An aerial architectural rendering of a park area. The scene shows a large green lawn with several winding paths. There are numerous trees of various sizes scattered throughout the area. In the upper left, a portion of a modern building with a grey facade is visible. The overall atmosphere is bright and clear, suggesting a sunny day. The text is overlaid on the central part of the image.

Proiect schiță  
Privind posibilitatea amenajării unui scuar pe teren  
cu nr. cadastral 01001030415 în adiacența blocului locativ  
situat pe adresa mun. Chișinău, sec. Botanica, bd. Dacia, 2.

Chișinău 2021

# Schema de amplasare

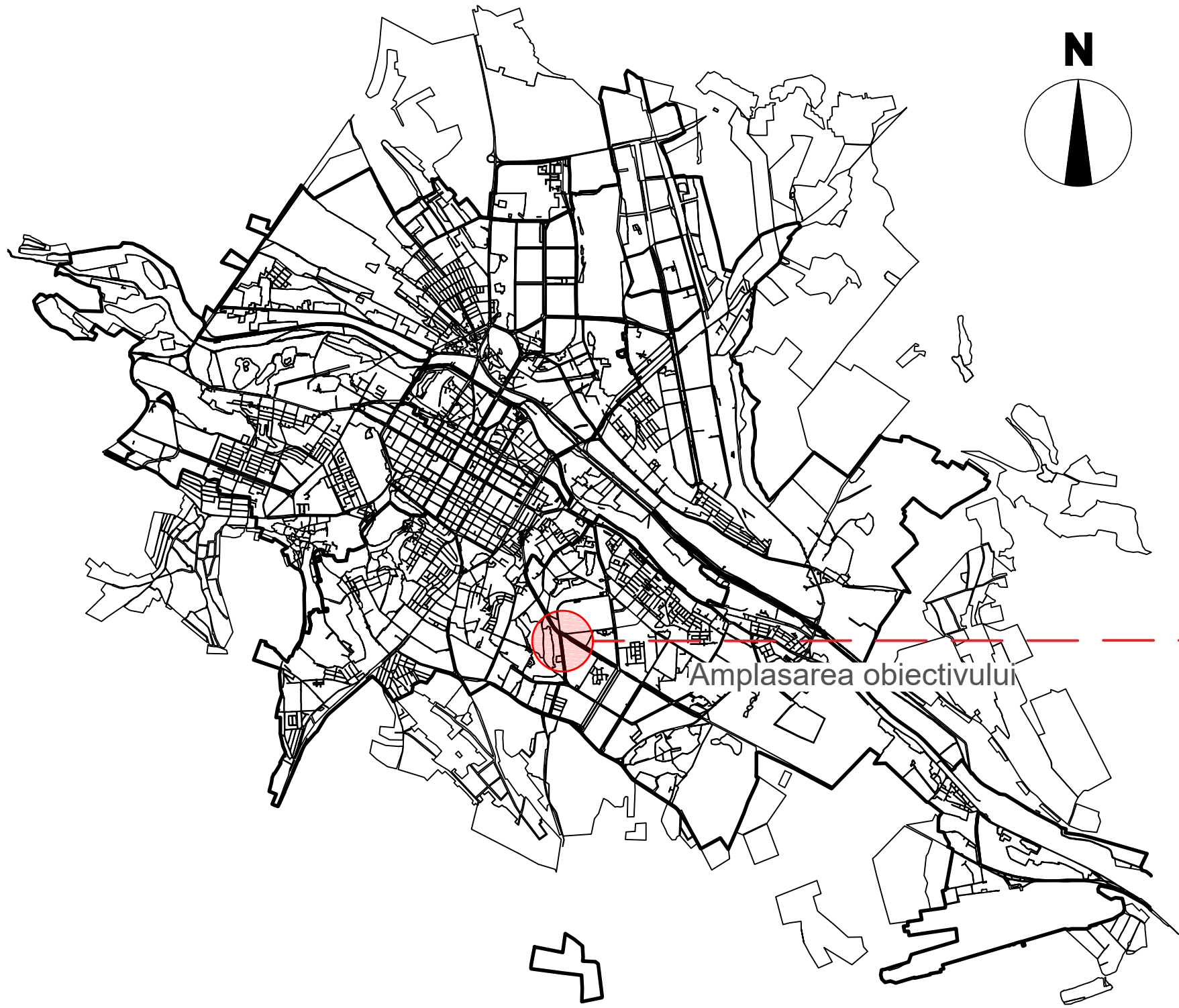

Amplasarea obiectivului

# Plan Situatie



Beneficiar: Pretura sectorului Botanica						10-05-2021-P																																																			
<table border="1"> <thead> <tr> <th>Faza</th> <th>Nr. part.</th> <th>Plansa</th> <th>Nr. doc.</th> <th>Semnat</th> <th>Data</th> </tr> </thead> <tbody> <tr><td> </td><td> </td><td> </td><td> </td><td> </td><td> </td></tr> <tr><td> </td><td> </td><td> </td><td> </td><td> </td><td> </td></tr> <tr><td> </td><td> </td><td> </td><td> </td><td> </td><td> </td></tr> <tr><td> </td><td> </td><td> </td><td> </td><td> </td><td> </td></tr> <tr><td> </td><td> </td><td> </td><td> </td><td> </td><td> </td></tr> <tr><td> </td><td> </td><td> </td><td> </td><td> </td><td> </td></tr> <tr><td> </td><td> </td><td> </td><td> </td><td> </td><td> </td></tr> </tbody> </table>						Faza	Nr. part.	Plansa	Nr. doc.	Semnat	Data																																											Privind posibilitatea amenajarii unui scuar pe teren cu nr. cadastral 01001030415 în adiacența blocului locativ situat pe adresa mun.Chișinău, sec. Botanica. bd. Dacia, 2.			
						Faza	Nr. part.	Plansa	Nr. doc.	Semnat	Data																																														
Parcare				Faza	Planșa	Planșe																																																			
				PS	1	9																																																			
Schema de amplasare																																																									
Plan situatie																																																									

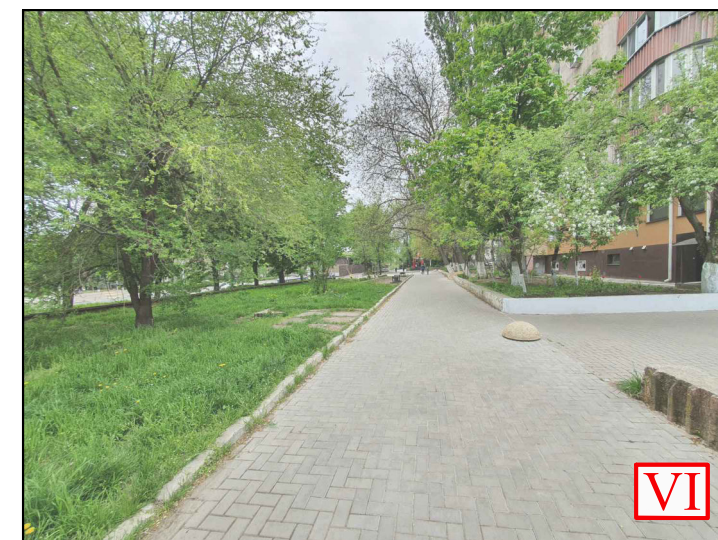
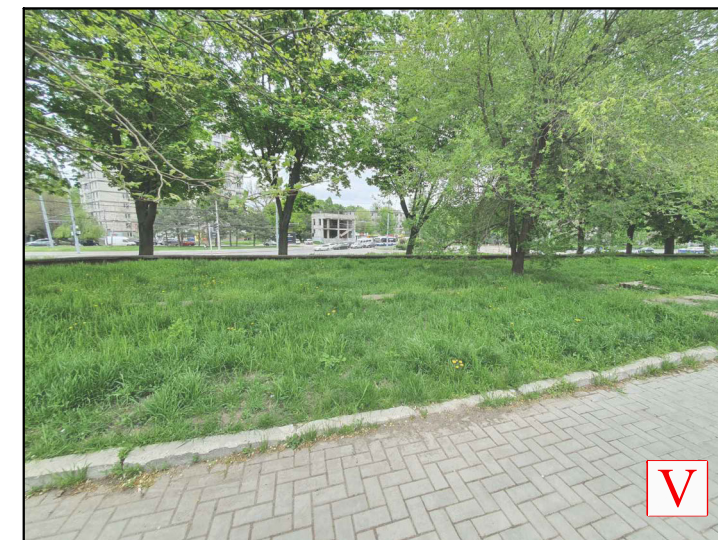
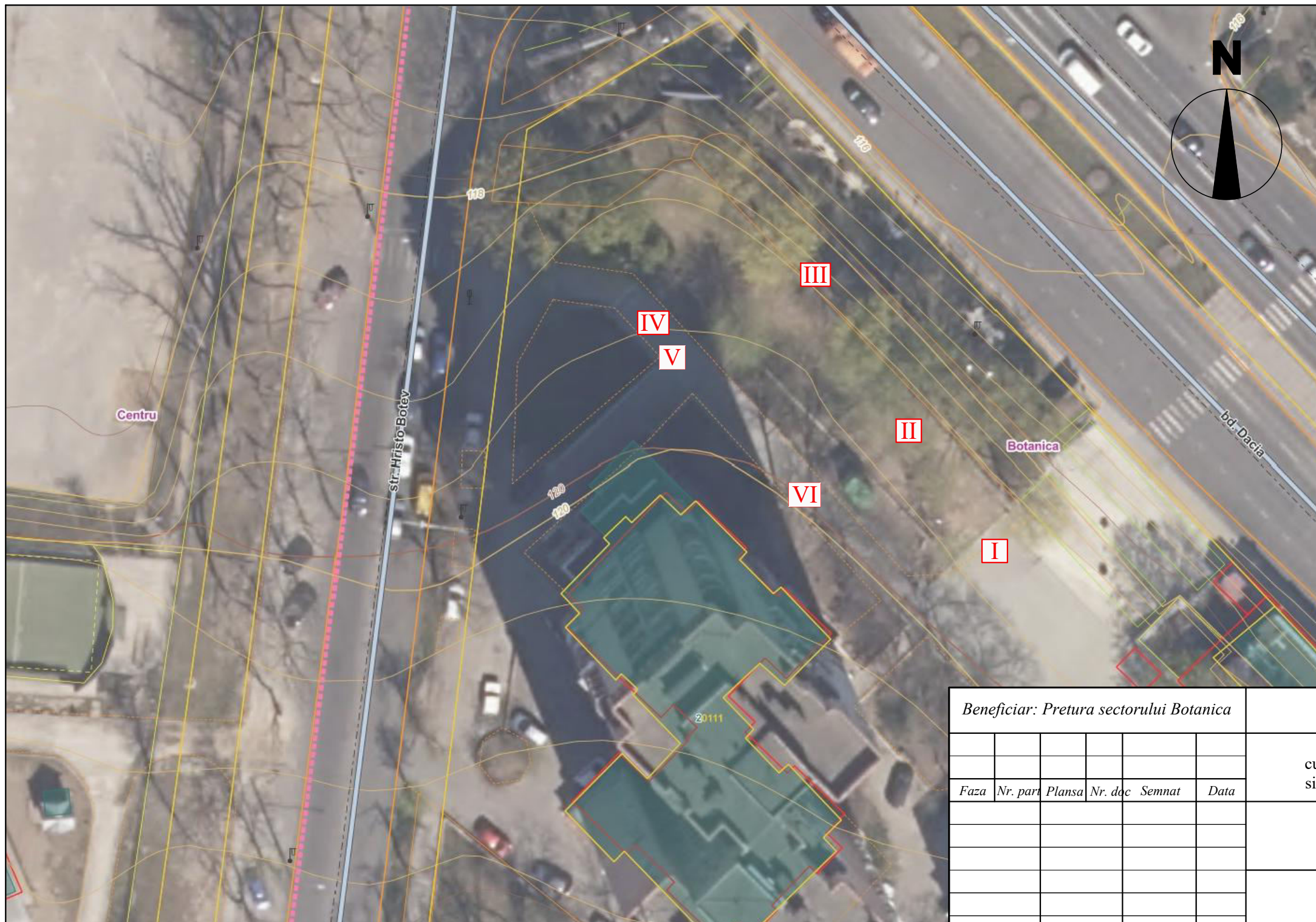
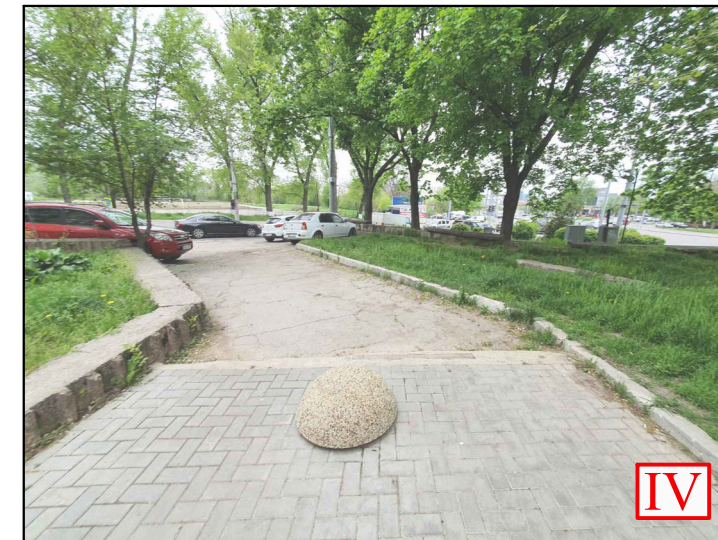
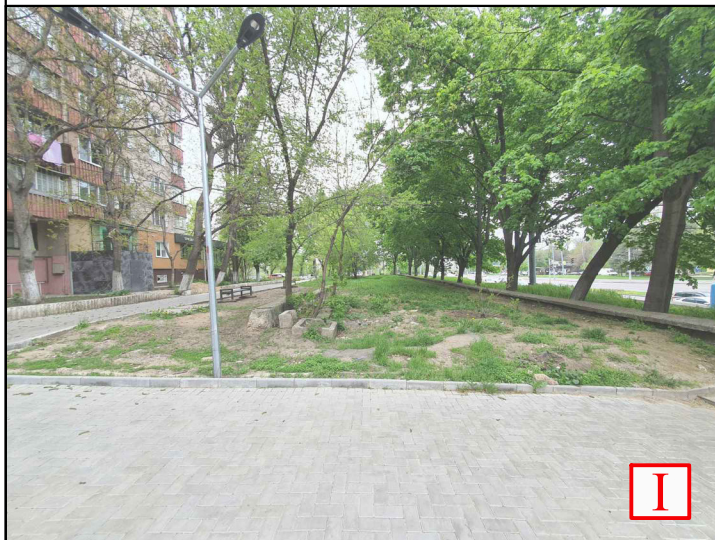

Beneficiar: Pretura sectorului Botanica						10-05-2021-P			
						Privind posibilitatea amenajarii unui scuar pe teren cu nr. cadastral 01001030415 in adiacenta blocului locativ situat pe adresa mun.Chişinau, sec. Botanica. bd. Dacia, 2.			
Faza	Nr. part.	Planşa	Nr. doc	Semnat	Data	Scuar	Faza	Planşa	Planşe
							PS	2	
						Fotofixare			

Schema de încadrare în teritoriu



LOTUL DESTINAT PROIECTĂRII

**Notație Convențională**

— • • • — Limitele teritoriului destinat proiectării

Plan general sc. 1:500

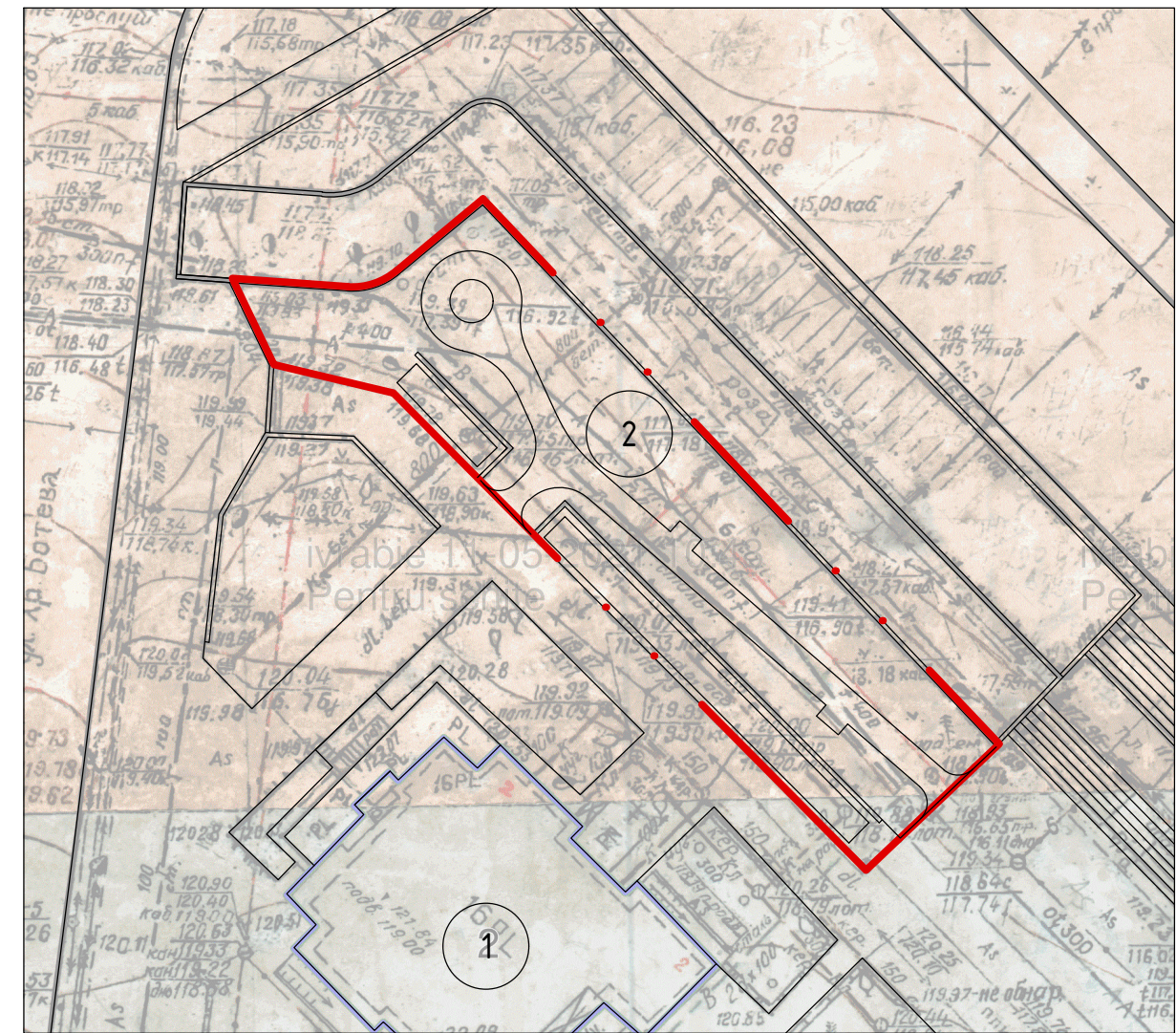

**BORDEROU CLĂDIRI/TERENURI**

PLANȘA	DENUMIRE	NUMĂRUL NIVELULI	NOTĂ
1	Clădiri locative	9	existent
2	Scuar	0	Proiectat

Beneficiar: Pretura sectorului Botanica						10-05-2021-P																	
Faza						Privind posibilitatea amenajării unui scuar pe teren cu nr. cadastral 01001030415 în adiacența blocului locativ situat pe adresa mun. Chișinău, sec. Botanica, bd. Dacia, 2.																	
						Nr. part						Plansa											
Nr. doc						Semnat						Data											
Scuar						Faza						Planșa						Planșe					
						PS						3											
Schema de încadrare în teritoriu						Plan general sc. 1:500																	

Plan trasare sc. 1:250

**BORDEROU FORME ARHITECTURALE MICI ȘI UTILAJE**

Nr.	SEMŢN CONVENŢIONAL	DENUMIRE	NUMĂRUL	UNITATE
1		Pavaj din dale de beton	140	m <sup>2</sup>
2		Borduri	140	m.l.
3		Decoptare strat 10 cm de sol	50	m <sup>3</sup>
		Nivelarea a 10 cm cu cernoziom	50	m <sup>3</sup>
		Semănare cu iarbă	500	m <sup>2</sup>
4		Organizare Vegetativa-Floristica	75	m <sup>2</sup>

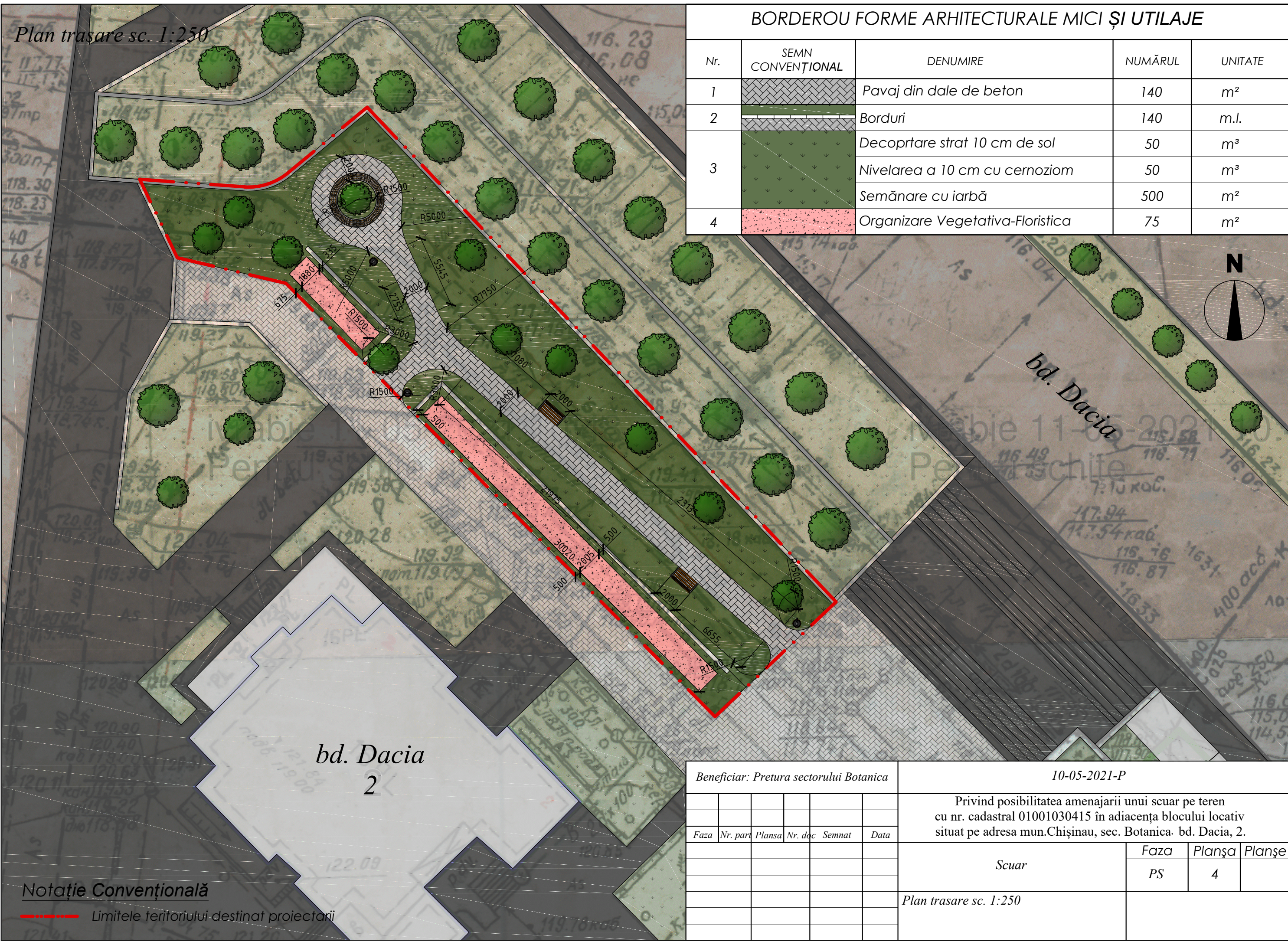
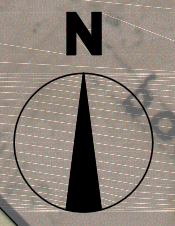

bd. Dacia  
2

Beneficiar: Pretura sectorului Botanica						10-05-2021-P					
Faza						Privind posibilitatea amenajarii unui scuar pe teren cu nr. cadastral 01001030415 în adiacența blocului locativ situat pe adresa mun.Chișinau, sec. Botanica bd. Dacia, 2.					
						Nr. part					
Plansa						PS		4			
Nr. doc						Plan trasare sc. 1:250					
Semnat											
Data											

**Notatie Conventiionala**

Limitele teritoriului destinat proiectarii

Plan de amenajare cu  
amplasarea mobilierului  
urban sc. 1:250

BORDEROU FORME ARHITECTURALE MICI ȘI UTILAJE

Nr.	DENUMIRE	NUMĂRUL	UNITATE	NOTĂ
1	Bănci pentru parc	2	buc.	-
2	Bănci pentru parc (tip cerc)	1	buc.	-
3	Coșuri pentru gunoi	3	buc.	-

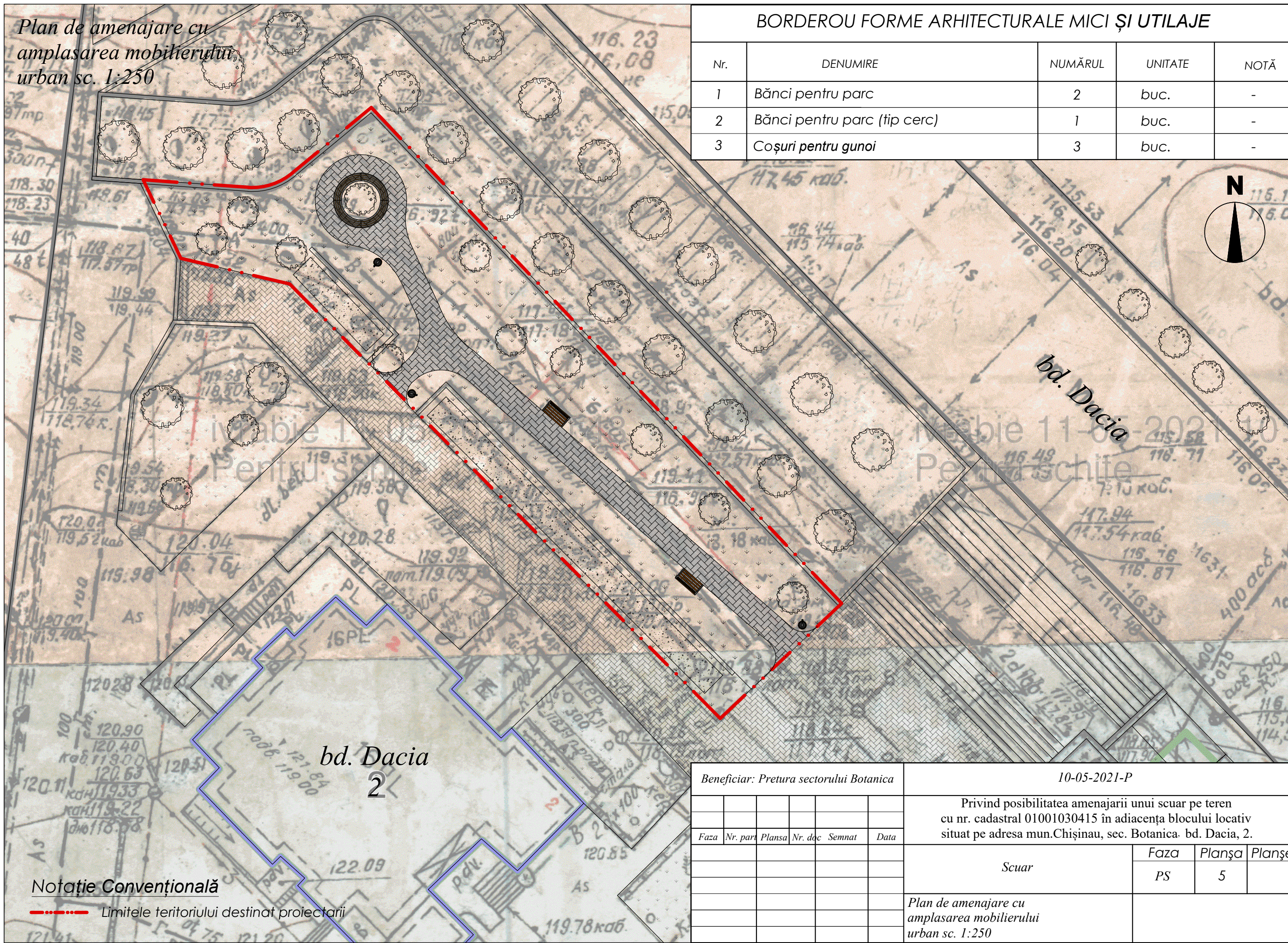
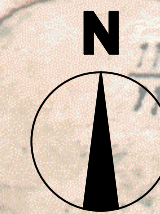

Notație Convențională

----- Limitele teritoriului destinat proiectării

Beneficiar: Pretura sectorului Botanica						10-05-2021-P			
						Privind posibilitatea amenajării unui scuar pe teren cu nr. cadastral 01001030415 în adiacența blocului locativ situat pe adresa mun.Chișinau, sec. Botanica- bd. Dacia, 2.			
Faza	Nr. part.	Planșa	Nr. doc	Semnat	Data	Scuar	Faza	Planșa	Planșe
							PS	5	
						Plan de amenajare cu amplasarea mobilierului urban sc. 1:250			

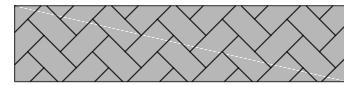

Elementul acoperisului din dale de beton

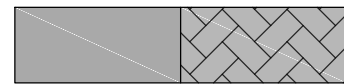
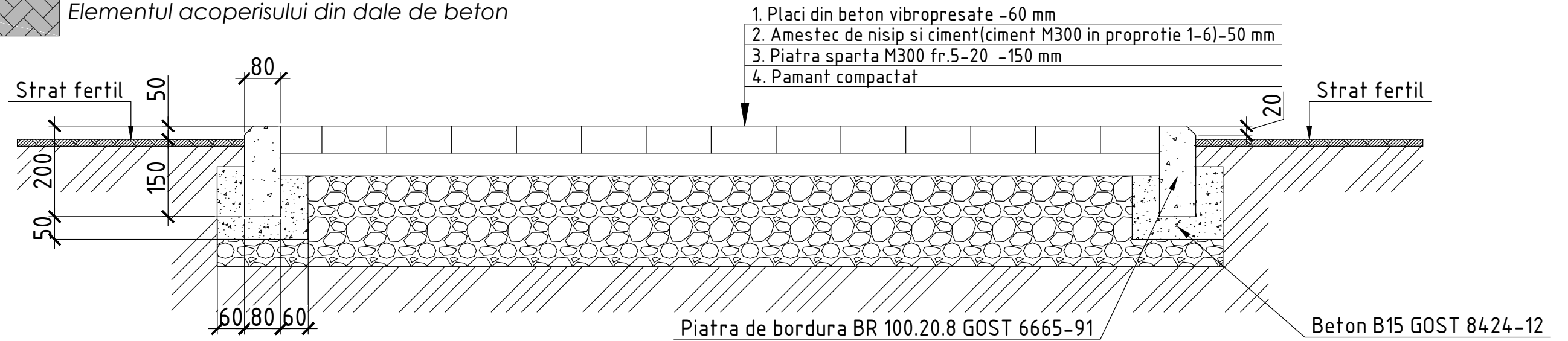

Elementul acoperisului din dale de beton  
 si elementul acoperisului existent din beton asfaltic

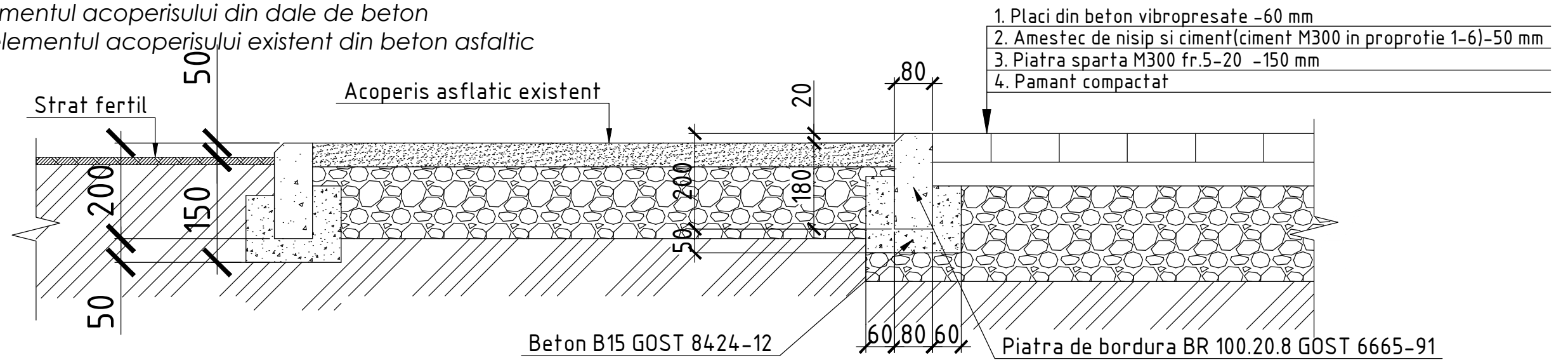

Beneficiar: Pretura sectorului Botanica						10-05-2021-P																																						
<table border="1"> <thead> <tr> <th>Faza</th> <th>Nr. par.</th> <th>Planşa</th> <th>Nr. doc</th> <th>Semnat</th> <th>Data</th> </tr> </thead> <tbody> <tr><td> </td><td> </td><td> </td><td> </td><td> </td><td> </td></tr> <tr><td> </td><td> </td><td> </td><td> </td><td> </td><td> </td></tr> <tr><td> </td><td> </td><td> </td><td> </td><td> </td><td> </td></tr> <tr><td> </td><td> </td><td> </td><td> </td><td> </td><td> </td></tr> <tr><td> </td><td> </td><td> </td><td> </td><td> </td><td> </td></tr> </tbody> </table>						Faza	Nr. par.	Planşa	Nr. doc	Semnat	Data																															Privind posibilitatea amenajarii unui scuar pe teren cu nr. cadastral 01001030415 în adiacența blocului locativ situat pe adresa mun.Chişinău, sec. Botanica. bd. Dacia, 2.		
						Faza	Nr. par.	Planşa	Nr. doc	Semnat	Data																																	
<table border="1"> <thead> <tr> <th colspan="2">Scuar</th> <th>Faza</th> <th>Planşa</th> <th>Planşe</th> </tr> </thead> <tbody> <tr> <td colspan="2"> </td> <td>PS</td> <td>6</td> <td> </td> </tr> </tbody> </table>						Scuar		Faza	Planşa	Planşe			PS	6		Constructia îmbrăcămintei Acceselor																												
						Scuar		Faza	Planşa	Planşe																																		
		PS	6																																									







<i>Beneficiar: Pretura sectorului Botanica</i>						<i>10-05-2021-P</i>			
						Privind posibilitatea amenajării unui scuar pe teren cu nr. cadastral 01001030415 în adiacența blocului locativ situat pe adresa mun. Chișinău, sec. Botanica, bd. Dacia, 2.			
<i>Faza</i>	<i>Nr. par.</i>	<i>Planșa</i>	<i>Nr. doc</i>	<i>Semnat</i>	<i>Data</i>	<i>Scuar</i>	<i>Faza</i>	<i>Planșa</i>	<i>Planșe</i>
							<i>PS</i>	8	
						<i>Vizualizări</i>			



<i>Beneficiar: Pretura sectorului Botanica</i>						<i>10-05-2021-P</i>			
						Privind posibilitatea amenajării unui scuar pe teren cu nr. cadastral 01001030415 în adiacența blocului locativ situat pe adresa mun.Chișinău, sec. Botanica. bd. Dacia, 2.			
<i>Faza</i>	<i>Nr. par.</i>	<i>Plansa</i>	<i>Nr. doc</i>	<i>Semnat</i>	<i>Data</i>	<i>Scuar</i>	<i>Faza</i>	<i>Plansa</i>	<i>Planșe</i>
							<i>PS</i>	<i>9</i>	
						<i>Vizualizări</i>			