

$F_1 = 110$ buc (cu deschidere 65 buc
fără deschidere
65 buc)

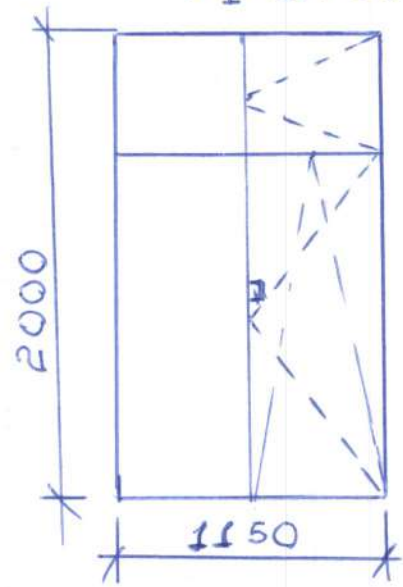

$F_2 = 94$ buc (cu deschidere 60 buc
fără deschidere
34 buc)

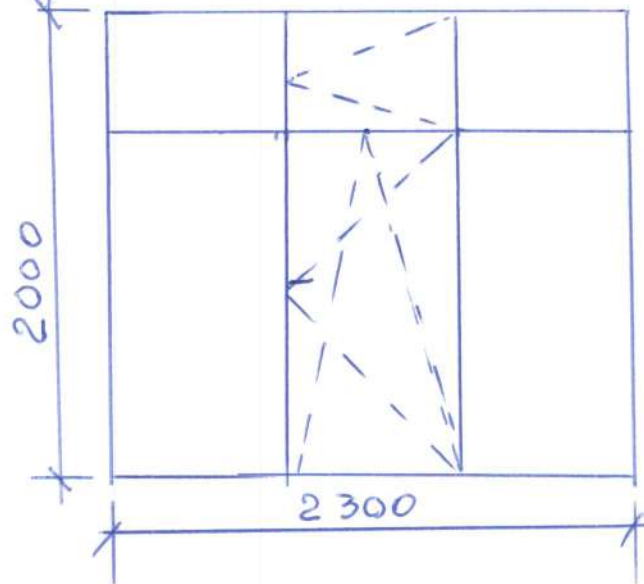

$F_3 = 18$ buc

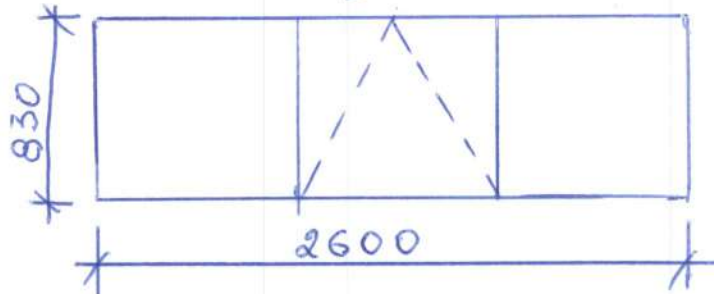

$U_1 = 1$ buc

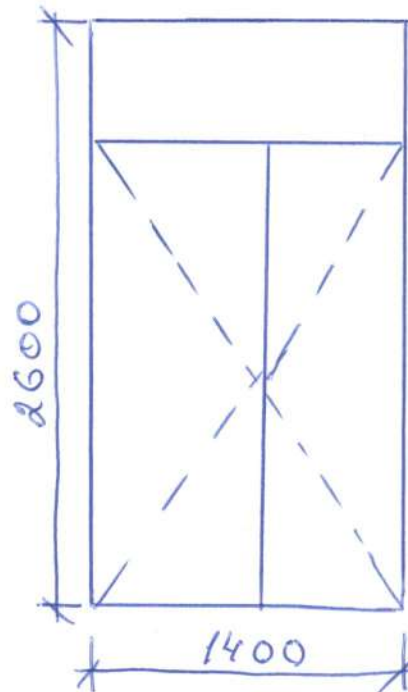

Bloc 1 = buc

700

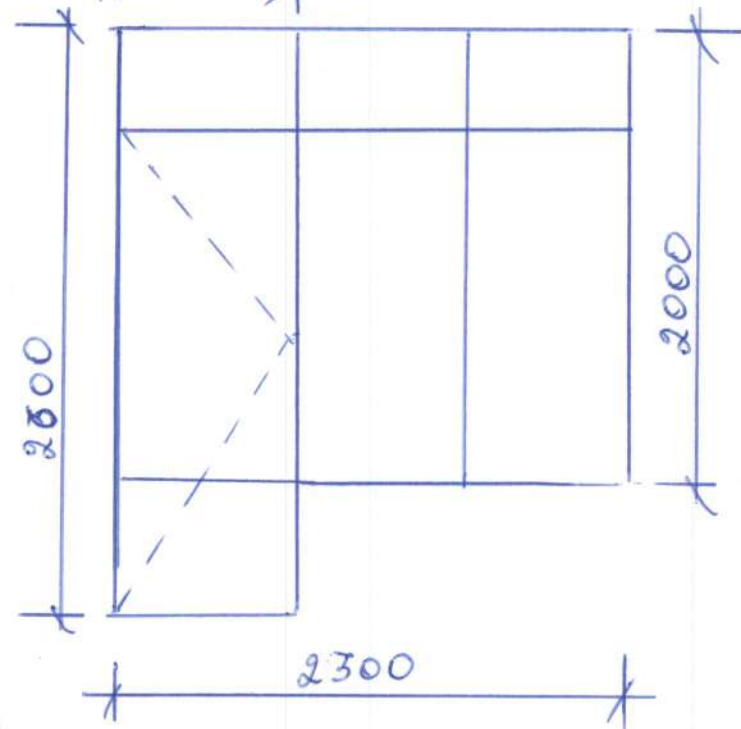

$F_4 = 1$ buc

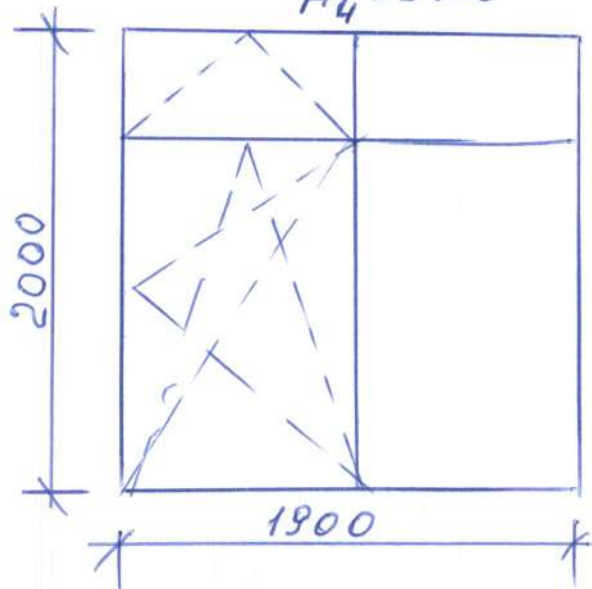

F5 - 2 buc

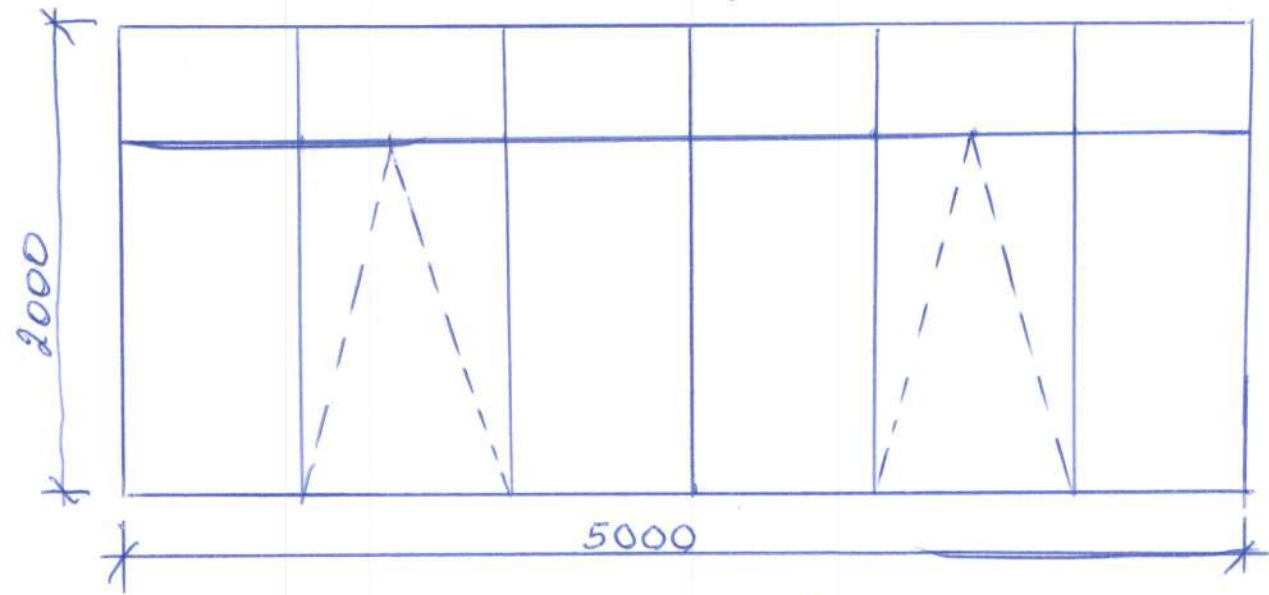

Bloc 2 - 2 buc

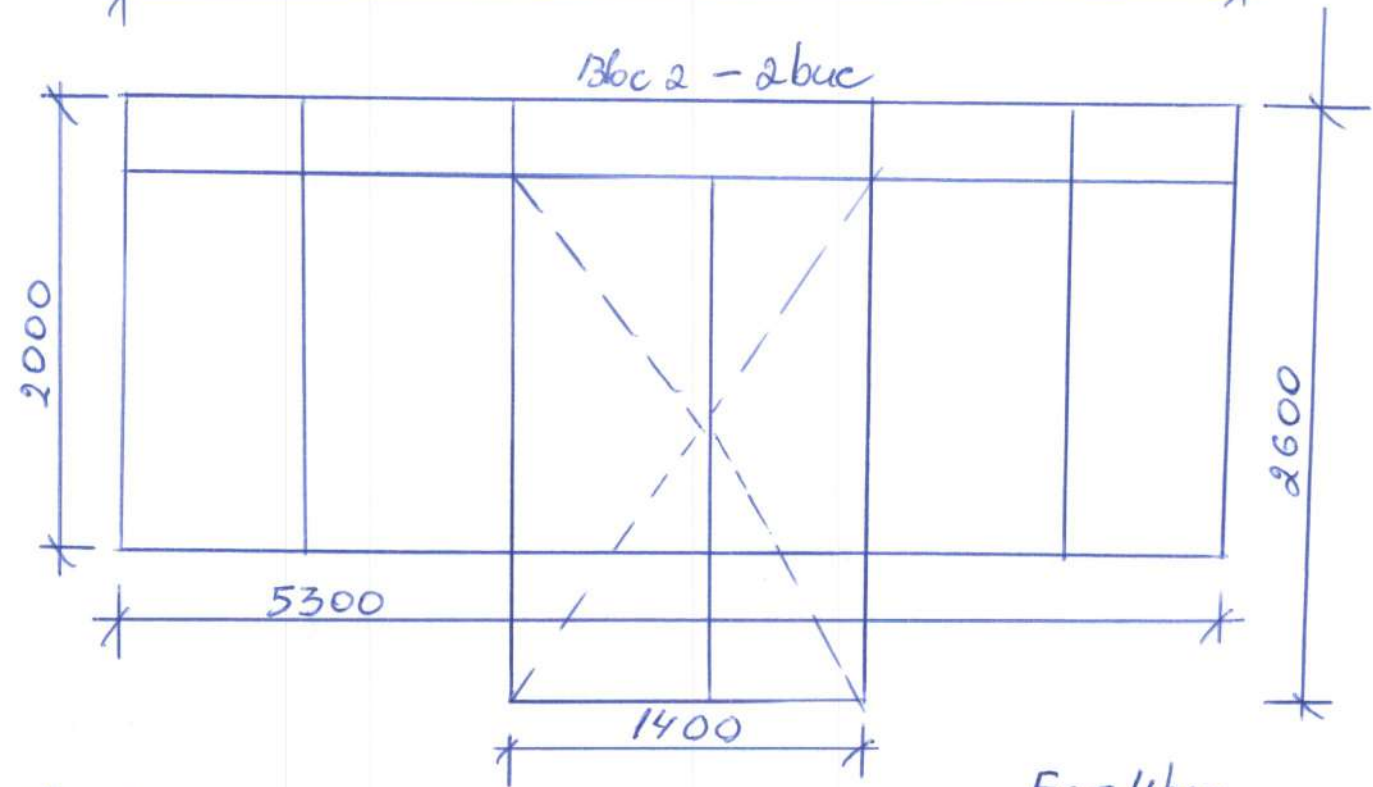

F6 - 4 buc

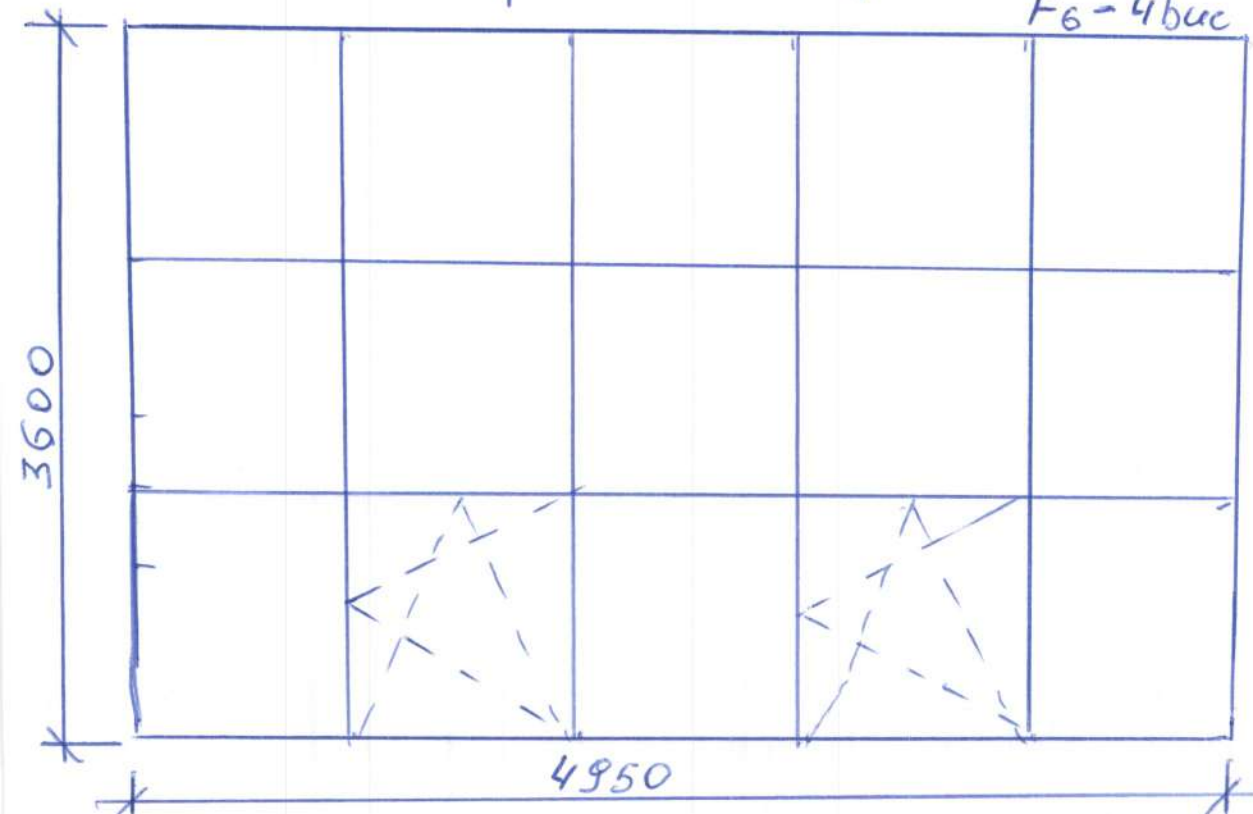

$F_4 = 20 \text{ buc}$ (cu deschidere
10, fãcã deschide
10)



$F_8 = 5 \text{ buc}$

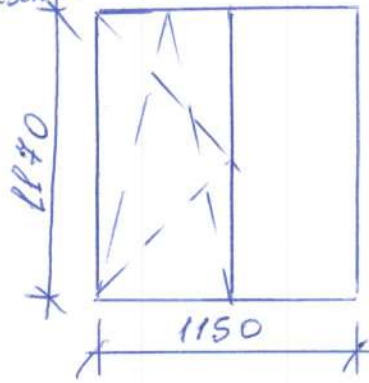

$F_9 = 1 \text{ buc}$

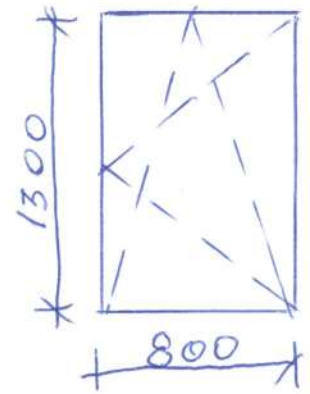

$F_{10} = 4 \text{ buc}$

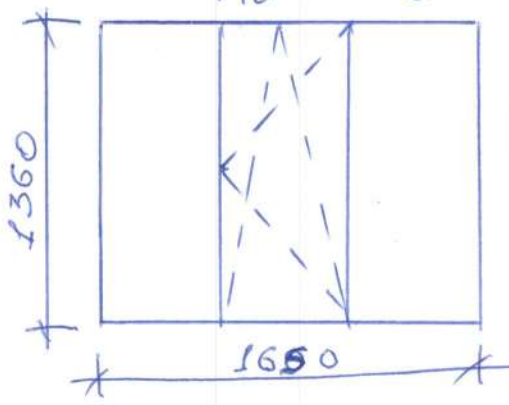

$F_{11} = 7 \text{ buc}$

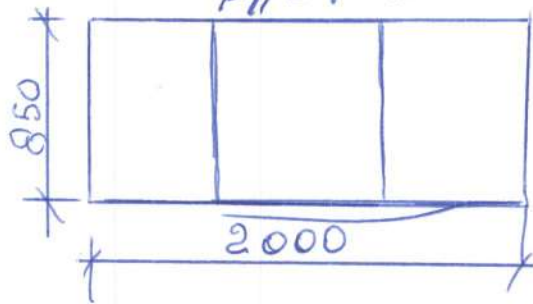

$F_{12} = 1 \text{ buc}$

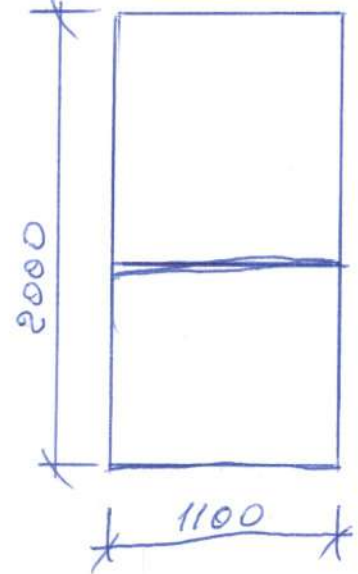

$U_2 = 1 \text{ buc}$



$Bloc_3 = 1 \text{ buc}$

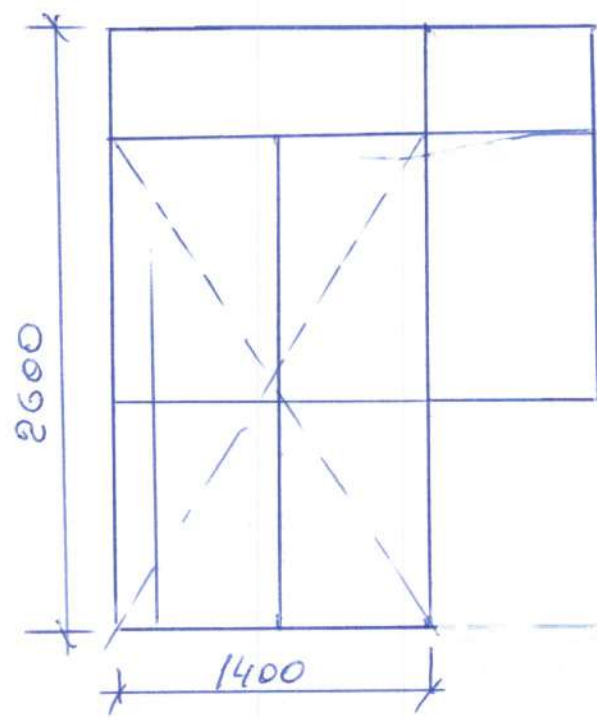

$F_{13} = 16 \text{ buc}$

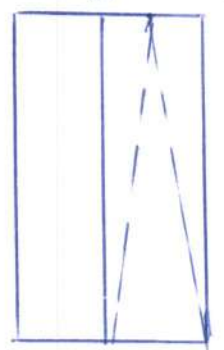

13locu - 2 buc (intrearea principala)

