

# ANEXE

ANEXA 1

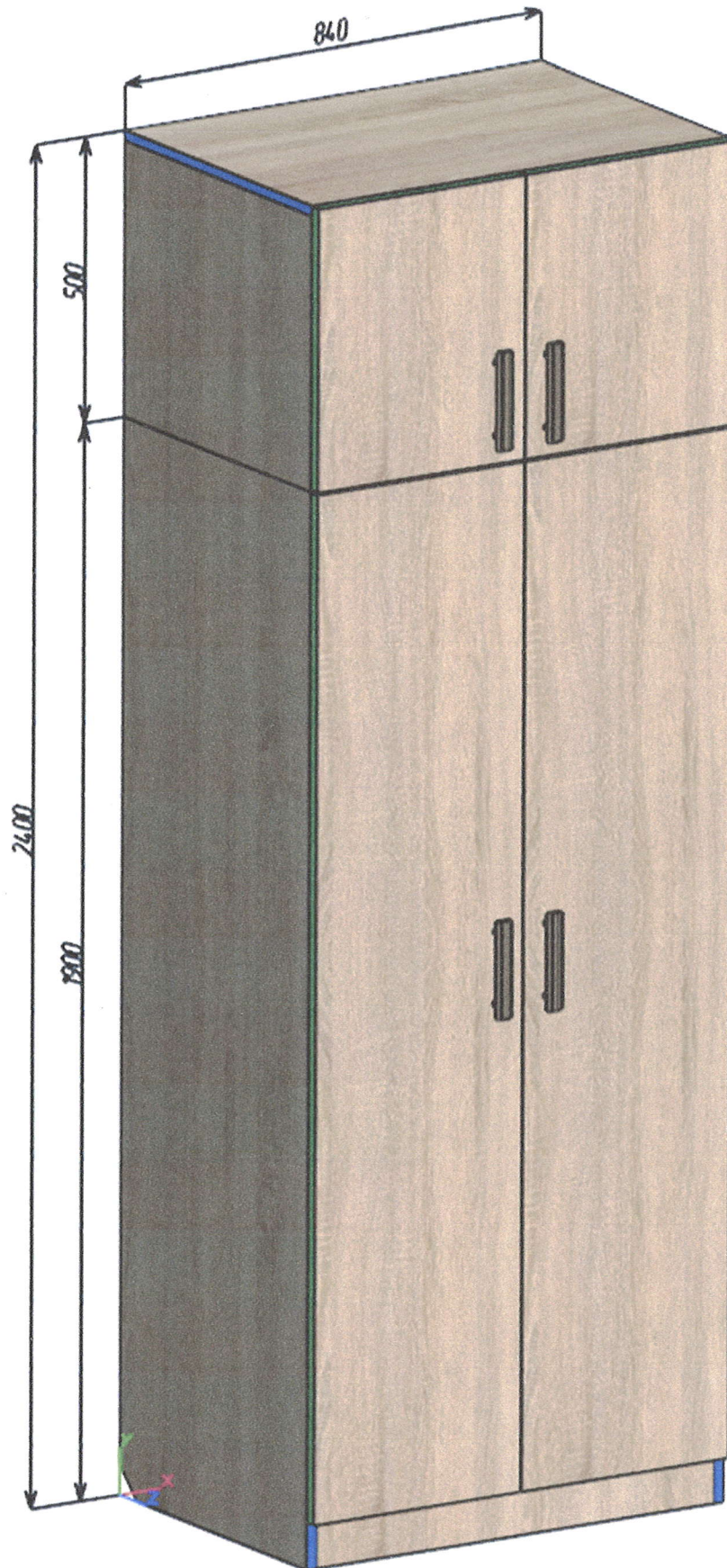

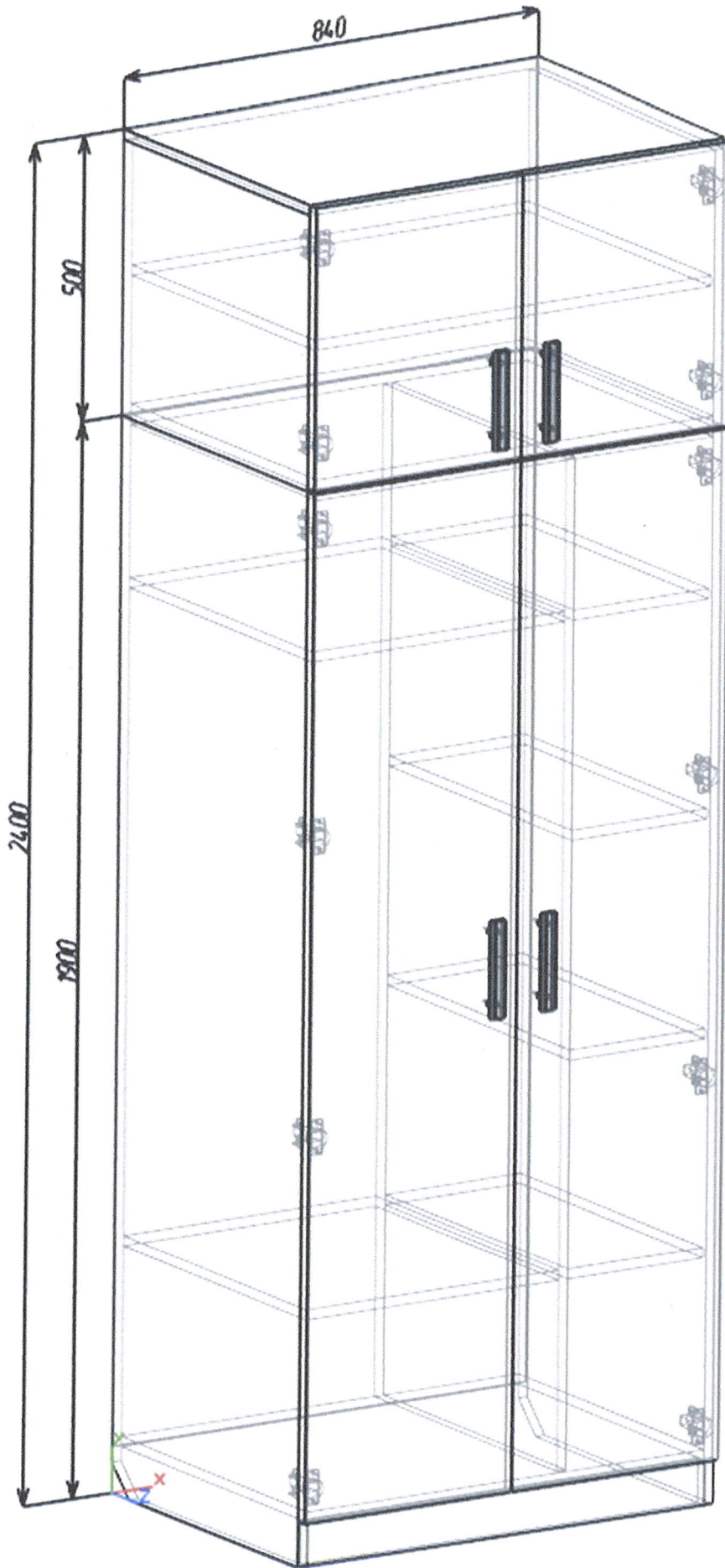

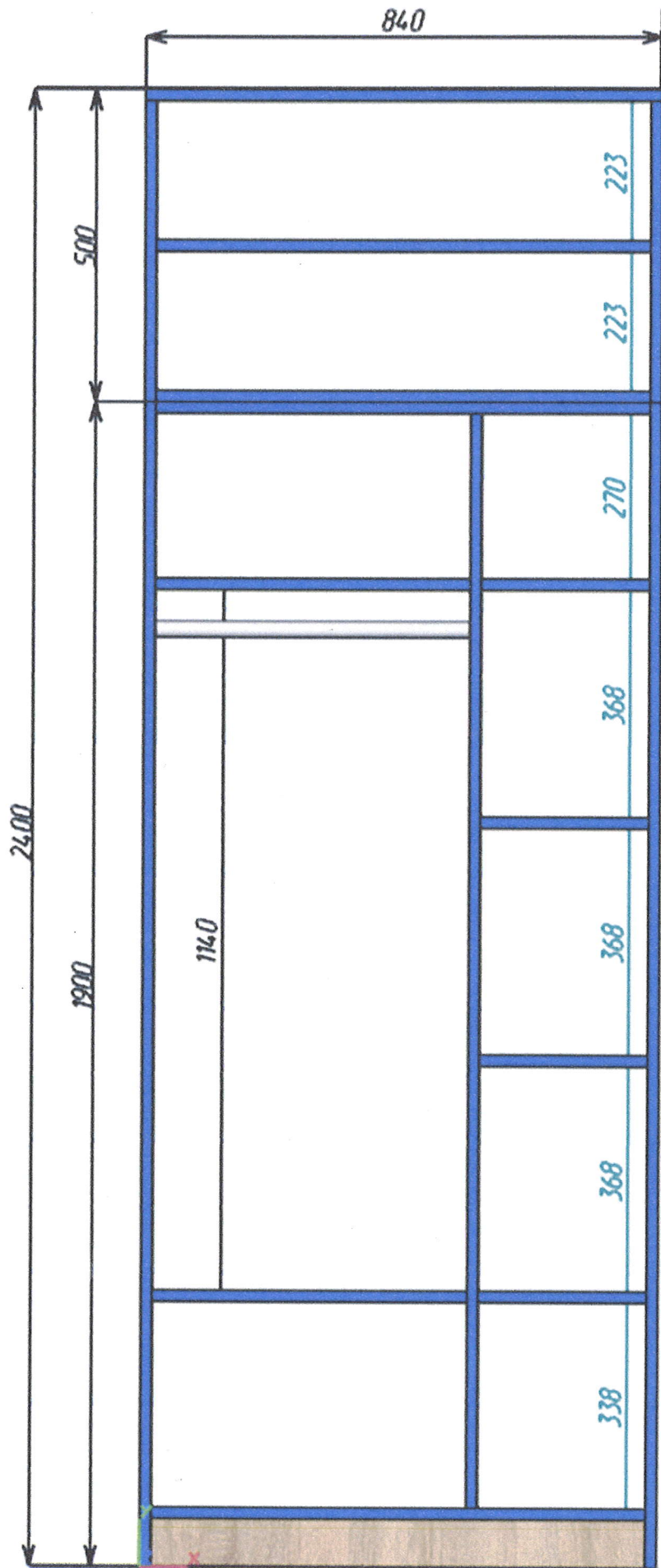



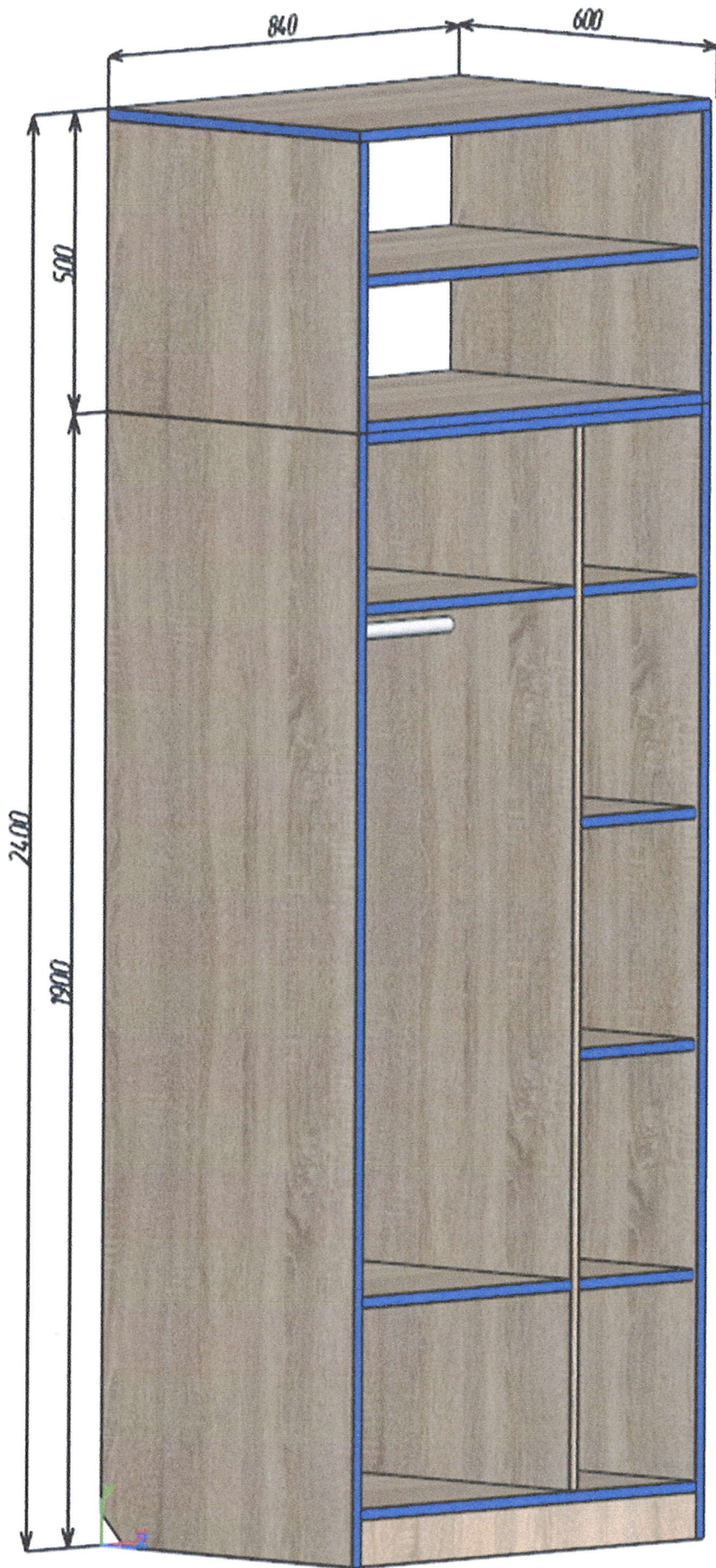



ANEXA 2

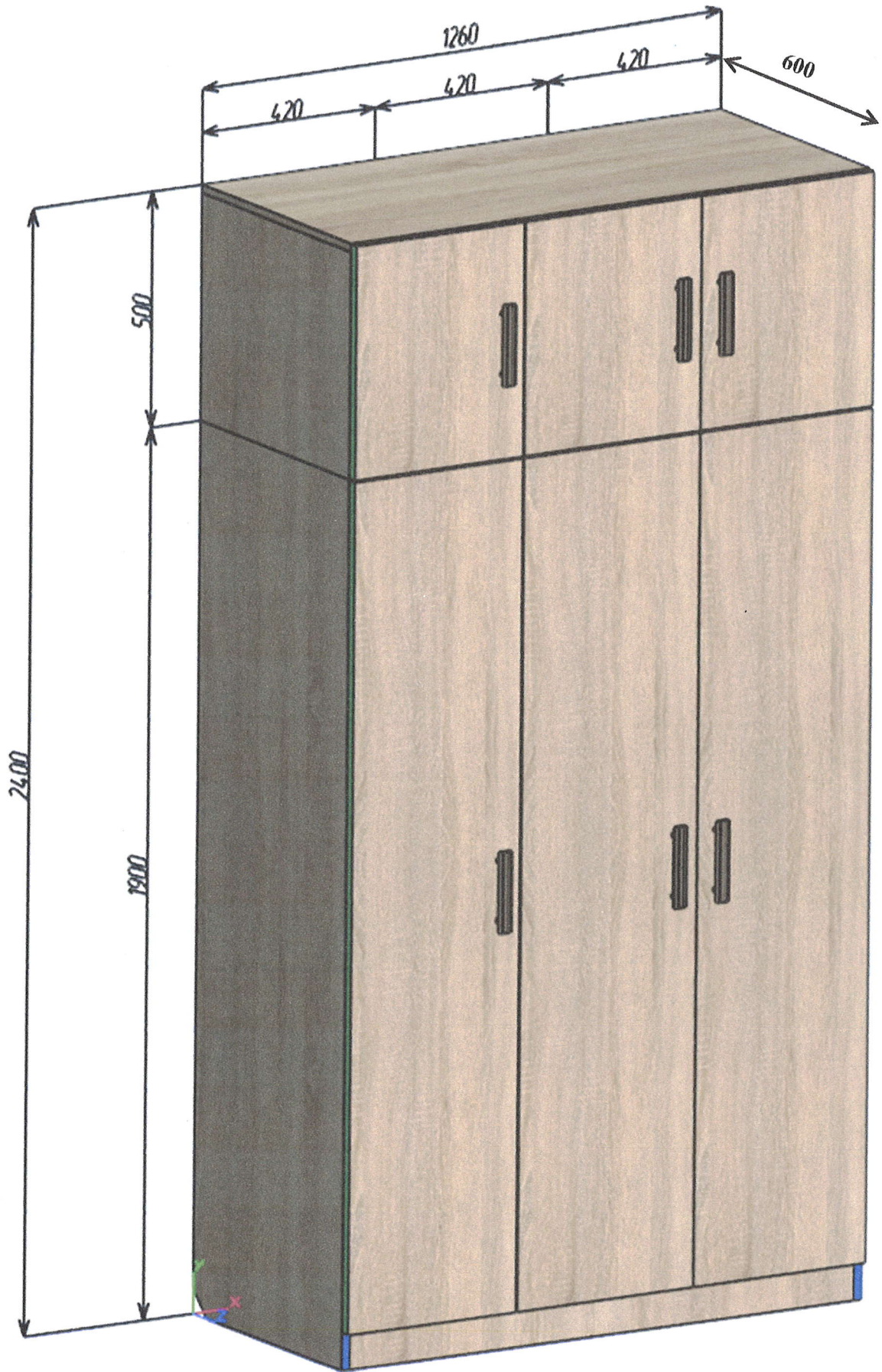

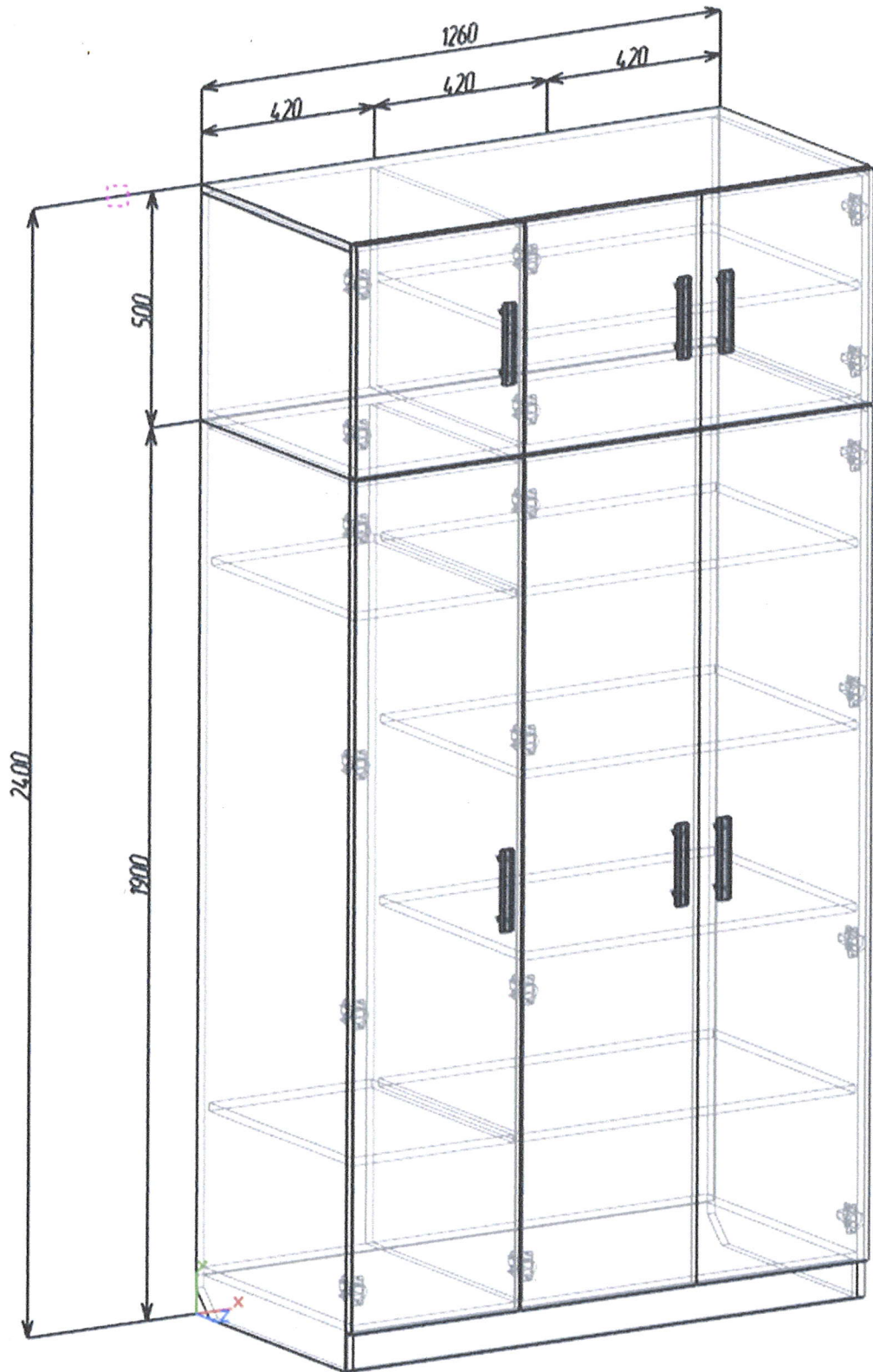



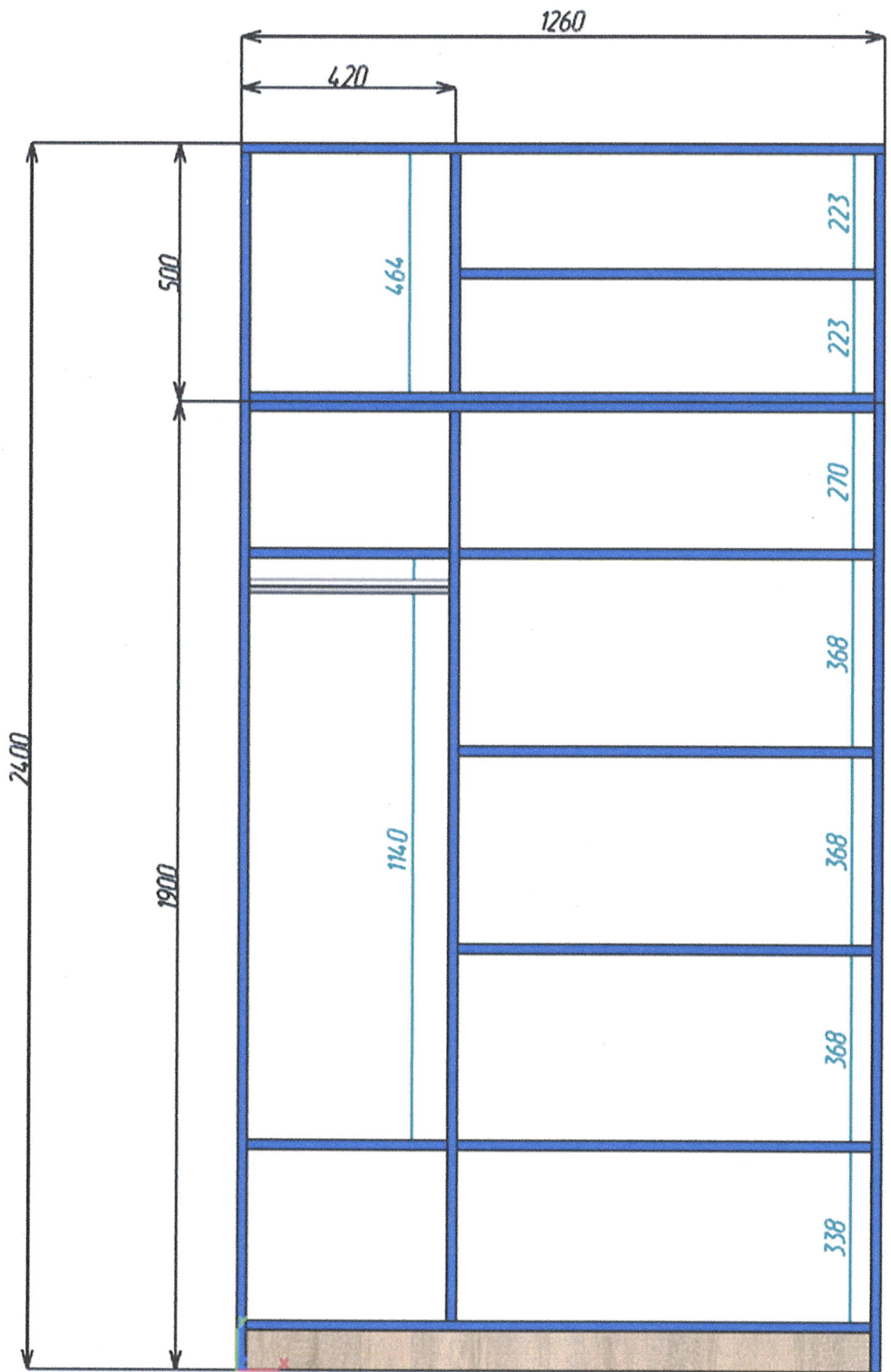



ANEXA 3

(în dependență de model diferă doar lungimea)

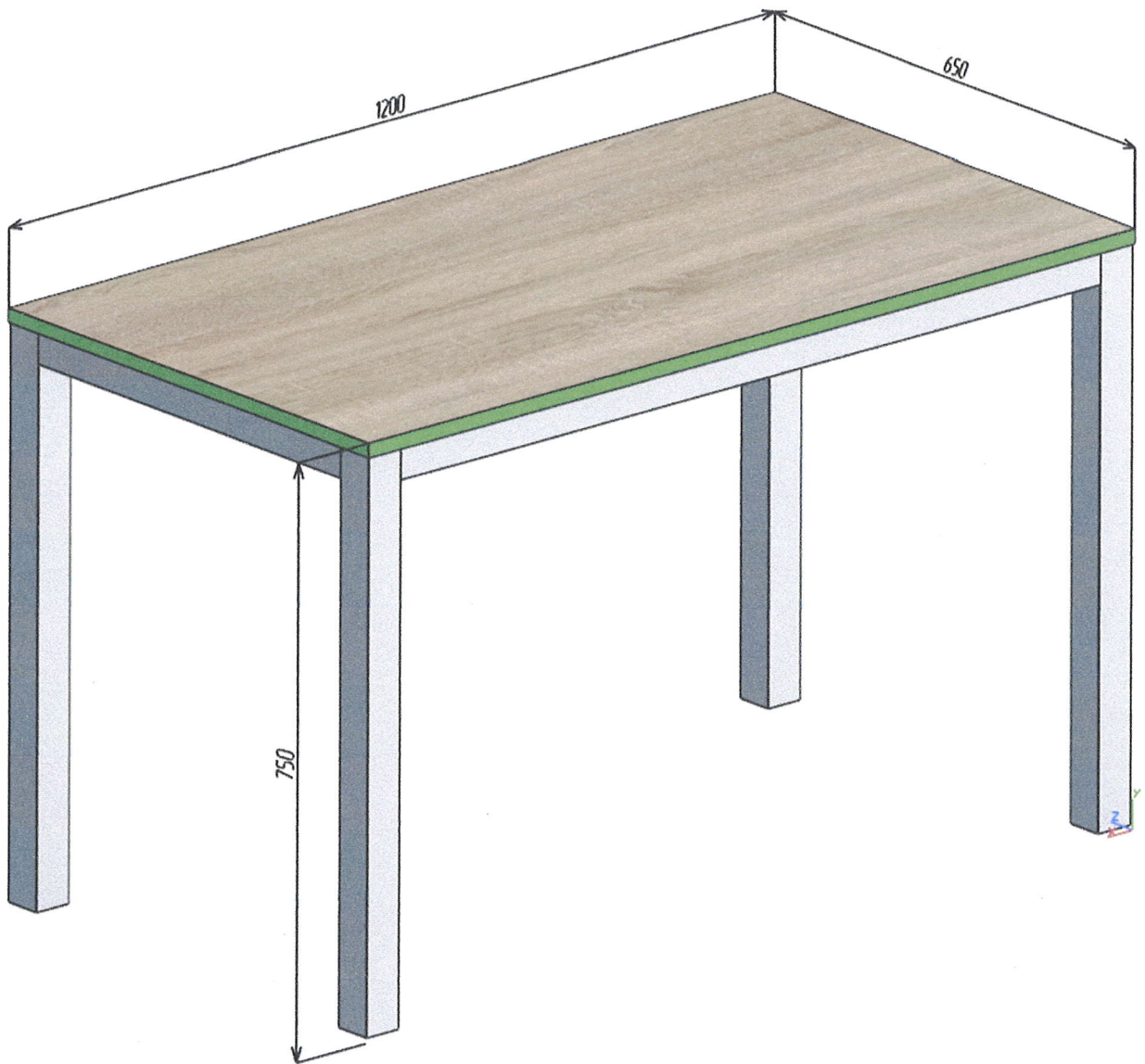

# ANEXA 4

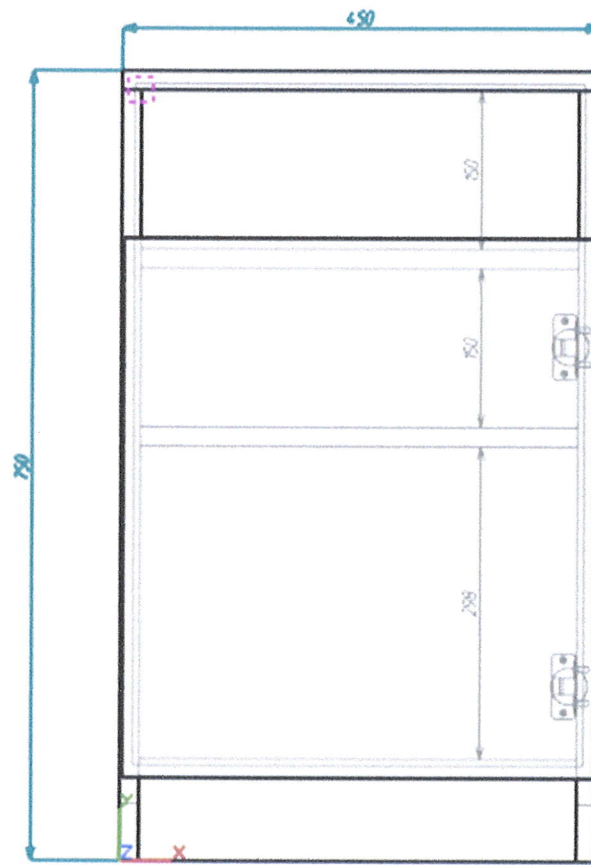
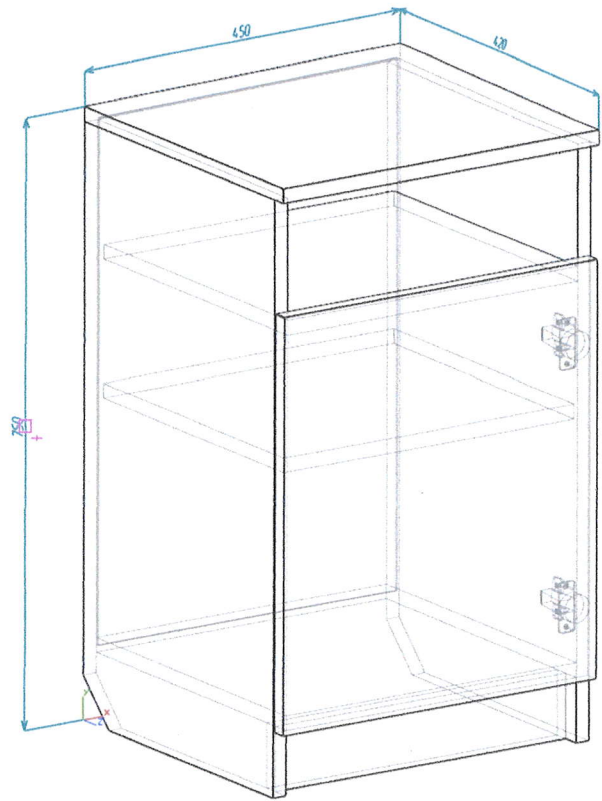
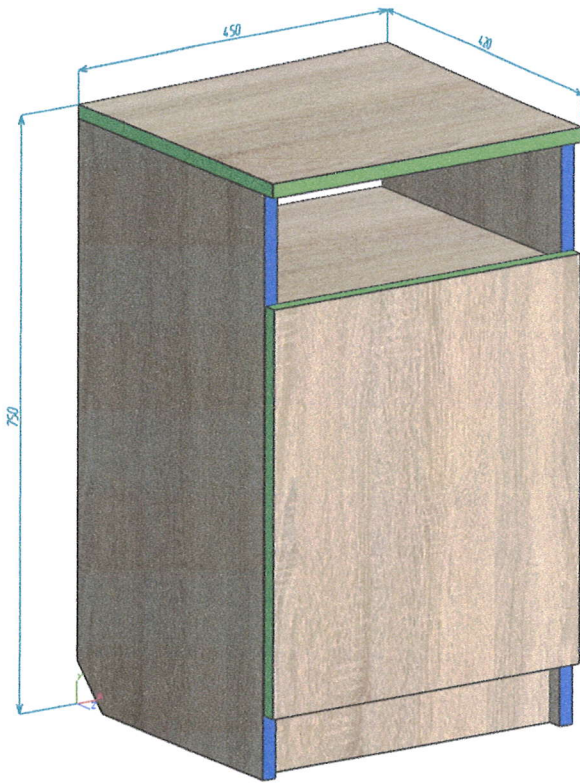

ANEXA 5

