An architectural rendering of a park square. The scene is viewed from an elevated perspective. In the center, a tall, conical evergreen tree stands in a circular planter. A wooden bench is positioned around the base of the tree. A paved path winds through the square, with several stylized human figures walking. One figure is walking a dog. The square is surrounded by green lawns and various shrubs and trees. The overall atmosphere is bright and sunny.

Proiect schiță
Privind posibilitatea amenajării unui scuar pe teren
cu nr. cadastral 001001130471 în adiacența blocului locativ
situat pe adresa mun. Chișinău, sec. Botanica, bd. Cuza Vodă, 25/2.

Chișinău 2021

Schema de amplasare



Plan Situatie

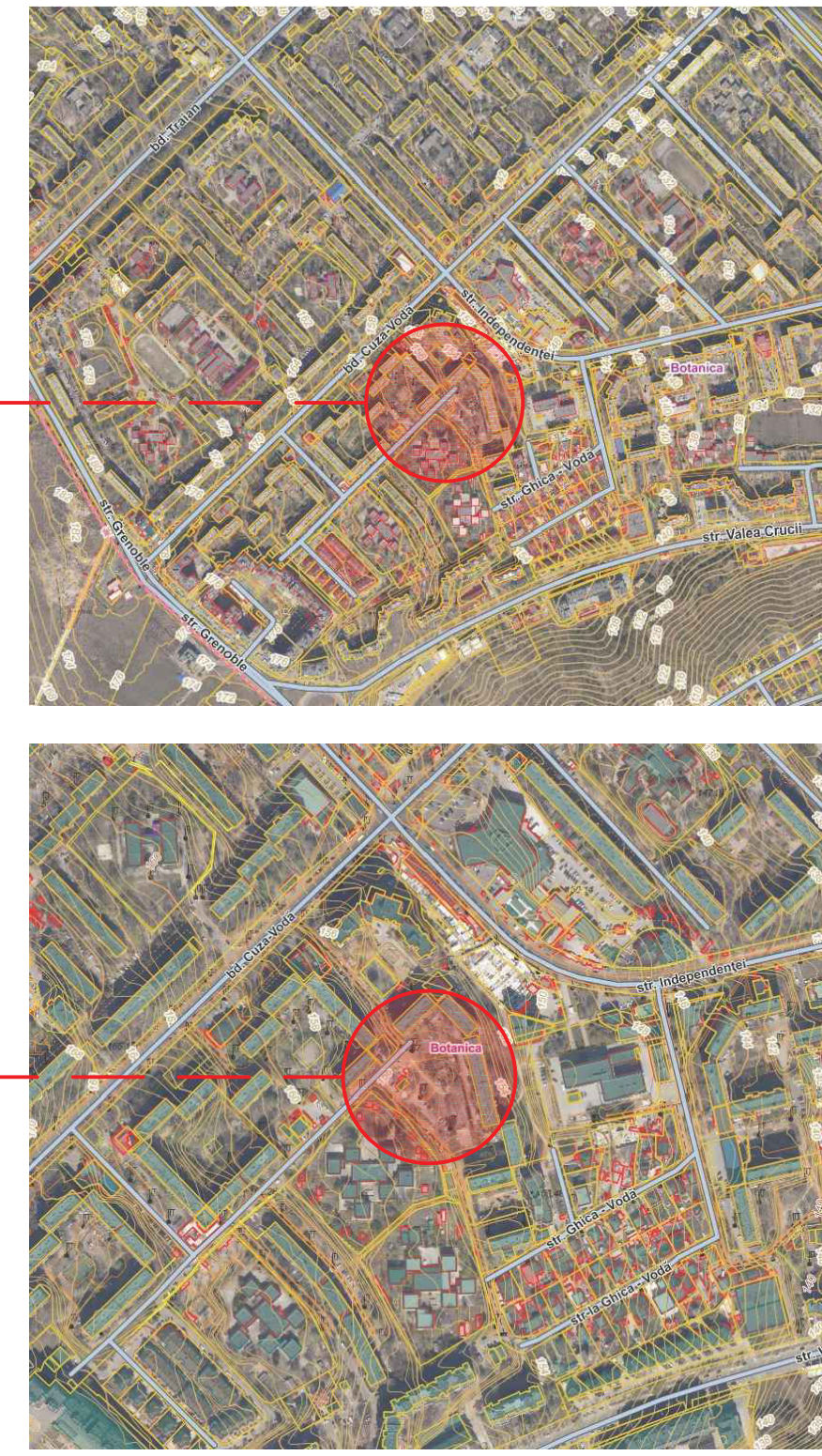

Beneficiar: Pretura sectorului Botanica						10-05-2021-P																																																			
<table border="1"> <thead> <tr> <th>Faza</th> <th>Nr. part.</th> <th>Plansa</th> <th>Nr. doc</th> <th>Semnat</th> <th>Data</th> </tr> </thead> <tbody> <tr><td> </td><td> </td><td> </td><td> </td><td> </td><td> </td></tr> <tr><td> </td><td> </td><td> </td><td> </td><td> </td><td> </td></tr> <tr><td> </td><td> </td><td> </td><td> </td><td> </td><td> </td></tr> <tr><td> </td><td> </td><td> </td><td> </td><td> </td><td> </td></tr> <tr><td> </td><td> </td><td> </td><td> </td><td> </td><td> </td></tr> <tr><td> </td><td> </td><td> </td><td> </td><td> </td><td> </td></tr> <tr><td> </td><td> </td><td> </td><td> </td><td> </td><td> </td></tr> </tbody> </table>						Faza	Nr. part.	Plansa	Nr. doc	Semnat	Data																																											Privind posibilitatea amenajarii unui scuar pe teren cu nr. cadastral 001001130471 în adiacența blocului locativ situat pe adresa mun.Chișinau, sec. Botanica. bd. Cuza Vodă, 25/2.			
						Faza	Nr. part.	Plansa	Nr. doc	Semnat	Data																																														
Parcare Schema de amplasare Plan situatie						Faza	Planșa	Planșe																																																	
						PS	1	9																																																	

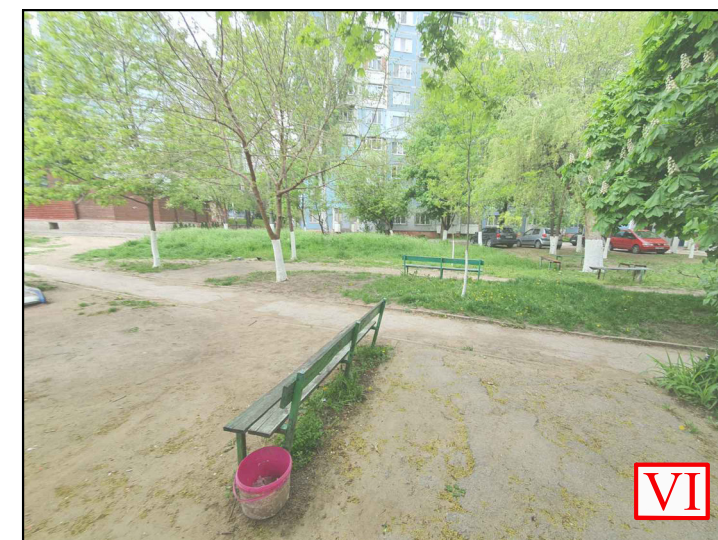
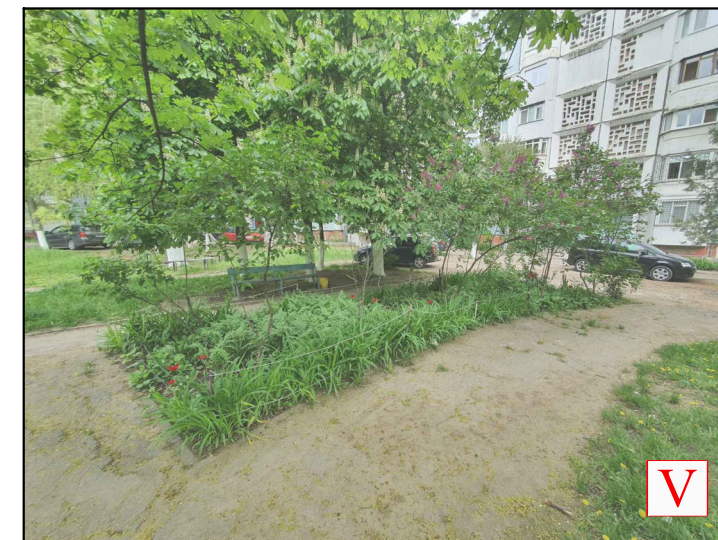
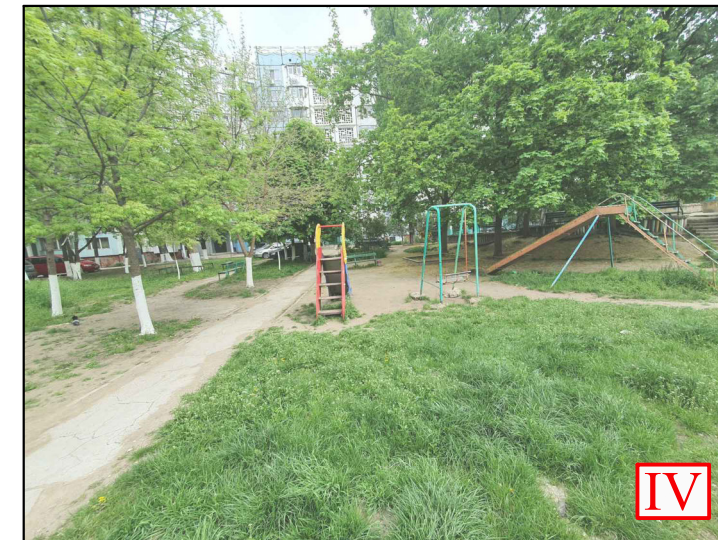
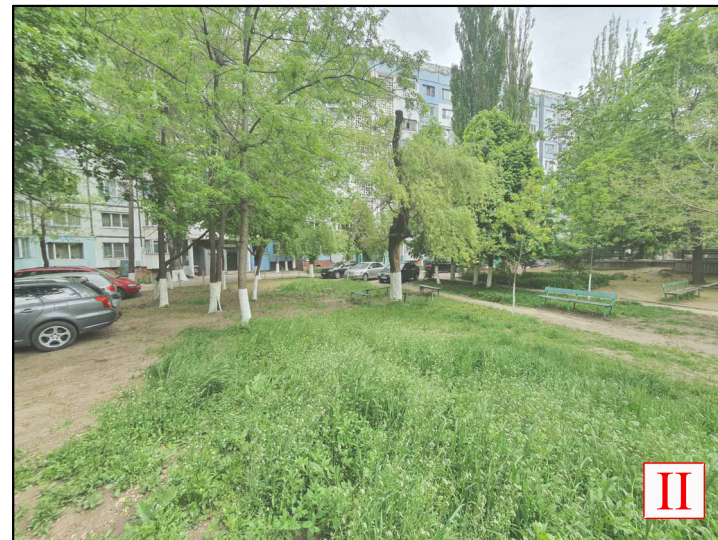
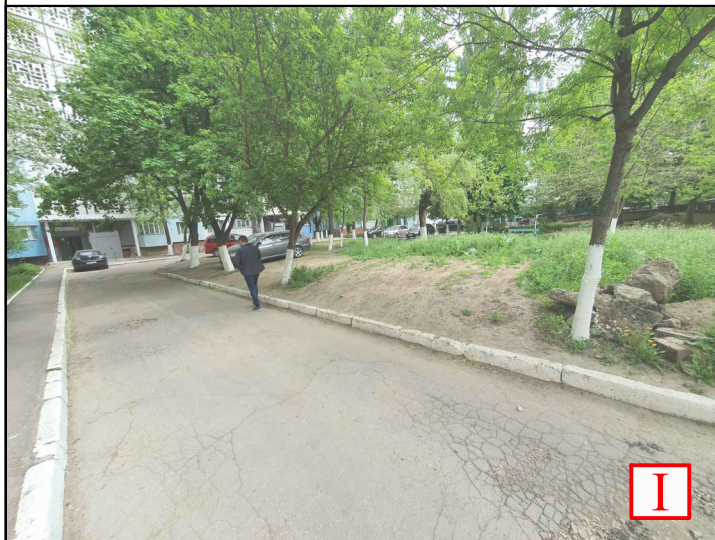

Beneficiar: Pretura sectorului Botanica						10-05-2021-P			
Privind posibilitatea amenajarii unui scuar pe teren cu nr. cadastral 001001130471 în adiacența blocului locativ situat pe adresa mun.Chișinău, sec. Botanica. bd. Cuza Vodă, 25/2.									
Faza	Nr. part.	Planșa	Nr. doc	Semnat	Data	Scuar	Faza	Planșa	Planșe
							PS	2	
Fotofixare									

Schema de încadrare în teritoriu



LOTUL DESTINAT PROIECTĂRII

Notație Convențională

— • • • — Limitele teritoriului destinat proiectării

Plan general sc. 1:1000

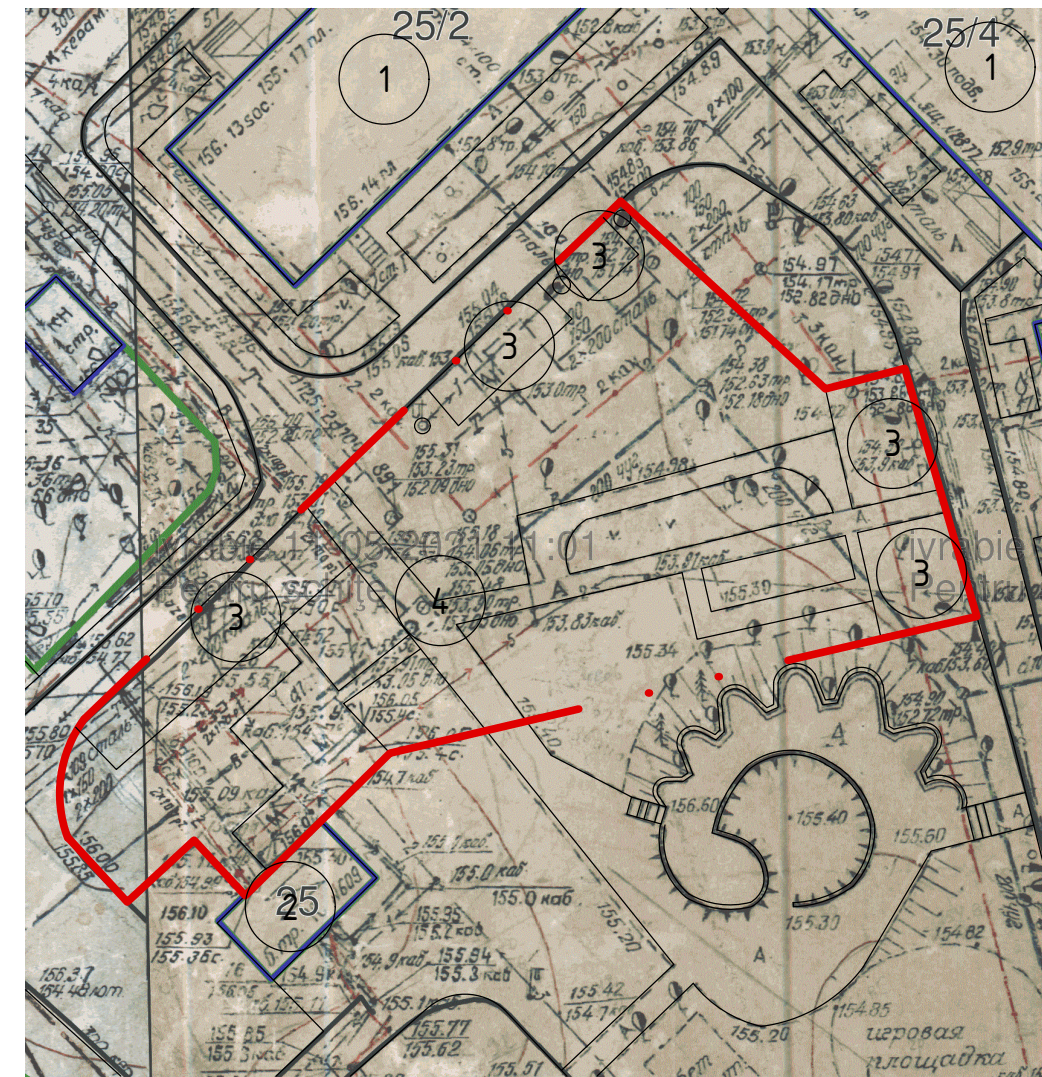

BORDEROU CLĂDIRI/TERENURI

PLANȘA	DENUMIRE	NUMĂRUL NIVELULI	NOTĂ
1	Clădiri locative	9	existent
2	Obiective tehnico-edilitare	1	existent
3	Locuri de parcare improvizate	0	existent
4	Scuar	0	Proiectat

Beneficiar: Pretura sectorului Botanica						10-05-2021-P					
Faza						Privind posibilitatea amenajării unui scuar pe teren cu nr. cadastral 001001130471 în adiacența blocului locativ situat pe adresa mun.Chișinău, sec. Botanica. bd. Cuza Vodă, 25/2.					
						Nr. part					
Plansa						Scuar					
Nr. doc						PS					
Semnat						3					
Data						Planșe					
						Schema de încadrare în teritoriu					
						Plan general sc. 1:1000					

Plan trasare sc. 1:250

bd. Cuza Vodă
25/2

BORDEROU FORME ARHITECTURALE MICI ȘI UTILAJE

Nr.	SEMN CONVENȚIONAL	DENUMIRE	NUMĂRUL	UNITATE
1		Pavaj din dale de beton	456	m ²
2		Borduri	515	m.l.
3		Decoptare strat 10 cm de sol	93	m ³
		Nivelarea a 10 cm cu cernoziom	93	m ³
4		Semănare cu iarbă	933	m ²
		Organizare Vegetativa-Floristica	40	m ²
5		Decopertarea asfaltului uzat	75	m ²

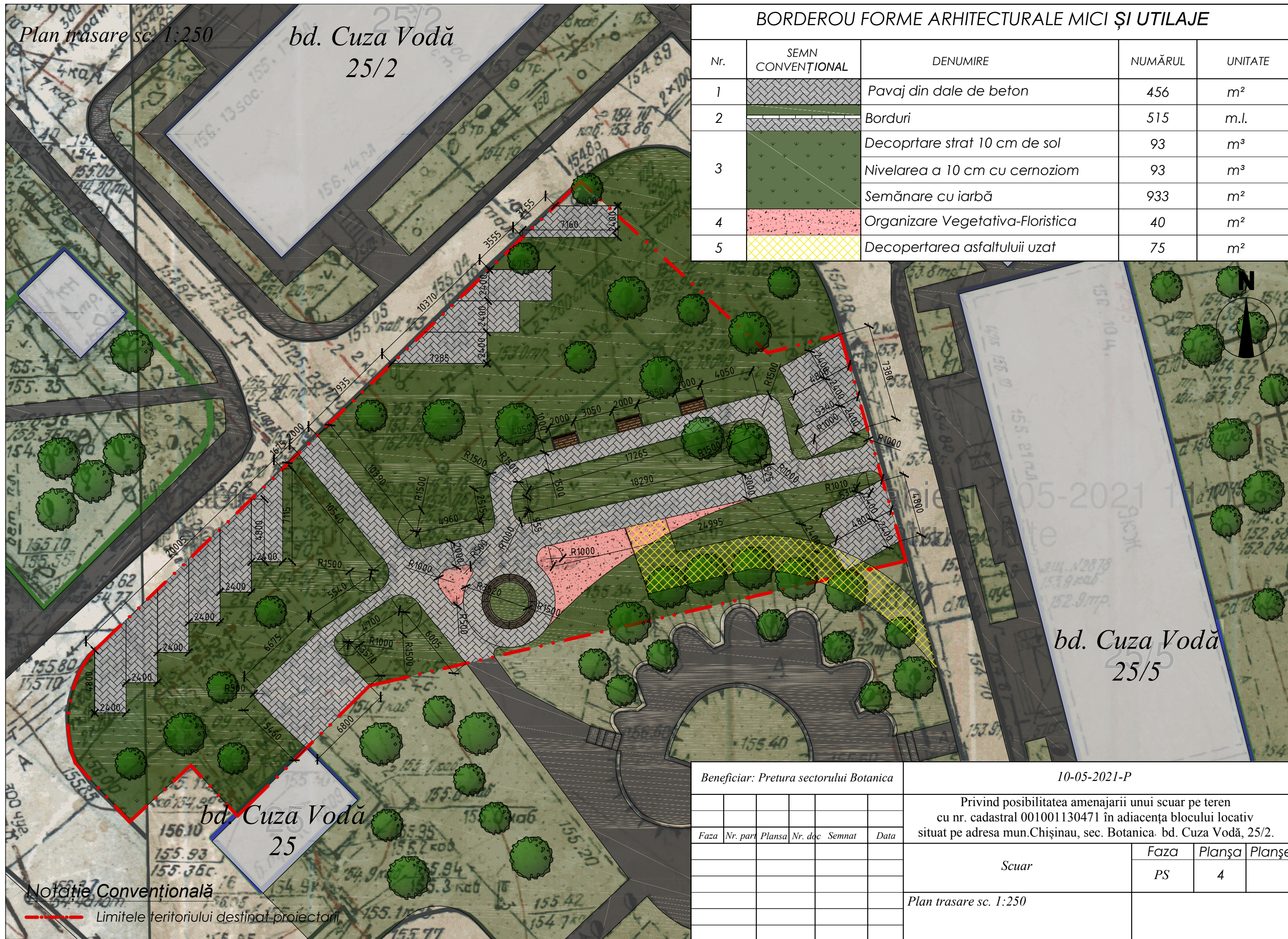

bd. Cuza Vodă
25/5

bd. Cuza Vodă
25

Notatie Conventiională

--- Limitele teritoriului destinat proiectarii

Beneficiar: Pretura sectorului Botanica						10-05-2021-P			
						Privind posibilitatea amenajarii unui scuar pe teren cu nr. cadastral 001001130471 în adiacența blocului locativ situat pe adresa mun.Chișinau, sec. Botanica. bd. Cuza Vodă, 25/2.			
Faza	Nr. part	Planșa	Nr. doc	Semnat	Data	Scuar	Faza	Planșa	Planșe
							PS	4	
						Plan trasare sc. 1:250			

Plan de amenajare cu
amplasarea mobilierului
urban sc. 1:250

bd. Cuza Vodă
25/2

BORDEROU FORME ARHITECTURALE MICI ȘI UTILAJE

Nr.	DENUMIRE	NUMĂRUL	UNITATE	NOTĂ
1	Bănci pentru parc	3	buc.	-
2	Bănci pentru parc (tip cerc)	1	buc.	-
3	Coșuri pentru gunoi	4	buc.	-
4	Locuri pentru parcare	15	locuri	-

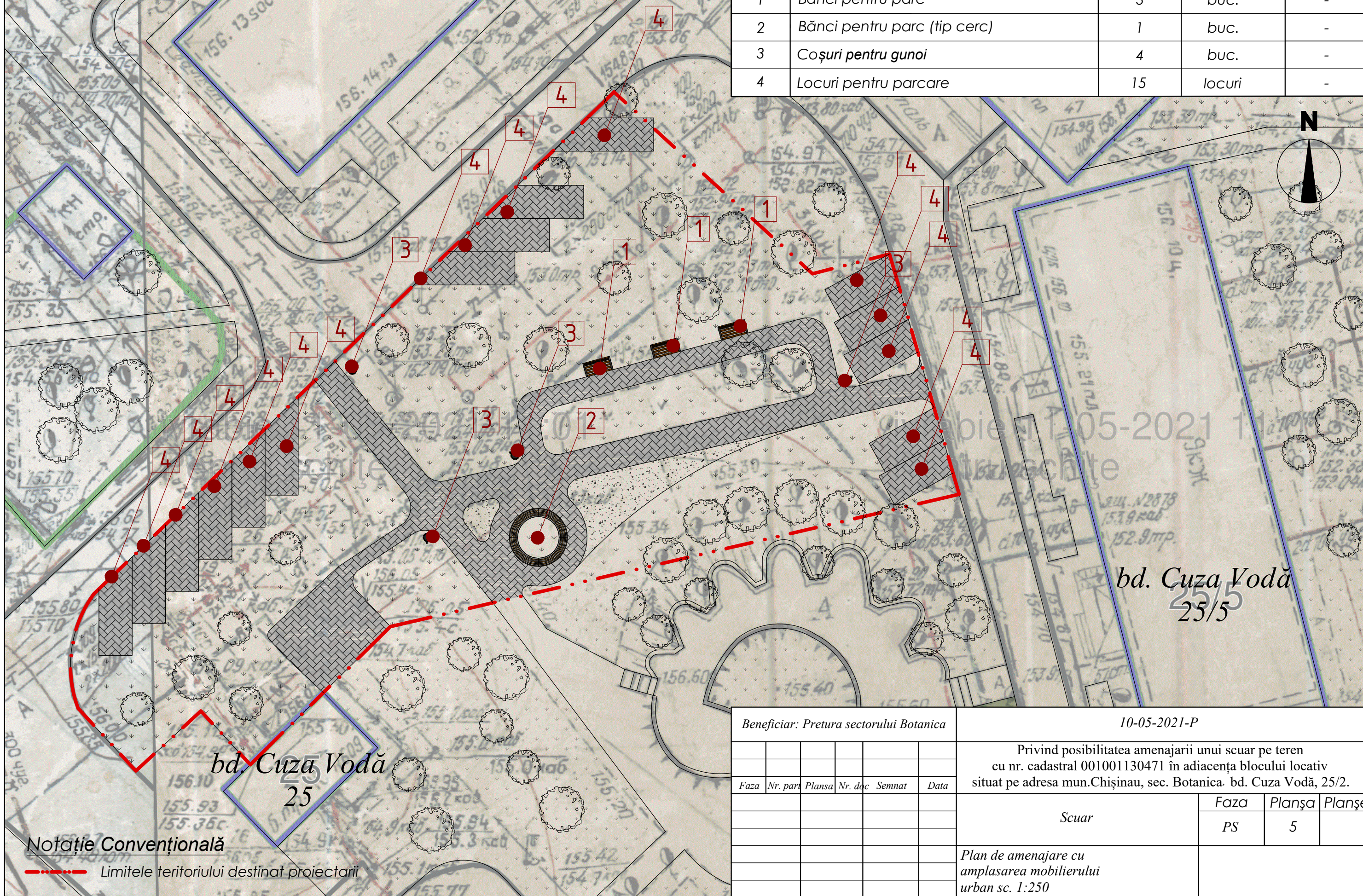

Notație Convențională

----- Limitele teritoriului destinat proiectării

Beneficiar: Pretura sectorului Botanica

10-05-2021-P

Faza	Nr. par.	Plansa	Nr. doc	Semnat	Data

Privind posibilitatea amenajării unui scuar pe teren
cu nr. cadastral 001001130471 în adiacența blocului locativ
situat pe adresa mun. Chișinău, sec. Botanica - bd. Cuza Vodă, 25/2.

Scuar

Faza	Planșa	Planșe
PS	5	

Plan de amenajare cu
amplasarea mobilierului
urban sc. 1:250

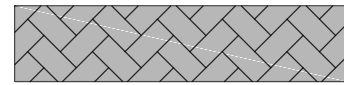

Elementul acoperisului din dale de beton

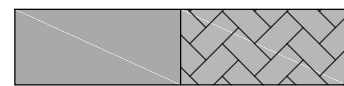
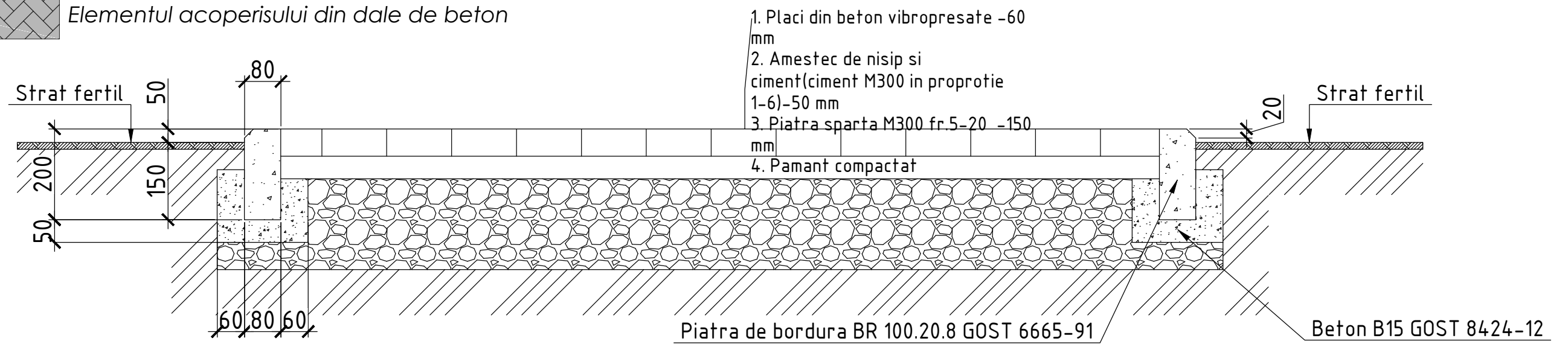

Elementul acoperisului din dale de beton
 si elementul acoperisului existent din beton asfaltic

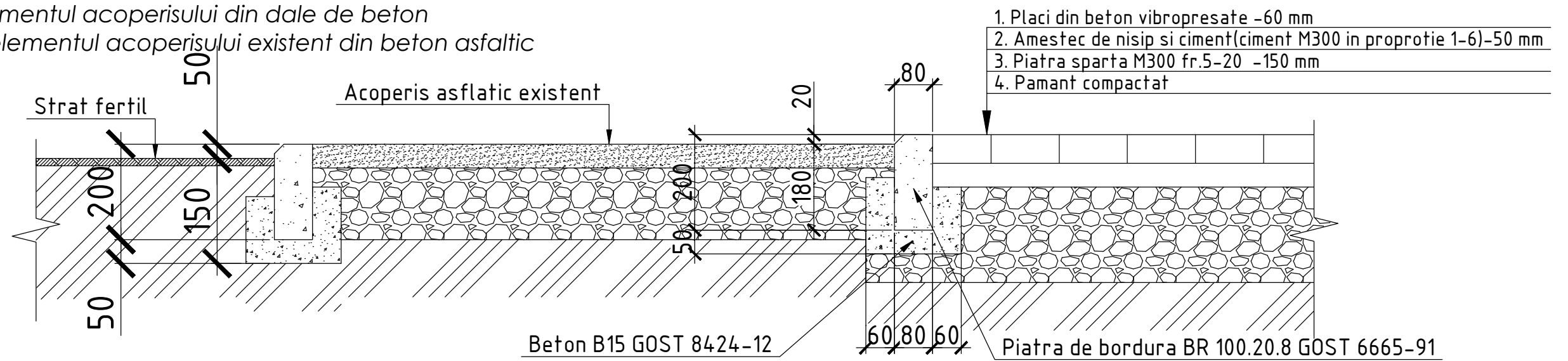

Beneficiar: Pretura sectorului Botanica						10-05-2021-P																																
<table border="1"> <thead> <tr> <th>Faza</th> <th>Nr. par</th> <th>Planşa</th> <th>Nr. doc</th> <th>Semnat</th> <th>Data</th> </tr> </thead> <tbody> <tr> <td> </td> <td> </td> <td> </td> <td> </td> <td> </td> <td> </td> </tr> <tr> <td> </td> <td> </td> <td> </td> <td> </td> <td> </td> <td> </td> </tr> <tr> <td> </td> <td> </td> <td> </td> <td> </td> <td> </td> <td> </td> </tr> <tr> <td> </td> <td> </td> <td> </td> <td> </td> <td> </td> <td> </td> </tr> </tbody> </table>						Faza	Nr. par	Planşa	Nr. doc	Semnat	Data																									Privind posibilitatea amenajarii unui scuar pe teren cu nr. cadastral 001001130471 în adiacența blocului locativ situat pe adresa mun.Chişinău, sec. Botanica. bd. Cuza Vodă, 25/2.		
						Faza	Nr. par	Planşa	Nr. doc	Semnat	Data																											
<table border="1"> <thead> <tr> <th colspan="2">Scuar</th> <th>Faza</th> <th>Planşa</th> <th>Planşe</th> </tr> </thead> <tbody> <tr> <td colspan="2"> </td> <td>PS</td> <td>6</td> <td> </td> </tr> </tbody> </table>						Scuar		Faza	Planşa	Planşe			PS	6																								
						Scuar		Faza	Planşa	Planşe																												
		PS	6																																			
Constructia îmbrăcămintei Acceselor																																						

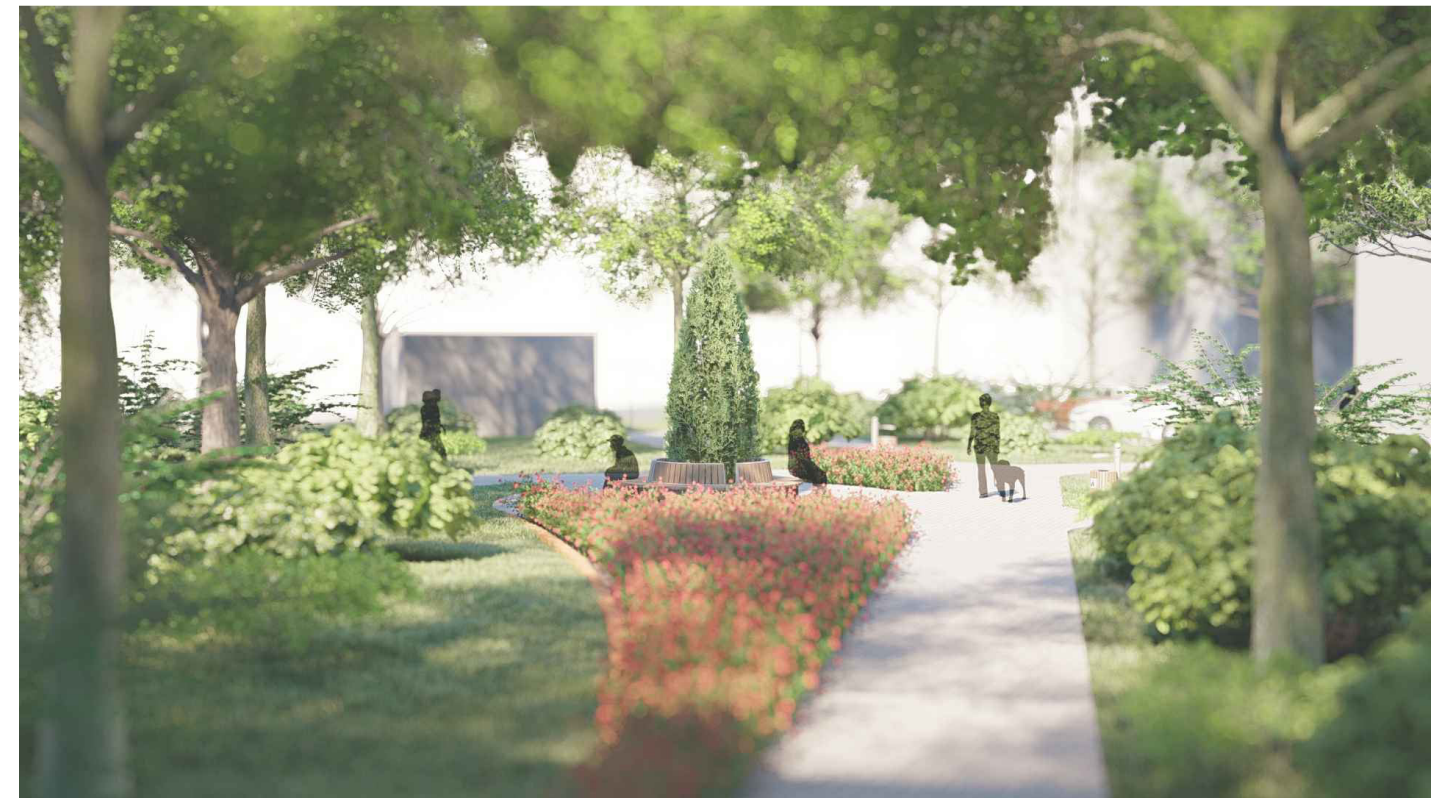

<i>Beneficiar: Pretura sectorului Botanica</i>						<i>10-05-2021-P</i>																																							
<table border="1"> <thead> <tr> <th><i>Faza</i></th> <th><i>Nr. par</i></th> <th><i>Plansa</i></th> <th><i>Nr. doc</i></th> <th><i>Semnat</i></th> <th><i>Data</i></th> </tr> </thead> <tbody> <tr><td> </td><td> </td><td> </td><td> </td><td> </td><td> </td></tr> <tr><td> </td><td> </td><td> </td><td> </td><td> </td><td> </td></tr> <tr><td> </td><td> </td><td> </td><td> </td><td> </td><td> </td></tr> <tr><td> </td><td> </td><td> </td><td> </td><td> </td><td> </td></tr> <tr><td> </td><td> </td><td> </td><td> </td><td> </td><td> </td></tr> </tbody> </table>						<i>Faza</i>	<i>Nr. par</i>	<i>Plansa</i>	<i>Nr. doc</i>	<i>Semnat</i>	<i>Data</i>																															Privind posibilitatea amenajării unui scuar pe teren cu nr. cadastral 001001130471 în adiacența blocului locativ situat pe adresa mun.Chișinău, sec. Botanica. bd. Cuza Vodă, 25/2.			
						<i>Faza</i>	<i>Nr. par</i>	<i>Plansa</i>	<i>Nr. doc</i>	<i>Semnat</i>	<i>Data</i>																																		
<table border="1"> <thead> <tr> <th><i>Faza</i></th> <th><i>Planșa</i></th> <th><i>Planșe</i></th> </tr> </thead> <tbody> <tr> <td><i>Scuar</i></td> <td><i>PS</i></td> <td>8</td> </tr> <tr> <td><i>Vizualizări</i></td> <td> </td> <td> </td> </tr> </tbody> </table>						<i>Faza</i>	<i>Planșa</i>	<i>Planșe</i>	<i>Scuar</i>	<i>PS</i>	8	<i>Vizualizări</i>																																	
						<i>Faza</i>	<i>Planșa</i>	<i>Planșe</i>																																					
<i>Scuar</i>	<i>PS</i>	8																																											
<i>Vizualizări</i>																																													



<i>Beneficiar: Pretura sectorului Botanica</i>						<i>10-05-2021-P</i>			
						Privind posibilitatea amenajării unui scuar pe teren cu nr. cadastral 001001130471 în adiacența blocului locativ situat pe adresa mun.Chișinău, sec. Botanica. bd. Cuza Vodă, 25/2.			
<i>Faza</i>	<i>Nr. par</i>	<i>Planșa</i>	<i>Nr. doc</i>	<i>Semnat</i>	<i>Data</i>	<i>Scuar</i>	<i>Faza</i>	<i>Planșa</i>	<i>Planșe</i>
							<i>PS</i>	9	
						<i>Vizualizări</i>			