

# 1. Masă pentru calculator - Anexa 1

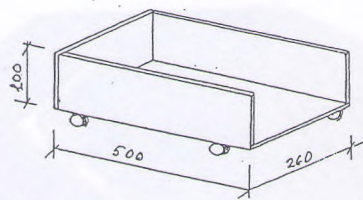

Carucior p/у procesor

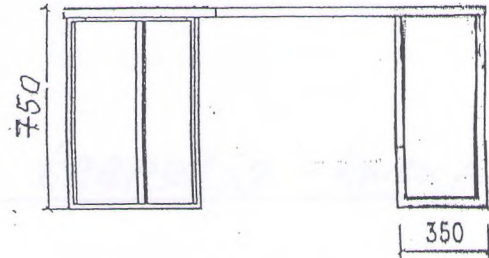
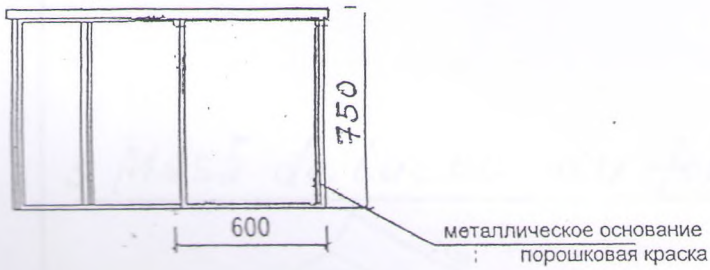
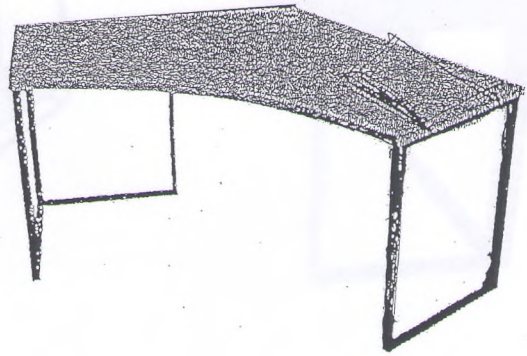
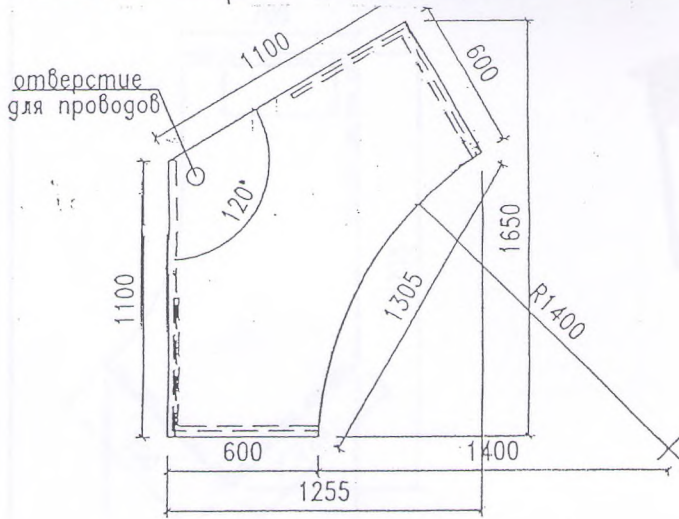

2. Masă pentru calculator (ptu profesor) - Anexa 2

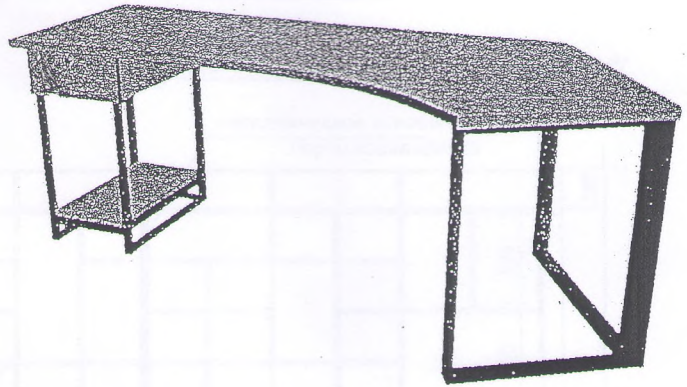
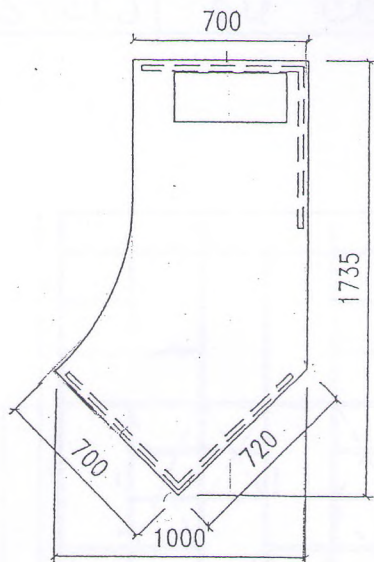

3. Masă de lucru cu formă trapezică - Anexa 3

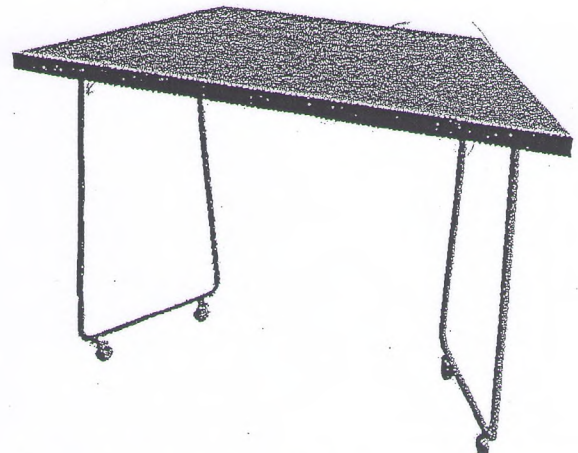
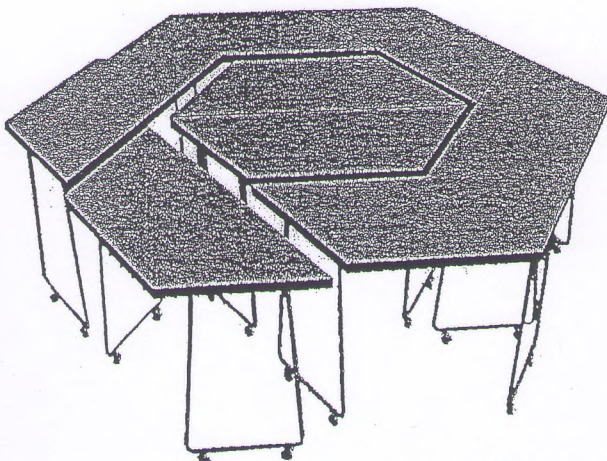
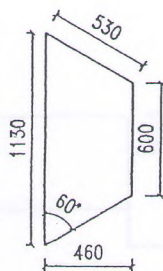
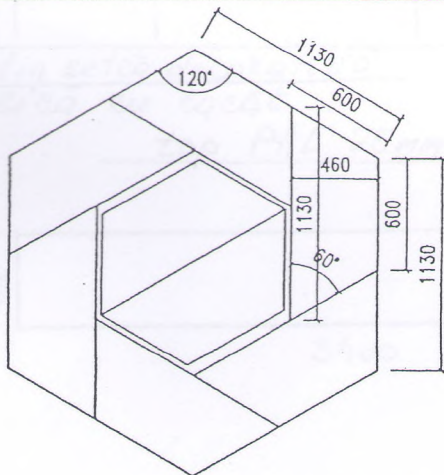

!!! Перед заказом индивидуальных элементов произвести контрольные замеры

500

3400

210

2130

160

500



4. Stelaj cu celule pentru ochelari-amenaj

Baqhet decorativ P4L 18mm

Металлическое основание  
поручиковая краска

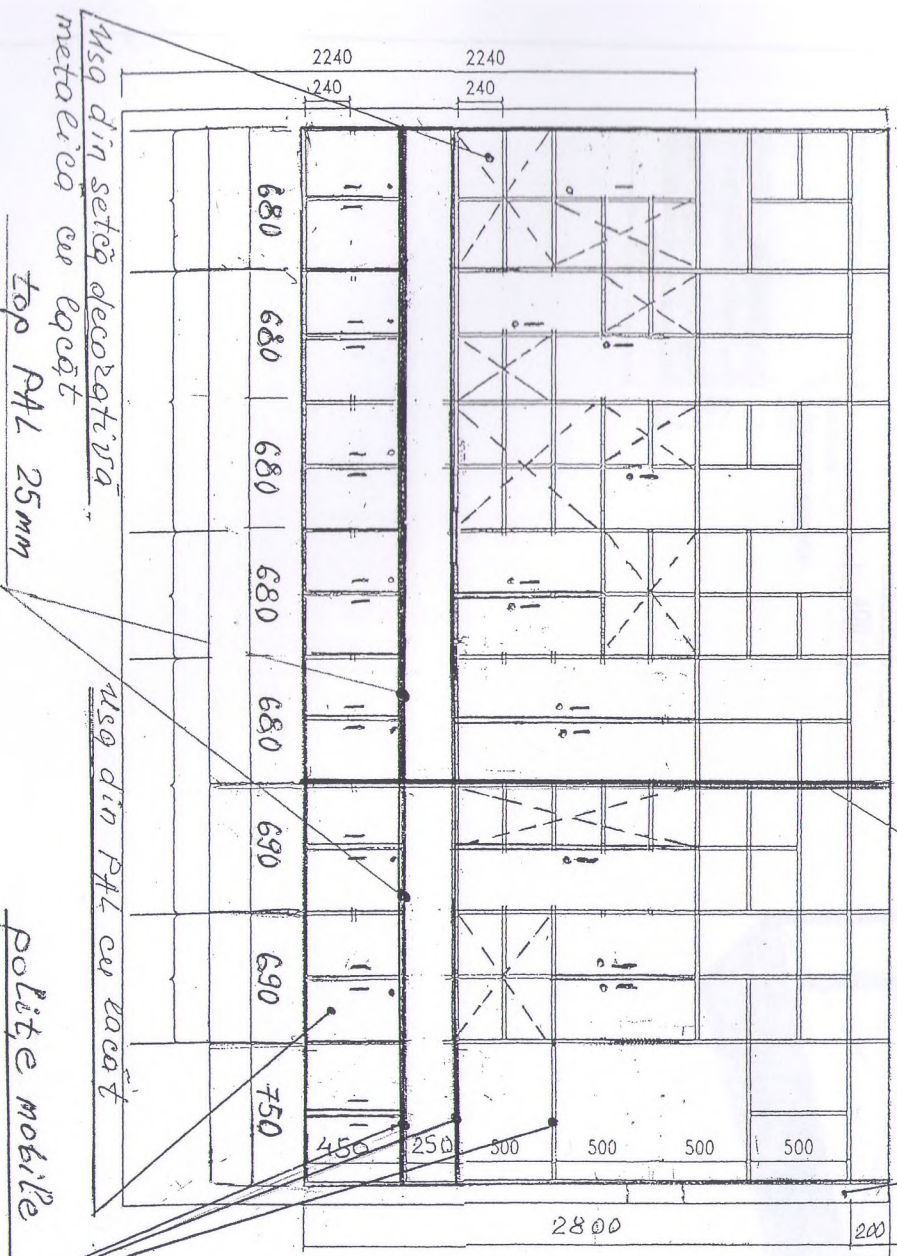

Msq din setaj decorativa  
metalica cu lacat  
top P4L 25mm

Msq din P4L cu lacat  
polite mobile

# 5. Polita - Амет 5

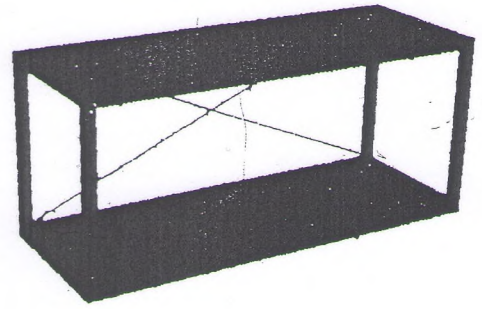
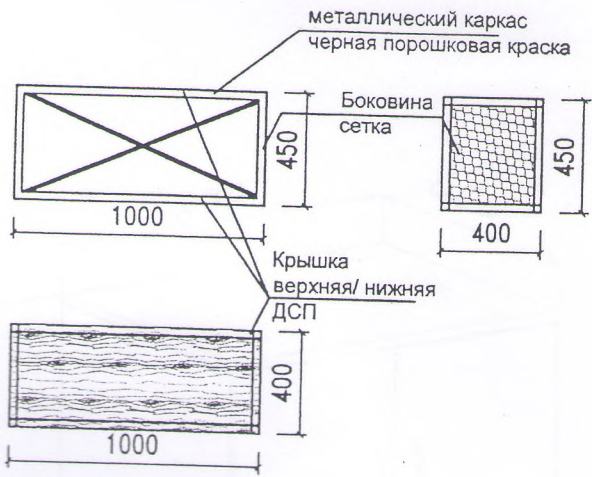



6. Comodă pentru PRINTER - Anexa 20a

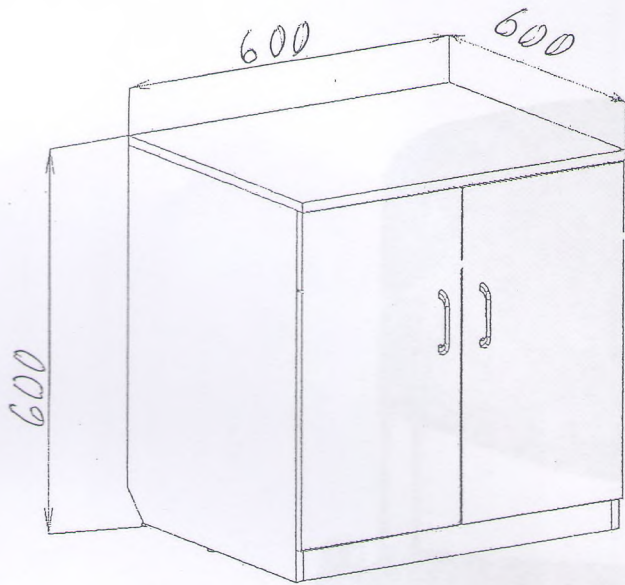

7.

Anexa 92a

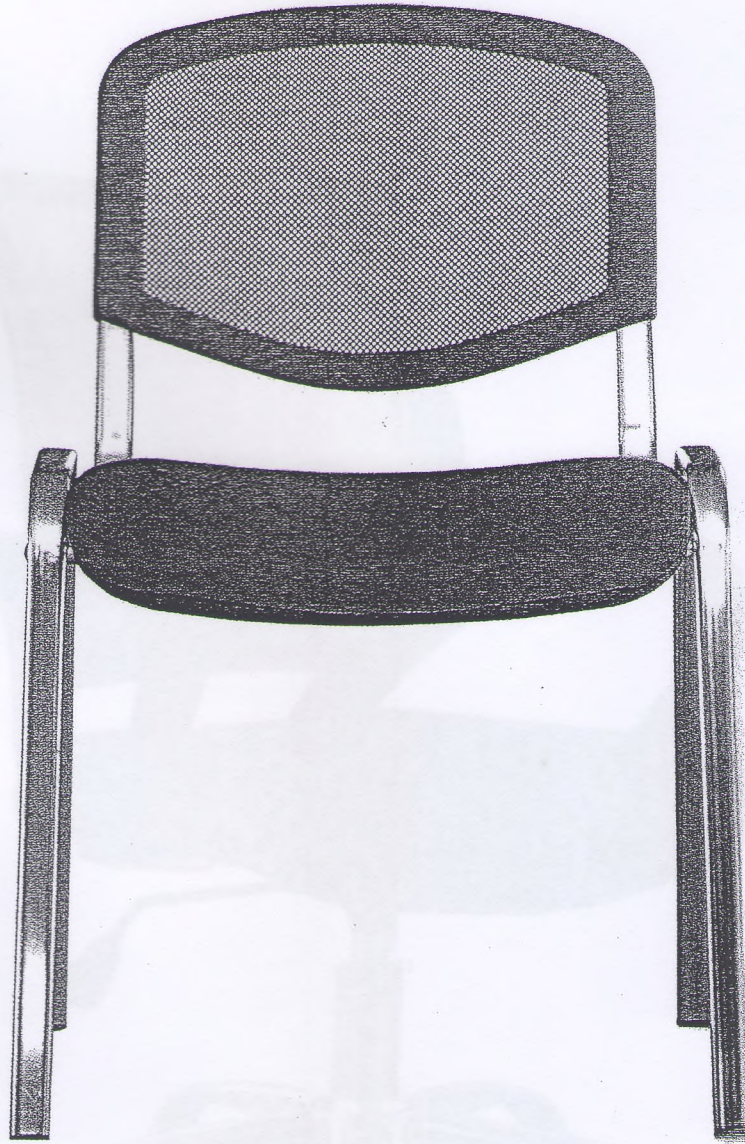

ISO net chrome



Анеха 6





9. Element moale (pref) - Anexa 7

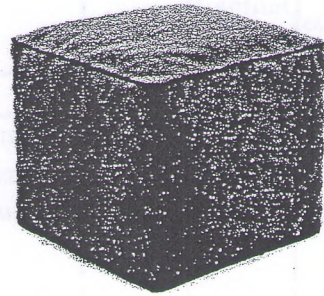
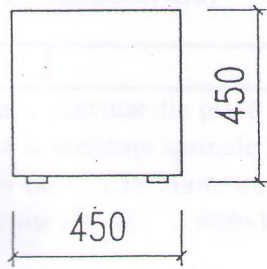
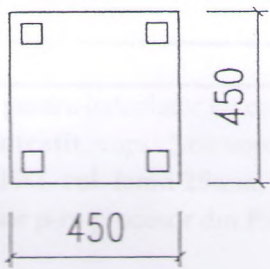

10. Tablă albă p/u marker - Anexa 8

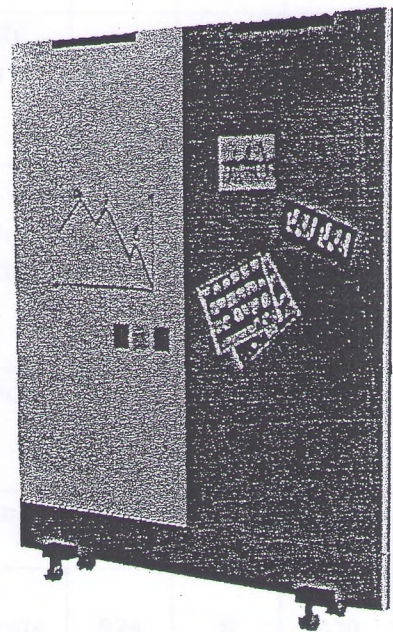
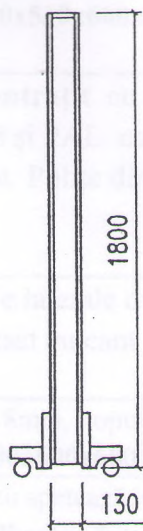
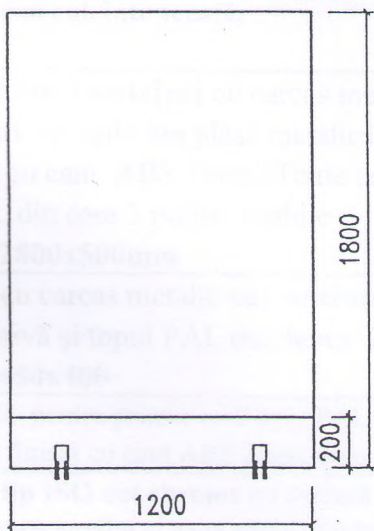

!!! Перед заказом индивидуальных элементов произвести контрольные замеры











