

1. Masă pentru calculator - Anexa 1

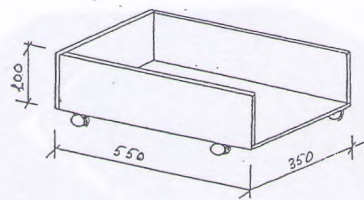

Carucior p/у procesor

2. Masă pentru calculator (p/n profesor) - Anexa 2

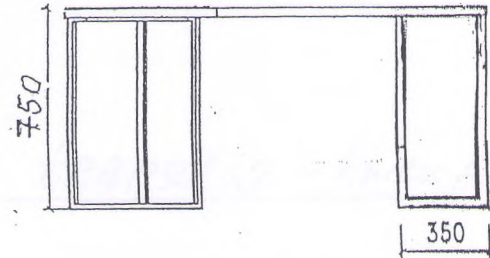
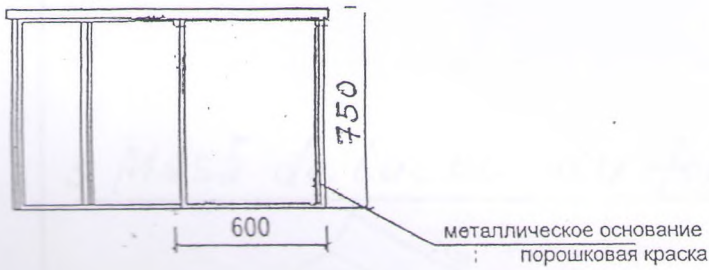
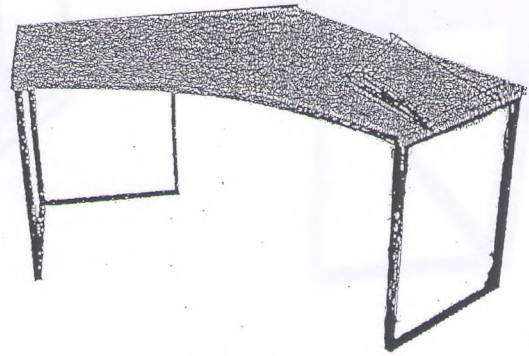
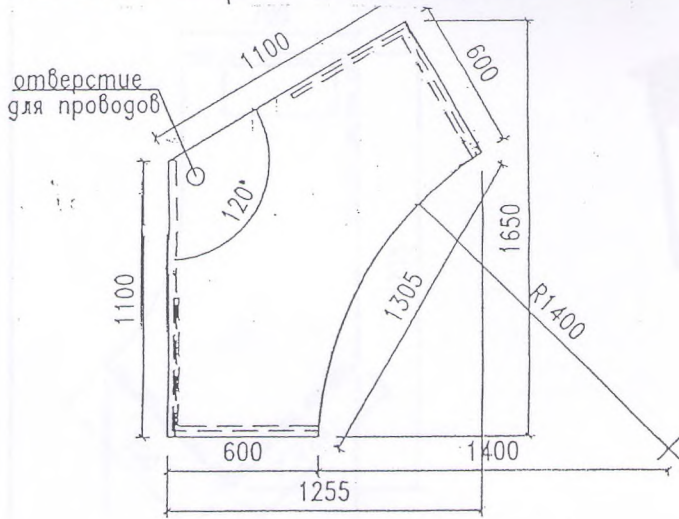
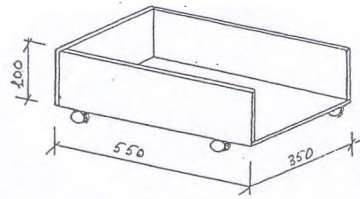
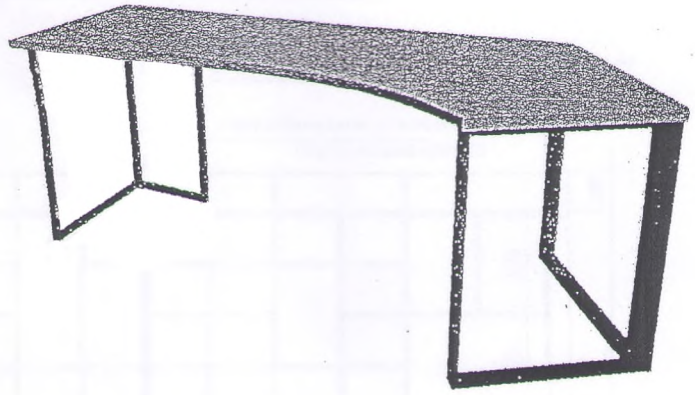
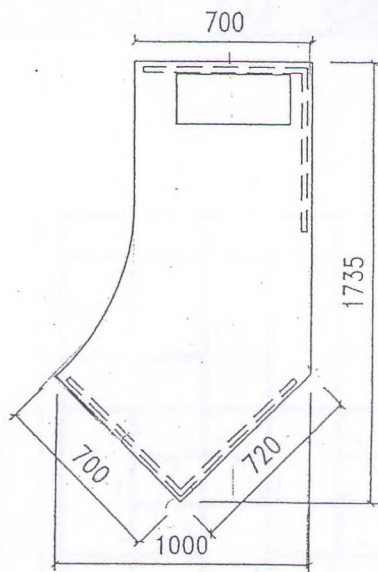

Carucior p/n procesor

3. Masă de lucru cu formă trapezică - Anexa 3

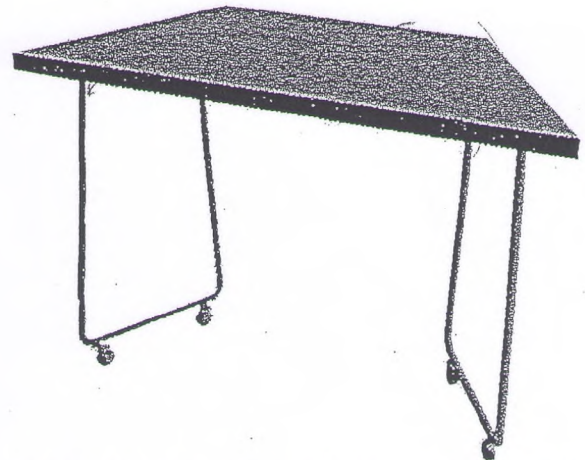
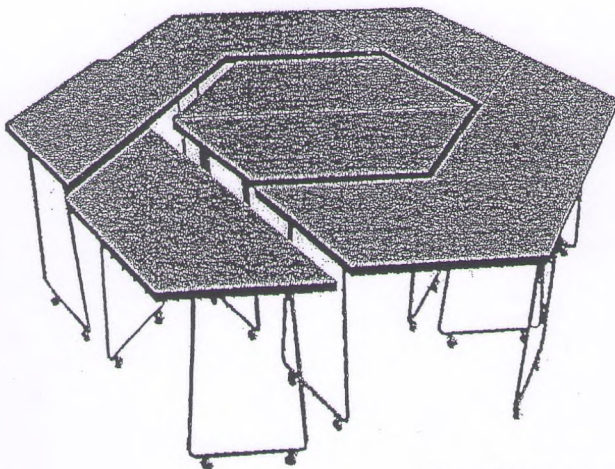
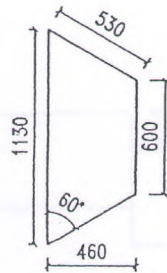
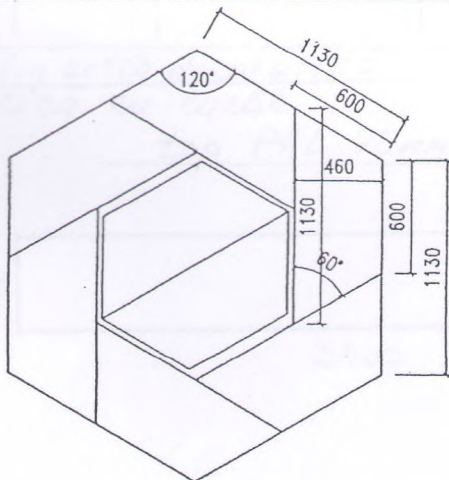

!!! Перед заказом индивидуальных элементов произвести контрольные замеры

500

3400

210

2130

160

500

4. Stelaj cu celule pentru ochelari-amenaj

Baqhet decorativ PVL 18mm

Металлическое основание
популярная краска

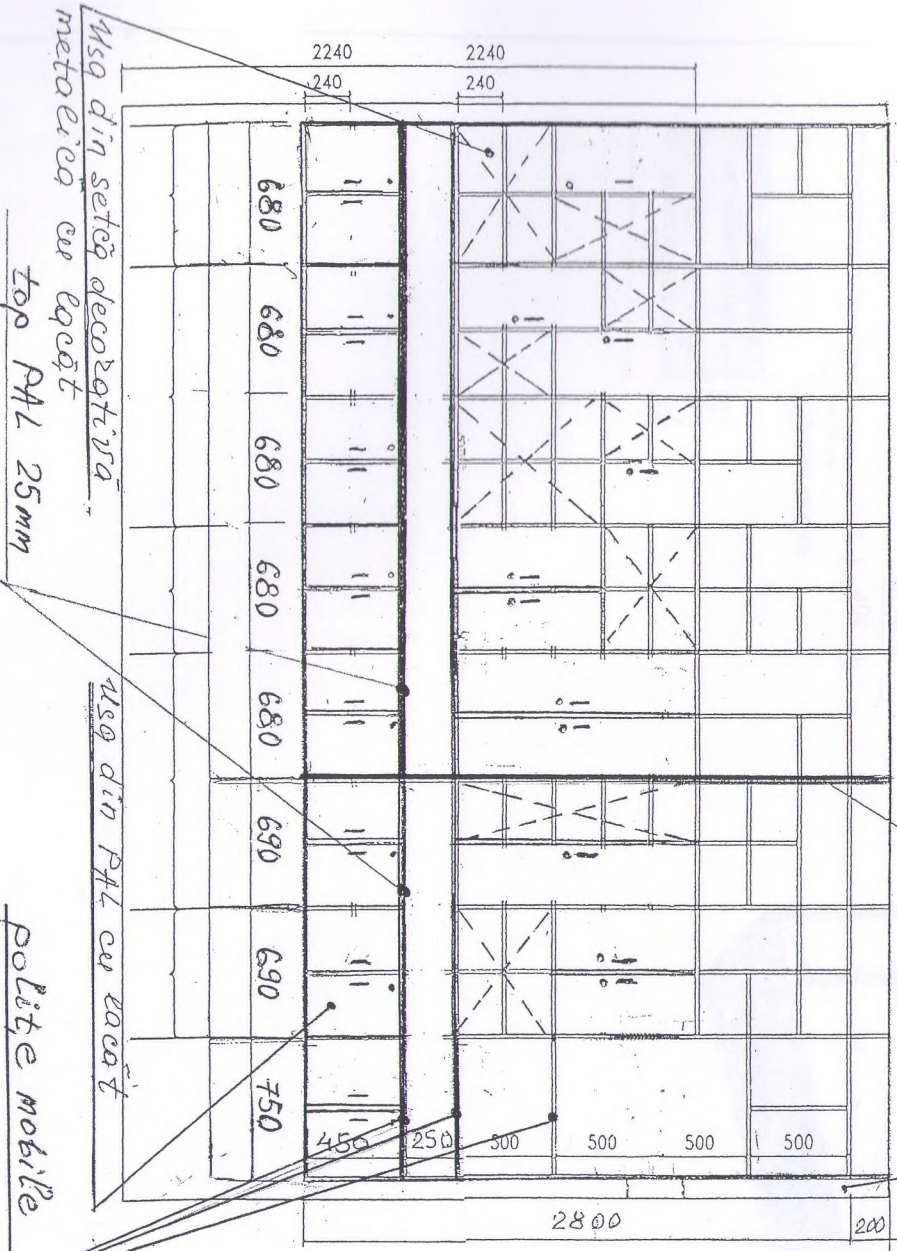

5. Polita - Амет 5

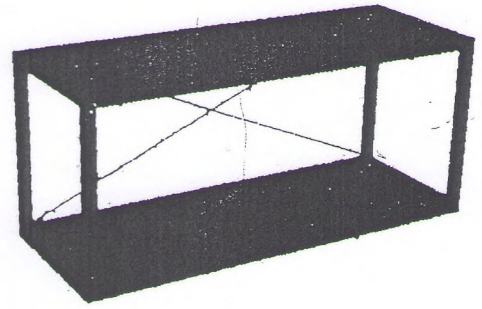
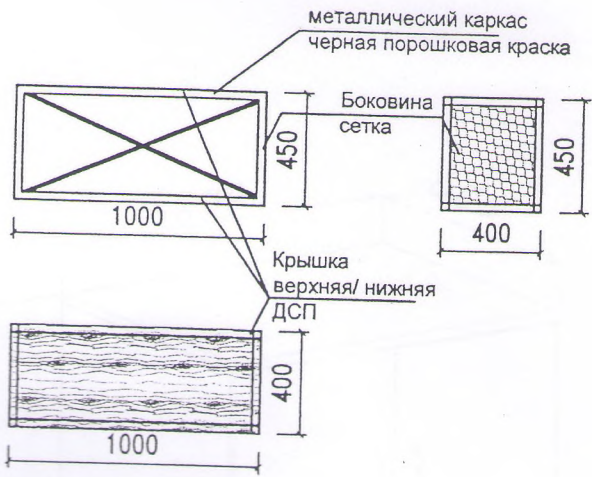

6. Comodă pentru PRINTER - Anexa 20a

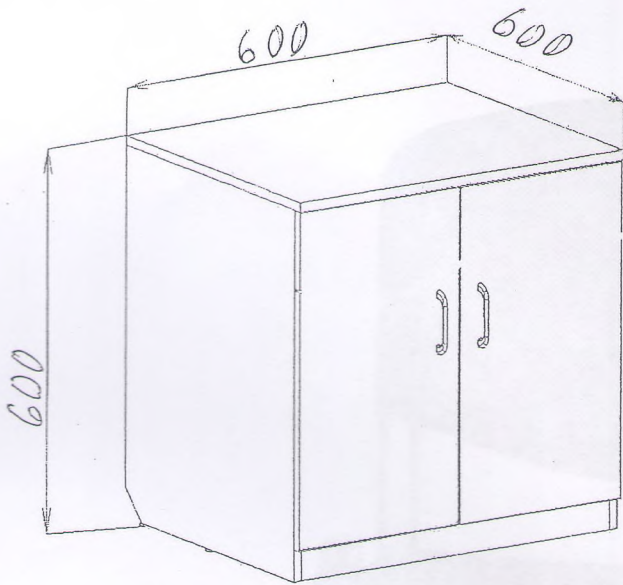

7.

Anexa 92a

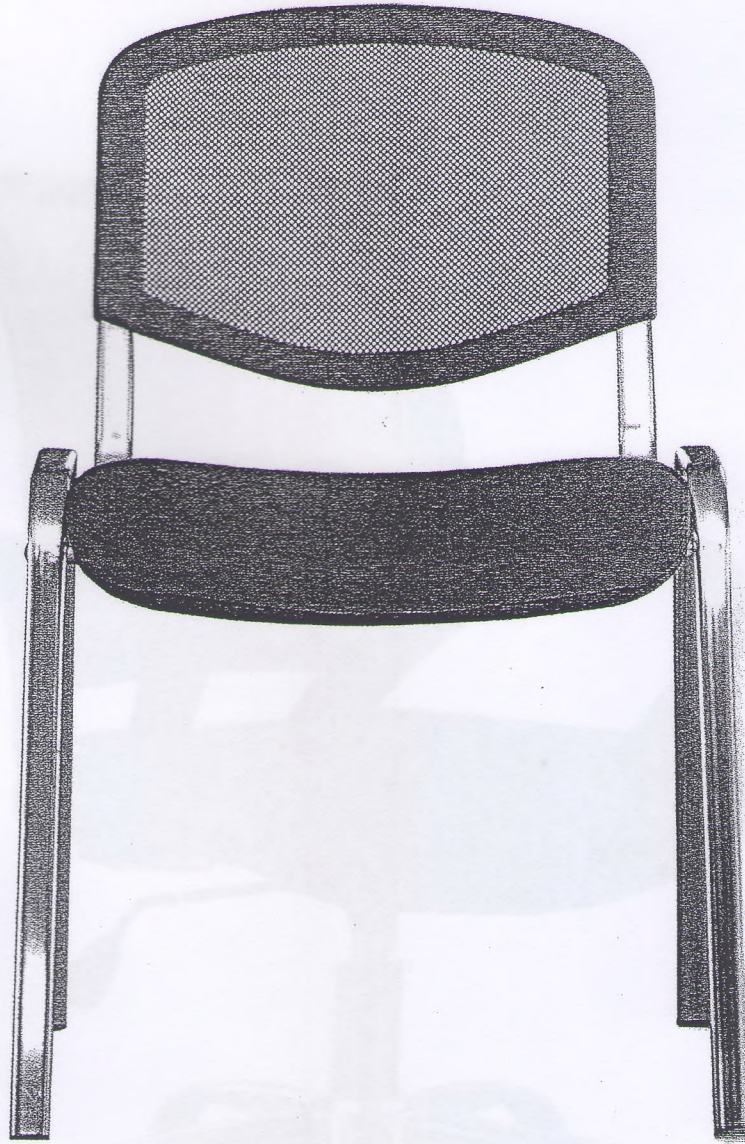

ISO net chrome

Анеха 6



!!! Перед заказом индивидуальных элементов производства
нужно сделать эскизы

9. Element moale (pref) - Anexa 7

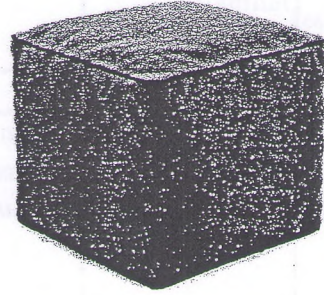
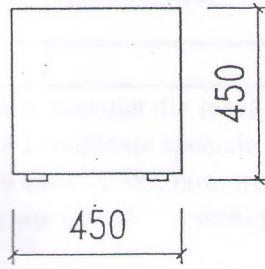
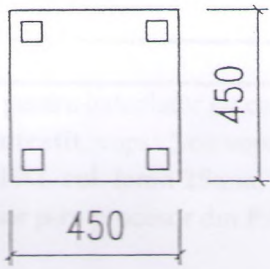

10. Tablă albă p/u marker - Anexa 8

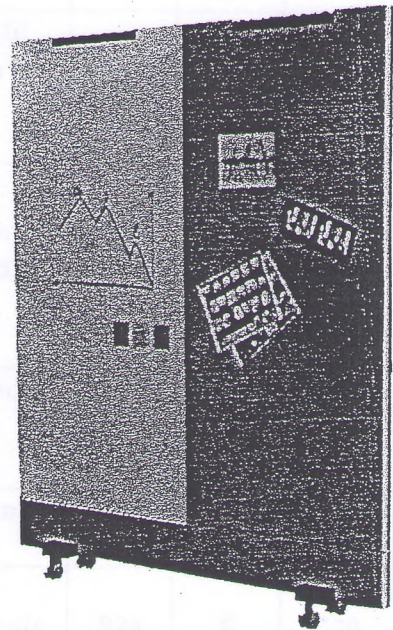
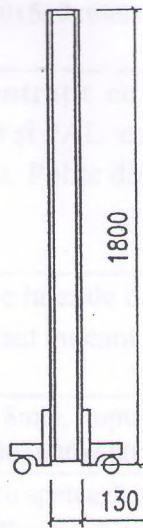
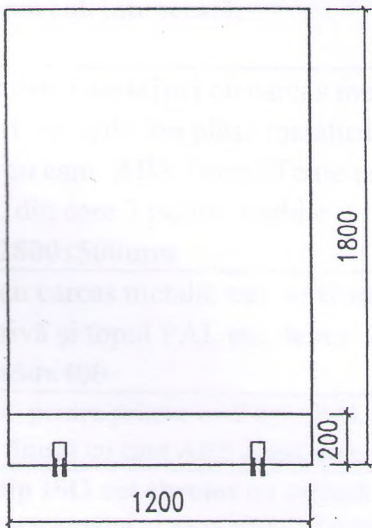

!!! **Перед заказом индивидуальных элементов произвести контрольные замеры**





