



Accessories and Consumables

CATALOGUE

2024.07

www.mindray.com

P/N:ENG-Accessories and Consumables Catalogue-210210X160P-20240717
©2024 Shenzhen Mindray Bio-Medical Electronics Co.,Ltd. All rights reserved.





Welcome to the Mindray Accessories Catalogue

This catalogue will provide you with the parts and accessories that connect to your Mindray Patient Monitor, Electrocardiograph, Defibrillator. Each Mindray product is the product of a special brand of patient focused, clinician-friendly design. For this reason, you can expect the same service, focus and quality with our parts and accessories.

Finding the Right Part

This catalog has been designed to make finding the right part easy. Chapters are organized by specific parameter categories. Simply locate the type of part you are looking for under the appropriate category.

Note:

This catalog is not an Operating Instructions Manual. This catalog will assist you in identifying the correct parts and accessories to connect to your Mindray product, please refer to the Operating Instructions Manual. Warnings, Precautions and Notes can also be found in the Operating Instructions.

Patient Monitor Accessories

ECG	2
SpO ₂	22
NIBP	36
mWear	52
TEMP	56
CO ₂	67
AG	82
IBP	86
RM	91
C.O.	94
ICG	98
BIS	99
ESI	100
PICCO ₂	102
CCO	106
aEEG	107
ANI	111
NMT	112
rSO ₂	115
Mounting	116
Rolling stands	127
Others	129
Accessories Management	132
Barcode Scanner	133

01

02

Defibrillator Accessories

134

03

Electrocardiograph Accessories

154



Patient Monitor Accessories

ECG Accessories







Integrated ECG Cable

- Integrated design, convenient for use and maintenance
- Meeting the requirements of EC53
- Outstanding shielding property and anti-interference performance, protecting ECG signal from being interfered
- Excellent defibrillation-proof performance, well protecting the equipment
- Flexible and durable cables
- Outstanding cable material, enduring repeated cleaning and disinfection
- Latex free

Integrated ECG Cables - IEC

For BeneVision, ePM, uMEC series monitors, BeneHeart defibrillator, uMED 20

Picture	Model	Part No.	No. Description	Purchasing Unit
	EA6252B	040-000963-00	ECG cable and wires (integrative): Adu/Ped, 12 Pin 5-Lead, Defib-Proof, IEC, Snap, 3.6 m	Each
	EA6232B	040-000967-00	ECG cable and wires (integrative): Adu/Ped, 12 Pin 3-Lead, Defib-Proof, IEC, Snap, 3.6 m	Each
	EA6252A	040-000962-00	ECG cable and wires (integrative): Adu/Ped, 12 Pin 5-Lead, Defib-Proof, IEC, Clip, 3.6 m	Each
	EA6232A	040-000966-00	ECG cable and wires (integrative): Adu/Ped, 12 Pin 3-Lead, Defib-Proof, IEC, Clip, 3.6 m	Each

Integrated ECG Cables - AHA

For BeneVision, ePM, uMEC series monitors, BeneHeart defibrillator, uMED 20

Picture	Model	Part No.	No. Description	Purchasing Unit
	EA6251B	040-000961-00	ECG cable and wires (integrative): Adu/Ped, 12 Pin 5-Lead, Defib-Proof, AHA, Snap, 3.6 m	Each
	EA6231B	040-000965-00	ECG cable and wires (integrative): Adu/Ped, 12 Pin 3-Lead, Defib-Proof, AHA, Snap, 3.6 m	Each
	EA6251A	040-000960-00	ECG cable and wires (integrative): Adu/Ped, 12 Pin 5-Lead, Defib-Proof, AHA, Clip, 3.6 m	Each
	EA6231A	040-000964-00	ECG cable and wires (integrative): Adu/Ped, 12 Pin 3-Lead, Defib-Proof, AHA, Clip, 3.6 m	Each

Trunk Cables

- Easy to replace leadwires
- Meeting the requirements of EC53
- Outstanding shielding property and anti-interference performance, protecting ECG signal from being interfered
- Excellent defibrillation-proof performance, well protecting the equipment
- ESU-proof, ensuring ECG signals not interfered during operation Flexible and durable cables
- Outstanding cable material, enduring repeated cleaning and disinfection
- Latex free

For BeneVision, ePM, uMEC series monitors, BeneHeart defibrillator, uMED 20

Picture	Model	Part No.	No. Description	Purchasing Unit
	EV6201	0010-30-42719 (009-004728-00)	ECG trunk cable: 3/5-lead, Adu/Ped, 12 Pin, Defib-Proof, AHA/IEC, 3 m	Each
	EV6211	0010-30-42723	ECG trunk cable: 3/5-lead, Adu/Ped, 12 Pin, ESU-Proof, AHA/IEC, 3 m	Each
	EV6202	0010-30-42720	ECG trunk cable: 3-lead, Ped/Neo, 12 Pin, Defib-Proof, AHA/IEC, 3 m	Each

Picture	Model	Part No.	No. Description	Purchasing Unit
	EV6212	0010-30-42724	ECG trunk cable: 3-lead, Ped/Neo, 12 Pin, ESU-Proof, AHA/IEC, 3 m	Each
	EV6203	0010-30-42721	ECG trunk cable: 12-lead, Adu/Ped, 12 Pin, Defib-Proof, AHA, 3 m	Each
	EV6204	0010-30-42722	ECG trunk cable: 12-lead, Adu/Ped, 12 Pin, Defib-Proof, IEC, 3 m	Each
	EV6222	040-000754-00	ECG Trunk Cable, 3-lead, Ped/Neo, 12 Pin, TPU, Defib-Proof, AHA/IEC, 3 m	Each

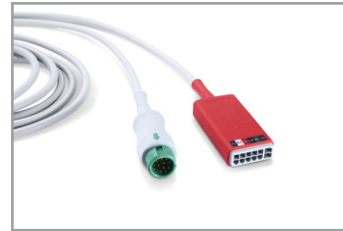

For BeneVision, ePM series monitors

Picture	Model	Part No.	No. Description	Purchasing Unit
	EV6206	009-005266-00	ECG trunk cable: 3/5/6-lead, Adu/Ped, Defib-proof, 12 Pin, 3.1m, AHA/IEC	Each
	EV6216	009-005268-00	ECG trunk cable: 3/5/6-lead, Adu/Ped, ESU-proof, 12 Pin, 3.1m, AHA/IEC	Each

ECG Leadwires – IEC

- Easy to replace trunk cables
- Meeting the requirements of EC53
- Outstanding shielding property and anti-interference performance, protecting ECG signal from being interfered
- Flexible and durable cables
- Outstanding cable material, enduring repeated cleaning and disinfection
- Latex free

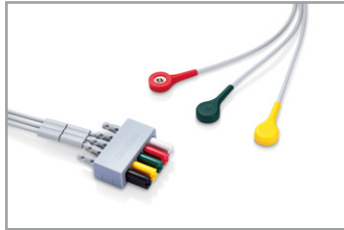
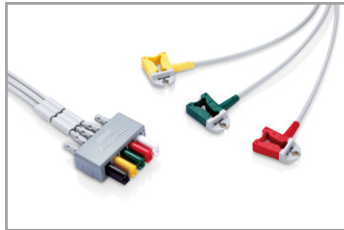

Match with 3/5-lead cables (0010-30-42719, 0010-30-42723)

Picture	Model	Part No.	No. Description	Purchasing Unit
	EL6502A	0010-30-42728	5-Lead ECG wires, Clip, Adu/Ped, TPU, IEC, 0.6m/1m	Each
	EL6504A	0010-30-42730	5-Lead ECG wires, Clip, Adu/Ped, TPU, IEC, long, 1m/1.4 m	Each
	EL6502B	0010-30-42736 (009-004730-00)	5-Lead ECG wires, Snap, Adu/Ped, TPU, IEC, 1m/1.4m	Each





Picture	Model	Part No.	No. Description	Purchasing Unit
	EL6308B	0010-30-42733	3-Lead ECG wires, Snap, Adu/Ped, TPU, IEC, 1m	Each
	EL6304A	0010-30-42732	3-Lead ECG wires, Clip, Adu/Ped, TPU, IEC, 1m	Each

Match with 3-lead cables (0010-30-42720, 0010-30-42724)				
Picture	Model	Part No.	No. Description	Purchasing Unit
	EL6306A	0010-30-42897	3-Lead ECG wires, Clip, Neo, TPU, IEC, 1m	Each

Match with 3-lead Neonatal cables (040-000754-00)

Picture	Model	Part No.	No. Description	Purchasing Unit
	EL6312B	040-000147-00	3-lead ECG wires, Single-patient use, Ped/Neo, Snap, IEC, DIN, 1m	Each
	EL6312A	040-000149-00	3-lead ECG wires, Single-patient use, Ped/Neo, Clip, IEC, DIN, 1m	Each

Match with 12-lead cables (0010-30-42721, 0010-30-42722)

Picture	Model	Part No.	No. Description	Purchasing Unit
	EL6802B	0010-30-42907	12-Lead ECG limb wires, Snap, Adu/Ped, Gray, TPU, IEC, 0.8 m	Each
	EL6804B	0010-30-42909	12-Lead ECG Chest Wires, Snap, Adu/Ped, White, TPU, IEC, 0.6 m	Each
	EL6802A	0010-30-42903	12-Lead ECG limb wires, Clip, Adu/Ped, Gray, TPU, IEC, 0.8 m	Each
	EL6804A	0010-30-42905	12-Lead ECG Chest Wires, Clip, Adu/Ped, White, TPU, IEC, 0.6 m	Each

For BeneVision, ePM series monitors, Telemetry (TM80)

Picture	Model	Part No.	No. Description	Purchasing Unit
	EY6304B	009-004797-00	6-Lead, Adu/Ped, Snap, 36", reusable, TPU, IEC, BeneVision	Each

	EY6504B	009-004801-00	6-Lead, Adu/Ped, Clip, 36", reusable, TPU, IEC, BeneVision	Each
---	---------	---------------	--	------

For Telemetry (TM80)

Picture	Model	Part No.	No. Description	Purchasing Unit
	EY6308B	009-004769-00	3-Lead, Adu/Ped, Snap, 36", reusable, TPU, IEC, BeneVision	Each

	EY6308A	009-004775-00	3-Lead, Adu/Ped, Clip, 36", reusable, TPU, IEC, BeneVision	Each
---	---------	---------------	--	------

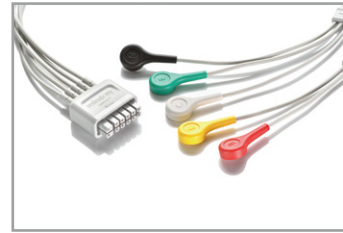
Picture	Model	Part No.	No. Description	Purchasing Unit
	EY6506B	009-004785-00	5-Lead, Adu/Ped, Snap, 36", reusable, TPU, IEC, BeneVision	Each

	EY6506A	009-004789-00	5-Lead, Adu/Ped, Clip, 36", reusable, TPU, IEC, BeneVision	Each
---	---------	---------------	--	------



	EY6304A	009-004780-00	3-Lead, Adu/Ped, Snap, 24", single-patient, IEC, BeneVision	Each
--	---------	---------------	---	------



	EY6504A	009-004792-00	5-Lead, Adu/Ped, Snap, 24", single-patient, IEC, BeneVision	Each
---	---------	---------------	---	------

ECG Leadwire – AHA

- Easy to replace trunk cables
- Meeting the requirements of EC53
- Outstanding shielding property and anti-interference performance, protecting ECG signal from being interfered
- Flexible and durable cables
- Outstanding cable material, enduring repeated cleaning and disinfection
- Latex free



Match with 3/5-lead cables (0010-30-42719, 0010-30-42723)

Picture	Model	Part No.	No. Description	Purchasing Unit
	EL6501A	0010-30-42727	5-Lead ECG wires, Clip, Adu/Ped, TPU, AHA, 0.6m/1m	Each
	EL6503A	0010-30-42729	5-Lead ECG wires, Clip, Adu/Ped, TPU, AHA, long, 1m/1.4 m	Each
	EL6501B	0010-30-42735 (009-004729-00)	5-Lead ECG wires, Snap, Adu/Ped, TPU, AHA, 1m/1.4m	Each





Picture	Model	Part No.	No. Description	Purchasing Unit
	EL6301B	0010-30-42734	3-Lead ECG wires, Snap, Adu/Ped, TPU, AHA, 1m	Each
	EL6303A	0010-30-42731	3-Lead ECG wires, Clip, Adu/Ped, TPU, AHA, 1m	Each

Match with 3-lead cables (0010-30-42720, 0010-30-42724)				
Picture	Model	Part No.	No. Description	Purchasing Unit
	EL6305A	0010-30-42896	3-Lead ECG wires, Clip, Neo, TPU, AHA, 1m	Each



Match with 3-lead Neonatal cables (040-000754-00)

Picture	Model	Part No.	No. Description	Purchasing Unit
	EL6311B	040-000146-00	3-Lead ECG wires, Disposable, AHA, Snap, 1m	Each
	EL6311A	040-000148-00	3-Lead ECG wires, Disposable, AHA, Clip, 1m	Each



Match with 12-lead cables (0010-30-42721, 0010-30-42722)





Picture	Model	Part No.	No. Description	Purchasing Unit
	EL6801A	0010-30-42902	12-Lead ECG limb wires, Clip, Adu/Ped, Gray, TPU, AHA, 0.8 m	Each
	EL6803A	0010-30-42904	12-Lead ECG Chest wires, Clip, Adu/Ped, Brown, TPU, AHA, 0.6 m	Each
	EL6801B	0010-30-42906	12-Lead ECG limb wires, Snap, Adu/Ped, Gray, TPU, AHA, 0.8 m	Each
	EL6803B	0010-30-42908	12-Lead ECG Chest wires, Snap, Adu/Ped, Brown, TPU, AHA, 0.6 m	Each

For BeneVision, ePM series monitors, Telemetry (TM80)

Picture	Model	Part No.	No. Description	Purchasing Unit
	EY6602B	009-004795-00	6-Lead, Adu/Ped, Snap, 36", reusable, TPU, AHA, BeneVision	Each
	EY6602A	009-004799-00	6-Lead, Adu/Ped, Clip, 36", reusable, TPU, AHA, BeneVision	Each

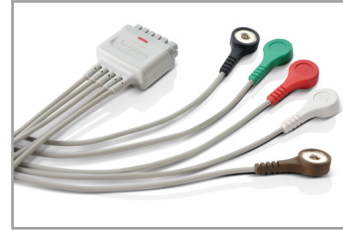

For Telemetry (TM80)

Picture	Model	Part No.	No. Description	Purchasing Unit
	EY6305B	009-004766-00	3-Lead, Adu/Ped, Snap, 36", reusable, TPU, AHA, BeneVision	Each
	EY6305A	009-004772-00	3-Lead, Adu/Ped, Clip, 36", reusable, TPU, AHA, BeneVision	Each

Picture	Model	Part No.	No. Description	Purchasing Unit
	EY6512B	009-004783-00	5-Lead, Adu/Ped, Snap, 36", reusable, TPU, AHA, BeneVision	Each
	EY6512A	009-004787-00	5-Lead, Adu/Ped, Clip, 36", reusable, TPU, AHA, BeneVision	Each
	EY6310B	009-004777-00	3-Lead, Adu/Ped, Snap, 24", single-patient, AHA, BeneVision	Each
	EY6507B	009-004790-00	5-Lead, Adu/Ped, Snap, 24", single-patient, AHA, BeneVision	Each

Electrode

- Latex free
- DEHP free
- Good biocompatibility, avoiding allergic reactions to patient

Picture	Model	Part No.	No. Description	Purchasing Unit
	H124SG	900E-10-04880	Neonatal ECG Electrode (Kendall, H124SG)	50pcs/pouch
		040-002711-00	Adult ECG electrode (INTCO)	5 pcs/pouch
		040-002833-00	Pediatric/Neonatal ECG electrode (INTCO)	30 pcs/pouch

Match with 3-lead Neonatal cables (040-000754-00)

Picture	Model	Part No.	No. Description	Purchasing Unit
	0406062	040-003254-00	Disposable neonatal 3-lead pre-wired electrode, radio translucent, AHA, 60 cm	50 pouch/box (3 pcs/pouch)



SpO₂ Accessories

Mindray SpO₂ Accessories



Integrated SpO₂ Cable

For BeneVision, ePM, uMEC, VS series monitors, BeneHeart defibrillator

Picture	Model	Part No.	No. Description	Purchasing Unit
	512FLH	115-012807-00	Integrative reusable SpO ₂ sensor, Adult, Finger, >30 kg, 3 m	Each
	518BLH	115-020887-00	Integrative reusable SpO ₂ sensor, Neo, Foot (adult/pediatric, finger), <5 kg, 3 m	Each



Mindray SpO₂ Cable

For BeneVision, ePM, uMEC, VS series monitors, BeneHeart defibrillator

- Ergonomic design, precise engineering and clinical testing guaranteeing reliable measurement
- Well anti-electromagnetic interference, suitable for complex electrical environment
- Flexible and durable cables
- Outstanding cable jacket, enduring repeated cleaning and disinfection
- Easy to change sensor, meeting clinical requirements for patient use
- Latex free

Picture	Model	Part No.	No. Description	Purchasing Unit
	562A	0010-20-42710 (009-004600-00)	Mindray SpO ₂ extension cable, 7 Pin, 2.5 m	Each
	562B	040-001443-00	Mindray SpO ₂ extension cable, 7 Pin, 1.2 m	Each

For Telemetry



Picture	Model	Part No.	No. Description	Purchasing Unit
	SAT 10	115-029488-00	Mindray SpO ₂ module for BeneVision TM80, 6 Pin, 0.5 m	Each
		125-000058-00	Masimo SpO ₂ module for BeneVision TM80 and TMS 40	Each

Mindray SpO₂ Sensor

Finger-Clip Sensor (Reusable)

- Ergonomic design, precise engineering and clinical testing guaranteeing reliable measurement
- High quality photoelectric element, ensuring precise measurement
- Well anti-electromagnetic interference, suitable for complex electrical environment
- Perfect performance against light interference, can be used in environment of strong light
- ESU-proof, ensuring SpO₂ signals not interfered during operation
- Strict electric safety specification, guaranteeing safety for use
- Few pit structure, not easily staining, convenient for cleaning
- Outstanding cable jacket, enduring repeated cleaning and disinfection
- Latex free
- Good biocompatibility, avoiding allergic reactions to patient

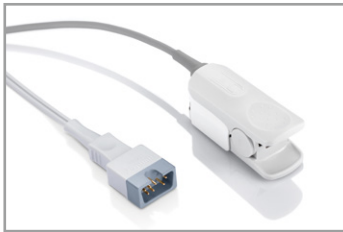
For all Mindray SpO₂ Cables and PM-50/60 pulse oximeter

Picture	Model	Part No.	No. Description	Purchasing Unit
	512F	512F-30-28263	Reusable sensor, adult, finger-clip, 1.1 m, >30 kg	Each
	512H	512H-30-79061	Reusable sensor, pediatric, finger-clip, 1.1 m, 10-30 kg	Each

Finger-Tip Sensor (Reusable)

- Ergonomic design, precise engineering and clinical testing guaranteeing reliable measurement
- High quality photoelectric element, ensuring precise measurement
- Well anti-electromagnetic interference, suitable for complex electrical environment
- Perfect performance against light interference, can be used in environment of strong light
- ESU-proof, ensuring SpO₂ signals not interfered during operation
- Strict electric safety specification, guaranteeing safety for use
- Silicone rubber sheath, not likely to break in case of drop, hardly sensor off
- Few pit structure, not likely staining, convenient for cleaning
- Outstanding cable jacket, enduring repeated cleaning and disinfection
- Latex free
- Good biocompatibility, avoiding allergic reactions to patient

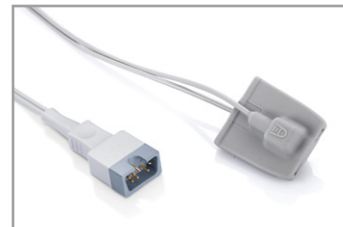

For all Mindray SpO₂ Cables and PM-50/60 pulse oximeter



Picture	Model	Part No.	No. Description	Purchasing Unit
	512E	512E-30-90390	Reusable sensor, adult, finger-tip, 1.1 m, >30 kg	Each
	512G	512G-30-90607	Reusable sensor, pediatric, finger-tip, 1.2 m, 10-30 kg	Each

Bandage Sensor (Reusable)

- Ergonomic design, precise engineering and clinical testing guaranteeing reliable measurement
- High quality photoelectric element, ensuring precise measurement
- Well anti-electromagnetic interference, suitable for complex electrical environment
- ESU-proof, ensuring SpO₂ signals not interfered during operation
- Strict electric safety specification, guaranteeing safety for use
- Compact and lightweight, single buckle design, easy to handle, not likely to loose
- Silicone rubber bandage (518BLH), no sharp edges, no hazard to hurt the neonates, no breakage from drop
- Foam bandage (518C), comfortable, permeable to air
- Few pit structure, not likely staining, convenient for cleaning
- Outstanding cable jacket, enduring repeated cleaning and disinfection
- Latex free
- Good biocompatibility, avoiding allergic reactions to patient

For all Mindray SpO₂ Cables and PM-50/60 pulse oximeter

Picture	Model	Part No.	No. Description	Purchasing Unit
	518B	518B-30-72107	Reusable sensor, Neo, Foot (adult/pediatric, finger), 1.2 m, <5 kg	Each
	518C	040-000407-00	Reusable sensor, with foam wrap replacement, Neo, Foot, 1.2 m, <5 kg	Each

Picture	Model	Part No.	No. Description	Purchasing Unit
	518C	115-004895-00	Disposable wrap for 518C sensor, <5 kg	12 pcs/pouch
	518BLH	115-050154-00	Reusable sensor, Neo, Foot toe, <5kg, 1.2m	Each

Ear Sensor (Reusable)

- Suitable for SpO₂ monitoring for the case sensor cannot be applied to fingers or toes
- Ergonomic design, comfortable to use
- Well anti-electromagnetic interference, suitable for complex electrical environment
- Outstanding cable jacket, enduring repeated cleaning and disinfection
- Latex free
- Good biocompatibility, avoiding allergic reactions to patient

For all Mindray SpO₂ Cables and PM-50/60 pulse oximeter



Picture	Model	Part No.	No. Description	Purchasing Unit
	513A	115-034527-00	Reusable SpO ₂ sensor, adu/ped, ear-clip, 1.6 m, >30 kg	Each

Non-Adhesive Sensor (Disposable)

- Ergonomic design, precise engineering and clinical testing guaranteeing reliable measurement
- High quality photoelectric element, ensuring precise measurement
- Well anti-electromagnetic interference, suitable for complex electrical environment
- ESU-proof, ensuring SpO₂ signals not interfered during operation
- Strict electric safety specification, guaranteeing safety for use
- Velcro® bandage, convenient for changing application site
- Latex free
- Good biocompatibility, avoiding allergic reactions to patient

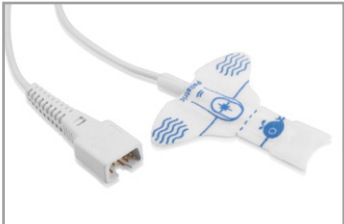
For all Mindray SpO₂ Cables and PM-50/60 pulse oximeter



Picture	Model	Part No.	No. Description	Purchasing Unit
	520A	009-005087-00	520A disposable SpO ₂ sensor, nonadhesive, Adu, >30 kg, 0.5 m	20 pcs/box
	520P	009-005088-00	520P disposable SpO ₂ sensor, nonadhesive, Ped, 10 to 50 kg, 0.5 m	20 pcs/box

Picture	Model	Part No.	No. Description	Purchasing Unit
	520I	009-005089-00	520I disposable SpO ₂ sensor, non-adhesive, Inf, 3 to 20 kg, 1m	20 pcs/box
	520N	009-005090-00	520N disposable SpO ₂ sensor, non-adhesive, Adult (>30 kg) / Neo(<3 kg), 1m	20 pcs/box

Adhesive Sensor (Disposable)

- Ergonomic design, precise engineering and clinical testing guaranteeing reliable measurement
- High quality photoelectric element, ensuring precise measurement
- Well anti-electromagnetic interference, suitable for complex electrical environment
- ESU-proof, ensuring SpO₂ signals not interfered during operation
- Strict electric safety specification, guaranteeing safety for use
- Medical adhesive tape , great performance for fixation
- Latex free
- Good biocompatibility, avoiding allergic reactions to patient

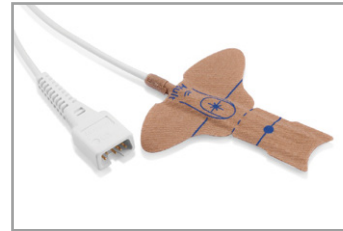
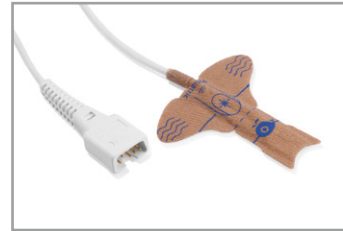
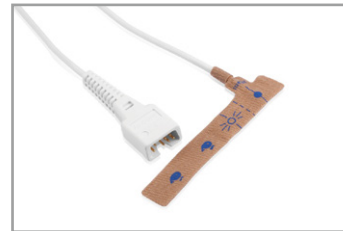
For all Mindray SpO₂ Cables and PM-50/60 pulse oximeter

Picture	Model	Part No.	No. Description	Purchasing Unit
	521A	009-005091-00	521A disposable SpO ₂ sensor, adhesive, Adu, >30 kg, 0.5 m	20 pcs/box
	521P	009-005092-00	521P disposable SpO ₂ sensor, adhesive, Ped, 10 to 50 kg, 0.5 m	20 pcs/box
	521I	009-005093-00	521I disposable SpO ₂ sensor, adhesive, Inf, 3 to 20 kg, 1m	20 pcs/box
	521N	009-005094-00	521N disposable SpO ₂ sensor, adhesive, Adult (>30 kg) /Neo(<3 kg), 1m	20 pcs/box

Nellcor SpO₂ Accessories (COVIDIEN)

Nellcor SpO₂ Cables

- Ergonomic design, precise engineering and clinical testing guaranteeing reliable measurement
- Well anti-electromagnetic interference, suitable for complex electrical environment
- Flexible and durable cables
- Outstanding cable jacket, enduring repeated cleaning and disinfection
- Easy to change sensor, meeting clinical requirements for patient use
- Latex free





For BeneVision, ePM, VS series monitors, BeneHeart defibrillator

Picture	Model	Part No.	No. Description	Purchasing Unit
	572A	0010-20-42712	Nellcor SpO ₂ extension cable, 8 Pin, 2.5 m	Each

Reusable Nellcor SpO₂ Sensors

- Ergonomic design, precise engineering and clinical testing guaranteeing reliable measurement
- Well anti-electromagnetic interference, suitable for complex electrical environment
- Strict electric safety specification, guaranteeing safety for use
- Outstanding cable jacket, enduring repeated cleaning and disinfection
- Latex free
- Good biocompatibility, avoiding allergic reactions to patient



For all the Nellcor Cables (0010-20-42712)

Picture	Model	Part No.	No. Description	Purchasing Unit
	DS100A	9000-10-05161	Nellcor reusable sensor, adult, 1m, >40 kg	Each
	OXI-P/I	9000-10-07308	Nellcor reusable sensor, pediatric/Inf, 1m, 3-40 kg	Each
	OXI-A/N	9000-10-07336	Nellcor reusable sensor, adult/Neo, 1m, 1-<3 kg or >40 kg	Each
	D-YS	0010-10-12476	Nellcor multisite sensor, adult/pediatric /Inf/Neo, 1m, 1-3 kg or >40 kg (A/N), 3-40 kg (P/I)	Each

Nellcor SpO₂ Sensor (Disposable)



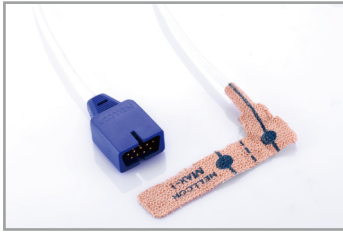
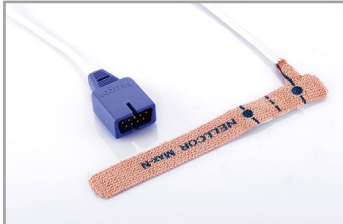

- Ergonomic design, precise engineering and clinical testing guaranteeing reliable measurement
- Well anti-electromagnetic interference, suitable for complex electrical environment
- Strict electric safety specification, guaranteeing safety for use
- Various sensors meeting requirements of different patients
- Latex free
- Good biocompatibility, avoiding allergic reactions to patient

For all the Nellcor Cables (0010-20-42712)

Picture	Model	Part No.	No. Description	Purchasing Unit
	MAX AI	0010-10-12202	Nellcor disposable sensor, adult, >30 kg, 0.5 m	24 pcs/box
	MAX PI	0010-10-12203	Nellcor disposable sensor, pediatric, 10 to 50 kg, 0.5 m	24 pcs/box
	MAX II	0010-10-12204	Nellcor disposable sensor, Inf, 3 to 20 kg, 0.5 m	24 pcs/box
	MAX N1	0010-10-12205	Nellcor disposable sensor, adult/Neo, >40 kg or <3 kg, 0.5 m	24 pcs/box

Masimo

For BeneVision, ePM, VS series monitors, BeneHeart defibrillator

Picture	Model	Part No.	No. Description	Purchasing Unit
	582A	040-000332-00	Masimo SpO ₂ extension cable, 8 Pin, purple connector	Each
	583A	040-005973-00	Masimo Cable (RD SET), 8 Pin, purple connector	Each
	LNCS DC-I		Masimo LNCS DC-I Adult SpO ₂ Reusable sensor (Please contact with Masimo's local distributor)	Each
	RD DCI		Masimo RD DCI Adult SpO ₂ Reusable sensor (Please contact with Masimo's local distributor)	Each





Non-invasive Blood Pressure Accessories



Non-invasive Blood Pressure Tubing

- Not deform even if for long-term use
- Reasonable hardness avoids severe bending, ensures the safety of deflation
- Reasonable hardness ensures well transmission of blood pressure signal
- TPU ensures good air tightness and long life
- Latex free, PVC free
- Good biocompatibility, free from biological hazard to skin

For BeneVision, ePM, uMEC, VS series monitors, BeneHeart defibrillator

Picture	Model	Part No.	No. Description	Purchasing Unit
	CM1903	6200-30-09688	NIBP Tubing, Adu/Ped/Inf/Neo, with air plug connectors, 3m - ISO80369	Each
	CM1903	115-012522-00	NIBP Tubing, Adu/Ped/Inf/Neo, with air plug connectors, 3m - ISO80369	Each
	CM1908	040-002712-00	NIBP Tubing, Adu/Ped/Inf/Neo, with air plug connectors, 3m - ISO80369	Each
	CM1901	6200-30-11560	NIBP Tubing, Neo, with connectors, 3 m	Each



Adapted with the tubing (6200-30-09688, 115-012522-00, 040-002712-00)



Picture	Model	Part No.	No. Description	Purchasing Unit
	CM1905	040-000688-00	NIBP Cuff Tubing Adapter (Adult tubing to Neonate cuff)	Each

CM1200 Series

- Soft and comfortable. Low hazard to skin even if a long-term use
- Easy to clean. The cuff wrap can not be damped or stained by liquid if duly cleaned
- Pilling-proof. Not deform even if for long-term use
- TPU bladder ensures good air tightness and long life
- Latex free, PVC free
- Good biocompatibility, free from biological hazard to skin

Connected with the tubing 6200-30-09688, 115-012522-00 and 040-002712-00

Picture	Model	Part No.	No. Description	Purchasing Unit
	CM1200	115-002480-00	Reusable cuff, Small Inf, 7-13cm - ISO80369	Each
	CM1201	0010-30-12157	Reusable cuff, Inf, 10-19cm, with connector - ISO80369	Each





Picture	Model	Part No.	No. Description	Purchasing Unit
	CM1202	0010-30-12158	Reusable cuff, Child, 18-26cm, with connector - ISO80369	Each
	CM1203	0010-30-12159	Reusable cuff, Adu, 25-35cm, with connector - ISO80369	Each
	CM1204	0010-30-12160	Reusable cuff, Large Adu, 33-47cm, with connector - ISO80369	Each
	CM1205	0010-30-12161	Reusable cuff, Thigh, 46-66cm, with connector - ISO80369	Each



CM1300 Series

- Easy to clean. No bladder, can be cleaned and disinfected directly
- Color-coded by size for different patient
- Avoid inaccurate measurement. No-bladder design avoids inaccurate measurements due to bladder twisting
- Pilling-proof. Not deform even if for long-term use
- Round angle design improves safety
- Easy to use. The index line for proper size and placement
- Latex free, PVC free
- Good biocompatibility

Connected with the tubing 6200-30-09688, 115-012522-00 and 040-002712-00

Picture	Model	Part No.	No. Description	Purchasing Unit
	CM1300	040-000968-00	Reusable bladderless cuff, Small Inf, 7-13cm - ISO80369	Each
	CM1301	040-000973-00	Reusable bladderless cuff, Inf, 10-19cm, with connector - ISO80369	Each



Picture	Model	Part No.	No. Description	Purchasing Unit
	CM1302	040-000978-00	Reusable bladderless cuff, Child, 18-26cm, with connector - ISO80369	Each
	CM1303	040-000983-00	Reusable bladderless cuff, Adu, 25-35cm, with connector - ISO80369	Each
	CM1304	040-000988-00	Reusable bladderless cuff, Large Adu, 33-47cm, with connector - ISO80369	Each
	CM1305	040-000993-00	Reusable bladderless cuff, Thigh, 46-66cm, with connector - ISO80369	Each

Picture	Model	Part No.	No. Description	Purchasing Unit
	CM1306	115-015930-00	Reusable bladderless cuff, Adu, long wrap, 25-35cm with connector - ISO80369	Each
	CM1307	115-015931-00	Reusable bladderless cuff, Large Adu, long wrap, 33-47cm with connector - ISO80369	Each

CM1300 Series(Neonatal)

- Soft and comfortable. Low hazard to skin even if a long-term use
- Avoid inaccurate measurement. No-bladder design avoids inaccurate measurements due to bladder twisting
- Pilling-proof. Not deform even if for long-term use
- Round angle design improves safety
- Easy to use. The index line for proper size and placement
- Latex free, PVC free
- Good biocompatibility, free from biological hazard to skin

Connected with the tubing 6200-30-11560, 040-000688-00

Picture	Model	Part No.	No. Description	Purchasing Unit
	CM1300C	115-057848-00	Bladderless cuff, Neo, reusable, 5.8-10.9 cm, with connector	Each
	CM1300D	115-057849-00	Bladderless cuff, Neo, reusable, 7.1-13.1 cm, with connector	Each
	CM1300E	115-057850-00	Bladderless cuff, Neo, reusable, 8-15 cm, with connector	Each

Non-invasive Blood Pressure Cuff (Single Use)

CM1500 Series (Adult and Child)

- Soft and comfortable. Low hazard to skin even if a long-term use
- Avoid inaccurate measurement. No bladder design avoids inaccurate measurements due to bladder twisting
- For single patient only, avoiding cross infection
- Round angle design improves safety
- Easy to use. The index line for proper size and placement
- Latex free, PVC free
- Good biocompatibility, free from biological hazard to skin

Connected with the tubing 6200-30-09688, 115-012522-00 and 040-002712-00

Picture	Model	Part No.	No. Description	Purchasing Unit
	CM1501	001B-30-70697	Single-patient use cuff, Inf, 10-19cm - ISO80369	10 pcs/box
	CM1502	001B-30-70698	Single-patient use cuff, Child, 18-26cm - ISO80369	10 pcs/box
	CM1503	001B-30-70699	Single-patient use cuff, Adu, 25-35cm - ISO80369	10 pcs/box

Picture	Model	Part No.	No. Description	Purchasing Unit
	CM1504	001B-30-70700	Single-patient use cuff, Large Adu, 33-47cm - ISO80369	10 pcs/box
	CM1505	001B-30-70701	Single-patient use cuff, Thigh, 46-66cm - ISO80369	10 pcs/box
	CM1506	115-016969-00	Single-patient use cuff, Adu, long wrap, 25-35cm - ISO80369	10 pcs/box
	CM1507	115-016970-00	Single-patient use cuff, Large Adu, long wrap, 33-47cm - ISO80369	10 pcs/box

CM1500 Series (Neonatal)



- Soft and comfortable. Low hazard to skin even if a long-term use
- Easy to clean. The stain can be cleaned by wet cloth
- Avoid inaccurate measurement
- No-bladder design avoids inaccurate measurements due to bladder twisting
- For single patient only, avoiding cross infection
- Transparent design for observing the patient skin condition conveniently
- Easy to use. The index line for proper size and placement
- Latex free, PVC free
- Good biocompatibility, free from biological hazard to skin

Connected with the tubing (6200-30-11560, 040-000688-00)

Picture	Model	Part No.	No. Description	Purchasing Unit
	CM1500A	001B-30-70692	Single-patient use cuff, Neo, 3.1-5.7 cm	20 pcs/box
	CM1500B	001B-30-70693	Single-patient use cuff, Neo, 4.3-8.0 cm	20 pcs/box



Picture	Model	Part No.	No. Description	Purchasing Unit
	CM1500C	001B-30-70694	Single-patient use cuff, Neo, 5.8-10.9 cm	20 pcs/box
	CM1500D	001B-30-70695	Single-patient use cuff, Neo, 7.1-13.1 cm	20 pcs/box
	CM1500E	001B-30-70696	Single-patient use cuff, Neo, 8-15 cm	20 pcs/box

Connected with the tubing (6200-30-09688, 115-012522-00, 040-002712-00)

Picture	Model	Part No.	No. Description	Purchasing Unit
	CM1500A	125-000051-00	Single-patient use cuff, Neo, 3.1-5.7 cm - ISO80369	20 pcs/box
	CM1500B	125-000052-00	Single-patient use cuff, Neo, 4.3-8.0 cm - ISO80369	20 pcs/box
	CM1500C	125-000053-00	Single-patient use cuff, Neo, 5.8-10.9 cm - ISO80369	20 pcs/box
	CM1500D	125-000054-00	Single-patient use cuff, Neo, 7.1-13.1 cm - ISO80369	20 pcs/box

Picture	Model	Part No.	No. Description	Purchasing Unit
	CM1500E	125-000055-00	Single-patient use cuff, Neo, 8-15 cm - ISO80369	20 pcs/box

For Telemetry BP10

Picture	Model	Part No.	No. Description	Purchasing Unit
	CM1907	040-002379-00	NIBP tubing - ISO80369	Each
	CM1102	115-020374-00	Reusable cuff, Child, 18-26 cm, with connector - ISO80369	Each
	CM1103	115-020375-00	Reusable cuff, Adu, 25-35 cm, with connector - ISO80369	Each
	CM1104	115-020376-00	Reusable cuff, Large Adu, 33-47 cm, with connector - ISO80369	Each
	CM1602	115-020377-00	Single-patient cuff liner, Ped, 18-26 cm (for CM1102)	Each
	CM1603	115-020378-00	Single-patient cuff liner, Adu, 25-35 cm (for CM1103)	Each
	CM1604	115-020379-00	Single-patient cuff liner, Large Adu, 33-47 cm (for CM1104)	Each



NIBP Accessory Kit

For BeneVision, ePM, uMEC, VS series monitors, BeneHeart defibrillator



Part No.	No. Description	Purchasing Unit
0651-30-77024	Tubing + Adu cuff (25-35cm) Including: 6200-30-09688 NIBP Tubing, Adu/Ped/Inf, with connector, 3m, ISO80369, 1 pcs CM1203 Reusable cuff, Adu, 25-35cm, with connector, ISO80369, 1 pcs	Set
0651-30-77025	Tubing + Ped cuff(18-26cm) Including: 6200-30-09688 NIBP Tubing, Adu/Ped/Inf, with connector, 3m, ISO80369, 1 pcs CM1202 Reusable cuff, Ped, 18-26cm, with connector, ISO80369, 1 pcs	Set
0651-30-77026	Tubing + Neo disposable cuff (5.8-10.9 cm) Including: 6200-30-11560 NIBP Tubing, Neo, with connectors, 3 m, 1 pcs CM1500C (001B-30-70679) Disposable cuff, Neo, 5.8-10.9 cm, with connector 1 pcs	Set
115-076325-00	Tubing + Neo single-patient use cuffs(3.1-15cm) Including: 6200-30-09688 NIBP Tubing, Adu/Ped/Inf, with connector, 3m, ISO80369, 1 pcs CM1500A-CM1500E, Single-patient use cuff, Neo, ISO80369, 1 pcs per model	Set

mWear Accessories



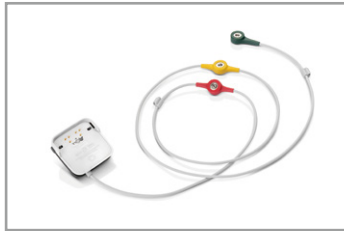

For EP 30 module

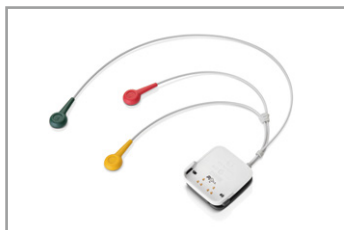
Picture	Model	Part No.	No. Description	Purchasing Unit
	512RS	125-000246-00	EP Docking_512RS SpO ₂ +Adu+Ring+FS	Each
	512HS	125-000268-00	EP Docking_512HS SpO ₂ +Ped+F-Clip+FS	Each
	512ES	125-000269-00	EP Docking_512ES SpO ₂ +Adu+F-Tip+FS	Each



For ES 30 module

Picture	Model	Part No.	No. Description	Purchasing Unit
	EA6431B	125-000270-00	ES30 Docking_AHA+3lead+Knot+Snap	Each
	EA6432B	125-000271-00	ES30 Docking_IEC+3lead+Knot+Snap	Each
	EA6433B	125-000272-00	ES30 Docking_AHA+3lead+Split+Snap	Each
	EA6434B	125-000273-00	ES30 Docking_IEC+3lead+Split+Snap	Each

For BP 20 module

Picture	Model	Part No.	No. Description	Purchasing Unit
	CM1702A	125-000624-00	Cuff with connector (Child, CM1702A, 18-26cm)	Each
	CM1703A	125-000625-00	Cuff with connector (Adult, CM1703A, 25-35cm)	Each
	CM1704A	125-000626-00	Cuff with connector (Large Adult, CM1704A, 33-47cm)	Each
	CM1707A	125-000627-00	Cuff with connector (Large Adult Long, CM1707A, 33-47cm)	Each

For mWear series

Picture	Model	Part No.	No. Description	Purchasing Unit
		115-097218-00	mWear carrying case	Each
	WT701	125-000419-00	Raiing Wireless IThermonitor (CE/40pcs)	40 pcs/box
	C25	115-092325-00	Charger	Each



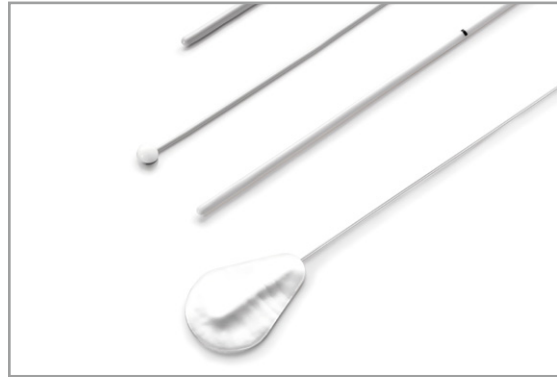

Temperature Accessories



Reusable Temperature Probes

- Available in Rectal/Esophageal and Skin Surface Styles
- Flexible and durable cables
- Outstanding cable material, enduring repeated cleaning and disinfection
- Latex free
- Good biocompatibility, avoiding allergic reactions to patient

For BeneVision, ePM, uMEC, series monitors, BeneHeart defibrillator

Picture	Model	Part No.	No. Description	Purchasing Unit
	MR401B	0011-30-37392	Reusable Temp Probe, Adu, Esophageal/Rectal, 2 Pin, 3 m	Each
	MR402B	0011-30-37394	Reusable Temp Probe, Ped/Neo, Esophageal/Rectal, 2 Pin, 3 m	Each
	MR403B	0011-30-37393	Reusable Temp Probe, Adu, Skin, 2 Pin, 3.6 m	Each
	MR404B	0011-30-37395	Reusable Temp Probe, Ped/Neo, Skin, 2 Pin, 3.6 m	Each

Temperature cables

- Extension cables are connected with the disposable temperature probes
- Flexible and durable cables
- Outstanding cable material, enduring repeated cleaning and disinfection
- Latex free



For BeneVision, ePM, uMEC, series monitors, BeneHeart defibrillator

Picture	Model	Part No.	No. Description	Purchasing Unit
	MR420B	040-001235-00	Extension Cable for Disposable Probes, 2 Pin, 3 m, Rectangle Connector (Molex)	Each

Disposable Temperature Probes

- Available in Rectal/Esophageal and Skin Surface Styles
- A scale line is set every 10cm for easy identification of the insertion depth for disposable esophageal/rectal probe
- Specially designed thermal insulation foam and polyester reflective film to reduce ambient temperature interference and ensure measurement accuracy for disposable skin surface probe
- Latex free
- Good biocompatibility, avoiding allergic reactions to patient



Match with the extension cables 040-001235-00



Picture	Model	Part No.	No. Description	Purchasing Unit
	MR411	040-003294-00	Disposable general purpose temperature probe, 9Fr, Molex connector, 0.76 m	20 pcs/box
	MR412	040-003295-00	Disposable temperature probe, skin surface, Molex connector, 0.76 m	20 pcs/box

SmarTemp Accessories

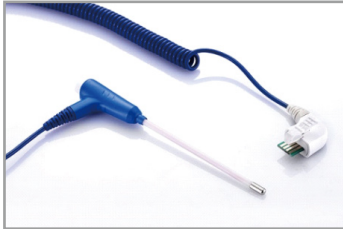
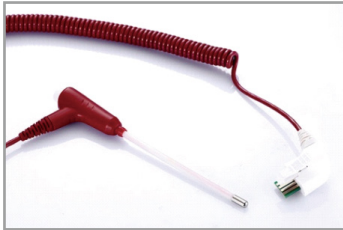
- Available in oral/axillary and rectal styles
- The probe cover is disposable, avoiding cross-infection
- Flexible and durable cables
- Outstanding cable material, enduring repeated cleaning and disinfection
- Latex free
- Good biocompatibility, avoiding allergic reactions to patient





For VS series monitors

Picture	Model	Part No.	No. Description	Purchasing Unit
	MR431	6006-30-39598	Oral/Axillary probe, 0.4~4 m	Each
	MR432	6006-30-39599	Rectal probe, 0.4~4 m	Each
	MR491	M09A-20-62062	Blue sheath for Oral/Auxiliary probe	Each

Picture	Model	Part No.	No. Description	Purchasing Unit
	MR492	M09A-20-62062-51	Red sheath for Rectal probe	Each
	ST-001	M09A-20-62124	Probe covers	20 pcs/box
	MR431	6006-30-39590	Oral/Auxiliary probe kit for SmarTemp (with blue sheath, and 20 pcs probe covers)	Set
	MR432	6006-30-39591	Rectal probe kit for SmarTemp (with red sheath, and 20 pcs probe covers)	Set

TrueTemp Accessories

For VS series monitors

Picture	Model	Part No.	No. Description	Purchasing Unit
	MR441	125-000422-00	MR TrueTemp probe, Oral/Axillary	Each
	MR442	125-000423-00	MR TrueTemp probe, Rectal	Each
	MR493	125-000157-00	MR TrueTemp Blue sheath for Oral/Auxiliary probe	Each
	MR494	125-000158-00	MR TrueTemp Red sheath for Rectal probe	Each

Picture	Model	Part No.	No. Description	Purchasing Unit
		040-006506-00	MR TrueTemp probe cover	10 boxes/carton (20 pcs/box)



TrueTemp Accessory Kit

For VS series monitors

Part No.	No. Description	Purchasing Unit
115-090780-00	MR TrueTemp probe kit, Oral/Axillary Including: MR TrueTemp probe, Oral/Axillary, 1 pcs MR TrueTemp Blue sheath for Oral/Auxiliary probe, 1 pcs MR TrueTemp probe cover, 20 pcs/box	Set
115-090781-00	MR TrueTemp probe kit, Rectal Including: MR TrueTemp probe, Rectal, 1 pcs MR TrueTemp Red sheath for Rectal probe, 1 pcs MR TrueTemp probe cover, 20 pcs/box	Set



Thermometer Accessories - TrueTymp

For VS series monitors

Picture	Model	Part No.	No. Description	Purchasing Unit
		120-023000-00	MR TrueTymp ear thermometer kit with link (CE) with 20 pcs probe covers	Set
		009-016268-00	Mindray ear thermometer switch harness (Exergen/Genius Dock connect TureTymp)	Each



For BeneVision, ePM, VS series monitors, BeneHeart DX/D60

Picture	Model	Part No.	No. Description	Purchasing Unit
	ET-001	040-006890-00	MR TrueTymp ear thermometer cover	200pcs/box

Picture	Model	Part No.	No. Description	Purchasing Unit
		040-007149-00	MR TrueTymp thermometer security tether	Each
		120-025788-00	MR TrueTymp ear thermometer gift box, no charger, CE, with 20pcs probe covers	Set
		120-023164-00	MR TrueTymp thermometer kit independent (EUR) with 20pcs probe covers	Set
		120-023001-00	MR TrueTymp thermometer kit independent (GBR) with 20pcs probe covers	Set
		120-023166-00	MR TrueTymp thermometer kit independent (AUS) with 20pcs probe covers	Set
		120-023162-00	MR TrueTymp thermometer kit independent (USA) with 20pcs probe covers	Set

Thermometer Accessories-Exergen

For VS series monitors

Picture	Model	Part No.	No. Description	Purchasing Unit
		115-050159-00	Exergen TemporalScanner thermometer package(including cradle)	Each
		115-050157-00	Exergen TemporalScanner thermometer	Each
		009-016657-00	Thermometer adapter wire (TureTymp Dock connect Exergen)	Each



CO₂ Accessories







Side-stream CO₂ Accessories (Mindray)



- Sampling line for intubated patients, Nasal sample cannula for non-intubated patients
- Sampling lines are disposable
- Water trap can be reused (Should be replaced every month)
- Latex free
- Good biocompatibility

For BeneVision, ePM, uMEC series monitors, BeneHeart defibrillator

Picture	Model	Part No.	No. Description	Purchasing Unit
	100-000080-00	115-043024-00	M02C DRYLINE II water trap Adu/Ped for single-slot module	10 pcs/box
	100-000081-00	115-043025-00	M02C DRYLINE II water trap Neo for single-slot module	10 pcs/box

For BeneVision, ePM, uMEC series monitors, BeneHeart defibrillator

Picture	Model	Part No.	No. Description	Purchasing Unit
	60-15200-00	115-043017-00 (9200-10-10533)	Sampling line, Adu/Ped, 2.5 m	25 pcs/box
	60-15300-00	115-043018-00 (9200-10-10555)	Sampling line, Neo, 2.5 m	25 pcs/box
	60-14100-00	115-043020-00 (9000-10-07486)	Dryline airway adapter, straight	10 pcs/box
	60-14200-00	115-043021-00 (9000-10-07487)	Dryline airway adapter, elbow	10 pcs/box

Picture	Model	Part No.	No. Description	Purchasing Unit
	040-001187-00	115-043019-00 (040-001187-00)	Dryline airway adapter, straight, neonate	10 pcs/box
	4000	115-043001-00 (M02A-10-25937)	CO ₂ Nasal sample cannula, Adu, 2.1 m	25 pcs/box
	4100	115-043002-00 (M02A-10-25938)	CO ₂ Nasal sample cannula, Pad, 2.1 m	25 pcs/box
	4200	115-043003-00 (M02B-10-64509)	CO ₂ Nasal sample cannula, Inf, 2.1 m	25 pcs/box

Side-stream CO₂ Accessory Kit







For BeneVision, ePM, uMEC series monitors, BeneHeart defibrillator



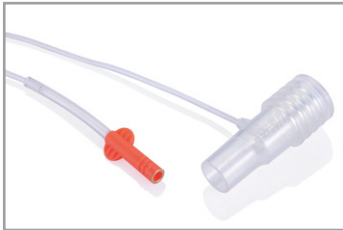

Part No.	No. Description	Purchasing Unit
115-021054-00	M02C Sidestream CO ₂ kit, Adu/Ped Including: M02C DRYLINE II water trap Adu/Ped, 2 pcs 4000 CO ₂ Nasal sample cannula, Adu, 2 pcs 4100 CO ₂ Nasal sample cannula, Ped, 2 pcs 60-15200-00 Sampling line, Adu, 2 pcs 60-14100-00 Dryline air way adapter, straight, 2 pcs	Set
115-021055-00	M02C Sidestream CO ₂ kit, Neo Including: M02C DRYLINE II water trap Neo, 2 pcs 4200 CO ₂ Nasal sample cannula, Inf, 2 pcs 60-15300-00 Sampling line, Neo, 2 pcs 040-001187-00 Dryline air way adapter, straight, 2 pcs	Set

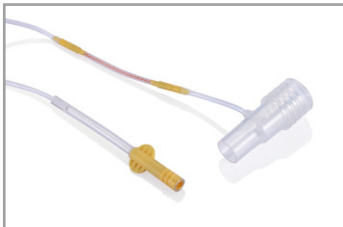



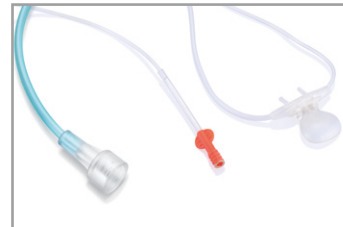

Micro-stream CO₂ Accessories (Oridion)

- For intubated or non-intubated patients
- Sampling lines are disposable
- Easy to use, without water trap
- Latex free
- Good biocompatibility

For BeneVision, ePM, VS 9, VS-900, uMEC series monitors, BeneHeart defibrillator

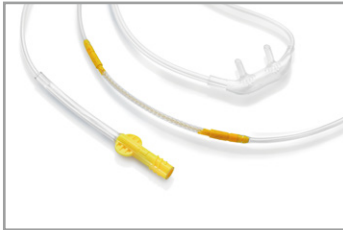
Picture	Model	Part No.	No. Description	Purchasing Unit
	MVAI	0010-10-42560	Adult-Pediatric Intubated CO ₂ Filter Line, Short-term use, 2 m	Each
	MVAIL	0010-10-42563	Adult-Pediatric Intubated CO ₂ Filter Line, Short-term use, 4 m	Each
	MVAN	0010-10-42577	Adult Nasal CO ₂ Filter Line, Short-term use, 2 m	Each
	MVPN	0010-10-42578	Pediatric Nasal CO ₂ Filter Line, Short-term use, 2 m	Each
	MVAIH	0010-10-42561	Adult-Pediatric Intubated CO ₂ Filter Line, Extended Duration, 2 m	Each
	MVAIHL	0010-10-42564	Adult-Pediatric Intubated CO ₂ Filter Line, Extended Duration, 4 m	Each

Picture	Model	Part No.	No. Description	Purchasing Unit
	MVIH	0010-10-42562	Neonatal-Infant Intubated CO ₂ Filter Line, Extended Duration, 2 m	Each
	MVIHL	0010-10-42565	Neonatal-Infant Intubated CO ₂ Filter Line, Extended Duration, 4 m	Each
	MVA	0010-10-42566	Adult Oral-Nasal CO ₂ Filter Line with O ₂ connector, Short-term use, 2 m	Each
	MVP	0010-10-42567	Pediatric Oral-Nasal CO ₂ Filter Line, Short-term use, 2 m	Each
	MVAO	0010-10-42568	Adult Oral-Nasal CO ₂ Filter Line with O ₂ Tubing, Short-term use, 2 m	Each
	MVAOL	0010-10-42570	Adult Oral-Nasal CO ₂ Filter Line with O ₂ Tubing, Short-term use, 4 m	Each

Picture	Model	Part No.	No. Description	Purchasing Unit
	MVPO	0010-10-42569	Pediatric Oral-Nasal CO ₂ Filter Line with O ₂ Tubing, Short-term use, 2 m	Each
	MVPOL	0010-10-42571	Pediatric Oral-Nasal CO ₂ Filter Line with O ₂ Tubing, Short-term use, 4 m	Each
	MVANH	0010-10-42572	Adult Nasal CO ₂ Filter Line, Extended Duration, 2 m	Each
	MVINH	0010-10-42574	Neonatal-Infant Nasal CO ₂ Filter Line, Extended Duration, 2 m	Each
	MVANOH	0010-10-42575	Adult Nasal CO ₂ Filter Line with O ₂ Tubing, Each Extended Duration, 2 m	Each
	MVPNOH	0010-10-42576	Pediatric Nasal CO ₂ Filter Line with O ₂ Tubing, Extended Duration, 2 m	Each

For BeneVision N1,VS 9, VS-900, BeneHeart D3/D30/D60/DX

Picture	Model	Part No.	No. Description	Purchasing Unit
	GA3501	045-003134-00	CO ₂ adapter (reusable)	Each

Micro-stream CO₂ Accessory Kit

For BeneVision, ePM, uMEC series monitors, BeneHeart defibrillator

Part No.	No. Description	Purchasing Unit
040-000027-00	Microstream CO ₂ kit, Ped Including: MVAI Adult-Pediatric Intubated CO ₂ Filter Line, Short-term use, 2 m, 1 pcs MVPN Pediatric Nasal CO ₂ Filter Line, Short-term use, 2 m, 1 pcs	Set
040-000026-00	Microstream CO ₂ kit, Neo Including: MVIH Neonatal-Infant Intubated CO ₂ Filter Line, Extended Duration, 2 m, 1 pcs MVINH Neonatal-Infant Nasal CO ₂ Filter Line, Extended Duration, 2 m, 1 pcs	Set
6800-30-50619	Microstream CO ₂ kit, Adu Including: MVAI Adult-Pediatric Intubated CO ₂ Filter Line, Short - term use, 2 m, 1 pcs MVAN Adult Nasal CO ₂ Filter Line, Short-term use, 2 m, 1 pcs	Set



For VS-900, VS 9



Part No.	No. Description	Purchasing Unit
115-039622-00	Sidestream CO ₂ accessories kit, Adu nasal Including: CO ₂ adapter, 1 pcs MVAN Adult Nasal CO ₂ Filter Line, Short-term use, 2 m, 1 pcs	Set
115-039825-00	Sidestream CO ₂ accessories kit, Ped nasal Including: CO ₂ adapter, 1 pcs MVPN Pediatric Nasal CO ₂ Filter Line, Short-term use, 2 m, 1 pcs	Set
115-039623-00	Sidestream CO ₂ accessories kit, Neo nasal Including: CO ₂ adapter, 1 pcs MVINH Neonatal-Infant Nasal CO ₂ Filter Line, Extended Duration, 2 m, 1 pcs	Set

Main-stream CO₂ Accessories (Capnostat)

- Designed for intubated patients. Non-intubated patient need to wear mask to use mainstream CO₂ module
- Short response time
- Adapter and mask are disposable
- Latex free
- Good biocompatibility

For BeneVision, ePM series monitors

Picture	Model	Part No.	No. Description	Purchasing Unit
	1036698	6800-30-50760	Capnostat CO ₂ sensor (Cable: 2.4 m)	Each
	6063	0010-10-42662	Single-Patient Use Air way Adapter, Adu/Ped	Each
	6312	0010-10-42664	Single-Patient Use Air way Adapter, Neo	Each

Picture	Model	Part No.	No. Description	Purchasing Unit
	6412	0010-10-42663	Single-Patient Use Air way Adapter, Adu/Ped, with mouthpiece	Each
		0010-10-42665	Reusable airway adapter, Adu/Ped	Each
		0010-10-42666	Neonatal reusable airway adapter (Respironics)	Each

Main-stream CO₂ Accessory Kit (Capnostat)



For BeneVision, ePM series monitors



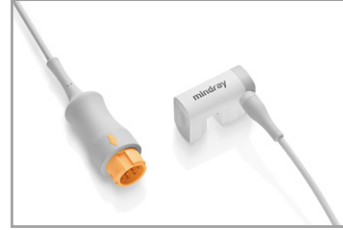

Part No.	No. Description	Purchasing Unit
6800-30-50613	Mainstream CO ₂ kit, Adu/Ped/Neo Including: Capnostat CO ₂ sensor, 1 pcs 6063 Single-Patient Use Airway Adapter, Adu/Ped, 1 pcs 6312 Single-Patient Use Airway Adapter, Neo, 1 pcs	Set

Main-stream CO₂ Accessories (Mindray)

- Designed for intubated patients.
- Short response time
- Reusable & disposable adapter
- Latex free
- Good biocompatibility

For BeneVision, ePM, new uMEC series monitors

Picture	Model	Part No.	No. Description	Purchasing Unit
	GA3701	125-000278-00	MR Main-stream CO ₂ sensor, 2.6m	Each
	GA3211	040-006830-00	MR Reusable Main-stream CO ₂ airway adapter, Adu/Ped	Each
	GA3212	040-006831-00	MR Reusable Main-stream CO ₂ airway adapter, Neo	Each

Picture	Model	Part No.	No. Description	Purchasing Unit
	GA3201	125-000280-00	MR Disposable Main-stream CO ₂ airway adapter, Adu/Ped	10pcs/box
	GA3202	125-000281-00	MR Disposable Main-stream CO ₂ airway adapter, Neo	10pcs/box
	GA3801	040-006897-00	MR Main-stream CO ₂ sensor cable holding clip, φ22mm	5pcs/pouch
	GA3802	040-006898-00	MR Main-stream CO ₂ sensor cable holding clip, φ10mm	5pcs/pouch

Main-stream CO₂ Accessory Kit (Mindray)

For BeneVision, ePM, new uMEC series monitors



Part No.	No. Description	Purchasing Unit
115-091760-00	Mindray Mainstream CO ₂ kit, Adu/Ped/Neo Including: Mindray Mainstream CO ₂ sensor (with 2.6m cable), 1 pcs Mindray Mainstream CO ₂ sensor cable holding clips, φ22mm, 5 pcs Mindray Mainstream CO ₂ sensor cable holding clips, φ10mm, 5 pcs Mindray Mainstream CO ₂ disposable airway adapter, Adu, 1 pcs Mindray Mainstream CO ₂ disposable airway adapter, Neo, 1 pcs	Set

Anesthesia Gas Accessories







- Only for intubated patients
- Sampling lines are disposable
- Water trap can be reused (Should be replaced every month)
- Latex free
- Good biocompatibility

For BeneVision, ePM series monitors

Picture	Model	Part No.	No. Description	Purchasing Unit
	100-000080-00	115-043024-00	M02C DRYLINE II water trap Adu/Ped for single-slot module	10 pcs/box
	100-000081-00	115-043025-00	M02C DRYLINE II water trap Neo for single-slot module	10 pcs/box

For BeneVision, ePM series monitors

Picture	Model	Part No.	No. Description	Purchasing Unit
	60-15200-00	115-043017-00 (9200-10-10533)	Sampling line, Adu/Ped, 2.5 m	25 pcs/box
	60-15300-00	115-043018-00 (9200-10-10555)	Sampling line, Neo, 2.5 m	25 pcs/box
	60-14100-00	115-043020-00 (9000-10-07486)	Dryline airway adapter, straight	10 pcs/box
	60-14200-00	115-043021-00 (9000-10-07487)	Dryline airway adapter, elbow	10 pcs/box

Picture	Model	Part No.	No. Description	Purchasing Unit
	040-001187-00	115-043019-00 (040-001187-00)	Dryline airway adapter, straight, neonate	10 pcs/box

Anesthesia Gas Accessory Kit

For BeneVision, ePM series monitors

Part No.	No. Description	Purchasing Unit
115-042994-00	Dual-slot Multi-Gas accessory kit (Adu/Ped/Neo) Including: DRYLINE II watertrap, Adu/Ped, 5 pcs DRYLINE II watertrap, Neo, 5 pcs DRYLINE airway adapter, straight, 2 pcs DRYLINE airway adapter, elbow, 2 pcs DRYLINE airway adapter, Neo, 2 pcs Sampling line, Adu/Ped, 2.5 m (P/N:60-15200-00), 4 pcs Sampling line, Neo, 2.5 m (P/N: 60-15300-00), 4 pcs	Set



Invasive Blood Pressure (IBP) Accessories

Invasive Blood Pressure Cables

- Compatible solution with major monitor IBP module interface and disposable pressure transducer brands in the market
- Flexible and durable cables
- Outstanding cable material, enduring repeated cleaning and disinfection
- Latex free

For BeneVision, ePM, uMEC series monitors, BeneHeart defibrillator



Picture	Model	Part No.	No. Description	Purchasing Unit
	IM2201	001C-30-70759	12 Pin IBP Cable (for ICU Medical), 4 m	Each
	IM2202	001C-30-70757	12 Pin IBP Cable (for BD), 4 m	Each
	IM2207	0010-21-43082	12 Pin IBP Cable (for Memscap, SP844 82031 transducer), 4 m	Each

Picture	Model	Part No.	No. Description	Purchasing Unit
	IM2211	0010-21-12179	12 Pin IBP Cable (for Edwards), 4 m	Each
	IM2206	115-017849-00	12 Pin IBP cable (for Utah), 4 m	Each

Y-type IBP cable: For BeneView, iPM series patient monitor, BeneHeart DX

Picture	Model	Part No.	No. Description	Purchasing Unit
	IM2204	040-001029-00	Y-type IBP cable (switch one connector to two connectors)	Each

Bracket and Mounting Clamp

Picture	Model	Part No.	No. Description	Purchasing Unit
	42602	M90-000133---	Steady rest for IBP transducer (ICU Medical)	Each
	42394	M90-000134---	Mounting clamp for IBP transducer (ICU Medical)	Each
	682275	0010-10-12156	Mounting background and accessory for IBP transducer (BD)	Each

Connected with Abbott (ICU Medical) Cables (001C-30-70759, 001C-30-70760)

Picture	Model	Part No.	No. Description	Purchasing Unit
	42584	0010-10-42638	Disposable transducer (ICU Medical)	1 pc/box

Connected with BD cables (001C-30-70757, 001C-30-70758)

Picture	Model	Part No.	No. Description	Purchasing Unit
	DT-4812	6000-10-02107	Disposable transducer (BD)	5 pcs/box

Invasive Blood Pressure Accessory Kit



For BeneVision, ePM, uMEC series monitors, BeneHeart defibrillator





Part No.	No. Description	Purchasing Unit
6800-30-50876	IBP accessory kit (ICU Medical, 12 Pin) Including: IM2201 12 Pin IBP Cable (for ICU Medical), 1 pcs 42584 Disposable transducer (ICU Medical), 5 pcs M90-000133--- Steady rest for IBP transducer (ICU Medical), 1 pcs M90-000134--- Mounting clamp for IBP transducer (ICU Medical), 1 pcs	Set
6800-30-50877	IBP accessory kit (BD, 12 Pin) Including: IM2202 12 Pin IBP Cable (for BD), 1 pcs DT-4812 Disposable transducer (BD), 5 pcs 0010-10-12156 Mounting background and accessory for IBP transducer (BD), 1 pcs	Set



Respiratory Mechanics (RM) Accessories

- Precise volume, flow, and pressure data are obtained by RM module
- Respiratory mechanics monitoring is applicable to neonate

For BeneVision series monitors

Picture	Model	Part No.	No. Description	Purchasing Unit
	60-16100-00	125-000125-00	Artema RM disposable flow sensor, with CO ₂ sampling line, Adu, 2.5 m	10pcs/box
	60-16200-00	125-000126-00	Artema RM disposable flow sensor, with CO ₂ sampling line, Ped, 2.5 m	10pcs/box

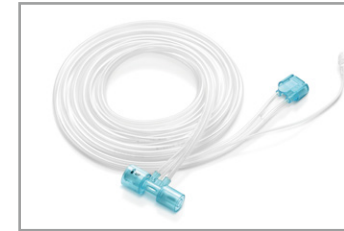
Picture	Model	Part No.	No. Description	Purchasing Unit
	MR4412	115-043038-00	Artema SPIRIT RM disposable flow sensor, 10pcs/box Adu/Ped, 1.8 m	
	040-006128-00	125-000127-00	Artema SPIRIT RM disposable flow sensor, 10pcs/box Adu/Ped, 2.5 m	
	MR4413	115-043039-00	Artema SPIRIT RM disposable flow sensor, 10pcs/box Adu/Ped, 3.3 m	
	MR4414	115-043040-00	Artema SPIRIT RM disposable flow sensor, 10pcs/box Neo, 1.8 m	
	040-006129-00	125-000128-00	Artema SPIRIT RM disposable flow sensor, 10pcs/box Neo, 2.5 m	
	MR4415	115-043041-00	Artema SPIRIT RM disposable flow sensor, 10pcs/box Neo, 3.3 m	
	RM11107	125-000334-00	Artema SPIRIT RM disposable flow sensor, 10pcs/box Adu/Ped, 1.8m (New)	
	RM11101	125-000293-00	Artema SPIRIT RM disposable flow sensor, 10pcs/box Adu/Ped, 2.5m (New)	
	RM11109	125-000336-00	Artema SPIRIT RM disposable flow sensor, 10pcs/box Adu/Ped, 3.3m (New)	
	RM11108	125-000335-00	Artema SPIRIT RM disposable flow sensor, 10pcs/box Neo, 1.8m (New)	
	RM11102	125-000294-00	Artema SPIRIT RM disposable flow sensor, 10pcs/box Neo, 2.5m (New)	
	RM11110	125-000337-00	Artema SPIRIT RM disposable flow sensor, 10pcs/box Neo, 3.3m (New)	

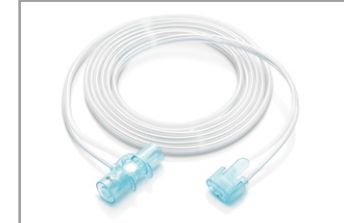
Picture	Model	Part No.	No. Description	Purchasing Unit
	RM11103	125-000295-00	Artema SPIRIT RM disposable flow sensor, 10pcs/box with CO ₂ sampling line, Adu/Ped, 2.5m	
	RM11104	125-000296-00	Artema SPIRIT RM disposable flow sensor, 10pcs/box with CO ₂ sampling line, Neo, 2.5m	
	RM11105	125-000291-00	Artema SPIRIT RM disposable flow sensor, 10pcs/box with Mindray airway adapter, Adu/Ped, 2.5m	
	RM11106	125-000292-00	Artema SPIRIT RM disposable flow sensor, 10pcs/box with Mindray airway adapter, Neo, 2.5m	

Cardiac Output Accessories

Cardiac Output Cables

- Secure connection to ensure clear transmission signal
- Outstanding cable material, enduring repeated cleaning and disinfection
- Convenient for cleaning
- Latex-free



For BeneVision, ePM, uMEC series monitors



Picture	Model	Part No.	No. Description	Purchasing Unit
	CO7702	0010-30-42743	12 Pin C.O. Cable	Each

Cardiac Output Sensors

- Secure connection to ensure clear transmission signal
- Latex-free
- Good biocompatibility, avoiding allergic reactions to patient

Connected with the C.O. cables (CO7702)

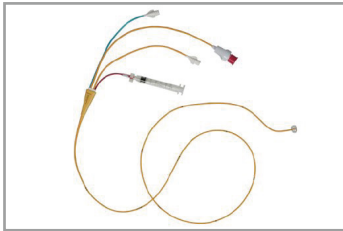
Picture	Model	Part No.	No. Description	Purchasing Unit
	SP4042	6000-10-02079	Injection liquid temperature sensor (BD)	Each
	SP5045	6000-10-02080	Injection liquid temperature sensor housing (BD)	Each
	12 ml	040-005992-00	12ml control syringe with rotator (Antmed)	Each

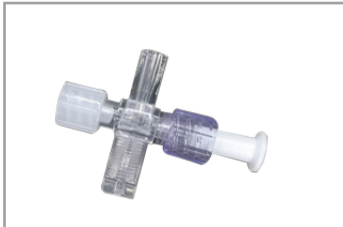
Picture	Model	Part No.	No. Description	Purchasing Unit
	131F7	6000-10-02183	Edward, Dilution hose (131F7, Edwards)	Each
		0012-00-1520	In-line inject temperature Probe (Edwards)	Each
		040-007710-00	C.O. Set + Closed Injectate System (Edwards)	Each

Cardiac Output Accessory Kit For BeneVision, ePM, uMEC series monitors

Part No.	No. Description	Purchasing Unit
115-065439-00	C.O. accessory kit Including: 12 Pin C.O. Cable, 1pc 12ml control syringe with rotator, 2pcs	Set
115-101739-00	C.O. sensor accessory kit (BD) Including: Injection liquid temperature sensor (BD P/N: SP4042), 1 pcs Injection liquid temperature sensor housing (BD P/N: SP5045), 2 pcs	Set
115-101738-00	C.O. sensor accessory kit (Edwards) Including: In-line inject temperature Probe (Edwards), 1 pcs C.O. Set + Closed Injectate System(Edwards), 2 pcs	Set



FloTrac Accessories For BeneVision series monitors

Part No.	No. Description	Purchasing Unit
120-022097-00	FloTrac Upgrade kit(w module & accessory kit) Including: FloTrac module, 1 pcs FloTrac cable, 1 pcs FloTrac sensors for adults, 5 pcs	Set

Note: to order more consumables, please contact with Edwards local distributor.

Impedance Cardiography (ICG) Accessories

For BeneVision series monitors

Picture	Model	Part No.	No. Description	Purchasing Unit
	N1301-3	100-000149-00	ICG patient cable-normal	Each
	N1201-5	100-000148-00	ICG sensor	4pcs/pouch

Impedance Cardiography (ICG) Accessory Kit



For BeneVision series monitors

Part No.	No. Description	Purchasing Unit
115-033951-00	ICG accessory kit (normal) Including: Medis ICG patient cable (N1301-3) Medis ICG electrode (N1201-5) , 4 pcs/pack x 2	Set

Bispectral Index (BIS) Accessories





Bispectral Index (BIS) Accessory Kits

For BeneVision, ePM series monitors

Picture	Part No.	No. Description
	6800-30-50878	BIS accessory kit, Adu Including: 186-0195-MR BIS module and cables 186-0106 BIS sensor, Adu, 5 pcs/pkg
	6800-30-50144	BIS accessory kit, Ped Including: 186-0195-MR BIS module and cables 186-0200 BIS sensor, Ped, 5 pcs/pkg
	115-005614-00	BISx4 accessory kit, Adu Including: 186-0224-MR BISx4 module and cables 186-0212 BISx4 bilateral sensor, Adu (5 pcs/pkg)

Encephalon State Index (ESI) Accessories

For BeneVision series monitors

Picture	Model	Part No.	No. Description	Purchasing Unit
		040-003330-00	ESI cable	Each
		040-003429-00	Ambu ECG electrode P-00-S	50 pcs/pouch
		040-003329-00	ESI trunk cable	Each
		040-003418-00	ESI Disposable Sensor, Adult	20 pcs/box

Picture	Model	Part No.	No. Description	Purchasing Unit
		040-003419-00	ESI Disposable Sensor, Ped	20 pcs/box

ESI Accessory Kit

For BeneVision series monitors



Part No.	No. Description	Purchasing Unit
115-101737-00	ESI reusable accessory kit Including: ESI cable, 1 pcs Ambu ECG electrode P-00-S, 50 pcs	Set
115-101813-00	ESI disposable accessory kit, Adult Including: ESI trunk cable, 1 pcs ESI Disposable Sensor, Adult, 5 pcs	Set
115-101814-00	ESI disposable accessory kit, Ped Including: ESI trunk cable, 1 pcs ESI Disposable Sensor, Ped, 5 pcs	Set

PiCCO₂ Accessories

PiCCO₂ Cables

- Secure connection to ensure clear transmission signal
- Outstanding cable material, enduring repeated cleaning and disinfection
- Convenient for cleaning
- Latex-free

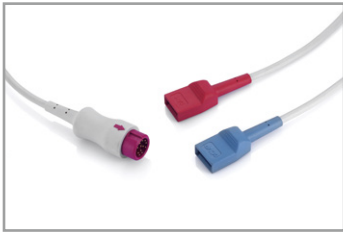
For BeneVision series monitors

Picture	Model	Part No.	No. Description	Purchasing Unit
	CO7701	040-000816-00	PiCCO ₂ 12 Pin Cable (for injecta temperature and blood temperature)	Each
	IM2203	040-000815-00	PiCCO ₂ Y-Type IBP Cable (for artery pressure and central venous pressure)	Each
	IM2212	040-002827-00	12 Pin PiCCO ₂ Y-Type IBP Cable (for artery pressure and central venous pressure) short	Each

Picture	Model	Part No.	No. Description	Purchasing Unit
	PC80105	040-000817-00	PiCCO ₂ 2 Pin Injecta Temperature Sensor Cable (Reusable)	Each

PiCCO₂ Sensors

- Secure connection to ensure clear transmission signal
- Single patient use, avoiding cross-infection
- Latex-free
- Good biocompatibility, avoiding allergic reactions to patient

Connected with CO7701 PC80105 PiCCO₂ cable



Picture	Model	Part No.	No. Description	Purchasing Unit
	PV2015L20-A	040-000921-00	PiCCO ₂ catheter adult	Each
	PV2013L07-A	040-000922-00	PiCCO ₂ catheter pediatric	Each

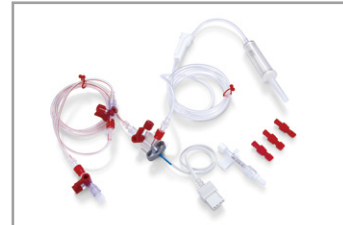



Connected with IM2203 PiCCO₂ cable

Picture	Model	Part No.	No. Description	Purchasing Unit
	PV8215	040-002899-00	PiCCO ₂ monitoring kit (Pressure transducer with Utah connector, injecta temperature sensor housing)	Set

Picture	Model	Part No.	No. Description	Purchasing Unit
	EA6251B	040-002903-00	PiCCO ₂ mounting clamp for PV8215 IBP transducer	Each

PiCCO₂ Accessory Kit
For BeneVision series monitors

Picture	Part No.	No. Description
	115-040654-00	PiCCO ₂ Accessory kit, Adult, Utah Including: IM2203 12 Pin IBP Y Cable CO7701 12 Pin PiCCO ₂ Cable PC80105 2 Pin Injecta Temperature Sensor Cable PV8215 PiCCO ₂ Monitoring Kit PV2015L20-A PiCCO ₂ catheter Adult PiCCO ₂ Mounting clamp for PV8215 (040-002903-00)
	115-040653-00	PiCCO ₂ Accessory kit, Pediatric, Utah Including: IM2203 12 Pin IBP Y Cable CO7701 12 Pin PiCCO ₂ Cable PC80105 2 Pin Injecta Temperature Sensor Cable Pv8215 PiCCO ₂ Monitoring kit PV2013L07 PiCCO ₂ catheter pediatric PiCCO ₂ Mounting clamp for PV8215 (040-002903-00)

Picture	Part No.	No. Description
	115-041298-00	PiCCO ₂ Accessory kit, Adult, 2pcs IBP Cable (Utah+BD/Argon) Including: 12 Pin IBP Y Cable (040-002827-00) 12 Pin Utah IBP Cable (115-017849-00) 12 Pin BD IBP Cable (001C-30-70757) CO7701 12 Pin PiCCO ₂ Cable PC80105 2 Pin Injecta Temperature Sensor Cable PV2015L20-A PiCCO ₂ catheter Adult PV8215 PiCCO ₂ Monitoring kit PiCCO ₂ Mounting clamp for PV8215 (040-002903-00)
	115-041293-00	PiCCO ₂ Accessory kit, Pediatric, 2pcs IBP Cable (Utah+BD/Argon) Including: 12 Pin IBP Y Cable (040-002827-00) 12 Pin Utah IBP Cable (115-017849-00) 12 Pin BD IBP Cable (001C-30-70757) CO7701 12 Pin PiCCO ₂ Cable PC80105 2 Pin Injecta Temperature Sensor Cable PV2013L07 PiCCO ₂ catheter Pediatric PV8215 PiCCO ₂ Monitoring kit PiCCO ₂ Mounting clamp for PV8215 (040-002903-00)
	115-041296-00	PiCCO ₂ Accessory kit, Adult, 2pcs IBP Cable (Utah+ICU Medical) Including: 12 Pin IBP Y Cable (040-002827-00) 12 Pin Utah IBP Cable (115-017849-00) 12 Pin ICU Medical IBP Cable (001C-30-70759) CO7701 12 Pin PiCCO ₂ Cable PC80105 2 Pin Injecta Temperature Sensor Cable PV2015L20-A PiCCO ₂ catheter Adult PV8215 PiCCO ₂ Monitoring kit PiCCO ₂ Mounting clamp for PV8215 (040-002903-00)
	115-041294-00	PiCCO ₂ Accessory kit, Pediatric, 2pcs IBP Cable (Utah+ICU Medical) Including: 12 Pin IBP Y Cable (040-002827-00) 12 Pin Utah IBP Cable (115-017849-00) 12 Pin ICU Medical IBP Cable (001C-30-70759) CO7701 12 Pin PiCCO ₂ Cable PC80105 2 Pin Injecta Temperature Sensor Cable PV2013L07 PiCCO ₂ catheter Pediatric PV8215 PiCCO ₂ Monitoring kit PiCCO ₂ Mounting clamp for PV8215 (040-002903-00)



CCO Accessories





For BeneVision series monitors

Picture	Model	Part No.	No. Description	Purchasing Unit
	CO7704	009-000259-00	CCO Link Cable	Each

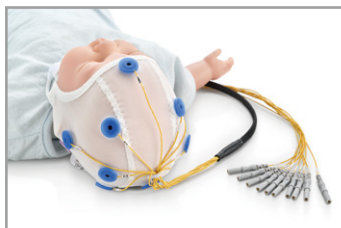
aEEG Accessories

For BeneVision series monitors

Picture	Model	Part No.	No. Description	Purchasing Unit
	EG14102	125-000131-00	MR aEEG/EEG cable	Each
	MN4013D15S		SPES EEG subdermal needle electrodes (disposable, L=13 mm, adu/ped/neo) (Please refer to local SPES supplier)	24 pcs
	CSSAGLNC1126J		SPES EEG headcap (reusable, Ag/AgCl, 30-34 cm, 9+GND+REF, neo) (Please refer to local SPES supplier)	1 pcs
		040-006211-00	GreenTek EEG headcap (reusable, Ag/AgCl, 30-34 cm, 8+GND+REF, neo)	1 pcs

Picture	Model	Part No.	No. Description	Purchasing Unit
		040-006213-00	GreenTek EEG cup electrodes (reusable, Ag/AgCl, D=10 mm, adu)	12 pcs
		040-006214-00	GreenTek EEG cup electrodes (reusable, Ag/AgCl, D=6 mm, ped/neo)	12 pcs
		040-006220-00	GreenTek EEG conductive cream GT20 for cup electrodes	Each
		040-006222-00	GreenTek EEG conductive cream GT5 for headcap	Each

Picture	Model	Part No.	No. Description	Purchasing Unit
		040-001595-00	EEG scrub cream	Each

aEEG Accessory Kit
For BeneVision series monitors

Part No.	No. Description	Purchasing Unit
115-073525-00	GreenTek aEEG accessory kit (cup electrodes, Ag/AgCl, D=6 mm, neo) Including: 125-000131-00 MR aEEG/EEG cable, 1pc 040-006214-00 GreenTek EEG cup electrodes, 1pc 040-001595-00 Nuprep EEG scrub cream, 1pc 040-006220-00 GreenTek EEG conductive cream GT20 for cup electrodes, 1pc	Set
115-073528-00	GreenTek aEEG accessory kit (cup electrodes, Ag/AgCl, D=10 mm, adu/ped) Including: 125-000131-00 MR aEEG/EEG cable, 1pc 040-006213-00 GreenTek EEG cup electrodes, 1pc 040-001595-00 Nuprep EEG scrub cream, 1pc 040-006220-00 GreenTek EEG conductive cream GT20 for cup electrodes, 1pc	Set
115-073527-00	GreenTek aEEG accessory kit (headcap, neo) Including: 125-000131-00 MR aEEG/EEG cable, 1pc 040-006211-00 GreenTek EEG headcap, 1pc 040-001595-00 Nuprep EEG scrub cream, 1pc 040-006222-00 GreenTek EEG conductive cream GT5 for headcap, 1pc	Set

ANI Accessory Kit
For BeneVision series monitors



Part No.	No. Description	Purchasing Unit
120-022099-00	ANI Upgrade kit (with module & accessory kit) Including: ANI module, 1 pcs ANI cable, 1 pcs ANI sensors for adult and pediatric above 12, 5 pcs Note: To order more consumables, please contact with MDoloris local distributor.	Set

NMT Accessories

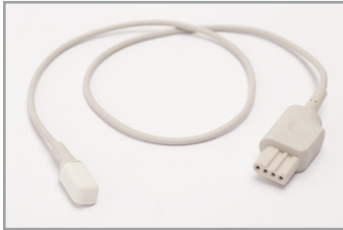
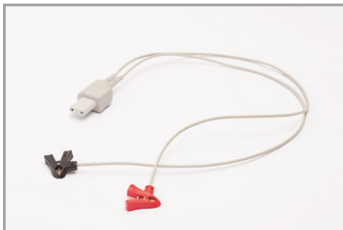
For BeneVision series monitors

Picture	Model	Part No.	No. Description	Purchasing Unit
	NM13101	040-001462-00	NMT main cable	Each
	NM13401	040-001463-00	NMT transducer cable	Each
	NM13701	040-001464-00	NMT stimulation cable	Each

For BeneVision series monitors

Picture	Model	Part No.	No. Description	Purchasing Unit
		040-002711-00	Adult ECG electrode (INTCO)	5 pcs/pouch
	NM13901	040-002258-00	Bandage for NMT transducer, disposable	20 pcs/pouch
	NM13902	115-058073-00	Reusable NMT handadapter for adult/pediatric	Each



NMT Accessory Kit

For BeneVision series monitors

Part No.	NO. Description	Purchasing Unit
115-040403-00	NMT accessory kit Including: 040-001462-00 NMT main cable 040-001463-00 NMT transducer cable 040-001464-00 NMT stimulation cable 040-002711-00 Adult ECG electrode (INTCO), 5 pcs 040-002258-00 Bandage for NMT transducer, disposable, 20 pcs	Set
115-057396-00	NMT accessory kit Including: 040-001462-00 NMT main cable 040-001463-00 NMT transducer cable 040-001464-00 NMT stimulation cable 040-002711-00 Adult ECG electrode (INTCO), 5 pcs 115-058073-00 Reusable NMT handadapter for adult/pediatric A30-000010--- Shipping label printing paper 100X150 mm	Set





INVOS rSO₂ Accessories

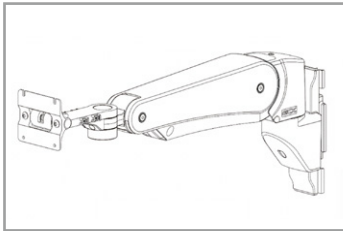

For BeneVision series monitors

Picture	Part No.	Description
	115-033947-00	INVOS rSO ₂ accessory kit, Adu Including: INVOS 5100C cable, channel 1&2, with Pre-amplifier A 1 pcs INVOS 5100C reusable sensor, channel 1 (blue) 1 pcs INVOS 5100C reusable sensor, channel 2 (brown) 1 pcs INVOS SomaSensor disposable sensor, Adu>40kg, 2 pcs
	115-033949-00	INVOS rSO ₂ accessory kit, Neo Including: INVOS 5100C cable, channel 1&2, with Pre-amplifier A 1 pcs INVOS cable + disposable sensor, Neo<5kg, brain/body, 2 pcs

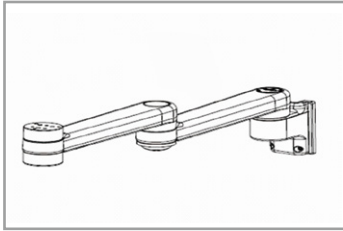
Mountings

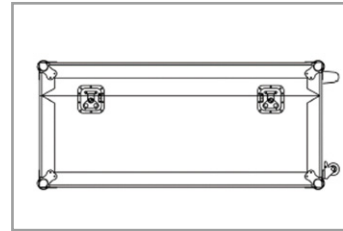
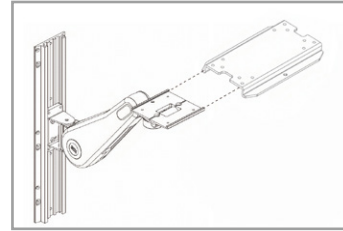

For BeneVision N series monitors

Picture	Model	Part No.	No. Description	Purchasing Unit
		034-000782-00	GCX VHM-P series variable height arm (for N22/N19, External Screen of N17/N15/N12)	Each
		034-000457-00	GCX M series 12" pivot arm (for N22/N19, External Screen of N17/N15/N12)	Each
		115-033882-00	SMR pivot arm	Each
		034-000452-00	7" Channel with 38 mm Post Clamp	Each

Picture	Model	Part No.	No. Description	Purchasing Unit
		045-002138-00	N22/N19 desktop support (VESA, only for Demo)	Each
		048-006620-00	N22/N19 demo case	Each
		045-003253-00	GCX VHM Variable Height Arm with/ transition plate (for N17/N15/N12)	Each
		045-003426-00	GCX M Series Pivot Arm with/ transition plate and basket (for N17/N15/N12)	Each

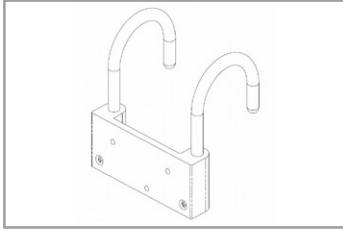
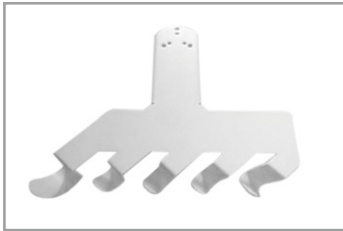
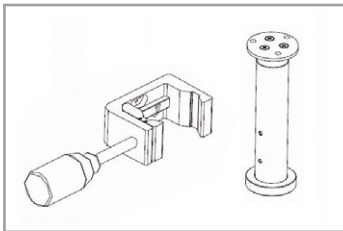
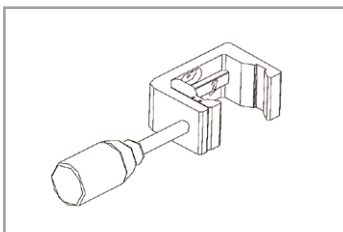
For BeneVision N series monitors

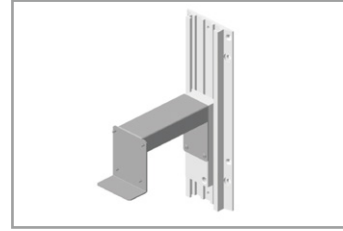
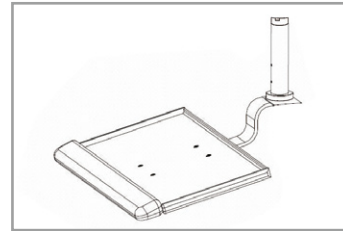
Picture	Model	Part No.	No. Description	Purchasing Unit
		115-045865-00	Bedrail hook (M3x16mm) only for N12	Each
		045-003814-00	5-Hook Cable Management Kit (for BeneVision N, ePM series monitors)	Each
		115-045621-00	SMR 9" down pole with mounting clamp (for N22/N19/N17/N15/N12)	Each
		115-035995-00	SMR 6" down pole with mounting clamp (for N22/N19/N17/N15/N12)	
		115-033913-00	SMR mounting clamp (for N22/N19/N17/N15/N12)	Each

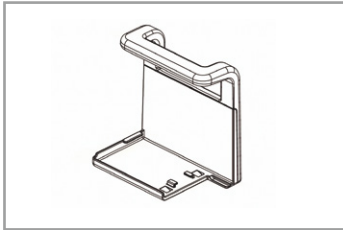
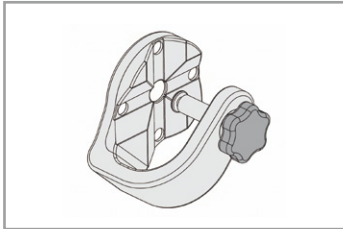
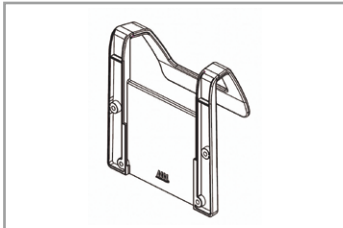

Picture	Model	Part No.	No. Description	Purchasing Unit
		115-037737-00	SMR mounting on wall kit (basic version)	Each
		115-033871-00	GCX M series Keyboard tray kit for on wall or ceiling (9" down pole)	Each
		115-033884-00	GCX M series Keyboard tray kit for on wall or ceiling (6" down pole)	
		115-033885-00	Wireless 1D Barcode Scanner (LI4278, USB & Bluebooth) with mounting kit	Each

For N1

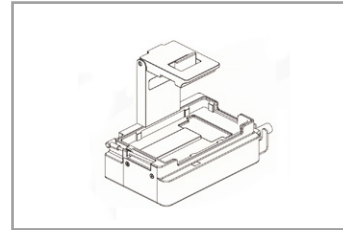
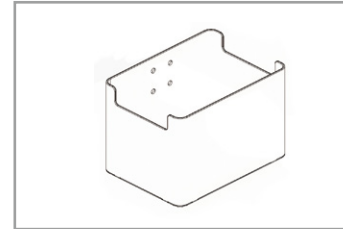
Picture	Model	Part No.	No. Description	Purchasing Unit
		115-050756-00	N1 handle (same as T1 handle)	Each
		045-001230-00	N1/T1/TDS crosslock/pole clamp	Each
		115-050759-00	N1 bedrail hook (paired with N1 handle)	Each

Picture	Model	Part No.	No. Description	Purchasing Unit
		115-049412-00	N1 Transport Dock (with China cord)	Each
		115-049422-00	N1 Transport Dock (with US cord)	
		115-049407-00	N1 Transport Dock (with UK cord)	
		115-049408-00	N1 Transport Dock (with Europe cord)	
		115-049503-00	N1 Transport Dock (with India cord)	
		115-049409-00	N1 Transport Dock (with South Africa cord)	
		115-049413-00	N1 Transport Dock (with Australia cord)	
	115-049410-00	N1 Transport Dock (with Swiss cord)		
	115-049411-00	N1 Transport Dock (with Brazil cord)		
		115-048417-00	N1 Accessory Cabinet for out-of-hospital transport	Each

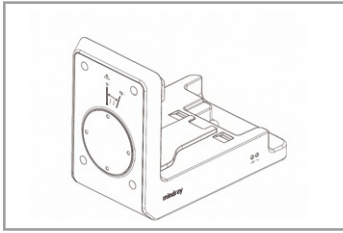
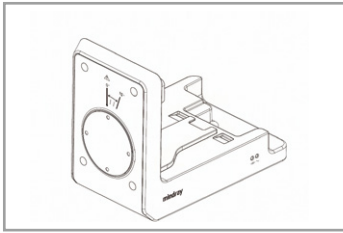
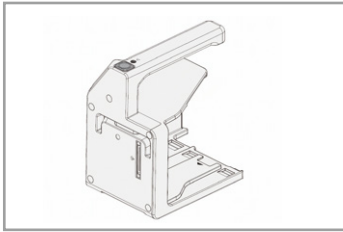
For N1 TDS

Picture	Model	Part No.	No. Description	Purchasing Unit
		With VGA	TDS docking station	Each
		115-048152-00	China cord	
		115-048153-00	US cord	
		115-048154-00	UK cord	
		115-048155-00	Europe cord	
		115-048156-00	India cord	
		115-048157-00	South Africa cord	
		115-048158-00	Australia cord	
	115-048160-00	Swiss cord		
		Without VGA	TDS docking station	Each
		115-048161-00	China cord	
		115-048162-00	US cord	
		115-048163-00	UK cord	
		115-048164-00	Europe cord	
		115-048165-00	India cord	
		115-048166-00	South Africa cord	
		115-048167-00	Australia cord	
	115-048169-00	Swiss cord		
		115-048150-00	TDS Modular Rack	Each
		115-050757-00	TDS bedrail hook	Each

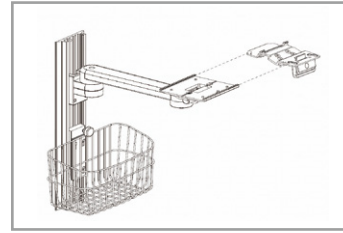
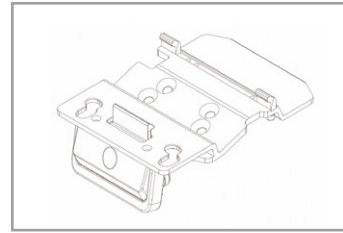
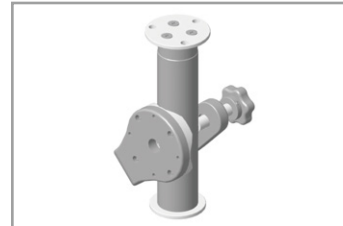
Picture	Model	Part No.	No. Description	Purchasing Unit
		045-003427-00	GCX M Series Pivot Arm w/quick release and basket	Each
		045-003424-00	Commen Quick lock adapter for all existing monitor models under 12" inch screen and VS (either on wall mount or trolley)	Each
		045-002198-00	TDS 6" up pole mount with crosslock clamp	Each



For ePM, uMEC, VS series monitors

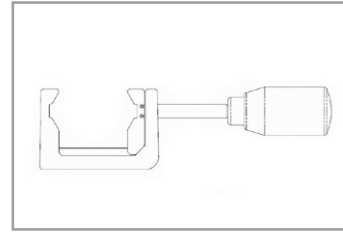
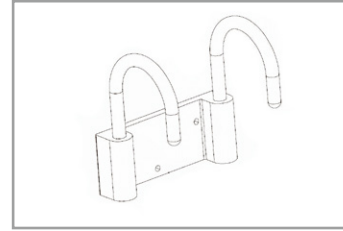
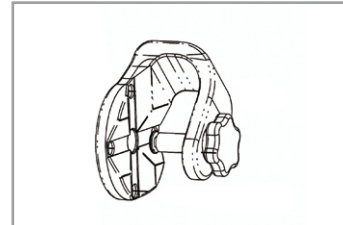



Picture	Model	Part No.	No. Description	Purchasing Unit
		045-003426-00	GCX M Series Pivot Arm with/transition plate and basket (for ePM 15)	Each
		045-003427-00	GCX M Series Pivot Arm with quick release and basket (for ePM <screen size is 12" inch or less>, uMEC, VS series monitors)	Each
		045-003055-00	Basic wall arm with quick release kit, basket (for ePM, iPM <screen size is 12" inch or less>, uMEC, iMEC series monitors in ROW market)	Each
		045-003054-00	Basic wall mount bracket (for VS series in ROW market)	Each

Picture	Model	Part No.	No. Description	Purchasing Unit
		8000-30-90170	Bedrail Clamp (for ePM 12M/10M/12/10)	Each
		8000-30-90169	Bedrail Hook (for ePM 12M/10M/12/10)	Each
		115-044101-00	uMEC 10 transition plate for bedrail mounting	Each
		115-044102-00	uMEC 12/15 transition plate for bedrail mounting	Each
		115-020575-00	VS Crosslock Clamp (VS 9/VS-900)	Each
		115-084841-00	VS Crosslock Clamp (VS 8)	Each

Part No.	No. Description	Purchasing Unit
115-097387-00	Bedrail clamp kit (10&12-inch New uMEC)	Each
115-097393-00	Bedrail clamp kit (15-inch New uMEC)	Each
115-097386-00	Bedrail hook kit (10&12-inch New uMEC)	Each
115-097388-00	Bedrail hook kit (15-inch New uMEC)	Each



Rolling stands

Picture	Model	Part No.	No. Description	Purchasing Unit
		045-003133-00	Roll Stand A (≤ 23kg, fixed-angle) (for N22/N19)	Each
		045-000915-00	Roll Stand B (≤15kg, fixed-angle, with two baskets) + Adapter (for N17/N15/ePM15/ePM15M)	Each
		045-003255-00	Roll Stand C (≤6kg, fixed-angle, with two brackets and barrel fix mounting) + Quick lock (for N12, ePM under 12" inch screen)	Each

Picture	Model	Part No.	No. Description	Purchasing Unit
		045-003053-00	Basic rolling stand (for ePM under 12" inch screen and uMEC series in ROW market)	Each
		045-003052-00	VS series basic rolling stand (ONLY for ROW market)	Each
		045-004267-00	Rolling Stand (Standard) + commen Quick lock (compact with all existing models under 12" inch screen and VS)	Each
		045-004268-00	VS 8/9 Rolling Stand (Advanced) + commen Quick lock	Each
		045-004269-00	VS 8/9 Rolling Stand (Advanced, with extended battery capacity) + commen Quick lock (the extended battery 115-034132-00 need to be purchased separately)	Each

Others

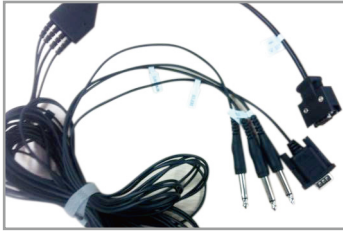
Picture	Model	Part No.	No. Description	Purchasing Unit
		009-003116-00	Nurse call cable (for ePM, VS series)	Each
		8000-21-10361	Nurse call cable (for N series)	Each
		009-005391-00	Output cable for ECG, IBP analog signal and Defib. Sync, MPM with MP1 port (for N series)	Each

Picture	Model	Part No.	No. Description	Purchasing Unit
		009-003117-00	Analog output cable (for ePM, iPM, uMEC, iMEC series)	Each
		009-003118-00	Defib Sync cable (for ePM, iPM, uMEC, iMEC series)	Each
		A30-000001---	Thermal Paper (50 mmX20 m)	Each

Picture	Model	Part No.	No. Description	Purchasing Unit
		048-005246-00	Reusable bag for telemetry (main unit not included)	Each
		115-032957-00	Single-patient bag for telemetry	25pcs/box

Accessories Management

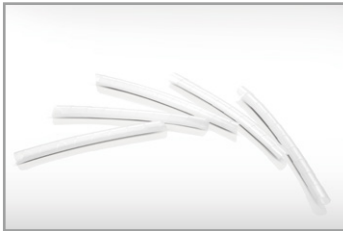
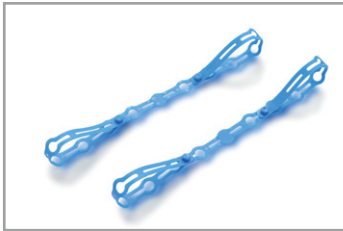
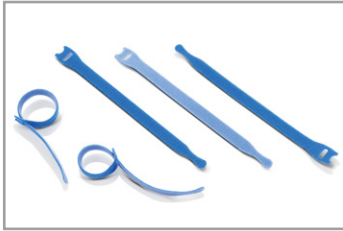
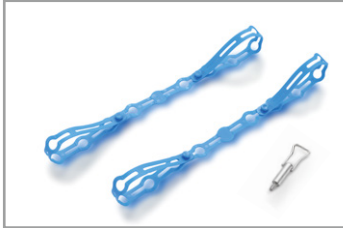
Picture	Model	Part No.	No. Description	Purchasing Unit
		009-003650-00	cable protecting tube, 20cm	5 pcs/pkg
		009-003649-00	cable protecting tube, 40cm	5 pcs/pkg
		009-003903-00	Accessories management tape, 62cm	2 pcs/pkg
	6934	0010-10-42667	Cable management straps	5 pcs/pack
		043-015467-00	Accessories Management assembly for ePM	Each

Barcode Scanner

Picture	Model	Part No.	No. Description	Purchasing Unit
		023-002134-00	Honeywell 1D&2D barcode scanner (HH450, USB)	Each
		025-000038-00	Honeywell 2D barcode scanner (HH1800, USB&RFID) with mounting kit	Each
		025-000256-00	Honeywell 2D barcode scanner (HH1800, USB) with mounting kit	Each



Defibrillator Accessories



Defibrillator Accessories





Reusable Internal paddles

- Apply for exposed heart defibrillation in OR during the heart surgery
- Integrate both cable and paddles in one cable
- Offer three paddle sizes to be chosen based on different patient types (1", 2" and 3")
- Auto-identify the paddle connection and reduce the energy level under 50J (default setting is 10J) for internal defibrillation use by uMED 20, BeneHeart D3/D6/D30/D60/DX
- Autoclavable

For BeneHeart DX/D60/D30/D6/D3/uMED 20

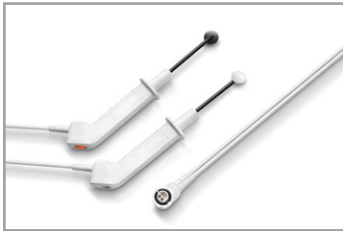
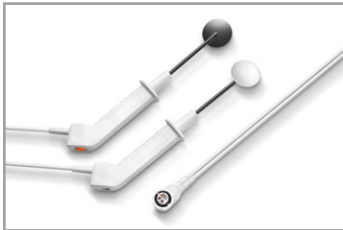
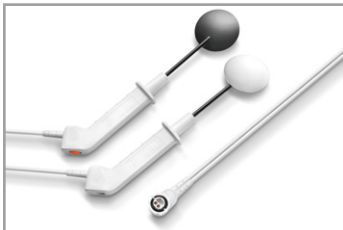
Picture	Model	Part No.	No. Description	Purchasing Unit
		115-018366-00	Internal paddles, without shock button, 1 inch	Each
		115-018367-00	Internal paddles, without shock button, 2 inch	Each
		115-018368-00	Internal paddles, without shock button, 3 inch	Each

Picture	Model	Part No.	No. Description	Purchasing Unit
		125-000166-00	Internal paddles, with shock button, 1 inch	Each
		125-000167-00	Internal paddles, with shock button, 2 inch	Each
		125-000168-00	Internal paddles, with shock button, 3 inch	Each
		125-000491-00	Internal paddle conversion cable_ DX pad ver.	Each

External Paddles and Cables

- Applicable for both adults and pediatric patients, and easy to switch
- Safe for defibrillation energy delivery
- Patient contact indicator (PCI) makes it more convenient for medical staff to check the patient's contact status
- Space-saving spiral cable, flexible and durable
- Outstanding cable material, enduring repeated cleaning and disinfection
- Latex free



For BeneHeart DX/D60/D30/D6/D3/uMED 20

Picture	Model	Part No.	No. Description	Purchasing Unit
		0651-30-77114	External paddles kit, Adu/Ped, PCI, with conductive gel (250 g)_D3 D6	Each
		125-000135-00	External paddles kit, Adu/Ped, PCI, with conductive gel (250 g)_uMED 20	Each
		125-000343-00	External paddles kit, Adu/Ped, PCI, with conductive gel (250 g)_D30 D60	Each
		125-000340-00	External paddles kit, Adu/Ped, PCI, with conductive gel (250 g), straight line design, recommended for pre-hospital with carrycase_D60 DX	Each

Pads Cable

- High voltage resistance and high safety
- Flexible and durable cables
- Outstanding cable material enduring repeated cleaning and disinfection



For BeneHeart DX/D60/D30/D6/D3/uMED 20

Picture	Model	Part No.	No. Description	Purchasing Unit
	MR6702	040-000545-00	Cable of electrode pads with test load (50 ohm) _uMED20 D3 D6 D30 D60 DX paddle ver.	Each
	MR6703	125-000254-00	Cable of electrode pads with test load (50 ohm)_ DX pad ver.	Each



Multifunctional Pads

- Two models for either adult or pediatric
- Multifunctional for defibrillation, pacing, and ECG monitoring
- Wide applicable temperature scope
- Highly adhesive
- Outstanding cable material enduring repeated cleaning and disinfection
- Disposable after use, and no pollution to the environment

For BeneHeart DX/D60/D30/D6/D3/D1/uMED 20

Picture	Model	Part No.	No. Description	Purchasing Unit
	MR60	0651-30-77007	Defibrillator disposable pads (Adu/Ped, without auto-identification, radiolucent), cable length 1.2 m, preconnectable (0.45 m cable out-of-pouch)	5pcs/box
	MR61	0651-30-77008	Defibrillator disposable pads (Ped, without auto-identification), cable length 1.2 m, preconnectable (0.45 m cable out-of-pouch)	5pcs/box

For BeneHeart D1

Picture	Model	Part No.	No. Description	Purchasing Unit
	MR62	115-035426-00	AED disposable pads (Adu/Ped, with auto-identification), cable length 1.2 m, preconnectable (0.45 m cable out-of-pouch)	5pcs/box
	MR63	115-035427-00	AED disposable pads (Ped, with auto-identification), cable length 1.2 m, preconnectable (0.45 m cable out-of-pouch)	5pcs/box

Test Load



- Used to test the performance of the main unit and multifunctional cable
- High reliability and safety

For BeneHeart DX/D60/D30/D6/D3/uMED 20

Picture	Model	Part No.	No. Description	Purchasing Unit
	MR6905	040-000413-00	Test load (for use with the cable of electrode pads)	Each



CPR Sensor





For BeneHeart DX/D60/D30/D6/D3/D1

Picture	Model	Part No.	No. Description	Purchasing Unit
		115-044871-00	CPR sensor kit (without battery) Including: CPR sensor without battery CPR sensor cable Disposable CPR sensor adhesive tape, 3 pcs	Each
		115-044836-00	CPR sensor kit (with battery, not for D1) Including: CPR sensor with battery CPR sensor cable Disposable CPR sensor adhesive tape, 3 pcs	Each
		040-003123-00	Disposable CPR sensor adhesive tape	3 pcs/pack

Carrying Case

- Carrying a defibrillator for pre-hospital or field emergency treatment
- Two models for either adult or pediatric
- High safety coefficient in load bearing
- High applicability in extreme environments
- Outstanding material enduring repeated cleaning and disinfection

Picture	Model	Part No.	No. Description	Purchasing Unit
		115-018610-00	Carry case_D3	Each
		125-000022-00	Carry case_D6	Each
		115-023421-00	Carry case_D1	Each

Picture	Model	Part No.	No. Description	Purchasing Unit
		048-004292-00	Rescue kit	Each
		125-000023-00	Upper pouch_D3	Each
		115-008543-00	Upper pouch_D6	Each
		115-008708-00	Back pouch_D3	Each
		125-000255-00	Carry case_D30	Each

Picture	Model	Part No.	No. Description	Purchasing Unit
		125-000411-00	Carry case (for paddle version main unit)_D60	Each
		125-000256-00	Carry case (for pad version main unit)_D60	Each
		125-000261-00	Carry case (including N1 rack)_DX paddle ver.	Each
		125-000260-00	Carry case (including N1 rack)_DX pad ver.	Each

Conductive Gel

Picture	Model	Part No.	No. Description	Purchasing Unit
	15-25	0000-10-10775	Conductive gel, 250 g	Each

Battery Charger

For BeneHeart D6/D3/D1



Picture	Model	Part No.	No. Description	Purchasing Unit
		115-009187-00	External Li-ion battery charger +1 power cord (GB)	Each
		115-009188-00	External Li-ion battery charger +1 power cord (US)	Each
		115-009189-00	External Li-ion battery charger +1 power cord (India)	Each
		115-009190-00	External Li-ion battery charger +1 power cord (EU)	Each
		115-009191-00	External Li-ion battery charger +1 power cord (Brazil)	Each
		115-009192-00	External Li-ion battery charger +1 power cord (UK)	Each
		115-025630-00	External Li-ion battery charger +1 power cord (Australia)	Each
		115-033660-00	External Li-ion battery charger +1 power cord (Swiss)	Each
		009-001687-00	DC power input cable for external charger, cigarette-lighter plug	Each
		115-013411-00	Mounting plate of external charger	Each

For BeneHeart DX/D60/D30



Picture	Model	Part No.	No. Description	Purchasing Unit
		115-098853-00	PowerBay 2X battery charger + power cord (US)_D30 D60 DX	Each
		115-098857-00	PowerBay 2X battery charger + power cord (UK)_D30 D60 DX	Each
		115-098862-00	PowerBay 2X battery charger + power cord (Swiss)_D30 D60 DX	Each
		115-098855-00	PowerBay 2X battery charger + power cord (EU)_D30 D60 DX	Each
		115-098858-00	PowerBay 2X battery charger + power cord (AUS)_D30 D60 DX	Each
		115-101129-00	PowerBay 2X battery charger + power cord (South Africa)_D30 D60 DX	Each

Power Adapter



For BeneHeart DX/D60

Picture	Model	Part No.	No. Description	Purchasing Unit
		115-091485-00	Power adapter (AC-DC, for D60 DX main unit with DC input)	Each
		115-105218-00	Power adapter (DC-DC, for D60 DX main unit with DC input)	Each

Thermal Paper

Picture	Model	Part No.	No. Description	Purchasing Unit
		A30-000001---	Thermal paper (50mmx20m) _D3 D6 D30 uMED 20	Each
		M002-10-69954	Thermal paper (80mmx20m)_D6	Each
		095-003317-00	Thermal Paper (110mmx20m) _D60 DX	Each





Mobile Trolley

Picture	Model	Part No.	No. Description	Purchasing Unit
		115-015823-00	Mobile trolley kit for D6 Including: Mounting for D6 Trolley for D3/D6	Each
		115-015825-00	Mobile trolley kit for D3 Including: Mounting for D3 Trolley for D3/D6	Each
		115-105360-00	Mobile trolley kit (including mounting)_D30 D60 DX	Each

Cabinet

Picture	Model	Part No.	No. Description	Purchasing Unit
		045-001140-00	AED cabinet (with mounting kit, lock and alarm)	Each

Mounting





Picture	Model	Part No.	No. Description	Purchasing Unit
		115-007587-00	Bedrail hook_D3 D30 D60 paddle ver.	Each
		115-051797-00	Bedrail hook_D6	Each
		115-096566-00	Bedrail hook_D60 pad ver.	Each
		115-013412-00	Table mounting kit_D3	Each
		115-066638-00	Vehicle mounting kit_D3	Each
		115-005061-00	Vehicle mounting kit_D6	Each





Picture	Model	Part No.	No. Description	Purchasing Unit
		115-030528-00	D6 vehicle dock station CE, DC power input connector, with cigarette DC power cable	Each
		115-030529-00	D6 vehicle dock station CE, AC power input connector, without AC power cable	Each
		115-091479-00	Vehicle mounting (No charging)_D30 D60 DX	Each
		115-091477-00	Vehicle charging dock CE, AC/DC power input connector, with cigarette DC power cable (to D60 DX main unit with DC input)	Each

Picture	Model	Part No.	No. Description	Purchasing Unit
		115-091478-00	Vehicle charging dock CE, AC power input connector (to D60 DX main unit with DC input)	Each

Others

For BeneHeart DX/D60/D30/D6/D3/uMED 20

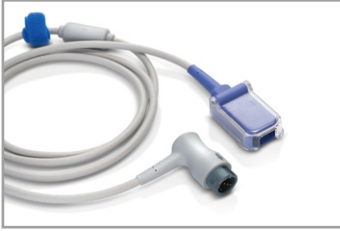
Picture	Model	Part No.	No. Description	Purchasing Unit
		125-000258-00	ECG cable and wires (integrative): Adu/Ped, 12Pin 4-Lead ECG Cable, IEC, Snap (L-type plug), recommended for pre-hospital_D60 DX	Each
		125-000259-00	12-Lead ECG Chest Wires, Adu/Ped, Snap, IEC (use with 125-000258-00 only), recommended for pre-hospital_D60 DX	Each
		125-000683-00	ECG cable and wires (integrative): Adu/Ped, 12Pin 4-Lead ECG Cable, AHA, Snap (L-type plug), recommended for pre-hospital_D60 DX	Each
		125-000685-00	12-Lead ECG Chest Wires, Adu/Ped, Snap, AHA (use with 125-000258-00 only), recommended for pre-hospital_D60 DX	Each

Picture	Model	Part No.	No. Description	Purchasing Unit
		125-000252-00	Mindray SpO ₂ cable, 7 Pin, L-type plug, recommended for pre-hospital_D60 DX	Each
		125-000689-00	Masimo SpO ₂ extension cable, 8 Pin, purple connector, L-type plug, recommended for pre-hospital _D60 DX	Each
		125-000688-00	Nellcor SpO ₂ extension cable, 8 Pin, L-type plug, recommended for pre-hospital _D60 DX	Each
		125-000253-00	NIBP Tubing, Adu/Ped/Infant, with air plug connectors (2m), recommended for pre-hospital, ISO80369 _D60 DX	Each

Picture	Model	Part No.	No. Description	Purchasing Unit
		120-023307-00	Ultrasound probe (a3P-X)_D60 DX	Each

Part No.	No. Description	Purchasing Unit
009-008523-00	Defib Sync cable_D3 D6 D30 D60 DX	Each
0651-20-77046	Defib Sync cable_uMED 20	Each
009-008524-00	Analog output cable_ D3 D6 D30 D60 DX	Each
0651-20-77122	Analog output cable_uMED 20	Each
115-067930-00	Wi-Fi to 4G router kit_D3 D6	Each

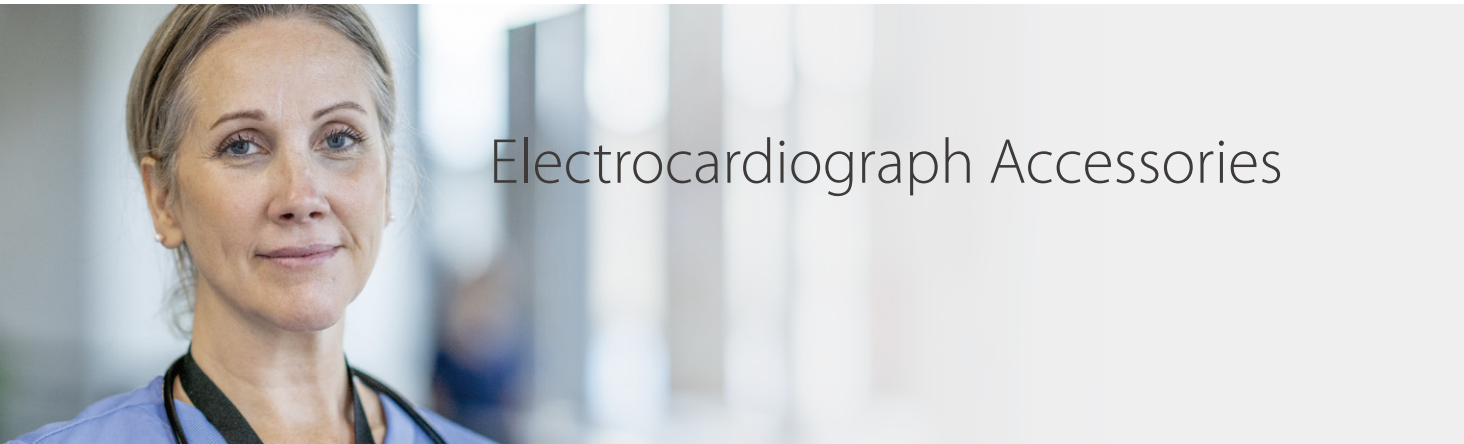









Electrocardiograph Accessories





Electrocardiograph accessories



- Apply for 12-lead ECG acquisition on electrocardiograph
- Both ECG cable with banana plugs, Limb Clamps, Chest Bulbs and ECG cable with Electrode clips are available
- Both IEC and AHA accessories are available

For BeneHeart R3/R12

Picture	Model	Part No.	Description	Purchasing Unit
		040-001579-00	12-lead ECG cable, IEC, Φ4 banana plugs (Qingdao Bright)	Each
		040-001582-00	12-lead ECG cable, AHA, Φ4 banana plugs (Qingdao Bright)	Each

Picture	Model	Part No.	No. Description	Purchasing Unit
		040-001644-00	12-lead ECG cable, IEC, Φ4 banana plugs (Mindray)	Each
		040-001642-00	12-lead ECG cable, AHA, Φ4 banana plugs (Mindray)	Each
		040-001587-00	Limb clamps, 4/set, IEC	4 pcs/set
		040-001586-00	Limb clamps, 4/set, AHA	4 pcs/set
		040-001585-00	Chest bulbs, 6/set	6 pcs/set
		040-001645-00	12-lead ECG cable, IEC, Clip	Each
		040-001643-00	12-lead ECG cable, AHA, Clip	Each

Picture	Model	Part No.	No. Description	Purchasing Unit
	15-25	0000-10-10775	Conductive gel, 250 g	Each
		115-024338-00	Carrying bag for R3	Each
		045-001385-00	Trolley for R3, with case and cable arm	Each
		045-001384-00	Trolley for R12, with case and cable arm	Each
		049-000739-00	Keyboard cover for R12, Silica rubber	Each

Picture	Model	Part No.	No. Description	Purchasing Unit
		M002-10-69954	Rolling thermal paper (80mmx20m)	Each
		095-002775-00 095-003383-00	Thermal paper, A4 size, 210mmx295mm 100p	Each
		095-002773-00 095-003381-00	Thermal paper, A4 size, 210mmx295mm 150p	Each
		095-002708-00	Folding thermal paper (80mmx14m)	Each
		095-002776-00 095-003384-00	Thermal paper, US letter 215mmx280mm 100p	Each
		095-002774-00 095-003382-00	Thermal paper, US letter 215mmx280mm 150p	Each