



Advanced Visualization System™

Product Catalog



50L
INSUFFLATION SYSTEM



10K
PUMP



EDGE
BIPOLEAR ARTHROSCOPIC RF



To learn more about these and other products, call 800-448-6506 or visit CONMED.com.

Ordering Information	2
Product Support.....	3
Warranty Terms.....	4
Return/Repair Information.....	5
Camera Systems.....	6
3DHD Camera Systems	7
Light Sources and Light Guides	8
Medical Monitors.....	9
Surgical Video Carts and Accessories.....	10
Digital Documentation.....	11
UHD & HD Arthroscopes.....	12
Arthroscopes and Sheath Systems	13 - 16
UHD Laparoscopes.....	17
HD Laparoscopes	18
Sterilization Trays.....	19
Insufflation Systems.....	20
Video Accessories.....	21

Terms

CONMED standard terms are net thirty (30) days, F.O.B. shipping point, unless otherwise approved in writing by CONMED. All orders and transactions are subject to the laws of the state of Florida.

To Place Your Order

Please provide a purchase order number, billing and shipping instructions, product catalog number and description, valid CONMED quotation, and quantity and pricing to one of the following:

Your Sales Representative

Customer Service

Phone: 800-237-0169

Fax: 727-399-5256

E-mail: custserv1@CONMED.com

CONMED

Attn: Customer Service

11311 Concept Boulevard

Largo, FL 33773-4908 USA

True Purchasing Flexibility

CONMED Financial Services offers a variety of flexible financing programs, from leases to Pre-Procedure Programs to delayed payment plans. Ask your Sales Representative for more information on how you can acquire the latest technology through a financing program that fits your unique budgetary requirements.

Rental Program for Instrument Sets and Capital Equipment

In every O.R., there are times when you have to schedule a case but do not have the equipment needed. Either the capital funding for the equipment has yet to be approved or you have been unable to justify the cost of the equipment due to the procedure's low volume.

For these situations, CONMED offers a rental program for procedure-specific instruments and capital equipment. Simply call CONMED at 888-587-9742 and everything that you need for the case is on its way.

To enroll in a rental program, contact your Sales Representative or call the CONMED field inventory team. Your representative will help you customize the kit(s) to fit your procedural requirements. After the case, simply return the instruments, cleaned and sterilized if appropriate, along with any disposables you did not use. The rental fee will be billed for the disposables not returned, and customer will be responsible for any expedited shipping cost.

Failure to return instrumentation/equipment at the end of the rental period will result in the customer being charged the standard rental fee automatically for each week that the instrumentation/equipment is not received by CONMED.

At CONMED, we want to offer more than a quality product. We take pride in being able to provide you with value added services to support our products. The information given in this catalog is designed to address your questions regarding product support.

Customer Support

If you encounter a problem or need technical assistance, contact Customer Service (Product Support) or your Sales Representative. Refer to the Customer Service telephone numbers listed on page 2.

Regulatory Compliance

Report any injuries or malfunctions to CONMED Customer Service. Refer to the Customer Service telephone numbers listed.

Original Warranty

CONMED (the “Company”) warrants to the first purchaser or lessee (“You” or “Customer”) that the instruments, attachments and parts manufactured by or for the Company (hereinafter collectively “Instruments”) have been tested, inspected, and shipped in proper working order.

The Company warrants all new instruments to be free from defects in materials and workmanship for the following periods, measured from date of sale:

Product Categories	Months
All Single Use Products.....	Upon Receipt
Powered Surgical Instruments.....	12
Power Attachments and Accessories	12
Handpiece Cords and Power Cords	6
Light Source.....	24
Pneumatic Hoses.....	6
Bur Guards, Blade Guards, Attachments	6
Battery Packs and Accessories.....	3
Battery Chargers	12
Camera Console.....	12
Video Components	12
Video Cables and Light Guides.....	3
Scopes.....	12
Camera Heads	12
Instruments	12
Instrument Tray.....	3
Footswitches	12
Irrigation Systems (Pumps and Remotes).....	12
Reusable Procedure Specific Instruments	6

Following the Original Warranty, CONMED offers additional warranty and service programs that support our products throughout their lifetime. Service programs address the necessity to control cost and greatly reduce repair turnaround time by eliminating the need for repair quotes.

Products not covered under a service program are subject to variable repair charges. To find out which service option best meets your needs, contact your local Sales Representative.

Service Agreements

Service Agreements provide additional service coverage on capital equipment. This additional service coverage period covers all repair costs, periodic maintenance, free loaner usage during repair time and freight charges out from CONMED both on the loaner product and the repaired instrument.

Service Warranty

After expiration of the Original or Service Agreement period, instruments may be returned to CONMED for repair at the customer’s expense. CONMED warrants that any service or repair work performed by CONMED shall be free from defects in workmanship and materials for a period of 90 days after the date the customer receives the Instrument(s). This limited warranty applies only to the actual service or repair work performed by CONMED or its authorized service centers. CONMED warrants that all parts and assemblies used in the repair or service of Instruments meet new part functional specifications, although some parts or assemblies may have been remanufactured.

CONMED components are manufactured to exacting tolerances and design specifications. As a standard practice, all repairs are subject to strict product performance and testing specifications prior to returning the Instrument to the customer. CONMED ensures that each Instrument is inspected according to the guidelines used for new manufactured Instruments. If an Instrument is determined unrepairable, CONMED will offer to sell to the customer a refurbished or brand new Instrument or comparable equivalent at a preferential price. All parts and assemblies replaced by CONMED shall become the property of CONMED.

Repair Quotes

Customer Service will provide an estimate of the repair charge for non-warranty repairs at the time the Service Request (SR) is authorized.

Minimum Service Charge

There is a minimum repair charge for the evaluation and testing of all returns (except for products covered under warranty).

Return Shipping

All repaired products will be returned to you by ground transportation unless you request an alternate shipping method. The cost of return shipping is your responsibility unless the product is under warranty or service agreement.

Warranty Terms

If the customer discovers within the warranty period (Original or Service Agreement) that an Instrument has a defect in materials and/or workmanship, the customer must promptly notify the Company. Also, if the customer discovers within the service warranty period that any service or repair work performed by CONMED has a defect in workmanship and/or materials, the customer must promptly notify the Company. If it becomes necessary to return the Instrument to the Company, the customer must (a) acquire a "Service Request" (SR) authorization from the Company Customer Service Department, (b) pack the unit carefully, and (c) return it to the Company.

Within a reasonable time after receipt of the Instrument, the Company will investigate and correct any defect covered by warranty by providing, at its option, one of the following: service or repair of the Instrument, or replacement of the Instrument. All parts and assemblies replaced by CONMED shall become the property of CONMED. These remedies are the customer's exclusive remedies under the warranty.

The foregoing limited warranties do not apply to:

- » Instruments that have been tampered with, altered, neglected, or misused,
- » Instruments damaged through use with other than Company authorized accessories, attachments, burs or blades,
- » Instruments not manufactured by or for the Company,
- » Instruments used for purposes other than those for which they were designed and manufactured, including use in any way inconsistent with the instructions and warnings contained in the Company instruction manuals and package inserts, and
- » Instruments that were last serviced, refurbished, reprocessed or reconditioned by a nonauthorized service entity.

THE FOREGOING LIMITED WARRANTIES ARE IN LIEU OF ALL OTHER WARRANTIES, EXPRESS OR IMPLIED, INCLUDING, BUT NOT LIMITED TO, THE IMPLIED WARRANTIES OF MERCHANTABILITY AND FITNESS FOR A PARTICULAR PURPOSE.

In no case shall the Company be liable for any special, incidental, indirect or consequential damages based upon breach of warranty or any other legal theory. Some jurisdictions do not allow limits on warranties, or on remedies, and, in such jurisdictions, the limits in this and the preceding paragraphs may not apply.

The Company reserves the right (a) to make design changes to Instruments at any time without notice to customer and without incurring any obligation to incorporate those changes into Instruments previously purchased or leased, and (b) to make changes from time to time in the contents of any publication, instruction manual or package insert without any obligation to notify customers of such revisions or changes, and (c) to change price without notice.

U.S. Procedure for Returns/Repairs

1. All instruments must be cleaned and decontaminated prior to the return to CONMED. Instruments contaminated with biohazardous materials will be returned to you at your expense.
2. An authorized Service Request (SR) Number must be obtained prior to returning any Instrument for repair/return.
3. To return a product for repair, contact CONMED Customer Service. The following information is needed to process a repair/return:
 - » Catalog Number
 - » Serial/Lot Number
 - » Detailed Description of the problem or reason for return
 - » Contact Name, Phone Number and Email Address
4. The SR number must be displayed on the outside of the box, included with all paperwork, and must be referred to when making an inquiry about the status of a repair/return.
5. CONMED maintains various repair centers around the world. When you are issued your SR number, you will be advised of the location where to send your product.

Return Terms

If it becomes necessary to return a product after purchase, the product must be returned within 45 days of its ship date. The product must be returned unused, in the original packaging and be restockable. Returns must be shipped prepaid freight. Returns that are not shipped prepaid freight will not be accepted. All product returns, except those attributable to a CONMED error, are subject to a restocking fee of 15% of the purchase price or \$25, whichever is greater.

Products Not Eligible for Credit:

- » Sterile products/single use devices returned with the outer packaging seals broken
- » Non-sterile products that have been sterilized and/or placed in the surgical field
- » Products damaged by customer misuse or negligence
- » Altered or customized products
- » Products damaged in return transit due to inadequate packaging
- » Less than full packages – all products must be in original packaging
- » Obsolete products

Packaging

Whenever it is required to return your product, be sure to package it in a protective carton. We recommend that you save the original shipping container for this purpose. In-transit damage is not covered by the warranty; therefore, it is best to always insure shipments.



**IM8000 True HD 3
MOS Camera Control Unit**



True HD 3MOS "Eyecup" Camera Head



True HD 3MOS "Cartridge" Camera Head



True HD 3MOS "Urology" Camera Head

IM8000 True HD 3MOS Camera Control Unit

- » Vivid Visualization - CMOS chip sensors provides increased light sensitivity, crisp resolution and the most natural color spectrum for advanced surgical procedures.
- » Fully Autoclavable- All three camera heads are designed to be autoclavable, which is the most cost-effective form of sterilization.
- » Durable Design -For increased durability and reliability, these camera heads feature our proprietary ShockFlex™ prism mounting designed to limit surprises in the OR caused by faulty equipment and ensure a long life span

	Cat. No.
True HD 3MOS Camera Control Unit	IM8000
Autoclavable True HD 3MOS "Eyecup" Camera Head.....	IM8120
Autoclavable True HD 3MOS "Cartridge" Camera Head.....	IM8121
Autoclavable True HD 3MOS "Urology" Camera Head	IM8123

All products may not be available in all markets.

3DHD Camera Controller and Light Source

	Cat. No.
3DHD Camera Controller	8170-6
3DHD Light Source.....	8050-2
3DHD Light Guide 5mm.....	LG1050

3DHD LCD Display

3DHD LCD Display – 24" (Sony)	8272-14
3DHD LCD Display – 32" (Panasonic**)	8273-19

3DHD Camera Heads

3DHD Dual Channel Camera Head	8170-9
3DHD Single Channel Camera Head.....	8170-8
3DHD 2D Camera Head.....	8170-7
Coupler F-27.....	8080-02

3DHD 3D Glasses

3DHD 3D Glasses (box of 5)	8272-15
3DHD Overwear 3D Glasses (box of 5).....	8272-16

Endoscopes

3DHD Dual Channel Endoscope 10mm 0°	8191-05
3DHD Dual Channel Endoscope 10mm 30°	8191-06
3DHD Stereo Endoscope 10mm 0°	8191-01
3DHD Stereo Endoscope 10mm 30°	8191-02
3DHD Dual Channel Stereo Endoscope 10mm 0°	8191-11
3DHD Dual Channel Stereo Endoscope 10mm 30°	8191-12
3DHD Dual Channel Standard Length Stereo Endoscope 10mm 0°	8191-13
3DHD Dual Channel Standard Length Stereo Endoscope 10mm 30°	8191-14

3DHD Light Source



3DHD Camera Controller



3DHD Dual Channel Camera Head

3DHD Single Channel Camera Head



3DHD 2D Camera Head



Coupler F-27



3DHD Overwear 3D Glasses

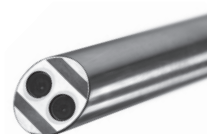

3DHD Dual Channel Endoscope 10mm 30°

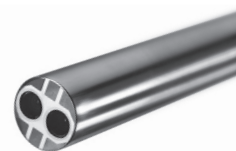

3DHD Dual Channel Endoscope 10mm 0°



3DHD Stereo Endoscope 10mm 30°

All products may not be available in all markets.



LS8000 Direct LED Light Source

LS8000 Direct LED Light Source

- » Energy-efficient, LED technology consumes less energy than Xenon style bulbs and can last up to 40 times longer than many other light source types. This avoids the constant replacement of light bulbs which can become costly and time consuming for the hospital staff.
- » Includes light guide detection feature for automatic standby when the light guide is removed from the receptacle. This avoids excessive heat at the tip of the scope that may engage the drape and cause safety issues during the procedure.
- » Light box console Includes new informative display with intuitive icons for ease-of-use in operating.
- » Ideal for frequent on-off cycling with low burn out rates.

Cat. No.

Direct LED Light Source..... LS8000

High Definition Compatible Light Source

The HD Compatible 300 Watt Xenon Light Source from CONMED is a stand-alone, user-friendly light source that provides optimal light output so even the most challenging surgical cases are adequately illuminated.

- » OLED window display with multi-function read out
- » HD Camera control connection allows surgeon to safely turn bulb stand-by on/off via the remote camera head button
- » HD Camera communication link allows light output to automatically adjust to optimal light intensity when using the IM4000 HD Camera
- » Universal light guide receptacle that accommodates both long and short light guide adapters
- » Auto bulb-saver feature designed to extend useful life of bulb when light source is not in use
- » Easy access bulb replacement
- » Locking feature to keep light guide securely in place
- » Compatible with ConMed's SMART OR™ Nurse's Assistant® OR Control and Integration Systems

300 Watt Xenon Light SourceLS7700

Universal Light Guides

- » Autoclavable
- » Superior light transmission
- » Lightweight and flexible
- » Universal fittings

5mm Universal Light Guide, Non-Transparent C3278

5mm Autoclavable Light Guide, Translucent Blue LG1050

5mm Autoclavable Light Guide, 90 degree, Translucent BlueLG1090

Wolf, Dyonics Scope Fitting..... 7451

ACMI Scope Fitting..... 7452

Storz, Olympus Scope Fitting 7453

Wolf, Dyonics Light Source Fitting..... 7455

ACMI Light Source Fitting 7456

Storz Light Source Fitting..... 7457

Olympus Light Source Fitting 7458

Weck Xenon Light Source Fitting..... 7462

Replacement Scope Fiber Post Adapters 7513

*NOTE: When ordering a light, make sure to order appropriate fittings to go with it.



LS7700 HD Compatible Light Source

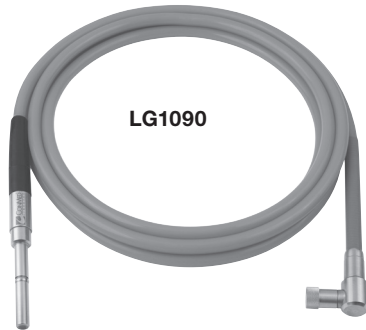

LG1090



LG1050

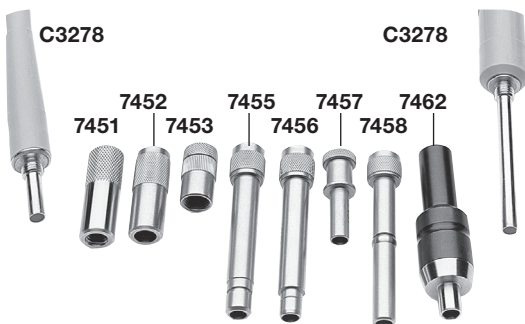

C3278

C3278

7451 7452 7453 7455 7456 7457 7458 7462

All products may not be available in all markets.

4K MONITORS

CONMED's 4K System provides dependable performance and a vivid image, allowing surgeons the depth and clarity needed in the OR.

	Cat. No.
SONY 31" Medical Monitor	LMD-X310MD
4K UHD Monitor, 32"	VP4932

HD LED Monitor

26" and 32" HD LED Backlit Medical Grade Monitors & Wireless System

26" High Definition LED Monitor	VP4826
32" High Definition LED Monitor	VP4832

Wireless Options

HD Wireless Kit	WIS1000
HD Wireless Kit w/ Signal Conditioner	WIS1000-1001

LCD Monitor Covers

» Protects your investment when not in use

Monitor Cover, 26"	VP4826C
Monitor Cover, 32"	VP4832C



LMD-X310MD



VP4932



LCD Monitor Cover

All products may not be available in all markets.



VP8500 Video Cart



Flat Panel Post Mount



Flat Screen Roll Stand

All products may not be available in all markets.

VP8500 Video Cart

The next generation video cart is like nothing else on the market. The VP8500 Video Cart provides your OR with clean lines, new features and added flexibility. Providing a platform for High Definition or Enhanced Definition equipment, the VP8500 is designed to be as modern looking as the equipment on its shelves.

	Cat. No.
Video Cart, US.....	VP8500
Video Cart, Standard, INT	VP8501

Accessories

Primary Articulating Arm.....	VP8570
Secondary Articulating Arm with Keyboard Tray	VP8571
17" Wide shelf option	VP8540
10K Pump Holder	VP8572
Dual Tank Gauge	VP8573
CO ₂ Holder, Dual Tank Holder	VP8574
CO ₂ Holder, Single Tank Holder	VP8575
Storage Drawer	VP8576
Camera Head Holder	VP8577
Footswitch Bin.....	VP8578
Patch Panel Kit.....	VP8579
Tank Wrench with Magnetic Base.....	VP8580
Heavy Panel, Flat Panel Post Mount	VP8565
Articulating Arm 26" monitor	VP8525
Post Mount 26" monitor	VP8526
Trinity Tablet Arm	VP8581
Monitor Yoke 32" monitor M4 x 14mm stainless steel screws are used to mount 32" monitor bracket	VP8532

Replacement Parts

Replacement Isolation Transformer for VP8501	VP8536
*Replacement Cord Reel	VP8547
Replacement Power Strip/Switch.....	VP8561
Replacement Stickers are available. Contact Customer Service.	

Flat Screen Roll Stand

Flat Screen Roll Stand	VP4602
Replacement VESA Mounting Kit.....	VP4603
Height Adjustment Knob	VP4604
Utility Basket	VP4605
Cable Management Clips (pkg of 5).....	VP4606
Caster Wheels (pkg of 5)	VP4607
Tilt Adjustment Lever	VP4608

*Only applicable to carts with cord reel currently installed

CMS9000 Content Management System

With features like multi-channel Full HD recording, wireless connectivity, integration with hospital electronic health record (EHR) networks, live streaming, an improved iOS app (iPad and iPhone) and more, the CMS9000 represents CONMED's next generation of high definition image capture system that's designed to improve how hospitals manage surgical footage both in and out of the OR.

Features

- » Wi-Fi Connection to Hospital EMR Networks
- » Integrated iPad/iPhone App
- » Live, Full-HD Streaming over ip
- » Integrated Data Security
- » Customizable User Profiles

Cat. No.

CMS9000 Content Management System.....	CMS9000
CMS9000 Software Upgrade with Installation Card	CMS30
15" LCD Medical Touch Screen Monitor.....	CMS34
CMS34 Stand	CMS34-STD

Sony Full Page Color Printer

The UP-DR80MD is the flagship printing option for HD image capture systems. The UP-DR80MD prints in letter or A4 format and is medical grade. The UP-DR80MD is ideal for all applications where outstanding image quality and accurate color reproduction are essential. This fast and reliable dye sublimation printer is compact enough for video cart integration.

Features

- » Premium, photo-realistic prints
- » High-speed printing
- » Compact size and stylish design
- » Fits well on surgical video carts
- » USB 2.0 connection
- » Self-laminating roll media
- » Easy to operate
- » Letter or A4 Paper Size/50 sheet capacity

Specifications

- » Power Requirements: 100 – 240 VAC, 50/60 Hz, 3.4 A to 1.4 A
- » Controller: 12.5" h x 8.13" w x 16.75" l (31.7 cm w x 20.7cm h x 42.5cm d)
- » Weight:25.3 lbs. (11.5 kg)

Sony UP-DR80MD Full Page Digital Color Printer.....	UP-DR80MD
Color Print Pack, Letter Size, 100 Sheets	UPC-R81MD
Color Print Pack, A4 Size, 100 Sheets.....	UPC-R80MD



**CMS9000
Content Management System**

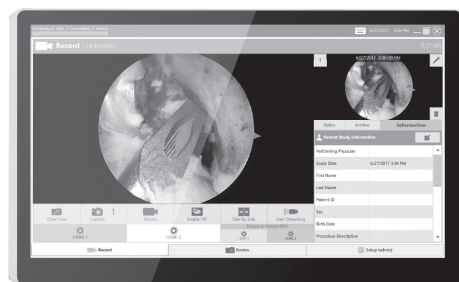

15" LCD Medical Touch Screen Monitor



Sony UP-DR80MD Full Page Color Printer

All products may not be available in all markets.



Ultra HD 4mm, 0° Arthroscope



Ultra HD 4mm, 30° Arthroscope



Double QuickLatch® Bridge



HD Autoclavable 4mm Arthroscope

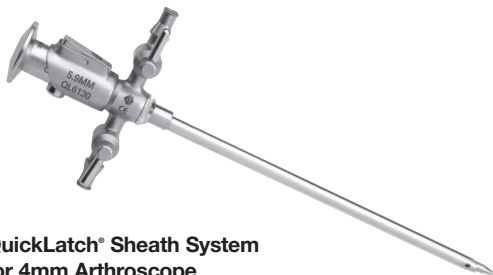

QuickLatch® Sheath System for 4mm Arthroscope

UHD 4mm Arthroscope

Proprietary scope-sheath interface offers ease-of-use with better protection of the arthroscope and increased flow efficiency.

- » 5.5mm and 5.9mm Outside diameter sheaths
- » Scope-sheath interface increases durability and provides excellent tip protection of the arthroscope

	Cat. No.
Ultra HD 4 mm, 0° Scope, 157 mm WL	UHD4000
Ultra HD 4 mm, 30° Scope, 157 mm WL	UHD4300
Ultra HD 4 mm, 30° Scope, Reverse Light Post, 157 mm WL	UHD4302
Ultra HD 4 mm, 70° Scope, 157 mm WL.....	UHD4700
5.5 mm, Single Stopcock Arthroscope Sheath System.....	UQL5531
5.5 mm, Single Stopcock Arthroscope Sheath System, Reverse Light Post.....	UQL5531-R
5.5 mm, Double Stopcock Arthroscope Sheath System	UQL5532
5.5 mm, Double Stopcock Arthroscope Sheath System, Reverse Light Post	UQL5532-R
5.9 mm, Single Stopcock Arthroscope Sheath System.....	UQL6131
5.9 mm, Single Stopcock Arthroscope Sheath System, Reverse Light Post.....	UQL6131-R
5.9 mm, Dual Stopcock Arthroscope Sheath System	UQL6132
5.9 mm, Dual Stopcock Arthroscope Sheath System, Reverse Light Post.....	UQL6132-R
4.0 mm, Blunt Obturator.....	UQL6101
4.0 mm, Conical Obturator.....	UQL6102
4.0 mm, Sharp Trocar	UQL6103
Single Stopcock QuickLatch® Bridge	UQL6111
Single Stopcock QuickLatch® Bridge, Reverse Light Post	UQL6111-R
Double Stopcock QuickLatch® Bridge	UQL6112
Double Stopcock QuickLatch® Bridge, Reverse Light Post	UQL6112-R

HD Autoclavable 4mm Arthroscope

CONMED's 4mm HD Arthroscope features state-of-the-art optics with an innovative scope-sheath interface.

- » Working length 170mm

	Eyecup	Cartridge
4mm 0°	HD4000	HD4001
4mm 30°	HD4300	HD4301
4mm 70°	HD4700	HD4701

QuickLatch® Sheath System for 4mm Arthroscope

Proprietary scope-sheath interface offers ease-of-use with better protection of the arthroscope and increased flow efficiency.

- » 5.5mm and 5.9mm Outside diameter sheaths
- » Scope-sheath interface increases durability and provides excellent tip protection of the arthroscope

5.5mm Arthroscopy Sheath Kit	
Single Stopcock.....	QL5531
Double Stopcock.....	QL5532
5.9mm High Flow Sheath Kit	
Single Stopcock.....	QL6131
Double Stopcock.....	QL6132
5.9mm Pressure Sensing Sheath Kit	
Single Stopcock.....	QL6231
Double Stopcock.....	QL6232
Switching Sticks	
11" Switching Stick	T4906-11
14" Switching Stick	T4906
Arthroscopic Portal Rod.....	T490

All products may not be available in all markets.

QuickLatch® Autoclavable 2.9mm Arthroscope

CONMED's 2.9mm Arthroscope offers superior optical performance in a smaller package than a standard 4mm arthroscope. Features include:

- » 2.9mm outside diameter
- » Working length 152mm
- » 100° field-of-view
- » 0°, 30°, 45° and 70° angle-of-view
- » Equivalent light transmission and image size to a 4mm arthroscope
- » Increased depth-of-field and less distortion compared to competitive 4mm arthroscopes
- » Increased durability with new proprietary sheath system

	Eyecup	Cat. No. Cartridge
2.9mm 0°	T2900	
2.9mm 30°	T2930	T2931
2.9mm 45°	T2944	
2.9mm 70°	T2970	T2971

QuickLatch® Sheath System for 2.9mm Arthroscope

A proprietary scope-sheath interface offers better protection of the arthroscope and increased flow efficiency.

- » Smaller outside diameter allows for better maneuverability
- » Scope-sheath interface ensures excellent tip protection
- » Ease-of-use increases efficiency

4.0mm Small Joint Single Stopcock Sheath	T4031
4.0mm Small Joint Double Stopcock Sheath	T4032
4.7mm Arthroscopy Single Stopcock Sheath	T4731
4.7mm Arthroscopy Double Stopcock Sheath	T4732
5.2mm High Flow Single Stopcock Sheath	T4931
5.2mm High Flow Double Stopcock Sheath	T4932
5.2mm Pressure Sensing Single Stopcock Sheath System	T5131
5.2mm Pressure Sensing Double Stopcock Sheath System	T5132
Blunt Obturator	T4901
Conical Obturator	T4902
Sharp Trocar	T4903
Sheath Body O-ring (Replacement), Qty. 2	T4904
Stopcock O-ring (Replacement), Qty. 4	T4908
11" Switching Stick	T4906-11
14" Switching Stick	T4906
Arthroscopic Portal Rod	T4907
Stopcock Locking Nut	T4905
Pressure Sensing Bridge Adapter	T4910
Pressure Sensing Single Stopcock Assembly	T5101
Pressure Sensing Double Stopcock Assembly	T5102
Pressure Sensing Outer Tip Assembly	T5103
Pressure Sensing Stopcock O-ring	T5104
Pressure Sensing Outer Tip Assembly O-ring	T5105
Arthroscopy Sheath Body (Replacement)	T4730
Arthroscopy High Flow Sheath Body (Replacement)	T4930
Pressure Sensing Sheath Body	T5130



QuickLatch® Autoclavable 2.9mm Arthroscope



QuickLatch® High Flow Double Stopcock Sheath

All products may not be available in all markets.



1.9mm Autoclavable Arthroscope



2.5mm Autoclavable Arthroscope

Arthroscopes

CONMED Autoclavable Arthroscopes offer excellent optical performance with state-of-the-art optical systems. Sapphire lenses ensure durability, decreasing costly repairs.

1.9mm Autoclavable Arthroscope

» Working Length 60mm

	Eyecup	Cat. No. Cartridge
1.9mm 0°	T1900	
1.9mm 30°	T1930	T1931

Sheath System for 1.9mm Arthroscope

	Cartridge
2.8mm Sheath	C3101
Blunt Obturator.....	C3102
Conical Obturator	C3103
Sharp Trocar	C3104

2.5mm Autoclavable Arthroscope

» Working Length 72mm

	Eyecup	Cartridge
2.5mm 0°	T2500	T2501
2.5mm 30°	T2530	T2531
2.5mm 70°	T2570	T2571

Sheath System for 2.5mm Arthroscope

	Cartridge
3.5mm Double Stopcock Sheath Kit.....	C3252
3.5mm Double Stopcock Sheath Kit with 30° tip.....	C3252-30
Blunt Obturator.....	C3253
Conical Obturator	C3254
Sharp Trocar	C3255

All products may not be available in all markets.

DoubleLatch® Bridge System

	Cat. No.
10 Replacement Seals for DoubleLatch Cannulas	DL1008
Replacement Cannula Seal Cap	DL1009
Seal Cap Installation and Removal Tool	DL1010
4.6mm DoubleLatch Cannula	DL4601
4.6mm DoubleLatch Cannula with Valve	DL4601V

DoubleLatch® Hip Arthroscopy Bridge System

Single Stopcock DoubleLatch Hip Bridge	DLH100
Double Stopcock DoubleLatch Hip Bridge	DLH200
4.6mm DoubleLatch Hip Conical Obturator	DLH460
4.6mm DoubleLatch Hip Cannulated Obturator	DLH461
4.6mm DoubleLatch Hip Cannulated Obturator with Handle	HPS-H46
4.6mm DoubleLatch Hip Cannula Straight	DLH462
4.6mm DoubleLatch Hip Cannula Fenestrated	DLH463
5.8mm DoubleLatch Hip Conical Obturator	DLH580
5.8mm DoubleLatch Hip Cannulated Obturator	DLH581
5.8mm DoubleLatch Hip Cannulated Obturator with Handle	HPS-H58
5.8mm DoubleLatch Hip Cannula Straight	DLH582
5.8mm DoubleLatch Hip Cannula Fenestrated	DLH583

QuickLatch® Bridge Systems for 4mm Arthroscope

Single Stopcock Bridge	QL6111
Double Stopcock Bridge	QL6112
Pressure Sensing Bridge Adapter	QL6210
Pressure Sensing Bridge Adapter for Extended Length Cannulas	QL6210XL
Scope Cleaning Kit	T0001

Replacement Parts

Blunt Obturator	QL6101
Conical Obturator	QL6102
Sharp Trocar	QL6103
Sheath Body O-ring (Replacement), Qty. 2	T4904
Stopcock O-ring (Replacement), Qty. 4	T4908
Stopcock Locking Nut	T4905
Single Stopcock Assembly	T5801
Double Stopcock Assembly	T5802
Pressure Sensing Single Stopcock Assembly	T5101
Pressure Sensing Double Stopcock Assembly	T5102
Pressure Sensing Outer Tip Assembly	QL6201
Pressure Sensing Stopcock O-ring (replacement)	T5104
Pressure Sensing O-ring, Outer Tip Assembly, Qty. 2	QL6205
Pressure Sensing 5.9mm Sheath Body	QL6230

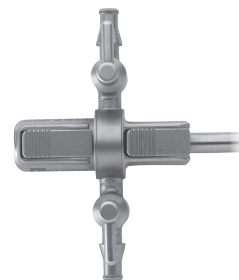

DoubleLatch® Hip Double Stopcock



DoubleLatch® Hip Cannula Straight



DoubleLatch® Hip Cannulated Obturator



4.6mm DoubleLatch® Hip Cannulated Obturator with Handle



QuickLatch® Bridge Systems for 4mm Arthroscope

- Pressure Sensing 5.9mm Sheath Body
- Pressure Sensing Double Stopcock Assembly
- Pressure Sensing Bridge Adapter

All products may not be available in all markets.



Stainless Steel Cannula

Bridge Cannulas

	Cat. No.
4.6mm Stainless Steel Cannula	OC4601
4.6mm Stainless Steel 30°/70° Cannula (for use with T-Series 4mm Arthroscopes).....	OC4606
4.6mm Stainless Steel Fenestrated Cannula.....	OC4607
4.6mm Trocar.....	OC4603
4.6mm Conical Obturator	OC4604
4.6mm Cannulated Obturator (Compatible with CONMED's 2220, T4906, & T4906-11 Switching Sticks)	OC4605
5.8mm Stainless Steel Cannula	OC5801
5.8mm Stainless Steel 30°/70° Cannula (for use with T-Series 4mm Arthroscopes).....	OC5806
5.8mm Trocar.....	OC5803
5.8mm Conical Obturator	OC5804
5.8mm Cannulated Obturator (Compatible with CONMED's 2220, T4906, & T4906-11 Switching Sticks)	OC5805
5.8mm Extended Length Stainless Steel Cannula (compatible with QuickLatch® 4mm Arthroscopes and T4911, T4912, or QL6210LX Bridge Adapters).....	OC5801XL
5.8mm Extended Length Conical Obturator	OC5804XL
7.6mm Stainless Steel Cannula	OC7601
7.6mm Trocar.....	OC7603
7.6mm Conical Obturator	OC7604
7.6mm Cannulated Obturator (Compatible with CONMED's 2220, T4906, & T4906-11 Switching Sticks)	OC7605
Silicone Cannula Seal (latex free), 1 per Package	7557
Infusion Adapter.....	7554

Pressure Sensing Cannula System

For use with the 87k® Fluid Control System and Apex Pressure Sensing tubing sets.

- » Dual cannulation to provide separate fluid inflow and pressure measurement
- » Outer cannula is removable for patient entry and cleaning

5.1mm O.D.	Inner Cannula	Inflow Adapter
3.5" (89mm) length	83255.....	83234
5.0" (127mm) length		83234
Inflow Adapter for 5.1mm O.D. Cannula System (Converts to Luer).....		83234

Replacement Parts for Quick-Connect® Sheath Sets (T5830, T5831, T5832, T5833, T5870, T5871, T5872, and T5873)

Quick-Connect sheaths are compatible with non-QuickLatch® 4mm Arthroscopes.

5.8mm Fenestrated 30° Sheath Body.....	T5834
5.8mm Non-Fenestrated 30° Sheath Body.....	T5835
5.8mm Fenestrated 30°/70° Sheath Body.....	T5874
5.8mm Non-Fenestrated 30°/70° Sheath Body.....	T5875
Single Stopcock Bridge	T5811
Double Stopcock Bridge	T5812
Blunt Obturator.....	T5803
Conical Obturator.....	T5804
Sharp Trocar.....	T5805
Single Stopcock Assembly.....	T5801
Double Stopcock Assembly.....	T5802
Stopcock Lock.....	T5814
Replacement O-ring for Sheath.....	T4908
Replacement Stopcock Nut.....	T4905



Inner Cannula



Inflow Adapter

All products may not be available in all markets.

Ultra High Definition (UHD) Laparoscopes

Upgrade your OR to our next generation of clinical visualization. CONMED's third generation Ultra-High Definition Laparoscopes have features designed to enhance image clarity and sharpness for improved viewing of anatomical structures.

	Cat. No.
5.5mm Standard Working Length, 30 degree, eyecup	UHD5530
5.5mm Standard Working Length, 45 degree, eyecup	UHD5544
5.5mm Extended Working Length, 0 degree, eyecup	UHD5500XL
5.5mm Extended Working Length, 30 degree, eyecup	UHD5530XL
5.5mm Extended Working Length, 45 degree, eyecup	UHD5544XL
10mm Standard Working Length, 0 degree, eyecup.....	UHD1000
10mm Standard Working Length, 30 degree, eyecup.....	UHD1030
10mm Standard Working Length, 45 degree, eyecup	UHD1044
10mm Extended Working Length, 0 degree, eyecup	UHD1000XL
10mm Extended Working Length, 30 degree, eyecup	UHD1030XL
10mm Extended Working Length, 45 degree, eyecup	UHD1044XL



Ultra-High Definition Laparoscopes

All products may not be available in all markets.

Laparoscopes

Autoclavable Laparoscopes offer excellent optical performance with state-of-the-art optical systems. Sapphire lenses ensure durability, decreasing costly repairs.

5.5mm HD Autoclavable Laparoscope

» Working length 325mm

	Eyecup	Cat. No. Cartridge
5.5mm 0°	HD5500	HD5501
5.5mm 30°	HD5530	HD5531
5.5mm 45°	HD5544	HD5545

5.5mm HD Autoclavable Extended Length Laparoscope

» Working Length 450mm

	Eyecup	Cartridge
5.5mm 0°	HD5500XL	HD5501XL
5.5mm 30°	HD5530XL	HD5531XL
5.5mm 45°	HD5544XL	HD5545XL

10mm HD Autoclavable Laparoscope

» Working length 325mm

	Eyecup	Cartridge
10mm 0°	HD1000.....	HD1001
10mm 30°	HD1030.....	HD1031
10mm 45°	HD1044.....	HD1045

2DHD Laparoscope HD

	Cartridge
2DHD Laparoscope HD 5.5mm 0°	8090-01
2DHD Laparoscopic HD 5.5mm 30°	8090-02



**5.5mm Eyecup HD
Autoclavable Laparoscope**



**5.5mm Eyecup HD
Autoclavable Extended
Length Laparoscope**



**10mm Eyecup HD
Autoclavable Laparoscope**



2DHD Laparoscopic HD 5.5mm 0°

All products may not be available in all markets.

Sterilization Trays

VP100X Sterilization Tray Series

CONMED's tray product portfolio will allow you to properly store and reprocess a variety of our 2DHD autoclavable devices that can be used in multi-specialty, minimally invasive surgical procedures. These components include camera heads, scopes, sheaths, bridge systems, cannula's and light guides.

	Cat. No.
Video Extended Length Tray.....	VP1003
» Scopes and Light Guides	
Scopes with an outer diameter not less than 5.5mm or greater than 10mm with lengths no greater than 530mm	
Video Tray Single Level.....	VP1005
» Camera heads, Scopes, Sheaths, Cannula's and Bridge Systems	
Scopes, Sheaths, Cannulas and Bridge Systems with internal diameters no less than 2.3mm, outer diameter not less than 2.3mm or greater than 10mm, and with lengths no greater than 404mm may be sterilized in this tray.	
Video Arthroscopy Tray.....	VP1006
» 2.9mm and 4.0mm Arthroscopes.	
Scopes with diameters no less than 2.9mm or greater than 4mm, with lengths no greater than 233mm may be sterilized in this tray.	
Video Laparoscope Tray.....	VP1007
» 5.5mm and 10mm Laparoscopes.	
Scopes with diameters no less than 5.5mm or greater than 10mm, with lengths no greater than 404mm may be sterilized in this tray.	
3DHD Camera System Tray.....	VP1008
» 3DHD System components including camera heads, scopes and light guide in this two section tray.	
-Bottom will accommodate 3DHD Dual Channel Endoscope, Stereo Endoscope, 2DHD Single Channel Laparoscope.	
-Top portion will accommodate both 3DHD camera head models and 2DHD camera head and light guide.	
3DHD Rigid Scope Sterilization Tray.....	VP1009

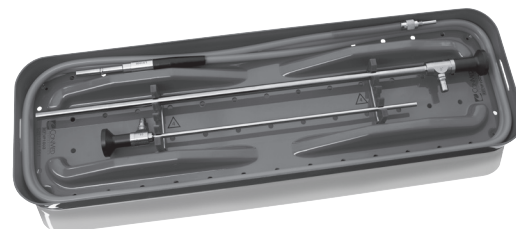

VP1003

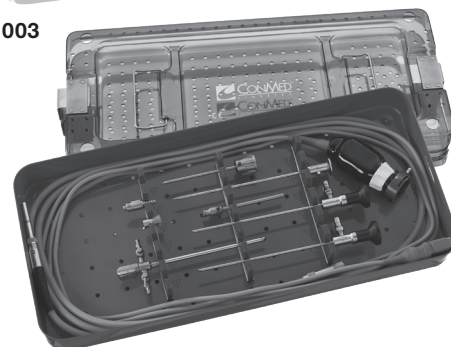

VP1005

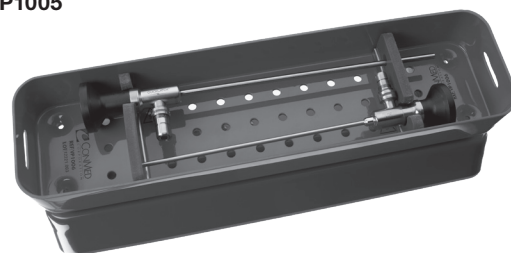

VP1006

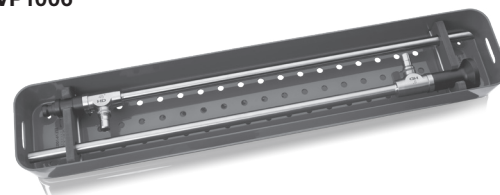

VP1007

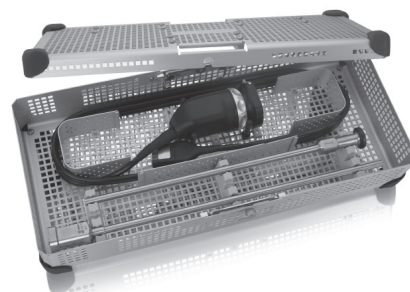

VP1008

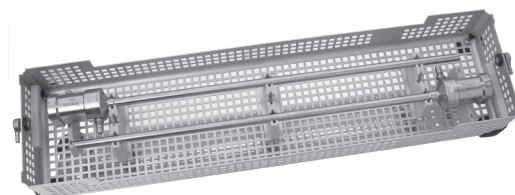

VP1009

All products may not be available in all markets.

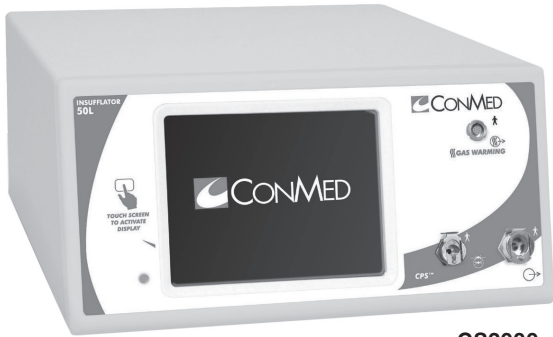

GS2000

50L Insufflation System

Featuring the fastest flow rate on the market, our 50L Insufflation System provides continuous and constant pressure at the surgical site for uninhibited laparoscopic visualization with an intuitive, easy-to-use design.

	Cat. No.
50L Insufflator.....	GS2000
Hose and Yoke for CO ₂ , E-Tank, 4 ft.....	GS1052
DIN477, Hose and Connection for CO ₂ Tank.....	GS202K
DISS Hose for "wall" CO ₂ 2 ft.....	GS1053
Dual Tank Shuttle Valve System.....	GS2050
Power Cord, 155 VAC 6 ft.....	C7104
Power Cord, 230 VAC 10 ft.....	C7105

Cleaning Brushes for Warmer



CO₂ Warmer

CO₂ Warming System

CONMED's second generation warming system safely delivers body-temperature gas in an ergonomic and easy-to-use package. Gas warming is achieved by inserting the small warmer assembly into the gas path near the distal end of a standard insufflation tubing set. The warmer assembly is powered by either CONMED 35L or 40L Insufflator.

- » Safe – Warmer stays cool to touch
- » Cost Effective – Uses standard insufflation tubing
- » Easy-to-Use – Lightweight and ergonomic

CO ₂ Warmer, In-Line, Reusable.....	*GS1012
Cleaning Brushes for Warmer Assembly 10/Pkg.....	GS1054

*Requires insufflation tubing set



CPS™ Tubing Set

CPS™ Continuous Pressure Sensing Tubing Set (Not made with Natural Rubber Latex)

The CPS feature enhances insufflation safety and performance by increasing average flow rate, maintaining stable pressure during gas leaks and eliminating the "breathing effect" during insufflation. Compatible only with the CONMED 40L Insufflator (GS1002).

CPS Tubing Set, Disposable, with Filter.....	GS1013
--	--------

CO₂ Output Adapters for CONMED Insufflators

Standardize to one tubing set with CONMED insufflator gas port adapters. These stainless steel adapters attach to your CONMED 35L or 40L Insufflator to allow use of tubing sets made for CONMED C7000 or C7000A Insufflators. The adapters are non-rotating and include tethers for permanent attachment to CONMED 35L or 40L Insufflator chassis. Order one each of the desired adapter for the GS1000 or two each for the GS1002.

Adapter, CO ₂ Output, CPC to IEC (for C7011 Tubing).....	GS1050
Adapter, CO ₂ Output, CPC to Luer (for C7010 Tubing).....	GS1051

Insufflation Tubing Sets (Not made with Natural Rubber Latex)

CONMED offers three different insufflation tubing sets to meet your standardization needs.

Insufflation Tubing Set, Disposable, CPC to Luer, with Filter.....	GS1016
Insufflation Tubing Set, Disposable, Luer to Luer, with Filter.....	C7010
Insufflation Tubing Set, Disposable, IEC to Luer, with Filter.....	C7011

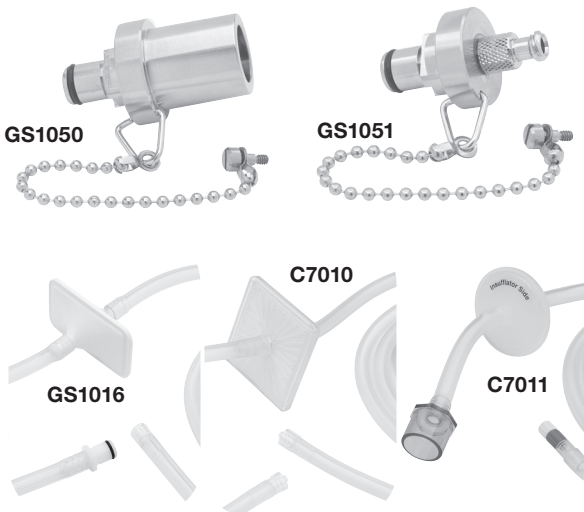

All products may not be available in all markets.

Adapters

	Cat. No.
Cable, 3.5mm to 3.5mm Stereo Remote	IM9001

Replacement Lamps

With Bracket for LS7500	LS7501
With Bracket for LS7600	LS7601
With Bracket for LS7700	LS7701

Cables, DVI-D

DVI-D video cable, DVI to DVI, 6'	IM9021
DVI-D video cable, DVI to DVI, 25'	IM9022
DVI-D to HDMI, 6' 1.8m Replacement	DRS04

Cables, HD-SDI

HD-SDI video cable, BNC to BNC, 3'	IM9010
HD-SDI video cable, BNC to BNC, 6'	IM9011
HD-SDI video cable, BNC to BNC, 25'	IM9012

Cables, "S" Video

6' "S" Cable	8149-06
--------------------	---------

Drapes

9 x 95" Camera Drape, Qty. 10 (latex free product)	9707
5 x 95" Camera Drape, Qty. 10 (latex free product)	60-3950-031

Power Cords

3' Power Cord, 115V	C7104-3
6' Power Cord, 115V	C7104
10' Power Cord, 230V	C7105

Print/Ink Sets

	Cat. No.
Print/Ink Set, for C3149 (200 Prints)	C3271
Print/Ink Set, for VP2721 (200 Prints)	VP2722
Print/Ink Set, for VP2750, VP2755 (200 Prints)	VP2751
Print/Ink Set, for UPDR80MD, Letter	UPC-R81MD
Print/Ink Set, for UPDR80MD, A4	UPC-R80MD

VP8501 Power Cords

15 foot country-specific power cords for connecting the VP8501 to a power source.

Continental Europe Wall Plug	VP8552
Argentina Wall Plug	VP8553
Denmark Wall Plug	VP8555
India Wall Plug	VP8556
Italy Wall Plug	VP8557
Switzerland Wall Plug	VP8558
UK Wall Plug	VP8559
North American Wall Plug	VP8560

Scope Cleaning Kit

Replacement Aluminum Oxide Powder	T0001
---	-------



Advanced Visualization System™ Product Catalog

525 French Road
Utica, New York 13502

Local 727-392-6464
Toll Free 1-800-237-0169

CONMED.com
customer_service@CONMED.com