



## Cabinets e-RTU2020-2S and e-RTU2020-4S

### Installation and operating guide



4PR-F14-D

## General

### - Before unpacking

- > Verify that the product in its packaging has not been damaged during transport.
- > Verify that the product is suitable for the intended installation.

### - Before installation

- > Carefully read this guide before installing or using this product.
- > While carrying out the installation, ensure that the equipment remains clean throughout the operation.

### - After installation

- > If you are installing this product for someone else, leave the guide for the end user.
- > Clean the work area after installation.

## Legal notices

- The product may only be installed by a competent person with adequate training in installation practices and with adequate knowledge of proper safety and installation practices for electrical equipment. If local regulations have requirements relating to this training or adequate knowledge in terms of the installation of electrical equipment, the aforementioned requirements must be complied with by this person.

- Ensto Novexia declines all liability for any property damage or personal injury caused by poor installation, mishandling, or failure to comply with safety recommendations.

### **WARNING**

For the operation of this system in complete safety, it is essential that installers, users and technicians follow the procedures and precautions described in this guide. Non-compliance with these instructions may cause damage to the products and/or serious or even fatal injury.



## CONTENTS

1	PRESENTATION.....	6
1.1	PRODUCT PURPOSE.....	7
1.2	GENERAL CHARACTERISTICS.....	7
1.2.1	General.....	7
1.2.2	Overview of the product:.....	10
1.2.3	Description of the card rack:.....	11
1.2.4	Description of the user interface (UI):.....	12
1.2.5	Description of the wiring board.....	14
1.2.6	Access levels:.....	15
1.3	MECHANICAL SPECIFICATIONS.....	17
1.3.1	Characteristics:.....	17
1.3.2	Rating plate:.....	17
1.3.3	Identification of electronic circuit boards:.....	18
1.4	LIST OF EQUIPMENT REQUIRED FOR INSTALLATION (SUPPLIED depending on order).....	18
1.4.1	Battery:.....	18
1.4.2	Current sensors and connecting cable:.....	19
1.4.3	Capacitive voltage sensors and connecting cable (if directional detection):.....	19
1.4.4	Radio antenna and holder (only useful for the RADIO version):.....	21
1.4.5	Cabinet mounting element:.....	21
1.4.6	PC:.....	21
1.4.7	Ethernet Cable:.....	21
1.4.8	Tools:.....	21
2	INSTALLATION.....	22
2.1	UNPACKING AND HANDLING INSTRUCTIONS.....	23
2.2	INSTALLATION OPERATIONS.....	23
2.3	EXTERNAL CONNECTIONS.....	25
2.3.1	Identification of grommets and connectors:.....	25

2.3.2	Connections: .....	27
2.4	EARTHING INSTRUCTIONS.....	33
3	COMMISSIONING.....	34
3.1	POINTS TO BE CHECKED BEFORE COMMISSIONING.....	35
3.1.1	Visual inspection.....	35
3.1.2	Setting up the configuration PC .....	35
3.2	LIST OF COMMISSIONING OPERATIONS .....	39
3.2.1	Product power supply:.....	39
3.2.2	Configuration by PC.....	39
3.3	OPERATIONAL TESTS .....	47
4	OPERATION .....	50
4.1	FUNCTIONS .....	51
4.1.1	Power supply unit function .....	51
4.1.2	Switch command function .....	54
4.1.3	Fault detection function .....	54
4.1.4	ASF function .....	56
4.1.5	APSS function .....	58
4.2	COMMANDS, TESTS, CONFIGURATIONS.....	60
4.3	METHOD FOR USING THE PC INTERFACE .....	61
4.3.1	Available tabs depending on the user level .....	62
4.3.2	Visualization Tab.....	63
4.3.3	Fault Tab.....	65
4.3.4	Measurements and Counters Tab .....	67
4.3.5	Inputs / Outputs Tab .....	69
4.3.6	Events tab .....	70
4.3.7	Local Command Tab .....	70
4.3.8	Downloading Tab .....	71
4.3.9	IP Analyzer Tab .....	72
4.3.10	IP Traces Tab .....	72
4.3.11	Communication and Protocols Tab.....	72
4.3.12	Automation Tab.....	75

4.3.13	Fault Detection Tab.....	77
4.3.14	Delays and Alarms Tab .....	79
4.3.15	Cyclic measurement recording tab.....	80
4.3.16	Analog Input Tab.....	81
4.3.17	I/O Label Tab.....	83
4.3.18	SPI Fault Grouping Tab .....	84
4.3.19	Maintenance Tab .....	86
4.3.20	Administrator Settings Tab (Administrator user only).....	88
4.3.21	System Tab.....	90
5	MAINTENANCE .....	91
5.1	PREVENTIVE .....	92
5.1.1	IP analyzer .....	92
5.1.2	IP traces.....	93
5.1.3	Visualization of Dated Recorded Maintenance Events (DRME): .....	93
5.1.4	Fault display .....	105
5.1.5	CPU2020 firmware update: .....	106
5.2	CORRECTIVE .....	107
	Accessing the converter/charger boards .....	108
	Removing the converter/charger boards.....	109
	Inserting converter/charger boards.....	110
6	TECHNICAL SUPPORT .....	112
7	END OF PRODUCT LIFE .....	113



# 1 PRESENTATION

1.1. Product purpose

1.2. General characteristics

1.3. Mechanical specifications

1.4. List of equipment required for installation  
(not supplied by Ensto Novexia)



## 1.1 PRODUCT PURPOSE

The e-RTU2020-2S & e-RTU2020-4S versions combine all the functions required to manage a MV sub-station in a compact unit. Combining the equipment with MV circuit breakers makes the electrical network more reliable.

## 1.2 GENERAL CHARACTERISTICS

### 1.2.1 General

The product enables instrumentation and control of 2 (e-RTU2020-2S) or 4 (e-RTU2020-4S) motorised circuit breakers. In addition, it is equipped with functions for remote communication, acquisition of analogue values, fault detection and automated system.

The parameters below can be viewed and/or programmed either on the local panel on the front of the e-RTU2020 cabinet, or on a PC. For additional details, see § 4.2.

- **Remote communication with the control station (Scada):**

By default, the cabinet incorporates the standard protocols for communication with control stations (IEC 104/101, DNP3 IP/serial, MODBUS RTU/IP, etc.)

With its 3 Ethernet ports and 2 UARTs, the e-RTU2020 enables all modern communication media (IP or serial) to be used with the control station – SCADA – (XG modem, ADSL or fibre optic routers, IP radio, digital radio, etc.)

It enables several media to be used simultaneously (communication redundancy)

- **Control of MV circuit breakers:**

In remote or local mode, it is possible to independently operate 1 to 4 motorised MV circuit breakers. In addition, the operation of circuit breakers can be controlled by automated systems (ASF or APSS). The position of circuit breakers is accessible locally via the user (UI) and PC interfaces.



- **Acquisition of analogue values:**

The cabinets measure the following MV network values:

- Measurement of instantaneous currents for all channels
- Calculation of current averaged for all channels over X minutes (configurable value)
- Saving of maximum instantaneous current for all channels
- Measurement of instantaneous MV voltage
- Calculation of MV voltage averaged over X minutes (configurable value)
- Cyclic measurement recording in a file (configurable measurements and frequency)

The product measures the following information in real time:

- LV supply voltage
- Voltage and current relating to the 12 V internal and 12 V radio power supply
- Voltage and current of the 48 V voltage source
- Internal temperature of the cabinet
- External temperature (PT100) for external T° or transformer measurement
- Measurement originating from a 4-20 mA or 0-10 V external sensor for measuring the water level, SF6 pressure, etc.

- **Visualisation of the cabinet status and information relating to the MV network:**

The following information is displayed on the front panel of the product or on the PC:

- Position of the MV switch
- Switch status (neutralised - manual mode - or unlocked)
- Number of operations per channel
- Cabinet 12V, 48V voltage and supply voltage out of range
- Battery fault
- Internal fault
- Local or remote modes
- Automated system (ASF & APSS) status
- Date and time

- **Detection of MV faults:**

Overcurrent on 2 to 4 channels: single-phase fault, double faults, poly-phase faults, in accordance with specification "**HN 45-S-50**" of February 2011

Directional on 2 to 4 channels: red single-phase fault, green single-phase fault, poly-phase fault in accordance with specification "**HN 45-S-51**" of February 2011

Fault counters: Polyphase / double & single-pole

Fault indication on the user interface depending on the type of detection (see §4.2)





- **Automated systems:**

Auto-Sectionalising Function (ASF) equating to opening the MV switch in the event of a downstream fault during the source unit resetting cycles.

Automatic Power Supply Switching (APSS) allowing a voltage source that has become inactive to be swapped for an active voltage source

- **Recording of Dated Events (RDE):**

All the cabinet events (opening, fault detection, etc.) can be consulted or downloaded in .csv format using the PC interface (DRME).

The .csv files can be directly exported into excel

- **Power supplies:**

AC voltage 230 V  $\pm$  15 % (originating from the MV 20 kV network) or 172.5 V  $\pm$  15 % (originating from the MV 15 kV network)

Sealed lead battery 12 V 38 Ah (autonomous supply).

Possible compatibility with other network voltages (on request)



## 1.2.2 Overview of the product:

The e-RTU2020 cabinet is divided into several sub-assemblies accessible at different access levels

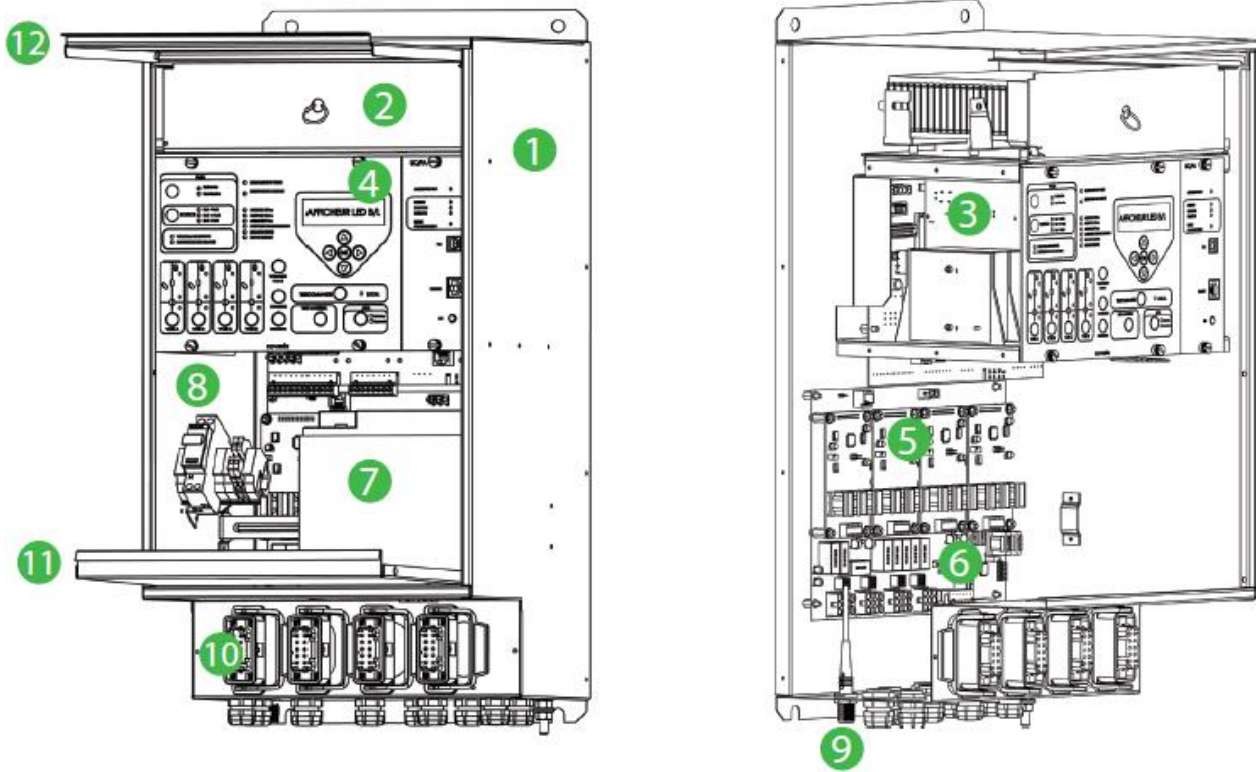

1. Cabinet metal enclosure
2. Space reserved for communication equipment (XG modem, Radio, IP router, etc.)
3. Card rack containing the LV transformer, the power supplies, the CPU and the modem card.
4. User interface (UI)
5. Line and fault current acquisition modules
6. Wiring board (contains the current acquisition modules, external inputs/outputs and the residual MV voltage measuring unit)
7. 12 V battery (autonomous supply)
8. Connection space for alternative power supply
9. Radio interface: Radio antenna connection area
10. Connection area for the electrical control interface connectors (1 to 4 channels)
11. Lower door
12. Upper door



### 1.2.3 Description of the card rack:

The rack comprises 6 functional units highlighted in the diagram below:

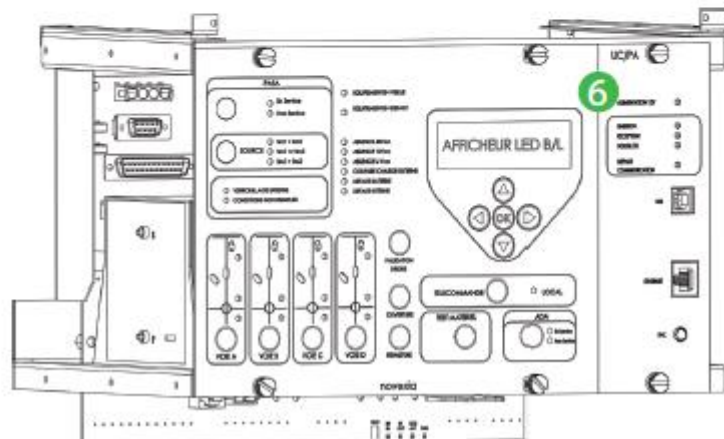
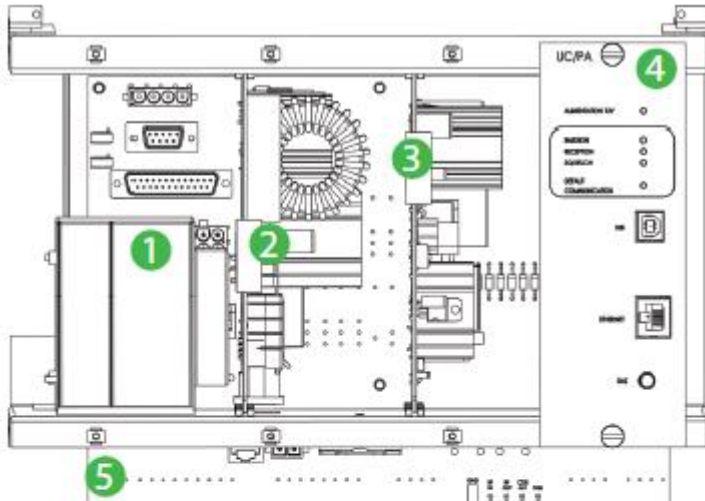

- 1- Product power supply transformer.
- 2- 48 V voltage module: Provides the power needed for motorised operation of the circuit breakers
- 3- 12 V voltage module: Charges the battery and provides the cabinet's internal and external power supply. The module also has automatic protection for the battery and loads (internal and external).
- 4- CPU2020 module: Supervises all equipment.
- 5- Motherboard: positioned on the back panel, provides the interface for the equipment's internal and external connections (cards, cables, etc.).
- 6- User interface: Allows the user to exchange information with the product (display and/or adjustment of certain cabinet parameters).



## 1.2.4 Description of the user interface (UI):

The user interface is available in the cabinet at access level 1. It allows the user to configure and/or display certain equipment parameters.

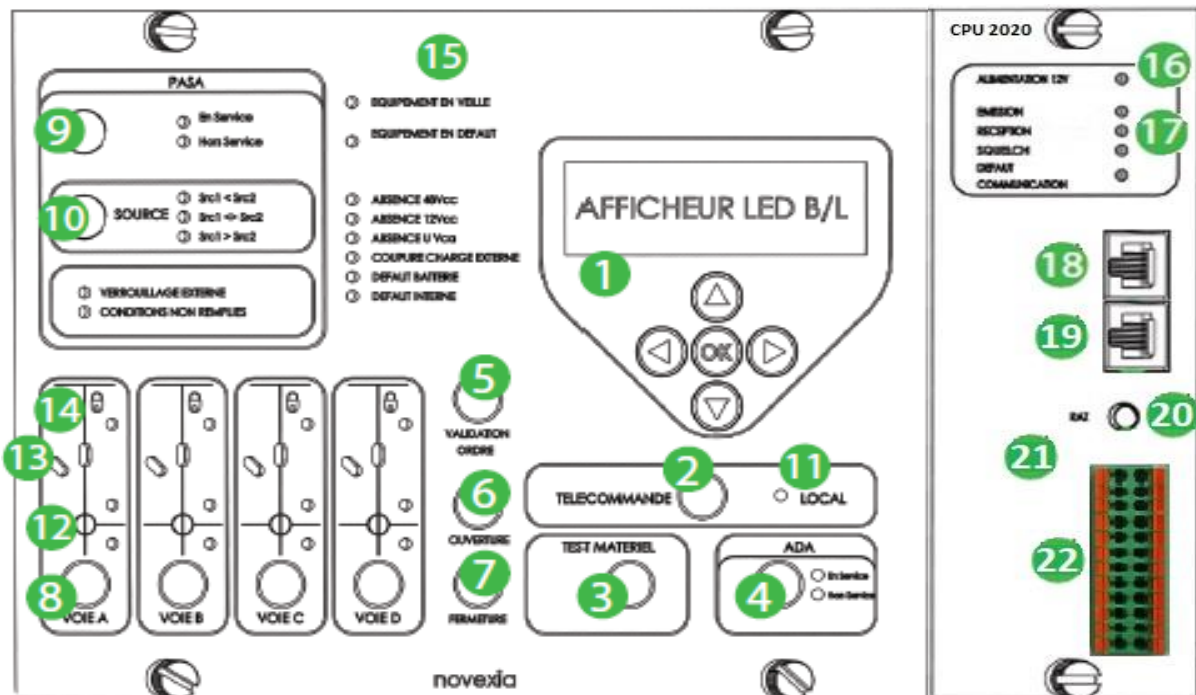

1. **Display/navigation button module:** Display and/or configuration of product information.
2. **Remote control button:** Selects local or remote mode.
3. **Equipment test button:** Lights up all of the lights to check their proper operation.
4. **ASF button:** Turns the automated systems (ASF) on/off.
5. **Command validation button:** Use in parallel with the open/close & ASF buttons
6. **Open button:** Controls opening of the selected channel
7. **Close button:** Controls closing of the selected channel
8. **Channel selection buttons:** Selects the channel to be controlled
9. **APSS button:** Turns the automated systems (ASF & APSS) on/off.
10. **Source button:** Selects the automatic switching direction (APSS)
11. **Local indicator light:** Local mode active if lit
12. **MV fault indicator lights:** Image of green and red MV fault single remote signals
13. **Position indicator lights:** Position (open, closed or invalid) of the circuit breaker connected to the channel
14. **Neutralisation light:** The flashing light indicates neutralisation of the circuit breaker connected to the channel
15. **Cabinet status indicator lights**



- Equipment on standby: flashing green indicates normal operation of the cabinet
- Equipment fault: Lit up red indicates a fault. Refer to the following LEDs
- No 48 V DC: indicates a lack of 48 V voltage
- No 12 V DC: indicates a lack of 12 V voltage
- No AC voltage: indicates a lack of AC power supply voltage
- External load outage: Indicates that the power supplies for external loads are cut off
- Battery fault: Indicates a battery fault
- Internal fault (connect the PC to analyse the fault)

16. **12 V power supply indicator light:** Lit if the cabinet is supplied with power

17. **Communication indicator lights:** Indicates the traffic present on the communication device.

18. **ETHERNET Configuration Port:** Provides access to the PC interface.

Address 192.168.10.1 (static)

19. **ETHERNET Extension Port:** Allows external equipment or a second IP communication medium to be connected.

Address 220.220.0.1 (modifiable)

20. **ETHERNET Communication Port (on the back of the CPU):** Allows an IP communication medium to be connected. The Ethernet cable is offset towards the area reserved for communication media (see §1.2.2).

Address 192.168.0.1 (modifiable)

21. **Reset button:** Peripheral reset, SPI fault reset, charger fault reset

22. **I/O connector:** Temperature measurement (PT100), 4-20 mA / 0-10 V sensor, user inputs and outputs (dry contacts)

Wiring:

PT100 (red)	2	1	PT100 (red)
PT100 (white) / 0 V	4	3	4-20 mA / 0-10 V analogue input
Common 0 V	6	5	Digital input 1
Common 0 V	8	7	Digital input 2
Common 0 V	10	9	Digital input 3
Common 0 V	12	11	Digital input 4
Common 0 V	14	13	Digital input 5
Common 0 V	16	15	+12 V
NC (Isolation)	18	17	NC (Isolation)
RELAY1 (CONTACT1)	20	19	RELAY1 (CONTACT2)
RELAY2 (CONTACT1)	22	21	RELAY2 (CONTACT2)
RELAY3 (CONTACT1)	24	23	RELAY3 (CONTACT2)

The user Input and Output Labels are fully configurable by means of software



## 1.2.5 Description of the wiring board

The wiring board supports the current acquisition modules. It allows the circuit breakers to be operated, the residual MV voltage to be measured, the MV presence to be provided and external inputs/outputs to be controlled (urgent fault, switching in progress, etc.).

The MV voltage sensors must be connected directly to it and the current sensors to the related current acquisition module (channels A to D).

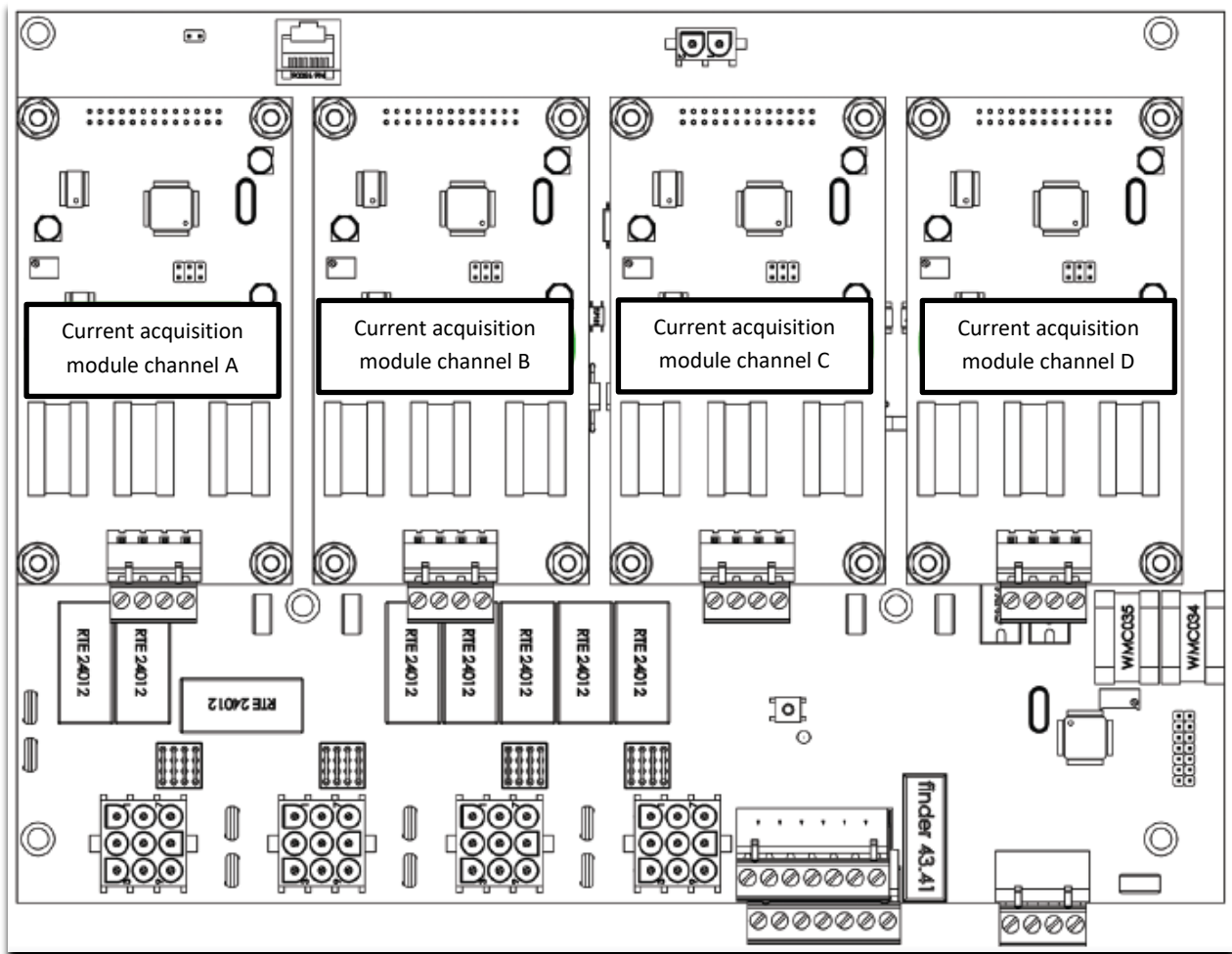

NB.: Channels C & D are only present for type 4S.



## 1.2.6 Access levels:

The cabinet has three access levels defined as follows:

**Level 0: On:** The cabinet is closed and the user interface is visible but inaccessible. The upper part of the cabinet is padlocked (not supplied by Novexia).

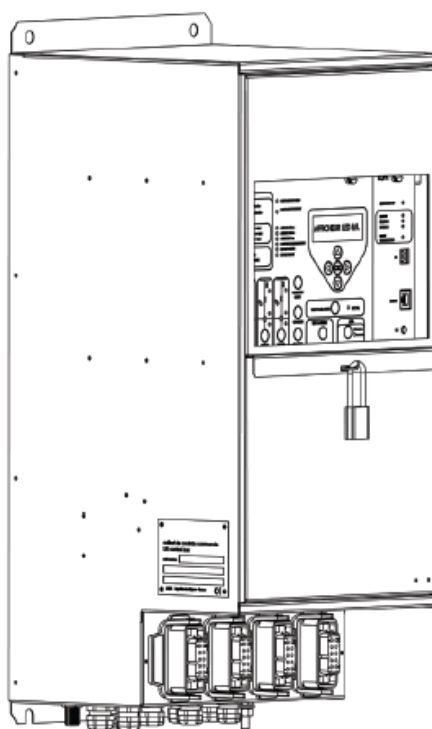
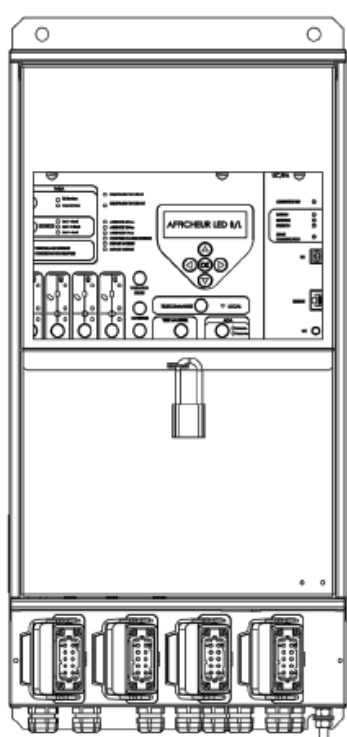



**Level 1: Operation:** access for operating personnel. Only the user interface (UI) is accessible. The upper part is locked using two seals.

At this level, it is possible to operate the circuit breakers locally, view the status of the cabinet and connect the configuration PC.

To open the cabinet, release the upper door by raising it then slide it into the upper section.

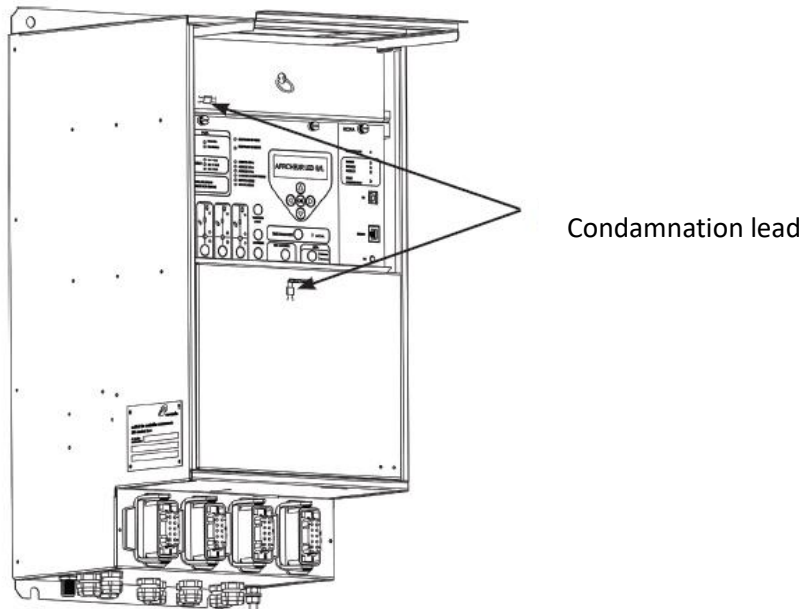

**Level 2: Maintenance:**

access for maintenance technicians (complete accessibility).

At this level, it is possible to work on each element of the cabinet (electronic circuit boards, battery, cables, etc.) to carry out maintenance or troubleshooting operations.

To release the lower door, pull the lower door towards you. It is possible to remove this door for improved access to the battery and to facilitate wiring

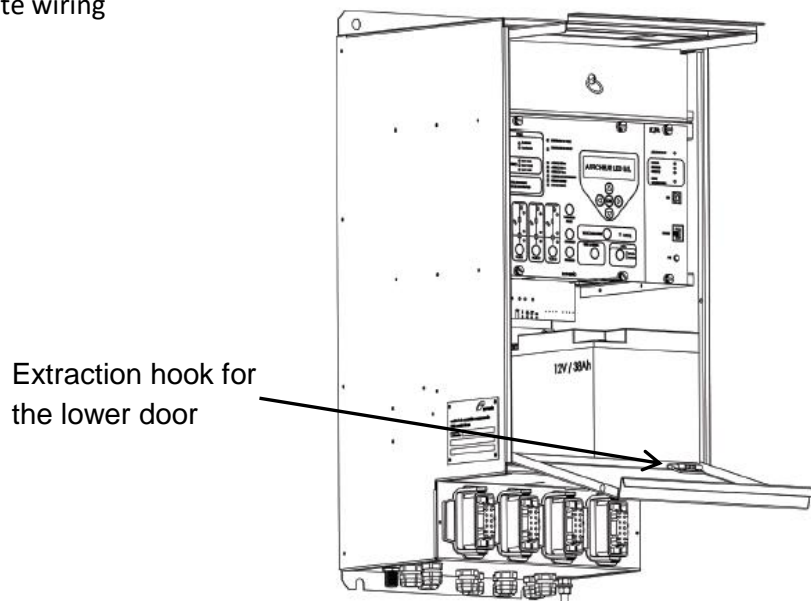





## 1.3 MECHANICAL SPECIFICATIONS

### 1.3.1 Characteristics:

Dimensions	H x W x D	650 mm x 310 mm x 330 mm
Dimensions with door open	H x W x D	650 mm x 310 mm x 600 mm
Weight		38 kg
Enclosure materials		Galvanised steel
	1 mm-thick galvanised sheet	
Protection rating		IP2XC for access level 0 and IP2X for access level 1
Mechanical impacts		IK10
Mechanical vibration	In accordance with NF EN 60068-2-6	(10Hz to 500Hz 2g or 0.15mm peak-to-peak)
Resistance to saline mist	NF EN 60068-2-11	Exposure 178 h
Earthquake resistance	NF 60255-21-3	Class 2
Operating temperature		-15°C to +55°C
Storage temperature		-25°C to +70°C

The mounting plate has four holes with a diameter of 12 mm, spaced at 250 mm x 630 mm, allowing it to be mounted.

### 1.3.2 Rating plate:

An easy to read external plate allows the cabinet to be identified.

**It contains the following details (e.g. cabinet e-RTU2020-4S + 4 detectors)**

- Ensto product code
- The product's date of manufacture Year - Week
- Serial number
- Compliant with HN 64-S-44 Version F dated March 2012
- Type of equipment: e-RTU2020
- Commercial name: e-RTU2020-2S or e-RTU2020-4S

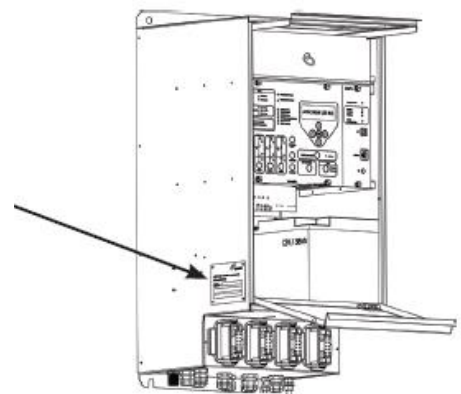

4PR-F14-D



### 1.3.3 Identification of electronic circuit boards:

Each electronic circuit board is identified by a serial number and its type. The information for each board (serial number and type) appear on a plate inside the lower door.

Example:

2009725 CABINET e-RTU2020 Underground: e-RTU2020-4S No. 00106					
Board Name	Novexia code	Serial no.	Board Name	Novexia code	Serial no.
CPU2020 board PR236 V1.0 PR241 V1.0	2009612-14		Wiring board PR167 V1.3	2005412-14	
Converter board	2004995-08		current acquisition PR149 V1.2	2005158-08	
Charger card PR142 V1.2	2004993-08		current acquisition PR149 V1.2	2005158-08	
Motherboard	2005023-08		current acquisition PR149 V1.2	2005158-08	
4 channel display board: PR144 V1.2	2005009-04		current acquisition PR149 V1.2	2005158-08	
<b>Novexia after-sales service: +33 (0)6 16 66 46 43 / +33 (0)6 08 93 26</b>					

## 1.4 LIST OF EQUIPMENT REQUIRED FOR INSTALLATION (SUPPLIED DEPENDING ON ORDER)

### 1.4.1 Battery:

The batteries used in operation meet the following criteria:

- Stationary lead, sealed type with valve according to NF EN 60696-21 and 22
- Maximum dimensions: 195mm x 160mm x 170mm
- Initial capacity: 38 Ah
- Connection via type M5 insulated threaded ring terminals



**Note:** The cable connecting the battery to the equipment and the retaining strap are included in the product's bag of accessories.

If there is no LV voltage, the battery enables power to be supplied to the cabinet. In addition, the battery provides the power required to motorise the circuit breakers during an operation.



**Only batteries approved by ENSTO Novexia can be used.**

#### 1.4.2 Current sensors and connecting cable:

The 500/1 ratio sensors take instantaneous measurements of the three MV line currents to detect faults and to acquire the analogue values.



**Only current coils and connecting cables approved by Ensto Novexia may be used.**

The current coils used have the characteristics listed below:

- Compliant with standard NF EN 60044-1
- Power: 1.5 VA
- Precision class: 3
- Rated load: 1.5 Ohm
- Primary rated current: 500 A
- Secondary rated current: 1 A
- Rated transformation ratio: 500/1
- Rated usable frequency: 50 Hz to 500 Hz
- Rated thermal short-circuit current: 12500 A for 1 sec
- Secondary dielectric strength: 4 kV 50 Hz 1 minute in common mode 5 kV 1.2/50  $\mu$ s in common and differential mode



Connecting cable specifications:

- Copper cross section:  $\geq 1.5 \text{ mm}^2$
- Number of conductors: 4
- Cable type: U-1000 R 02V
- Length: 2, 5, 10 or 15 m
- Connector type: MATE N LOCK 2

#### 1.4.3 Capacitive voltage sensors and connecting cable (if directional detection):

The transducers measure the individual MV voltages to detect directional faults and the presence of voltage.



**Only PPACS connectors and connecting cables approved by Ensto Novexia may be used.**



The PPACS installed comply with specification HN 52-S-63.

Connecting cable specifications:

- Number of conductors: 4
- Length: 7 or 12 m
- Connector type: HARTING (Han Q5/0)

Calibration of the voltage acquisition module allows for the acknowledgement of head capacitors with capacities of between 0.7 pF and 3.3 pF for MV voltages of between 15 kV and 20 kV. The sampling method is described in §3.2.

**The e-RTU2020 cabinet has the option of being connected to the secondary windings of MV/100 V voltage transformers.**

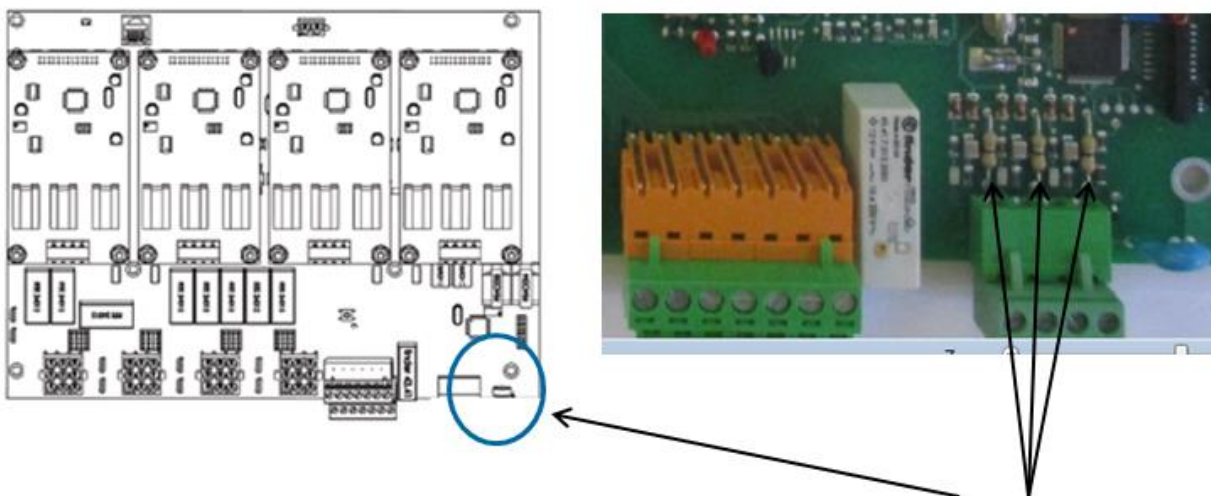

To do this, you need to use suitable wire cutters to cut away the 3 standard resistors at the bottom right of the wiring board. Therefore, the calibration method is identical to that described above and presented in §3.2.



**Take care not to damage the electronic circuit board when performing this operation. For increased safety and convenience, it may be necessary to remove the electronic circuit board to perform this operation.**



#### 1.4.4 Radio antenna and holder (only useful for the RADIO version):

Install a compliant communications antenna.

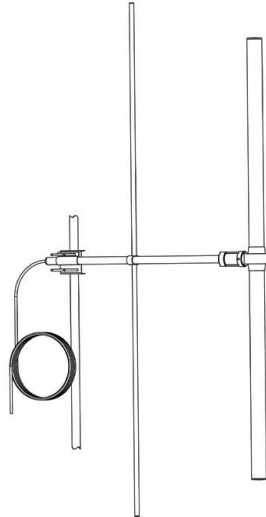

#### 1.4.5 Cabinet mounting element:

The equipment is attached using 4 type M10 screws for good mechanical adhesion to the wall (not supplied by Novexia).

#### 1.4.6 PC:

A PC is needed to commission the cabinet.

The PC used must use an OS no earlier than Windows 7, an Ethernet connection and a standard web browser (Microsoft Edge, Mozilla FireFox, Google Chrome, etc.).

#### 1.4.7 Ethernet Cable:

An RJ45 straight Ethernet cable (standard, commercially available cable) is required to connect the PC to the cabinet (not supplied with the cabinet).

#### 1.4.8 Tools:

Only standard tools are required to install the product:

- Flat screwdriver for the screw connectors
- Philips (cross-head) screwdriver for positioning the Harting connector
- Flat spanners (13) to secure the cabinet to its rail



## 2 INSTALLATION

- 2.1. Unpacking and handling instructions
- 2.2. Installation operations
- 2.3. External connections
- 2.4. Earthing instructions



## 2.1 UNPACKING AND HANDLING INSTRUCTIONS

On receipt of the cabinet, check that the equipment matches the product requested. An identification label is fixed to the outside of the packaging.

Check the contents of the package against the order

- Cabinet
- Bag of accessories containing
  - Battery strap
  - Battery cable
  - Replacement fuses: 12 V internal (Radio) and 48 V
  - Installation and operating guide
  - Battery installation guide

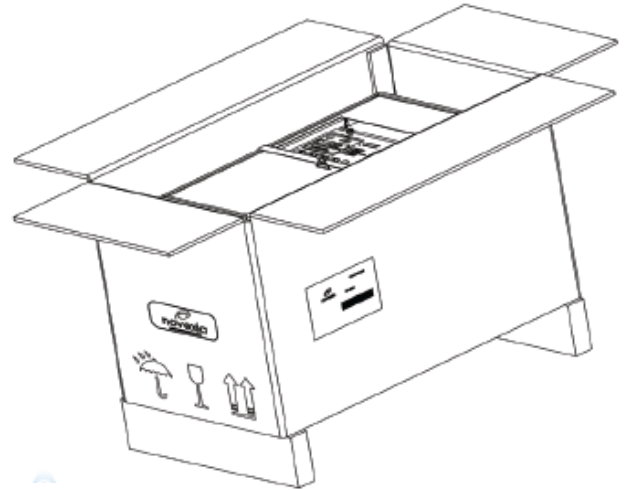

**It is preferable to assign two people to the product installation task.**

No specific tools are needed to open the packaging.



**Store the cabinet indoors at a temperature between -25°C and +70°C**

## 2.2 INSTALLATION OPERATIONS

Four steps are needed to attach the cabinet to the rail:

**Step 1:** Drill four holes in the wall in accordance with the mounting distances.

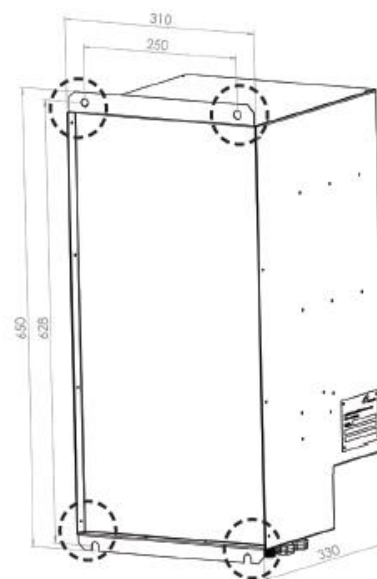



**Step 2:** Place the wall plugs in the holes in the wall.

**Step 3:** Position the cabinet so that the holes in the wall are facing the mounting holes.

**Step 4:** Attach the cabinet using four type M10 screws.

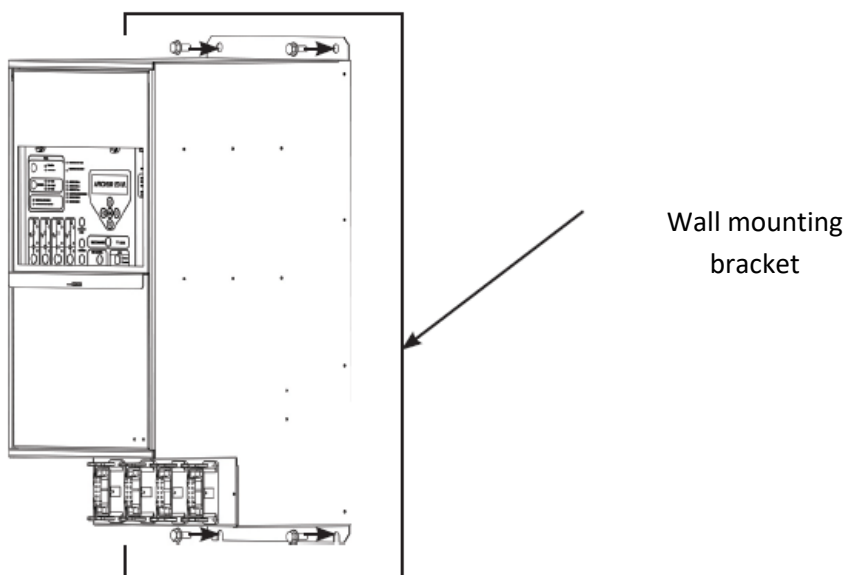





## 2.3 EXTERNAL CONNECTIONS

### 2.3.1 Identification of grommets and connectors:

The purpose of these assembly drawings is to facilitate connection of the external elements to the product (battery, current sensor, communications, etc.).

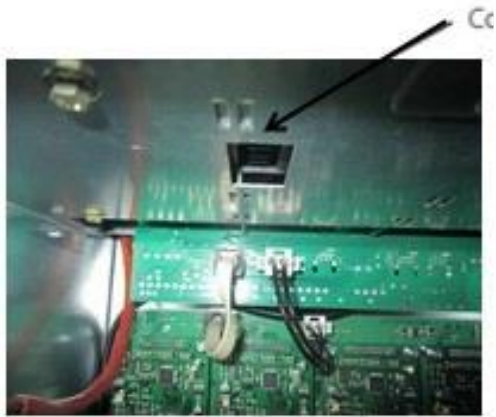

Battery connector

Power fuse holder

HTA switch connectors

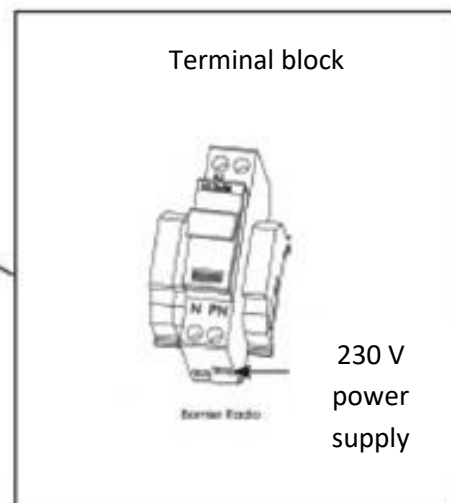
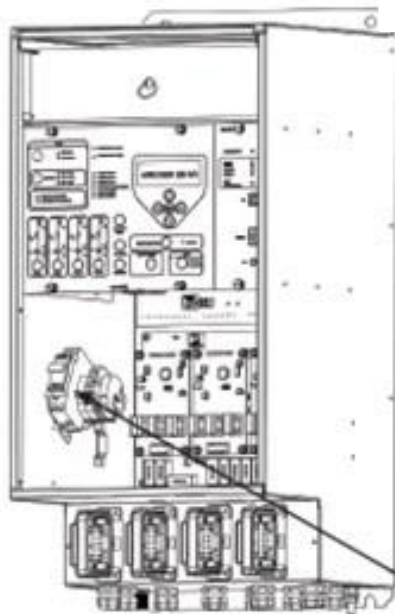
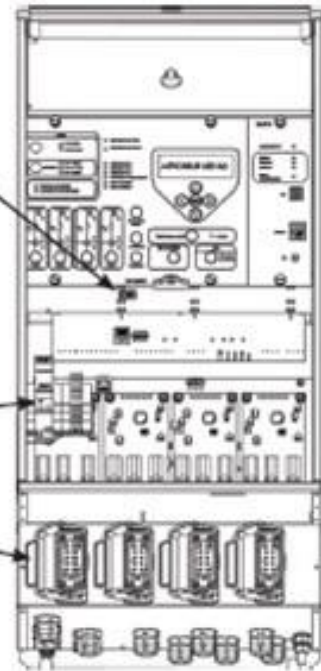



- 1- Radio antenna interface (for Radio versions)
- 2- Current sensor channel A connecting cable grommet
- 3- Current sensor channel B connecting cable grommet
- 4- Current sensor channel C connecting cable grommet
- 5- Current sensor channel D connecting cable grommet
- 6- 230 V power supply cable grommet
- 7- Communication cable grommet
- 8- Voltage sensor connecting cable grommet
- 9- Grommets for external single remote signalling, switching in progress, reserved connections, etc.

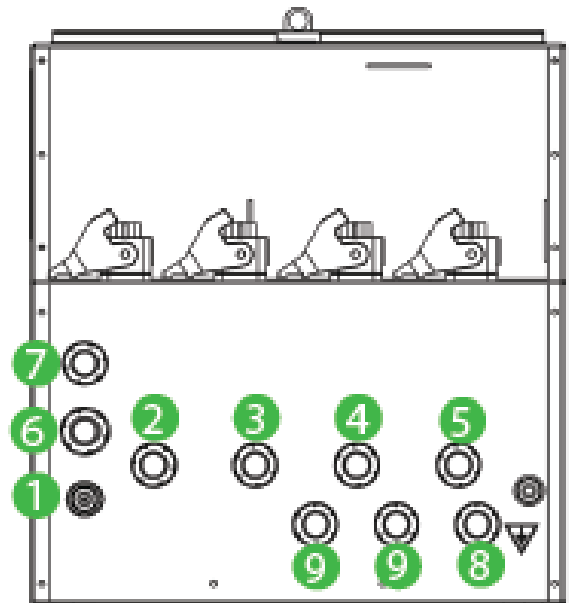

Connectors current sensor link

External connector grouping: external TTS (urgent, non-urgent defect, water level alarm and PASA exterior lock)  
Potential free contact permutation in progress  
Reserve entry

PPACS voltage sensor link connector

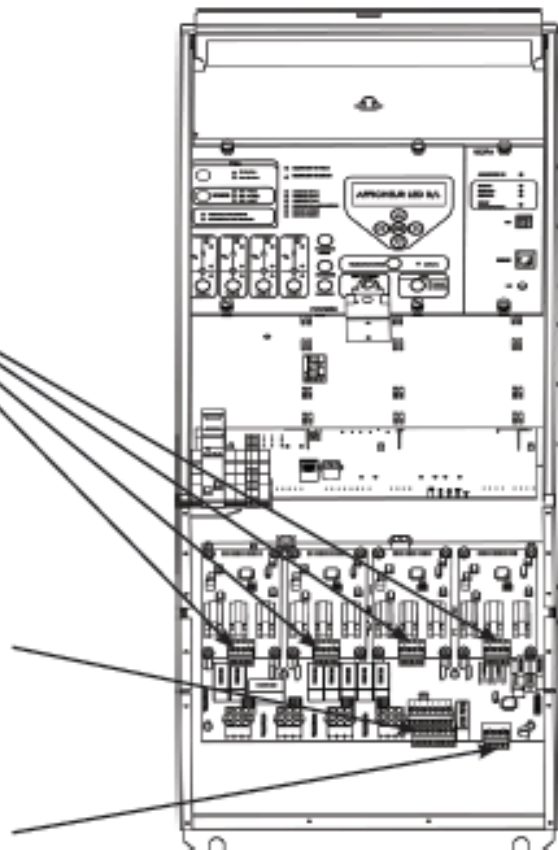

Note: For the e-RTU2020-2S version only two "HARTING" type connectors and two current acquisition modules are installed on the product.



## 2.3.2 Connections:

To facilitate the connection of external elements, refer to § 2.3 “Identification of grommets and connectors”.

### a) Cabinet power supply

The cabinet being at access level 2, remove the power supply fuse.

Then insert the power supply connection cable into the dedicated grommet.

To complete this operation, connect the cable to the **power supply connector** (neutral on the left & phase on the right).

Place the fuse back in its housing without closing the fuse holder

U1000 R2V  
Power supply cable

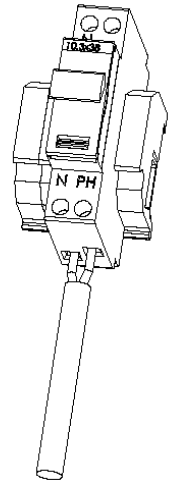

### b) Transmission via communication (IP router, RADIO – GSM/GPRS – external RTU, etc.)

**Note:** The data cable and the radio power supply cable are pre-connected in the factory depending on the type of communication base required.

1- Pull out the metal communication drawer.

2- Attach the communication system to the base.

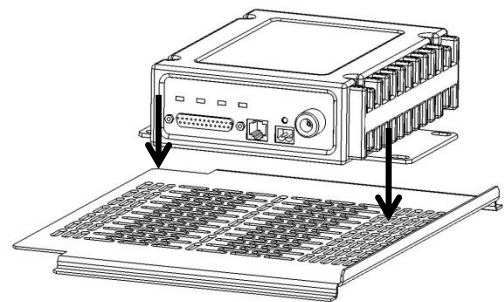

3- Connect the equipment **power supply** cable to the connector provided.



4- The **data cable** (serial protocols) is already connected to the 25-pin connector on the motherboard. If this cable is not suitable for your communication equipment, you can modify it in line with the following diagram.

>>>>>> 9-pin **female** DATA cable or 9-pin **male** DATA cable depending on the circumstances.

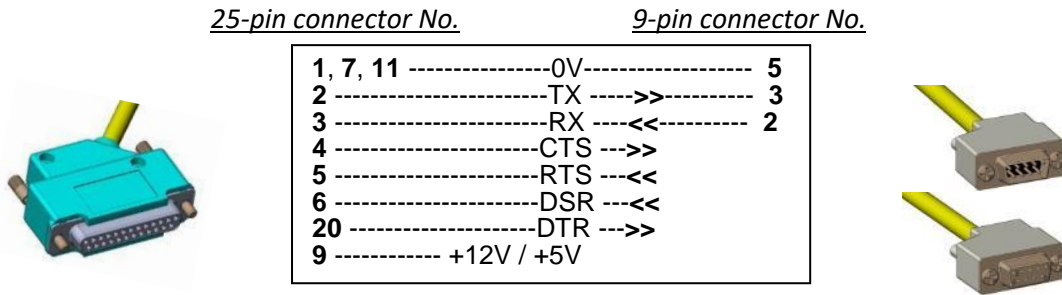

For an IP base, the Ethernet cable is pre-connected to the Ethernet Communication port (Eth0) on the CPU2020 board.

5- Connect the radio or the XG modem to the antenna connector

6- Put the drawer back in place.

To complete mounting, connect the **radio antenna interface** to the communications antenna.

### c) Current sensors (coils):

The installation method for current sensors is similar for all channels (A to D).

Insert the coil connection cable through the specific grommet for the channel.  
Fasten the green connector on the current acquisition module to the end of the coil connection cable while clearly respecting the position of the blue wire (on the right)

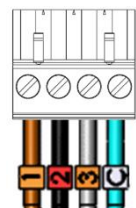

Connect the connector to the current board.  
Tighten the grommet

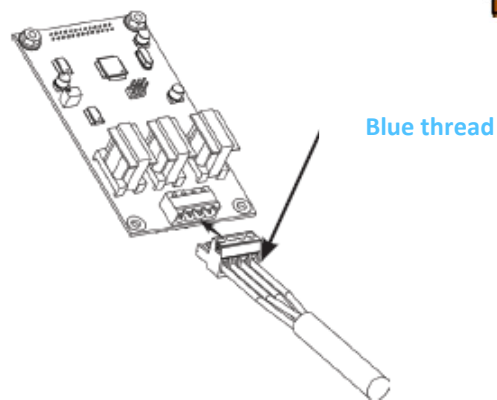

Position the three current coils on the MV feed (400A socket) with the green side of each coil on the circuit breaker side.

This is absolutely vital to achieve proper delivery of the single-pole current.

**When replacing a box on the work place it is mandatory to put tors version 2012 and new connecting cables**

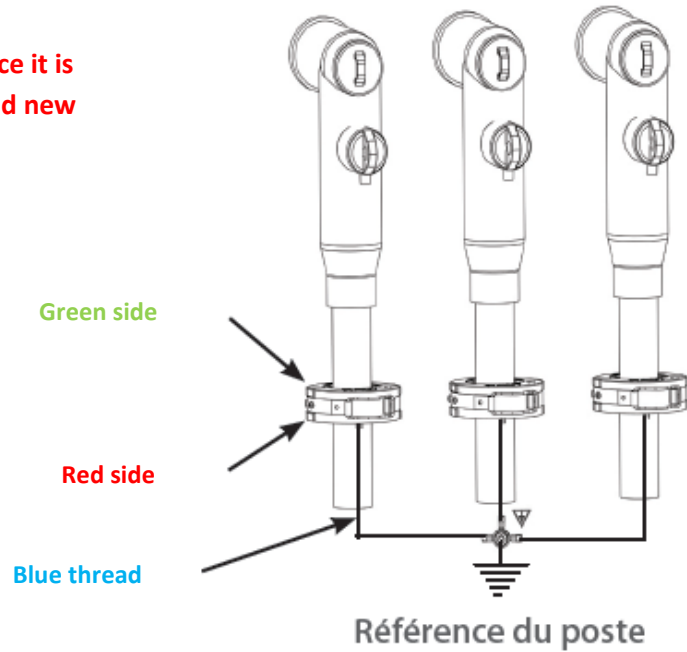

Connect all the sensor Earth connections (blue wire fitted with a ring terminal) to the unit Earthing point. The Earth braid of the MV cable shield must pass inside the coils

Connect the three coil connectors to those on the connecting cable

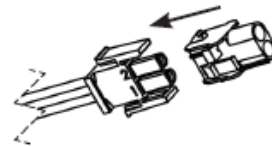

**The connection of live coils can be dangerous, consequently it is absolutely essential that the coil connecting cables are connected to the cabinet before they are connected to the coils.**

**Once this wiring has been created, it is possible to remove this live connector, specifically in order to conduct fault seeding tests using the standard tool**



**d) Voltage sensors (capacitive divider if directional detection):**

The voltage sensors must only be installed if the cabinet is configured for directional fault detection (DFD).

Connect the three PPACs to the 400 A sockets.

Connect the Earth connection (green/yellow wire fitted with a ring terminal) to the unit Earthing point

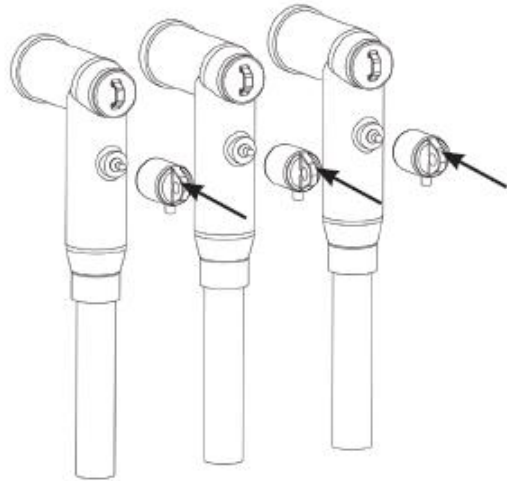
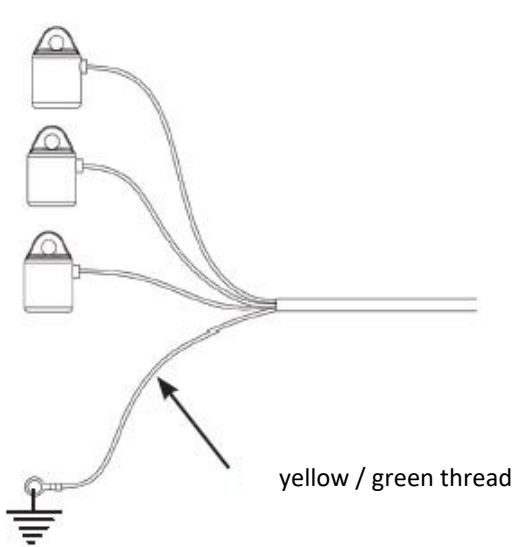

Insert the PPACS connecting cable through the grommet designed for this purpose. Screw the green connector on the wiring board onto the end of the

PPACS connecting cable, making sure you respect the position of the blue wire.

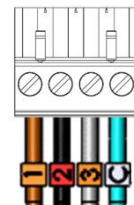

Connect the connector to the wiring board (bottom right).

Tighten the grommet

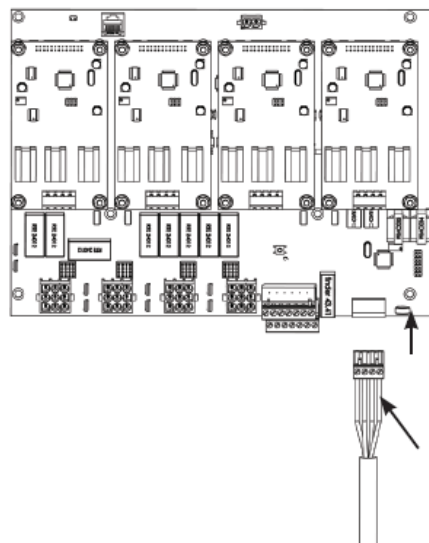

blue wire on the right



Connect the PPACS connector to that on the connecting cable.

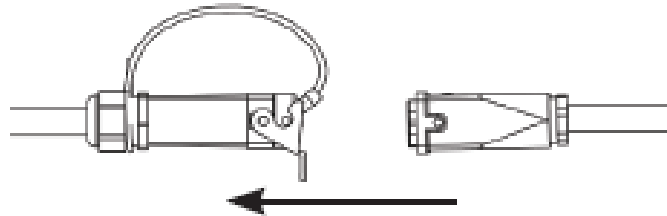

### e) External signalling connector (on the wiring board):

It combines external remote signalling (reserved connection) and the “switching in progress” floating potential contact.

The reserved connection labels can be fully customised by software.

Identification of the pins of the external connector:

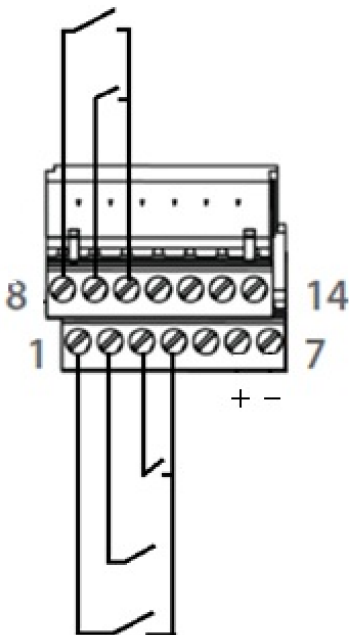

Pin no.	Function
1	Reserve 1
2	Reserve 2
3	Lock switching / Reserve 5
4	0 V
5	NC
6	Switching in progress + contact
7	Switching in progress - contact
8	Reserve 3
9	Reserve 4
10	0 V
11	Common indicator light (+)
12	Red indicator light (-)
13	Common indicator light (+)
14	Green light (-)

The dry contact inputs must be wired between the input for the desired signal (e.g. Water level on Reserve 3) and a 0 V input (representation of external contact wiring above).



## External indicator light wiring

Dual-colour light (Green/Red):

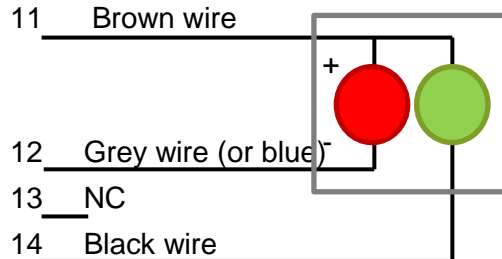

Single-colour light (Red):

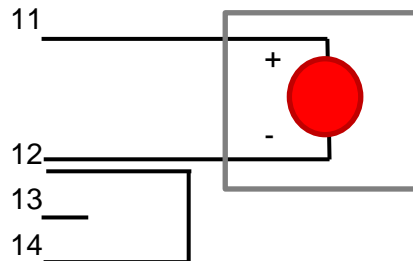

## f) Electrical control of circuit breakers:

The method for connecting electrical control “HARTING” connectors is identical for all channels. Each channel is positioned in production.

### Trunion

#### Identification of control pins:

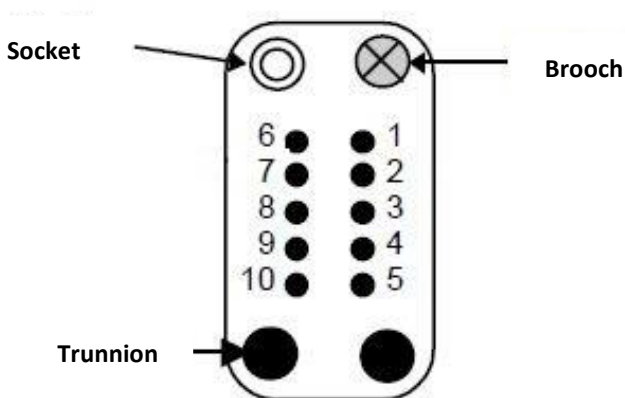

Pin no.	Function
1	0 V (- 48 V)
2	Close command
3	Open command
4	Open position
5	Closed position
6	+ 48 V
7	Neutralised control
8	MV power supply circuit breaker presence/absence
9	Use reserved
10	Use reserved





### De-rompage of connectors and header Han-10 A (contact pin side view)

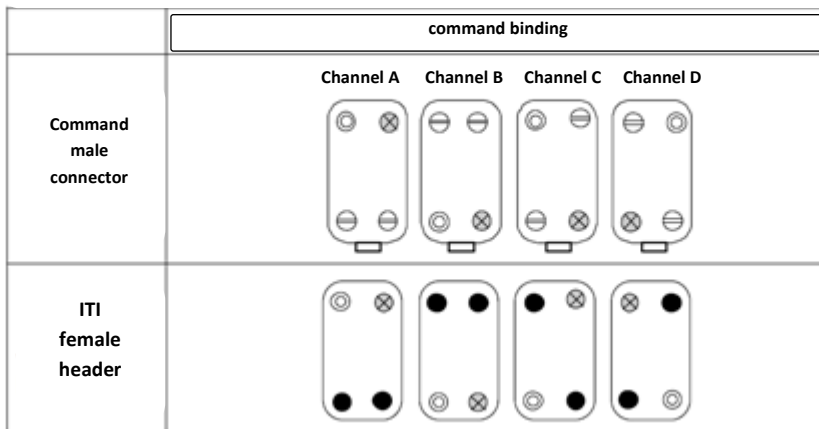

Once the electrical control interface connector is attached to the cabinet, lock it.

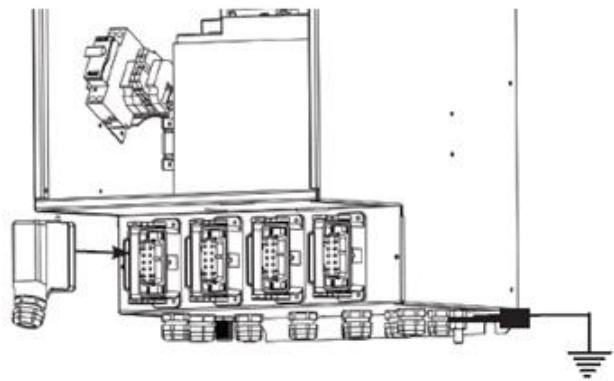

#### g) MV voltage selection:



The MV voltage can only be selected by programming using the PC software (see §4.2)

## 2.4 EARTHING INSTRUCTIONS

Loosen the earth M8 stud bolt nut.

Remove the two washers (flat and locking).

Place the **ring terminal connected to the equipment Earth** on the bolt.

Place the two washers on the bolt and secure it all in place using the nut.

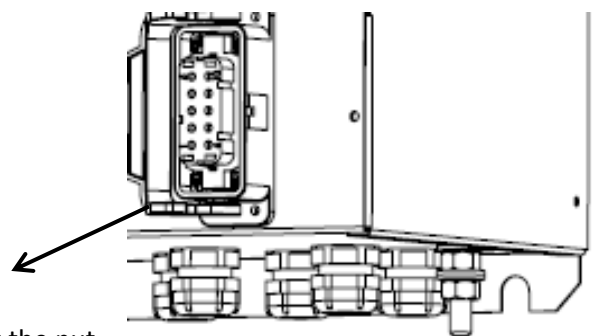



## 3 COMMISSIONING

- 3.1. Points to be checked before commissioning
- 3.2. List of commissioning operations
- 3.3. Operational tests



## 3.1 POINTS TO BE CHECKED BEFORE COMMISSIONING

### 3.1.1 Visual inspection

Check the product by means of a simple visual inspection (cabinet and user interface with no impact).

Check the battery charge status in accordance with the supplier's options.

### 3.1.2 Setting up the configuration PC

The equipment is configured during this phase. To do this, it is necessary to use a computer with an Ethernet connection and a standard web browser (Microsoft Edge, Mozilla FireFox, Google Chrome, etc.).

First, it is necessary to establish the connection between the equipment and the embedded software.

**Note:** The PC used must have at least Windows 7, an Ethernet connection and a standard web browser (Microsoft Edge, Mozilla FireFox, Google Chrome, etc.).

#### Changing an IP address on a PC

The connection to new e-RTU2020 cabinets is established via an Ethernet port and uses the IP protocol.

For this to work, it is therefore essential to provide the configuration PC with an IP address which matches that of the cabinet.

The cabinet configuration IP address is common to all of our products and is as follows:

- IP address: 192.168.10.1
- Subnet mask: 255.255.255.0

The configuration PC address must be:

- IP address: from **192.168.10.2** (or up to 192.168.10.254)
- Subnet mask: **255.255.255.0**



This operation only needs to be performed once on the same PC to connect to all the cabinets.

Note: The CPU2020 board includes a DHCP server (disabled by default).

Refer to guide 72868 – System configuration guide for cabinet e-RTU 2020

### It is essential to have administrator rights in order to change the IP addresses of a PC.

Note: Following configuration, if this PC needs to be connected to one or more different networks, it is necessary to change its IP address in order to bring it into line with the network addressing principles (static IP, DHCP).

The method for changing the PC IP addresses in different PC operating environments is detailed below

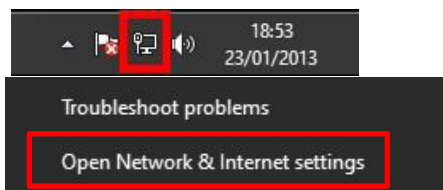

➤ Windows 10



Right-click the network icon in the menu bar to the right.

Select “Open Network and Sharing centre”

### Change your network settings

-  **Change adapter options**  
View network adapters and change connection settings.
-  **Sharing options**  
For the networks you connect to, decide what you want to share.
-  **Network troubleshooter**  
Diagnose and fix network problems.

[View your network properties](#)

[Windows Firewall](#)

[Network and Sharing Center](#)

[Network reset](#)

Select “Network and sharing centre”



Control Panel Home

Change adapter settings

Change advanced sharing settings

Media streaming options

In the panel on the left-hand side, select "Change adapter settings"

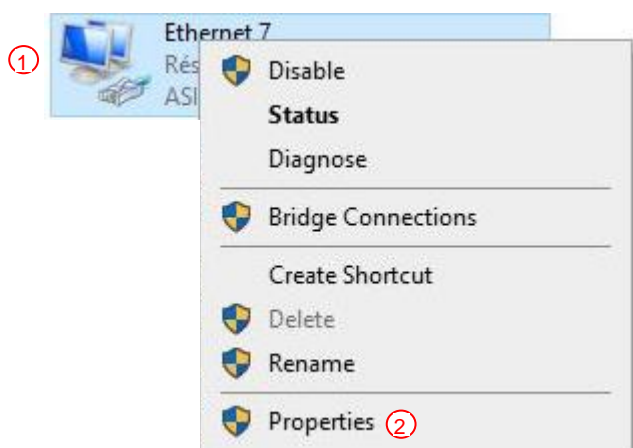

① Select and right-click the icon to view the network connection pop-up menu that will be used.

② Select "Properties"

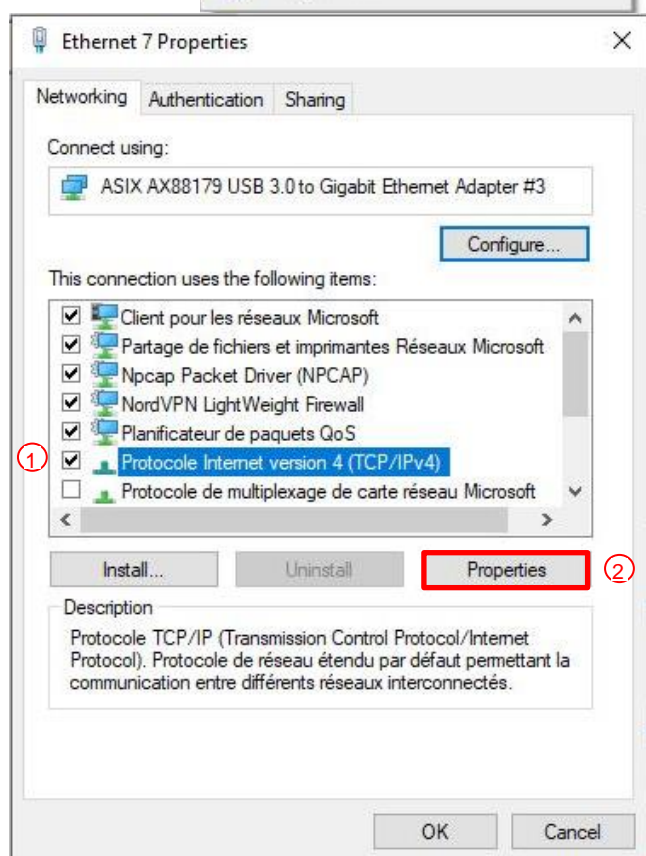

① Select "Internet Protocol (TCP/IP)" or "Internet Protocol version 4 (TCP/IPv4)" (without deselecting the check box)

② Select "Properties"

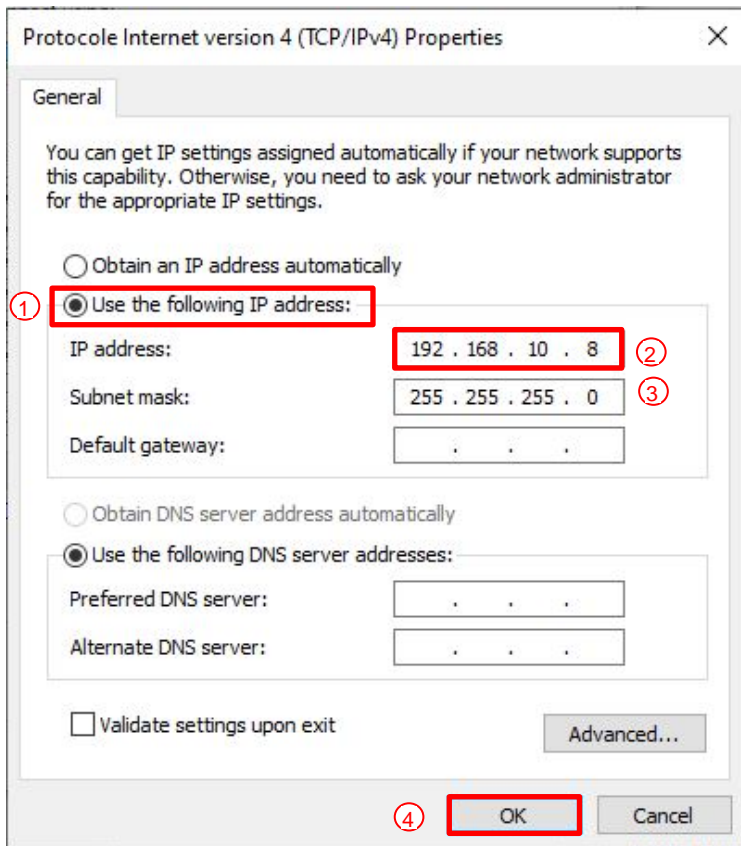

① Select “Use the following IP address”

Enter:

② the IP address

③ the subnet mask

④ Press “OK” to confirm

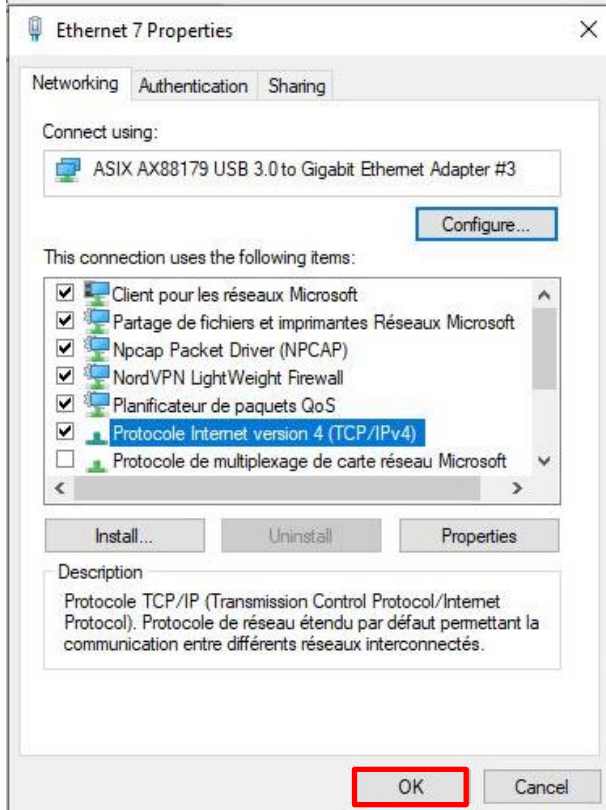

Select “Close”.

The change of IP address has now taken effect.



## 3.2 LIST OF COMMISSIONING OPERATIONS

### 3.2.1 Product power supply:

Connect the battery cable to the battery (in the bag of accessories).



**Check that the battery cable is correctly fitted  
(red cable to + and black cable to -)**

Insert the battery into its housing and connect it to the equipment (see § 2.3).

Position the retaining strap in place (by passing it through the rectangles at the bottom).

Close the fuse holder.

**The equipment is now live**

Close the lower door and apply the second locking seal.

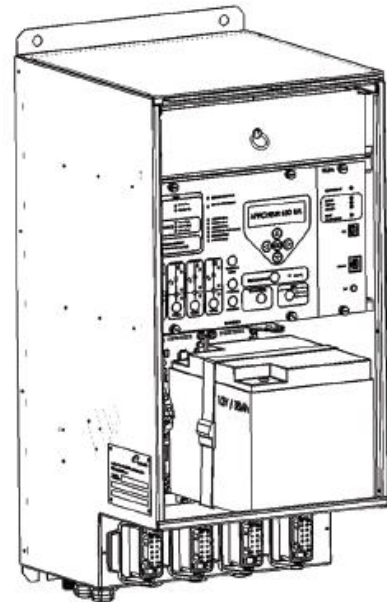

### 3.2.2 Configuration by PC

Now connect your PC to the cabinet's Ethernet Configuration port.

Open the Internet browser and enter <https://192.168.10.1> in the address bar

As the certificate is self-signed, a warning message may appear. Agree to continue.

**You are then taken to the home page for the embedded software.**



# ENSTO

## e-RTU2020

User :  

Password :

3 user accounts are created by default:

- Administrator:  
Access to all tabs.  
Default password: root\_ensto
- Maintenance:  
Access to all tabs associated with operation of the MV network  
Default password: maintenance\_ensto
- Visualization  
Access limited to visualization, downloading and actions available on the local UI.  
Default password: ensto

The passwords for Administrator and Maintenance users must be changed when the user first logs in.

Additional accounts can be added

*(Refer to guide 72868 – System configuration guide for cabinet e-RTU2020)*

All of the configuration settings are detailed in § 4.2, but the following settings at least must be configured



## ENSTO

### Visualization

e-RTU2020

- Equipment
- Fault
- Measurements and Counters
- Inputs / Outputs
- Events
- Local order
- Downloading
- IP tester
- IP analyzer
- IP traces
- Serial traces
- Communication and Protocols
- Automation
- Fault Detection
- Delays and Alarms
- Cyclic Measurement Recording
- Telemetry
- I/O Label
- TSS Fault Grouping
- Maintenance
- Administrator Settings
- System

**Equipment**

Standby Equipment
 Local

Equipment in default
 Absence U Vac

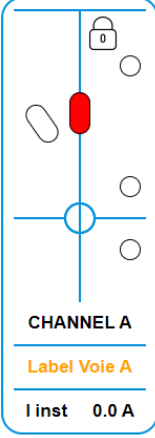

**CHANNEL A**

Label Voie A

I inst 0.0 A

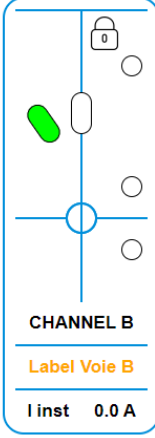

**CHANNEL B**

Label Voie B

I inst 0.0 A

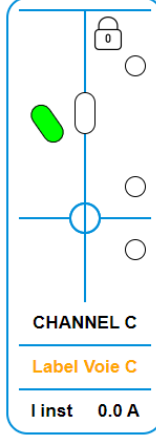

**CHANNEL C**

Label Voie C

I inst 0.0 A

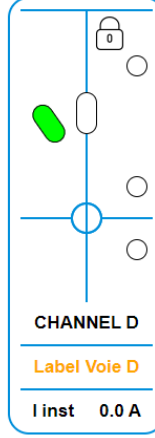

**CHANNEL D**

Label Voie D

I inst 0.0 A

**ASF**

In Service
 Out of order

**ASPP**

In Service
 Out of order
 Switching in progress

Src1 < Src2
 Src1 <=> Src2
 Src1 > Src2

External locking
 Conditions Not Met

- Communication and Protocols Menu
  - Configure the communication devices
    - IP:

## ENSTO

### Communication and Protocols

e-RTU2020

- [Return](#)
- Ethernet
- Uart (COM)
- Main Communication
- Secondary Communication

**Ethernet**

Ethernet IP address eth0 (COM)

Ethernet mask eth0 (COM)

Ethernet eth2 IP address (EXTENSION)

Ethernet mask eth2 (EXTENSION)

**IP routing**

Destination IP	IP Gateway	Interface	
<input type="text" value="0.0.0.0"/>	<input type="text" value="192.168.0.254"/>	<input type="text" value="eth0"/>	

Save

4PR-F14-D



- Serial:

ENSTO Communication and Protocols

ENSTO e-RTU2020

- Return
- Ethernet
- Uart (COM)
- Main Communication
- Secondary Communication

### Uart (COM)

Uart 1	
COM	COM1
Baudrate	9600
Parity	Even
Number of bits	8
Stop bit (s)	1
RTS management	No
Delay pre RTS (ms)	100
Delay post RTS (ms)	50
RTS polarity	Normal
COM settings	direct protocol (null modem)
Dialing buffer (ATD)	ATD00000000
Uart 2	
COM	COM2
Baudrate	9600
Parity	Even
Number of bits	8
Stop bit (s)	1
RTS management	No
Delay pre RTS (ms)	0
Delay post RTS (ms)	0
RTS polarity	Normal

Save

- Configure primary/secondary communication (see Protocol Notice)

- Fault detection menu

- Program the type of fault detection

ENSTO Fault Detection

ENSTO e-RTU2020

- Return
- Fault detection
- Amperemetric Fault Detection
- Directional Fault Detection

### Fault detection

Neutral regime type Amperemetric

Save



- Overcurrent (“Amperimetric”):

- Program the current thresholds for single-phase and polyphase faults

ENSTO You are logged in as Administrator

### Fault Detection

e-RTU2020

- Return
- Fault detection
- Amperemetric Fault Detection
- Directional Fault Detection

#### Amperemetric Fault Detection

Earth current channel A (A)	40
Earth current channel B (A)	40
Earth current channel C (A)	40
Earth current channel D (A)	40
Time taken into account earth fault current (ms)	80
Phase current Channel A (A)	450
Phase current Channel B (A)	450
Phase current Channel C (A)	450
Phase current Channel D (A)	450
IDouble Channel A (A)	1200
IDouble Channel B (A)	1200
IDouble Channel C (A)	1200
IDouble Channel D (A)	1200
Time for taking into account phase and double fault (ms)	80
SPI activation time (ms)	250
Minimum SPI signaling time (s)	3
Reset detector by LV presence	Yes
Detector reset by MV presence (switch)	No
Detector reset by MV presence (PPACS)	No
Reset detector by current presence	No
Reset detector by time delay	Yes
SPI maximum time signaling (s)	7200

Save

- Directional

- Program the current thresholds for single-phase and polyphase faults

ENSTO You are logged in as Administrator

### Fault Detection

e-RTU2020

- Return
- Fault detection
- Amperemetric Fault Detection
- Directional Fault Detection

#### Directional Fault Detection

Phase current Channel A (A)	500
Phase current Channel B (A)	500
Phase current Channel C (A)	500
Phase current Channel D (A)	500
Time for taking into account phase fault (ms)	80
IDouble Channel A (A)	250
IDouble Channel B (A)	250
IDouble Channel C (A)	250
IDouble Channel D (A)	250
Time for taking into account double fault (ms)	80
Earth current peak threshold (Acr)	30
Earth voltage peak threshold (Vcr)	4000
Earth voltage confirmation threshold (Veff)	1700
Presetting 1	Preset the parameters with the Jeu 1
Presetting 2	Preset the parameters with the Jeu 2
Time of taking into account MV presence (ms)	5000
SPI presence time (s)	10
Max time SPI (s)	7200

Save

Standard homopolar sensitivity presets are available  
(Press the Preset1 and Preset2 buttons)

- Calibrate the PPACs (to do this, there must be MV) in the local control tab

ENSTO Visualization

Local

Local order

- Reset Counters
- LV Voltage Calibration
- Detector Test
- Change source APSS
- Cyclic measurement file initialize
- Voltage card calibration
- Battery Test
- Activate/Desactivate APSS
- Activate/Desactivate ASF

CHANNEL A CHANNEL B CHANNEL C CHANNEL D

OPENING CLOSING I inst 0.0 A

Sorties TOR

- Open close Libelle digital output 1
- Open close Libelle digital output 2
- Open close Libelle digital output 3



- Automation menu (if necessary)
  - ASF

🇫🇷 🇩🇪 🇪🇸
You are logged in as Administrator

ENSTO
Automation

e-RTU2020

Return

ASF

ASPP

ASF

Active function	No
Voltage monitored during opening	None
Validated Automation channel A	No
Opening during	Fault 2
Fault direction	Red
Validated Automation channel B	No
Opening during	Fault 2
Fault direction	Red
Validated Automation channel C	No
Opening during	Fault 2
Fault direction	Red
Validated Automation channel D	No
Opening during	Fault 2
Fault direction	Red
Minimum time between 2 faults (ms)	1500
ASF Standby Timeout (s)	40
Opening delay on ASF (ms)	3000
Opening supervision delay on ASF (s)	10

Save

➤ Enable or disable the use of ASF automation (Function active/inactive)

- APSS

🇫🇷 🇩🇪 🇪🇸
You are logged in as Administrator

ENSTO
Automation

e-RTU2020

Return

ASF

ASPP

ASPP

Active function	No
Source 1 configuration	Channel A
+	None
+	None
Source 2 configuration	Channel B
+	None
+	None
Type of automation	Full
Number of attempts	3
Automatic return to main source	No
Cancel time permut. on active Src voltage return (T3s) (ms)	3000
Time out permutation (T3mn) (s)	180
Switchover delay (s)	45
Cell opening monitoring delay on ASPP (s)	10
Cell closing monitoring delay on ASPP (s)	10
Time between 2 attempts (ms)	150

Save

Enable or disable the use of APSS automation (Function active/inactive)



In order to function, the automated systems must be turned on either locally via the local panel or remotely.



- System menu

The screenshot shows the ENSTO System configuration page. The top navigation bar includes language flags and the text 'You are logged in as Administrator'. The main content area is titled 'System' and contains several sections: 'System' (with Date / Hour and Version), 'Update' (with a file selection dropdown and an Update button), 'Configuration' (with a Download button and a Send and reboot button), 'Reboot' (with a Reboot button), 'Restoration' (with buttons for restoring previous configuration and factory settings), and 'Settings' (with input fields for Session timeout (s), Maximum number of login attempts, and Lockout time for too many failed login attempts (s), and a Save and take into account button).

- Set the ITI cabinet's time either manually or using the time on your PC (click on the cogwheel alongside the time)

**On completion of configuration, there should no longer be any faults and the green equipment standby LED on the local panel should flash.**



### 3.3 OPERATIONAL TESTS

A description of the user interface is available in § 1.2.

Via the local panel, check that the following information is displayed:

12 V POWER SUPPLY indicator light	STEADY ON	
EQUIPMENT IN STANDBY indicator light	FLASHING	
EQUIPMENT FAULT indicator light	OFF	
Fault indicator lights	OFF	
LOCAL indicator light	STEADY ON	
POSITION indicator lights	STEADY ON GREEN OR RED (if a circuit breaker is connected)	
NEUTRALISATION indicator lights	OFF OR FLASHING (depends on the status of the circuit breaker neutralisation switch)	
TEXT display	> Measurements > Counters > Configuration > Maintenance	

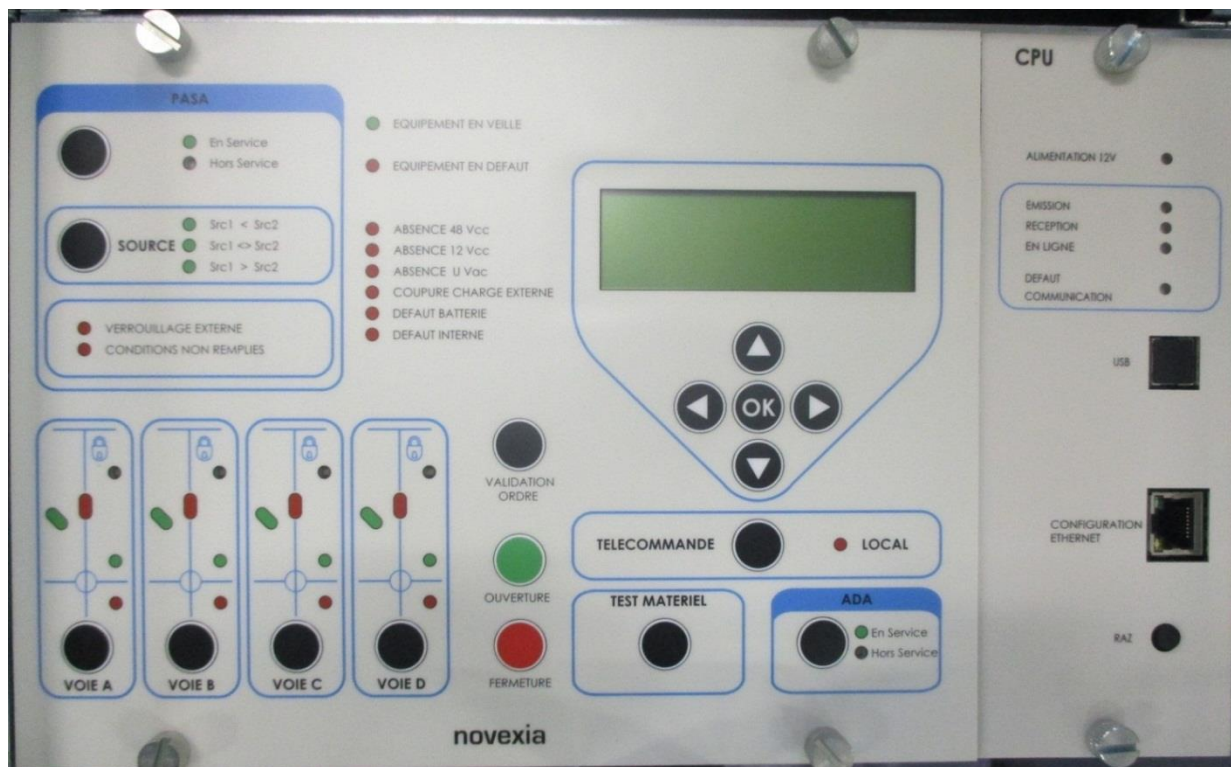

Press the **EQUIPMENT TEST** button and check that all the indicator lights come on and that the display is off.



The following commissioning operations may be carried out via:

- User interface: Display module / navigation button.
- Web user interface: Local Command Tab

The cabinet must be in local position

a. Battery test:

The equipment integrates a battery test to confirm the condition of the battery.

**Maintenance → Battery test → Press the “OK” button**

20 seconds later the screen displays the message: **“Battery test OK” or “Battery test failed”**. If the procedure has failed, refer to §5.2 (corrective maintenance) to identify the cause of the problem.

b. Fault detector test:

**Maintenance → Detector tests → Press the “OK” button**

Flashing fault lights implies the detector is functioning correctly. If the procedure has failed, refer to §5.2 (corrective maintenance) to identify the cause of the problem.

Note: To check all the fault detection features, use the NOVEXIA fault simulator (internal cat. No. IFS NX2000401).

c. Calibration procedure: (if voltage sensors present and directional)

As the switch is connected to the live network, you can only initiate the calibration of voltage sensors via the Web User interface (local Command tab).

After 10 seconds the calibration status (OK or Fail) can be seen in the fault tab. If the procedure has failed, refer to §5.2 (corrective maintenance) to identify the cause of the problem.





d. Communication test

Perform communication tests with the control station and check that information is correctly returned to the remote control centre.

The "Reception", "Transmission", and "Online" LEDs must flicker during communication (serial protocols).

e. Circuit breaker control test

Check the proper operation of the electrical control of the MV circuit breakers. To do this, for each channel, perform an open/close cycle (via the local panel, select the channel then press the command validation and the open or close buttons at the same time) and check the correspondence between the position of the circuit breaker and the position indicator lights on the user interface.

Note: To perform this check, it is possible to use a circuit breaker simulator.

f. Testing the neutralisation switch for MV circuit breakers

For each channel, set the neutralisation switch on the MV circuit breaker to ON. Check that the corresponding "Neutralised" LED for the channel flashes.

Check that the electrical control is neutralised (manual mode): No possibility of performing an open/close cycle



## 4 OPERATION

4.1. Functions

4.2 Commands, tests, configurations

4.3. Method for using the PC interface

4.4 Upgrades with new functions



## 4.1 FUNCTIONS

The cabinet contains, with reduced space requirements, all of the functions required to remotely control underground circuit breakers. In addition, it can detect line faults, for example, a branch fallen on the line.

The product purpose is to make the MV network more reliable in order to reduce power outages for the end user (industrial users, residents, etc.).

Several variants are available to meet all communications needs.

Viewing and configuration are possible by PC by means of the HTML pages embedded in the equipment.

Certain settings can be viewed on the local panel.

### 4.1.1 Power supply unit function

The power supply unit comprises:

#### a. 100 VA primary isolation transformer

Primary: 230 V ( $U \pm 15\%$ )

Secondary: 0 V – 27 V

Dielectric strength: primary/screen: 10 kV 50 Hz – 1 mm, 20 kV with 1.2 / 50  $\mu$ s shock wave  
secondary/screen: 10 kV 50 Hz – 1 mm, 20 kV with 1.2 / 50  $\mu$ s shock wave  
primary/secondary: 10 kV 50 Hz – 1 mm, 20 kV with 1.2 / 50  $\mu$ s shock wave

#### b. Battery charger

The charger is voltage-regulated and temperature-compensated with a current limit of 3.5 A. The charge curve is specific to each type of battery, batteries must be replaced with batteries of the same type and the same make. The energy workshop can provide 15 A for 50ms and 5 A for 7s for controlling the circuit breaker motor.

- 12 V DC power source: the energy supply unit provides regulated DC voltage with temperature compensation of 13.8 V, 3.6 A at 20°C.

The protection of external loads is assured by a 5 x 20 mm fuse, rating 4 A.

- 48 V DC power source: A 12 V / 48 V converter provides 48 V, 7 A regulated voltage (it can withstand a current impact of 15 A for 50 ms).



## Management of the 12 V power supply required by the cabinet.

- Fuse F1 (4 A) protects the charger.
- An F2 fuse with 6.3 A rating protects the motor power supply.
- In standby or during operating cycles, the voltage is 12 V +30%, -10% depending on consumption and the ambient temperature.
- Residual ripple less than 1% from 50 Hz to 3 kHz
- 0 V connected to the protective Earth

## Battery protection against deep discharge

Subsequent to a lack of AC voltage for 16 hours , the loads powered by the battery are cut off (the cabinet is no longer supplied).

The power supply is restarted by:

- Return of the AC voltage supply
- Pressing the "RAZ" (Reset) button, which restarts a 16-hour charging cycle.

In the event of excessive power consumption by your communication equipment (Current > 2 A for more than 3 min) the 12 V power supply circuit is disconnected. Restore the power supply by pressing the reset button, which initialises the cabinet.

Monitoring of the AC voltage. The loss of AC voltage ( $U < 30 \%$ ) is signalled by

- Remote signalling: "no AC voltage"
- A red indicator light appears on the front panel of the local module panel

## Periodic battery test:

A battery testing system is incorporated into the battery charger. The battery capacity is systematically tested every 24 hours.

Values measured: battery voltage:  $12 \text{ V} \pm 2 \% \pm 0.1 \text{ V}$  or converter voltage:  $48 \text{ V} \pm 2 \% \pm 0.4 \text{ V}$  (depending on the model)

A current of 6 A is delivered in a resistive load for a period of 2 sec. The battery voltage is measured before, during and after testing. This enables us to calculate the voltage drop at these terminals. Exceeding the voltage drop threshold indicates that the battery's characteristics are no longer able to guarantee normal operation of the control cabinet (battery at the end of its life or insufficient charge).



This information is signalled by the flashing red indicator lights (battery fault and Equipment Failure) on the front panel and via remote signalling.

The battery voltage varies according to the ambient temperature; the permissible voltage drop threshold is offset by the temperature measurement.

It should be noted that the test can also be initiated manually via the display menu. This test takes about 2s. If a battery fault is detected, the battery fault remote signal is activated. The battery fault and the red equipment failure indicator lights switch on and remain lit until total removal of the power supplies.

### c. Battery

Lead battery: 12 V / 38 Ah.

The battery (not supplied with the cabinet) has a recommended working life of seven years.

Replace the battery if a battery fault is reported by the cabinet.

**NB.:**

**In the case of prolonged storage, the battery must be recharged every 3 months.**

Charging voltage	Temperature
12 V	
13.9 V	15°
13.8 V	20°
13.7 V	25°

**Note that you can recharge the battery using the instrumentation and control unit by connecting it to mains power**



## 4.1.2 Switch command function

The switch can be operated remotely or locally via the cabinet's UI.

For local operation, ensure that the cabinet is in local operation ("local" indicator light on) otherwise press the "REMOTE CONTROL/LOCAL" button

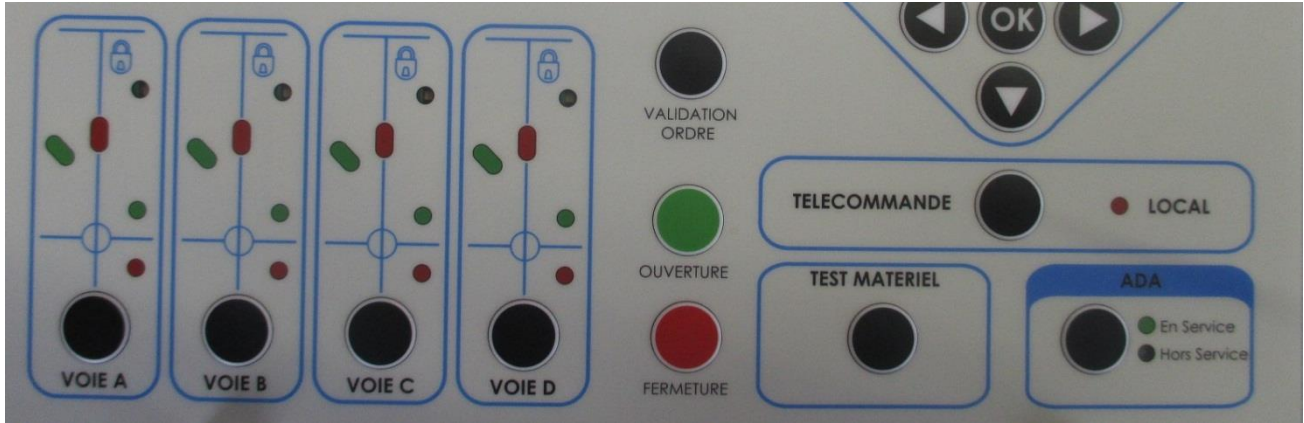

To close a channel, first select the channel to close, then press the "CLOSE" and "COMMAND VALIDATION" buttons at the same time. After closure, the red position indicator lights up

To open a channel, first select the channel to open, then press the "OPEN" and "COMMAND VALIDATION" buttons at the same time. After opening, the green position indicator light comes on

Note: If a circuit breaker is neutralised by the neutralisation switch on the circuit breaker, the corresponding indicator light ① flashes yellow and all local or remotely controlled operations are prevented.

## 4.1.3 Fault detection function

For each channel, the device consists of:

- 3 current measuring coils installed on the phases with a ratio of 500 A/1 A and 3 kV insulation between the windings and earth
- 3 isolation transformers with 2 kV coils, which protect our electronic system from voltage surges.



Electronic assembly comprising the modules for:

- phase current measurement
- detection of exceeding thresholds
- monitoring of AC voltage
- fault display
- remote signalling of faults

There are 2 types of fault current detector

#### Overcurrent detector (with an impedance-earthed neutral)

This enables single-phase faults, double earth faults and polyphase faults to be detected.

Any excess phase current or phase-earth above the current threshold lasting longer than 300 ms ( $\pm 10$  ms) is signalled by:

- display on the front panel of the cabinet
  - a flashing red light indicating a phase fault.
  - flashing red and green lights indicating a polyphase fault
- remote signalling of “fault occurrence”



Deletion of logs is performed by the return of AC voltage or after 2 hours signalling. However, the information is retained for at least 3s after the fault has disappeared.

The different fault and time delay thresholds can be modified via the PC (see §4.2)

#### Directional sensor (compensated neutral)

This enables the detection of green or red single-phase faults, double earth faults and polyphase faults.

- display on the front panel of the cabinet
  - a flashing green light indicating a green single-phase fault.
  - a flashing red light indicating a red single-phase fault.
  - flashing green and red lights indicating polyphase or double faults

How this detection works is described in HN 45-S-51

The different fault and time delay thresholds can be modified via the PC (see §4.3)



## 4.1.4 ASF function

Automation analyses and stores the occurrence of permanent faults detected by the fault detector and controls the automatic opening of the switch if the threshold for the number of faults is reached. A fault is considered permanent when, in the power supply substation (or source substation), the upstream circuit breaker performs an ineffective slow recloser cycle.

The automation considers a fault downstream of the circuit breaker to be permanent when N number of network faults (N programmable from 1 to 7) are detected. The faults taken into consideration are Phase-Earth or Phase-Phase faults > T1. Faults < T1 are not considered.

E.g.:

The circuit breaker cycle takes place as shown in the diagram. The order to open the circuit breaker is sent 3 sec (T3) after the second occurrence of a current fault only if the line is switched off.

If the voltage has not disappeared, the opening command is not transmitted.

If no other fault is detected during a time of T2 seconds after the occurrence of the first fault, the automated system returns to the initial mode (T2 programmable from 30 sec to 240 sec).

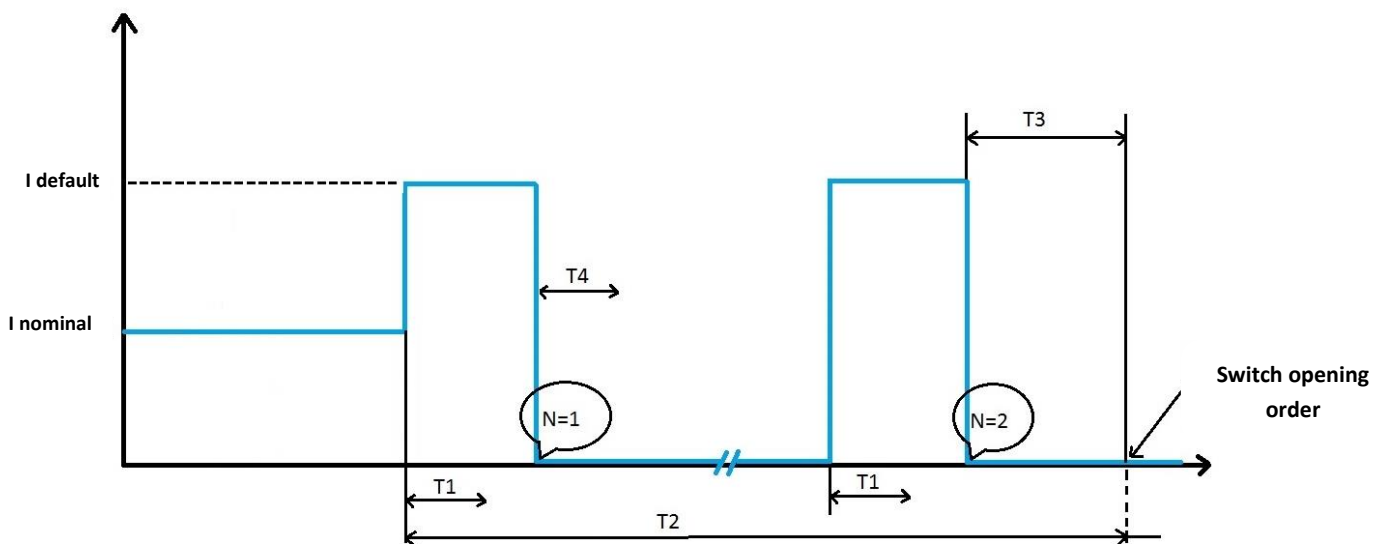



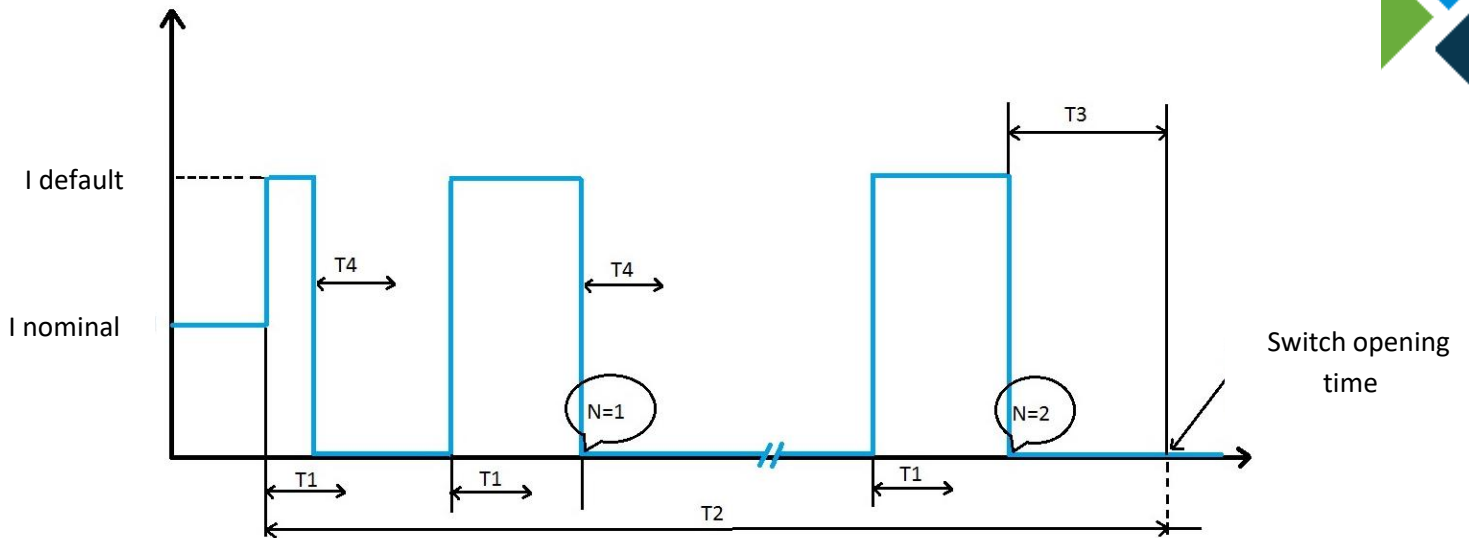

- T1: Time to trigger fault detection (page “fault detector setting programming”)
- T2: Timeout to return to the initial state
- T3: Time delay before opening command
- T4: Minimum time between two faults
- N: Number of faults before opening

Automated systems (ASF & APSS) can be turned on/off either remotely or locally via the cabinet local user interface (UI).



To activate the ASF function, press the “ASF” and "COMMAND VALIDATION" buttons at the same time. After activation, the green "ASF on" indicator light is illuminated

4PR-F14-D



To deactivate the ASF function, press the "ASF" and "COMMAND VALIDATION" buttons at the same time. After deactivation, the yellow "ASF off" indicator light is illuminated



The ITI cabinet's ASF function is only active if it has been previously configured by the PC software (see §4.3.12)

If the function has not been activated, the 2 ASF function lights (on, off) are not lit up



The direct action of activation/deactivation using the "ASF" button can be configured (see § 4.3.20 Administrator Parameters)

#### 4.1.5 APSS function

The APSS automated system continuously analyses the network's status and switches between 2 sources when the following switching conditions are fulfilled:

- At least one circuit breaker for the active source is closed. The closed circuit breakers are not neutralised.
- The circuit breakers for the back-up source are open.
- There is no voltage at all the closed circuit breakers for the active source.
- There is voltage at at least one non-neutralised circuit breaker for the back-up source.
- The 48 V DC voltage is correct, guaranteeing the complete switching of sources.
- There is no external locking order.
- The switching direction is authorised.
- No default MV locking order originating from MV fault detectors for the active source in the case of complete automation.
- Locking conditions for the APSS function

#### Overcurrent

Locked switching in the presence of at least one single-pole or polyphase fault affecting the active source.

#### Directional

Locked switching in the presence of at least one green or polyphase fault affecting the active source.



The APSS automated system is configured using the PC. It defines

- Definition of the switching pair Src1 and Src2: 1 to 3 channels per source
- Type of automated system: Complete (MV fault monitoring) or Simplified
- Switching direction: Src1 -> Src2 ; Src1 <-> Src2 ; Src1 <- Src2
- Time delay to switching (Tr): 1, 5, 25, 45s
- Number of authorised attempts: 1 to 4

Automated systems (ASF & APSS) can be activated and deactivated either remotely or locally via the local user interface (UI) on the cabinet.

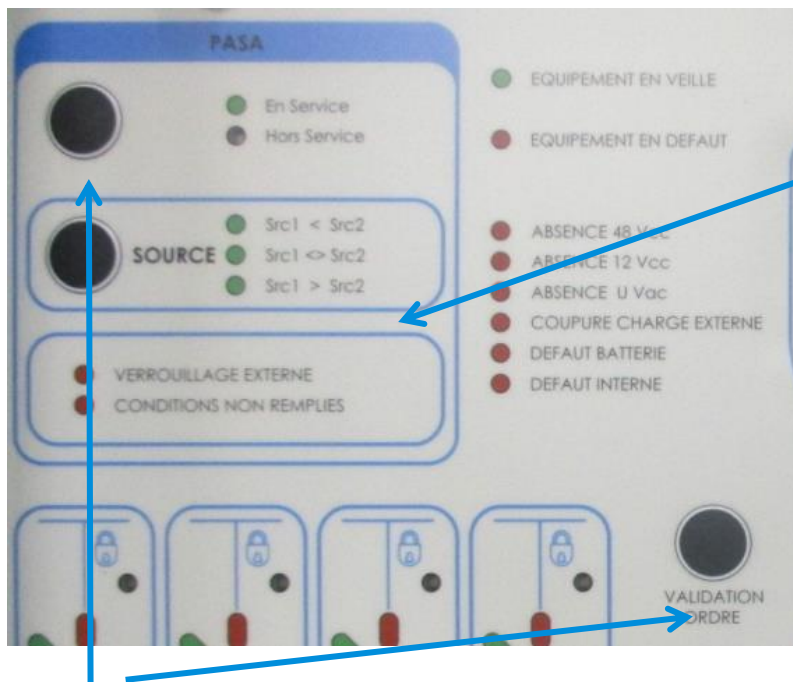

Display of the switching direction

To activate the PASA function, press the "APSS" and "COMMAND VALIDATION" buttons at the same time. After activation, the green "APSS ON" indicator is illuminated

To deactivate the PASA function, press the "APSS" and "COMMAND VALIDATION" buttons at the same time. After deactivation, the yellow "APSS OFF" indicator is illuminated.



The ASPP function of e-RTU2020 cabinet the is only active if it has been configured beforehand by the PC software (see §4.3.12)

If the function has not been activated, the 2 PASA function lights (on, off) are not lit up



The direct action of activation/deactivation using the "PASA" button can be configured (see § 4.3.20 Administrator Parameters)

4PR-F14-D



## 4.2 COMMANDS, TESTS, CONFIGURATIONS

The product has UI and PC interfaces for configuring it and visualizing information on the cabinet and the network. This paragraph informs the technician of the method for using the product interfaces.

### Method for using the user interface (UI):

The user interface has buttons, indicator lights and a display.

The use of buttons and the visualization of LEDs is intuitive. The memo (below) is available for taking charge of the **display/navigation button** module.

### Memo for using the display/navigation button module

In the initial state in local mode, the screen displays the following tabs:

- > Measure
- > Counters
- > Configuration
- > Maintenance



Position the arrow opposite a tab and press the OK button to access it. To leave the tab, press the LEFT button. The arrow is moved using the UP and DOWN buttons.

It is possible to scroll through the information contained in the tabs using the UP and DOWN buttons.

The “Configuration” and “Maintenance” menus allow certain cabinet settings to be visualized.



## 4.3 METHOD FOR USING THE PC INTERFACE

# ENSTO

## e-RTU2020

User : Administrator  
Password :  
Cancel

3 user accounts are created by default:

- Administrator:  
Access to all tabs.  
Default password: root\_ensto
- Maintenance:  
Access to all tabs associated with operation of the MV network  
Default password: maintenance\_ensto
- Visualization  
Access limited to visualization, downloading and actions available on the local UI.  
Default password: ensto

The passwords for Administrator and Maintenance users must be changed when the user first logs in.

Additional accounts can be added

(Refer to guide 72868 – System configuration guide for cabinet e-RTU2020)



### 4.3.1 Available tabs depending on the user level

User Level	Visualization	Maintenance	Administrator
Accessible tabs			

The Maintenance and Administrator user levels allow settings to be changed, by entering the value via the computer keyboard or via the drop-down menu.

Data is incorporated by the equipment when the **Save** button is pressed on the corresponding page.

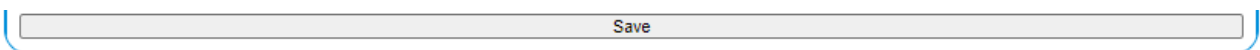

Once all the settings have been changed, they are applied by the cabinet when the **Apply changes** button is pressed:

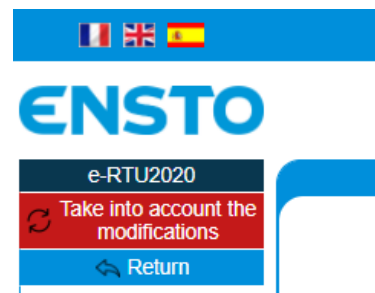

**Better life.**  
With electricity.



## 4.3.2 Visualization Tab

🇫🇷 🇬🇧 🇪🇸
You are logged in as Visualization

# ENSTO

## Visualization

e-RTU2020

Equipment

Fault

Measurements and Counters

Inputs / Outputs

Events

Local order

Downloading

IP tester

IP analyzer

IP traces

Serial traces

**Equipment**

Standby Equipment

Equipment in default

Local

Absence U Vac

**CHANNEL A**

Label Voie A

I inst 0.0 A

**CHANNEL B**

Label Voie B

I inst 0.0 A

**CHANNEL C**

Label Voie C

I inst 0.0 A

**CHANNEL D**

Label Voie D

I inst 0.0 A

**ASF**

In Service
 Out of order

**ASPP**

In Service
 Out of order
 Switching in progress

Src1 ◀ Src2
 Src1 ↔ Src2
 Src1 ▶ Src2

External locking
 Conditions Not Met

Settings	Possibilities	Definitions
<b>Equipment fault</b>	Lit up red Off	Fault affecting one of the cabinet's elements. An explanation of the fault will be provided in the Fault tab
<b>Equipment in standby</b>	Lit up green Off	Equipment operating normally. Additional information on the equipment fault
<b>No LV supply voltage</b>	Lit up red Off	No power supply if the voltage is below 170 V (for a 230 V power supply)
<b>Local</b>	Lit up red Off	Display of product operating mode (Local / Remote)
<b>Switch position</b> (by channel)	Lit up green Lit up red Off Lit up red+green	Switch open Switch closed Switch not present Switch fault
<b>Instantaneous current</b> (by channel)	0 to 999	Instantaneous value of three averaged line currents
<b>Fault detection</b> (by channel)	Lit up red Lit up green Lit up green+red Off	Line fault detection depending on the type of detection selected (§4.3.13 Fault detection tab) and the type of visualization selected (§4.3.20 Administrator Settings tab)
<b>Channel lockout information – padlock –</b> (by channel)	Lit up yellow Off	Status of the lockout switch for the MV cell

4PR-F14-D

Ensto Novexia SAS 210 rue Léon Jouhaux  
 BP 10446  
 69656 Villefranche-sur-Saône Cedex,  
 France

Tel. +33 (0)474 656 161  
 Fax +33 (0)474 629 657

Better life.

With electricity.

Automated system status (ASF)	Lit up green Lit up yellow Off	On Off Disabled
Automated system status (APSS)	Lit up green Lit up yellow Off	On Off Disabled
Switching in progress	Lit up red Off	Switching source in progress
Switching direction	Lit up green Off	Defining the authorised switching direction
External locking	Lit up red Off	Automated system locked by presence of external contact (see §2.3.2.e)
Conditions not fulfilled	Lit up red Off	Automation locked as the result of a lack of switching conditions

By moving the mouse over the channel, the channel details appear:

**CHANNEL A**

**I inst**    0.0 A  
**I avg**     0.0 A  
**I max**    0.0 A

**Manoeuvres number:**  
**1**

**Earth fault:**  
**0**

**Phase fault:**  
**1**

SEE MORE

<b>Instantaneous current</b>	0 to 999	Instantaneous value of three averaged line currents
<b>Average current</b>	0 to 999	Averaged instantaneous current
<b>Maximum current</b>	0 to 999	Maximum instantaneous current
<b>Switching operation counters</b>	0 to 9999	Number of switching operations switching operations
<b>Phase/earth fault</b> (in amperometric detection mode only)	0 to 9999	Number of faults between phase and earth
<b>Fault between phases</b>	0 to 9999	Number of faults between phases
<b>Red fault</b> (in directional detection mode only)	0 to 9999	Number of red faults
<b>Green fault</b> (in directional detection mode only)	0 to 9999	Number of green faults

**SEE MORE**

The button opens the *Measurements and Counters* tab (see §4.3.4)





### 4.3.3 Fault Tab

You are logged in as Administrator

## ENSTO

- e-RTU2020
- Equipment
- Fault
- Measurements and Counters
- Inputs / Outputs
- Events
- Local order
- Downloading
- IP tester
- IP analyzer
- IP traces
- Serial traces
- Communication and Protocols
- Automation
- Fault Detection
- Delays and Alarms
- Cyclic Measurement Recording
- Telemetry
- I/O Label
- TSS Fault Grouping
- Maintenance
- Administrator Settings
- System

## Visualization

**Fault**

- U Alim Fault
- subst. U Alim Fault
- Charger(12V) Fault
- Charger(COM) Fault
- Battery Fault
- Display fault
- Converter fuse Fault
- DC/DC Convert. Fault
- Measure board Fault
- 12V motor fuse Fault
- SF6 low pressure
- CPU Fault
- IO board Fault
- Reserve IO board 1
- Reserve IO board 2
- Voltage board1 Fault
- Voltage board2 Fault
- Radio overcurrent
- APSS open fault
- APSS close Fault
- APSS def. conditions
- ASF open Fault Ch A
- ASF open Fault Ch B

- ASF open Fault Ch C
- ASF open Fault Ch D
- ASF open Fault Ch E
- ASF open Fault Ch F
- ASF open Fault Ch G
- ASF open Fault Ch H
- CD Fault Channel A
- CD Fault Channel B
- CD Fault Channel C
- CD Fault Channel D
- CD Fault Channel E
- CD Fault Channel F
- CD Fault Channel G
- CD Fault Channel H
- DD board fault Ch A
- DD board fault Ch B
- DD board fault Ch C
- DD board fault Ch D
- DD board fault Ch E
- DD board fault Ch F
- DD board fault Ch G
- DD board fault Ch H

**Remote fault reporting**

- Equipment fault
- Internal fault
- Non Urgent Fault

- Card Fault
- Urgent fault

Settings	Possibilities	Definitions
<b>Prolonged lack of LV supply voltage (AC voltage)</b>	Lit up red Off	No power supply for 16 h (configurable value)
<b>Charger Fault (12 V voltage)</b>	Lit up red Off	12 V voltage fault or no 12 V voltage
<b>Charger fault (COM)</b>	Lit up red Off	Charger card communication fault
<b>Battery fault</b>	Lit up red Off	Battery anomaly if the voltage at its terminals is less than 10.5 V or its capacity is zero or the battery test has failed
<b>Display fault</b>	Lit up red Off	Display board communication fault
<b>Converter fuse fault</b>	Lit up red Off	48 V fuse fault as the result of 48 V over-consumption
<b>Converter fault</b>	Lit up red Off	Output voltage fault or no output voltage from the DC/DC converter
<b>Measurement board fault (overhead only)</b>	Lit up red Off	Measurement board communication fault
<b>Motor fuse fault (overhead only)</b>	Lit up red Off	Motor fuse fault as the result of 12 V motor over-consumption
<b>SF6 pressure drop fault (overhead only)</b>	Lit up red Off	Information originating from the SF6 pressure sensor contact (Auguste)
<b>CPU fault</b>	Lit up red Off	CPU board electronic fault
<b>IO board fault</b>	Lit up red	IO 16 board communication fault

4PR-F14-D



	Off	
<b>Reserves card 1 fault</b>	Lit up red Off	Reserves information originating from the fault detector card wire 1 communication fault
<b>Reserves card 2 fault</b>	Lit up red Off	Reserves information originating from the fault detector card wire 2 communication fault
<b>VT 1 fault (PPACS)</b> (directional only)	Lit up red Off	Communication fault or fault affecting initialisation of the voltage acquisition electronics originating from the PPACS fault detector card wire 1
<b>VT 2 fault (PPACS)</b> (directional only)	Lit up red Off	Communication fault or fault affecting initialisation of the voltage acquisition electronics originating from the PPACS fault detector card wire 2
<b>Prolonged max. radio current</b>	Lit up red Off	Over-consumption of external 12 V current (by default > 2 A for 3 min – Adjustable)
<b>APSS active source open fault</b>	Lit up red Off	Fault affecting opening of the active source during APSS switching
<b>APSS backup source close fault</b>	Lit up red Off	Fault affecting closing of the backup source during APSS switching
<b>APSS conditions definition</b>	Lit up red Off	Automation locked as the result of a lack of switching conditions
<b>ASF opening fault</b> (by channel)	Lit up red Off	Channel opening fault as the result of ASF automation
<b>TCD fault</b> (by channel)	Lit up red Off	Switch O/C management system communication fault
<b>DD fault</b> (by channel)	Lit up red Off	Fault detection card communication fault or internal fault

Faults can also be viewed directly on the display.

## Maintenance/Equipment fault menu



### 4.3.4 Measurements and Counters Tab

e-RTU2020
Equipment
Fault
Measurements and Counters
Inputs / Outputs
Events
Local order
Downloading
IP tester
IP analyzer
IP traces
Serial traces
Communication and Protocols
Automation
Fault Detection
Delays and Alarms
Cyclic Measurement Recording
Telemetry
I/O Label
TSS Fault Grouping
Maintenance
Administrator Settings
System

Measurements and Counters			
LV voltage	224.0 V	MV voltage	19.5 kV
Average LV voltage (10 min)	224.0 V	Average MV voltage (10 min)	19.5 kV
12V voltage	13.4 V	Voltage 48V	48.2 V
Current 12V	0.0 A	Current 48V	0.0 A
CPU temperature	41 °C	Analog input 0-10V / 4-20mA	0 %
PT100 temperature	xx °C		

CHANNEL A	
I inst Phase 1	0.0 A
I inst Phase 2	0.0 A
I inst Phase 3	0.0 A
I inst avg	0.0 A
I avg (10 min)	0.0 A
I max	0.0 A
MV presence (Switch)	No
MV presence (PPACS)	No
Initialized Sensors (PPACS)	No
Number of Maneuvers	1
ASF Openings Number	0
Number of Earth Faults	0
Number of Phase Faults	1

CHANNEL B	
I inst Phase 1	0.0 A
I inst Phase 2	0.0 A
I inst Phase 3	0.0 A
I inst avg	0.0 A
I avg (10 min)	0.0 A
I max	0.0 A
MV presence (Switch)	No
MV presence (PPACS)	No
Initialized Sensors (PPACS)	No
Number of Maneuvers	1
ASF Openings Number	0
Number of Earth Faults	0
Number of Phase Faults	0

CHANNEL C	
I inst Phase 1	0.0 A
I inst Phase 2	0.0 A
I inst Phase 3	0.0 A
I inst avg	0.0 A
I avg (10 min)	0.0 A
I max	0.0 A
MV presence (Switch)	No
MV presence (PPACS)	No
Initialized Sensors (PPACS)	No
Number of Maneuvers	0
ASF Openings Number	0
Number of Earth Faults	0
Number of Phase Faults	0

CHANNEL D	
I inst Phase 1	0.0 A
I inst Phase 2	0.0 A
I inst Phase 3	0.0 A
I inst avg	0.0 A
I avg (10 min)	0.0 A
I max	0.0 A
MV presence (Switch)	No
MV presence (PPACS)	No
Initialized Sensors (PPACS)	No
Number of Maneuvers	0
ASF Openings Number	0
Number of Earth Faults	0
Number of Phase Faults	0

Settings	Possibilities	Definitions
LV voltage	0 to 999.9	LV voltage value in V
Average LV voltage	0 to 999.9	Averaged LV voltage value in V
MV voltage	0 to 99.9	Value of the MV voltage in kV originating from the LV
Average MV voltage	0 to 99.9	Averaged MV voltage value in kV
12 V voltage	0 to 99.9	Instantaneous value of the internal 12 V voltage in V
12 V current	0 to 9.9	Instantaneous current supplied to external elements (radio, etc.) in A
48 V voltage	0 to 99.9	Instantaneous value of the 48 V source in V
48 V current	0 to 9.9	Instantaneous current supplied to the switch
CPU temperature	± 99.9°	Internal temperature of the cabinet in degrees
PT100 temperature	± 999.9°	Temperature originating from the PT100 temperature sensor in degrees (see §1.2.4)



<b>Analogue input 0-10 V / 4-20 mA</b>	0 to 100%	Measurement as a % originating from the analogue sensor (see §1.2.4)
<b>Instantaneous current Phase 1</b> (by channel)	0 to 999	Instantaneous line current value for phase 1
<b>Instantaneous current Phase 2</b> (by channel)	0 to 999	Instantaneous line current value for phase 2
<b>Instantaneous current Phase 3</b> (by channel)	0 to 999	Instantaneous line current value for phase 3
<b>Average instantaneous current</b> (by channel)	0 to 999	Instantaneous value of three averaged line currents
<b>Average current (10mn)</b> (by channel)	0 to 999	Averaged instantaneous current
<b>Maximum current</b> (by channel)	0 to 999	Maximum instantaneous current
<b>MV available (DC)</b> (by channel)	Yes No	MV availability information originating from the switch connector (see §2.3.2.f)
<b>MV available (PPACS)</b> (by channel)	Yes No	MV availability information originating from the PPACS separable connector (see §2.3.2.d)
<b>Initialized sensor (PPACS)</b> (by channel)	Yes No	PPACS sensor initialised (see §4.3.13 Fault detection menu – directional)
<b>Switching operation counters</b> (by channel)	0 to 9999	Number of switching operations (1 switching operation = 1 opening + 1 closing)
<b>ASF opening counters</b> (by channel)	0 to 9999	Number of openings triggered by ASF automation
<b>Phase/earth fault</b> (by channel) (in amperometric detection mode only)	0 to 9999	Number of faults between phase and earth
<b>Fault between phases</b> (by channel) (in amperometric detection mode only)	0 to 9999	Number of faults between phases
<b>Red fault</b> (by channel) (in directional detection mode only)	0 to 9999	Number of red faults
<b>Green fault</b> (by channel) (in directional detection mode only)	0 to 9999	Number of green faults
<b>Poly fault</b> (by channel) (in directional detection mode only)	0 to 9999	Number of faults between phases (polyphase)

Measurements can also be viewed directly on the display.

### Measurements and Counters menus



## 4.3.5 Inputs / Outputs Tab

e-RTU2020	<b>Reserves</b>
Equipment	Libelle reserve 1 : Libelle reserve 3 : Libelle reserve 5 :
Fault	Libelle reserve 2 : Libelle reserve 4 : Libelle reserve 6 :
Measurements and Counters	
Inputs / Outputs	<b>Digital inputs</b>
Events	Libelle digital input 1 : Libelle digital input 3 : Libelle digital input 5 :
Local order	Libelle digital input 2 : Libelle digital input 4 :
Downloading	
IP tester	<b>Digital outputs</b>
IP analyzer	Libelle digital output 1 : Libelle digital output 3 :
IP traces	Libelle digital output 2 :
Serial traces	
Communication and Protocols	
Automation	
Fault Detection	
Delays and Alarms	
Cyclic Measurement Recording	
Telemetry	
I/O Label	
TSS Fault Grouping	
Maintenance	
Administrator Settings	
System	

Settings	Possibilities	Definitions
<b>Reserves 1 to 6</b>	Contact open or closed	Status of the reserves contact (see §2.3.2.e)
<b>Digital inputs 1 to 5</b>	Contact open or closed	Status of the dry contact at digital inputs (see §1.2.4)
<b>Digital outputs 1 to 5</b>	Contact open or closed	Status of the dry contact at digital output relays (see §1.2.4)

The labels are fully customisable (see §4.2.17 I/O labels)



### 4.3.6 Events tab

See §5.1.3

### 4.3.7 Local Command Tab

The screenshot shows the ENSTO 'Visualization' interface. At the top, there are flags for France, UK, and Spain, and a notification 'You are logged in as Administrator'. The sidebar menu on the left lists various system functions. The main area is titled 'Visualization' and contains a 'Local order' panel with buttons for: Reset Counters, LV Voltage Calibration, Detector Test, Change source APSS, Cyclic measurement file initialize, Voltage card calibration, Battery Test, Activate/Desactivate APSS, and Activate/Desactivate ASF. Below this are four channel status panels (CHANNEL A, B, C, D), each showing 'OPENING' and 'CLOSING' indicators and a current reading of 'I inst 0.0 A'. At the bottom, there is a 'Sorties TOR' panel with three buttons for 'Open close Libelle digital output 1', '2', and '3'.

This tab enables the actions that can be performed with the local UI to be performed locally.

This offers the option of performing opening and closing commands for a switch, following a maintenance operation on the latter, in complete safety and outside the substation.



Buttons	Actions	Local UI
Reset counters	Resets the switching operation counters	Configuration/Reset Counters
LV Voltage Calibration	Calibration of the LV voltage (correction of the LV/ELV transformer ratio, if necessary)	
Detector test	Runs a test of the detectors present (The fault LEDs flash)	Maintenance / Detector Test
Change APSS source	Changing the permitted switching direction	SOURCE button
Cyclic measurement file initialize	to start cyclic measurement recording (see §4.3.16)	
Calibration (directional only)	Calibration of PPACs (see §3.2.2. Directional)	
Battery Test	Initiation of the battery test procedure Result in the Fault tab (see §4.3.3)	Maintenance / Battery test
Activate/Deactivate the APSS	Turns the APSS function off	APSS button (on/off)
Activate/Deactivate ASF	Turns the ASF function off	ASF button (on/off)
Opening / Closing (by channel)	Switch opening or closing command (instantaneous current recalled for increased safety)	Switch Control Buttons CHANNEL / COMMAND VALIDATION / OPENING / CLOSING
Open/close digital outputs	Digital output command relayed. Position in the Inputs / Outputs tab (see §4.3.5)	

### 4.3.8 Downloading Tab

You are logged in as Administrator

## Visualization

	Downloading	
e-RTU2020	Maneuver counter file	<input type="button" value="Download"/>
Equipment	Fault counter file	<input type="button" value="Download"/>
Fault	Box description file	<input type="button" value="Download"/>
Measurements and Counters	EEMD file	<input type="button" value="Download"/>
Inputs / Outputs	Cyclic measurements file	<input type="button" value="Download"/>
Events	Average measurements file	<input type="button" value="Download"/>
Local order		
Downloading		
IP tester		
IP analyzer		

This tab allows files generated by the cabinet to be downloaded in .csv format, for direct export into excel type spreadsheets



### 4.3.9 IP Analyzer Tab

See §5.1.1

### 4.3.10 IP Traces Tab

See §5.1.2

### 4.3.11 Communication and Protocols Tab

#### 4.3.11.1 Ethernet tab

This tab enables definition of the IP addresses (V4) for the 2 Eth0 (COM) communication ports located on the back of the CPU2020 board (remote Ethernet connection in the communication area) and Eth2 (EXTENSION) on the front of the CPU2020 board.

Remember: the address of the Eth1 (CONFIGURATION) port is static (192.168.10.1)

IP routing can be adapted to all the routing options for IP networks.

The default address is recorded as 0.0.0.0

Settings	Possibilities	Definitions
Ethernet IP address eth0 (COM)	Xxx.Xxx.Xxx.Xxx	IP address(V4) that is assigned to the COM port of the e-RTU2020 cabinet
Ethernet mask eth0 (COM)	Xxx.Xxx.Xxx.Xxx	Subnet mask that is assigned to the COM port of the e-RTU2020 cabinet
Ethernet IP address eth2 (EXTENSION)	Xxx.Xxx.Xxx.Xxx	IP address (V4) that is assigned to the EXTENSION port of the e-RTU2020 cabinet





<b>Ethernet mask etho (COM)</b>	Xxx.Xxx.Xxx.Xxx	Subnet mask that is assigned to the EXTENSION port of the e-RTU2020 cabinet
<b>IP routing – Destination IP</b>	Xxx.Xxx.Xxx.Xxx	Destination address using the "IP Gateway" gateway on the "Interface" Ethernet port
<b>IP routing - Gateway IP</b>	Xxx.Xxx.Xxx.Xxx	IP address of the gateway used by the routing function
<b>IP routing - Interface</b>	Etho or Eth2	Ethernet port used by the routing function (etho COM or eth2 EXTENSION)



## 4.3.11.2 UART(COM) Tab

🇫🇷 🇬🇧 🇪🇸
You are logged in as Administrator [↗](#)

### Communication and Protocols

e-RTU2020

Return

Ethernet

Uart (COM)

Main Communication

Secondary Communication

**Uart (COM)**

Uart 1

COM COM1

Baudrate 9600

Parity Even

Number of bits 8

Stop bit (s) 1

RTS management No

Delay pre RTS (ms) 100

Delay post RTS (ms) 50

RTS polarity Normal

COM settings direct protocol (null modem)

Dialling buffer (ATD) ATD00000000

Uart 2

COM COM2

Baudrate 9600

Parity Even

Number of bits 8

Stop bit (s) 1

RTS management No

Delay pre RTS (ms) 0

Delay post RTS (ms) 0

RTS polarity Normal

Save

This tab enables configuration of the 2 serial communication ports UART 1 (COM1) and UART 2 (COM2)

Management of the RTS signal with pre-activation and post-activation delays provides a means to interface with transparent digital radios

Settings (UART 1 and UART 2)	Possibilities	Definitions
<b>Baud rate</b>	110 to 3686400 baud	
<b>Parity</b>	Even Odd None	
<b>Data bits</b>	7 or 8	
<b>Stop bit</b>	1 or 2	
<b>RTS management</b>	Yes No	
<b>Delay pre RTS</b>	0 to 500 ms	
<b>Delay post RTS</b>	0 to 500 ms	
<b>RTS polarity</b>	Normal Inverted	
<b>COM settings</b> (UART 1 only)	Direct protocol (null modem) AT command modem	Null modem or digital radio Modem using AT commands (GSM type). DTR used for command / line mode
<b>Dialling buffer (ATD)</b> (UART 1 and AT command modem only)	ATD<telephone number>	



### 4.3.11.3 Primary Communication Tab and Secondary Communication Tab

See specific protocol notices

### 4.3.12 Automation Tab

#### 4.3.12.1 ASF Tab

How the ASF function works is described in §4.1.4

Settings	Possibilities	Definitions
Function enabled	Yes No	Activation or deactivation of the ASF function
Voltage monitored during opening	None Cabinet power supply (LV) MV (DRS) MV (PPACS)	This setting involves opening only if the voltage selected is not present Voltage sensors see §2.3.2
ASF configuration (by channel)	Valid Invalid	Invalid disables the function on the specified channel
Opening during (by channel)	Slow 1 to 7	Opening of the switch after the 1st and 7th fault
Fault configuration (by channel) (in directional only)	Red Green	Defines the type of fault triggering opening
Minimum time between 2 faults	100 to 5000 ms	Time between 2 faults in order for the fault to be counted
ASF Standby Timeout	15 to 240s	Return to the initial automation state after the timeout
ASF opening time delay	0 to 5000 ms	Opening time delay in relation to the time when the ASF conditions are met
Opening supervision delay on ASF	1 to 50s	Opening delay as the result of ASF automation. The expiry of this period without a return to the "open" position, creates an "ASF opening on" fault

4PR-F14-D



## 4.3.12.2 APSS Tab

You are logged in as Administrator

### ENSTO

e-RTU2020

Return

ASF

ASPP

### Automation

#### ASPP

Active function	No
Source 1 configuration	Channel A
+	None
+	None
Source 2 configuration	Channel B
+	None
+	None
Type of automation	Full
Number of attempts	3
Automatic return to main source	No
Cancel time permut. on active Src voltage return (T3s) (ms)	3000
Time out permutation (T3mn) (s)	180
Switchover delay (s)	45
Cell opening monitoring delay on ASPP (s)	10
Cell closing monitoring delay on ASPP (s)	10
Time between 2 attempts (ms)	150

Save

Settings	Possibilities	Definitions
<b>Function active</b>	Yes No	Activate or deactivate the APSS function
<b>Configuration sources 1 (Active sources)</b>	None Channel A Channel B Channel C Channel D	Choice of channels associated with source 1
<b>Configuration sources 2 (Backup sources)</b>	None Channel A Channel B Channel C Channel D	Choice of channels associated with source 2
<b>Type of automation</b>	Simplified complete	If complete, take account of locking for MV faults
<b>Number of switching attempts</b>	1 to 3	Number of switching attempts in the event of a failure
<b>Automatic return to primary source</b>	Yes No	Automatic return to Source 1 upon the return of voltage to it
<b>Time to abandon return to active source upon voltage return</b>	1 to 10 sec	Cancel switching in progress if active Source voltage is present during this time
<b>Delay on switching</b>	1 to 60 sec	Delay on switching
<b>Monitoring time for cell opening on APSS</b>	1 to 50 sec	Opening time for active source subsequent to APSS automated system. The expiry of this period without a return to the "open" position, creates an "APSS open" fault
<b>Monitoring time for cell closing on APSS</b>	1 to 50 sec	Closing time for active source subsequent to APSS automated system. The expiry of this period without a return to the "closed" position, creates an "APSS closed" fault
<b>Time between 2 attempts</b>	0 to 1000 ms	Time delay between 2 switching attempts



### 4.3.13 Fault Detection Tab

The list of types of fault detections managed by the electronics installed in the equipment is available in the “Fault Detection” tab.

It relates directly to the type of neutral point treatment used.

Contact Ensto novexia for more information.

#### 4.3.13.1 Overcurrent Fault Detection Tab

Amperemetric Fault Detection	
Earth current channel A (A)	40
Earth current channel B (A)	40
Earth current channel C (A)	40
Earth current channel D (A)	40
Time taken into account earth fault current (ms)	80
Phase current Channel A (A)	450
Phase current Channel B (A)	450
Phase current Channel C (A)	450
Phase current Channel D (A)	450
IDouble Channel A (A)	1200
IDouble Channel B (A)	1200
IDouble Channel C (A)	1200
IDouble Channel D (A)	1200
Time for taking into account phase and double fault (ms)	80
SPI activation time (ms)	250
Minimum SPI signaling time (s)	3
Reset detector by LV presence	Yes
Detector reset by MV presence(switch)	No
Detector reset by MV presence(PPACS)	No
Reset detector by current presence	No
Reset detector by time delay	Yes
SPI maximum time signaling (s)	7200

Settings	Possibilities	Definitions
<b>Homopolar current</b> (by channel)	20 A to 240 A	Detection of an earth fault if the residual current is above the threshold for an interval longer than the time for triggering detection of the homopolar current
<b>Homopolar fault trigger time</b>	30 to 30000 ms	Minimum earth fault time
<b>Phase current</b> (by channel)	250 A to 1600 A	Detection of a phase fault if at least one of the two line currents is above the configured threshold

4PR-F14-D

Double current (by channel)	250 A to 1200 A	Detection of a phase fault if the residual current is above the threshold for an interval longer than the time for triggering detection of the phase fault
Phase and double fault trigger time	30 to 3000 ms	Minimum phase fault time
SPI activation time	30 to 10000 ms	Minimum fault time for validating the related SPI
Minimum SPI signalling time	0 to 60s	Minimum time for maintaining the fault SPI
Reset detector if LV available	No Yes	Allows the fault detector to be reset if LV voltage is available
Reset detector if line current available	No Yes	Allows the fault detector to be reset if line current is available (>5 A)
Reset detector by time delay	No Yes	Allows the fault detector to be reset at the end of the "Maximum SPI signalling time" timeout
Maximum SPI signalling time	1s to 10,800s (3 h)	

### 4.3.13.2 Directional Fault Detection Tab

Directional detection in accordance with HN 45 S 51 (EDF)



Settings	Possibilities	Definitions
Phase current (by channel)	100 A to 1000 A	Detection of a phase fault if at least one of the two line currents is above the configured threshold.
Double current (by channel)	250 A to 1000 A	Detection of a double fault if the residual current is above the configured threshold
Homopolar peak threshold (APK)	10 to 100 APK	green or red fault Refer to specification HN 54-S51 for the operating principle
Homopolar voltage peak threshold (VPK)	2,000 to 10,000 VPK	green or red fault Refer to specification HN 54-S51 for the operating principle
Homopolar voltage confirmation threshold (Vrms)	1,000 to 6,000 Vrms	green or red fault Refer to specification HN 54-S51 for the operating principle
Homopolar detection sensitivity pre-selection	Preset 1 Preset 2	green or red fault Refer to specification HN 54-S51 for the operating principle

MV availability trigger time	100 to 10000 ms	Refer to specification HN 54-S51 for the operating principle
SPI availability trigger time	0 to 70s	Delay before SPI activation
Max SPI time	1s to 10,800s (3 h)	Remote signalling duration if no MV

## 4.3.14 Delays and Alarms Tab

### 4.3.14.1 TS Delay Tab

This tab allows a delay to be defined between the physical appearance of a status and the positioning of the related TS (information recorded by protocol)

You are logged in as Administrator 



## Delays and Alarms

e-RTU2020

← Return

TS delay

TS alarm

TS delay

ASF ES / HS (ms)	0
APSS ES / HS (ms)	0
Position Channel A (ms)	0
Position Channel B (ms)	0
Position Channel C (ms)	0
Position Channel D (ms)	0
Absence Ubt (ms)	0
Persistent Ubt absence (ms)	0
Local (ms)	0
Battery fault (ms)	0
Equipment fault (ms)	0
Card fault (ms)	0
Internal fault (ms)	0
Urgent fault (ms)	0
Non-urgent fault (ms)	0
Blocked Channel A (ms)	0
Blocked Channel B (ms)	0
Blocked Channel C (ms)	0
Blocked Channel D (ms)	0
MV presence Channel A (ms)	0
MV presence Channel B (ms)	0
MV presence Channel C (ms)	0
MV presence Channel D (ms)	0

### 4.3.14.2 TS Alarm Tab

This tab allows the TSs generating a call (use of a line) to be configured.

This configuration is only used when a modem is used with a non-permanent connection (GSM type – AT command see §4.3.11.2)



### 4.3.15 Cyclic measurement recording tab

This tab allows cyclic measurement recording in a .csv format file, for direct export into an Excel type spreadsheet, to be configured.

The file size is 100k, enabling more than 10,000 measurements to be recorded

Should the capacity be exceeded, the file is saved by after-sales service and a new one is created.



## Cyclic Measurement Recording

e-RTU2020	<b>General</b>
Return	activated <input type="text" value="No"/>
General	Recording frequency (s) <input type="text" value="60"/>
Definition of recorded tm	<input type="button" value="Save"/>

Settings	Possibilities	Definitions
Enabled	No Yes	Activation of cyclic measurement recording
Recording frequency	1 to 100s	



## Cyclic Measurement Recording

e-RTU2020	<b>Definition of recorded tm</b>
Return	U BT <input type="text" value="No"/>
General	12V voltage <input type="text" value="No"/>
Definition of recorded tm	12V current <input type="text" value="No"/>
	48V voltage <input type="text" value="No"/>
	48V current <input type="text" value="No"/>
	HTA Voltage <input type="text" value="No"/>
	CPU temperature <input type="text" value="No"/>
	External temperature sensor (PT100) <input type="text" value="No"/>
	Analog input Value <input type="text" value="No"/>
	Instantaneous current phase1 Channel A <input type="text" value="No"/>
	Instantaneous current phase2 Channel A <input type="text" value="No"/>
	Instantaneous current phase3 Channel A <input type="text" value="No"/>
	Instantaneous current Channel A <input type="text" value="No"/>
	Instantaneous current phase1 Channel B <input type="text" value="No"/>
	Instantaneous current phase2 Channel B <input type="text" value="No"/>
	Instantaneous current phase3 Channel B <input type="text" value="No"/>
	Instantaneous current Channel B <input type="text" value="No"/>
	Instantaneous current phase1 Channel C <input type="text" value="No"/>
	Instantaneous current phase2 Channel C <input type="text" value="No"/>
	Instantaneous current phase3 Channel C <input type="text" value="No"/>
	Instantaneous current Channel C <input type="text" value="No"/>
	Instantaneous current phase1 Channel D <input type="text" value="No"/>
	Instantaneous current phase2 Channel D <input type="text" value="No"/>
	Instantaneous current phase3 Channel D <input type="text" value="No"/>
	Instantaneous current Channel D <input type="text" value="No"/>
	Average current Channel A <input type="text" value="No"/>
	Average current Channel B <input type="text" value="No"/>
	Average current Channel C <input type="text" value="No"/>
	Average current Channel D <input type="text" value="No"/>
	Average current time <input type="text" value="No"/>
	Maximum current Channel A <input type="text" value="No"/>
	Maximum current Channel B <input type="text" value="No"/>
	Maximum current Channel C <input type="text" value="No"/>
	Maximum current Channel D <input type="text" value="No"/>
	Voltage Average Time <input type="text" value="No"/>
	Voltage Average <input type="text" value="No"/>
	HTA Voltage Average <input type="text" value="No"/>
	<input type="button" value="Save"/>

4PR-F14-D





### 4.3.16 Analog Input Tab

#### 4.3.16.1 Time averages tab

This tab allows the voltage (LV and MV) and average current information to be defined by channel. The time averages are synchronised at a fixed time taking account of the averaging duration. For example: for a programmed 10-min period, an average value is calculated at Xh10mn, Xh20mn, Xh30mn, etc.

#### 4.3.16.2 Dead Bands Tab (Sampling / Threshold and variation)

These tabs allow the conditions for updating AIs available for communication (see protocol notices) to be defined

Settings	Possibilities	Definitions
Recording frequency	1 to 105	At refresh frequency and "Thresholds and variations" management



e-RTU2020

[Return](#)

[Time averages](#)

[Dead Bands - Sampling](#)

[Dead Bands - Thresholds and Variations](#)

### Dead Bands - Thresholds and Variations

	Coefficient	Rate variation	Mini variation	Low threshold	High threshold
Voltage bt (V)	1	20	20	0	400
MV voltage (V)	1	20	1000	0	40000
Voltage 12V (V)	1	20	1	0	16
Voltage 48V (V)	1	20	5	0	56
Current 12V (A)	1	20	1	0	10
Current 48V (A)	1	20	1	0	10
CPU temperature (°C)	1	20	20	0	100
PT100 temperature (°C)	1	20	20	0	100
Instantaneous current channel A (A)	1	20	5	0	700
Instantaneous current channel B (A)	1	20	5	0	700
Instantaneous current channel C (A)	1	20	5	0	700
Instantaneous current channel D (A)	1	20	5	0	700
Instantaneous current ph1 vA (A)	1	20	5	0	700
Instantaneous current ph2 vA (A)	1	20	5	0	700
Instantaneous current ph3 vA (A)	1	20	5	0	700
Instantaneous current ph1 vB (A)	1	20	5	0	700
Instantaneous current ph2 vB (A)	1	20	5	0	700
Instantaneous current ph3 vB (A)	1	20	5	0	700
Instantaneous current ph1 vC (A)	1	20	5	0	700
Instantaneous current ph2 vC (A)	1	20	5	0	700
Instantaneous current ph3 vC (A)	1	20	5	0	700
Instantaneous current ph1 vD (A)	1	20	5	0	700
Instantaneous current ph2 vD (A)	1	20	5	0	700
Instantaneous current ph3 vD (A)	1	20	5	0	700
Maximum current channel A (A)	1	20	5	0	700
Maximum current channel B (A)	1	20	5	0	700
Maximum current channel C (A)	1	20	5	0	700
Maximum current channel D (A)	1	20	5	0	700
Average current channel A (A)	1	20	5	0	700
Average current channel B (A)	1	20	5	0	700
Average current channel C (A)	1	20	5	0	700
Average current channel D (A)	1	20	5	0	700
Current average duration (s)	1	20	20	0	3600
Average voltage bt (V)	1	20	20	0	400
Average MV voltage (V)	1	20	1000	0	40000
Average voltage duration (s)	1	20	20	0	3600
Analog input (%)	1	20	20	0	100

[Save](#)

Settings	Possibilities	Definitions
<b>Variation rate</b> (for each item)	0 to 100%	Variation rate of a measurement for spontaneous transmission of a AI
<b>Mini variation</b> (for each item)	Measurement range and unit	Minimum variation of the measurement for transmission.
<b>Low threshold</b> (for each item)	Measurement range and unit	Minimum and Maximum permitted measurements (AI invalid outside these ranges)
<b>High threshold</b> (for each item)	Measurement range and unit	



## 4.3.17 I/O Label Tab

### 4.3.17.1 Reserves Tab

This tab enables you to customise the Reserved connection inputs (see §2.3.2.e)

Reserves	
Reserve 1	Libelle reserve 1
Reserve 2	Libelle reserve 2
Reserve 3	Libelle reserve 3
Reserve 4	Libelle reserve 4
Reserve 5	Libelle reserve 5
Reserve 6	Libelle reserve 6

Example:

Reserve 5: “Locking switching” if the APSS function is used

Reserve 3: “Water level”

### 4.3.17.2 Digital Inputs and Digital Output Tab

This tab allows the digital inputs and outputs to be customised (see §1.2.4)

Digital inputs	
Digital Input 1	Libelle digital input 1
Digital Input 2	Libelle digital input 2
Digital Input 3	Libelle digital input 3
Digital Input 4	Libelle digital input 4
Digital Input 5	Libelle digital input 5

Digital outputs	
Digital Output 1	Libelle digital output 1
Digital Output 2	Libelle digital output 2
Digital Output 3	Libelle digital output 3



### 4.3.18 SPI Fault Grouping Tab

The SPI fault groupings are SPIs allowing an SPI to be linked to various pieces of equipment fault information.

The e-RTU2020 cabinet offers 3 manufacturer SPI groupings (fixed) and 2 user SPI groupings (configurable)

#### Manufacturer SPI

- Equipment fault  
This fault is created for all equipment faults.  
Information relating to the equipment fault indicator light on the front.
- Board fault  
Fault relating to the electronics.
- Internal fault  
Equivalent to a board fault + faults relating to automation  
Information relating to the internal fault indicator light on the front  
(Display type = Type 1 – see §4.3.20).

#### User SPI:

- Urgent fault
- Non-urgent fault

#### 4.3.18.1 Manufacturer SPI

Board fault	Internal fault	Equipment fault
CPU board fault	<b>Board fault</b>	<b>Internal fault</b>
Display board fault	ASF opening fault (by channel)	Battery fault
Charger card fault (COM)	APSS active source opening fault	No AC voltage
DC electronic fault (by channel)	APSS backup source closing fault	Prolonged lack of AC voltage
Reserves electronic fault (board 1 and 2)	APSS condition not met fault	Charger fault (12V)
Fault detector board fault (by channel)		Converter fuse fault
Converter board fault		Prolonged over-consumption of external 12 V (max. radio current)
Measurement board fault (overhead only)		SF6 pressure drop (Overhead only)
16 I/O board fault		
PPACS (VT) voltage electronic fault (Underground: board 1 and 2,		

4PR-F14-D

Overhead: voltage board)		
Motor control fuse fault (overhead only)		

### 4.3.18.2 User SPI

🇫🇷 🇬🇧 🇪🇸
You are logged in as Administrator



## TSS Fault Grouping

e-RTU2020

[Return](#)

Definition SPI urgent fault

SPS non-urgent fault definition

Definition SPI urgent fault		
Power Voltage fault	No	▼
Prolonged Power Voltage fault	No	▼
Charger fault (12V)	No	▼
Charger fault (COM)	No	▼
Battery fault	No	▼
Motor fuse fault	No	▼
Converter fault	No	▼
Converter fuse fault	No	▼
Prolonged I <sub>max</sub> radio	No	▼
SF6 fault	No	▼
Display fault	No	▼
Electronic command fault Channel A	No	▼
Electronic command fault Channel B	No	▼
Electronic command fault Channel C	No	▼
Electronic command fault Channel D	No	▼
Fault reserves card 1	No	▼
Detector fault Channel A	No	▼
Detector fault Channel B	No	▼
Detector fault Channel C	No	▼
Detector fault Channel D	No	▼
Measurement card fault	No	▼
IO board fault	No	▼
TT1 fault (PPACS)	No	▼
CPU board fault	No	▼
Open active source fault APSS	No	▼
Close backup source fault APSS	No	▼
APSS conditions fault	No	▼
Open fault ASF Channel A	No	▼
Open fault ASF Channel B	No	▼
Open fault ASF Channel C	No	▼
Open fault ASF Channel D	No	▼
Libelle reserve 1	No	▼
Libelle reserve 2	No	▼
Libelle reserve 3	No	▼
Libelle reserve 4	No	▼
Libelle reserve 5	No	▼
Libelle reserve 6	No	▼
Libelle digital input 1	No	▼
Libelle digital input 2	No	▼
Libelle digital input 3	No	▼
Libelle digital input 4	No	▼
Libelle digital input 5	No	▼



## 4.3.19 Maintenance Tab

### 4.3.19.1 General Configuration Tab

You are logged in as Administrator

ENSTO

Maintenance

e-RTU2020

Return

General configuration

Anti Rebound Inputs

Charger Card

General configuration

Box language	English	▼
HMI standby	Yes	▼
Time before standby (s)	180	
Date change registration (EEMD)	Yes	▼
Box Reference	200XXXX	
Box serial number	200XXXX	
Box designation	e-RTU2020	
Time synchronization (Protocols)	Local	▼

Save

Settings	Possibilities	Definitions
Cabinet language	English English Spanish	
UI standby	No Yes	Local UI indicator lights off in <u>remote</u> mode at the end of "Time before standby". Only the "Equipment in standby" or "equipment fault" indicator lights are on.
Time before standby	10 to 600s	
Date recorded maintenance events (DRME)	No Yes	Registration of a date event when the day is changed
Cabinet Reference		ensto cabinet code
Cabinet serial number		To be entered for after-sales service contacts
Cabinet description		Free field for cabinet name Default name: e-RTU2020
Time synchronisation (Protocols)	Local UTC-12 to UTC+14	Time adjustment by protocol if required by SCADA

### 4.3.19.2 Anti Rebound Tab

This tab allows you to configure the anti-rebound times for Reserve inputs (see §2.3.2.e) and digital inputs (see §1.2.4)

These inputs can be connected to various sensors by the user, it is sometimes necessary to adjust the input's sensitivity.

Example: anti-rebound of 1 sec for a door contact to prevent unintentional status changes due to vibrations (a truck passing nearby) or atmospheric factors (wind).

## ENSTO

### Maintenance

- e-RTU2020
- Return
- General configuration
- Anti Rebound Inputs
- Charger Card

Anti Rebound Inputs	
Libelle reserve 1 (ms)	0
Libelle reserve 2 (ms)	0
Libelle reserve 3 (ms)	0
Libelle reserve 4 (ms)	0
Libelle reserve 5 (ms)	0
Libelle reserve 6 (ms)	0
Libelle digital input 1 (ms)	100
Libelle digital input 2 (ms)	100
Libelle digital input 3 (ms)	100
Libelle digital input 4 (ms)	100
Libelle digital input 5 (ms)	100

Save

Settings	Possibilities	Definitions
Anti rebound (for each item)	0 to 1000 ms	

#### 4.3.19.3 Charger card tab

This tab enables you to configure allows the power supply settings (Charger card)

## ENSTO

### Maintenance

- e-RTU2020
- Return
- General configuration
- Anti Rebound Inputs
- Charger Card

Charger Card	
LV / ELV transformer ratio	230V / 26V transformer
Coefficient for LV calibration (%)	100
MV network voltage (V)	20000
Prolonged lack of LV time (h)	16
Imax Radio (mA)	2500
Time Before Radio Outage (mn)	3

Save

Settings	Possibilities	Definitions
LV / ELV transformer ratio	230 V / 26 V transformer 58 V / 26 V transformer 135 V / 26 V transformer 101 V / 26 V transformer 270 V / 26 V transformer	Definition of the transformation ratio value for the cabinet's LV/ELV transformer
Coefficient for LV calibration	1 to 200%	Correction of the LV measurement error. The coefficient is calculated automatically by a simple measurement of the voltage at the cabinet's input. See §4.2.7
MV network voltage	5,000 to 30,000 V	MV network voltage for calculating the MV voltage analog input with the LV measurement
Prolonged lack of LV time	1 to 48 h	Time before outage
Imax Radio	200 to 4000 mA	Defines the maximum current consumed by the communication device (radio) when transmitting. In the event that this threshold is exceeded during the "Time Before Radio outage", the device power supply is cut off
Time Before Radio Outage	1 to 1000 mn	

4PR-F14-D



## 4.3.20 Administrator Settings Tab (Administrator user only)

### 4.3.20.1 General Configuration Tab

This tab defines and allows the cabinet’s specific features and options to be configured

These settings are factory-set on the basis of the cabinet’s configuration and the customer’s requirements



Settings	Possibilities	Definitions
<b>Cabinet type</b>	Underground Overhead (Auguste) Overhead (Other)	Determines the type of cabinet based on its operation
<b>Display type</b>	Type 1 (internal fault) Type 2	Definition of the Display board installed in the cabinet. Type 2 display for overhead only
<b>Upstream and downstream voltage LEDs (Type 2 disp.)</b>	Yes No	Upstream voltage/downstream voltage availability LED management options with Type 2 display only
<b>Fault Visualization (Earth/phase)</b>	Type 1 (Red/Red+Green)  Type 2 (Green/Red)	Red light for an Earth fault (homopolar) Red+green lights for a Phase fault (polyphase) Green light for an Earth fault (homopolar) Red light for a Phase fault (polyphase)
<b>Automation selection method</b>	ASF/APSS button ASF/APSS + COMMAND VALIDATION button	Automation enabled by pressing the button Automation enabled by pressing the button and the COMMAND VALIDATION button at the same time





### 4.3.20.2 Daily Reboot Tab

This tab allows daily Reboots (restarts) of the cabinet to be enabled and configured.

You are logged in as Administrator 

## ENSTO

- e-RTU2020
- [Return](#)
- [General configuration](#)
- [Daily reboot](#)
- [Command timers](#)
- [Absence SF6](#)

## Administrator Settings



Daily reboot

Daily reboot CPU	Inactive	▼
Hour	0	
Minute	0	
Daily reboot Peripherals	Inactive	▼
Hour	0	
Minute	0	

Settings	Possibilities	Definitions
Daily reboot CPU	Inactive active	Daily reboot of the CPU Equivalent to a reboot command (see System configuration guide)
Daily reboot Peripherals	Inactive active	Daily reboot of peripherals (display boards, charger, fault detection, communication device, etc.)

### 4.3.20.3 Command time delay tab

This tab allows the commands to be set

You are logged in as Administrator 

## ENSTO

- e-RTU2020
- [Return](#)
- [General configuration](#)
- [Daily reboot](#)
- [Command timers](#)
- [Absence SF6](#)

## Administrator Settings

Command timers

command pulse duration (ms)	10000	
command monitoring time (ms)	10000	
time no complementarity Channel A (ms)	10000	
time no complementarity Channel B (ms)	10000	
time no complementarity Channel C (ms)	10000	
time no complementarity Channel D (ms)	10000	

Settings	Possibilities	Definitions
Command pulse duration	10 to 10000 ms	Period during which the control voltage is applied at the opening and closing command output
Command monitoring time	10 to 10000 ms	Period during which the return of the position for signalling transmission to SCADA is expected (at the end of the period, the position is transmitted)

4PR-F14-D

No complementarity time (By channel)	10 to 10000 ms	Time during which no complementarity information is permitted (This corresponds to the max. time for physically executing the switching operation)
---	----------------	--

### 4.3.21 System Tab

This tab allows the firmware to be updated, the configuration to be loaded (PC -> cabinet) or downloaded (Cabinet ->PC), the time to be set for the cabinet and the entire system to be configured (Users, Firewall, VPN tunnel, etc.)

[See System configuration guide](#)



## 5 MAINTENANCE

5.1. Preventive

5.2. Corrective



## 5.1 PREVENTIVE

The e-RTU2020 cabinet allows the connections and data transmitted via IP communication devices to be analysed by means of the configuration PC.

### 5.1.1 IP analyzer

The “IP Analyzer” tab allows the connections to the 3 IP ports of the e-RTU2020 cabinet to be identified and quantified.

You are logged in as Administrator

ENSTO

Visualization

e-RTU2020	IP analyzer: eth0
Equipment	Number of incoming data
Fault	- octets
Measurements and Counters	Number of outgoing data
Inputs / Outputs	- octets
Events	Incoming IP
Local order	
Downloading	
IP tester	IP analyzer: eth1
IP analyzer	Number of incoming data
IP traces	185399433 octets
Serial traces	Number of outgoing data
Communication and Protocols	237470505 octets
Automation	Incoming IP
Fault Detection	192.168.10.2
Delays and Alarms	IP analyzer: eth2
Cyclic Measurement Recording	Number of incoming data
Telemetry	- octets
I/O Label	Number of outgoing data
TSS Fault Grouping	- octets
Maintenance	Incoming IP
Administrator Settings	
System	



## 5.1.2 IP traces

The “IP traces” tab allows the protocol frames of IP-based protocols (IEC 104, DNP3 IP) to be displayed.

Filters provide assistance for decoding frames on the basis of protocols.

Exchanges logged may be saved in a .txt file for analysis.

See protocol notices for more information on decoding.

## 5.1.3 Visualization of Dated Recorded Maintenance Events (DRME):

The cabinet stores a stack of a minimum of 10,000 dated events (1MB file), which can be viewed via the "Dated Recorded Maintenance Event (DRME)" HTML page.

Should the capacity be exceeded, the file is saved by after-sales service and a new one is created.



**It is impossible to delete an event.**

The screenshot shows the ENSTO web interface. At the top, there are flags for France, UK, and Spain, and a login status 'You are logged in as Administrator'. The main content area is titled 'Visualization' and contains a table of events. The table has columns for date, time, code, and description. The events listed include 'Restart Runtime', 'Start equipment', 'End digital output 1 (Libelle digital output 1)', 'End digital output 2 (Libelle digital output 2)', 'End digital output 3 (Libelle digital output 3)', 'AC power supply ON', 'Remote Mode', 'Local Mode', 'Selected channel A for manoeuvring', 'Request of manual closing channel A', 'Switch Closing channel A', 'Remote Mode', 'Local Mode', 'Selected channel B for manoeuvring', 'Request of manual closing channel B', 'Switch Closing channel B', 'Selected channel A for manoeuvring', and 'Display test'.

The DRMEs are events relating to the operation of the network and the cabinet

It is possible to save the events file (.csv) with the aid of the **“Download”** button.

A list of DRMEs and their numbers appears below.

code	Label
1	No voltage >2h
2	Charger card fault
3	Prolonged lack of voltage
4	Blacklisted number
5	drme stack full
6	Local
7	Remote
8	12 V fault (start)
9	12 V fault (end)
10	DC voltage fault (start)
11	DC voltage fault (end)
12	Battery fault (start)
13	Battery fault (end)
14	Autonomous supply backup (start)
15	Autonomous supply backup (end)
16	LV available
17	No LV



18	Red fault channel A
19	Red fault channel B
20	Red fault channel C
21	Red fault channel D
22	Red fault channel E
23	Red fault channel F
24	Red fault channel G
25	Red fault channel H
26	Green fault channel A
27	Green fault channel B
28	Green fault channel C
29	Green fault channel D
30	Green fault channel E
31	Green fault channel F
32	Green fault channel G
33	Green fault channel H
418	Earth fault channel A
419	Earth fault channel B
420	Earth fault channel C
421	Earth fault channel D
422	Earth fault channel E
423	Earth fault channel F
424	Earth fault channel G
425	Earth fault channel H
34	Phase fault channel A
35	Phase fault channel B
36	Phase fault channel C
37	Phase fault channel D
38	Phase fault channel E
39	Phase fault channel F
40	Phase fault channel G
41	Phase fault channel H
42	Permanent transmission
43	Selection of channel A for operation
44	Selection of channel B for operation
45	Selection of channel C for operation
46	Selection of channel D for operation
47	Selection of channel E for operation
48	Selection of channel F for operation
49	Selection of channel G for operation
50	Selection of channel H for operation
51	Manual opening request channel A

4PR-F14-D



52	Manual opening request channel B
53	Manual opening request channel C
54	Manual opening request channel D
55	Manual opening request channel E
56	Manual opening request channel F
57	Manual opening request channel G
58	Manual opening request channel H
59	Manual closing request channel A
60	Manual closing request channel B
61	Manual closing request channel C
62	Manual closing request channel D
63	Manual closing request channel E
64	Manual closing request channel F
65	Manual closing request channel G
66	Manual closing request channel H
67	Remote controlled opening request channel A
68	Remote controlled opening request channel B
69	Remote controlled opening request channel C
70	Remote controlled opening request channel D
71	Remote controlled opening request channel E
72	Remote controlled opening request channel F
73	Remote controlled opening request channel G
74	Remote controlled opening request channel H
75	Remote controlled closing request channel A
76	Remote controlled closing request channel B
77	Remote controlled closing request channel C
78	Remote controlled closing request channel D
79	Remote controlled closing request channel E
80	Remote controlled closing request channel F
81	Remote controlled closing request channel G
82	Remote controlled closing request channel H
83	Channel A opening
84	Channel B opening
85	Channel C opening
86	Channel D opening
87	Channel E opening
88	Channel F opening
89	Channel G opening
90	Channel H opening
91	Channel A closing
92	Channel B closing
93	Channel C closing

4PR-F14-D





94	Channel D closing
95	Channel E closing
96	Channel F closing
97	Channel G closing
98	Channel H closing
99	Blocked channel A (start)
100	Blocked channel B (start)
101	Blocked channel C (start)
102	Blocked channel D (start)
103	Blocked channel E (start)
104	Blocked channel F (start)
105	Blocked channel G (start)
106	Blocked channel H (start)
107	Blocked channel A (end)
108	Blocked channel B (end)
109	Blocked channel C (end)
110	Blocked channel D (end)
111	Blocked channel E (end)
112	Blocked channel F (end)
113	Blocked channel G (end)
114	Blocked channel H (end)
115	Start signalling closing heartbeat channel A
116	Start signalling closing heartbeat channel B
117	Start signalling closing heartbeat channel C
118	Start signalling closing heartbeat channel D
119	Start signalling closing heartbeat channel E
120	Start signalling closing heartbeat channel F
121	Start signalling closing heartbeat channel G
122	Start signalling closing heartbeat channel H
123	Start signalling opening heartbeat channel A
124	Start signalling opening heartbeat channel B
125	Start signalling opening heartbeat channel C
126	Start signalling opening heartbeat channel D
127	Start signalling opening heartbeat channel E
128	Start signalling opening heartbeat channel F
129	Start signalling opening heartbeat channel G
130	Start signalling opening heartbeat channel H
131	End signalling closing heartbeat channel A
132	End signalling closing heartbeat channel B
133	End signalling closing heartbeat channel C
134	End signalling closing heartbeat channel D
135	End signalling closing heartbeat channel E

4PR-F14-D



136	End signalling closing heartbeat channel F
137	End signalling closing heartbeat channel G
138	End signalling closing heartbeat channel H
139	End signalling opening heartbeat channel A
140	End signalling opening heartbeat channel B
141	End signalling opening heartbeat channel C
142	End signalling opening heartbeat channel D
143	End signalling opening heartbeat channel E
144	End signalling opening heartbeat channel F
145	End signalling opening heartbeat channel G
146	End signalling opening heartbeat channel H
147	ASF configuration channel A
148	ASF configuration channel B
149	ASF configuration channel C
150	ASF configuration channel D
151	ASF configuration channel E
152	ASF configuration channel F
153	ASF configuration channel G
154	ASF configuration channel H
155	ASF configuration channel A green fault
156	ASF configuration channel B green fault
157	ASF configuration channel C green fault
158	ASF configuration channel D green fault
159	ASF configuration channel E green fault
160	ASF configuration channel F green fault
161	ASF configuration channel G green fault
162	ASF configuration channel H green fault
163	ASF configuration channel A red fault
164	ASF configuration channel B red fault
165	ASF configuration channel C red fault
166	ASF configuration channel D red fault
167	ASF configuration channel E red fault
168	ASF configuration channel F red fault
169	ASF configuration channel G red fault
170	ASF configuration channel H red fault
171	ASF function activation
172	ASF function deactivation
173	ASF turned on locally
174	ASF turned off locally
175	ASF turned on by remote control
176	ASF turned off by remote control
177	ASF opening request channel A

4PR-F14-D



178	ASF opening request channel B
179	ASF opening request channel C
180	ASF opening request channel D
181	ASF opening request channel E
182	ASF opening request channel F
183	ASF opening request channel G
184	ASF opening request channel H
185	ASF opening fault channel A
186	ASF opening fault channel B
187	ASF opening fault channel C
188	ASF opening fault channel D
189	ASF opening fault channel E
190	ASF opening fault channel F
191	ASF opening fault channel G
192	ASF opening fault channel H
193	Simplified APSS configuration
194	Complete APSS configuration
195	Change to APSS source 1
196	Change to APSS source 2
197	APSS direction: Src1 -> Src2
198	APSS direction: Src1 <-> Src2
199	APSS direction: Src2 -> Src1
200	APSS function activation
201	APSS function deactivation
202	APSS turned on locally
203	APSS turned off locally
204	APSS turned on by remote control
205	APSS turned off by remote control
206	No voltage APSS source 1
207	Voltage available APSS source 1
208	No voltage APSS source 2
209	Voltage available APSS source 2
210	APSS switching (start)
211	APSS switching (end)
212	Locking APSS switching (start)
213	Locking APSS switching (end)
214	APSS switching cancelled
215	APSS opening request channel A
216	APSS opening request channel B
217	APSS opening request channel C
218	APSS opening request channel D
219	APSS opening request channel E



220	APSS opening request channel F
221	APSS opening request channel G
222	APSS opening request channel H
223	APSS closing request channel A
224	APSS closing request channel B
225	APSS closing request channel C
226	APSS closing request channel D
227	APSS closing request channel E
228	APSS closing request channel F
229	APSS closing request channel G
230	APSS closing request channel H
231	APSS active source opening fault
232	APSS backup source closing fault
233	Equipment reset
234	Equipment start-up
235	Display test
236	Urgent external fault (start)
237	Urgent external fault (end)
238	Non-urgent external fault (start)
239	Non-urgent external fault (end)
240	MV available (functional unit info) channel A
241	MV available (functional unit info) channel B
242	MV available (functional unit info) channel C
243	MV available (functional unit info) channel D
244	MV available (functional unit info) channel E
245	MV available (functional unit info) channel F
246	MV available (functional unit info) channel G
247	MV available (functional unit info) channel H
248	No MV (functional unit info) channel A
249	No MV (functional unit info) channel B
250	No MV (functional unit info) channel C
251	No MV (functional unit info) channel D
252	No MV (functional unit info) channel E
253	No MV (functional unit info) channel F
254	No MV (functional unit info) channel G
255	No MV (functional unit info) channel H
256	MV available (voltage sensor info) channel A
257	MV available (voltage sensor info) channel B
258	MV available (voltage sensor info) channel C
259	MV available (voltage sensor info) channel D
260	MV available (voltage sensor info) channel E
261	MV available (voltage sensor info) channel F

4PR-F14-D



262	MV available (voltage sensor info) channel G
263	MV available (voltage sensor info) channel H
264	No MV (voltage sensor info) channel A
265	No MV (voltage sensor info) channel B
266	No MV (voltage sensor info) channel C
267	No MV (voltage sensor info) channel D
268	No MV (voltage sensor info) channel E
269	No MV (voltage sensor info) channel F
270	No MV (voltage sensor info) channel G
271	No MV (voltage sensor info) channel H
272	DC electronic fault channel A
273	DC electronic fault channel B
274	DC electronic fault channel C
275	DC electronic fault channel D
276	DC electronic fault channel E
277	DC electronic fault channel F
278	DC electronic fault channel G
279	DC electronic fault channel H
280	Electronic wiring board fault 1
281	Electronic wiring board fault 2
282	Detector board fault channel A
283	Detector board fault channel B
284	Detector board fault channel C
285	Detector board fault channel D
286	Detector board fault channel E
287	Detector board fault channel F
288	Detector board fault channel G
289	Detector board fault channel H
290	16 IO module fault
300	48 V fuse fault
301	Detector voltage fault
302	Detector voltage fault
303	Display board fault
304	Converter board fault
305	Measurement board fault
306	CPU board fault
307	SPI start reserve 1
308	SPI start reserve 2
309	SPI start reserve 3
310	SPI start reserve 4
311	SPI start reserve 5
312	SPI start reserve 6

4PR-F14-D



313	SPI end reserve 1
314	SPI end reserve 2
315	SPI end reserve 3
316	SPI end reserve 4
317	SPI end reserve 5
318	SPI end reserve 6
319	Detector voltage initialisation
320	Detector voltage initialisation failure
321	2 detectors voltage initialisation
322	2 detectors voltage initialisation failure
323	Restart Runtime
324	Date and time programming
325	Date event
326	SCA function activation
327	SCA function deactivation
328	Digital input 1 start
329	Digital input 2 start
330	Digital input 3 start
331	Digital input 4 start
332	Digital input 5 start
333	Digital input 1 end
334	Digital input 2 end
335	Digital input 3 end
336	Digital input 4 end
337	Digital input 5 end
338	Digital output 1 start
339	Digital output 2 start
340	Digital output 3 start
341	Digital output 1 end
342	Digital output 2 end
343	Digital output 3 end
344	SF6 drop start
345	SF6 drop end
346	Equipment fault
347	SPI heartbeat (start)
348	SPI heartbeat (start)
349	SPI heartbeat (start)
350	SPI heartbeat (start)
351	SPI heartbeat (start)
352	SPI heartbeat (start)
353	SPI heartbeat (start)
354	SPI heartbeat (start)



355	SPI heartbeat (start)
356	SPI heartbeat (start)
357	SPI heartbeat (start)
358	SPI heartbeat (start)
359	SPI heartbeat (start)
360	SPI heartbeat (start)
361	SPI heartbeat (start)
362	SPI heartbeat (start)
363	SPI heartbeat (start)
364	SPI heartbeat (start)
365	SPI heartbeat (start)
366	SPI heartbeat (start)
367	SPI heartbeat (start)
368	SPI heartbeat (start)
369	SPI heartbeat (start)
370	SPI heartbeat (start)
371	SPI heartbeat (start)
372	SPI heartbeat (start)
373	SPI heartbeat (start)
374	SPI heartbeat (start)
375	SPI heartbeat (start)
376	SPI heartbeat (start)
377	SPI heartbeat (start)
378	SPI heartbeat (start)
379	SPI heartbeat (end)
380	SPI heartbeat (end)
381	SPI heartbeat (end)
382	SPI heartbeat (end)
383	SPI heartbeat (end)
384	SPI heartbeat (end)
385	SPI heartbeat (end)
386	SPI heartbeat (end)
387	SPI heartbeat (end)
388	SPI heartbeat (end)
389	SPI heartbeat (end)
390	SPI heartbeat (end)
391	SPI heartbeat (end)
392	SPI heartbeat (end)
393	SPI heartbeat (end)
394	SPI heartbeat (end)
395	SPI heartbeat (end)
396	SPI heartbeat (end)

4PR-F14-D

397	SPI heartbeat (end)
398	SPI heartbeat (end)
399	SPI heartbeat (end)
400	SPI heartbeat (end)
401	SPI heartbeat (end)
402	SPI heartbeat (end)
403	SPI heartbeat (end)
404	SPI heartbeat (end)
405	SPI heartbeat (end)
406	SPI heartbeat (end)
407	SPI heartbeat (end)
408	SPI heartbeat (end)
409	SPI heartbeat (end)
410	SPI heartbeat (end)
411	Initialisation of measurement recording file
412	DC closing Digital output 1
413	DC closing Digital output 2
414	DC closing Digital output 3
415	DC opening Digital output 1
416	DC opening Digital output 2
417	DC opening Digital output 3
418	Local closing command Digital output 1
419	Local closing command Digital output 2
420	Local closing command Digital output 3
421	Local opening command Digital output 1
422	Local opening command Digital output 2
423	Local opening command Digital output 3
424	Max. no. of login attempts admin mode
425	Reset bus
426	XML file initialisation fault
427	Motor fuse fault





## 5.1.4 Fault display

Faults associated with the equipment or operation are displayed on the local panel.

In the event of a fault:

- The "Equipment in standby" LED stops flashing
- The "Equipment fault" LED lights up red
- The corresponding fault LED lights up red



The faults displayed by the LEDs are as follows

No.	Labels	Fault LED
9	Start Irregularity on electrical control power supply	No 48 V DC + internal fault
334	48 V fuse fault	No 48 V DC
18	No voltage	No AC voltage
7	Start Irregularity on 12 V DC	No 12 V DC
15	Start Autonomous Source Backup	External load outage
13	Start Irregularity Autonomous Source	Battery fault
1	Charger irregularity	Internal fault
315 to 322	Wiring board fault (tcd channel x)	Internal fault
323 to 324	Wiring board x fault (external inputs)	Internal fault
325 to 332	Sensor board fault channel x	Internal fault
333	Eeprom parameters fault	Internal fault
334	48 V motor fuse fault	Internal fault
335	Voltage acquisition board 1 fault	Internal fault
336	Voltage acquisition board 2 fault	Internal fault
337	Display board fault	Internal fault

338	Converter board fault	Internal fault
347	Modem 1 fault	Internal fault
348	Modem 2 fault	Internal fault
349	CPU board fault	Internal fault
357	Initialisation failure voltage board 1	Internal fault
359	Initialisation failure voltage board 2	Internal fault
369	Eeprom mac CPU fault	Internal fault
370	Framework CPU fault	Internal fault
371	Modem interface CPU fault	Internal fault
372	Temperature sensor CPU fault	Internal fault
373	Time stamper CPU fault	Internal fault

### 5.1.5 CPU2020 firmware update:

Enables the new version of the CPU program to be downloaded

[See System configuration guide](#)



## 5.2 CORRECTIVE

### Location of protective fuses

#### Converter board (optional)

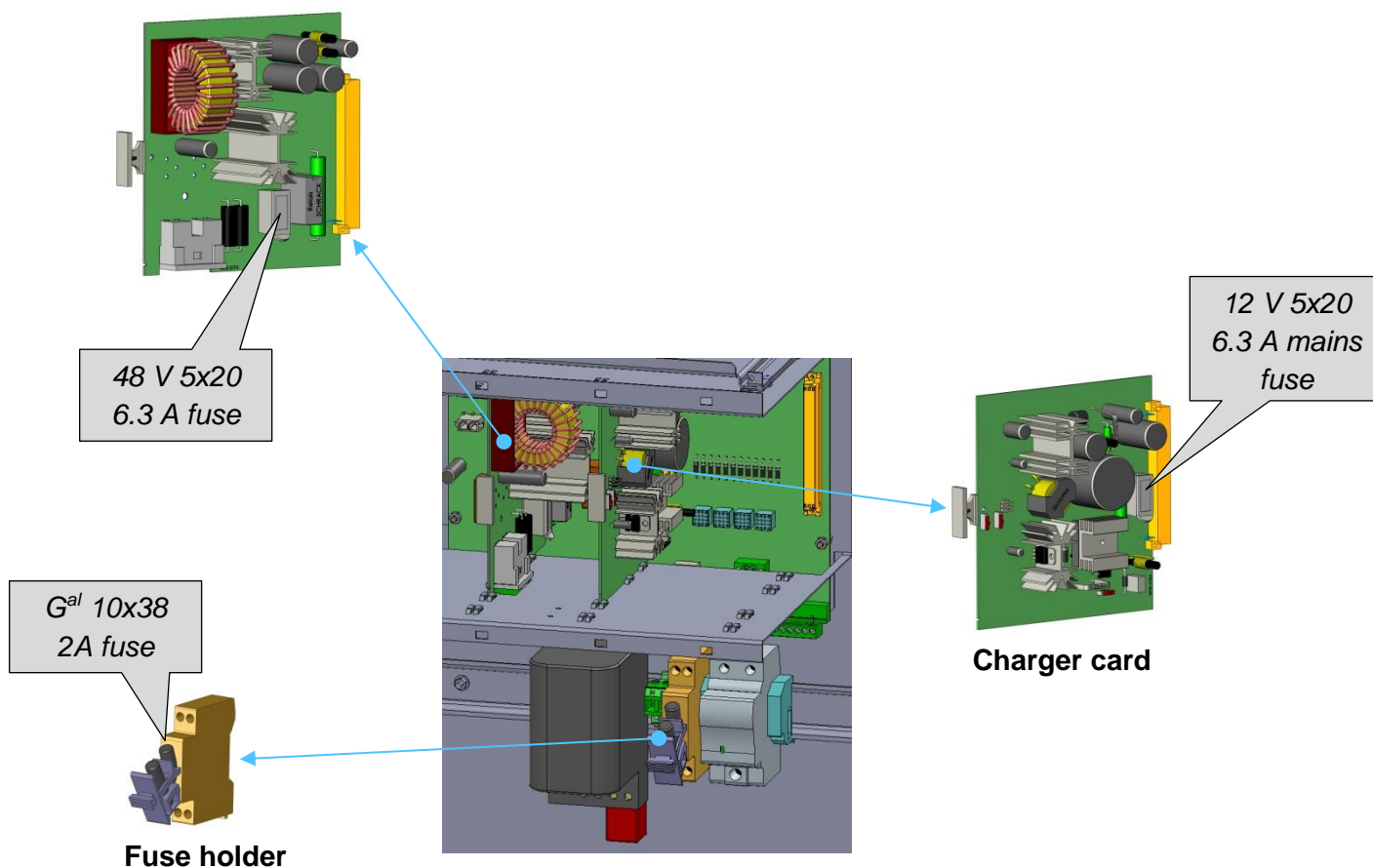

Should the equipment malfunction (to identify the problem see §5.1), it may be necessary to replace a cabinet component (electronic circuit board, battery, cable, etc.).



## To do this

- Open the cabinet's lower door
- Disconnect the battery cable
- Open the fuse holder
- Ensure that the equipment is not live (all LEDs off)
- Remove the faulty component
- Contact Ensto Novexia's After-sales Service

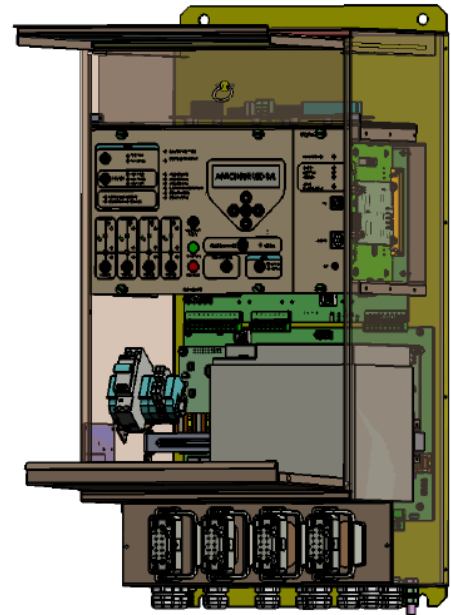

## Accessing the converter/charger boards

**Before undertaking any work, disconnect power to the cabinet (LV supply + battery).**

Loosen (4 screws) and disconnect the local panel board to access the Charger and Converter boards





You must remove the locking clips to remove the charger and converter boards.

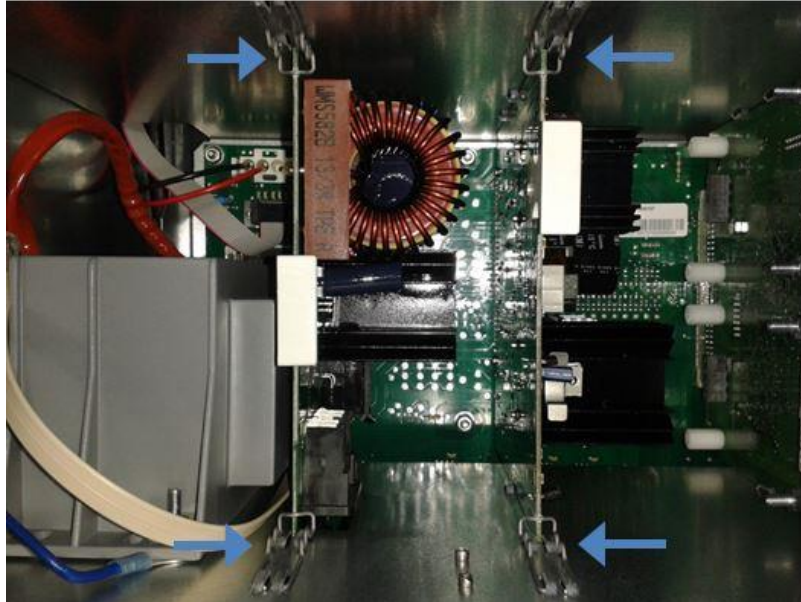

### Removing the converter/charger boards

Remove the clips holding the top and bottom of the board

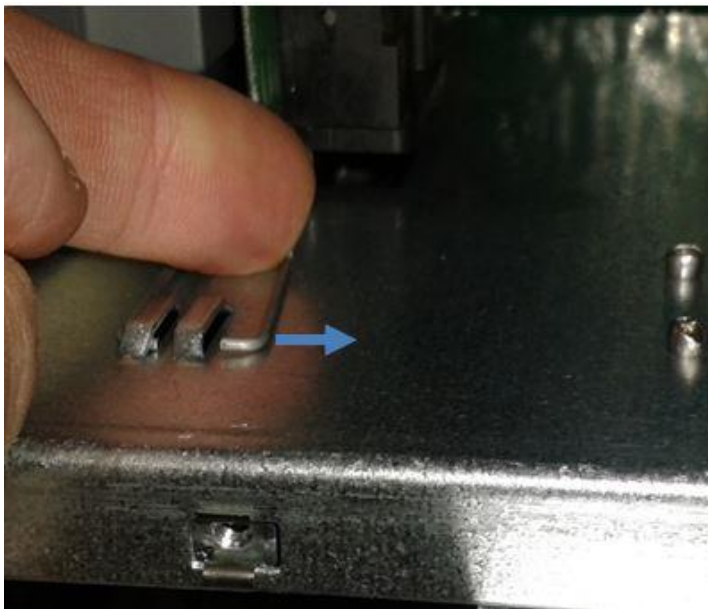

**Never use tools (screwdriver, spanner, etc.) that could damage the circuit boards**



Remove the board

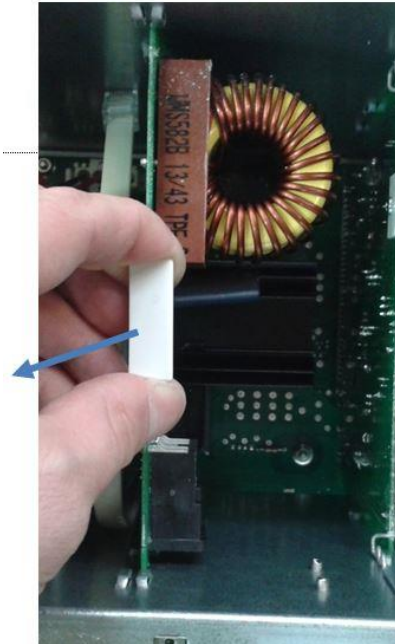

### Inserting converter/charger boards

Position the board and slide it onto the rack rails.  
connectors are connected

Ensure that the male/female

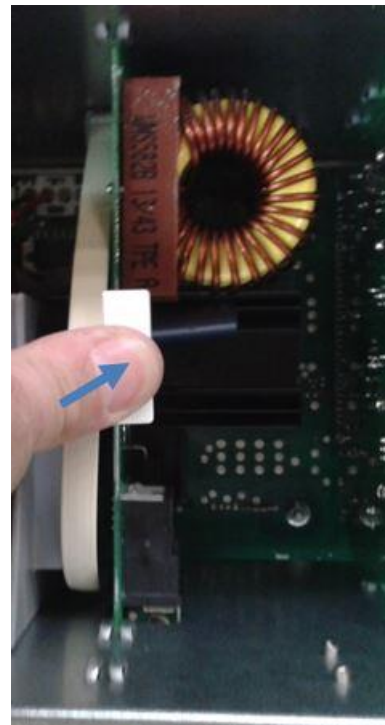

4PR-F14-D



Reposition the locking clips at the top and bottom of the board and reconnect the cable.

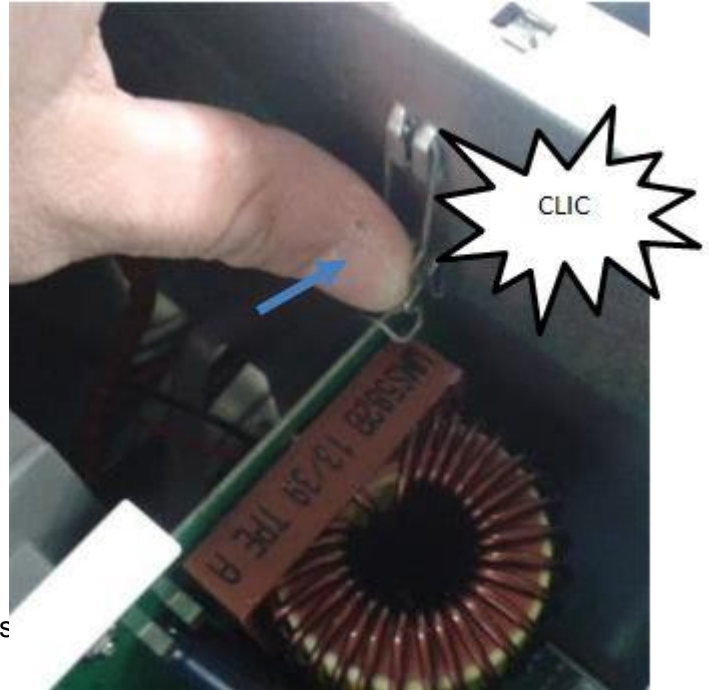
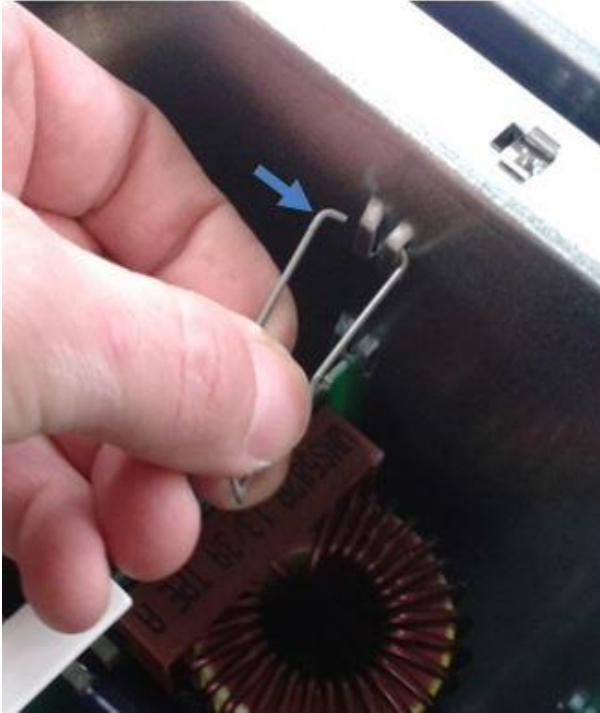

4PR-F14-D



## 6 TECHNICAL SUPPORT

The company operates an after-sales service to assist with equipment installation and troubleshooting.

**After-sales contact details:**

ENSTO VILLEFRANCHE → **+33 (0)474 656 160**

ENSTO BAGNERES DE BIGORRE → **+33 (0)562 914 510**





# 7 END OF PRODUCT LIFE

ITI cabinets are covered by European Directive 2002/96/CE, which requires the use of professional processing facilities for waste electrical and electronic equipment (WEEE) to dispose of the cabinet and its components, as well as the reprocessing of the used battery in an appropriate collection facility.

If a local service provider is not available, the products may be returned to the manufacturer after consultation with them; make sure you have the technical components for the sub-assemblies and/or the products to recycle and contact the Ensto Novexia technical support team.



**Service Après-Vente / After-Sales Service**

Parc d'Activités de la Haute-Bigorre

Boulevard de l'Adour

65200 Bagnères de Bigorre

Cedex

**Service Après-Ventes / After-Sales Service**

210, rue Léon Jouhaux – BP 10446

FR – 69656 Villefranche-sur-Saône

Cedex

Landline: +33 (0)4 74 65 61 60

Mobile: +33 (0)6 08 93 26 31

4PR-F14-D