

uMEC 100/120/150

Patient Monitor

Optimized uses at your fingertips



With Mindray's 30-year experience in patient monitoring, uMEC series patient monitors cater to clinical needs by offering precise and stable measurement of essential parameters. When monitoring is reliable, you can naturally be more confident with your clinical decisions.



Note: For uMEC 100/120/150, the models supplied in different regions are different. Consult Mindray sales engineers for details.

Ease of Use

- Standard touch screen. Easy to use
- Support gestures operations. Including adjust the screen brightness, adjust the alarm volume and switch a screen
- Flat UI design. Improve interaction experience
- Support self-learning. Make it easier for caregivers to use
- Support EWS, GCS and ECG 24h summary clinical assistive applications. Provide comprehensive analytical results for caregivers
- Minimum 3.5kg weight with battery
- Storage space to store accessories, cables etc



Gestures operations



Storage space

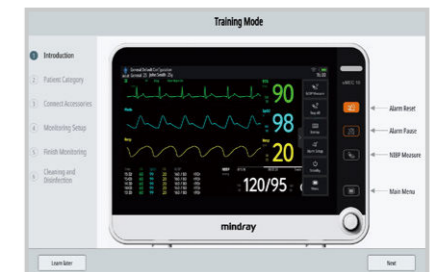

Self learning

Excellent Performance

- Mindray's patented Multi-lead ECG Algorithm
- NIBP quick-measurement technique
- Anti-interference SpO₂ algorithm
- External USB storage supported
- Large capacity for data storage
- Up to 12-hour continuous runtime with one Lithium-ion battery

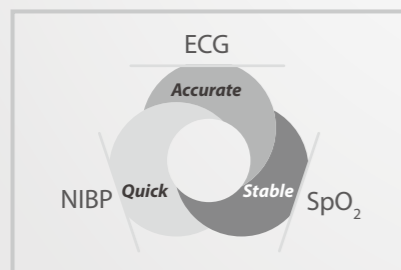

Essentially advanced measurements



Huge data capacity



Long battery working time

Reliability

- 0.75 m drop-protection and IPX1 water resistance
- Low power consumption and fanless design
- Robust housing resists aging and yellowing, with high corrosion resistance
- Mindray accessories with quality material and production technique
- Working temperature is 0~40°C, unaffected by extremes



Drop protection



Mindray accessories



uMEC 100/120/150

Patient Monitor

Data Sheet



Physical Specifications

Weight	uMEC 100: 3.5 kg uMEC 120: 4 kg uMEC 150: 5 kg (Standard configuration, standard battery excluding recorder and accessories.)
Size	uMEC 100: 300 x 210 x 165 mm uMEC 120: 350 x 250 x 180 mm uMEC 150: 430 x 300 x 190 mm
Display screen	Color touchscreen uMEC 100: 10.1-inch, 1024 x 600 pixels uMEC 120: 12.1-inch, 1280 x 800 pixels uMEC 150: 15.6-inch, 1366 x 768 pixels
Display channel	uMEC 100: Up to 8 waveform channels uMEC 120: Up to 10 waveform channels uMEC 150: Up to 12 waveform channels
Drop test	0.75m

ECG

Meet standards of IEC 60601-2-27 and IEC 60601-2-25.

Lead set	3-lead: I, II, III 5-lead: I, II, III, aVR, aVL, aVF, V 6-lead: I, II, III, aVR, aVL, aVF, Va, Vb 12-lead: I, II, III, aVR, aVL, aVF, V1 to V6
Automatic 3/5/6/12 - lead recognition.	
Input signal range	± 10 mV (p-p)
Electrode offset potential tolerance	± 800 mV
Sweep speed	6.25 mm/s, 12.5 mm/s, 25 mm/s, 50 mm/s
Gain	x 0.125, x 0.25, x 0.5, x 1, x 2, x 4, Auto
Waveform format	Standard, Cabrera
Bandwidth	Diagnostic mode: 0.05 to 150 Hz Monitor mode: 0.5 to 40 Hz Surgical mode: 1 to 20 Hz ST mode: 0.05 to 40 Hz Emphasis mode: 2 to 18 Hz Customise mode: available Highpass frequencies (0.01Hz, 0.05Hz, 0.15Hz, 0.25Hz, 0.32Hz, 0.5Hz, 0.67Hz); available Lowpass frequencies (25Hz, 35Hz, 45Hz, 75Hz, 100Hz, 150Hz)
CMRR	Diagnostic mode: >90 dB Monitor, Surgical, ST, Emphasis mode: >105 dB Customise mode: >105 dB (Lowpass frequency <40Hz), >90 dB (Lowpass frequency >40Hz)
Pace detection	Amplitude: ± 2 mV to ± 700 mV Width: 0.1 to 2 ms Rise time: 10 to 100 µs
Defib. protection	Withstand 5000V (360J) defibrillation
Baseline recovery time	<5 s
Multi-lead(2) algorithm	Yes
Provides Glasgow resting 12-lead ECG algorithm	

Heart Rate

HR rang	Adult: 10 to 300 bpm Pediatric/Neonate: 10 to 350 bpm
HR accuracy	± 1 bpm or ± 1%, whichever is greater.
HR resolution	1 bpm

Arrhythmia Analysis

Intended use for adult, pediatric and neonate.
Multi-lead, 27 classifications. Asystole, V-Fib/V-Tach, V-Tach, Vent Brady, Extreme Tachy, Extreme Brady, Vent Rhythm, PVCs/min, Pauses/min, Couplet, Bigeminy, Trigeminy, R on T, Run PVCs, PVC, Tachy, Brady, Missed Beats, PNP, PNC, Multiform PVC, Nonsus V-Tach, Pause, Irregular Rhythm, A-Fib (for adult only), SVT, SVCs/min.

ST Segment Analysis

Intended use for adult,	pediatric and neonate.
ST range	- 2.5 to + 2.5 mV RTI
ST accuracy	± 0.02 mV or ± 10%, whichever is greater (- 0.8 to + 0.8 mV)
ST resolution	0.01 mV

QT Analysis

Intended use for adult,	pediatric, and neonate.
Parameters	QT, QTc, ΔQTc
QTc formula	Bazett, Fridericia, Framingham, or Hodges
QT/QTc range	200 to 800 ms
QT accuracy	± 30 ms
QT resolution	4 ms
QTc resolution	1 ms
QT-HR range	Adult: 15 to 150 bpm Pediatric/Neonate: 15 to 180 bpm

Respiration

Lead	I, II and Auto
RR range	0 to 200 rpm (RR source is CO ₂ or ECG) 4 to 70 rpm (RR source is SpO ₂)
RR accuracy	when RR source is CO ₂ or ECG: ± 1 rpm (0 to 120 rpm) ± 2 rpm (121 to 200 rpm) when RR source is SpO ₂ : Arms ≤3rpm, mean deviation: [-1,1]rpm 1 rpm
RR resolution	1 rpm
Sweep speed	3 mm/s, 6.25 mm/s, 12.5 mm/s, 25 mm/s, 50 mm/s
Apnea time	10 s, 15 s, 20 s, 25 s, 30 s, 35 s, 40 s

SpO₂

Meet standards of ISO 80601-2-61.

Module	Mindray
Range	0 to 100 %
Resolution	1%
Accuracy	± 2% (70 to 100%, Adult/Pediatric): ± 3% (70 to 100%, Neonate) Unspecified (0 to 69%)
Refreshing rate	≤2 s
Perfusion index (PI)	Yes
Pitch tone	Yes
PR	
PR range	20 to 300 bpm (from SpO ₂) 20 to 350 bpm (from IBP, available for uMEC 120 and uMEC 150 only) 30 to 300 bpm (from NIBP)
PR accuracy	± 3 bpm (20 to 300 bpm, from SpO ₂) ± 1 bpm or ± 1 %, whichever is greater (from IBP, available for uMEC 120 and uMEC 150 only) ± 3 bpm or ± 3 %, whichever is greater (from NIBP)
Refreshing rate	≤ 2 s

Temperature

Meet standard of ISO 80601-2-56.

Technique	Thermal resistance
Channels	1 or 2 channels (for uMEC 120 & uMEC 150 only)
Temp range	0 to 50 °C (32 to 122 °F)
Temp accuracy	± 0.1 °C or ± 0.2 °F (without probe)
Temp resolution	0.1 °C
Refreshing rate	≤ 2 s

NIBP

Meet standards of ISO 80601-2-30.

Technique	Oscillometry
Operation mode	Manual, Auto, STAT, Sequence, Clock
Parameters	Systolic, Diastolic, Mean
Max measurement time	Adult/Pediatric: 120 s, Neonate: 90 s
Systolic range	Adult: 25 to 290 mmHg Pediatric: 25 to 240 mmHg Neonate: 25 to 140 mmHg
Diastolic range	Adult: 10 to 250 mmHg Pediatric: 10 to 220 mmHg Neonate: 10 to 115 mmHg
Mean range	Adult: 15 to 260 mmHg Pediatric: 15 to 225 mmHg Neonate: 15 to 125 mmHg
NIBP accuracy	Max mean error: ± 5 mmHg Max standard deviation: 8 mmHg
NIBP resolution	1 mmHg
Assisting venous puncture	Yes

IBP (for uMEC 120 & uMEC 150 only)

Meet standard of IEC 60601-2-34.

Channels	2 channels
Sensitivity	5 μ V/V/mmHg
Impedance range	300 to 3000 Ω
IBP range	-50 to 360 mmHg
IBP accuracy	± 1 mmHg or ± 2 %, whichever is greater (without sensor)
IBP resolution	1 mmHg
PPV range	0 to 50 %
PAWP	Yes
ICP measurement	Yes
Support waveforms overlapping.	

C.O. (for uMEC 120 & uMEC 150 only)

Technique	Thermodilution
C.O. range	0.1 to 20 L/min
C.O. accuracy	± 0.1 L/min or ± 5 %, whichever is greater
C.O. resolution	0.1 L/min
TB range	23 to 43 $^{\circ}$ C
TI range	0 to 27 $^{\circ}$ C
TB & TI accuracy	± 0.1 $^{\circ}$ C (without sensor)
TB & TI resolution	0.1 $^{\circ}$ C

Artema Sidestream CO₂ (for uMEC 120 & uMEC 150 only)

Meet standard of ISO 80601-2-55.

CO ₂ sample flow rate	120 ml/min (DRYLINE II™ watertrap for adult/pediatric) 90/70 ml/min (DRYLINE II™ watertrap for neonate)
CO ₂ sample flow rate accuracy	± 15 ml/min or ± 15 %, whichever is greater.
CO ₂ response time	≤ 5.0 s @ 120ml/min (for adult/pediatric) ≤ 4.5 s @ 90 ml/min (for neonate) ≤ 5.0 s @ 70 ml/min (for neonate)
CO ₂ range	0-150 mmHg
CO ₂ accuracy	Full accuracy mode: 0 - 40 mmHg: ± 2 mmHg 41 - 76 mmHg: ± 5 % of reading 77 - 150 mmHg: ± 10 % of reading ISO accuracy mode: Add ± 2 mmHg to the full accuracy mode
CO ₂ resolution	1 mmHg
awRR range	0 to 150 rpm
awRR accuracy	± 1 rpm (0 to 60 rpm) ± 2 rpm (61 to 150 rpm)
Apnea time	10 s, 15 s, 20 s, 25 s, 30 s, 35 s, 40 s

Oridion Microstream CO₂ (for uMEC 120 & uMEC 150 only)

Meet standard of ISO 80601-2-55.

Sample flow rate	50 ⁺¹⁵ -7.5 ml/min
Initialization time	30 s (typical)
Response time	4.6 s (typical)
CO ₂ range	0 to 99 mmHg
CO ₂ accuracy	± 2 mmHg (0 to 38 mmHg) ± 5 % of the reading (8% increased in error for every 1 mmHg if the reading is more than 38 mmHg) (39 to 99 mmHg)
awRR range	0 to 150 rpm
awRR accuracy	± 1 rpm (0 to 70 rpm) ± 2 rpm (71 to 120 rpm) ± 3 rpm (121 to 150 rpm)
Apnea time	10 s, 15 s, 20 s, 25 s, 30 s, 35 s, 40 s

Mindray Mainstream CO₂ (for uMEC 120 & uMEC 150 only)

Meet standard of ISO 80601-2-55.

Rise time	< 60 ms
CO ₂ range	0 to 150 mmHg
CO ₂ accuracy	± 2 mmHg (0 to 40 mmHg) ± 5 % of the reading (41 to 70 mmHg) ± 8 % of the reading (71 to 100 mmHg) ± 10 % of the reading (101 to 150 mmHg)
awRR range	0 to 150 rpm
awRR accuracy	± 1 rpm
Apnea time	10 s, 15 s, 20 s, 25 s, 30 s, 35 s, 40 s

Data Review

For internal card

Trends data	Up to 4 hours @ 5 s Up to 120 hours @ 1min Up to 1200 hours @ 10 min
Events	Up to 1000 events, including parameter alarms, arrhythmia events technical alarms, and so on. 128 arrhythmia events
NIBP	Up to 1600 sets

For external card

Trends data	Up to 240 hours @ 1min Up to 2400 hours @ 10 min
Events	Up to 5000 events, including parameter alarms, arrhythmia events technical alarms, and so on. 128 arrhythmia events
NIBP	Up to 5000 sets

For internal & external card

OxyCRG	Up to 24 hours of OxyCRG events
ST review	Up to 120 hours, one group of ST segment waveforms is stored every 5 min.
Full disclosure	Up to 120 hours for one waveform. The specific storage time depends on the waveforms stored and the number of stored waveforms.

Alarms

Audible indicator	Yes, 3 different alarm tones
Visible indicator	Red/yellow LED, and alarm message display
Provide AlarmSight infographic alarm indicator.	

Special Functions

Clinical Assistive Application (CAA): ST Graphic™, EWS, GCS, 24h ECG summary, NIBP analysis
Calculations (Drug, Hemodynamic, Oxygenation, Ventilation, Renal), and Titration table.

Wi-Fi Communications

Protocol	IEEE 802.11a/b/g/n/ac
Modulation mode	BPSK, QPSK, 16QAM, 64QAM, 256QAM
Operating frequency	2.412 to 2.472 GHz 5.18 to 5.32 GHz 5.5 to 5.7 GHz 5.745 to 5.825 GHz
Wireless baud rate	IEEE 802.11a: 6 to 54 Mbps IEEE 802.11b: 1 to 11 Mbps IEEE 802.11g: 6 to 54 Mbps IEEE 802.11n: MCS0-MCS7 IEEE 802.11ac: MCS0-MCS8
Output power	< 20dBm (CE requirement: detection Mode: RMS) < 30dBm (FCC requirement: detection Mode: peak power)
Operating mode	As station, access AP for data transmission
Data security	Standards: WPA-PSK, WPA2-PSK, WPA-Enterprise, WPA2-Enterprise EAP method: EAP-FAST, EAP-TLS, EAP-TTLS, PEAP-GTC, PEAP-MSCHAPv2, PEAP-TLS, LEAP Encryption: TKIP and AES

Interfacing

Main unit	AC power connector (1) VGA port (1) Network connector (1), RJ45 USB 2.0 connector (2) Equipotential grounding terminal (1) Analog output / defibrillator Synchronization / nurse call (1)
Barcode scanner	Support 1D and 2D barcode
Thermal recorder	3 traces (paper 50 mm width, 20 m length)
Network printer	Support

Power

Line voltage	100 to 240 VAC ($\pm 10\%$)
Maximum current	2.0A
Frequency	50/60 Hz
Battery	Rechargeable lithium-ion battery, 2600mAh/5200mAh uMEC 100 ≥ 6 hours run time (2600mAh) uMEC 100 ≥ 12 hours run time (5200mAh) uMEC 120 ≥ 4.5 hours run time (2600mAh) uMEC 120 ≥ 10 hours run time (5200mAh) uMEC 150 ≥ 4 hours run time (2600mAh) uMEC 150 ≥ 9 hours run time (5200mAh)
Recharge time	3.5 hours to 90% (2600mAh, power off) 7 hours to 90% (5200mAh, power off)

Environmental requirements

Temperature	Operating: 0 to 40 °C Storage: -20 to 60 °C
Humidity	Operating: 15 to 95 % (noncondensing) Storage: 10 to 95 % (noncondensing)
Barometric	Operating: 427.5 to 805.5 mmHg (57 to 107.4 kPa) Storage: 120 to 805.5 mmHg (16 to 107.4 kPa)

Not all of the functions are available in all geographies. Please contact your local Mindray sales representative for the most current information.

www.mindray.com

P/N:ENG- uMEC 100/120/150 Datasheet-210285x4P-20230628

©2023 Shenzhen Mindray Bio-Medical Electronics Co.,Ltd. All rights reserved.

mindray
healthcare within reach

**uMEC 60/uMEC 70/uMEC 80/uMEC 100/
uMEC 120/uMEC 150**

Patient Monitor

Operator's Manual



© Copyright 2023 Shenzhen Mindray Bio-Medical Electronics Co., Ltd. All rights reserved.

Release time: 2023-07

Revision: 2.0

Intellectual Property Statement

SHENZHEN MINDRAY BIO-MEDICAL ELECTRONICS CO., LTD. (hereinafter called Mindray) owns the intellectual property rights to this Mindray product and this manual. This manual may refer to information protected by copyrights or patents and does not convey any license under the patent rights of Mindray, nor the rights of others.

Mindray intends to maintain the contents of this manual as confidential information. Disclosure of the information in this manual in any manner whatsoever without the written permission of Mindray is strictly forbidden.

Release, amendment, reproduction, distribution, rental, adaption and translation of this manual in any manner whatsoever without the written permission of Mindray is strictly forbidden.

mindray is the registered trademarks or trademarks owned by Mindray in China and other countries. All other trademarks that appear in this manual are used only for editorial purposes without the intention of improperly using them. They are the property of their respective owners.

Responsibility on the Manufacturer Party

Contents of this manual are subject to changes without prior notice.

All information contained in this manual is believed to be correct. Mindray shall not be liable for errors contained herein nor for incidental or consequential damages in connection with the furnishing, performance, or use of this manual.

Mindray is responsible for the effects on safety, reliability and performance of this product, only if:

- all installation operations, expansions, changes, modifications and repairs of this product are conducted by Mindray authorized personnel;
- the electrical installation of the relevant room complies with the applicable national and local requirements;
- the product is used in accordance with the instructions for use.

WARNING

- **This equipment must be operated by skilled/trained clinical professionals.**
 - **It is important for the hospital or organization that employs this equipment to carry out a reasonable service/maintenance plan. Neglect of this may result in machine breakdown or personal injury.**
-
-

Warranty

THIS WARRANTY IS EXCLUSIVE AND IS IN LIEU OF ALL OTHER WARRANTIES, EXPRESSED OR IMPLIED, INCLUDING WARRANTIES OF MERCHANTABILITY OR FITNESS FOR ANY PARTICULAR PURPOSE.

Exemptions

Mindray's obligation or liability under this warranty does not include any transportation or other charges or liability for direct, indirect or consequential damages or delay resulting from the improper use or application of the product or the use of parts or accessories not approved by Mindray or repairs by people other than Mindray authorized personnel.

This warranty shall not extend to

- Malfunction or damage caused by improper use or man-made failure.
- Malfunction or damage caused by unstable or out-of-range power input.
- Malfunction or damage caused by force majeure such as fire and earthquake.
- Malfunction or damage caused by improper operation or repair by unqualified or unauthorized service people.
- Malfunction of the instrument or part whose serial number is not legible enough.
- Others not caused by instrument or part itself.

Company Contact

Manufacturer:	Shenzhen Mindray Bio-Medical Electronics Co., Ltd.
Address	Mindray Building, Keji 12th Road South, High-tech Industrial Park, Nanshan, Shenzhen 518057, P.R.China
Website	www.mindray.com
E-mail Address:	service@mindray.com
Tel:	+86 755 81888998
Fax:	+86 755 26582680
EC-Representative:	Shanghai International Holding Corp. GmbH (Europe)
Address:	Eiffestraße 80, 20537 Hamburg, Germany
Tel:	0049-40-2513175
Fax:	0049-40-255726

Notification of Adverse Events

As a health care provider, you may report the occurrence of certain events to SHENZHEN MINDRAY BIO-MEDICAL ELECTRONICS CO., LTD., and possibly to the competent authority of the Member state in which the user and / or patient is established.

These events, include device-related death and serious injury or illness. In addition, as part of our Quality Assurance Program, SHENZHEN MINDRAY BIO-MEDICAL ELECTRONICS CO., LTD. requests to be notified of device failures or malfunctions. This information is required to ensure that SHENZHEN MINDRAY BIO-MEDICAL ELECTRONICS CO., LTD. provides only the highest quality products.

Preface

Manual Purpose

This manual contains the instructions necessary to operate the product safely and in accordance with its function and intended use. Observance of this manual is a prerequisite for proper product performance and correct operation and ensures patient and operator safety.

This manual is based on the maximum configuration and therefore some contents may not apply to your product. If you have any question, please contact us.

This manual is an integral part of the product. It should always be kept close to the equipment so that it can be obtained conveniently when needed.

Intended Audience

This manual is geared for clinical professionals who are expected to have a working knowledge of medical procedures, practices and terminology as required for monitoring of critically ill patients.

Illustrations

All illustrations in this manual serve as examples only. They may not necessarily reflect the setup or data displayed on your patient monitor.

Conventions

- ***Italic text*** is used in this manual to quote the referenced manuals, chapters, sections and formulas.
- **Bold text** is used to indicate the screen texts and names of hard keys.
- → is used to indicate operational procedures.

Contents

1 Safety	1 - 1
1.1 Safety Information	1 - 1
1.1.1 Warnings	1 - 1
1.1.2 Cautions	1 - 2
1.1.3 Notes	1 - 2
1.2 Equipment Symbols	1 - 3
2 Equipment Introduction	2 - 1
2.1 Intended Use	2 - 1
2.1.1 Intended Purpose Statement	2 - 1
2.1.2 Indication for Use	2 - 1
2.1.3 Medical Conditions	2 - 1
2.1.4 Intended Users	2 - 1
2.1.5 Intended Patient Population	2 - 1
2.1.6 Contra-indications	2 - 1
2.1.7 Side-effects	2 - 1
2.2 Applied Parts	2 - 1
2.3 System Components	2 - 2
2.3.1 Main Unit	2 - 2
2.3.2 Input Devices	2 - 6
2.3.3 Printing Devices	2 - 6
3 Getting Started	3 - 1
3.1 Equipment Preparation Safety Information	3 - 1
3.2 Monitor Installation	3 - 2
3.2.1 Unpacking and Checking	3 - 2
3.2.2 Environmental Requirements	3 - 2
3.3 Setting Up the Equipment	3 - 2
3.3.1 Connecting the AC Mains	3 - 2
3.3.2 Connecting the Input Devices	3 - 3
3.4 Turning on the Monitor	3 - 3
3.5 Operation on the Screen	3 - 3
3.5.1 Using the Touchscreen	3 - 3
3.5.2 Using the Knob	3 - 4
3.5.3 Using the On-Screen Keyboard	3 - 4
3.5.4 Using the Barcode Reader	3 - 4
3.6 Screen Display	3 - 5
3.6.1 On-screen Symbols	3 - 5
3.6.2 Menus	3 - 7
3.6.3 Quick Keys	3 - 7
3.7 Operating Modes	3 - 9
3.7.1 Monitoring Mode	3 - 9
3.7.2 Privacy Mode	3 - 9
3.7.3 Night Mode	3 - 10
3.7.4 Standby Mode	3 - 11

3.8 Configuring Your Monitor	3 - 12
3.8.1 Setting the Date and Time	3 - 12
3.8.2 Adjusting the Screen Brightness	3 - 12
3.8.3 Adjusting the Volume	3 - 12
3.8.4 Accessing the On-screen Guide	3 - 12
3.9 Starting Monitoring a Patient	3 - 13
3.10 Stopping a Parameter Measurement	3 - 13
3.11 General Operation	3 - 13
3.11.1 Switching On or Off a Parameter	3 - 13
3.11.2 Displaying Parameter Numerics and Waveforms	3 - 13
3.11.3 Displaying the Parameter List	3 - 14
3.11.4 Accessing Parameter Setup Menus	3 - 14
3.11.5 Changing Measurement Colors	3 - 14
3.12 Initiating a Manual Event	3 - 14
3.13 Using the On-Screen Timers	3 - 14
3.13.1 Displaying Timers	3 - 14
3.13.2 Controlling the Timer	3 - 15
3.13.3 Setting the Timer	3 - 15
3.14 Freezing Waveforms	3 - 15
3.14.1 Freezing Waveforms	3 - 15
3.14.2 Viewing Frozen Waveforms	3 - 16
3.14.3 Unfreezing Waveforms	3 - 16
3.14.4 Printing Frozen Waveforms	3 - 16
3.15 Entering Training Mode	3 - 16
3.16 Checking Software Licenses	3 - 16
3.17 Turning Off the Monitor	3 - 17
4 User Screens	4 - 1
4.1 Choosing a Screen	4 - 1
4.2 Switching a Screen	4 - 1
4.3 Normal Screen	4 - 1
4.3.1 Entering the Normal Screen	4 - 1
4.3.2 Configuring the Normal Screen	4 - 1
4.4 The Big Numerics Screen	4 - 2
4.4.1 Entering the Big Numerics Screen	4 - 2
4.4.2 Configuring the Big Numerics Screen	4 - 2
4.5 Minitrends Screen	4 - 2
4.5.1 Entering the Minitrends Screen	4 - 2
4.5.2 The Display of Minitrends Screen	4 - 3
4.5.3 Setting Minitrends Parameters	4 - 3
4.5.4 Setting the Minitrend Length	4 - 3
4.5.5 Setting the Alarm Statistics Switch	4 - 3
4.5.6 Setting the Alarm Statistics Duration	4 - 4
4.5.7 Routine Vital/Baseline	4 - 4
4.6 The OxyCRG Screen	4 - 4
4.6.1 Entering the OxyCRG Screen	4 - 4
4.6.2 OxyCRG Events	4 - 4

4.6.3 The Display of the ABD Event Area	4 - 5
4.6.4 Setting OxyCRG Parameters	4 - 5
4.6.5 Setting the Threshold of ABD Events	4 - 5
4.6.6 Editing ABD Events	4 - 5
4.7 Remote View Screen	4 - 5
4.7.1 Entering the Remote View Screen	4 - 6
4.7.2 Adding a Bed	4 - 7
4.7.3 Removing a Bed	4 - 7
4.7.4 Displaying the Main Bed	4 - 7
4.7.5 Saving a Manual Event	4 - 7
4.7.6 Resetting Alarms for Remote Devices	4 - 7
4.7.7 Alarm Watch	4 - 8
4.7.8 Auto Displaying the New Alarm Bed	4 - 9
5 Managing Patients	5 - 1
5.1 Discharging a Patient	5 - 1
5.1.1 Auto Discharging a Patient after Monitor Power Off	5 - 1
5.1.2 Manually Discharging a Patient	5 - 1
5.2 Admitting a Patient	5 - 1
5.3 Managing Patient Information	5 - 2
5.3.1 Entering the Patient Management Menu	5 - 2
5.3.2 Editing Patient Information	5 - 2
5.3.3 Loading Patient Information from the CMS	5 - 2
5.3.4 Loading Patient Information from the ADT Server	5 - 3
5.4 Exporting Patient Data	5 - 3
5.5 Deleting Patient Data	5 - 3
6 Managing Configurations	6 - 1
6.1 Configuration Introduction	6 - 1
6.2 Setting Default Patient Category	6 - 1
6.3 Setting Default Configuration	6 - 1
6.4 Defining Age Segments	6 - 1
6.5 Saving Current Settings	6 - 2
6.6 Deleting a Configuration	6 - 2
6.7 Transferring a Configuration	6 - 2
6.7.1 Exporting a Configuration	6 - 2
6.7.2 Importing a Configuration	6 - 2
6.8 Printing Configurations	6 - 3
6.9 Loading a Configuration	6 - 3
6.10 Modifying Configuration Password	6 - 3
7 Networked Monitoring	7 - 1
7.1 Network Introduction	7 - 1
7.2 Network Safety Information	7 - 1
7.3 Connecting the Monitor to the CMS	7 - 1
7.4 Connecting the eGateway	7 - 2
7.5 MLDAP	7 - 2

7.6 Connecting the Wireless Network	7 - 2
7.7 Disconnecting the Wireless Network	7 - 2
8 Alarms	8 - 1
8.1 Alarm Introduction	8 - 1
8.2 Alarm Safety Information	8 - 1
8.3 Understanding the Alarms	8 - 1
8.3.1 Alarm Categories	8 - 1
8.3.2 Alarm Priorities	8 - 2
8.3.3 Alarm Indicators	8 - 2
8.3.4 Alarm Status Symbols	8 - 3
8.4 Accessing On-screen Help for Technical Alarms (AlarmSight)	8 - 3
8.5 Checking Physiological Alarm List	8 - 3
8.6 Changing Alarm Settings	8 - 3
8.6.1 Setting Parameter Alarm Properties	8 - 3
8.6.2 Setting Alarm Tone Properties	8 - 3
8.6.3 Initiating Auto Alarm Limits	8 - 4
8.6.4 Setting the Alarm Delay Time	8 - 6
8.6.5 Restoring the Default Alarm Settings	8 - 6
8.6.6 Setting the Length of Printed Waveforms	8 - 7
8.6.7 Setting the Switch of the SpO ₂ Desat Alarm Off	8 - 7
8.6.8 Setting the Switch of the Apnea Alarm Off	8 - 7
8.7 Pausing Alarms/Pausing Alarm Tones	8 - 7
8.7.1 Defining the Pause Function	8 - 7
8.7.2 Pausing Alarms	8 - 7
8.7.3 Pausing Alarm Sound	8 - 8
8.8 Resetting Alarms	8 - 9
8.8.1 Resetting Physiological Alarms	8 - 9
8.8.2 Resetting Technical Alarms	8 - 9
8.9 Latching Alarms	8 - 9
8.10 Nurse Call	8 - 10
8.11 Calling for Help	8 - 10
8.12 CPB Mode	8 - 10
8.12.1 Entering the CPB Mode	8 - 10
8.12.2 Exiting the CPB Mode	8 - 10
8.13 Intubation Mode	8 - 11
8.13.1 Entering the Intubation Mode	8 - 11
8.13.2 Exiting the Intubation Mode	8 - 11
8.14 Testing Alarms	8 - 11
8.15 Actions When an Alarm Occurs	8 - 11
9 Monitoring ECG, Arrhythmia, ST and QT	9 - 1
9.1 ECG Introduction	9 - 1
9.2 ECG Safety Information	9 - 1
9.3 ECG Display	9 - 1
9.4 Preparing for ECG Monitoring	9 - 2
9.4.1 Preparing the Patient Skin	9 - 2

9.4.2 Applying Electrodes	9 - 2
9.4.3 Lead Wire Color Code	9 - 2
9.4.4 ECG Electrode Placement	9 - 3
9.4.5 Choosing the ECG Lead Type	9 - 4
9.4.6 Checking Paced Status	9 - 5
9.4.7 Enabling Pacer Rejection	9 - 5
9.5 Using 6-lead Placement to Derive 12-lead ECG (D12L)	9 - 5
9.6 Changing ECG Settings	9 - 6
9.6.1 Choosing an ECG Screen	9 - 6
9.6.2 Setting ECG Alarm Properties	9 - 6
9.6.3 Setting the Analysis Mode	9 - 7
9.6.4 Changing ECG Wave Settings	9 - 7
9.6.5 Disabling the Smart Lead Off Function	9 - 9
9.6.6 Setting CrozFusion™	9 - 9
9.6.7 Adjusting the QRS Volume	9 - 10
9.6.8 Adjusting the Minimum QRS Detection Threshold	9 - 11
9.7 Monitoring Arrhythmia	9 - 11
9.7.1 Arrhythmia Safety Information	9 - 11
9.7.2 Arrhythmia Events	9 - 11
9.7.3 Displaying Arrhythmia Information	9 - 13
9.7.4 Changing Arrhythmia Settings	9 - 13
9.7.5 Arrhythmia Alarms	9 - 15
9.8 ST Segment Monitoring	9 - 17
9.8.1 ST Safety Information	9 - 17
9.8.2 Enabling ST Monitoring	9 - 18
9.8.3 Displaying ST Numerics	9 - 18
9.8.4 Displaying ST Segments in the Waveform Area	9 - 19
9.8.5 Entering the ST View	9 - 19
9.8.6 Saving the Current ST as Baseline	9 - 19
9.8.7 Entering the ST Graphic Window	9 - 20
9.8.8 Changing ST Settings	9 - 21
9.8.9 ST Point, ISO Point, and J Point	9 - 21
9.9 QT/QTc Interval Monitoring	9 - 22
9.9.1 QT/QTc Monitoring Limitations	9 - 22
9.9.2 Enabling QT/QTc Monitoring	9 - 23
9.9.3 Displaying QT/QTc Numerics and Segments	9 - 23
9.9.4 Entering the QT View	9 - 23
9.9.5 Saving the Current QTc as Baseline	9 - 24
9.9.6 Changing QT Settings	9 - 24
9.10 ECG Relearning	9 - 25
9.10.1 Auto ECG Relearning	9 - 25
9.10.2 Manually Initiating an ECG Relearning	9 - 25
9.11 Calibrating ECG	9 - 25
9.12 Defibrillation Synchronization Pulse Output	9 - 25
9.13 ECG Troubleshooting	9 - 25
10 Resting 12-Lead ECG Analysis	10 - 1
10.1 Resting 12-Lead ECG Analysis Introduction	10 - 1
10.2 Entering the 12-Lead Screen	10 - 1

10.3 Initiating Resting 12-Lead ECG Analysis	10 - 1
10.4 Changing 12-Lead ECG Analysis Settings	10 - 1
10.5 Saving the 12-Lead Interpretation Report	10 - 1
10.6 Printing the 12-Lead Interpretation Report	10 - 1
10.7 Exiting the ECG 12-Lead Screen	10 - 2
11 Monitoring Respiration (Resp)	11 - 1
11.1 Resp Introduction	11 - 1
11.2 Resp Safety Information	11 - 1
11.3 Resp Display	11 - 1
11.4 Preparing for Resp Monitoring	11 - 2
11.4.1 Preparing the Patient	11 - 2
11.4.2 Placing the Electrodes	11 - 2
11.5 Changing Resp Settings	11 - 3
11.5.1 Setting the Resp Alarm Properties	11 - 3
11.5.2 Setting the RR Source	11 - 3
11.5.3 Choosing the Respiration Lead	11 - 3
11.5.4 Setting the Resp Waveform Size	11 - 3
11.5.5 Setting the Resp Waveform Speed	11 - 4
11.5.6 Setting the Auto Detection Switch	11 - 4
11.5.7 Adjusting the Resp Waveform Detection Threshold	11 - 4
11.6 Resp Troubleshooting	11 - 4
12 Monitoring Pulse Oxygen Saturation (SpO₂)	12 - 1
12.1 SpO ₂ Introduction	12 - 1
12.2 SpO ₂ Safety Information	12 - 1
12.3 SpO ₂ Measurement Limitations	12 - 2
12.4 SpO ₂ Display	12 - 3
12.5 Preparing for SpO ₂ Monitoring	12 - 3
12.6 Changing the SpO ₂ Settings	12 - 4
12.6.1 Changing the SpO ₂ Alarm Settings	12 - 4
12.6.2 Changing Sensitivity	12 - 4
12.6.3 Showing/Hiding PI	12 - 4
12.6.4 Monitoring SpO ₂ and NIBP Simultaneously	12 - 4
12.6.5 Changing the Sweep Speed of the Pleth Waveform	12 - 4
12.7 Changing the PR Settings	12 - 5
12.7.1 Changing the PR Alarm Settings	12 - 5
12.7.2 Changing the QRS Volume	12 - 5
12.7.3 Setting the PR Source	12 - 5
12.7.4 Showing/Hiding PR	12 - 5
12.8 SpO ₂ Troubleshooting	12 - 5
13 Monitoring Temperature (Temp)	13 - 1
13.1 Temperature Introduction	13 - 1
13.2 Displaying the Temp Numerics Area	13 - 1
13.3 Temperature Display	13 - 1
13.4 Preparing for Temperature Monitoring	13 - 1

13.5 Changing Temperature Settings	13 - 2
13.5.1 Setting the Temperature Alarm Properties	13 - 2
13.5.2 Selecting the Temperature Label	13 - 2
13.5.3 Displaying the Temperature Difference	13 - 2
13.6 Temperature Troubleshooting	13 - 2
14 Monitoring Noninvasive Blood Pressure (NIBP)	14 - 1
14.1 NIBP Introduction	14 - 1
14.2 NIBP Safety Information	14 - 1
14.3 NIBP Measurement Limitations	14 - 2
14.4 Measurement Modes	14 - 2
14.5 NIBP Display	14 - 2
14.6 Preparing for NIBP Measurements	14 - 3
14.6.1 Preparing the Patient for NIBP Measurements	14 - 3
14.6.2 Placing the NIBP Cuff	14 - 3
14.7 Starting and Stopping NIBP Measurements	14 - 4
14.8 Viewing NIBP Analysis	14 - 4
14.9 Changing NIBP Settings	14 - 5
14.9.1 Setting the NIBP Alarm Properties	14 - 5
14.9.2 Setting the Initial Cuff Inflation Pressure	14 - 5
14.9.3 Setting the NIBP Interval	14 - 5
14.9.4 Selecting NIBP Start Mode	14 - 5
14.9.5 Enabling the NIBP End Tone	14 - 5
14.9.6 Setting NIBP Sequence	14 - 6
14.9.7 Setting the NIBP Display Format	14 - 6
14.9.8 Setting the NIBP Alarm Limits Display Switch	14 - 6
14.9.9 Showing/Hiding PR	14 - 6
14.9.10 Correcting the NIBP Measurements	14 - 6
14.10 Assisting Venous Puncture	14 - 6
14.11 NIBP Maintenance	14 - 7
14.11.1 NIBP Leakage Test	14 - 7
14.11.2 NIBP Accuracy Test	14 - 7
14.12 NIBP Troubleshooting	14 - 7
15 Monitoring Invasive Blood Pressure (IBP) (for uMEC 70/uMEC 80/uMEC 120/uMEC 150)	15 - 1
15.1 IBP Introduction	15 - 1
15.2 IBP Safety Information	15 - 1
15.3 Preparing for IBP Monitoring	15 - 2
15.3.1 IBP Equipment to Patient Connection	15 - 2
15.3.2 Measuring an Invasive Blood Pressure	15 - 2
15.3.3 Zeroing the IBP transducer	15 - 3
15.4 Measuring ICP Using the Codman ICP Transducer	15 - 3
15.4.1 Zeroing the Codman ICP transducer	15 - 3
15.4.2 Measuring ICP	15 - 3
15.5 IBP Display	15 - 4
15.6 Changing IBP Settings	15 - 4
15.6.1 Changing the IBP Alarm Settings	15 - 4

15.6.2 Changing the Pressure Label	15 - 5
15.6.3 Setting the Pressure Type for Display	15 - 5
15.6.4 Changing the Sensitivity	15 - 5
15.6.5 Setting the IBP Waveform	15 - 6
15.6.6 Setting the Display Format of Artery Pressure	15 - 6
15.6.7 Showing/Hiding the Alarm Limits of Artery Pressure	15 - 6
15.6.8 Enabling PPV Measurement	15 - 6
15.6.9 Overlapping IBP Waveforms	15 - 7
15.7 Measuring PAWP	15 - 7
15.7.1 PAWP Equipment to Patient Connection	15 - 8
15.7.2 Preparing to Measure PAWP	15 - 8
15.7.3 Measuring PAWP	15 - 8
15.7.4 Setting the Waveforms of the PAWP Screen	15 - 9
15.7.5 Setting the Use PA-D as PAWP Switch	15 - 9
15.7.6 Performing Hemodynamic Calculation	15 - 10
15.8 IBP Troubleshooting	15 - 10
16 Monitoring Cardiac Output (C.O.) (for uMEC 70/uMEC 80/uMEC 120/uMEC 150)	16 - 1
16.1 C.O. Introduction	16 - 1
16.2 C.O. Safety Information	16 - 1
16.3 C.O. Measurement Limitations	16 - 1
16.4 C.O. Display	16 - 1
16.5 C.O. Equipment to Patient Connection	16 - 2
16.6 Performing C.O. Measurement	16 - 2
16.6.1 Preparing for C.O. Measurement	16 - 2
16.6.2 Setting C.O. Measurement	16 - 3
16.6.3 Performing C.O. Measurement	16 - 3
16.7 Changing C.O. Settings	16 - 4
16.7.1 Setting C.O. Alarm Properties	16 - 4
16.7.2 Selecting the Primary C.O. Parameter	16 - 4
16.8 C.O. Troubleshooting	16 - 4
17 Monitoring Carbon Dioxide (CO₂)(for uMEC 70/uMEC 80/uMEC 120/uMEC 150)	17 - 1
17.1 CO ₂ Introduction	17 - 1
17.2 CO ₂ Safety Information	17 - 1
17.3 CO ₂ Measurement Limitations	17 - 1
17.4 CO ₂ Display	17 - 2
17.5 Measuring CO ₂ Using Sidestream/Microstream CO ₂ Module	17 - 2
17.5.1 Preparing to Measure CO ₂ Using Sidestream CO ₂ Module	17 - 2
17.5.2 Preparing to Measure CO ₂ Using Microstream CO ₂ Module	17 - 4
17.5.3 Zeroing the Sidestream/Microstream CO ₂ Module	17 - 4
17.6 Measuring CO ₂ Using Mainstream CO ₂ Module	17 - 5
17.6.1 Preparing to Measure CO ₂ Using Mainstream CO ₂ Module	17 - 5
17.6.2 Zeroing the Mainstream CO ₂ Sensor	17 - 5
17.7 Changing Settings for All CO ₂ Modules	17 - 6
17.7.1 Changing CO ₂ Alarm Settings	17 - 6
17.7.2 Setting the CO ₂ Waveform	17 - 6

17.7.3 Setting the RR Source	17 - 6
17.7.4 Entering the Standby Mode	17 - 6
17.7.5 Entering the Intubation Mode	17 - 7
17.8 Changing Settings for Sidestream and Microstream CO ₂ Module	17 - 7
17.8.1 Setting the Auto Standby	17 - 7
17.8.2 Setting Humidity Compensation	17 - 7
17.9 Setting the Gas Compensation	17 - 7
17.10 Choosing a Time Interval for Peak-Picking	17 - 8
17.11 Changing Barometric Pressure	17 - 8
17.12 Performing the Leakage Test	17 - 9
17.13 CO ₂ Calibration	17 - 9
17.14 CO ₂ Troubleshooting	17 - 9
17.14.1 Troubleshooting the Sidestream/Microstream CO ₂ Module	17 - 9
17.14.2 Troubleshooting the Mainstream CO ₂ Module	17 - 10
17.15 Oridion Information	17 - 10
18 Review	18 - 1
18.1 Review Overview	18 - 1
18.2 Review Page	18 - 1
18.2.1 Accessing the Review Page	18 - 1
18.2.2 Example Review Page	18 - 1
18.2.3 Symbols on Review Pages	18 - 2
18.2.4 Common Operations	18 - 2
18.2.5 Tabular Trends Review Page	18 - 2
18.2.6 Reviewing the Graphics Trends	18 - 3
18.2.7 Reviewing Events	18 - 4
18.2.8 Reviewing Full Disclosure	18 - 6
18.2.9 OxyCRG Review Page	18 - 7
18.2.10 12-Lead ECG Review Page	18 - 8
18.2.11 ST Review Page	18 - 8
18.3 Reviewing Discharged Patients	18 - 9
18.3.1 Checking the Data of a Discharged Patient	18 - 9
18.3.2 Checking the Information of a Discharged Patient	18 - 9
19 Clinical Assistive Applications (CAA)	19 - 1
19.1 Early Warning Score (EWS)	19 - 1
19.1.1 Displaying the EWS Numerics Area	19 - 2
19.1.2 Accessing the EWS Screen	19 - 2
19.1.3 Performing EWS Scoring	19 - 3
19.1.4 Changing EWS Settings	19 - 4
19.1.5 Viewing Historical Scores	19 - 5
19.2 Glasgow Coma Scale (GCS)	19 - 5
19.2.1 Displaying the GCS Parameter Area	19 - 5
19.2.2 Accessing the GCS Menu	19 - 6
19.2.3 Performing GCS Scoring	19 - 6
19.2.4 Setting GCS Scoring Interval	19 - 7
19.2.5 Reviewing GCS Trend Data	19 - 7
19.3 ECG 24h Summary	19 - 7

19.3.1 Opening the ECG 24h Summary Window	19 - 7
19.3.2 The Display of ECG 24h Summary	19 - 7
19.3.3 Selecting Typical ECG Strips	19 - 8
19.3.4 Setting the Statistical Duration of the ECG 24h Summary	19 - 8
19.3.5 Reviewing the ECG Summary	19 - 8
20 Calculation	20 - 1
20.1 Calculation Overview	20 - 1
20.2 Calculation Safety Information	20 - 1
20.3 Drug Calculations	20 - 1
20.3.1 Performing Drug Calculations	20 - 1
20.3.2 Checking the Titration Table	20 - 2
20.3.3 Drug Calculation Formula	20 - 2
20.3.4 Titration Table Calculation Formula	20 - 2
20.4 Hemodynamic Calculations	20 - 3
20.4.1 Performing Hemodynamic Calculations	20 - 3
20.4.2 Input Parameters for Hemodynamic Calculations	20 - 3
20.4.3 Calculated Parameters and Formulas for Hemodynamic Calculations	20 - 3
20.5 Oxygenation Calculations	20 - 4
20.5.1 Performing Oxygenation Calculations	20 - 4
20.5.2 Input Parameters for Oxygenation Calculations	20 - 5
20.5.3 Calculated Parameters and Formulas for Oxygenation Calculations	20 - 5
20.6 Ventilation Calculations	20 - 6
20.6.1 Performing Ventilation Calculations	20 - 6
20.6.2 Input Parameters for Ventilation Calculations	20 - 6
20.6.3 Calculated Parameters and Formulas for Ventilation Calculations	20 - 6
20.7 Renal Calculations	20 - 7
20.7.1 Performing Renal Calculations	20 - 7
20.7.2 Calculated Parameters and Formulas for Renal Calculations	20 - 7
20.7.3 Calculated Parameters and Formulas for Renal Calculations	20 - 8
21 Recording	21 - 1
21.1 Recorder	21 - 1
21.2 Starting Recordings	21 - 1
21.2.1 Manually Starting Recordings	21 - 1
21.2.2 Automatic Recordings	21 - 1
21.3 Stopping Recordings	21 - 2
21.3.1 Stopping Recordings Manually	21 - 2
21.3.2 Stopping Recordings Automatically	21 - 2
21.4 Recording Related Flags	21 - 2
21.5 Setting the Recorder	21 - 2
21.6 Enabling Auto Recording on Alarm	21 - 2
21.7 Clearing Recording Tasks	21 - 3
21.8 Loading Paper	21 - 3
21.9 Removing Paper Jam	21 - 3
22 Printing	22 - 1
22.1 Supported Printer	22 - 1

22.2 End Case Reports	22 - 1
22.2.1 Printing the End Case Report	22 - 1
22.2.2 Setting a Report as An End Case Report	22 - 1
22.2.3 Setting the End Case Report	22 - 2
22.2.4 Setting the End Case Report Period	22 - 2
22.3 Manually Starting a Printing Task	22 - 2
22.3.1 Starting Printing from the Current Page	22 - 2
22.3.2 Printing Realtime Reports	22 - 2
22.3.3 Printing General Reports	22 - 2
22.4 Automatically Printing Reports	22 - 3
22.5 Stopping a Printing Task	22 - 3
22.6 Setting Reports	22 - 3
22.6.1 Setting ECG Reports	22 - 3
22.6.2 Setting Realtime Reports	22 - 4
22.6.3 Setting Tabular Trends Reports	22 - 4
22.6.4 Setting Graphic Trends Reports	22 - 5
22.7 Viewing Printer Status	22 - 5
22.8 Printer Out of Paper	22 - 5
23 User Maintenance Settings	23 - 1
23.1 Accessing the Maintenance Menu	23 - 1
23.2 The Device Location Settings	23 - 1
23.3 The Patient Management Settings	23 - 2
23.3.1 The Field Tab	23 - 2
23.3.2 The Find Patient Tab	23 - 2
23.3.3 The Discharge Tab	23 - 3
23.3.4 The Location Tab	23 - 3
23.3.5 The Display Tab	23 - 3
23.4 The Alarm Settings	23 - 4
23.4.1 The Audio Tab	23 - 4
23.4.2 The Pause/Reset Tab	23 - 5
23.4.3 The Latching Tab	23 - 6
23.4.4 The Remote View Tab	23 - 6
23.4.5 The Nurse Call Tab	23 - 7
23.4.6 The Other Tab	23 - 7
23.5 The CAA Settings	23 - 8
23.5.1 The EWS Tab	23 - 8
23.5.2 The GCS Tab	23 - 9
23.6 The Module Settings	23 - 9
23.6.1 The ECG Tab	23 - 9
23.6.2 The CO2 Tab (for uMEC 70/uMEC 80/uMEC 120/uMEC 150)	23 - 10
23.6.3 The Other Tab	23 - 10
23.7 The Review Settings	23 - 10
23.7.1 The Tabs Tab	23 - 10
23.7.2 The Event Tab	23 - 11
23.7.3 The Arrhy Mark Tab	23 - 11
23.7.4 The Export Tab	23 - 11
23.7.5 The Save Path Tab	23 - 11

23.8 The Print Settings	23 - 11
23.8.1 The Printer Tab	23 - 11
23.8.2 The Report Layout Tab	23 - 12
23.8.3 The ECG Report Tab	23 - 13
23.8.4 The PDF File Name Tab	23 - 13
23.8.5 The Other Tab	23 - 13
23.9 The Unit Settings	23 - 13
23.10 The Time Settings	23 - 14
23.10.1 The Time Synchronization Tab	23 - 14
23.10.2 The Daylight Savings Time Tab	23 - 14
23.11 The Other Settings	23 - 14
23.12 The Authorization Setup Settings	23 - 15
23.13 The Version Settings	23 - 16
23.14 The Battery Information Settings	23 - 16
23.15 The Scanner Settings	23 - 17
23.15.1 The 2D Barcode Tab (for the Mindray Custom 2D Barcode Reader)	23 - 17
23.15.2 The 1D Barcode Tab	23 - 17
23.15.3 The Scanner Information Tab	23 - 17
23.15.4 The Identify Scanner Tab (for the non-Mindray Custom 2D Barcode Reader)	23 - 17
23.15.5 The Field Tab (for the Mindray Custom 2D Barcode Reader)	23 - 18
23.16 The Network Setup Settings	23 - 18
23.16.1 The Network Type Tab	23 - 18
23.16.2 The LAN1 IP Tab	23 - 18
23.16.3 The WLAN Tab	23 - 18
23.16.4 The Central Station Setup Tab	23 - 19
23.16.5 The Device Discover Tab	23 - 19
23.16.6 The QoS Tab	23 - 20
23.16.7 The ADT Tab	23 - 20
23.16.8 The HL7 Configuration Tab	23 - 20
23.16.9 The Information Security Tab	23 - 21
23.16.10 The MLDAP Tab	23 - 21
24 Battery	24 - 1
24.1 Battery Introduction	24 - 1
24.2 Battery Safety Information	24 - 1
24.3 Battery Indications	24 - 1
24.3.1 Battery LED	24 - 1
24.3.2 Battery Symbols	24 - 2
24.3.3 Battery-related Alarms	24 - 2
24.4 Charging the Battery	24 - 2
24.5 Maintaining the Battery	24 - 2
24.5.1 Conditioning the Battery	24 - 2
24.5.2 Checking Battery Performance	24 - 3
24.6 Storing Batteries	24 - 3
24.7 Recycling Batteries	24 - 3
25 Care and Cleaning	25 - 1
25.1 Care and Cleaning Introduction	25 - 1

25.2 Care and Cleaning Safety Information	25 - 1
25.3 Cleaning the Monitor	25 - 1
25.4 Disinfecting the Monitor	25 - 2
25.5 Cleaning and Disinfecting the Accessories	25 - 2
25.5.1 Cleaning the Accessories	25 - 2
25.5.2 Disinfecting the Accessories	25 - 3
25.6 Sterilization	25 - 4
25.7 Cleaning the Thermal Print Head	25 - 4
25.8 Impact of Improper Cleaning	25 - 4
26 Maintenance	26 - 1
26.1 Maintenance Introduction	26 - 1
26.2 Maintenance Safety Information	26 - 1
26.3 Maintenance and Testing Schedule	26 - 2
26.4 Checking Version Information	26 - 2
26.5 Testing Methods and Procedures	26 - 2
26.5.1 Performing Visual Inspection	26 - 3
26.5.2 Performing Power-on Test	26 - 3
26.5.3 Testing the Recorder	26 - 3
26.5.4 Testing the Network Printer	26 - 3
26.5.5 Checking the Battery	26 - 3
26.6 Disposing of the Equipment	26 - 3
27 Accessories	27 - 1
27.1 ECG Accessories	27 - 1
27.1.1 ECG Electrodes	27 - 1
27.1.2 12-Pin Separable Trunk Cables	27 - 1
27.1.3 12-Pin Integrative Trunk Cables	27 - 2
27.1.4 3-lead ECG Leadwires	27 - 2
27.1.5 5-lead ECG Leadwires	27 - 3
27.1.6 6-lead ECG Leadwires	27 - 3
27.1.7 12-lead ECG Leadwires	27 - 3
27.2 SpO ₂ Accessories	27 - 4
27.2.1 Extension Cables	27 - 4
27.2.2 SpO ₂ Sensors	27 - 4
27.3 Temp Accessories	27 - 5
27.3.1 Temp Cable	27 - 5
27.3.2 Temp Probes	27 - 5
27.4 NIBP Accessories	27 - 5
27.4.1 NIBP Hoses	27 - 5
27.4.2 Cuffs	27 - 5
27.5 IBP Accessories (for uMEC 70/uMEC 80/uMEC 120/uMEC 150)	27 - 6
27.6 C.O. Accessories (for uMEC 70/uMEC 80/uMEC 120/uMEC 150)	27 - 7
27.7 CO ₂ Accessories (for uMEC 70/uMEC 80/uMEC 120/uMEC 150)	27 - 7
27.7.1 Sidestream CO ₂ Accessories	27 - 7
27.7.2 Microstream CO ₂ Accessories	27 - 7
27.7.3 Mainstream CO ₂ Accessories	27 - 8

27.8 Mount and Mounting Accessories	27 - 8
27.9 Miscellaneous Accessories	27 - 9
A Product Specifications	A - 1
A.1 Monitor Safety Specifications	A - 1
A.2 Physical Specifications	A - 1
A.3 Environmental Specifications	A - 1
A.4 Power Supply Specifications	A - 2
A.4.1 External Power Supply Specifications	A - 2
A.4.2 Battery Specifications	A - 2
A.5 Display Specifications	A - 3
A.6 Recorder Specifications	A - 3
A.7 LEDs	A - 4
A.8 Audio Indicator	A - 4
A.9 Monitor Interface Specifications	A - 4
A.10 Signal Outputs Specifications	A - 4
A.11 Data Storage	A - 5
A.12 Wi-Fi Specifications	A - 5
A.12.1 Wi-Fi Technical Specifications	A - 5
A.12.2 Wi-Fi Performance Specifications	A - 6
A.13 Measurement Specifications	A - 7
A.13.1 ECG Specifications	A - 7
A.13.2 Resp Specifications	A - 9
A.13.3 SpO ₂ Specifications	A - 10
A.13.4 PR Specifications.....	A - 11
A.13.5 Temp Specifications	A - 11
A.13.6 NIBP Specifications	A - 12
A.13.7 IBP Specifications (for uMEC 70/uMEC 80/uMEC 120/uMEC 150)	A - 14
A.13.8 C.O. Specifications (for uMEC 70/uMEC 80/uMEC 120/uMEC 150)	A - 15
A.13.9 CO ₂ Specifications (for uMEC 70/uMEC 80/uMEC 120/uMEC 150)	A - 15
A.14 Software Operating Environment	A - 18
B EMC and Radio Regulatory Compliance	B - 1
B.1 EMC	B - 1
B.2 Radio Regulatory Compliance	B - 5
C Default Settings	C - 1
C.1 Parameters Default Settings	C - 1
C.1.1 ECG, Arrhythmia, ST and QT Default Settings	C - 1
C.1.2 Respiration Default Settings	C - 4
C.1.3 SpO ₂ Default Settings	C - 5
C.1.4 Temperature Default Settings	C - 6
C.1.5 NIBP Default Settings	C - 6
C.1.6 IBP Default Settings (for uMEC 70/uMEC 80/uMEC 120/uMEC 150)	C - 8
C.1.7 C.O. Default Settings (for uMEC 70/uMEC 80/uMEC 120/uMEC 150)	C - 11
C.1.8 CO ₂ Default Settings (for uMEC 70/uMEC 80/uMEC 120/uMEC 150)	C - 12
C.2 Routine Default Settings	C - 13
C.2.1 Alarm Default Settings	C - 13

C.2.2 Review Default Settings	C - 13
C.2.3 Minitrends Default Settings	C - 14
C.2.4 OxyCRG Default Settings	C - 14
C.2.5 Remote View Default Settings	C - 14
C.2.6 Display Default Settings	C - 14
C.2.7 Report Default Settings	C - 15
C.2.8 Calculations Default Settings	C - 16
C.2.9 System Time Default Settings	C - 16
D Alarm Messages	D - 1
D.1 Physiological Alarm Messages	D - 1
D.1.1 General Physiological Alarm Messages	D - 1
D.1.2 Arrhythmia Alarm Messages	D - 1
D.1.3 ST Physiological Alarm Messages	D - 2
D.1.4 Resp Physiological Alarm Messages	D - 2
D.1.5 SpO ₂ Physiological Alarm Messages	D - 2
D.1.6 PR Physiological Alarm Messages	D - 2
D.1.7 NIBP Physiological Alarm Messages	D - 3
D.1.8 IBP Physiological Alarm Messages (for uMEC 70/uMEC 80/uMEC 120/uMEC 150)	D - 3
D.2 Technical Alarm Messages	D - 3
D.2.1 General Technical Alarm Messages	D - 3
D.2.2 ECG Technical Alarm Messages	D - 3
D.2.3 Resp Technical Alarm Messages	D - 4
D.2.4 SpO ₂ Technical Alarm Messages	D - 4
D.2.5 Temp Technical Alarm Messages	D - 5
D.2.6 NIBP Technical Alarm Messages	D - 5
D.2.7 IBP Technical Alarm Messages (for uMEC 70/uMEC 80/uMEC 120/uMEC 150)	D - 6
D.2.8 C.O. Technical Alarm Messages (for uMEC 70/uMEC 80/uMEC 120/uMEC 150)	D - 6
D.2.9 CO ₂ Technical Alarm Messages (for uMEC 70/uMEC 80/uMEC 120/uMEC 150)	D - 6
D.2.10 EWS Technical Alarms	D - 8
D.2.11 Power Supply Technical Alarm Messages	D - 8
D.2.12 Recorder Technical Alarm Messages	D - 9
D.2.13 Printer Technical Alarm Messages	D - 9
D.2.14 Technical Alarm Messages Related to Networked Monitoring	D - 9
D.2.15 Other System Technical Alarm Messages	D - 10
E Electrical Safety Inspection	E - 1
E.1 Power Cord Plug	E - 1
E.2 Device Enclosure and Accessories	E - 1
E.2.1 Visual Inspection	E - 1
E.2.2 Contextual Inspection	E - 1
E.3 Device Labeling	E - 2
E.4 Protective Earth Resistance	E - 2
E.5 Earth Leakage Test	E - 2
E.6 Patient Leakage Current	E - 2
E.7 Mains on Applied Part Leakage	E - 3
E.8 Patient Auxiliary Current	E - 3
F Electronic Interface	F - 1

G An ECG Wave Recognition Method for Mindray Resting 12-lead ECG Analysis Algorithm	G - 1
G.1 Preprocessing	G - 1
G.2 QRS typing	G - 1
G.3 Selection of required QRS class	G - 1
G.4 Averaging	G - 1
G.5 Wave measurement	G - 1
G.6 QRS components	G - 1
G.7 ST segment	G - 1
G.8 P and T waves	G - 2
G.9 Evaluation results of absolute interval and wave duration measurements	G - 2
G.10 Evaluation results of interval measurements on biological ECGs	G - 2
G.11 Evaluation results of stability of measurements against noise	G - 2
H Units, Symbols and Abbreviations	H - 1
H.1 Units	H - 1
H.2 Symbols	H - 2
H.3 Abbreviations	H - 3
I Declaration of Conformity	I - 1

1 Safety

1.1 Safety Information

WARNING

- Indicates a potential hazard or unsafe practice that, if not avoided, could result in death or serious injury.
-
-

CAUTION

- Indicates a potential hazard or unsafe practice that, if not avoided, could result in minor personal injury or product/property damage.
-

NOTE

- Provides application tips or other useful information to ensure that you get the most from your product.
-

1.1.1 Warnings

WARNING

- This equipment is used for single patient at a time.
 - To avoid explosion hazard, do not use the equipment in the presence of oxygen-rich atmospheres, flammable anesthetics, or other flammable agents.
 - Use and store the equipment in specified environmental condition. The monitor and accessories may not meet the performance specification due to aging, stored or used outside the specified temperature and humidity range.
 - The equipment is not intended to be used within the Magnetic Resonance (MR) environment.
 - Before connecting the equipment to the power line, check that the voltage and frequency ratings of the power line are the same as those indicated on the equipment's label or in this manual.
 - Before putting the system into operation, the operator must verify that the equipment, connecting cables and accessories are in correct working order and operating condition.
 - To avoid risk of electric shock, the equipment must only be connected to mains power with protective earth. If a protective earth conductor is not provided, operate it on battery power, if possible.
 - Do not use the multiple portable socket outlets (MPSO) or AC mains extension cords. Insure that the sum of the individual ground leakage currents does not exceed the allowable limits.
 - Do not touch the patient and live parts simultaneously. Otherwise patient injury may result.
 - Do not come into contact with the patient during defibrillation. Otherwise serious injury or death could result.
 - Do not open the equipment housings. All servicing and future upgrades must be carried out by trained and authorized personnel.
 - Do not exclusively rely on audible alarms for patient monitoring. Adjusting alarm volume to a low level or turning off alarm sound may result in patient hazards.
 - Customize alarm settings according to patient situations and keep patients under close surveillance.
 - Do not place the equipment or accessories in any position that might cause it to fall on the patient.
 - Do not start or operate the equipment unless the setup was verified to be correct.
-

- To avoid inadvertent disconnection, route all cables in a way to prevent a stumbling hazard. Wrap and secure excess cabling to reduce risk of entanglement by patients or personnel.
 - If any measurement seems questionable, first check the patient's vital signs by alternate means and then check the equipment for proper functioning.
 - Physiological data and alarm messages provided by the monitor should not be used as the only basis for diagnosis or therapy decisions. They must be used in conjunction with clinical signs and symptoms. Misinterpreting measured values or other parameters may result in patient hazards.
 - The software equipment copyright is solely owned by Mindray. No organization or individual shall resort to modifying, copying, or exchanging it or to any other infringement on it in any form or by any means without due permission.
-
-

1.1.2 Cautions

CAUTION



























- Use only parts and accessories specified in this manual.
 - Ensure that the equipment is supplied with continuous electric power during work. Sudden power failure may cause data loss.
 - Magnetic and electrical fields are capable of interfering with the proper performance of the equipment. For this reason make sure that all external devices operated in the vicinity of the equipment comply with the relevant EMC requirements. Mobile phone, X-ray equipment or MRI devices are a possible source of interference as they may emit higher levels of electromagnetic radiation.
 - Always install or carry the equipment properly to avoid damage caused by drop, impact, strong vibration or other mechanical force.
 - Dry the equipment immediately in case of rain or water spray.
 - Some settings are password protected and can only be changed by authorized personnel. Contact your department manager or biomedical engineering department for the passwords used at your facility.
 - Do not loop the patient cabling into a tight coil or wrap around the device, as this can damage the patient cabling.
 - Dispose of the package material as per the applicable waste control regulations. Keep it out of children's reach.
 - At the end of its service life, the equipment, as well as its accessories, must be disposed of in compliance with the guidelines regulating the disposal of such products. If you have any questions concerning disposal of the equipment, please contact us.
-









1.1.3 Notes

NOTE



- Put the equipment in a location where you can easily view and operate the equipment. The intended location for the equipment is where users can touch with hands.
 - The equipment use a mains plug as isolation means to the mains power. Do not locate the equipment in a place difficult to operate the mains plug.
 - In normal use, the operator is expected to be in front of the equipment.
 - The software was developed in compliance with IEC62304.
 - This manual includes information related to all features of the monitor. Some features may not be available on your monitor.
 - Keep this manual in the vicinity of the equipment so that it can be obtained conveniently when needed.
-

1.2 Equipment Symbols

Symbol	Description	Symbol	Description
	General warning sign		Refer to instruction manual/booklet
	Serial number		Temperature limitations
	Date of manufacture		Manufacturer
	USB connector		Graphical record
	Battery indicator		Computer network
	Equipotentiality		Alternating current
	DEFIBRILLATION-PROOF TYPE CF APPLIED PART		DEFIBRILLATION-PROOF TYPE BF APPLIED PART
	NIBP start/stop		Calibration
	Stand-by		Menu
IPX1	Protected against vertically falling water drops per IEC 60529		Non-ionizing electromagnetic radiation
	Alarm pause		Alarm reset
	Gas outlet		Output
	Video output		Defibrillation synchronization output
	Humidity limitations		Atmospheric pressure limitations

Symbol	Description	Symbol	Description
	Stacking limit by number		Keep dry
	This way up		Fragile; handle with care
	Authorised representative in the European Community		Dispose of in accordance to your country's requirements
	Unique Device Identifier		Medical Device
	The product bears CE mark indicating its conformity with the provisions of the REGULATION (EU) 2017/745 on medical devices and fulfills the general safety and performance requirements of Annex I of this regulation. Note: The product complies with the Council Directive 2011/65/EU.		

The general meaning assigned to geometric shapes, safety colors and contrast colors for safety signs are as follows:

Geometric shape	Meaning	Safety color	Contrast color	Graphical symbol color
	Mandatory action	Blue	White	White
	Warning	Yellow	Black	Black

2 Equipment Introduction

2.1 Intended Use

2.1.1 Intended Purpose Statement

The patient monitor is intended for monitoring, displaying, reviewing, storing, alarming and transferring of multiple physiological parameters.

2.1.2 Indication for Use

The patient monitor is intended to be used for monitoring, displaying, reviewing, storing, alarming and transferring of multiple physiological parameters including ECG (3-lead, 5-lead, 6-lead, and 12-lead selectable, arrhythmia detection, ST segment analysis, QT/QTc monitoring, and heart rate (HR)), respiration (Resp), temperature (Temp), pulse oxygen saturation (SpO₂), pulse rate (PR), non-invasive blood pressure (NIBP), invasive blood pressure (IBP), cardiac output (C.O.), carbon dioxide (CO₂). The monitor also provides interpretation of resting 12-lead ECG and CrozFusion.

2.1.3 Medical Conditions

The patient monitor is expected to be used in medical institutions, and its application fields include: operating room, anesthesia induction and postoperative recovery, intensive care unit, emergency care, respiratory care, Cardiac Care Unit, neural care, dialysis care, neonatal care, elderly care, obstetric care, internal medicine and surgical care.

2.1.4 Intended Users

The patient monitor is to be used in healthcare facilities by clinical professionals or under their guidance.

2.1.5 Intended Patient Population

All the parameters can be monitored on single adult, pediatric, and neonatal patients with the exception of the following: the C.O. monitoring and CrozFusion are intended for adult patients only.

2.1.6 Contra-indications

The CrozFusion function is contraindicated in the following situations:

- Performing CPR
- Performing CPB or using V-A ECMO
- Using IABP
- Patients in persistent and regular restlessness

2.1.7 Side-effects

None.

According to the conclusion of clinical evaluation and residual risk evaluation, for the intended patients, there is no known side effects that can occur during or after the use of the medical device. And there is no need for the operator to make extra preparations. Thus, no residual risk associated with using the medical device should be disclosed.

2.2 Applied Parts

The applied parts of the monitor are:

- ECG electrode and leadwire
- SpO₂ sensor
- Temp probe
- NIBP cuff
- IBP transducer (for uMEC 70/uMEC 80/uMEC 120/uMEC 150)
- C.O. sensor (for uMEC 70/uMEC 80/uMEC 120/uMEC 150)
- CO₂ sampling line/nasal sampling cannula, water trap, and mask (for uMEC 70/uMEC 80/uMEC 120/uMEC 150)

2.3 System Components

The monitor consists of the main unit, display, input devices, and output devices.

NOTE

- **Your monitor may not include all these components. Contact your local service personnel for the available components.**

2.3.1 Main Unit

The main unit processes data from modules.

2.3.1.1 Front View

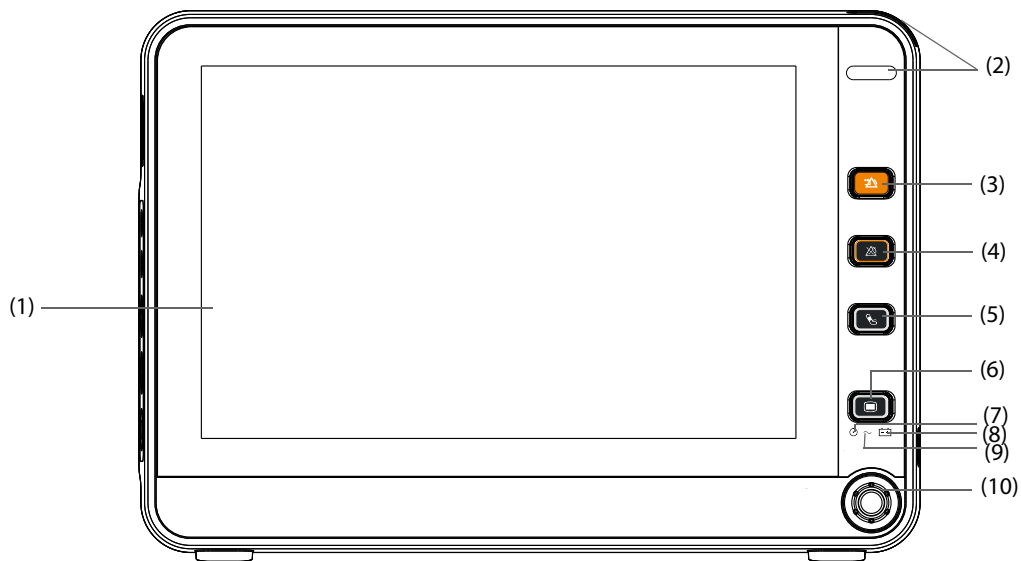

- (1) Display
- (2) Alarm lamp
When a physiological alarm or technical alarm occurs, this lamp lights and flashes corresponding with the alarm priority:
 - ◆ High priority alarms: the lamp quickly flashes red.
 - ◆ Medium priority alarms: the lamp slowly flashes yellow.
 - ◆ Low priority alarms: the lamp lights in yellow without flashing.
- (3) Alarm Reset hard key
Press to reset the alarm system.

- (4) Alarm Pause hard key
Press to pause the physiological alarm system.
- (5) NIBP Start/Stop hard key
Press to start an NIBP measurement or stop the current NIBP measurement.
- (6) Main Menu hard key
If no menu is displayed on the screen, pressing it will enter the main menu. If there is a menu displayed on the screen, pressing it will close that menu.
- (7) Power On/Off indicator
 - ◆ On: when the monitor is turned on.
 - ◆ Off: when the power is turned off.
- (8) Battery indicator
 - ◆ Green: the battery is fully charged or being charged.
 - ◆ Flashing green: the monitor operates on battery power.
 - ◆ Off: no battery is installed, or the battery is malfunctioning, or the monitor is powered off and no power is connected.
- (9) AC Power indicator
 - ◆ On: when the AC power is connected.
 - ◆ Off: when the AC power is not connected.
- (10) Knob
Rotate the Knob clockwise or anti-clockwise. With each click, the highlight jumps to the neighboring item. When you reach your desired item, press the Knob to select it.

2.3.1.2 Left View

uMEC 60/uMEC 100

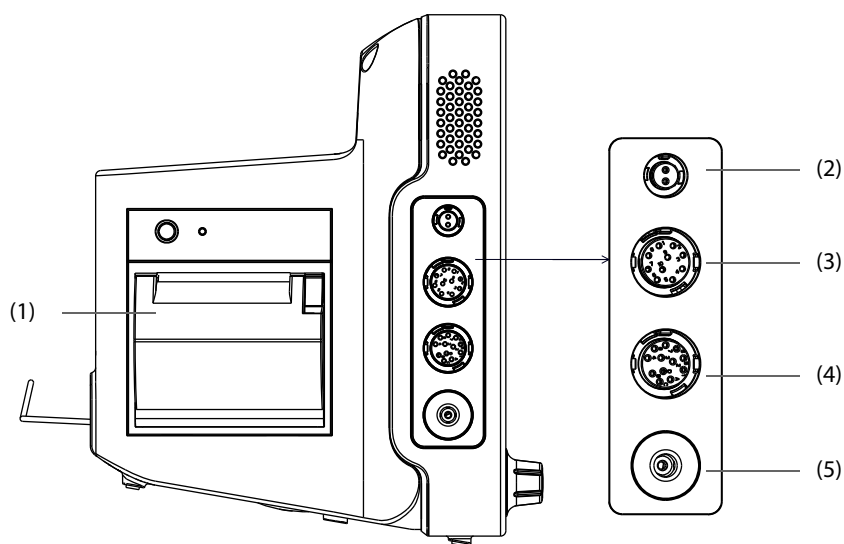

(1) Recorder

(3) SpO₂ probe connector

(5) NIBP cuff connector

(2) Temperature probe connector

(4) ECG cable connector

uMEC 70/uMEC 80/uMEC 120/uMEC 150

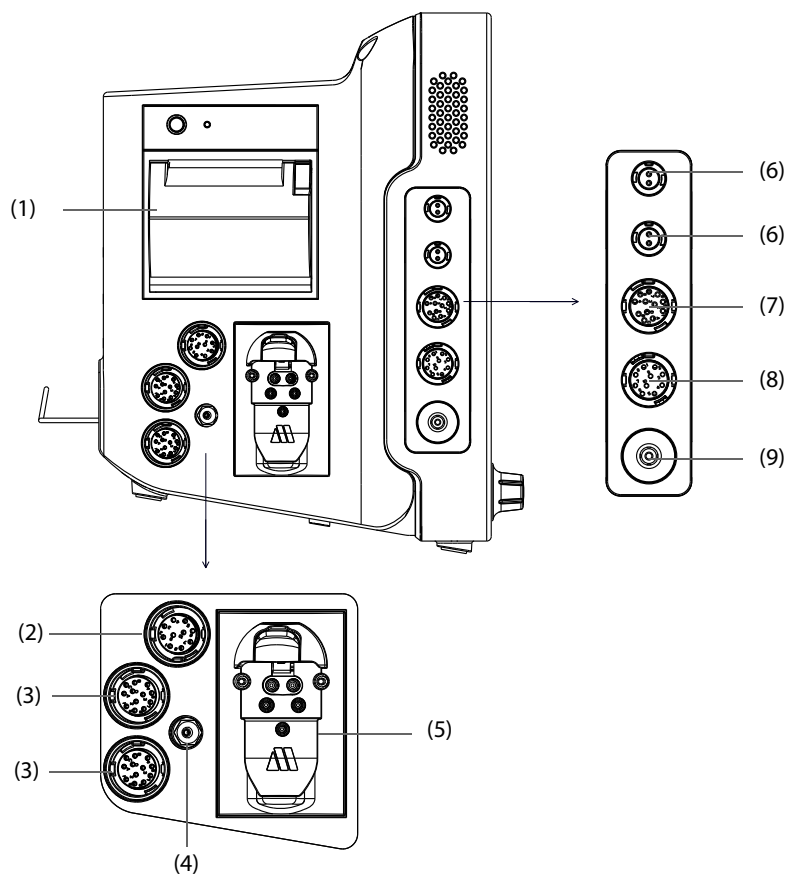

(1) Recorder

(3) IBP cable connector

(5) CO₂ watertrap seat

(7) SpO₂ probe connector

(9) NIBP cuff connector

(2) C.O. cable connector

(4) CO₂ Gas outlet

(6) Temperature probe connector

(8) ECG cable connector

2.3.1.3 Right View

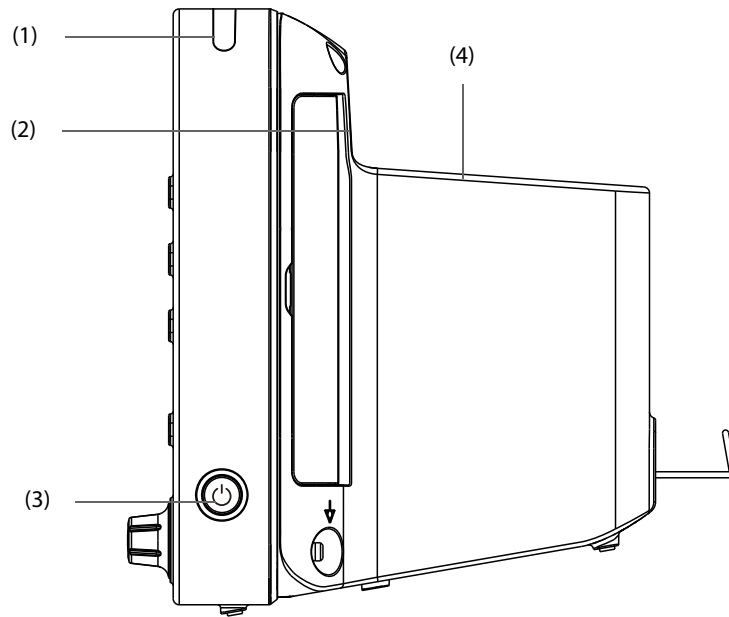

- (1) Alarm lamp
When a physiological alarm or technical alarm occurs, this lamp lights and flashes corresponding with the alarm priority:
- ◆ High priority alarms: the lamp quickly flashes red.
 - ◆ Medium priority alarms: the lamp slowly flashes yellow.
 - ◆ Low priority alarms: the lamp lights in yellow without flashing.
- (2) Handle
- (3) Power switch
- ◆ Pressing this switch turns on the monitor.
 - ◆ When the monitor is on, pressing and holding this switch for 3 seconds to turn off the monitor.
- (4) Storage space: it is used to store cables etc.

2.3.1.4 Rear View

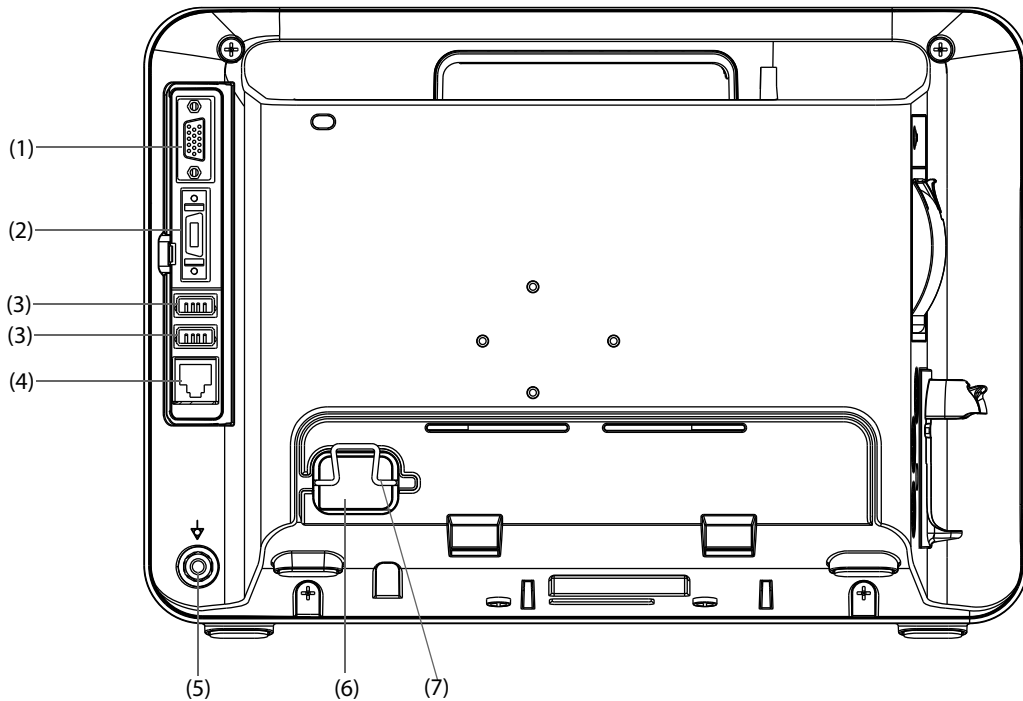

- (1) **VGA Connector**
It connects a external display, which extends the display capability of your monitor. The contents displayed on the external display screen accords with those displayed on the monitor screen.
- (2) **Multifunctional Connector**
It outputs defibrillator synchronization signals, nurse call signals and analogy output signals.
- (3) **USB connectors**
It connects USB devices, for example the barcode reader.
- (4) **Network Connector**
It is a standard RJ45 connector which connects the monitor to the central monitoring system (CMS) or other network devices.
- (5) **Equipotential Grounding Terminal**
When using the monitor together with other devices, connect their equipotential grounding terminals together to eliminate the potential difference between them.
- (6) **AC Power input**
- (7) **Power mousing- hook**

2.3.2 Input Devices

The monitor allows data entry through touchscreen, hardkey and barcode reader.

You can only use Mindray specified input devices.

2.3.3 Printing Devices

You can use Mindray specified printer and/or recorder to output patient information and data.

The monitor is configured with a build-in recorder.

The printer can be connected to the monitor through the network to output patient reports.

3 Getting Started

3.1 Equipment Preparation Safety Information

WARNING

- Use only installation accessories specified by Mindray.
 - The equipment software copyright is solely owned by Mindray. No organization or individual shall resort to modifying, copying, or exchanging it or to any other infringement on it in any form or by any means without due permission.
 - Connect only approved devices to this equipment. Devices connected to the equipment must meet the requirements of the applicable IEC standards (e.g. IEC 60950 safety standards for information technology equipment and IEC 60601-1 safety standards for medical electrical equipment). The system configuration must meet the requirements of the IEC 60601-1 medical electrical systems standard. Any personnel who connect devices to the equipment's signal input/output port are responsible for providing evidence that the safety certification of the devices has been performed in accordance to the IEC 60601-1. If you have any questions, please contact Mindray.
 - The monitor and parameter monitoring accessories are suitable for use within the patient environment. For other equipment and accessories connected to the monitor, consult corresponding manufacturers for the suitability within the patient environment.
 - If it is not evident from the equipment specifications whether a particular combination with other devices is hazardous, for example, due to summation of leakage currents, please consult the manufacturer or an expert in the field. A determination must be made that the proposed combination will not negatively affect the devices themselves or the patient's safety.
 - If the accuracy of any value displayed on the monitor, CMS system, or printed on a graph strip or report is questionable, determine the patient's vital signs by alternative means. Verify that all equipment is working correctly.
-

CAUTION

- The equipment should be installed by authorized Mindray personnel.
 - When disposing of the packaging material, be sure to observe the applicable waste control regulations and keep it out of children's reach.
 - Before use, verify whether the packages are intact, especially the packages of single use accessories. In case of any damage, do not apply it to patients.
 - Make sure that the equipment operating environment meets the specific requirements. Otherwise unexpected consequences, e.g. damage to the equipment, could result.
 - Observance of this manual is a prerequisite for proper product performance and correct operation and ensures patient and operator safety.
-

NOTE

- Put the equipment in a location where you can easily view and operate the equipment.
 - Keep this manual in the vicinity of the equipment so that it can be conveniently referenced when needed.
 - Save the packing case and packaging material as they can be used if the equipment must be reshipped.
-

3.2 Monitor Installation

The monitor can be installed in various ways as required.

- Wall mount
- Placed on desk
- Trolley tray
- Bedrail clamp
- Bedrail hook

3.2.1 Unpacking and Checking

Before unpacking, examine the packing case carefully for signs of damage. If any damage is detected, contact the carrier or us.

If the packing case is intact, open the package and remove the equipment and accessories carefully. Check all materials against the packing list and check for any mechanical damage. Contact us in case of any problem.

3.2.2 Environmental Requirements

The operating environment of the equipment must meet the requirements specified in this manual.

The environment where the equipment is used shall be reasonably free from noises, vibration, dust, corrosive, flammable and explosive substances. If the equipment is installed in a cabinet, sufficient space in front and behind shall be left for convenient operation, maintenance and repair. Moreover, to maintain good ventilation, the equipment shall be at least 2 inches (5cm) away from around the cabinet.

When the equipment is moved from one place to another, condensation may occur as a result of temperature or humidity difference. In this case, never start the system before the condensation disappears.

3.3 Setting Up the Equipment

Observance of this manual is a prerequisite for proper product performance and correct operation. It ensures patient and operator safety.

3.3.1 Connecting the AC Mains

The monitor is powered by AC power supply. Before connecting the equipment to the AC mains, check that the voltage and frequency ratings of the power line are the same as those indicated beside the AC power input.

To use the AC power source, follow this procedure:

1. Connect the female end of the power cord with the AC power input.
2. Connect the male end of the power cord with a wall AC outlet.
3. Check that the power indicator is on.

The AC indicator is off if the AC mains is not connected. When AC mains is connected, the AC indicator is illuminated in green.

WARNING

- **Always use the accompanying power cord delivered with the monitor.**
 - **Before connecting the equipment to the AC mains, check that the voltage and frequency ratings of the power line are the same as those indicated beside the AC power input.**
 - **Use the cable retainer to secure the power cord to prevent it from falling off.**
 - **Use the battery if the integrity of the protective earth conductor or the protective earthing system in the installation is in doubt.**
-

3.3.2 Connecting the Input Devices

Connect the barcode reader if necessary.

3.4 Turning on the Monitor

Before turn on the monitor, perform the following inspections:

1. Check the monitor for any mechanical damage. Make sure that all external cables, plug-ins and accessories are properly connected.
2. Connect the power cord to the power supply.

To turn on the monitor, press the power switch.

When the monitor is turned on, the alarms are paused for two minutes. Then the alarm system is activated.

CAUTION

- **Check that visual and auditory alarm signals are presented correctly when the equipment is powered on.**
 - **Do not use the monitor for any monitoring procedure on a patient if you suspect it is not working properly, or if it is mechanically damaged. Contact the service personnel or Mindray.**
-

3.5 Operation on the Screen

Screen elements include parameter values, waveforms, quick keys, menus, information area, alarms areas, and so on. Almost all screen elements are interactive. You can access the same element in different ways. For example, you can enter a parameter menu by selecting corresponding numeric area or waveform area, by pressing the Menu hard key  on the parameter module, or by selecting the **Parameters Setup** quick key.

3.5.1 Using the Touchscreen

You can touch the screen or swipe across the screen with your fingers to operate the monitor.

3.5.1.1 Tapping or Swiping across the Screen

■ Tapping the screen

- ◆ To select an item from menus or lists, tap on the item with your finger.
- ◆ To select a quick key, tap on the key with your finger.
- ◆ To enter a parameter menu, tap corresponding numeric area or waveform area. For example, select the ECG numeric area or waveform area to enter the **ECG** menu.

■ Swiping across the screen with a single finger

- ◆ To display the configured quick keys, swipe to the left the  symbol.
- ◆ To scroll through a list and a menu, swipe up and down.
- ◆ To adjust the screen brightness, swipe up and down on the left part of the main screen.
- ◆ To adjust the alarm volume, swipe up and down on the right part of the main screen.
- ◆ To set wireless network, swipe down from the top.

■ Swiping across the screen with two fingers

- ◆ To switch to another screen, swipe left or right across the screen. For example, on the normal screen, swipe with two fingers from left to right to switch to the Minitrends screen.
- ◆ To discharge a patient, swipe from top to bottom.

3.5.1.2 Locking the Touchscreen

To avoid misuse, you can temporarily disable the touchscreen. To do so, hold and press the **Main Menu** quick key and slide as directed by the arrow. A padlock symbol  displays at the top of the main menu quick key if the touchscreen is disabled.

The touchscreen lock period is configurable. To do so, follow this procedure:

1. Access **Display** in either of the following ways:
 - ◆ Select the **Screen Setup** quick key → select the **Display** tab.
 - ◆ Select the **Main Menu** hard key or quick key → from the **Display** column select **Display**.
2. Set **Screen Lock Duration**.

The touchscreen is enabled when the preset time is reached. If you need to manually enable the touchscreen, hold and press the **Main Menu** quick key and slide as directed by the arrow.

CAUTION





- **Check that the touchscreen is not damaged or broken. If there is any sign of damage, stop using the monitor and contact the service personnel.**
 - **If the touchscreen is loose, stop using the monitor and contact the service personnel.**
-

3.5.2 Using the Knob

Rotate the Knob clockwise or anti-clockwise. With each click, the highlight jumps to the neighboring item. When you reach your desired item, press the Knob to select it.

3.5.3 Using the On-Screen Keyboard

The on-screen keyboard enables you to enter information:

- Enter the information by selecting one character after another.
- Select the Backspace key  to delete single characters or select  to delete the entire entry.
- Select the Caps Lock key  to access uppercase letters.
- Select the Enter key  to confirm the entry and close the on-screen keyboard.

3.5.4 Using the Barcode Reader

The monitor supports both linear (1D) barcode reader and two-dimension (2D) barcode reader. The barcode reader is connected to the monitor's USB connector.

NOTE

- **You can use the Mindray custom barcode reader to scan both the 2D and 1D barcodes. Using other barcode readers can only output the patient's medical record number (MRN) and visit number.**
-

3.5.4.1 Clearing Old Data Formats (for the Mindray Custom 2D Barcode Reader)

If you are using the Mindray custom 2D barcode reader (Model HS-1R or HS-1M), before using it for the first time, clear old data formats and configure the barcode reader.

Before configuring the Mindray custom barcode reader, clear old data formats. To do so, follow this procedure:

1. Scan the engineering barcode to clear the previous data format.
2. Scan the 2D engineering barcode which contains your hospital's data format.

NOTE

- **Contact the scanner manufacturer or Mindray to obtain the barcodes for clearing data formats and containing the hospital's data format.**
-

3.5.4.2 Setting the Barcode Reader

For information on setting the barcode reader, see 23.15 *The Scanner Settings*.

3.6 Screen Display

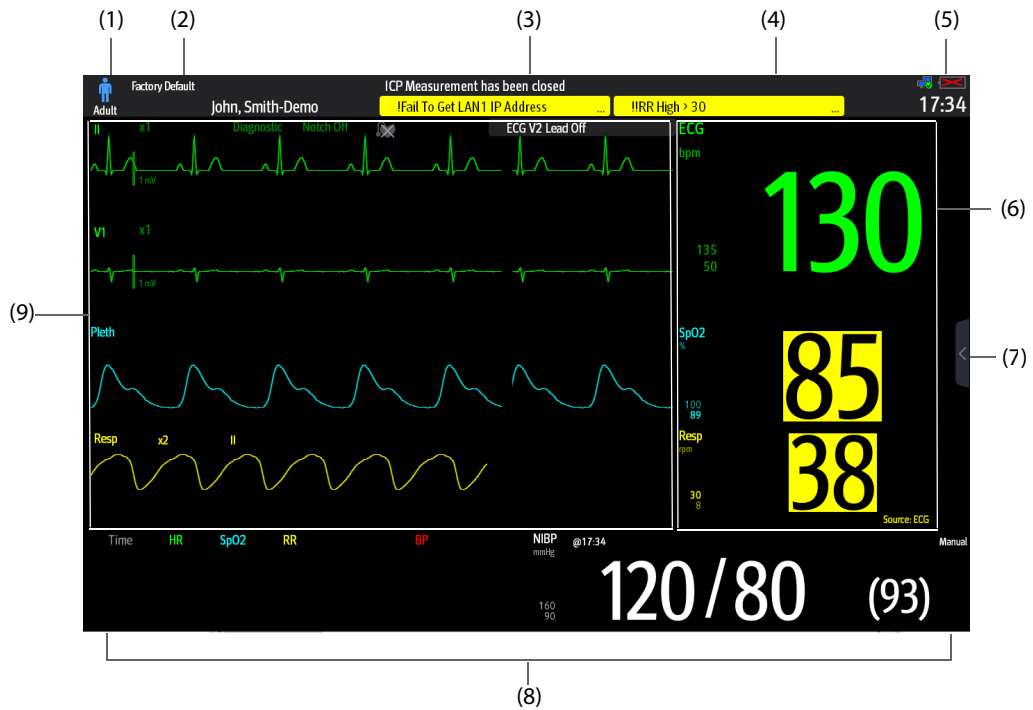

The following figure shows the normal screen:





















- (1) Patient information area: displays patient information, including patient category, gender, department, room number, bed number, and so on. The displayed patient information is configurable. Selecting this area enters the **Patient Management** menu. For more information, see 5.3 *Managing Patient Information*.
- (2) The current configuration
- (3) Technical alarm information area: displays prompt messages on the above; displays technical alarm messages at the bottom.
- (4) Physiological alarm information area: displays high priority physiological alarms on the above; displays medium and low priority physiological alarms at the bottom.
- (5) System status information area: displays alarm symbol, battery status, network status, currently connected CMS, storage device status, and system time. For more information, see 3.6.1 *On-screen Symbols*.
- (6) Parameter numerics area: displays parameter values, alarm limits, and alarm status. This area also displays parameter list. Selecting a parameter numeric block enters corresponding parameter menu. Selecting the parameter list enters tabular trend review. For more information, see 3.11.4 *Accessing Parameter Setup Menus*.
- (7) Selecting this button displays the configured quick keys.
- (8) Parameter waveform/numerics area: displays parameter waveforms, parameter values, alarm limits, and alarm status. This area also displays parameter list. Selecting a parameter numeric area or waveform area enters corresponding parameter menu. Selecting the parameter list enters tabular trend review. For more information, see 3.11.4 *Accessing Parameter Setup Menus*.
- (9) Parameter waveform area: displays parameter waveforms and parameter alarms. Select a waveform enters corresponding parameter menu. For more information, see 3.11.4 *Accessing Parameter Setup Menus*.

3.6.1 On-screen Symbols

The following table lists the on-screen symbols displayed on the system status information area:

Symbol	Description	Symbol	Description
	Adult, male		Adult, female

Symbol	Description	Symbol	Description
	Pediatric, male		Pediatric, female
	Neonate, male		Neonate, female
	All the alarms are paused.		Individual physiological alarms are turned off or the monitor is in the alarm off status.
	Audible alarm tones are paused.		Audible alarm tones are turned off
	The alarm system is reset.		The battery works correctly. The green portion represents the remaining charge.
	The battery has low power and needs to be charged.		The battery has critically low charge and needs to be charged immediately. Otherwise, the monitor will soon automatically shut down.
	The battery is being charged.		No battery is installed.
	Wired network is connected.		Wired network is not connected.
	Wireless network is connected. The solid part indicates network signal strength.		Wireless network is not connected.
	Wireless network is disabled.		

3.6.2 Menus

All menus have similar style and structure, see the figure below:

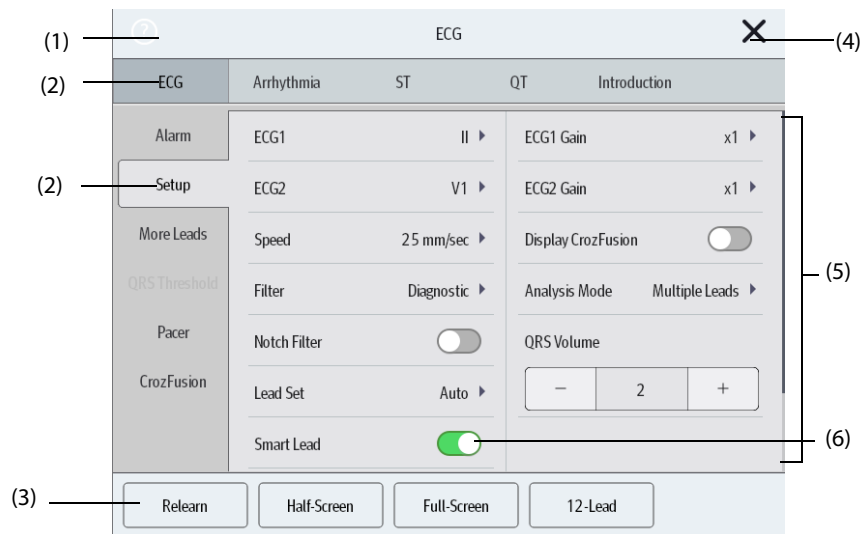

- (1) Menu heading
- (2) Submenu tabs
- (3) Operation buttons
- (4) Exit button: closes the current menu page.
- (5) Main body area: includes menu items and options.
- (6) Switch:
 - ◆ Green: the switch is on.
 - ◆ Gray: the switch is off.

3.6.3 Quick Keys



































The monitor provides quick keys for you to quickly access some functions. The quick keys displayed on the screen are configurable.







3.6.3.1 Displaying the Quick Keys

At the right side of the main screen, swipe to the left or tap the  symbol and the configured quick keys display.

3.6.3.2 Available Quick Keys

The following table shows available quick keys.

Symbol	Label	Function	Symbol	Label	Function
	Main Menu	Enters the main menu.		Standby	Enters the Standby mode.
	Alarm Setup	Enters the Alarm menu.		Alarm Reset	Resets the alarm system.
	End Case Report	Prints the selected end case reports.		Alarm Pause	Pauses the physiological alarms.
	Review	Enters the Review menu.		Call Help	Calls for help.
	Patient Management	Enters the Patient Management menu.		Screen Setup	Enters the Screen Setup menu.
	NIBP Start/ Stop	Starts an NIBP measurement or stops the current NIBP measurement.		NIBP Stop All	Stops all NIBP measurements.
	NIBP STAT	Starts a five-minutes continuous NIBP measurement.		NIBP Measure	Enters the NIBP Measure menu.
	Zero IBP(for uMEC 70/ uMEC 80/ uMEC 120/ uMEC 150)	Starts IBP zero calibration.		GCS	Enters the GCS menu.
	PAWP(for uMEC 70/ uMEC 80/ uMEC 120/ uMEC 150)	Enters the PAWP screen.		Venipuncture	Inflates the NIBP cuff to help venous puncture.
	C.O. Measure(for uMEC 70/ uMEC 80/ uMEC 120/ uMEC 150)	Opens the C.O. Measure window.		EWS	Enters the EWS screen.
	Parameters Setup	Enters the Parameters Setup menu.		Remote View	Opens the Remote View window.
	Manual Event	Manually triggers and saves an event.		Minitrends	Enters the Minitrends screen.
	OxyCRG	Enters the OxyCRG screen		ECG Full-Screen	Enters the ECG full screen.
	Privacy Mode	Enters the privacy mode.		Night Mode	Enters the night mode.
	CPB Mode	Enters the CPB mode.		Intubation Mode	Enters the intubation mode.
	Volume	Enters the Volume menu.		Freeze	Freezes waveforms.
	Calculations	Enters the Calculations menu.		Load Config	Enters the Load Config menu.

Symbol	Label	Function	Symbol	Label	Function
	Print	Starts printing a real-time report.		Record	Starts/Stops a recording.
	ECG 24h Sum	Views the 24-hour ECG summary.		ECG Lead/Gain	Enters the ECG Lead/Gain menu.
	Discharge Patient	Enters the Discharge Patient dialog box.		Discharged Patients	Enters the Discharged Patients dialog box.

3.6.3.3 Configuring the Displayed Quick Keys

To select the quick keys you want to display, follow this procedure:

1. Access **Quick Keys** in either of the following ways:
 - ◆ Select the **Screen Setup** quick key → the **Select Quick Keys** tab.
 - ◆ Select the **Main Menu** hard key or quick key → from the **Display** column select **Quick Keys**.
2. Select the **Current** tab to configure the quick keys you want to display on the screen: From the top of this page, select a block where you want to show a certain quick key, and then select the quick key from the quick key list. For example, if you want to show the **Screen Setup** quick key at the first block, select the first block, and then select **Screen Setup** from the list.

3.7 Operating Modes

The monitor provides different operating modes.

3.7.1 Monitoring Mode

The monitoring mode is the most frequently used clinical mode for patient monitoring. When the monitor is turned on, it automatically enters the monitoring mode.

3.7.2 Privacy Mode

The privacy mode is a special clinical monitoring mode. In the privacy mode, the monitor does not display patient information and monitoring data. This provides controlled access to patient data and ensures confidentiality.

The privacy mode is only available when the patient admitted by the monitor is also monitored by the CMS. The monitor continues monitoring the patient, but patient data is only visible at the CMS.

3.7.2.1 Entering the Privacy Mode

To enter the privacy mode, choose either of the following ways:

- Select the **Privacy Mode** quick key → select **OK**.
- Select the **Main Menu** hard key or quick key → from the **Display** column select **Privacy Mode** → select **OK**.

The monitor has the following features after entering the privacy mode:

- The screen turns blank.
- Except for the low battery alarm, the monitor inactivate alarm tone and alarm light of all other alarms.
- The monitor suppresses all system sounds, including heart beat tone, pulse tone, and prompt tone.

WARNING

- **In Privacy mode, all audible alarms are suppressed and the alarm light is deactivated at the monitor. Alarms are presented only at the CMS. Pay attention to potential risk.**
-

NOTE

- **You cannot enter the privacy mode if a low battery alarm occurs.**
-

3.7.2.2 Exiting the Privacy Mode

The monitor automatically exit the privacy mode in any of the following situations:

- The monitor disconnects from the CMS.
- The low battery alarm occurs.

You can also operate the touchscreen to manually exit the privacy mode.

3.7.3 Night Mode

The night mode is a special clinical monitoring mode. To avoid disturbing the patient, you can use the night mode.

You can switch on or off the night mode. This is password protected. For more information, see **Disable Night Mode** in 23.4.6 *The Other Tab*.

3.7.3.1 Entering the Night Mode

To enter the night mode, follow this procedure:

Select the **Night Mode** quick key to enter the night mode. You can also follow this procedure to enter the night mode:

1. Access night mode setup in either of the following ways:
 - ◆ Select the **Main Menu** hard key or quick key → from the **Display** column select **Night Mode**.
 - ◆ Select the **Alarm Setup** quick key → select the **Night Mode** tab.
2. Change the night mode settings if necessary.
3. Select **Enter Night Mode**.

CAUTION

- **Verify the night mode settings before entering the night mode. Pay attention to the potential risk if the setting value is low.**
-

3.7.3.2 Setting the Auto Night Mode Switch

You can configure the monitor to automatically enter and exit the night mode. To do so, follow this procedure:

1. Access night mode setup in either of the following ways:
 - ◆ Select the **Main Menu** hard key or quick key → from the **Display** column select **Night Mode**.
 - ◆ Select the **Alarm Setup** quick key → select the **Night Mode** tab.
2. Switch on or off **Auto Night Mode**.
 - ◆ **On:** the monitor automatically enters the night mode when the night mode period starts and exits the night mode when the night mode period ends. See the **Nighttime** setting from 23.10.1 *The Time Synchronization Tab*.
 - ◆ **Off:** the monitor will not automatically enters the night mode. To manually enter the night mode, see **Nighttime** from 3.7.3.1 *Entering the Night Mode*.

The **Auto Night Mode** switch is **Off** by default.

3.7.3.3 Changing Night Mode Settings

To change night mode settings, follow this procedure:

1. Access night mode setup in either of the following ways:
 - ◆ Select the **Main Menu** hard key or quick key → from the **Display** column select **Night Mode**.

- ◆ Select the **Alarm Setup** quick key → select the **Night Mode** tab.
2. Change the following night mode settings as necessary.
 - ◆ Screen brightness
 - ◆ Alarm volume, QRS volume, key-striking volume, and reminder volume
 - ◆ NIBP End Tone switch and Stop NIBP switch

3.7.3.4 Muting All Monitor Sounds

To silence the monitor in the Night mode, switch on **All Mute** from the **Night Mode Setup** menu.

Local password for accessing the **Maintenance** menu is required for switching on **All Mute**.

After the monitor is silenced, the monitor will not generate the alarm tone, QRS tone, key tone, reminder tone, or NIBP end tone.

3.7.3.5 Exiting the Night Mode

To cancel the night mode, follow this procedure:

1. Select the **Night Mode** quick key, or select the **Main Menu** hard key or quick key → from the **Display** column select **Exit Night Mode**.
2. Select **OK**.

NOTE

- **If your monitor is connected to the CMS, it automatically exits the night mode when being disconnected from the CMS.**
 - **The monitor resumes the previous settings after exiting the night mode.**
-

3.7.4 Standby Mode

You can temporarily stop patient monitoring without switching off the monitor by entering the standby mode.

3.7.4.1 Entering the Standby Mode

1. Select the **Standby** quick key, or select the **Main Menu** hard key or quick key → from the **Patient Management** column select **Standby**.
2. Define where the patient is by selecting a location in the drop down list when the monitor enters the standby mode.
3. Select **OK**.

The monitor behaves as follows after entering the standby mode:

- Stops all parameter measurements.
- Disables all the alarms and prompt messages, except for the battery low alarm.
- Turns screen brightness to the dimmest after entering the standby mode for 30 seconds.

WARNING

- **Pay attention to the potential risk of placing the monitor to standby. In the standby mode, the monitor stops all parameter measurements and disable all the alarm indications, except for the battery low alarm.**
-

3.7.4.2 Changing the Patient Location at Standby

If you need to change the patient's location, select patient location from the Standby screen.

3.7.4.3 Exiting the Standby Mode

To exit the standby mode, choose any of the following ways:

- Select **Resume monitor** to exit the standby mode and resume monitoring the current patient.
- Select **Discharge Patient** to discharge the current patient.

If the monitor automatically enters the standby mode after a patient is discharged, choose any of the following ways to exit the standby mode:

- Select **Monitor** to exit the standby mode and admit a new patient.
- Select **Patient Management** to enter the patient information for preparing to admit a new patient.

When the monitor exits the standby mode and resumes monitoring, the alarms are paused for two minutes. Then the alarm system is activated.

3.8 Configuring Your Monitor

Configure your monitor before putting it in use.

3.8.1 Setting the Date and Time

To set the system time, follow this procedure:

1. Select the **Main Menu** hard key or quick key → from the **System** column select **Time**.
2. Set **Date** and **Time**.
3. Set **Date Format**.
4. If you want to use the 12-hour mode, switch off **24-Hour Time**.
5. If you want to use daylight savings time, switch on **Daylight Savings Time**. You can manually switch on or off **Daylight Savings Time** when **Auto Daylight Savings Time** is switched off. For more information, see *23.11 The Other Settings*.

If your monitor is connected to a central monitoring system (CMS) or hospital clinical system (HIS), the date and time are automatically taken from the CMS. In this case, you cannot change the date and time from your monitor.

CAUTION

- **Changing the date and time affects the storage of trends and events and may result in loss of data.**
-

3.8.2 Adjusting the Screen Brightness

You can swipe up and down with one finger on the left part of the main screen to quickly adjust the screen brightness.

Or you can set specific screen brightness by following the procedure below:

1. Access **Display** in either of the following ways:
 - ◆ Select the **Screen Setup** quick key → select the **Display** tab.
 - ◆ Select the **Main Menu** hard key or quick key → from the **Display** column select **Display**.
2. If you are using the external power source, set **Brightness**. If you are using the battery to run the monitor, set **Brightness On Battery**.

3.8.3 Adjusting the Volume

Select the **Volume** quick key to set **Alarm Volume**, **QRS Volume**, and **Key Volume**.

3.8.4 Accessing the On-screen Guide

The monitor provides the on-screen guide to help you understand parameter monitoring functions. On-screen guide provides measurement principle, points to note, accessory connection, operating procedure, and so on.

To access the on-screen guide, follow this procedure:

1. Select the desired numerics area or waveform area to enter the parameter menu.

2. Select the **Introduction** tab.
3. Select a tab as required.

NOTE

- **The on-screen guide is not available for Respiration, temperature, and C.O. monitoring.**
-

3.9 Starting Monitoring a Patient

After turning on your monitor, follow this procedure to monitor a patient:

1. Admit the patient.
2. Check patient settings. Make sure that alarm limits, patient category and paced status, and so on, are appropriate for your patient. Change them if necessary.
3. Perform desired measurements. For more information, see corresponding measurement chapters.

3.10 Stopping a Parameter Measurement

To stop monitoring a parameter, follow this procedure:

1. Remove the corresponding sensor from the patient.
2. Disconnect the sensor from the patient cable.
3. Disconnect the patient cable from the parameter module.
4. If you are using the disposable sensor, discard it.

3.11 General Operation

This section describes the operations that are generally used when monitoring a patient.

3.11.1 Switching On or Off a Parameter

You can also manually switch on or off a parameter when its module is connected. If setting parameter switches is not password protected, follow this procedure to set parameter switches:

1. Access **Parameters On/Off** by any of the following ways:
 - ◆ Select the **Screen Setup** quick key → select the **Parameters On/Off** tab.
 - ◆ Select the **Main Menu** hard key or quick key → from the **Parameters** column select **Parameters On/Off**.
2. Switch on or off the desired parameters.

If setting parameter switches is password protected, to set parameter switches, switch on **Parameters On/Off Protected**. For more information, see 23.11 *The Other Settings*.

When a parameter is switched off, the monitor stops data acquisition and alarming for this measurement.

NOTE

- **When a parameter is manually switched off, you cannot monitor this parameter even if the corresponding parameter module is plugged in and related accessories are connected.**
-

3.11.2 Displaying Parameter Numerics and Waveforms

You can configure the parameter numerics, waveforms, and their sequence displayed on the normal screen. To do so, follow this procedure:

1. Access **Tile Layout** in either of the following ways:
 - ◆ Select the **Screen Setup** quick key → select the **Tile Layout** tab.
 - ◆ Select the **Main Menu** hard key or quick key → from the **Display** column select **Tile Layout**.

2. Select a parameter numeric area or waveform area, and then from the popup list select an element you want to display in this area. The parameters and waveforms you did not select will not be displayed.

3.11.3 Displaying the Parameter List

You can display trends of HR, SpO₂, RR, and NIBP/IBP in the parameter numerics area. To do so, follow this procedure:

1. Access **Tile Layout** in either of the following ways:
 - ◆ Select the **Screen Setup** quick key → select the **Tile Layout** tab.
 - ◆ Select the **Main Menu** hard key or quick key → from the **Display** column select **Tile Layout**.
2. Select the parameter numerics area where you want to display the parameter list, and then from the popup list select **Parameter List**.

3.11.4 Accessing Parameter Setup Menus

Each parameter has a setup menu in which you can adjust the alarm and parameter settings. You can enter a parameter setup menu by using any of the following ways:

- Select the parameter numeric area or waveform area.
- Select the **Parameters Setup** quick key, and then select the desired parameter.
- Select the **Main Menu** hard key or quick key → from the **Parameters** column select **Setup** → select the desired parameter.

NOTE

- In this manual, we always use the first method to enter the setup menu. But you can use any method you prefer.

3.11.5 Changing Measurement Colors

You can set the color of measurement values and waveforms for each parameter. To do so, follow this procedure:

1. Select **Main Menu** hard key or quick key → from the **Parameters** column select **Parameter Color**.
2. Select the **Current** tab and set the colors of the currently monitoring measurement values and waveforms.
3. Select the **All** tab and set the colors of measurement values and waveforms for all parameters.

3.12 Initiating a Manual Event

To save a manual event, follow this procedure:

1. Select the **Manual Event** quick key to enter the **Manual Event** menu.
2. Select a name for this event, for example **Intubated**, or input a name.
3. Select **OK**.

To edit the name of preset event names, select  to enter the **Manual Event Setup** menu.

The selecting or editing manual event name functionality is available only if the **Manual Event Edit** switch is turned on. For more information, see [23.11 The Other Settings](#).

You can review the manual events. For more information, see [18.2.7 Reviewing Events](#).

3.13 Using the On-Screen Timers

The monitor has a Timer function to notify you when a preset time period is expired. You can simultaneously display up to four timers.

3.13.1 Displaying Timers

To display a timer, follow this procedure:

1. Access **Tile Layout** in either of the following ways:

- ◆ Select the **Screen Setup** quick key → select the **Tile Layout** tab.
 - ◆ Select the **Main Menu** hard key or quick key → from the **Display** column select **Tile Layout**.
2. Click the parameter area where you want to display the timer, and then select a timer from the popup list.

3.13.2 Controlling the Timer

The timer provides the following controls:

- **Start:** starts the timer.
- **Pause:** pauses the timer.
- **Resume:** resumes the timer.
- **Reset:** clears the timer and end this timer episode.

WARNING

- **Do not use the timers for tasks related to critical patients.**
-
-

3.13.3 Setting the Timer

You can set each timer independently. To set the timer, follow this procedure:

1. Select the timer area to enter the **Timer Setup** menu.
2. Set **Timer Type**:
 - ◆ **Normal:** The timer has a single and defined run time, and stops when the run time is reached.
 - ◆ **Advanced:** The timer has a single and defined run time. When the run time is reached, the timer continuously displays the time beyond the end of run time.
 - ◆ **Cycled:** The timer has a single and defined run time. When the run time is reached, the timer restarts automatically. The cycles is also displayed.
 - ◆ **Unlimited:** The timer displays the time elapsed since the timer was started.
 - ◆ **Clock:** The timer displays the system time.
3. Set **Direction**.
 - ◆ **Down:** the timer counts down.
 - ◆ **Up:** the timer counts up.
4. Set **Run Time**.
5. Set **Reminder Volume**. A progress bar is shown with the run time. When the remaining time is 10 seconds, the monitor issues a reminder tone and the timer flashes in red, prompting you that the run time is to expire.

NOTE

- **You cannot change timer settings when a timer is running.**
 - **You can set Direction, Run Time, and Reminder Volume only for normal, advanced, and cycled timers.**
-

3.14 Freezing Waveforms

During patient monitoring, the freeze feature allows you to freeze the currently displayed waveforms on the screen so that you can have a close examination of the patient's status. Besides, you can select any frozen waveform for recording.

3.14.1 Freezing Waveforms

To freeze waveforms, select the **Freeze** quick key. Except waveforms of the following screens, all displayed waveforms stop refreshing and scrolling after you select the **Freeze** quick key:

- Minitrends screen

- OxyCRG screen
- Remote View screen
- EWS screen

3.14.2 Viewing Frozen Waveforms

To view the frozen waveforms, follow this procedure:

- Select the  or  button in the **Freeze** window.
- Slide the frozen waveform leftward or rightward.

At the lower right corner of the bottommost waveform displays the freeze time. The initial frozen time is 0 s. With the waveforms scrolling, the freeze time changes at an interval of 1 second. For example, -2 s means the two seconds before the frozen time. This change will be applied for all waveforms on the screen.

NOTE

- You can view the frozen waveforms of up to 120 seconds.

3.14.3 Unfreezing Waveforms

To unfreeze the frozen waveforms, select  of the **Freeze** window.

3.14.4 Printing Frozen Waveforms

To print the frozen waveforms, select  of the **Freeze** window.

3.15 Entering Training Mode

Training mode provides basic instructions about how to use this monitor. Users can enter training mode before actually using this device.

To enter training mode, follow this procedure:

1. Select the **Main Menu** hard key or quick key → from **System** column select **Training Mode**.
2. Select **OK** in the pop-up window and the system enters the Training Mode menu, automatically demonstrating learning content.
3. In the Training Mode menu, select **Next** to go to next learning content; select **Learn Later** to exit self-learning and return to patient monitoring; select **Previous** to go back to the previous learning content.
4. In **Connect Accessories** and **Monitoring Setup** steps, you need to swipe up and down on the screen to view complete learning content.
5. When “Congratulation! You have acquired basic skill in operating this equipment” appears. select **Next** to return to patient monitoring.

If you need more videos about how to operate this equipment, scan the QR code on the side of the monitor.

3.16 Checking Software Licenses

To run the following functions in your monitor, software licenses are required:

- Early Warning Score (EWS)
- ECG 24h Summary

To check the licenses, select the **Main Menu** hard key or quick key → select **License** → **Local**.

To install the licenses, follow this procedure:

1. Connect the USB drive with the licenses in to the monitor’s USB connector.
2. Select the **Main Menu** hard key or quick key →select **License** → select **External**.
3. Select **Install**.

3.17 Turning Off the Monitor

Before turn off the monitor, perform the following check:

1. Ensure that the monitoring of the patient has been completed.
2. Disconnect the cables and sensors from the patient.
3. Make sure to save or clear the patient monitoring data as required.

To turn off the monitor, press and hold the power switch for 3 seconds.

Turning off the monitor does not disconnect the monitor from the AC mains. To completely disconnect the power supply, unplug the power cord.

CAUTION

- **Press and hold the power switch for 10 seconds to forcibly shut down the monitor if it could not be shut down normally. This may cause loss of patient data.**

NOTE

- **In case of a temporary power failure, if the power is restored within 30 minutes, monitoring will resume with all active settings unchanged; if the monitor is without power for more than 30 minutes, the monitor behaves the same as it is normally turned off.**
-

This page intentionally left blank.

4 User Screens

The monitor provides different user screens to facilitate patient monitoring in different departments and clinical applications.

4.1 Choosing a Screen

To choose a screen, follow this procedure:

1. Access the **Choose Screen** page in either of the following ways:
 - ◆ Select the **Screen Setup** quick key.
 - ◆ Select the **Main Menu** hard key or quick key → from the **Display** column select **Choose Screen**.
2. Select the desired screen.

4.2 Switching a Screen

You can also quickly switch among the following screens by swiping across the screen with two fingers.

- For adult and pediatric patients: the normal screen, the big numeric screen, the minitrends screen.
- For neonatal patients: the normal screen, the big numeric screen, the minitrends screen, and the OxyCRG screen.

To set what screens to switch among, follow this procedure:

1. Access the **Switch Screen** page in either of the following ways:
 - ◆ Select the **Screen Setup** quick key → select **Switch Screen**.
 - ◆ Select the **Main Menu** hard key or quick key → from the **Display** column select **Choose Screen** → select **Switch Screen**.
2. Select desired screens. When you swipe left or right across the touchscreen with two fingers, the system will switch to the selected screens in the order of **Screen 1, Screen 2, Screen 3, Screen 4**.

4.3 Normal Screen

The normal screen is most frequently used for patient monitoring.

4.3.1 Entering the Normal Screen

To enter the normal screen, choose any of the following ways:

- Swipe left or right across the touchscreen with two fingers until you switch to the normal screen.
- Select the **Screen Setup** quick key → select the **Choose Screen** tab → select **Normal Screen**.
- Select the **Main Menu** hard key or quick key → from the **Display** column select **Choose Screen** → select **Normal Screen**.

4.3.2 Configuring the Normal Screen

You can configure the parameter numerics, waveforms, and their sequence displayed on the normal screen. To do so, follow this procedure:

1. Access **Tile Layout** in either of the following ways:
 - ◆ Select the **Screen Setup** quick key.
 - ◆ Select the **Main Menu** hard key or quick key → from the **Display** column select **Tile Layout**.
2. Select a parameter numeric area or waveform area, and then from the popup list select an element you want to display in this area. The parameters and waveforms you did not select will not displayed.

4.4 The Big Numerics Screen

The big numerics screen displays parameter numerics in big font size.

4.4.1 Entering the Big Numerics Screen

To enter the big numerics screen, choose any of the following ways:

- Swipe left or right across the touchscreen with two fingers until you switch to the big numerics screen.
- Select the **Screen Setup** quick key → select the **Choose Screen** tab → select **Big Numerics**.
- Select the **Main Menu** hard key or quick key → from the **Display** column select **Choose Screen** → select **Big Numerics**.

4.4.2 Configuring the Big Numerics Screen

To configure the big numerics screen, follow this procedure:

1. Access **Choose Screen** in either of the following ways:
 - ◆ Select the **Screen Setup** quick key.
 - ◆ Select the **Main Menu** hard key or quick key → from the **Display** column select **Choose Screen**.
2. Select the **Big Numerics** tab
3. Select a parameter numeric area or waveform area, and then from the popup list select an element to display in this area.

4.5 Minitrends Screen

The Minitrends screen shows the recent graphic trends of parameters.

4.5.1 Entering the Minitrends Screen

To enter the Minitrends screen, choose any of the following ways:

- Swipe left or right across the touchscreen with two fingers until you switch to the Minitrends screen.
- Select the **Minitrends** quick key.
- Select the **Screen Setup** quick key → Select the **Choose Screen** tab → select **Minitrends**.
- Select the **Main Menu** hard key or quick key → from the **Display** column select **Choose Screen** → select **Minitrends**.

4.5.2 The Display of Minitrends Screen

The following figure shows the Minitrends screen.

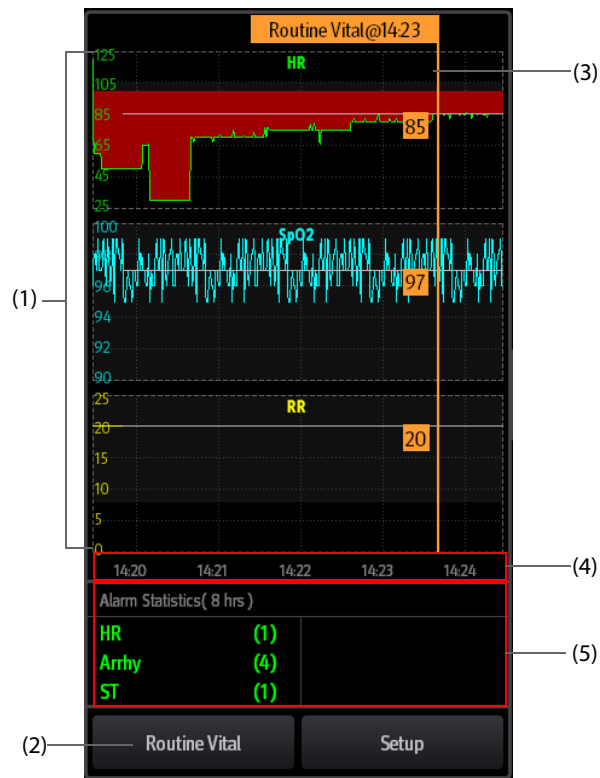

- (1) Scale
- (2) **Routine Vital** button.
- (3) Routine Vital
- (4) Time line
- (5) Alarm statistic area

4.5.3 Setting Minitrends Parameters

To set parameters, follow this procedure:

1. Enter the Minitrends screen.
2. Select the **Setup** button.
3. Set parameters. If you want to use the default parameters, select **Default Parameter**.

4.5.4 Setting the Minitrend Length

To set the Minitrend length, follow this procedure:

1. Enter the Minitrends screen.
2. Select the **Setup** button.
3. Set the **Minitrend Length**.

4.5.5 Setting the Alarm Statistics Switch

The Minitrends screen can be configured to display the statistic number of physiological alarms in its lower half screen. To set the alarm statistics switch, follow this procedure:

1. Enter the Minitrends screen.
2. Select the **Setup** button.

3. Switch on or off the **Alarm Statistics** switch.

4.5.6 Setting the Alarm Statistics Duration

The time length within which the alarms statistics are made is configurable. To set the alarm statistics length, follow this procedure:

1. Enter the Minitrends screen.
2. Select the **Setup** button.
3. Set **Alarm Statistics Duration**.

4.5.7 Routine Vital/Baseline

The Routine vital/Baseline function is used for marking the parameter measurements of certain moment for later reference.

4.5.7.1 Manually Marking the Routine Vital/Baseline

To manually mark the Routine Vital/Baseline, follow this procedure:

1. Enter the Minitrends screen.
2. Select the **Routine Vital** button or **Baseline** button.

NOTE

- **If you do not see the Baseline button or Routine Vital button in the Minitrends screen, you can select the Setup button and switch on the Baseline switch, or set Routine Vital to Manual or Auto.**
-

4.5.7.2 Configuring Automatic Routine Vital Settings

The monitor can automatically mark the routine vital sign values. To enable this function, follow this procedure:

1. Enter the Minitrends screen.
2. Select the **Setup** button.
3. Select **Auto** from the dropdown list of **Routine Vital**.
4. Select **Time** to set the time for marking the first routine vital sign values.
5. Select **Interval** to set the interval for marking the routine vital sign values.

4.6 The OxyCRG Screen

The monitor displays the OxyCRG screen by default when the neonatology department is selected. The OxyCRG screen is available in any department setting, but only when **Patient Category** is set to **Neo**. This screen displays 6-minute HR/btbHR, SpO₂ trends, CO₂/Resp compressed waveform, ABD parameters, and the latest ABD events.

The OxyCRG function is intended for neonatal patients only.

4.6.1 Entering the OxyCRG Screen

To enter the OxyCRG screen, choose any of the following ways:

- Swipe left or right on the touchscreen with two fingers until you switch to the OxyCRG screen.
- Select the **OxyCRG** quick key.
- Select the **Screen Setup** quick key → select the **Choose Screen** tab → select **OxyCRG**.
- Select the **Main Menu** hard key or quick key → from the **Display** column select **Choose Screen** → select **OxyCRG**.

4.6.2 OxyCRG Events

The following table lists the ABD events and their criteria:

Event type	Description	Remarks
A	Apnea event: the apnea duration exceeds the threshold. <ul style="list-style-type: none"> A20: the apnea duration is greater or equal to 20 seconds. A15: the apnea duration is between 15 to 20 seconds (excluding 20 seconds). A10: the apnea duration is between 10 to 15 seconds (excluding 15 seconds). 	A20 is a red event
B	Bradycardia event: the duration of low heart rate, bradycardia, extreme bradycardia, or asystole exceeds the threshold.	/
D	Low SpO ₂ event: the duration of SpO ₂ Desat exceeds the threshold.	/
BD	Bradycardia and low SpO ₂ happen at the same time.	/
AB	Apnea and bradycardia happens at the same time.	Red event
AD	Apnea and low SpO ₂ happen at the same time.	Red event
ABD	Apnea, bradycardia, and low SpO ₂ happen at the same time.	Red event

NOTE

- **The monitor records all ABD events for OxyCRG review, but only red events displays in the ABD list of the OxyCRG screen.**

4.6.3 The Display of the ABD Event Area

The ABD event area displays parameter values of currently active OxyCRG events and lists the latest red ABD events.

4.6.4 Setting OxyCRG Parameters

Select parameter trends or compressed waveform to set parameters and the compressed waveform you want to display. The selected parameters will be used for ABD event calculation.

4.6.5 Setting the Threshold of ABD Events

Select any parameter trend or the compressed waveform to perform the following setup:

- Set the threshold of ABD events.
- Set **Event Storage Format**:
 - ◆ **1 min+3 min**: stores data one minute before and three minutes after the event.
 - ◆ **3 min+1 min**: stores data three minutes before and one minute after the event.
 - ◆ **2 min+2 min**: stores data two minutes before and two minutes after the event.

The stored data includes the trends of the OxyCRG parameters, compressed waveform, alarm thresholds, NIBP, and Temp measurements.

4.6.6 Editing ABD Events

To edit ABD events, follow this procedure:

1. Select the **Mark** button to enter the **Mark** dialog box.
2. Drag the event list upwards and downwards to select the desired event.
3. Select the patient's status when the event happens.
4. Select **Save**.

4.7 Remote View Screen

On your monitor, you can observe alarm conditions and view real time physiological data from patients on other networked monitoring devices.

A device from a remote site is called a remote device or bed, for example, a bedside monitor. You can simultaneously watch up to 12 remote devices. You can also view the realtime screen of one remote device (the main bed) on your monitor.

You can watch the remote devices on the **Remote View** screen or the alarm watch tiles on the main screen.

From the **Remote View** screen you can watch the following information:

- The alarm status and alarm messages of up to 12 remote devices.
- The realtime parameter values and waveforms from the main bed.

NOTE

- **You can also view this monitor from remote devices. This monitor can be viewed by at most 32 remote devices at the same time, in which eight remote devices can watch this monitor's waveforms.**

4.7.1 Entering the Remote View Screen

To enter the **Remote View** screen, choose one of the following ways:

- Swipe left or right across the touchscreen with two fingers until you switch to the Remote View screen.
- Select the **Remote View** quick key.
- Select the bed at the alarm watch tile on the main screen. For more information, see 4.7.7.2 *Displaying the Alarm Watch Tile on the Main Screen* for configuring to display the tile on the main screen.
- Select the **Screen Setup** quick key → select the **Choose Screen** tab → select **Remote View**.

The **Remote View** screen displays parameter measurements and waveforms of the remote device.

The following figure shows the **Remote View** screen.

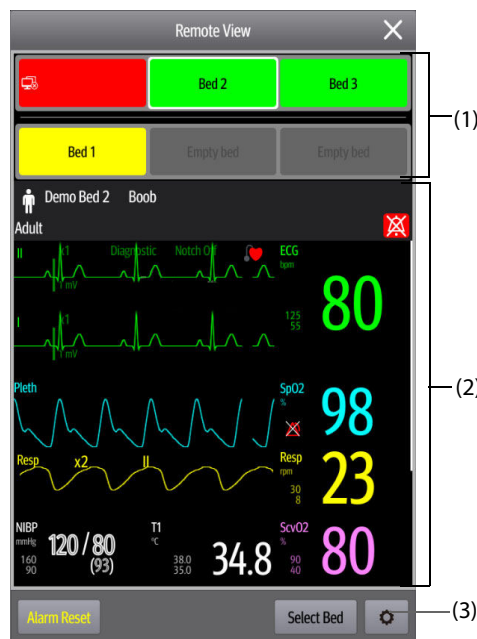

(1) Alarm watch area

- ◆ Displays the room number and bed number of the remote bed if only one remote device is watched.
- ◆ Each bed cyclically displays room number, bed number, and alarm of the highest priority if multiple remote beds are watched.
- ◆ The background color of each bed indicates the status of this bed as follows:

Background Color	Description
Green	No alarm is occurring to the bed.

Background Color	Description
Red	The remote device is disconnected or a high priority alarm is occurring. The high priority alarm currently is the highest alarm level on the bed. If the remote device is disconnected,  is displayed.
Yellow	The medium priority or the low priority alarm is occurring. The medium priority or the low priority alarm currently is the highest alarm level on the bed.
Grey	The remote device is in the standby mode.
Black	The remote device is powered off.

- (2) Main area: displays the realtime parameters and waveforms from the main bed. Scrolling up and down can view more parameters and waveforms.
- (3) Remote view setup button: select it to enter the **Remote View** setup menu.

4.7.2 Adding a Bed

You need to add the desired remote devices, and then the alarms from these devices can be watched on your monitor. To add a remote device, follow this procedure:

1. Enter the **Select Bed** menu. To do so, choose either of the following ways:
 - ◆ On the **Remote View** screen, select **Select Bed**. For more information, see 4.7.1 *Entering the Remote View Screen* for entering the **Remote View** screen.
 - ◆ Select the  icon at the alarm watch tile if the tile is configured to display on the main screen.
2. In the **Select Bed** menu, select a desired department. All the beds under this department will be listed. To select beds in the same care group during the shift of care groups in the CMS, select **Select Beds By Care Group**.
3. Select a desired tile at the A-W1 or A-W2 areas and then select a bed from the bed list. The selected bed will appear in the alarm watch area and the alarm watch tile if configured.

NOTE

- The added bed is indicated by a check mark (✓) at the left of the bed list.

4.7.3 Removing a Bed

If you do not want to monitor a remote device any longer, you can remove it. To remove a remote device, follow this procedure:

1. Enter the **Select Bed** menu. Choose either of the following ways:
 - ◆ In the **Remote View** screen, select **Select Bed**. For more information, see 4.7.1 *Entering the Remote View Screen* for entering the **Remote View** screen.
 - ◆ Select the  icon in the alarm watch tile if the tile is configured to display on the main screen.
2. In the **Select Bed** menu, select a bed at the A-W1 or A-W2 area, and then select **Clear Bed**. If you want remove all beds, select **Clear All Beds**.

4.7.4 Displaying the Main Bed

To watch the real time monitoring screen of a remote bed, select the bed from the alarm watch area. This bed is called the main bed.

4.7.5 Saving a Manual Event

You can initiate a manual event by selecting **Manual Event** in the **Remote View** screen.

The manual event stores in the event review of the corresponding remote device.

4.7.6 Resetting Alarms for Remote Devices

To reset remote device alarms, from the **Remote View** screen, select **Alarm Reset**.

NOTE

- You can reset remote device alarms only if the Alarm Reset by Other Bed switch is on at the remote devices. For more information, see 23.4.6 The Other Tab.

4.7.7 Alarm Watch

The alarm watch function provides the alarm notification by color and sound.

- The monitor sounds the highest priority alarm tone from all the monitored remote devices.
- The monitor displays the highest priority alarm in corresponding background color for each bed in the following areas:
 - ◆ At the top of the **Remote View** screen. For more information, see 4.7.1 Entering the Remote View Screen.
 - ◆ In the Alarm Watch tile on the main screen. For more information, see 4.7.7.1 About Alarm Watch Tile.

4.7.7.1 About Alarm Watch Tile

The main screen can display up to two alarm watch tiles, namely A-W1 and A-W2. Each tile can accommodate up to six beds.

The following figure shows the alarm watch tiles.

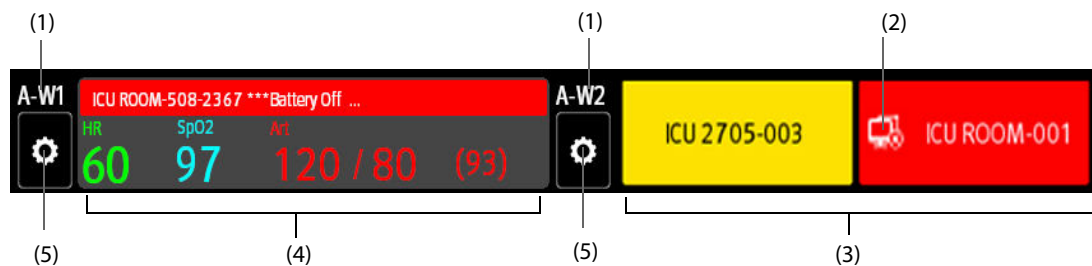

- (1) Alarm watch tile label
- (2) Disconnection icon: this icon displays when the remote device is disconnected and the background color of this tile turns red.
- (3) Bed area (multiple beds): if more than one bed is assigned to an alarm watch tile, each bed cyclically displays the bed number, room number, and the alarm of the highest priority. The background color of each bed indicated the status of that bed.
- (4) Bed area (one bed): if only one bed is assigned to an alarm watch area, this area displays the bed number, room number, parameter value, and alarm message from this bed, etc.
- (5) Bed selection button: select it to enter the **Select Bed** menu.

The alarm watch tile on the main screen is similar to the alarm watch area on the **Remote View** screen. For more information, see 4.7.1 Entering the Remote View Screen.

4.7.7.2 Displaying the Alarm Watch Tile on the Main Screen

To configure the alarm watch tile to be displayed on the monitor's main screen, follow this procedure:

1. Select the **Main Menu** hard key or quick key → from the **Display** column select **Choose Screen** to enter the **Screen Setup** menu.
2. Select the **Tile Layout** tab.
3. Select the numeric area where you want to display the alarm watch tile, and then in the drop-down list, select **Alarm Watch** → **A-W1** or **A-W2**.

4.7.8 Auto Displaying the New Alarm Bed

The monitor provides the function of automatically displaying the remote alarm bed. If this function is enabled, when a remote bed issues an alarm, the monitor automatically displays this bed as the main bed on the **Remote View** screen.

If multiple remote beds issue alarms, the monitor cyclically displays the alarm beds as per the preset interval and in the order of alarm time.

The auto displaying alarm bed function is disabled by default. To enable this function, follow this procedure:

1. From the **Remote View** screen, select  to enter the **Remote View** setup menu.
2. Switch on **Rollup Alarm Beds**.
3. Set **Rollup Interval**:
 - ◆ **Off**: do not cyclically display the remote alarm beds. Once a new alarm is issued, the monitor automatically switches to the new alarm bed.
 - ◆ **10 sec, 20 sec, or 30 sec**: If multiple remote beds issue alarms, the monitor cyclically displays the alarm beds as per the preset interval and alarm priority in the order of alarm time.
4. Set **Alarm Priority**:
 - ◆ **High Only**: Only when a high priority alarm is issued, the monitor automatically switches to the alarm bed.
 - ◆ **High & Med**: If **Rollup Interval** is set to **Off** and when a high priority alarm or medium priority alarm is issued, the monitor automatically switches to the alarm bed. If **Rollup Interval** is set to **10 sec, 20 sec, or 30 sec** and multiple remote beds issue alarms, the monitor cyclically displays the alarm beds with higher priority in the order of alarm time. For example, if both high priority alarms and medium priority alarms are issued, only beds with high priority alarms are cyclically displayed.
5. Set **Switch Bed Prompt Voice**. If this function is enabled, the monitor issues a reminding sound each time the main bed switches.

This page intentionally left blank.

5 Managing Patients

5.1 Discharging a Patient

Before monitoring a new patient, discharge the previous patient. After the patient is discharged, the technical alarms is reset, and monitor settings return to their defaults. For more information, see [6.3 Setting Default Configuration](#).

After a patient is discharged, the monitor automatically admits a new patient.

WARNING

- **Discharge the previous patient before starting monitoring a new patient. Otherwise there may be risk of mixing patient data.**
-

5.1.1 Auto Discharging a Patient after Monitor Power Off

You can let the monitor automatically discharge after the monitor has been switched off for a period of time. The configuration of this function is password protected. For more information, see [23.3.3 The Discharge Tab](#).

5.1.2 Manually Discharging a Patient

To manually discharge a patient, choose any of the following ways:

- Swipe down the touchscreen with two fingers.
- Select the **Discharge Patient** quick key.
- Select the patient information area at the top left corner of the screen → **Discharge Patient**.
- Select the **Patient Management** quick key → **Discharge Patient**.
- Select the **Main Menu** hard key or quick key → from the **Patient Management** column select **Discharge**.

Select the desired item from the popup box:

- **Print End Case Report:** prints the end case report when the patient is discharged.
- **Discharge:** clears the waveform data of the current patient. The monitor loads the default configuration and goes to the standby mode. The current patient becomes a discharged patient.
- **Clear Patient Data:** discharges the current patient and clears the waveform data. The monitor loads the default configuration and does not go to the standby mode. The current patient becomes a discharged patient.

5.2 Admitting a Patient

The monitor admits a new patient in the following situations:

- After a patient is manually discharged, the monitor automatically admits a new patient.
- After being switched off for the selected time period, the monitor automatically discharges the previous patient and admits a new patient at startup.
- If the monitor has not detected certain patient vital signs (ECG, SpO2, PR, RR, NIBP) for 30 minutes, you will be prompted whether to start monitoring a new patient if any of the above vital signs are detected again.

Always inputs patient information as soon as the patient is admitted. For more information, see [5.3.2 Editing Patient Information](#).

WARNING

- The settings of patient category and paced status always contain a default value, regardless of whether the patient is admitted or not. Check if the setting is correct for your patient.
 - For paced patients, set Paced to Yes. Otherwise the monitor could mistake a pace pulse for a QRS complex and fail to generate alarms when the ECG signal is too weak.
 - For non-paced patients, you must set Paced to No.
-
-

5.3 Managing Patient Information

5.3.1 Entering the Patient Management Menu

Use any of the following methods to enter the **Patient Management** menu:

- Select the patient information area at the top left corner of the screen.
- Select the **Patient Management** quick key.
- Select the **Main Menu** hard key or quick key → from the **Patient Management** column select **Patient Management**.

5.3.2 Editing Patient Information

Edit patient information after a patient has been admitted, or when patient information is incomplete, or when you want to change patient information:

To edit patient information, follow this procedure:

1. Enter the **Patient Management** menu. For more information, see *5.3.1 Entering the Patient Management Menu*.
2. Edit patient information as required.

If you connect a barcode reader with your monitor, you can scan the patient's barcode to enter patient information.

NOTE

- The monitor will reload the configuration if you change the patient category.
-

5.3.3 Loading Patient Information from the CMS

If the monitor is connected to the central monitoring system (CMS). You can load patient information from the CMS to the monitor. To do so, follow this procedure:

1. Enter the **Find Patient** menu in either of the following ways:
 - ◆ Select the **Main Menu** hard key or quick key → from the **Patient Management** column select **Find Patient**.
 - ◆ From the **Patient Management** menu select **Find Patient**.
2. Input query criteria. If your monitor is connected with the ADT server, input query criteria from the **Discharged Patients** page.
3. Select **Search**. Then a list pops up, including all the patients that meet the query criteria.
4. Select a patient from the patient list, and then select **Import**. Corresponding patient information in the monitor will be updated.

5.3.4 Loading Patient Information from the ADT Server

If the monitor is connected with the Admit-Discharge-Transfer (ADT) server through the eGateway. You can load patient information from ADT server to the monitor. To do so, follow this procedure:

1. Enter the **Find Patient** menu in either of the following ways:
 - ◆ Select the **Main Menu** hard key or quick key → from the **Patient Management** column select **Find Patient**.
 - ◆ Select **Find Patient** from the **Patient Management** menu.
2. Input query criteria.
3. Select **Search**. Then a list pops up, including all the patients that meet the query criteria.
4. Select a patient from the patient list, and then select **Import**. Corresponding patient information in the monitor will be updated.

NOTE

- You can load patient information from the ADT server only when ADT Query is enabled. For more information, see 7.5 MLDAP.
 - Loading patient information from the ADT server updates only patient information in the monitor. The patient's monitoring data is not changed and the patient is not discharged.
-

5.4 Exporting Patient Data

You can export the demographic information and monitoring data of the current and discharged patients via a USB drive. For more information, see 23.7.4 *The Export Tab*.

5.5 Deleting Patient Data

To delete the data of discharged patients, follow this procedure:

1. Access the **Discharged Patients** dialog box by either of the following ways:
 - ◆ Select the **Discharged Patients** quick key.
 - ◆ Select the **Main Menu** hard key or quick key → from the **Patient Management** column select **Discharged Patients**.
2. From the patient list select desired patients.
3. Select **Delete**.

This page intentionally left blank.

6 Managing Configurations

6.1 Configuration Introduction

When continuously monitoring a patient, the clinical professional often needs to adjust the monitor's settings according to the patient's condition. The collection of all these settings is called a configuration. System configuration items can be classified as: parameter configuration, alarm configuration, and user maintenance. The monitor provides one general department with three different sets of configurations tailored for adult, pediatric and neonatal patients. You can change some settings from a certain set of configuration and then save the changed configuration as a user configuration.

WARNING

- **The configuration management function is password protected. The configuration management tasks must be performed by clinical professionals.**
-

6.2 Setting Default Patient Category

To set the default patient category when admitting a new patient, follow this procedure:

1. Select the **Main Menu** hard key or quick key → from the **Configuration** column select **Manage** → input the required password → select .
2. Set **Default Patient Category**.

6.3 Setting Default Configuration

The monitor will load the pre-set default configuration in the following cases:

- A patient is admitted.
- A patient is discharged.
- Patient category is changed.

To set the default configuration, follow this procedure:

1. Select the **Main Menu** hard key or quick key → from the **Configuration** column select **Manage** → input the required password → select .
2. Select **Select Default Config**.
3. Select **Load the Latest Config** or **Load Specified Config**.
 - ◆ When you select **Load the Latest Config**, the latest configuration is loaded when the monitor is started or a patient is admitted.
 - ◆ When you select **Load Specified Config**, the selected configuration of **Default Adult Config**, **Default Ped Config**, or **Default Neo Config** is loaded when the monitor is started or a patient is admitted. The specified configuration can be the factory default configuration, the age segments configuration, or a saved user defined configuration. As an example, select **Default Neo Config** and then select **Factory Default**, **Neo GA Segments**, or a user configuration. For more information on defining age segments, see [6.4 Defining Age Segments](#).

6.4 Defining Age Segments

You must define age segments for any patient category you want to load configurations based on the patient's age. To do so, follow this procedure:

1. Select the **Main Menu** hard key or quick key → from the **Configuration** column select **Manage** → input the required password → select .
2. Select **Select Default Config**.

3. Respectively select the edit icons  followed by **Customize Configurations for Adult Age Segments**, **Customize Configurations for Ped Age Segments**, and **Customize Configurations for Neo Gestational Age Segments** to define the age segments for each patient category. The age segment of the neonatal patient is based on the baby's gestational age.

6.5 Saving Current Settings

Current settings can be saved as a user configuration. Up to 25 user configurations can be saved.

To save current settings, follow this procedure:

1. Select the **Main Menu** hard key or quick key → from the **Configuration** column select **Manage** → input the required password → select .
2. Select **Save Current Settings**.
3. Input the configuration name.
4. Select **OK** to save current settings as a user configuration.

6.6 Deleting a Configuration

To delete a configuration, follow this procedure:

1. Select the **Main Menu** hard key or quick key → from the **Configuration** column select **Manage** → input the required password → select .
2. Select **Delete Configuration**.
3. Select the configuration you want to delete:
 - ◆ In the **Delete Configuration** menu, selecting **Local** tab shows the existing user configurations on the monitor.
 - ◆ In the **Delete Configuration** menu, selecting **USB Drive** tab shows the existing user configurations on the USB drive.
4. Select **Delete**.
5. Select **OK**.

6.7 Transferring a Configuration

When installing several monitors with identical user configurations, it is not necessary to set each unit separately. Use a USB drive to transfer the configuration from monitor to monitor.

6.7.1 Exporting a Configuration

To export the current monitor's configuration, follow this procedure:

1. connect the USB drive to the monitor's USB connector.
2. Select the **Main Menu** hard key or quick key → from the **Configuration** column select **Manage** → input the required password → select .
3. Select **Export Configuration**.
4. Select the configurations and **User Maintenance Settings** to export.
5. Select **Export**.

6.7.2 Importing a Configuration

To import the configuration from the USB drive to the monitor, follow this procedure:

1. Connect the USB drive to the monitor's USB port.
2. Select the **Main Menu** hard key or quick key → from the **Configuration** column select **Manage** → input the required password → select .
3. Select **Import Configuration**.
4. Select the configurations and **User Maintenance Settings** to import.

5. Select **Import**.

6.8 Printing Configurations

To print factory configurations and user configurations, follow this procedure:

1. Select the **Main Menu** hard key or quick key → from the **Configuration** column select **Manage** → input the required password → select .
2. Select **Print Configuration**.
3. Select desired configurations.
4. Select **Print**.

6.9 Loading a Configuration

You may make changes to some settings during operation. However, these changes or the pre-selected configuration may not be appropriate for the newly admitted patient. Therefore, the monitor allows you to load a desired configuration to ensure that all the settings are appropriate for your patient.

To load a configuration, follow this procedure:

1. Select the **Main Menu** hard key or quick key → from the **Configuration** column select **Load**.
2. Select the desired configuration.
 - ◆ Select the configuration on this monitor in the **Local** page.
 - ◆ Select the configuration on the USB drive in the **USB Drive** page.
3. Select **Load**.

NOTE

- **The monitor may configure some settings by default when you load a configuration of different software version with the current configuration.**
-

6.10 Modifying Configuration Password

To modify the configuration password, follow this procedure:

1. Select the **Main Menu** hard key or quick key → from the **Configuration** column select **Manage** → input the required password → select .
2. Select **Modify Password**.
3. Respectively input the old password and new password.
4. Select **OK**.

This page intentionally left blank.

7 Networked Monitoring

7.1 Network Introduction

You can connect the monitor to the central monitoring system (CMS), eGateway, and other monitors through wired LAN or wireless LAN.

7.2 Network Safety Information

CAUTION

- **Wireless network design, deployment, debugging, and maintenance should be executed by Mindray service personnel or authorized technicians.**
 - **Always deploy the wireless network according to local wireless regulations.**
 - **Using 5G frequency band is recommended whenever possible. There are more interference sources in 2.4G frequency band.**
 - **Private APs and wireless routers are not allowed. These devices may cause radio interference and result in monitor and CMS data loss.**
 - **To ensure network security and stability, data communication must be performed within a closed network or within a virtually isolated hospital network. The hospital is responsible for ensuring the security of the virtually isolated network.**
 - **WPA2-PSK and WPA2-Enterprise verification and encryption should be used if possible. Otherwise, the equipment may not be able to work or patient information may be leaked. WPA2-Enterprise and a long password are recommended.**
 - **Keep network authentication information, for example password, from being accessed by unauthorized users.**
 - **Do not connect non-medical devices to the monitor network.**
 - **If wireless network signal is poor, there may be a risk of CMS data loss.**
 - **Maximum number of monitors connected to a single AP is 16. Too many monitors connected to the same AP may result in network disconnection.**
 - **RF interference may result in wireless network disconnection.**
 - **Disconnecting from the network may result in CMS data loss and function failure. Check the patient in case of network disconnection and reconnect the network as soon as possible.**
 - **Ensure that the monitor IP address setting is correct. Changing the network settings may result in network disconnection. Contact your service personnel if you have any problems on setting the IP address.**
-

7.3 Connecting the Monitor to the CMS

You can connect the monitor to the Central Monitoring System (CMS) through wired LAN or wireless LAN. When connected to the CMS, the system provides the following function.

- The monitor can transmit parameter values, waveforms, alarm settings, and events to the CMS. From the CMS, you can check the patient's monitoring data and alarms.
- Patient information, alarm settings, and alarm status can be synchronized between the monitor and the CMS.
- You can start or stop NIBP measurements from the CMS.
- In case of network disconnection, the monitor can transmit the offline data to the CMS when network is reconnected.

For more information on the CMS, see *the operator's manual of corresponding central monitoring system*.

To select a CMS, select the system status information area at the top right corner of the main screen. Select the desired CMS from the popup CMS list.

NOTE

- **You can select CMS only when Select CMS is switched on. For more information, see 23.16.4 The Central Station Setup Tab.**
-

7.4 Connecting the eGateway

You can connect the monitor to the eGateway to implement interaction between the monitor and external devices. When connected to the eGateway, the system provides the following functions:

- The monitor can transmit parameter values, waveforms, alarm settings, and events to the eGateway.
- Clock can be synchronized between the monitor and the eGateway.

7.5 MLDAP

MLDAP refers to Mindray LDAP (Lightweight Directory Access Protocol). It is an independent process which can be installed on eGateway or other application server (Windows). MLDAP provides user identity and authentication.

The MLDAP server is connected with the hospital LDAP server. All monitoring devices are connected to the MLDAP server to implement identity and authentication for the following operations:

- Changing alarm settings
- Changing arrhythmia settings
- Accessing the **Maintenance** menu

For more information on setting the MLDAP server, see 23.16.10 The MLDAP Tab. For more information on selecting or changing the passwords, see 23.12 The Authorization Setup Settings.

7.6 Connecting the Wireless Network

You can add up to five wireless networks for the monitor. If connecting the current wireless network fails, the monitor automatically connects other wireless networks in the order when they were added.

To manually switch the wireless network, from the system status information area on the top right corner of the screen select , and select the desired wireless network.

7.7 Disconnecting the Wireless Network

To disconnect the wireless network manually, follow this procedure:

1. Swipe the screen from top down with a single finger.
2. Select .

To reconnect the wireless network after it is disconnected manually, follow this procedure:

1. Swipe the screen from top down with a single finger.
2. Select .

8 Alarms

8.1 Alarm Introduction

This chapter describes alarm functions and alarm settings.

8.2 Alarm Safety Information

WARNING

- **A potential hazard can exist if different alarm presets and default configuration settings are used for the same or similar equipment in the same care area, for example an intensive care unit or cardiac operating room.**
 - **If your monitor is connected to the central monitoring system (CMS) or other monitors, alarms can be presented and controlled remotely. Remote suspension, inhibition, or reset of monitor alarms via the CMS or other monitors may cause a potential hazard. For more information, see the operator's manuals of the CMS and the other monitors.**
 - **The monitors in the care area may each have different alarm settings to suit different patients. Before starting monitoring, check that the alarm settings are appropriate for the patient. Always make sure that necessary alarm limits are active and set according to the patient's clinical condition.**
 - **Setting alarm limits to extreme values may cause the alarm system to become ineffective. For example, high oxygen levels may predispose a premature infant to retrolental fibroplasia. Setting the SpO₂ high alarm limit to 100% is equivalent to switching the alarm off the SpO₂ alarm.**
 - **When the alarm sound is switched off, the monitor gives no alarm tones even if a new alarm occurs. Be careful about whether to switch off the alarm sound or not. When the alarms are off or while alarm audio is paused either temporarily or indefinitely, observe the patient frequently.**
 - **When monitoring patients that are not continuously attended by a clinical operator, properly configure the alarm system and adjust alarm settings as per the patient's condition.**
 - **Do not exclusively rely on audible alarms for patient monitoring. Adjusting alarm volume to a low level or turning off alarm sound may result in patient hazards. Always make sure that the audio alarm volume level is adequate in your care environment. Always keep the patient under close surveillance.**
-

8.3 Understanding the Alarms

8.3.1 Alarm Categories

The monitor has two different types of alarms: physiological alarms and technical alarms.

- Physiological alarms are triggered by patient measurement exceeding the parameter limits, or by an abnormal patient conditions.
- Technical alarms are triggered by an electrical, mechanical, or other monitor failure, or by failure of a sensor or component. Technical alarm conditions may also be caused when an algorithm cannot classify or interpret the available data.

Apart from the physiological and technical alarms, the monitor can also prompt some messages telling the system status or patient status.

8.3.2 Alarm Priorities

By severity, the alarms are classified into the following priority levels:

- High priority alarms: indicate a life threatening situation or a severe device malfunction. High priority alarms require an immediate response.
- Medium priority alarms: indicate abnormal vital signs or a device malfunction. Medium priority alarms require a prompt response.
- Low priority alarms: indicate a discomfort condition, a device malfunction, or an improper operation. Low priority alarms require you to be aware of this condition.
- Messages: provides additional information on the patient or the equipment.

8.3.3 Alarm Indicators

When an alarm occurs, the monitor indicates it to you through visual or audible alarm indications. For more information, see the following table.





Alarm Indicator		High Priority Alarm	Medium Priority Alarm	Low Priority Alarm	Message	Comments
Alarm lamp		Red Flashing frequency: 1.4 - 2.8 Hz Duty cycle: 20 - 60% on	Yellow Flashing frequency: 0.4 - 0.8 Hz Duty cycle: 20 - 60% on	Yellow No flashing Duty cycle: 100% on	None	None
Audible tone pattern	ISO	Repeat pattern of triple + double + triple + double beeps	Repeat pattern of triple beeps	Single beep	None	None
Alarm message		White text inside a red box	Black text inside a yellow box	Black text inside a yellow box	White text	Alarm messages are displayed in the alarm information area at the top of the screen. You can select the alarm messages to show the alarm list.
Alarm priority indicator		!!!	!!	!	None	The indicator shows in front of corresponding alarm message.
Parameter value		White text inside a flashing red box	Black text inside a flashing yellow box	Black text inside a flashing yellow box	None	None

NOTE

- **When multiple alarms of different priority levels occur simultaneously, the monitor selects the alarm of the highest priority to light the alarm lamp and issue the alarm tone.**
- **When multiple technical alarms of different priority levels occur simultaneously and should be displayed in the same area, the monitor only displays the messages of the highest priority alarm.**
- **When multiple physiological alarms of different priority levels occur simultaneously and should be displayed in the same area, the monitor displays the high priority alarm, while the medium and low priority alarms are displayed circularly.**
- **When multiple alarms of the same priority levels occur simultaneously, alarm messages are displayed circularly.**
- **Lethal arrhythmia alarms, apnea, and SpO₂ Desat are exclusive high priority alarms. When these alarms occur, the monitor only displays messages of exclusive alarms. Other high priority alarms will not be displayed. When multiple exclusive alarms occur simultaneously, alarm messages are displayed circularly.**

8.3.4 Alarm Status Symbols

Apart from the alarm indicators as described in 8.3.3 *Alarm Indicators*, the monitor uses the following symbols to indicate the alarm status:

-  Alarm pause: indicates that all the alarms are paused.
-  Alarm off: indicates that individual measurement alarms are turned off or the system is in the alarm off status.
-  Audio pause: indicates that audible alarm tones are paused.
-  Audio off: indicates that audible alarm tones are turned off.
-  Alarm reset: indicates that the alarm system is reset.

8.4 Accessing On-screen Help for Technical Alarms (AlarmSight)

In the technical alarm list, alarm messages followed by **Detail** include help messages or pictures to help you identify the problem. This function is called AlarmSight. To access AlarmSight, follow this procedure:

1. Select the technical alarm information area to enter the **Alarms** window.
2. Select the **Technical Alarms** tab.
3. From the alarm list select the desired alarm.

8.5 Checking Physiological Alarm List

To check the physiological alarm list, follow this procedure:

1. Select the physiological alarm information area to enter the **Alarms** window.
2. Select the **Physiological Alarms** tab.

8.6 Changing Alarm Settings

Select the **Alarm Setup** quick key or from the **Alarm** column of the main menu select desired buttons to set alarm properties.

8.6.1 Setting Parameter Alarm Properties

To set parameter alarm properties, follow this procedure:

1. Access the **Limits** page in either of the following ways:
 - ◆ Select the **Alarm Setup** quick key.
 - ◆ Select the **Main Menu** hard key or quick key → from the **Alarm** column select **Limits**.
2. Select a parameter tab and set alarm properties as desired. Enter the password if required. For more information, see 23.12 *The Authorization Setup Settings*.

You can also change the alarm properties of individual parameter from corresponding parameter menu.

8.6.2 Setting Alarm Tone Properties

8.6.2.1 Changing the Alarm Volume

You can swipe up and down with one finger on the right part of the main screen to quickly change alarm volume.

Or you can set specific alarm volume by following the procedure below:

1. Access the **Setup** page in either of the following ways:
 - ◆ Select the **Alarm Setup** quick key → select the **Setup** tab.
 - ◆ Select the **Main Menu** hard key or quick key → from the **Alarm** column select **Setup**.
2. Set **Alarm Volume**. The optional alarm volume is between X to 10, in which X is the minimum volume, depending on the setting of minimum alarm volume, and 10 is the maximum volume.
3. Select **High Alarm Volume** to set the volume of the high priority alarm.
4. Select **Reminder Volume** to set the volume of the reminder tone.

NOTE

- **When Alarm Volume is set to 0, the alarm sound is turned off and the audio off symbol appears on the screen. You cannot set the volume of high priority alarms if Alarm Volume is set to 0.**

8.6.2.2 Password Protected Audio Alarm Settings

The following alarm settings are password protected:

- Minimum alarm volume
- Alarm sound pattern
- Alarm interval
- Alarm sound escalation switch and delay

For more information, see 23.4.1 *The Audio Tab*.

8.6.3 Initiating Auto Alarm Limits

The monitor provides the auto alarm limits function to automatically adjust alarm limits according to the patient's vital signs using. When auto limits are selected, the monitor calculates safe auto limits based on the latest measured values. To get accurate auto alarm limits, you need to collect a set of measured vital signs as a baseline.

To initiate auto alarm limits, follow this procedure:

1. Access the **Limits** page in either of the following ways:
 - ◆ Select the **Alarm Setup** quick key.
 - ◆ Select the **Main Menu** hard key or quick key → from the **Alarm** column select **Limits**.
2. From the **Limits** page, select **Auto Limits** at the left bottom.
3. Select **OK** from the popup dialog box.

Then the monitor will automatically calculate alarm limits basing on the latest measured values. Before applying these automatically created alarm limits, confirm if they are appropriate for your patient from the **Limits** menu. If not, you can adjust them manually. These alarm limits will remain unchanged until you select auto limits again or adjust them manually.

The monitor calculates auto limits basing on the following rules:

Module	Parameter	Lower Limit		Upper Limit		Auto Limit Range
		Adult/ Pediatric	Neonate	Adult/ Pediatric	Neonate	
ECG	HR/PR (bpm)	HR × 0.8 or 40 (whichever is greater)	(HR - 30) or 90 (whichever is greater)	HR × 1.25 or 240 (whichever is smaller)	(HR + 40) or 200 (whichever is smaller)	Adult/Pediatric: 35 to 240 Neonate: 55 to 225
Resp	RR (rpm)	RR × 0.5 or 6 (whichever is greater)	(RR - 10) or 30 (whichever is greater)	(RR × 1.5) or 30 (whichever is smaller)	(RR + 25) or 85 (whichever is smaller)	Adult/Pediatric: 6 to 55 Neonate: 10 to 90

Module	Parameter	Lower Limit		Upper Limit		Auto Limit Range
		Adult/ Pediatric	Neonate	Adult/ Pediatric	Neonate	
SpO ₂	SpO ₂ (%)	Same as the default alarm limit	Same as the default alarm limit	Same as the default alarm limit	Same as the default alarm limit	Same as the measurement range
NIBP	NIBP-S (mmHg)	$(SYS \times 0.68 + 10)$	$(SYS - 15)$ or 45 (whichever is greater)	$(SYS \times 0.86 + 38)$	$(SYS + 15)$ or 105 (whichever is smaller)	Adult: 45 to 270 Pediatric: 45 to 185 Neonate: 35 to 115
	NIBP-D (mmHg)	$(Dia \times 0.68 + 6)$	$(Dia - 15)$ or 20 (whichever is greater)	$(Dia \times 0.86 + 32)$	$(Dia + 15)$ or 80 (whichever is smaller)	Adult: 25 to 225 Pediatric: 25 to 150 Neonate: 20 to 90
	NIBP-M (mmHg)	$(Mean \times 0.68 + 8)$	$(Mean - 15)$ or 35 (whichever is greater)	$(Mean \times 0.86 + 35)$	$(Mean + 15)$ or 95 (whichever is smaller)	Adult: 30 to 245 Pediatric: 30 to 180 Neonate: 25 to 105
Temp (xx refers to temperature site)	Txx (°C)	$(Txx - 0.5)$	$(Txx - 0.5)$	$(Txx + 0.5)$	$(Txx + 0.5)$	1 to 49
	ΔT (°C)	Same as the default alarm limit	Same as the default alarm limit	Same as the default alarm limit	Same as the default alarm limit	Same as the measurement range
IBP: ART/ Ao/UAP/ BAP/ FAP/LV/ P1-P4 (Arterial pressure)	IBP-S (mmHg)	$SYS \times 0.68 + 10$	$(SYS - 15)$ or 45 (whichever is greater)	$SYS \times 0.86 + 38$	$(SYS + 15)$ or 105 (whichever is smaller)	Adult: 45 to 270 Pediatric: 45 to 185 Neonate: 35 to 115
	IBP-D (mmHg)	$(Dia \times 0.68 + 6)$	$(Dia - 15)$ or 20 (whichever is greater)	$(Dia \times 0.86 + 32)$	$(Dia + 15)$ or 80 (whichever is smaller)	Adult: 25 to 225 Pediatric: 25 to 150 Neonate: 20 to 90
	IBP-M (mmHg)	$Mean \times 0.68 + 8$	$(Mean - 15)$ or 35 (whichever is greater)	$Mean \times 0.86 + 35$	$(Mean + 15)$ or 95 (whichever is smaller)	Adult: 30 to 245 Pediatric: 30 to 180 Neonate: 25 to 105
IBP: PA	IBP-S (mmHg)	$SYS \times 0.75$	$SYS \times 0.75$	$SYS \times 1.25$	$SYS \times 1.25$	3 to 120
	IBP-D (mmHg)	$Dia \times 0.75$	$Dia \times 0.75$	$Dia \times 1.25$	$Dia \times 1.25$	3 to 120
	IBP-M (mmHg)	$Mean \times 0.75$	$Mean \times 0.75$	$Mean \times 1.25$	$Mean \times 1.25$	3 to 120
IBP: CPP	CPP (mmHg)	$CPP \times 0.68 + 8$	$(CPP - 15)$ or 35, (whichever is greater)	$CPP \times 0.86 + 35$	$(CPP + 15)$ or 95, (whichever is smaller)	Adult: 20 to 235 Pediatric: 25 to 175 Neonate: 25 to 100
IBP: CVP/ LAP/ RAP/ UVP/P1-P4 (Venous pressure)	IBP-M	$Mean \times 0.75$	$Mean \times 0.75$	$Mean \times 1.25$	$Mean \times 1.25$	3 to 40

Module	Parameter	Lower Limit		Upper Limit		Auto Limit Range
		Adult/ Pediatric	Neonate	Adult/ Pediatric	Neonate	
CO ₂	EtCO ₂ (mmHg)	0 to 32: remains the same	0 to 32: remains the same	0 to 32: remains the same	0 to 32: remains the same	Same as the measurement range
		33 to 35: 29	33 to 35: 29	33 to 35: 41	33 to 35: 41	Same as the measurement range
		36 to 45: (EtCO ₂ - 6)	36 to 45: (EtCO ₂ - 6)	36 to 45: (EtCO ₂ + 6)	36 to 45: (EtCO ₂ + 6)	Same as the measurement range
		46 to 48: 39	46 to 48: 39	46 to 48: 51	46 to 48: 51	Same as the measurement range
		>48: remains the same	>48: remains the same	>48: remains the same	>48: remains the same	Same as the measurement range
	FiCO ₂	None	None	Same as the default alarm limit	Same as the default alarm limit	Same as the measurement range
	awRR (rpm)	awRR × 0.5 or 6 (whichever is greater)	(awRR - 10) or 30 (whichever is greater)	awRR × 1.5 or 30 (whichever is smaller)	(awRR+25) or 85 rpm (whichever is smaller)	Adult/Pediatric: 6 to 55 Neonate: 10 to 90
C.O.	TB (°C)	Adult: (TB - 1) Pediatric: N/A	N/A	Adult: (TB + 1) Pediatric: N/A	N/A	Same as the measurement range
	C.I.	N/A	N/A	N/A	N/A	N/A
	TFC	N/A	N/A	N/A	N/A	N/A

8.6.4 Setting the Alarm Delay Time

For continuously measured parameters, you can set the alarm delay time. If the alarm condition is resolved within the delay time, the monitor does not present the alarm.

This setting is password protected. For more information, see 23.4.6 *The Other Tab*.

The setting of **Alarm Delay** is not applied to the apnea alarms and the ST alarms. You can set **Apnea Delay** and **ST Alarm Delay** separately; for details, see 8.6.4.1 *Setting the Apnea Delay Time* and 23.4.6 *The Other Tab*.

WARNING

- **The alarm delay time can be set to a maximum of 15 seconds. Changing this setting to an inappropriate level could result in a hazard to the patient.**
-

8.6.4.1 Setting the Apnea Delay Time

To set the apnea delay time, follow this procedure:

1. Access the **Setup** page in either of the following ways:
 - ◆ Select the **Alarm Setup** quick key → select the **Setup** tab.
 - ◆ Select the **Main Menu** hard key or quick key → from the **Alarm** column select **Setup**.
2. Select **Apnea Delay** to set the apnea delay time.

8.6.5 Restoring the Default Alarm Settings

To reset all alarm settings to the defaults, follow this procedure:

1. Access the **Limits** page in either of the following ways:

- ◆ Select the **Alarm Setup** quick key.
 - ◆ Select the **Main Menu** hard key or quick key → from the **Alarm** column select **Limits**.
2. Select **Defaults** at the bottom.

8.6.6 Setting the Length of Printed Waveforms

You can define the length of printed waveforms when an alarm is triggered. To do so, follow this procedure:

1. Access the **Setup** page in either of the following ways:
 - ◆ Select the **Alarm Setup** quick key → select the **Setup** tab.
 - ◆ Select the **Main Menu** hard key or quick key → from the **Alarm** column select **Setup**.
2. Set **Printing Duration On Alarm**.

8.6.7 Setting the Switch of the SpO₂ Desat Alarm Off

You can choose whether switching off the SpO₂ Desat alarm is permissible or not. This setting is password protected. For more information, see 23.4.6 *The Other Tab*.

WARNING

- If you switch off the SpO₂ Desat alarm, the monitor will not alarm when the patient's SpO₂ is extremely low. This may result in a hazard to the patient. Always keep the patient under close surveillance.
-
-

8.6.8 Setting the Switch of the Apnea Alarm Off

You can choose whether switching off the apnea alarm is permissible or not. This setting is password protected. For more information, see 23.4.6 *The Other Tab*.

WARNING

- If you switch off the apnea alarm, the monitor will not issue the apnea alarm in case that apnea happens. This may result in a hazard to the patient. Keep the patient under close surveillance.
-
-

8.7 Pausing Alarms/Pausing Alarm Tones

8.7.1 Defining the Pause Function

You can either pause alarms or pause alarm tones. This depends on the pause setting. This setting is password protected. For more information, see 23.4.2 *The Pause/Reset Tab*.

8.7.2 Pausing Alarms

If the pause function is designated as pausing alarms, the following rules are followed:

- No physiological alarm will be presented.
- Except battery-related technical alarms, sounds of other technical alarms are paused, but alarm lamps and alarm messages remain presented.
- The remaining alarm pause time is displayed in the physiological alarm information area.
- The alarm pause symbol is displayed in the system information area.

When the alarm pause time expires, the alarm paused status is automatically deactivated.

The following alarm pause and alarm reset settings are password protected.

- Alarm pause time
- Priorities of paused alarms
- Alarm reset setting
- Reminder tone settings

For more information, see 23.4.2 *The Pause/Reset Tab*.

8.7.2.1 Switching Off All Alarms

If the pause function is designated as pausing alarms and **Pause Time** is set to **Permanent** (see 23.4.2 *The Pause/Reset Tab*), the alarm off status has the following features:

- Physiological alarms are switched off. The alarm lamp does not flash and alarm sound is not issued.
- Alarm sound of technical alarms is switched off, but alarm lamp flashes and alarm messages are presented.
- The message **Alarm Off** with red background is displayed in the physiological alarm information area.
- The alarm off symbol is displayed in the system status information area.

WARNING

- **Pausing or switching off alarms may result in a hazard to the patient.**
-
-

8.7.3 Pausing Alarm Sound

If the pause function is defined as **Audio Pause**, pressing the **Audio Pause** key pauses alarm tone. When alarm tones are paused, the following rules are followed:

- The sound of all physiological alarms and technical alarms are switched off.
- The remaining audio pause time is displayed in the physiological alarm information area.
- The audio pause symbol is displayed in the system information area.

When the audio pause time expires, the audio paused status is automatically deactivated. You can also cancel the audio paused status by pressing the **Audio Pause** quick key.

8.7.3.1 Setting the Alarm Tone Pause Time

The alarm tone pause time can be set to **1 min**, **2 min**, **3 min**, or **Permanent**. The default audio pause time is two minutes.

This function is password protected. For more information, see 23.4.2 *The Pause/Reset Tab*.

8.7.3.2 Prolonging the Alarm Tone Pause Time

You can temporarily prolong the alarm tone pause time after the monitor enters the alarm tone paused status. This function is password protected. For more information, see 23.4.2 *The Pause/Reset Tab*.

NOTE

- **Prolonging alarm pause time does not affect the setting of alarm tone pause time.**
-

8.7.3.3 Setting the Priority of Audio Paused Alarms

You can select alarm sound of what priority can be paused. This function is password protected. For more information, see 23.4.2 *The Pause/Reset Tab*

8.7.3.4 Switching Off Alarm Sound

If **Pause Time** is set to **Permanent** (see 23.4.2 *The Pause/Reset Tab*), pressing the **Audio Pause** quick key permanently switches off all alarm sound. The audio off status has the following features:

- Alarm sound of both physiological alarms and technical alarms is switched off.

- The audio off symbol is displayed in the system information area.

To exit the audio off status, press the **Audio Pause** quick key again.

WARNING

- **Pausing or switching off alarm sound may result in a hazard to the patient.**
-

8.8 Resetting Alarms

Pressing the **Alarm Reset** quick key to reset the alarm system. When the alarm system is reset, the alarm reset symbol displays in the system status information area for alarm symbols.

NOTE

- **If a new alarm is triggered after the alarm system is reset, the alarm reset icon will disappear and the alarm light and alarm tone will be reactivated.**
-

8.8.1 Resetting Physiological Alarms

Physiological alarms give different alarm indicators when the alarm system is reset:

- The alarm sound is silenced.
- A √ appears before the alarm message.
- The color of the parameter numeric background corresponds with the alarm priority, but the parameter numeric does not flash.

8.8.2 Resetting Technical Alarms

Technical alarms give different alarm indicators when the alarm system is reset:

- Some technical alarms are cleared. The monitor gives no alarm indications.
- Some technical alarms are changed to the prompt messages.
- For some technical alarms, the alarm is silenced and a √ appears before the alarm message.

For details about the indications of technical alarms when the alarm system is reset, see *D.2 Technical Alarm Messages*.

8.9 Latching Alarms

The latching setting for physiological alarms defines how alarm indicators behave if you do not reset the alarms.

- If you do not “latch” physiological alarms, their alarm indications disappear when the alarm condition ends.
- If you “latch” physiological alarms, all visual and audible alarm indications remain until you reset the alarms. For latched alarms the time when the alarm is last triggered is displayed behind the alarm message.

You can separately latch visual indications or simultaneously latch the visual and the audible indications.

- When visual indications are latched, visual indications, including alarm lamp, alarm message and its background remain when the alarm condition ends and the time when the alarm last triggered is displayed behind the alarm message.
- When audible indications are latched, the monitor issues alarm sounds when the alarm condition ends.

The alarm latch settings is password protected. For more information, see *23.4.3 The Latching Tab*.

NOTE

- **Changing alarm priority may affect the latching status of corresponding alarm. Determine if you need to reset the alarm latching status if you changed the alarm priority.**
 - **When the alarm system is reset, latched physiological alarms are cleared.**
-

8.10 Nurse Call

The monitor provides a nurse call connector to output nurse call signal when a user-defined alarm occurs. To obtain nurse call signal, use the nurse call cable to connect the hospital nurse call system with the monitor's nurse call connector.

Alarms are indicated on the nurse call device only when the following conditions are met:

- The nurse call system is enabled.
- A user-defined alarm occurs.
- Alarms are not paused or reset.

WARNING

- **Do not rely exclusively on the nurse call system for alarm notification. Remember that the most reliable alarm notification combines audible and visual alarm indications with the patient's clinical condition.**
-

8.11 Calling for Help

In case of needing a help, you can call monitors in the same department and the CMS system from your monitor so that nearby doctors and nurses can come for help.

To call help, select the **Call Help** quick key and select **OK** from the popup dialog box. If you did not select **OK**, the monitor will automatically send out the call help signal in five seconds.

After the call help signal is sent out, the **Call Help** quick key flashes in red. If you need to stop calling for help, select the **Call Help** quick key again.

Monitors receiving the call help signal issue a sound and a dialog box pops up indicating which monitor is calling. Select **OK** to acknowledge the call and stop the sound at this monitor.

Central Monitoring System (CMS) receiving the call help signal also issues a sound which automatically stops after a while. Selecting the call help icon on the CMS clears this call help and stops the sound.

NOTE

- **The call help function works only when the monitor is connected to the network.**
 - **The call help sound may disturb patients in the same department.**
-

8.12 CPB Mode

In the CPB mode, all the physiological alarms and technical alarms are switched off. So when performing CPB, you can put the monitor in the CPB mode in order to inactivate unnecessary alarms.

8.12.1 Entering the CPB Mode

To enter the CPB mode, choose either of the following ways:

- Select the **CPB Mode** quick key.
- Select the **Main Menu** hard key or quick key → from the **Alarm** column select **CPB Mode**.

In the CPB mode, **CPB Mode** is displayed in the physiological alarm area with a red background color.

NOTE

- **When the CPB mode is entered, the monitor stops all NIBP measurements. You can restart NIBP measurements after entering the CPB mode.**
-

8.12.2 Exiting the CPB Mode

To exit the CPB mode, choose either of the following ways:

- Select the **CPB Mode** quick key.
- Select the **Main Menu** hard key or quick key → from the **Alarm** column select **Exit CPB Mode**.

8.13 Intubation Mode

Intubation mode is available for Resp, CO₂ monitoring. When performing intubation during general anesthesia, you can put the monitor in the intubation mode in order to inactivate unnecessary alarms.

In the intubation mode, Resp, CO₂ related physiological alarms are switched off.

8.13.1 Entering the Intubation Mode

To enter the intubation mode, choose either of the following ways:

- Select the **Intubation Mode** quick key.
- From the bottom of the **Resp** or **CO₂** menu, select **Intubation Mode**.
- Select the **Main Menu** hard key or quick key → from the **Alarm** column select **Intubation Mode**.

8.13.2 Exiting the Intubation Mode

To exit the intubation mode, choose either of the following ways:

- Select the **Exit Intubation Mode** quick key.
- From the bottom of the **Resp** or **CO₂** menu, select **Exit Intubation Mode**.
- Select the **Main Menu** hard key or quick key → from the **Alarm** column → select **Exit Intubation Mode**.

8.14 Testing Alarms

The monitor automatically performs a selftest at startup. Check that an alarm tone is heard, and the alarm lamp illuminates, one by one, in red, yellow. This indicates that audible and visible alarm indicators function properly.

8.15 Actions When an Alarm Occurs

When an alarm occurs, observe the following steps and take proper actions:

1. Check the patient's condition.
2. Confirm the alarming parameter or alarm category.
3. Identify the source of the alarm.
4. Take proper action to eliminate the alarm condition.
5. Make sure the alarm condition is corrected.

For more information, see *D Alarm Messages*.

This page intentionally left blank.

9

Monitoring ECG, Arrhythmia, ST and QT

9.1 ECG Introduction

The electrocardiogram (ECG) measures and records the electrical activity of the heart. ECG monitoring provides 3-, 5-, 6- and 12-lead ECG monitoring, ST-segment analysis, arrhythmia analysis, and QT/QTc measurements.

9.2 ECG Safety Information

WARNING

- This equipment is not intended for direct cardiac application.
- Make sure the conductive parts of electrodes and associated connectors, including the neutral electrode, do not contact any other conductive parts including earth.
- Use defibrillation-proof ECG cables during defibrillation.
- Do not touch the patient or metal devices connected to the patient during defibrillation.
- To reduce the hazard of burns during high-frequency surgical procedure, ensure that the monitor's cables and transducers never come into contact with the electrosurgery unit (ESU).
- To reduce the hazard of burns during use of high-frequency surgical unit (ESU), the ECG electrodes should not be located between the surgical site and the ESU return electrode.

CAUTION

- Only use parts and accessories specified in this manual. Follow the instructions for use and adhere to all warnings and cautions.
- Periodically inspect the electrode application site to ensure skin integrity. If the skin quality changes, replace the electrodes or change the application site.
- Interference from ungrounded instrument near the patient and electrosurgery interference can induce noise and artifact into the waveforms.

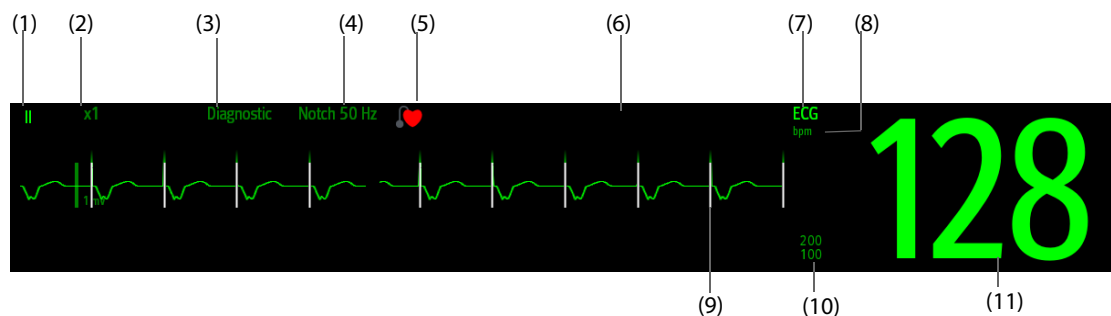

9.3 ECG Display

The following figures show the ECG waveform and numeric areas.



(1) ECG lead label of the displayed waveform. When 6-lead placement is used to derive 12-lead ECG (D12L), all derived leads are marked with a “d” in front of the lead label, for example “dV1”.

(2) ECG waveform gain (3) ECG filter mode (4) Notch filter status

(5) Paced status: If **Paced** is set to **Yes**,  is displayed. If **Paced** is set to **No**,  is displayed.

(6) HR/PR alarm message (7) Parameter label (8) HR unit

(9) Pace pulse mark: If **Paced** is set to **Yes**, the pace pulse markers “|” are displayed corresponding to detected pace pulse on each ECG waveform.

(10) HR alarm limits (11) HR value

9.4 Preparing for ECG Monitoring

9.4.1 Preparing the Patient Skin

Proper skin preparation is necessary to ensure good signal quality at the electrode sites, as the skin is a poor conductor of electricity. To properly prepare the skin, follow this procedure:

1. Shave hair from skin at chosen electrode sites.
2. Gently rub skin surface at sites to remove dead skin cells.
3. Thoroughly cleanse the site with a mild soap and water solution.
4. Dry the skin completely before applying electrodes.

9.4.2 Applying Electrodes

To connect ECG cables, follow this procedure:

1. Check that electrode packages are intact and the electrodes are not past the expiry date. Make sure the electrode gel is moist. If you are using snap electrodes, attach the snaps to the electrodes before placing electrodes on the patient.
2. Place the electrodes on the prepared sites. Make sure that all electrodes have good skin contact.
3. Connect the leadwires to the patient cable if not already connected.
4. Plug the patient cable into the ECG connector.

NOTE

- **Store the electrodes at room temperature.**
- **Only open the electrode package immediately prior to use.**
- **Never mix patient electrode types or brands. This may lead to problem due to impedance mismatch.**
- **When applying the electrodes, avoid bony area, obvious layers of fat, and major muscles. Muscle movement can result in electrical interference. Applying electrodes on major muscles, for example on muscles of the thorax, may lead to erroneous arrhythmia alarms due to excessive muscle movement.**

9.4.3 Lead Wire Color Code

The following table lists the color coding of leadwires for both AHA and IEC standards:

Lead	IEC		AHA	
	Label	Color	Label	Color
Right arm	R	Red	RA	White
Left arm	L	Yellow	LA	Black

Lead	IEC		AHA	
	Label	Color	Label	Color
Right leg (neutral)	N	Black	RL	Green
Left leg	F	Green	LL	Red
Chest 1	C1	White/Red	V1	Brown/Red
Chest 2	C2	White/Yellow	V2	Brown/Yellow
Chest 3	C3	White/Green	V3	Brown/Green
Chest 4	C4	White/Brown	V4	Brown/Blue
Chest 5	C5	White/Black	V5	Brown/Orange
Chest 6	C6	White/Violet	V6	Brown/Violet

9.4.4 ECG Electrode Placement

In this section, electrode placement is illustrated using the AHA naming convention.

9.4.4.1 3-Lead Electrode Placement

3-lead electrode placement is as follows:

- RA: just below the clavicle and near the right shoulder.
- LA: just below the clavicle and near the left shoulder.
- LL: below the lower left edge of the rib cage.

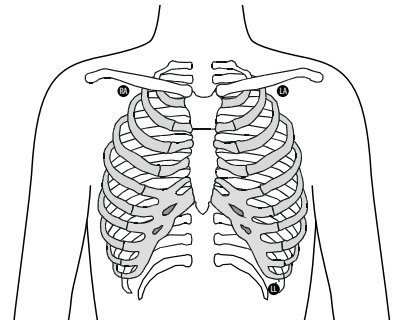

9.4.4.2 5-Lead Electrode Placement

5-lead electrode placement is as follows:

- RA: just below the clavicle and near the right shoulder.
- LA: just below the clavicle and near the left shoulder.
- RL: below the lower right edge of the rib cage.
- LL: below the lower left edge of the rib cage.
- V: on the chest.

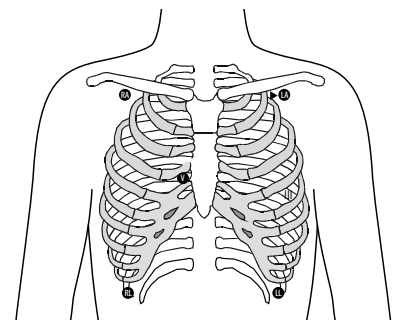

9.4.4.3 6-Lead Electrode Placement

For 6-lead electrode placement, you can use the position for the 5-lead placement but with two chest leads. The chest leads Va and Vb can be positioned at any two of the V1 to V6 positions. For more information, see *9.4.4.4 Chest Electrode Placement*. The Va and Vb lead positions are configurable. For more information, see *9.6.4.4 Changing Va and Vb Labels*.

When 6-lead placement is used to derive 12-lead ECG, Va and Vb shall use any of the following combinations.

- V1 and V3, V1 and V4, V1 and V5
- V2 and V4, V2 and V5
- V3 and V5, V3 and V6

9.4.4.4 Chest Electrode Placement

The chest electrode can be placed at the following positions:

- V1: on the fourth intercostal space at the right border of sternal.
- V2: on the fourth intercostal space at the left border of sternal.
- V3: midway between V2 and V4.
- V4: on the fifth intercostal space on the left midclavicular line.
- V5: on the left anterior axillary line at the same horizontal level as V4.
- V6: on the left midaxillary line at the same horizontal level as V4 and V5.

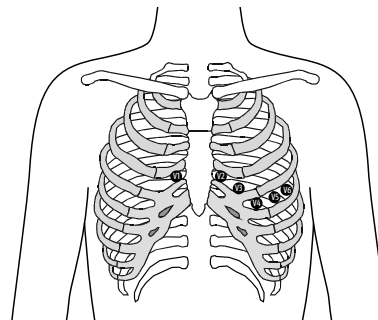

NOTE

- For the 5-leadwire and 6-leadwire placement, place the precordial electrode according to the physician's preference.

9.4.4.5 12-Lead Electrode Placement

12-lead ECG monitoring uses 10 electrodes. The chest electrodes can be placed according to the physician's preference. The picture at the right side shows the conventional 12-lead electrode placement. For the placement of RA, RL, LA, and LL, see 9.4.4.2 5-Lead Electrode Placement. For the placement of chest electrodes, see 9.4.4.4 Chest Electrode Placement.

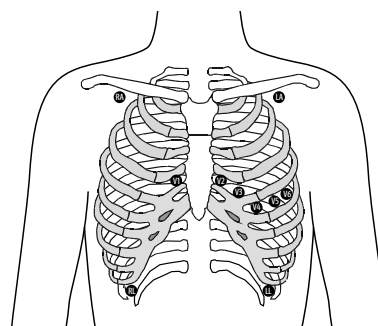

9.4.4.6 Lead Placement for Pacemaker Patients

The pacemaker patient usually requires a different electrode placement configuration than a non-pacemaker patient.

Do not place an ECG electrode directly over the pacemaker generator. Place the electrodes 5 cm to 7 cm away from the pacemaker generator area. For example, if the pacemaker generator is located in the left subclavian area, relocate the Left Arm electrode closer in towards the center of the chest.

9.4.4.7 Lead Placement for Surgical Patients

The surgical site should be taken into consideration when placing electrodes on a surgical patient. For example, for open-chest surgery, the chest electrodes can be placed on the lateral chest or back. To reduce artifacts and interference from electrosurgical units, you can place the limb electrodes close to the shoulders and lower abdomen and the chest electrodes on the left side of the mid-chest. Do not place the electrodes on the upper arm. Otherwise, the ECG waveform will be very small.

WARNING



- To reduce the hazard of burns during use of electrosurgical units (ESU), the ECG electrodes should not be located between the surgical site and the ESU return electrode.
 - Never entangle the ESU cable and the ECG cable together.
 - If the ESU is used, do not place ECG electrodes near the grounding plate of the ESU. Otherwise interference on ECG signals may occur.
-

9.4.5 Choosing the ECG Lead Type

To choose ECG lead type, follow this procedure:

1. Select the ECG numeric area or waveform area to enter the **ECG** menu.
2. Select the **Setup** tab.
3. Set **Lead Set** according to the lead type you are going to use. The default lead type is **Auto**. In this case, the monitor automatically detects the lead type.

9.4.6 Checking Paced Status

You should check the patient's paced status before monitoring ECG. The paced symbol  is displayed when **Paced** is set to **Yes**. The pace pulse markers "|" are shown on each ECG waveform when the patient has a paced signal. If **Paced** is set to **No** or if the patient's paced status is not selected, the symbol  will be shown in the ECG waveform area.

To change the paced status, follow this procedure:

1. Select the ECG numeric area or waveform area to enter the **ECG** menu.
2. Select the **Pacer** tab.
3. Set **Paced** to **Yes** or **No**.

You can also change the patient's paced status from the Patient Management menu. For more information, see *5.3.1 Entering the Patient Management Menu*.

If you did not set the paced status, the monitor issues a prompt tone when pace pulse is detected. At the same time, the paced symbol  flashes and the message **Please check if the patient has a pacemaker** appears in the ECG waveform area. Check and set the patient's paced status.

WARNING

- **For paced patients, set Paced to Yes. Otherwise the monitor could mistake a pace pulse for a QRS complex and fail to generate alarm when the ECG signal is too weak. On ventricular paced patients, episodes of ventricular tachycardia may not always be detected. Do not rely entirely upon the system's automated arrhythmia detection algorithm.**
 - **False low heart rate or false asystole alarms may result with certain pacemakers because of pacemaker artifacts, such as electrical overshoot of the pacemaker overlapping the true QRS complexes.**
 - **Do not rely entirely on rate meter alarms when monitoring patients with pacemakers. Always keep these patients under close surveillance.**
 - **The auto pacer recognition function is not applicable to pediatric patient, neonatal patients.**
 - **For non-paced patients, you must set Paced to No.**
-

9.4.7 Enabling Pacer Rejection

The pace pulse rejection function is disabled by default. To enable this function, follow this procedure:

1. Select the ECG numeric area or waveform area to enter the **ECG** menu.
2. Select the **Pacer** tab.
3. Switch on **Pacer Reject**.

NOTE

- **When pace pulses are detected, the pace pulse marks "|" are shown on the ECG waveforms. Pacer Rejection setting has no impact on the display of pace pulse marks "|".**
 - **You can switch on Pacer Reject only when Paced is set to Yes. If Paced is set to No, the setting of Pacer Reject is disabled.**
-

9.5 Using 6-lead Placement to Derive 12-lead ECG (D12L)

The monitor supports using the 6-lead placement to derive 12-lead ECG. This function is called D12L. When D12L is enabled, the monitor can derive four additional chest leads according to directly acquired ECG signals.

D12L provides a non-diagnostic 12-lead view, including ECG waveforms and ST/QT measurements. D12L is intended for adult patients only.

The available Va and Vb combinations supporting D12L are:

- V1 and V3, V1 and V4, V1 and V5
- V2 and V4, V2 and V5
- V3 and V5, V3 and V6

D12L is disabled by default. To enable D12L, follow this procedure:

1. Select the ECG numeric area or waveform area to enter the **ECG** menu.
2. Select the **Setup** tab.
3. Select the positions of Va and Vb. You shall use an available Va and Vb combination.
4. Switch on **D12L**.

WARNING

- **D12L is not intended for pediatric and neonatal patients.**
 - **The positions of Va and Vb shall be consistent with the settings of Va and Vb. Otherwise D12L does not work properly.**
 - **The derived leads cannot be used for heart rate calculation and arrhythmia analysis.**
 - **The derived 12-lead ECGs should not be used for diagnostic interpretations.**
-
-

NOTE

- **You shall use the available Va and Vb combination supporting D12L. If you choose other combinations, D12L does not work and the message “D12L Not Available” is prompted.**
-

9.6 Changing ECG Settings

9.6.1 Choosing an ECG Screen

When monitoring ECG, you can choose the screen as desired.

- For 3-lead ECG monitoring, only normal screen is available.
- For 5-lead ECG monitoring, besides the normal screen, you can also choose 7-lead full screen or 7-lead half screen.
- For 6-lead ECG monitoring, besides the normal screen, you can also choose 8-lead full screen or 8-lead half screen.
- For 12-lead ECG monitoring, besides the normal screen, you can also choose 7-lead full screen, 7-lead half screen, and 12-lead full screen.

To choose the desired screen configuration, follow this procedure:

1. Select the ECG numeric area or waveform area to enter the **ECG** menu.
2. From the bottom of the menu, select **Full-Screen**, **Half-Screen**, or **12-Lead** (for 12-lead ECG monitoring).

9.6.2 Setting ECG Alarm Properties

To set ECG alarm properties, follow this procedure:

1. Select the ECG numeric area or waveform area to enter the **ECG** menu.
2. Select the **Alarm** tab.
3. Enter the password if required.
4. Set alarm properties as desired.

9.6.3 Setting the Analysis Mode

Multiple leads analysis enhances detection sensitivity and reduces false alarms. However, when most leads are noisy or with low amplitude, choosing the optimal lead as calculation lead and single lead analysis is recommended.

To set the ECG analysis mode, follow this procedure:

1. Select the ECG numeric area or waveform area to enter the **ECG** menu.
2. Select the **Setup** tab.
3. Set the **Analysis Mode**.
 - ◆ **Multiple Leads:** the monitor uses two leads (ECG1 to ECG 2) as calculation leads.
 - ◆ **Single Lead:** the monitor uses one lead (ECG1) as calculation lead.

NOTE

- **It is difficult for the monitor to differentiate an aberrantly conducted beat from a ventricular beat. An aberrantly conducted beat may be misclassified as a ventricular beat. In this case, choose the lead with a narrow R-wave for ECG1 and select Single Lead.**
 - **When a 3-lead ECG cable is used, the monitor always uses single lead as calculation lead.**
-

9.6.4 Changing ECG Wave Settings

9.6.4.1 Selecting the Leads of Displayed ECG Waveforms

To select the leads of displayed ECG waveforms, follow this procedure:

1. Select the ECG numeric area or waveform area to enter the **ECG** menu.
2. Select the **Setup** tab.
3. Select **ECG** to set the lead of each ECG waveform.
4. If more than three ECG waveforms are displayed, select the **More Leads** tab, and then select **ECG** to set leads of other ECG waveforms.

The waveform of selected lead should have the following characteristics:

- The QRS complex is tall and narrow.
- The QRS complex is completely above or below the baseline. It should not be biphasic.
- The amplitudes of P waves and T waves are less than 0.2 mV.

CAUTION

- **Ensure that you have selected the optimal leads with the best waveform amplitude and the highest signal-to-noise ratio. Selecting the optimal leads is important for detecting beats, classifying beats, and detecting ventricular fibrillation.**
-

NOTE

- **If D12L is enabled, you cannot select the derived leads as ECG1 or ECG2.**
-

9.6.4.2 Setting the ECG Waveform Layout

To set the ECG waveform layout, follow this procedure:

1. Select the ECG numeric area or waveform area to enter the **ECG** menu.
2. Select the **Setup** tab.
3. Set **Waveform Layout**.
 - ◆ **Standard:** the waveform sequence is I, II, III, aVR, aVL, aVF, V1, V2, V3, V4, V5, V6.
 - ◆ **Cabrera:** the waveform sequence is aVL, I, -aVR, II, aVF, III, V1, V2, V3, V4, V5, V6.

9.6.4.3 Changing ECG Waveform Size

If the ECG waveform is too small or clipped, you can change its size by selecting an appropriate **Gain** setting. To do so, follow this procedure:

1. Select the ECG numeric area or waveform area to enter the **ECG** menu.
2. Select the **Setup** tab.
3. Select **ECG Gain** to set the size of each ECG waveform.
4. If more than three ECG waveforms are displayed, select the **More Leads** tab, and then select **ECG Gain** to change the sizes of other ECG waveforms. If you select **Auto**, the monitor automatically adjusts the size of the ECG waveforms.

9.6.4.4 Changing Va and Vb Labels

When monitoring ECG with 6-leadwire. You can change the labels of Va and Vb leads. To do so, follow this procedure:

1. Select the ECG numeric area or waveform area to enter the **ECG** menu.
2. Select the **Setup** tab.
3. Set **Va** and **Vb** according to the Va and Vb electrode sites. Default settings are **Va** and **Vb**.

9.6.4.5 Changing ECG Waveform Speed

To change ECG waveform speed, follow this procedure:

1. Select the ECG numeric area or waveform area to enter the **ECG** menu.
2. Select the **Setup** tab.
3. Set **Speed**.

9.6.4.6 Setting the ECG Filter

To set the ECG waveform filter mode, follow this procedure:

1. Select the ECG numeric area or waveform area to enter the **ECG** menu.
2. Select the **Setup** tab.
3. Set **Filter**.
 - ◆ **Diagnostic**: is used when ECG waveform of diagnostic quality is required.
 - ◆ **Monitor**: is used in ECG monitoring.
 - ◆ **Surgery**: is used if ECG signals are distorted by high or low frequency noise. In the operating room, setting **Filter** to **Surgery** can reduce ESU interference. However, during normal ECG monitoring, selecting **Surgery** may suppress certain features or details of the QRS complexes.
 - ◆ **ST**: is recommended for ST monitoring.
 - ◆ **Emphasis**: is used when ECG signals are still obviously distorted by high or low frequency noise when selecting **Surgery**. However, during normal ECG monitoring, selecting **Emphasis** may suppress certain features or details of the QRS complexes.
 - ◆ **Custom**: is used to customize filter frequency range including **Highpass** and **Lowpass**. Signal within this range is displayed and signal beyond this range is filtered out. For example, set **Highpass** and **Lowpass** as **0.32Hz** and **45Hz** respectively, then signal with frequency between 0.32Hz and 45Hz is displayed and signal with frequency beyond 0.32Hz and 45Hz is filtered out.

9.6.4.7 Switching On or Off the Notch Filter

The notch filter removes the line frequency interference. To switch on or off the notch filter, follow this procedure:

1. Select the ECG numeric area or waveform area to enter the **ECG** menu.
2. Select the **Setup** tab.
3. Switch on or off **Notch Filter**.

NOTE

- **Notch Filter can only be switched on or off when Filter is set to Diagnostic. In other filter modes, Notch Filter is always on.**

9.6.5 Disabling the Smart Lead Off Function

The monitor provides the smart lead off function . When the lead of the first ECG wave is detached but another lead is available, the monitor automatically switches to the available lead to recalculate heart rate, and to analyze and detect arrhythmias. When you reconnect the detached leads, the monitor automatically switches back to the original lead.

The smart lead off function is enabled by default. To disable this function, follow this procedure:

1. Select the ECG numeric area or waveform area to enter the **ECG** menu.
2. Select the **Setup** tab.
3. Switch off **Smart Lead**.

9.6.6 Setting CrozFusion™

The CrozFusion™ function analyzes the ECG signal and the Pleth wave signal together to achieve more accurate arrhythmia analysis result and HR/PR measurements.

9.6.6.1 Displaying CrozFusion™

When the CrozFusion™ function is enabled, you can display ECG and Pleth signal quality and signal fusion status in the ECG parameter area. To do so, follow this procedure:

1. Select the ECG numeric area or waveform area to enter the ECG menu.
2. Select the **Setup** tab.
3. Switch on **Display CrozFusion**.

The following figure is an example when **Display CrozFusion** is switched on:

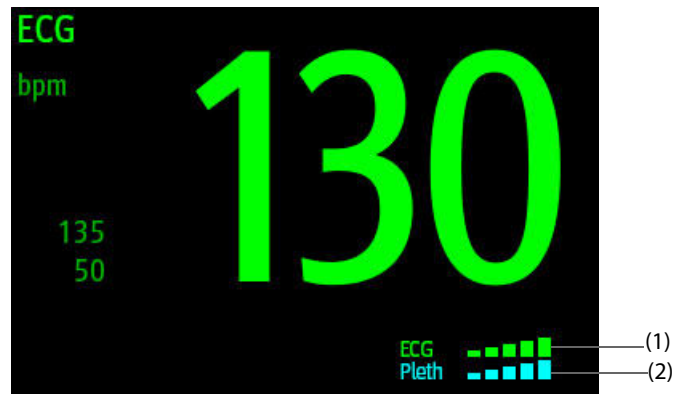

(1) ECG signal quality index (ECG SQI) (2) Pleth signal quality index (Pleth SQI)

SQI with five highlighted bars indicates the best signal. SQI with one highlighted bar indicates the poorest signal.

To view the on-screen help for the CrozFusion™ function, select the **CrozFusion** tab from the **ECG** menu. The following table lists SQI indications of different signal fusion status:



The quality of both ECG and Pleth signal is good. ECG signal and Pleth signal are independently analyzed.



The quality of Pleth signal is poor. The PR value may be erroneous. The ECG signal is being used to correct the PR value.



The quality of ECG signal is poor. The HR value and arrhythmia analysis may be erroneous. The Pleth signal is being used to correct the HR value and for arrhythmia analysis.

NOTE

- **The CrozFusion™ function is not applicable to the following arrhythmias: Pacer Not Capture and Pacer Not Pacing.**
 - **The CrozFusion™ function is not suitable for patients with uncertain hemodynamic such as low perfusion.**
 - **Do not exclusively rely on the CrozFusion™ function. Always pay close attention to the changes of the patient's physiological parameters when enabling the CrozFusion™ function.**
 - **The CrozFusion™ function uses ECG arrhythmia analysis leads according to the Analysis Mode setting. So the ECG SQI indicates the signal quality of the ECG arrhythmia analysis leads.**
 - **If the SQI is poor, check ECG electrodes or SpO₂ sensor application. Reposition the electrodes or sensor if necessary.**
-

9.6.6.2 Disabling the CrozFusion™ Function

The CrozFusion™ function is enabled by default. However, in some situations you may need to disable this function, or the CrozFusion™ function may not be able to work. You shall disable the CrozFusion™ function in the following situation:

- Administrating CPR
- Performing CPB
- Performing IABP
- Other situations that the CrozFusion™ function is not applicable

To disable the CrozFusion™ function, follow this procedure:

1. Select the ECG numeric area or waveform area to enter the ECG menu.
2. Select the **Setup** tab.
3. Switch off **CrozFusion**.

WARNING

- **The monitor is used for single patient at a time. Simultaneously monitoring more than one patient may result in a hazard to the patient.**
 - **CrozFusion™ function might lead to suppressing arrhythmia falsely or medical personnel neglecting interfering elements. In this case, medical personnel should disable this function according to patient's status.**
 - **ECG signal and Pleth signal from different patients may result in incorrect signal fusion.**
-

9.6.6.3 Setting CrozFusion™

- To set the maximum time CrozFusion suppresses the false arrhythmias, see *23.6.1 The ECG Tab*.
- To set whether to display arrhythmia suppression events in the events review page, see *23.6.1 The ECG Tab*.

9.6.7 Adjusting the QRS Volume

To adjust the QRS volume, follow this procedure:

1. Select the ECG numeric area or waveform area to enter the **ECG** menu.
2. Select the **Setup** tab.
3. Set **QRS Volume**.

When valid SpO₂ measurements are available, the monitor adjusts the pitch of QRS tone based on the SpO₂ value.

9.6.8 Adjusting the Minimum QRS Detection Threshold

To avoid false asystole alarm due to low R wave amplitude, and to avoid tall T waves and P waves being mistaken for QRS complexes, the monitor provides a means to manually adjust the minimum QRS detection threshold.

To adjust the minimum QRS detection threshold, follow this procedure:

1. Select the ECG numeric area or waveform area to enter the **ECG** menu.
2. Select the **Setup** tab and set **Filter** to **Monitor**.
3. Select the **QRS Threshold** tab.
4. Select up or down arrow buttons to adjust the minimum threshold for QRS detection. Selecting **Default** resets the QRS threshold to the default value (0.16 mV).

CAUTION

- **The setting of the QRS detection threshold can affect the sensitivity for arrhythmia, ST, QT/QTc detection, and heart rate calculation.**
 - **If QRS amplitude is low, the monitor might not be able to calculate heart rate and false asystole calls may occur.**
-

NOTE

- **The minimum QRS detection threshold can only be adjusted when the ECG filter is set to Monitor.**
-

9.7 Monitoring Arrhythmia

Arrhythmia monitoring is intended for adult, pediatric and neonatal patients.

9.7.1 Arrhythmia Safety Information

WARNING

- **Heart rate reading may be affected by cardiac arrhythmias. Do not rely entirely on heart rate alarms when monitoring patients with arrhythmia. Always keep these patients under close surveillance.**
 - **Atrial fibrillation (A-Fib) detection function is not intended for pediatric and neonatal patients.**
 - **The arrhythmia analysis program may incorrectly identify the presence or absence of an arrhythmia. Therefore, a physician must analyze the arrhythmia information with other clinical findings.**
-

CAUTION

- **Since the arrhythmia detection algorithm sensitivity and specificity are less than 100%, sometimes there may be some false arrhythmias detected and also some true arrhythmia events may not be detected. This is especially true when the signal is noisy.**
 - **The ECG size and minimum QRS detection threshold settings affect arrhythmia detection and heart rate calculation sensitivity.**
 - **If QRS amplitude is low, the monitor might not be able to calculate heart rate and false asystole calls may occur. During the learning phase of the algorithm, arrhythmia detection may not be available. So you should closely monitor patient condition during and for several minutes after the learning phase to allow the algorithm to reach optimal detection performance.**
-

9.7.2 Arrhythmia Events

This section lists all arrhythmia events and their criteria.

9.7.2.1 Lethal Arrhythmia Events

Arrhythmia message	Description
Asystole	No QRS complex detected within the set time interval in the absence of ventricular fibrillation or chaotic signal.
V-Fib/V-Tach	A fibrillatory wave for 6 consecutive seconds. A dominant rhythm of adjacent PVCs and the ventricular rate is greater than the V-tach rate limit.
V-Tach	The number of consecutive PVCs is greater than or equal to the V-Tach PVCs limit, and the ventricular rate is greater than or equal to the V-Tach rate limit.
Vent Brady	The number of consecutive PVCs is greater than or equal to V brady PVC limit and the ventricular rate is less than the V brady rate limit.
Extreme Tachy	The heart rate is greater than the extreme tachycardia limit.
Extreme Brady	The heart rate is less than the extreme bradycardia limit.

9.7.2.2 Nonlethal Arrhythmia Events

Arrhythmia message	Description
R on T	R on T PVC is detected.
Run PVCs	More than two consecutive PVCs, but lower than the V brady PVCs limit, and the ventricular rate is lower than the V-Tach rate limit.
Couplet	A Pair of PVCs detected in between normal beats.
Multiform PVC	Multiform PVCs detected in Multif. PVC's Window (which is adjustable).
PVC	One PVC detected in between normal beats.
Bigeminy*	A dominant rhythm of N, V, N, V, N, V.
Trigeminy*	A dominant rhythm of N, N, V, N, V, N, V, N, V.
Tachy	The heart rate is greater than the tachycardia limit.
Brady	The heart rate is lower than the bradycardia limit.
Pacer Not Capture	No QRS complex detected for 300 ms following a pace pulse (for paced patients only).
Pacer Not Pacing	No pace pulse detected for 1.75 x average R-to-R intervals following a QRS complex (for paced patients only).
Missed Beat	At least 3 consecutive Ns, and The current RR interval is greater than 1.5 x previous RR interval, and The next RR interval is lower than 1.5 x average RR interval, and HR lower than 100 and the current RR interval is greater than 1.75 x average RR interval , or HR is greater than or equal to 100 and the current RR interval is greater than 1000 ms.
Nonsus V-Tach	The number of consecutive PVCs is lower than the V-Tach PVCs limit but greater than 2, and the ventricular rate is greater than or equal to the V-Tach Rate limit.
Vent Rhythm	The number of consecutive PVCs is greater than or equal to the V Brady PVCs limit, and ventricular rate is greater than or equal to the V Brady Rate limit but lower than V-Tach Rate limit.
Pause	No QRS complex is detected within the set time threshold of pause.
Irr Rhythm	Consistently irregular rhythm (N, irregular RR interval change is greater than 12.5%)
A-Fib	P wave is absent and normal beat RR intervals are irregular.
PVCs/min	PVCs/min exceeds high limit.
Pauses/min	Pauses/min exceeds high limit.
Irr Rhythm End	Irregular rhythm no longer detected within the irregular rhythm end delay time.

Arrhythmia message	Description
A-Fib End	Atrial fibrillation no longer detected within the Afib end delay time.
SVT	The number of consecutive SVCs is greater than or equal to the SVT SVCs limit, and the supraventricular HR is greater than or equal to the SVT HR limit.
SVCs/min	SVCs/min exceeds the high limit.

*N: normal beat; V: ventricular beat

9.7.3 Displaying Arrhythmia Information

You can display the arrhythmia information in the numeric area. To do so, follow this procedure:

1. Access **Tile Layout** by either of the following ways:
 - ◆ Select the **Screen Setup** quick key → select the **Tile Layout** tab.
 - ◆ Select **Main Menu** hard key or quick key → from the **Display** column select **Tile Layout**.
2. Click the numeric area where you want to display the arrhythmia information, and then select ECG → **Arrhythmia**.

9.7.4 Changing Arrhythmia Settings

9.7.4.1 Changing Arrhythmia Alarm Settings

To set the arrhythmia alarm properties, follow this procedure:

1. Select the ECG numeric area or waveform area to enter the **ECG** menu.
2. Select the **Arrhythmia** tab → **Alarm** tab.
3. Enter the password if required.
4. Set alarm properties as desired.

NOTE

- You can switch off lethal arrhythmia alarms only when you have enabled **Lethal Arrhys Off**. For more information, see 9.7.4.2 *Setting the Lethal Arrhythmia Alarms Switch*.
- The priority of lethal arrhythmia alarms is always high. It cannot be altered.

9.7.4.2 Setting the Lethal Arrhythmia Alarms Switch

You can choose whether switching off lethal arrhythmia alarms is permissible or not. This function is password protected. For more information, see 23.4.6 *The Other Tab*.

WARNING

- If you switch off all arrhythmia alarms, the monitor will not alarm for any arrhythmia event. This may result in a hazard to the patient. Always keep the patient under close surveillance.

NOTE

- If any of the lethal arrhythmia alarms is switched off, the ECG waveform area displays the “Lethal Arrhys Off” message.

9.7.4.3 Changing Arrhythmia Alarm Threshold Settings

You can change threshold settings for some arrhythmia alarms. When an arrhythmia violates its threshold, an alarm will be triggered. To do so, follow this procedure:

1. Select the ECG numeric area or waveform area to enter the **ECG** menu.

2. Select the **Arrhythmia** tab → select the **Threshold** tab.
3. Enter the password if required.
4. Set the threshold of desired arrhythmia alarms.

NOTE

- **The asystole delay time relates to ECG relearning. When heart rate is less than 30 bpm, it is recommended to set Asystole Delay to 10 sec.**

9.7.4.4 Arrhythmia Threshold Range

Arrhythmia	Threshold Range
Asystole Delay	3 s to 10 s
Tachy(HR High)	60 bpm to 295 bpm
Brady(HR Low)	16 bpm to 120 bpm
Extreme Tachy	65 bpm to 300 bpm
Extreme Brady	15 bpm to 115 bpm
Multif PVCs Window	3 beats to 31 beats
V-Tach Rate	100 bpm to 200 bpm
V-Brady Rate	15 bpm to 60 bpm
V-Tach PVCs	3 beats to 99 beats
V-Brady PVCs	3 beats to 99 beats
PVCs/min	1 to 100
Pauses/min	1 to 15
Pause Threshold	1.5s, 2.0s, 2.5s, 3.0s
AF/Irr Rhy End Time	0, 1 min, 2 min, 3 min, 4 min, 5 min, 10 min, 15 min, 30 min
SVT HR	100 bpm to 300 bpm
SVT SVCs	3 beats to 99 beats
SVCs/min	1 to 100

9.7.4.5 Setting Thresholds for PVC-Related Alarms

The monitor detects PVC-related alarms basing on the current PVC rate and the number of consecutive PVCs.

To set the required thresholds for PVC-related alarms, follow this procedure:

1. Select the ECG numeric area or waveform area to enter the **ECG** menu.
2. Select the **Arrhythmia** tab → select the **More Threshold** tab.
3. Enter the password if required.
4. Adjust **V-Tach PVCs**, **V-Tach Rate**, **V-Brady PVCs**, and **V-Brady Rate** to set the threshold of desired PVC-related alarms.

The following figure illustrates the conditions under which PVC alarms will be generated if **V-Tach PVCs** is set to 6, **V-Tach Rate** is set to 130, **V-Brady PVCs** is set to 5, and **V-Brady Rate** is set to 40.

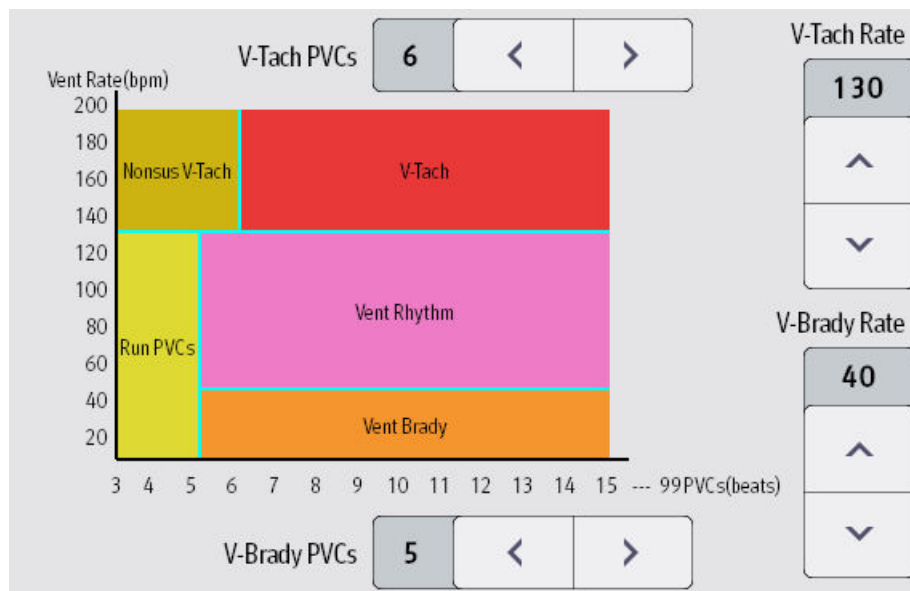

- If the number of consecutive PVCs is greater than or equal to the V-Tach PVCs limit (6), and the ventricular rate (Vent Rate) is greater than or equal to the V-Tach Rate limit (130), a V-Tach alarm is generated.
- If the number of consecutive PVCs is lower than the V-Tach PVCs limit (6) but greater than 2, and the ventricular rate is greater than or equal to the V-Tach Rate limit (130), a Nonsus V-Tach alarm is generated.
- If the number of consecutive PVCs is greater than or equal to the V-Brady PVCs limit (5), and the ventricular rate is lower than the V-Tach Rate limit (130) but greater than or equal to the V Brady Rate limit (40), a Vent Rhythm alarm is generated.
- If the number of consecutive PVCs is lower than the V-Brady PVCs limit (5) but greater than 2, and the ventricular rate is lower than the V-Tach Rate limit (130), a Run PVCs alarm is generated.
- If the number of consecutive PVCs is greater than or equal to the V-Brady PVCs limit (5), and the ventricular rate is lower than the V Brady Rate limit (40), a Vent Brady alarm is generated.

9.7.5 Arrhythmia Alarms

The monitor generally issues an alarm once an arrhythmia condition is detected. However, in some conditions, alarm light and alarm tone are disabled although the arrhythmia condition is detected. For more information, see [9.7.5.1 Arrhythmia Alarm Chains](#) and [9.7.5.2 Setting Arrhythmia Alarm Shielding Period](#).

9.7.5.1 Arrhythmia Alarm Chains

If multiple arrhythmia conditions occur simultaneously, announcing all detected alarm conditions may be confusing. This may result in serious conditions being overlooked. So arrhythmia alarms are prioritized through alarm chains.

There are five arrhythmia alarm chains: one high priority chain and four medium priority chains, including PVC chain, beats detection chain, supraventricular chain, and A-Fib chain.

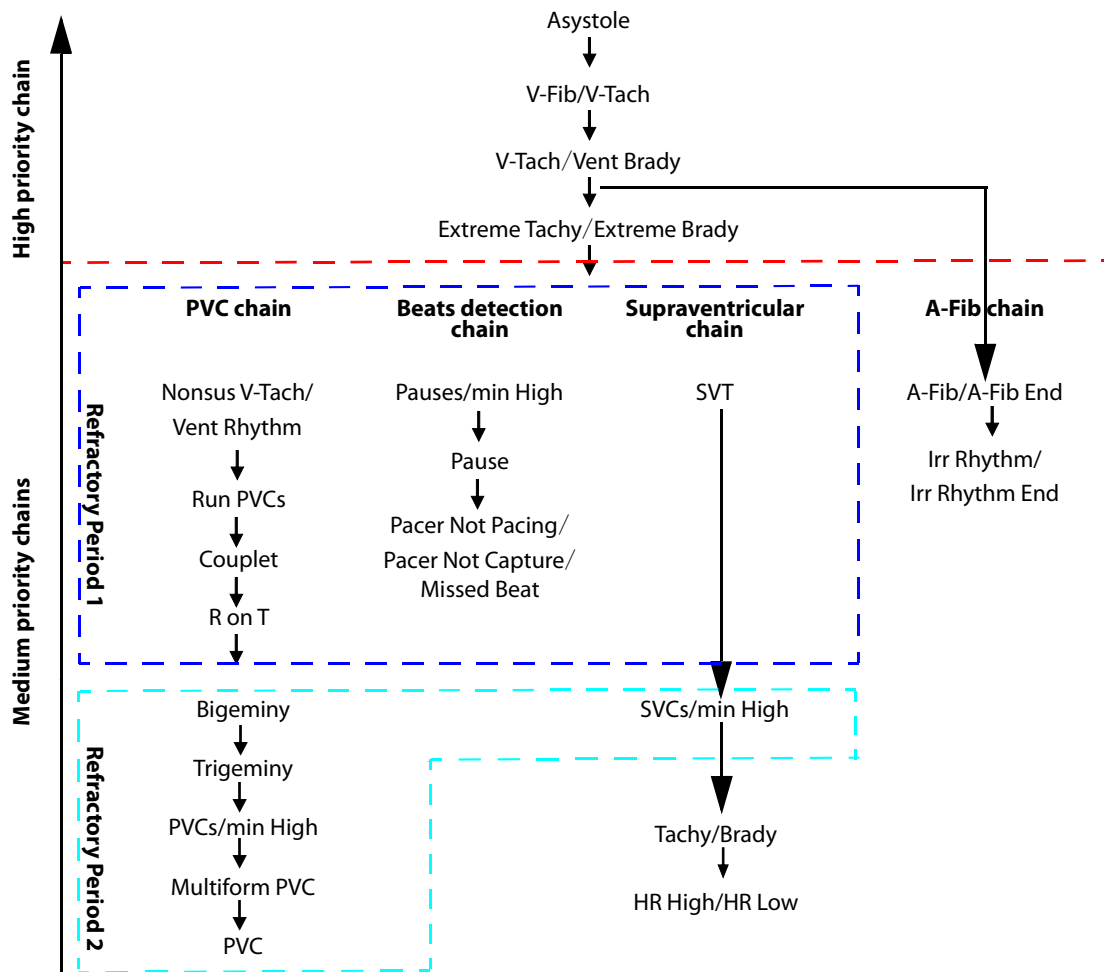

Note:The refractory periods have no impact on Tachy, Brady, HR High, and HR Low.

9.7.5.2 Setting Arrhythmia Alarm Shielding Period

The arrhythmia algorithm can disable alarm light and alarm tone for designated period of time when certain arrhythmia alarms are detected.

This function is password protected. For more information, see **Arrhy Shield Time** in 23.4.6 *The Other Tab*.

NOTE

- The arrhythmia shielding period is only applicable to arrhythmias in the medium priority chains. For arrhythmias in the high priority chain, alarm tone and alarm light are generated as soon as an alarm condition is detected.
- The arrhythmia shielding period has no impact on HR High, HR Low, Tachy, Brady, A-Fib End, Irr Rhythm End.

9.7.5.3 Arrhythmia Alarm Shielding Rules

The following table explains how audible and visual alarm indicate during arrhythmia alarm shielding period.

Previous alarm	Current alarm	Alarm indication
Alarm in high priority chain	Alarm in high priority chain	Alarm light and alarm tone
	Alarm in medium priority chain	During the shielding period, alarm light and alarm tone are disabled. When the shielding period is reached, alarm light and alarm tone are reactivated.
Alarm in medium priority chain	Alarm in high priority chain	Alarm light and alarm tone
	Alarm in the same medium priority chain, but with higher priority	Alarm light and alarm tone
	The same alarm reoccurs	During the shielding period, alarm light and alarm tone are disabled. When the shielding period is reached, alarm light and alarm tone are reactivated.
	Alarm in the same medium priority chain, but with lower priority	During the shielding period, alarm light and alarm tone are disabled. When the shielding period is reached, alarm light and alarm tone are reactivated.
	Alarm in other medium priority chain	Alarm light and alarm tone

9.7.5.4 Setting Arrhythmia Refractory Periods

For some arrhythmias in the medium priority chain, an arrhythmia and arrhythmias with lower priority in the same alarm chain can be deactivated in a designated period of time. This period is called refractory period. When an arrhythmia is detected, the refractory period automatically starts. During the refractory period, the same alarm condition does not trigger an alarm. If the condition of an arrhythmia with lower priority in the same alarm chain appears, the monitor does not generate an alarm either.

To set arrhythmia refractory periods, follow this procedure:

1. Access arrhythmia alarm setup by either of the following ways:
 - ◆ Select the ECG numeric area or waveform area to enter the **ECG** menu → select the **Arrhythmia** tab.
 - ◆ Select the **Alarm Setup** quick key → select the **Arrhythmia** tab.
2. Select the **Threshold** tab.
3. Set **Refractory Period 1** and **Refractory Period 2**. The default refractory period 1 is 3 minutes. The default refractory period 2 is 10 minutes. To disable a refractory period, set it to **Off**.

See the figure of arrhythmia alarm chain in 9.7.5.1 *Arrhythmia Alarm Chains* for arrhythmias applying to Refractory Period 1 and Refractory Period 2.

NOTE

- **Refractory periods are only applicable to arrhythmias in the medium priority chains.**
- **Refractory periods have no impact on Tachy, Brady, HR High, HR Low, A-Fib/A-Fib End, Irr Rhythm/Irr Rhythm End.**

9.8 ST Segment Monitoring

ST monitoring is intended for adult, pediatric and neonatal patients.

9.8.1 ST Safety Information

WARNING

- **ST values may be affected by such factors as some drugs or metabolic and conduction disturbances.**
- **ST deviation is often calculated at a fixed offset from the J point. Changes in heart rate may affect ST.**

- **The significance of the ST segment changes must be decided by the physician.**

9.8.2 Enabling ST Monitoring

The ST monitoring function is disabled by default. Before you start ST monitoring, enable the ST function. To do so, follow this procedure:

1. Select the ECG numeric area or waveform area to enter the **ECG** menu.
2. Select the **ST** tab → select the **Setup** tab.
3. Switch on **ST Analysis**.

ST analysis may not be reliable under the following situations. Consider switching off ST analysis in these cases:

- The patient is implanted with a ventricular pacemaker.
- The patient has left bundle branch block.
- Arrhythmias such as atrial fibrillation or flutter occur, which may cause irregular baseline.
- All ECG leads are noisy.

9.8.3 Displaying ST Numerics

To display ST numerics and Segments, follow this procedure:

1. Access **Tile Layout** by either of the following ways:
 - ◆ Select the **Screen Setup** quick key → select the **Tile Layout** tab.
 - ◆ Select **Main Menu** hard key or quick key → from the **Display** column select **Tile Layout**.
2. Click the numeric area where you want to display the ST numerics, and then select **ECG** → **ST**.

The display of ST parameters area is different according to the lead type:

- When you are using the 3-lead ECG leadwires, the ST numeric area does not display. A ST value displays in the ECG numeric area.
- When you are using the 5-lead ECG leadwires, the ST numeric area displays 7 ST values: ST-I, ST-II, ST-III, ST-aVR, ST-aVL, ST-aVF, ST-V.
- When you are using the 6-lead ECG leadwires, the ST numeric area displays 8 ST values: ST-I, ST-II, ST-III, ST-aVR, ST-aVL, ST-aVF, ST-Va, ST-Vb.
- When you are using the 6-lead ECG placement to derive 12-lead ECG (D12L), the ST numeric area displays 12 ST values: ST-I, ST-II, ST-III, ST-aVR, ST-aVL, ST-aVF, ST-V1, ST-V2, ST-V3, ST-V4, ST-V5, ST-V6, in which two chest leads are directly measured and four are derived. The derived leads are marked with a "d" in front of the lead label, for example "dV1".
- When you are using the 12-lead ECG leadwires, the ST numeric area displays 12 ST values: ST-I, ST-II, ST-III, ST-aVR, ST-aVL, ST-aVF, ST-V1, ST-V2, ST-V3, ST-V4, ST-V5, ST-V6.

This example shows the ST numeric area when 5-lead ECG cable is used.

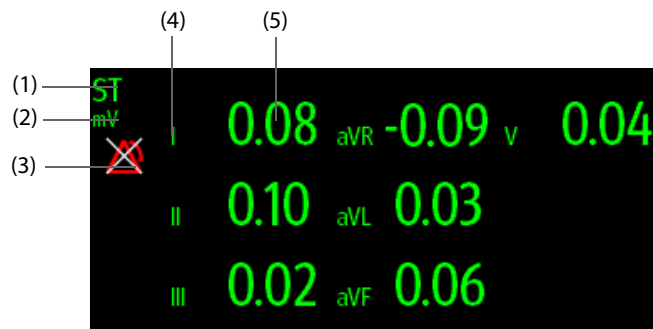

(1) Parameter label. When 6-lead placement is used to derive 12-lead ECG (D12L), all derived leads are marked with a "d" in front of the lead label, for example "dV1".

(2) ST unit

(3) ST alarm off symbol

(4) Lead labels

(5) ST numerics: a positive value indicates ST segment elevation, and a negative value indicates ST segment depression.

9.8.4 Displaying ST Segments in the Waveform Area

You can display ST segments in the waveform area. To do so, follow this procedure:

1. Access **Tile Layout** by either of the following ways:
 - ◆ Select the **Screen Setup** quick key → select the **Tile Layout** tab.
 - ◆ Select **Main Menu** hard key or quick key → from the **Display** column select **Tile Layout**.
2. Select the waveform area where you want to display the ST segments, and then select **ECG** → **ST Segment**.

The waveform area displays the current and baseline ST segments. It also displays the current and baseline ST values. In the following picture, the current ST segment and value are in green, while the baseline ST segment and value are in white.

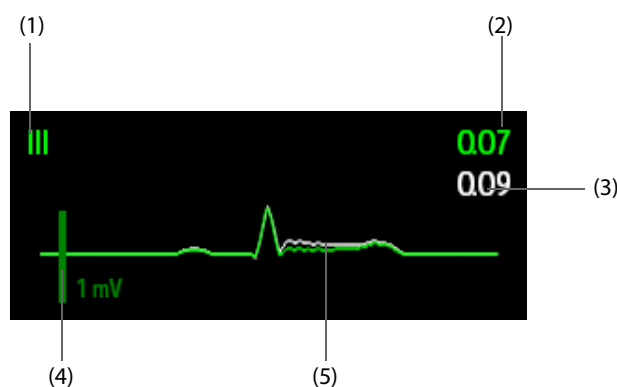

- | | |
|--|----------------------|
| (1) ST lead | (2) Current ST value |
| (3) Baseline ST value | (4) 1 mV scale |
| (5) Current ST segment (green) and baseline ST segment (white) | |

9.8.5 Entering the ST View

The ST View shows a complete QRS segment for each ST lead. The color of current ST segments and ST values is consistent with the color of ECG waveforms, normally green. The color of baseline ST segments and ST values is white.

You can enter the ST view either by selecting the ST segment in the waveform area or by the following ways:

1. Select the ST numeric area, ECG numeric area, or ECG waveform area to enter the **ECG** menu.
2. Select the **ST** tab.
3. From the bottom of the menu, select **ST View**.

NOTE

- In the ST view, the derived leads are marked with a "d" in front of the lead label, for example "dV1".

9.8.6 Saving the Current ST as Baseline

ST deviation is typically monitored as a relative change from a baseline value. Set an ST baseline when ST values become stable. If you did not set the ST baseline, the monitor automatically saves the baseline when valid ST values appear for 5 minutes. To set the ST baseline, follow this procedure:

1. From the **ST View** window, select **Set Baseline**.
2. From the pop-up dialog box, select **OK** to set the current ST segments and values as the baseline.

From the **ST View** window, you can also perform the following operations:

- Display or hide ST baseline by selecting **Display Baseline** or **Hide Baseline**.
- Display or hide the position of ISO point, J point and ST point by selecting **Display Marker** or **Hide Marker**.

CAUTION

- **Updating ST baseline affects ST alarms.**

NOTE

- **If you set the ST baseline with D12L enabled, the baseline time is followed by “(D12L)”, for example “Baseline 2017-04-06 20:30 (D12L)”.**

9.8.7 Entering the ST Graphic Window

To display **ST Graphic** window, follow this procedure:

1. Select ST numeric area, ECG numeric area, or ECG waveform area to enter the **ECG** menu.
2. Select the **ST** tab.
3. From the bottom of the menu, select **ST Graphic**.

The following figure shows the ST Graphic when **ST Alarm Mode** is set to **Absolute**. The height of the bar indicates the ST value of corresponding ST lead. The color of the bar indicates ST alarm status: green indicates that corresponding ST value is within alarm limits; yellow and red indicate that the ST value exceeds the alarm limits. The color matches ST alarm priority.

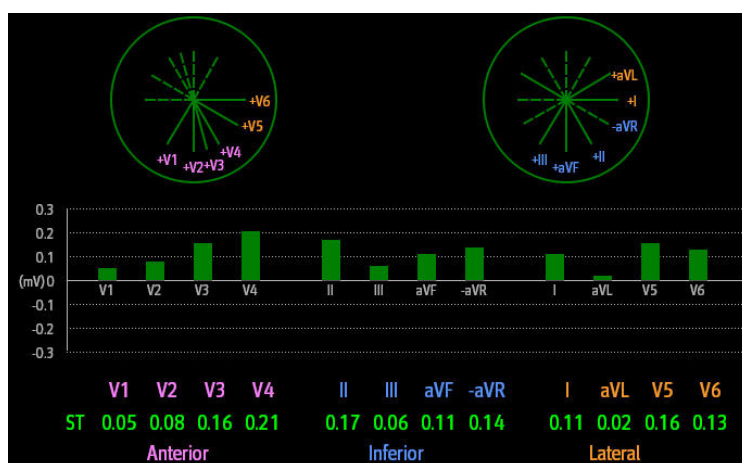

The following figure shows the ST Graphic when **ST Alarm Mode** is set to **Relative**. The height of grey bar indicates the baseline ST value and the green bar (yellow or red if an alarm occurs) indicates Δ ST.

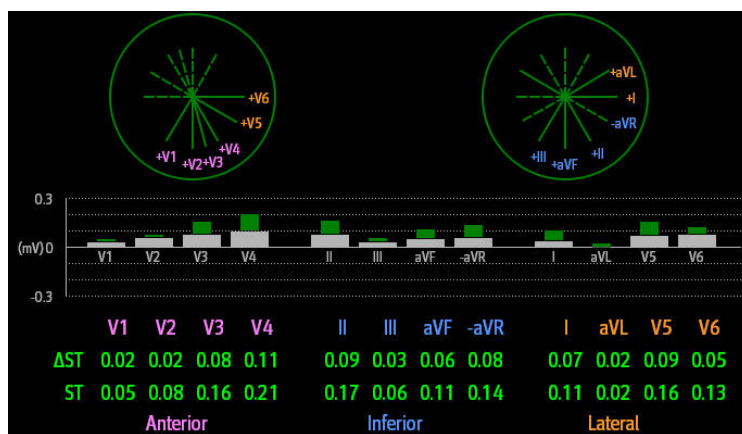

NOTE

- In the ST Graphic, the derived leads are marked with a “d” in front of the lead label, for example “dV1”.

9.8.8 Changing ST Settings

9.8.8.1 Setting ST Alarm Properties

To set ST alarm properties, follow this procedure:

1. Select the ST numeric area, ECG numeric area, or ECG waveform area to enter the **ECG** menu.
2. Select the **ST** tab → **Alarm** tab.
3. Set **ST Alarm Mode** to **Absolute** or **Relative**.
 - ◆ **Absolute**: you can separately set the alarm properties for each ST alarm.
 - ◆ **Relative**: you can set the alarm properties for **ST Single** and **ST Dual** alarms.
4. Set ST alarm properties.

9.8.8.2 Changing Leads for ST Display

The monitor automatically selects the three most deviated leads for ST display. You can also manually select the leads. To do so, follow this procedure:

1. Select the ST numeric area, ECG numeric area, or ECG waveform area to enter the **ECG** menu.
2. Select the **ST** tab → select the **Setup** tab.
3. Set **ST Segment**. You can select up to 3 leads.

9.8.8.3 Showing ISO Point, J Point, and ST Point Marks

In the waveform area, the ISO point, J point, and ST point mark do not display on the ST segments by default. To show these marks, follow this procedure:

1. Select the ST numeric area, ECG numeric area, or ECG waveform area to enter the **ECG** menu.
2. Select the **ST** tab → select the **Setup** tab.
3. Switch on **Show Markers**.

9.8.9 ST Point, ISO Point, and J Point

The following figure shows the position of ST point, isoelectric (ISO) point, and J point:

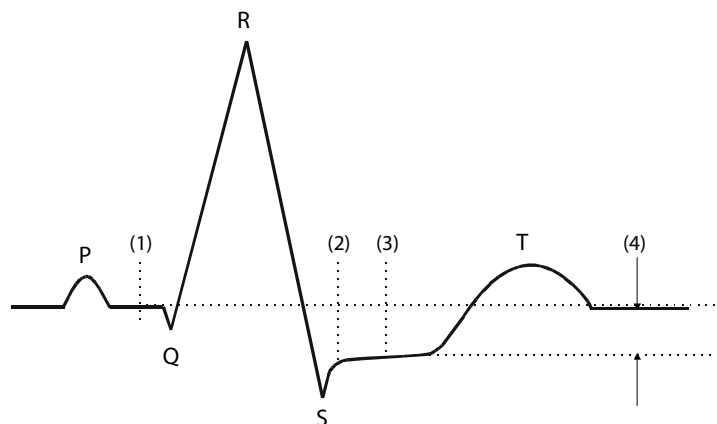

- (1) ISO point: is located between the end of the P-wave and the onset of the QRS complex. The ISO point provides the baseline for ST deviation measurement.
- (2) J point: is located at the end of the QRS complex. The distance between the J point and ST point is fixed. So it helps correctly position the ST point.

- (3) ST point: is located at the midpoint of the ST segment.
- (4) ST deviation (ST elevation or depression): is the potential difference between the ISO point and the ST point.

9.8.9.1 Setting ST Point, ISO Point, and J Point

Make sure that the position of the ST point is correctly set for the patient. Incorrect setting of ST point may result in artifactual ST deviation. Adjust the ST point before starting monitoring, or if the patient's heart rate or ECG morphology changes dramatically.

To set ST point, ISO point, and J point, follow this procedure:

1. Select the ST numeric area, ECG numeric area, or ECG waveform area to enter the **ECG** menu.
2. Select the **ST** tab→ select the **Adjust** tab.
3. Set **ST Point**. The ST point is positioned a fixed distance from the J point. When **J+60/80ms** is selected, the ST point is positioned either 80 ms (HR≤120 bpm) or 60 ms (HR>120 bpm) from the J point.

The setting of **Auto Adjust** defines the method of adjusting the ISO point and J point. **Auto Adjust** is enabled by default. In this case, positions of ISO point and J point are automatically adjusted accordingly. If you disable when **Auto Adjust**, you need to manually adjust the position of ISO point and J point by selecting the arrows at the right sides of **ISO** and **J**.

- Put the ISO point in the middle of the flattest part between the P and Q waves.
- Put the J point at the end of the QRS complex and the beginning of the ST segment.

CAUTION

- **Make sure that the position of the ST point is correctly set for the patient. Incorrect setting of ST point may result in artifactual ST deviation. Adjust the ST point before starting monitoring, or if the patient's heart rate or ECG morphology changes dramatically.**
-

9.9 QT/QTc Interval Monitoring

The QT interval is from the beginning of the Q wave to the end of the T wave. QTc is the HR corrected QT interval. Monitoring QT interval helps detect the long QT syndrome.

QT/QTc interval monitoring is intended for adult, pediatric and neonatal patients.

9.9.1 QT/QTc Monitoring Limitations

Some conditions may make it difficult to achieve reliable QT/QTc monitoring, for example:

- R-wave amplitudes are too low
- The presence of frequent ventricular ectopic beats
- Unstable RR intervals
- P-waves tending to encroach on the end of the previous T-wave at high heart rates
- The T-wave is very flat or T-wave are not well defined
- The end of the T-wave is difficult to delineate because of the presence of U-waves
- QTc measurements are not stable
- In the presence of noise, asystole, ventricular fibrillation, atrial fibrillation, and ECG lead off

For these cases you should select a lead with good T-wave amplitude and no visible flutter activity, and without a predominant U-wave or P-wave.

Some conditions such as left or right bundle branch block or hypertrophy can lead to a widened QRS complex. If a long QTc is observed you should verify it to ensure that it is not caused by QRS widening.

Because normal beats followed by ventricular beats are not included in the analysis, no QT measurement will be generated in the presence of a bigeminy rhythm.

If the heart rate is extremely high (over 150bpm for adults and over 180bpm for pediatrics and neonates), QT will not be measured. When the heart rate changes, it can take several minutes for the QT interval to stabilize. For reliable QTc calculation it is important to avoid measurements when the heart rate is changing.

9.9.2 Enabling QT/QTc Monitoring

The QT monitoring function is disabled by default. Before you start QT monitoring, enable the QT function. To do so, follow this procedure:

1. Select the QT numerics area, ECG numeric area, or waveform area to enter the **ECG** menu.
2. Select the **QT** tab → select the **Setup** tab.
3. Switch on **QT Analysis**.

9.9.3 Displaying QT/QTc Numerics and Segments

To display QT/QTc numerics and Segments, follow this procedure:

1. Access **Tile Layout** by either of the following ways:
 - ◆ Select the **Screen Setup** quick key → select the **Tile Layout** tab.
 - ◆ Select **Main Menu** hard key or quick key → from the **Display** column select **Tile Layout**.
2. Click the parameter numeric area where you want to display the QT numerics, and then select **ECG** → **QT/QTc**.

NOTE

- **QTc values are calculated based on the QT-HR, not the ECG HR. For more information, see 9.9.4 Entering the QT View.**

The following picture shows the QT numeric area.

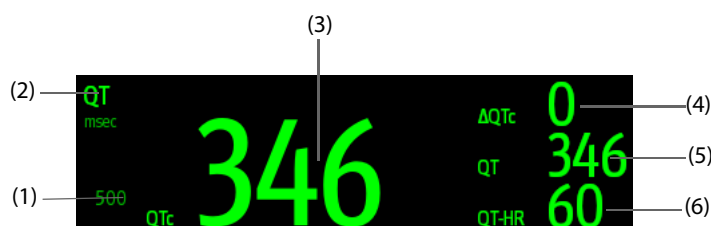

- (1) QTc alarm limit (if QTc alarm is off, the alarm off symbol is displayed)
- (2) Parameter label
- (3) QTc value
- (4) Δ QTc value (the difference between the current and baseline QTc values)
- (5) QT value
- (6) QT-HR value

NOTE

- **The display of the QT numeric area differs as related settings change.**

9.9.4 Entering the QT View

QT View shows the current and baseline QT parameter values and waveforms. To enter the QT View, follow this procedure:

1. Select the QT numerics area, ECG numeric area, or waveform area to enter the **ECG** menu.
2. Select the **QT** tab.
3. From the bottom of the menu, select **QT View**.

The following picture shows the QT view.

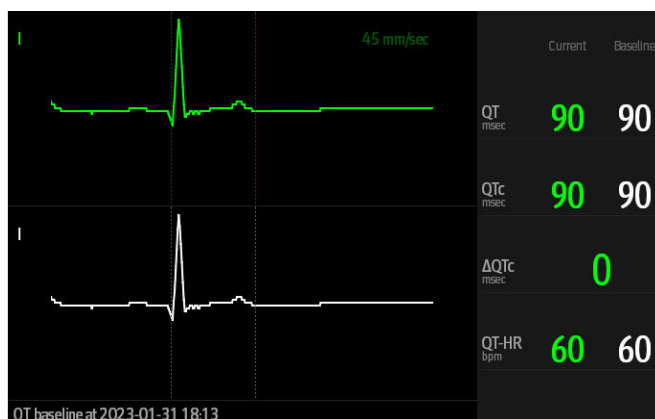

- The current waveform is shown in the upper half in green.
- The baseline waveform is shown below in white.
- The start of QRS complex and the end of the T wave are marked with a vertical line.
- In some conditions, no QT measurement can be calculated. Then the cause of failed QT measurement is shown at the bottom of the QT numerics area and the message "Cannot Analyze QT" is shown in the technical alarm area.

Select the left or right arrow to switch leads. Corresponding waveform will be highlighted.

NOTE

- In the QT view, the derived leads are marked with a "d" in front of the lead label, for example "dV1".

9.9.5 Saving the Current QTc as Baseline

In order to quantify differences in the QTc value, you can set a QTc baseline. If you do not set a baseline within the first five minutes after getting valid QT values, the monitor will automatically set a baseline for this patient.

1. From the **QT View** window, select **Set Baseline**.
2. From the pop-up dialog box, select **OK**.

This baseline will then be used to calculate Δ QTc and the old baseline will be discarded.

From the **QT View** window, you can also perform the following operations:

- Select the left or right arrow to select a lead label to highlight corresponding waveform.
- Select **Display Baseline** or **Hide Baseline** to display or hide baseline waveform.

CAUTION

- Updating QTc baseline affects Δ QTc value and alarm.

9.9.6 Changing QT Settings

9.9.6.1 Setting QT Alarm Properties

To set QT alarm properties, follow this procedure:

1. Select the QT numerics area, ECG numeric area, or ECG waveform area to enter the **ECG** menu.
2. Select the **QT** tab → select the **Alarm** tab.
3. Set QTc and Δ QTc alarm properties.

9.9.6.2 Selecting Leads for QT Calculation

You can select one lead or all leads for QT calculation. To do so, follow this procedure:

1. Select the QT numerics area, ECG numeric area, or ECG waveform area to enter the **ECG** menu.
2. Select the **QT** tab→ select the **Setup** tab.
3. Set **QT Leads**. All is selected by default. This means all leads are used for QT calculation.

9.10 ECG Relearning

Changes in ECG template could result in incorrect arrhythmia alarms and/or inaccurate heart rate. ECG relearning allows the monitor to learn new ECG template so as to correct arrhythmia alarms and HR value. Once learning is complete, the dominant QRS complex is stored as a reference template. The reference template is used as a normal morphology of that patient and it is compared with incoming beats to identify possible arrhythmias.

9.10.1 Auto ECG Relearning

Auto arrhythmia relearning happens in the following situation:

- The ECG lead type or lead label is changed.
- ECG leads are off and are not reconnected within 60 seconds.
- The patient's paced status is changed.

9.10.2 Manually Initiating an ECG Relearning

If you suspect that abnormal arrhythmia alarms are presented, you may need to manually initiate an ECG relearning. To do so, follow this procedure:

1. Select the ECG numeric area or waveform area to enter the **ECG** menu.
2. Select **Relearn** at the bottom left corner of the menu.

CAUTION

- **Initiate ECG relearning only during periods of predominantly normal rhythm and when ECG signal is relatively free of noise. If ECG relearning occurs during arrhythmia, abnormal QRS complex may be incorrectly learned as normal QRS complex, resulting in missed detection of subsequent arrhythmia.**
-

9.11 Calibrating ECG

The ECG signal may be inaccurate due to hardware or software problems. As a result, the ECG waveform amplitude becomes greater or smaller. In that case, you need to calibrate the ECG module. For more information, see 23.6.1 *The ECG Tab*.

9.12 Defibrillation Synchronization Pulse Output

The monitor provides an analog out connector to output defibrillation synchronization pulse. If a defibrillator is connected, it receives a synchronization pulse (100 ms, +5 V) through the analog out connector each time an R-wave is detected.

WARNING

- **Improper use of a defibrillator may cause injury to the patient. The operator should determine whether to perform defibrillation or not according to the patient's condition.**
 - **Before defibrillation, the user must ensure both defibrillator and monitor have passed the system test and can be safely used together.**
-

9.13 ECG Troubleshooting

This section lists the problems that might occur. If you encounter problems when using the monitor or accessories, check the table below before requesting for services. If the problem persists after you have taken corrective actions, contact your service personnel.

Problem	Corrective Actions
Do not see ECG numeric area or waveform area on the main screen	<ol style="list-style-type: none"> 1. Check that ECG is set to display in the Screen Setup menu. For more information, see 3.11.2 <i>Displaying Parameter Numerics and Waveforms</i>. 2. Check that if the ECG parameter switch is enabled. If not, enable the ECG measurement. For more information, see 3.11.1 <i>Switching On or Off a Parameter</i>. 3. Check that the cable connections of ECG electrode and the lead set are tight. Replace the ECG electrode or the lead set if needed.
Noisy ECG traces	<ol style="list-style-type: none"> 1. Check that electrodes are not detached or dry. Replace with fresh and moist electrodes if necessary. 2. Check that leadwires are not defective. Replace leadwires if necessary. 3. Check that patient cable or leadwires are routed too close to other electrical devices. Move the patient cable or leadwires away from electrical devices.
Excessive electrosurgical Interference	Use ESU-proof ECG cables. For more information, see 27.1 <i>ECG Accessories</i> .
Muscle Noise	<p>Inadequate skin preparation, tremors, tense subject, and/or poor electrode placement.</p> <ol style="list-style-type: none"> 1. Perform skin preparation again and re-place the electrodes. For more information, see 9.4.1 <i>Preparing the Patient Skin</i> and 9.4.2 <i>Applying Electrodes</i>. 2. Apply fresh, moist electrodes. Avoid muscular areas.
Intermittent Signal	<ol style="list-style-type: none"> 1. Check that cables are properly connected. 2. Check that electrodes are not detached or dry. Perform skin preparation again as described in 9.4.1 <i>Preparing the Patient Skin</i> and apply fresh and moist electrodes. 3. Check that the patient cable or leadwires are not damaged. Change them if necessary.
Excessive alarms: heart rate, lead fault	<ol style="list-style-type: none"> 1. Check that electrodes are not dry. Perform skin preparation again and re-place the electrodes. For more information, see 9.4.1 <i>Preparing the Patient Skin</i> and 9.4.2 <i>Applying Electrodes</i>. 2. Check for excessive patient movement or muscle tremor. Reposition the electrodes. Replace with fresh and moist electrodes if necessary.
Low Amplitude ECG Signal	<ol style="list-style-type: none"> 1. Check that the ECG gain is not set too low. Adjust the gain as required. For more information, see 9.6 <i>Changing ECG Settings</i>. 2. Perform skin preparation again and re-place the electrodes. For more information, see 9.4.1 <i>Preparing the Patient Skin</i> and 9.4.2 <i>Applying Electrodes</i>. 3. Check electrode application sites. Avoid bone or muscular area. 4. Check that electrodes are not dry or used for a prolonged time. Replace with fresh and moist electrodes if necessary.
No ECG Waveform	<ol style="list-style-type: none"> 1. Check that the ECG gain is not set too low. Adjust the gain as required. For more information, see 9.6.4 <i>Changing ECG Wave Settings</i>. 2. Check that the leadwires and patient cables are properly connected. 3. Change cable and lead wires. 4. Check that the patient cable or leadwires are not damaged. Change them if necessary.
Base Line Wander	<ol style="list-style-type: none"> 1. Check for excessive patient movement or muscle tremor. Secure leadwires and cable. 2. Check that electrodes are not detached or dry and replace with fresh and moist electrodes if necessary. For more information, see 9.4.1 <i>Preparing the Patient Skin</i> and 9.4.2 <i>Applying Electrodes</i>. 3. Check for ECG filter setting. Set ECG Filter mode to Monitor to reduce baseline wander on the display.

10 Resting 12-Lead ECG Analysis

10.1 Resting 12-Lead ECG Analysis Introduction

The monitor can be configured with Mindray 12-lead ECG analysis algorithm.

The Mindray algorithm is intended for adult patients only.

The monitor providing the 12-lead ECG analysis function has a 12-lead label.

10.2 Entering the 12-Lead Screen

To enter the 12-Lead screen, follow this procedure:

1. Select the ECG numeric area or waveform area to enter the **ECG** menu.
2. Select the **Setup** tab.
3. Set the **Lead Set** to **12-Lead**.
4. From the bottom of the **ECG** menu, select **12-Lead**.

You can also enter the 12-Lead screen by following this procedure:

- Select the **Screen Setup** quick key → select **Choose Screen** → select **ECG 12-Lead**.
- Select **Main Menu** quick key → from the **Display** column select **Choose Screen** → select **ECG 12-Lead**.

10.3 Initiating Resting 12-Lead ECG Analysis

Before 12-lead ECG interpretation, check that all electrodes are correctly connected to the lead wires and the ECG trunk cable is properly connected. Check that patient information is correct. Keep the patient still.

To initiate 12-Lead ECG analysis, select **Analyze** from the left bottom of the 12-Lead screen.

10.4 Changing 12-Lead ECG Analysis Settings

On the ECG 12-Lead screen, you can set the baseline drift removal (BDR) switch.

The baseline drift removal (BDR) suppresses most baseline drift interference and also is able to preserve the fidelity of the ST-segment level. BDR is switched on by default. To set the BDR, follow this procedure:

1. On the ECG 12-Lead screen, select the ECG numeric area or waveform area to enter the **ECG** menu.
2. Select the **Setup** tab.
3. Switch on or off **Baseline Drift Removal**. If BDR is switched off, the 0.05 Hz high pass filter is used.

NOTE

- **BDR introduces around 1-second delay. We recommend using BDR except when the delay is unacceptable.**

10.5 Saving the 12-Lead Interpretation Report

At the completion of 12-lead ECG interpretation, select **Save** to save the report. You can review the saved 12-lead interpretation reports. For more information, see *18.2.10 12-Lead ECG Review Page*.

10.6 Printing the 12-Lead Interpretation Report

At the completion of 12-lead ECG interpretation, select **Print** or **Record** to output the report via the printer or recorder.

10.7 Exiting the ECG 12-Lead Screen

To exit the ECG 12-Lead screen, select **Exit** on the ECG 12-Lead screen.

11 Monitoring Respiration (Resp)

11.1 Resp Introduction

Impedance respiration is measured across the thorax. When the patient is breathing or ventilated, the volume of air changes in the lungs, resulting in impedance changes between the electrodes. Respiration rate (RR) is calculated from these impedance changes, and a respiration waveform appears on the patient monitor screen.

Respiration monitoring is intended for adult, pediatric and neonatal patients.

11.2 Resp Safety Information

WARNING

- **When monitoring the patient's respiration, do not use ESU-proof ECG cables. The respiration measurement does not recognize the cause of apneas. It only indicates an alarm if no breath is detected when a pre-adjusted time has elapsed since the last detected breath. Therefore, it cannot be used for diagnostic purpose.**
- **The impedance respiration measurement may cause rate changes in Minute Ventilation Rate Responsive Pacemakers. Set the pacemaker rate responsive mode off or disable the impedance respiration measurement on the monitor.**
- **When using the electrosurgery unit, ensure proper contact of the ESU return electrode to the patient to avoid burns at monitor measurement sites. Also ensure that the ESU return electrode is near the operating area.**

CAUTION

- **Only use parts and accessories specified in this manual.**
- **Respiration monitoring is not for use on the patients who are very active, as this will cause false alarms.**

11.3 Resp Display

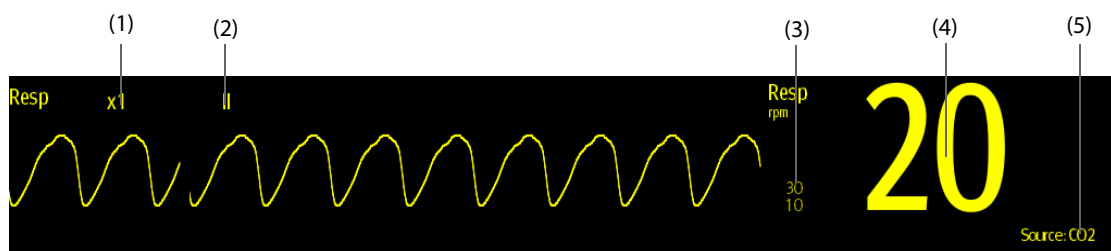

(1) Resp waveform gain

(2) Resp lead label

(3) Alarm limits

(4) Respiration rate (RR)

(5) RR source

NOTE

- **If ESU-proof ECG cables are used, the Resp waveform area will display the message "Check Leads". Replace the ECG cable if necessary.**

11.4 Preparing for Resp Monitoring

11.4.1 Preparing the Patient

Follow this procedure to prepare the patient:

1. Shave hair from skin at chosen sites.
2. Gently rub skin surface at sites to remove dead skin cells.
3. Thoroughly cleanse the site with a mild soap and water solution.
4. Dry the skin completely before applying the electrodes.

CAUTION

- **Proper skin preparation is necessary for good signal quality at the electrode site, as the skin is a poor conductor of electricity.**
-

11.4.2 Placing the Electrodes

As the Respiration measurement adopts the standard ECG electrode placement, you can use different ECG cables. Since the respiration signal is measured between two ECG electrodes, if a standard ECG electrode placement is applied, the two electrodes should be RA and LA of ECG Lead I, or RA and LL of ECG Lead II.

For more information, see *9.4.4 ECG Electrode Placement*.

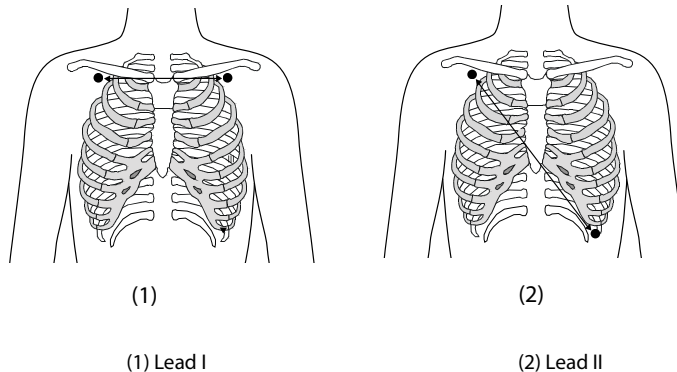

CAUTION

- **To reduce cardiovascular artifact, apply the respiration electrodes so that the liver area and the ventricles of the heart are not in the line between the respiratory electrodes. This is especially important for neonatal patients.**
 - **To optimize the respiration waveform, place the RA and LA electrodes horizontally when monitoring respiration with ECG Lead I; place the RA and LL electrodes diagonally when monitoring respiration with ECG Lead II.**
 - **To optimize respiratory waveforms for patients breathing mainly abdominally, apply the LL electrode on the left abdomen at the point of maximum abdominal expansion.**
 - **For patients expand chests laterally (normally neonatal patients), to avoid negative intrathoracic pressure and optimize respiratory waveforms, respectively apply the electrodes in the right midaxillary and the left lateral chest areas at the maximum point of the breathing movement.**
 - **Periodically inspect the electrode application site to ensure skin quality. If the skin quality changes, replace the electrodes or change the application site.**
-

NOTE

- **Store the electrodes at room temperature. Open the electrode package immediately prior to use.**
 - **Check that the electrode packages are intact and not expired. Make sure the electrode gel is moist.**
-

11.5 Changing Resp Settings

11.5.1 Setting the Resp Alarm Properties

To set the Resp alarm properties, follow this procedure:

1. Select the Resp numeric area or waveform area to enter the **Resp** menu.
2. Select the **Alarm** tab.
3. Enter the password if required.
4. Set alarm properties as desired.

NOTE

- **You can switch off the apnea alarm only when Apnea Alarm Off is enabled. For more information, see 8.6.8 Setting the Switch of the Apnea Alarm Off.**

11.5.2 Setting the RR Source

To set the RR source, follow this procedure:

1. Select the Resp numeric area or waveform area to enter the **Resp** menu.
2. Select the **Setup** tab.
3. Choose **RR Source** from the dropdown list.

When you select **Auto**:the system automatically selects between CO₂ and ECGaccording to the priority. The priority of RR source is first CO₂, and then ECG.

CAUTION

- **When RR source is SpO₂, apnea alarms cannot be detected.**
- **The following factors may influence the accuracy of RR measurement sourcing from SpO₂: low perfusion; excessive motion on the measurement site; arrhythmia; RR signal too weak to be detected in the pleth waveform.**

NOTE

- **RR measurement sourcing from SpO₂ is intended for only adults.**

11.5.3 Choosing the Respiration Lead

To set the respiration lead, follow this procedure:

1. Select the Resp numeric area or waveform area to enter the **Resp** menu.
2. Select the **Setup** tab.
3. Set **Resp Lead**.

If you cannot get optimal Resp waveform or you suspect the Resp value after choosing the Resp lead, you may need to optimize the electrode placement.

11.5.4 Setting the Resp Waveform Size

To set the Resp waveform size, follow this procedure:

1. Select the Resp numeric area or waveform area to enter the **Resp** menu.
2. Select the **Setup** tab.
3. Set **Gain**.

11.5.5 Setting the Resp Waveform Speed

To set the Resp waveform speed, follow this procedure:

1. Select the Resp numeric area or waveform area to enter the **Resp** menu.
2. Select the **Setup** tab.
3. Set **Speed**.

11.5.6 Setting the Auto Detection Switch

To set the auto detection switch, follow this procedure:

1. Select the Resp numeric area or waveform area to enter the **Resp** menu.
2. Select the **Setup** tab.
3. Switch on or off **Auto Threshold Detection**.
 - ◆ If **Auto Threshold Detection** is switched on, the monitor automatically adjusts the Resp waveform detection level, or threshold.
 - ◆ If **Auto Threshold Detection** is switched off, you have to manually adjust the Resp waveform threshold. For more information, see *11.5.7 Adjusting the Resp Waveform Detection Threshold*.

In the auto detection mode, if ECG is switched off when you are monitoring respiration, the monitor cannot compare ECG and RR to detect cardiovascular artifact. To avoid cardiovascular artifact being interpreted as respiration, the respiration threshold is automatically set higher.

11.5.7 Adjusting the Resp Waveform Detection Threshold

It is recommended to use the manual detection mode in the following situations:

- The patient has intermittent mandatory ventilation.
- The patient's respiration is weak.
- The patient's RR is close to HR.

To set the Resp waveform threshold to the desired level, follow this procedure:

1. Select the Resp numeric area or waveform area to enter the **Resp** menu.
2. Select the **Threshold** tab.
3. Select the up and down arrows below **Upper Line** and **Lower Line** to define the Resp waveform threshold.

Once you set the Resp waveform threshold, it will not automatically adapt to different respiration depths. In the manual detection mode, cardiovascular artifact can be mistakenly interpreted as respiration in certain situations. This results in higher respiration rate or undetected apnea. If you suspect the RR reading, adjust the Resp waveform threshold to raise the detection level. If you cannot adjust threshold because the Resp waveform is too small, consider optimize the electrode placement.

CAUTION

- **Always remember that if the depth of breathing changes, you may need to change the detection level.**
 - **In the manual detection mode, if the respiration threshold is not correctly set, an apnea may not be detected. When the respiration threshold is set too low, the monitor may falsely interpret cardiac activity as respiratory activity in the case of apnea.**
-

11.6 Resp Troubleshooting

For more information, see *D Alarm Messages*.

12 Monitoring Pulse Oxygen Saturation (SpO₂)

12.1 SpO₂ Introduction

Pulse Oxygen Saturation (SpO₂) monitoring is a non-invasive technique used to measure the amount of oxygenated haemoglobin and pulse rate by measuring the absorption of selected wavelengths of light. The light generated in the emitter side of the probe is partly absorbed when it passes through the monitored tissue. The amount of transmitted light is detected in the detector side of the probe. When the pulsative part of the light signal is examined, the amount of light absorbed by the haemoglobin is measured and the pulse oxygen saturation can be calculated. This device is calibrated to display functional oxygen saturation.

SpO₂ monitoring is intended for adult, pediatric and neonatal patients.

NOTE

- **The SpO₂ extension cable should be compatible with the SpO₂ connectors. For example, you can only the Mindray SpO₂ extension cable to the Mindray SpO₂ connectors.**
 - **Measurement accuracy verification: The SpO₂ accuracy has been verified in human experiments by comparing with arterial blood sample reference measured with a CO-oximeter. Pulse oximeter measurements are statistically distributed and about two-thirds of the measurements are expected to come within the specified accuracy range compared to CO-oximeter measurements.**
 - **A functional tester or SpO₂ simulator can be used to determine the pulse rate accuracy.**
 - **A functional tester or SpO₂ simulator cannot be used to assess the SpO₂ accuracy.**
-

12.2 SpO₂ Safety Information

WARNING

- **If the patient has a trend of deoxygenation, analyze the blood samples with a laboratory CO-oximeter to completely understand the patient's condition.**
 - **Do not use the monitor or SpO₂ sensors during MRI scanning or in an MRI environment. Induced current could potentially causes burns. The monitor may affect the MRI image, and the MRI device may affect the accuracy of the SpO₂ measurements.**
 - **Prolonged continuous monitoring may increase the risk of undesirable changes in skin characteristics, such as irritation, reddening, blistering or burns. Inspect the sensor site every two hours and move the sensor if the skin quality changes. Change the application site every four hours. For neonates, or patients with poor peripheral blood circulation or sensitive skin, inspect the sensor site more frequently.**
 - **If the sensor is too tight because the application site is too large or becomes too large due to edema, excessive pressure for prolonged periods may result in venous congestion distal from the application site, leading to interstitial edema and tissue ischemia.**
 - **When patients are undergoing photodynamic therapy they may be sensitive to light sources. Pulse oximetry may be used only under careful clinical supervision for short time periods to minimize interference with photodynamic therapy.**
 - **Setting alarm limits to extreme values may cause the alarm system to become ineffective. For example, high oxygen levels may predispose a premature infant to retrolental fibroplasia. Setting the SpO₂ high alarm limit to 100% is equivalent to switching off the SpO₂ alarm.**
 - **SpO₂ is empirically calibrated in healthy adult volunteers with normal levels of carboxyhemoglobin (COHb) and methemoglobin (MetHb).**
 - **To protect from electric shock, always remove the sensor and completely disconnect the pulse oximeter before bathing the patient.**
 - **The pulse oximeter function of the bedside monitor should not be used for apnea monitoring.**
-

- The pulse oximeter function of the bedside monitor should not be used for arrhythmia analysis.

CAUTION

- Change the application site or replace the sensor and/or patient cable when a persistent “SpO₂ Low Signal Quality” message is displayed on the equipment. These messages may indicate that patient monitoring time is exhausted on the patient cable or sensor.
 - Replace the cable or sensor when a “SpO₂ Sensor Off”, “SpO₂ No Sensor”, or “SpO₂ Low Signal Quality” message is consistently displayed while monitoring consecutive patients after completing troubleshooting steps listed in this manual.
 - Variation in measurements may be profound and may be affected by sampling technique as well as the patient's physiological conditions. Any results exhibiting inconsistency with the patient's clinical status should be repeated and/or supplemented with additional test data. Blood samples should be analyzed by laboratory instruments prior to clinical decision making to completely understand the patient's condition.
 - Use only SpO₂ sensors specified in this manual. Follow the instructions for use delivered with the SpO₂ sensor.
 - Do not place the pulse oximeter where the controls can be changed by the patient.
 - If using pulse oximetry during full body irradiation, keep the sensor out of the radiation field. If the sensor is exposed to the radiation, the reading might be inaccurate or the device might read zero for the duration of the active irradiation period.
-

12.3 SpO₂ Measurement Limitations

The following factors may influence the accuracy of SpO₂ measurement:

- Patient physiological characteristics:
 - ◆ Cardiac arrest
 - ◆ Hypotension
 - ◆ Darkly pigmented skin
 - ◆ Shock
 - ◆ Severe vasoconstriction
 - ◆ Hypothermia
 - ◆ Severe anemia
 - ◆ Ventricular septal defects (VSDs)
 - ◆ Venous pulsations
 - ◆ Poor perfusion
 - ◆ Dysfunctional hemoglobin, such as carboxyhemoglobin (COHb) and methemoglobin (MetHb)
 - ◆ Elevated levels of bilirubin
 - ◆ Vasospastic disease, such as Raynaud's, and peripheral vascular disease
 - ◆ Hemoglobinopathies and synthesis disorders such as thalassemias, Hb s, Hb c, sickle cell, etc.
 - ◆ Hypocapnic or hypercapnic conditions
 - ◆ Birthmark(s), tattoos, skin discolorations, moisture on skin, deformed or abnormal fingers. etc.
- Interfering substances:
 - ◆ Intravascular dyes (such as indocyanine green, methylene blue, indigo carmine, etc.)
 - ◆ Dyes in the measure site, such as nail polish.
- Environmental conditions:
 - ◆ Excessive ambient light
 - ◆ Electrosurgery equipment
 - ◆ Defibrillation (may cause inaccurate reading for a short amount of time)
 - ◆ Excessive patient/sensor motion

- ◆ Electromagnetic field
- ◆ Arterial catheters and intra-aortic balloon
- Others
 - ◆ Inappropriate positioning of the SpO₂ sensor, or use of incorrect SpO₂ sensor
 - ◆ Cuff or arterial blood pressure measurement device on the same limb as the SpO₂ sensor.

12.4 SpO₂ Display

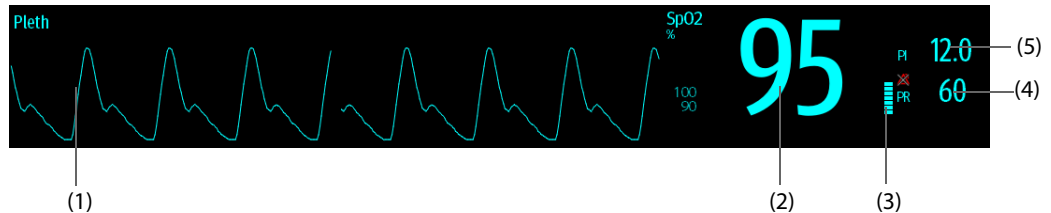

- (1) Pleth waveform (Pleth): indicates the blood pulsation at the measurement site. The waveform is not normalized.
- (2) Oxygen saturation of arterial blood (SpO₂): indicates the percentage of oxygenated hemoglobin relative to total hemoglobin.
- (3) Perfusion indicator: the pulsatile portion of the measured signal caused by arterial pulsation. The higher the bar, the better the perfusion quality.
- (4) Pulse rate: indicates the number of pulsations per minute.
- (5) Perfusion index (PI): indicates the percentage of pulsate signal to non pulsate signal. PI is an indicator of the pulsate strength. You can also use it to assess the SpO₂ signal strength.

For Mindray SpO₂ module,

- ◆ Above 1 is optimal.
- ◆ Between 0.3 and 1 is acceptable.
- ◆ Below 0.3 indicates low perfusion. Reposition the SpO₂ sensor or find a better site. If low perfusion persists, choose another method to measure oxygen saturation if possible.

12.5 Preparing for SpO₂ Monitoring

To prepare to monitor SpO₂, follow this procedure:

1. Select an appropriate sensor according to the module type, application site, patient category and weight.
2. Clean the contact surface of the reusable sensor.
3. Apply the sensor to the patient according to the instruction for use of the sensor.
4. Select an appropriate extension cable according to the connector type and plug the cable into the SpO₂ connector.
5. Connect the sensor to the extension cable.

CAUTION

- **Select proper SpO₂ sensor according to application site. Applying sensor too tight may severely obstruct circulation and lead inaccurate measurements. Loose application may result in measurement site exposing to ambient light.**
 - **Avoid placing the SpO₂ sensor on the same extremity with an NIBP cuff, arterial catheter, or intravascular line.**
 - **When monitoring SpO₂ at high ambient temperature, to avoid burns at the application site that is not well perfused, pay attention to prolonged SpO₂ sensor application.**
-

12.6 Changing the SpO₂ Settings

12.6.1 Changing the SpO₂ Alarm Settings

To change the SpO₂ alarm settings, follow this procedure:

1. Select the SpO₂ numeric area or waveform area to enter the **SpO2** menu.
2. Select the **Alarm** tab.
3. Enter the password if required.
4. Set the alarm properties of SpO₂ and SpO₂ Desat.

NOTE

- **You can switch off the SpO2 Desat alarm only when SPO2 Desat Alarm Off is enabled. For more information, see section 8.6.9 Setting the Switch of the SpO₂ Desat Alarm Off.**
-

12.6.2 Changing Sensitivity

The SpO₂ value displayed on the monitor screen is the average of data collected within a specific time. The shorter the averaging time is, the quicker the monitor responds to changes in the patient's oxygen saturation level. Contrarily, the longer the averaging time is, the slower the monitor responds to changes in the patient's oxygen saturation level, but the SpO₂ measurement is more stable. For critically ill patients, selecting shorter averaging time will help understanding the patient's state.

To set the averaging time, follow this procedure:

1. Select the SpO₂ numeric area or waveform area to enter the **SpO2** menu.
2. Select the **Setup** tab.
3. Set **Sensitivity**.

12.6.3 Showing/Hiding PI

You can set whether to display PI in the SpO₂ parameter area. To do so, follow this procedure:

1. Select the SpO₂ numeric area or waveform area to enter the **SpO2** menu.
2. Select the **Setup** tab.
3. Switch on or off **Display PI**.

12.6.4 Monitoring SpO₂ and NIBP Simultaneously

When monitoring SpO₂ and NIBP on the same limb simultaneously, you can switch on **NIBP Simul** to lock the SpO₂ alarm status until the NIBP measurement ends. If you switch off **NIBP Simul**, low perfusion caused by NIBP measurement may lead to inaccurate SpO₂ readings and therefore cause false physiological alarms.

To set the **NIBP Simul**, follow this procedure:

1. Select the SpO₂ numeric area or waveform area to enter the **SpO2** menu.
2. Select the **Alarm** tab.
3. Set **NIBP Simul**.

12.6.5 Changing the Sweep Speed of the Pleth Waveform

To set the sweep speed of Pleth waveform, follow this procedure:

1. Select the SpO₂ numeric area or waveform area to enter the **SpO2** menu.
2. Select the **Setup** tab.
3. Set **Speed**.

12.7 Changing the PR Settings

12.7.1 Changing the PR Alarm Settings

To change the PR alarm settings, follow this procedure:

1. Select the SpO₂ numeric area or waveform area to enter the **SpO2** menu.
2. Select the **PR Alarm** tab.
3. Enter the password if required.
4. Set the alarm properties as desired.

12.7.2 Changing the QRS Volume

If the **Alarm Source** is set to **PR**, the QRS tone is derived from PR measurements. To set the QRS volume, follow this procedure:

1. Select the SpO₂ numeric area or waveform area to enter the **SpO2** menu.
2. Select the **PR** tab.
3. Select the **Setup** tab.
4. Set **QRS Volume**.

If the SpO₂ value is effective, the monitor also adjusts the QRS tone (pitch tone) according to the SpO₂ value. For information, see 23.11 *The Other Settings*.

12.7.3 Setting the PR Source

You can select the source of PR. The current PR source is displayed in the PR numeric area. PR from the current source is monitored as system pulse and generates alarms when you select PR as alarm source.

To set which pulse rate as PR source, follow this procedure:

1. Select the SpO₂ numeric area or waveform area to enter the **SpO2** menu.
2. Select the **PR** tab.
3. Select the **Setup** tab.
4. Set **PR Source**.

The **PR Source** menu displays the currently available PR sources from top to bottom by priority. When you select **Auto**, the system will automatically select the first option as the PR source. If the current PR source is unavailable, the system will automatically switch **PR Source** to **Auto**. When you select **IBP**, the system will automatically select the first pressure label as the PR source.

12.7.4 Showing/Hiding PR

You can set whether to display the PR value in the SpO₂ parameter area. To do so, follow this procedure:

1. Select the SpO₂ numeric area or waveform area to enter the **SpO2** menu.
2. Select the **PR** tab.
3. Select the **Setup** tab.
4. Switch on or off **Display PR**.

12.8 SpO₂ Troubleshooting

This section lists the problems that might occur. If you encounter the problems when using the equipment or accessories, check the table below before requesting for services. If the problem persists, contact your service personnel.

NOTE

-
- For the physiological and technical alarm messages, see *D Alarm Messages*.
-

Problem	Solution
Do not see SpO ₂ numeric area or waveform area on the main screen	<ol style="list-style-type: none"> 1. Check that the SpO₂ is set to display in the Screen Setup menu. For more information, see 3.11.2 <i>Displaying Parameter Numerics and Waveforms</i>. 2. Check that if the SpO₂ parameter switch is enabled. If not, enable the SpO₂ measurement. For more information, see 3.11.1 <i>Switching On or Off a Parameter</i>. 3. Check that the cable connections of SpO₂ sensor and the extension cable are tight. Replace the SpO₂ sensor or the extension cable if needed.
Dashes "--" display in place of numerics.	<ol style="list-style-type: none"> 1. Check that the cable connections of SpO₂ sensor and the extension cable are tight. Replace the SpO₂ sensor or the extension cable if needed. 2. Reconnect the SpO₂ sensor if the alarm SpO2 Sensor Off appears. 3. Check the PI value. If the PI value is too low, adjust the SpO₂ sensor, or apply the sensor to the site with better perfusion. 4. Move the sensor to the place with weaker light, or cover the sensor with shade cloth if the alarm SpO2 Sensor Off appears.
Low amplitude SpO ₂ signal	<ol style="list-style-type: none"> 1. The SpO₂ sensor and NIBP cuff are placed on the same limb. Change a monitoring site if necessary. 2. Check the PI value. If the PI value is too low. Adjust the SpO₂ sensor, or apply the sensor to the site with better perfusion. 3. Check the sensor and its application site.
SpO ₂ value is inaccurate	<ol style="list-style-type: none"> 1. Check the patient's vital signs. 2. Check for conditions that may cause inaccurate SpO₂ readings. For more information, see 12.3 <i>SpO₂ Measurement Limitations</i>. 3. Check the monitor or the SpO₂ module for proper functioning.

13 Monitoring Temperature (Temp)

13.1 Temperature Introduction

You can continuously monitor the patient's skin temperature and core temperature. Thermally sensitive resistors (thermistors) are used. They are based on the principle that electrical resistance of the thermistor changes as temperature changes. Thermistors measure the resistance change and use it to calculate the temperature.

For uMEC 70/uMEC 80/uMEC 120/uMEC 150, you can simultaneously monitor up to two temperature sites and calculate the difference between two measured sites. For uMEC 60/uMEC 100, you can only monitor one temperature site.

Temperature monitoring is intended for adult, pediatric and neonatal patients.

13.2 Displaying the Temp Numerics Area

To display the Temp numerics area, follow this procedure:

1. Access **Tile Layout** in either of the following ways:
 - ◆ Select the **Screen Setup** quick key → select the **Tile Layout** tab.
 - ◆ Select the **Main Menu** hard key or quick key → from the **Display** column select **Tile Layout**.
2. Select a parameter numeric area or waveform area, and then from the popup list select **Any Temp**.

13.3 Temperature Display

The following figure shows the Temp numeric area for temperature monitoring.

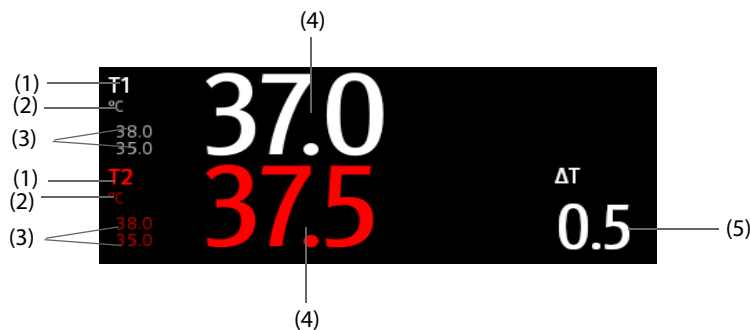

(1) Temperature site (2) Temperature unit (3) Alarm limits (4) Temperature value

(5) Temperature difference (ΔT): Difference between two temperature sites. It displays only when ΔT is switched on.

13.4 Preparing for Temperature Monitoring

To prepare temperature monitoring, follow this procedure:

1. Select an appropriate probe for your patient according to patient category and measured site.
2. Plug the probe or temperature cable to the temperature connector. If you are using a disposable probe, connect the probe to the temperature cable.
3. Follow the probe manufacturer's instructions to connect the probe to the patient.

13.5 Changing Temperature Settings

13.5.1 Setting the Temperature Alarm Properties

To set the temperature alarm properties, follow this procedure:

1. Select the temperature numeric area to enter the **Temp** menu.
2. Select the **Alarm** tab.
3. Enter the password if required.
4. Set the alarm properties.

13.5.2 Selecting the Temperature Label

Select the temperature label according to the measurement site. To do so, follow this procedure:

1. Select the temperature numeric area to enter the **Temp** menu.
2. Select the **Setup** tab.
3. Set the temperature label.

13.5.3 Displaying the Temperature Difference

To display the temperature difference between two measurement sites monitored by the same temperature module, switch on corresponding ΔT . To do so, follow this procedure:

1. Select the temperature numeric area to enter the **Temp** menu.
2. Select the **Setup** tab.
3. Switch on ΔT .

13.6 Temperature Troubleshooting

This section lists the problems that might occur. If you encounter the problems when using the equipment or accessories, check the table below before requesting for services. If the problem persists, contact your service personnel.

NOTE

- For the physiological and technical alarm messages, see *D Alarm Messages*.

Problem	Solution
Do not see Temp numeric area on the main screen	<ol style="list-style-type: none">1. Check that the Temp is set to display in the Screen Setup menu. For more information, see 3.11.2 <i>Displaying Parameter Numerics and Waveforms</i>.2. Check that if the Temp parameter switch is enabled. If not, enable the Temp measurement. For more information, see 3.11.1 <i>Switching On or Off a Parameter</i>.3. Check that the connections of the temperature probe and the temperature cable are tight.
Measurement fails/'--' is displayed in the Temp numeric area	<ol style="list-style-type: none">1. If you are using a disposable probe, check the connection between the probe and the temperature cable.2. Try using a known good probe in case the sensor is damaged.

14 Monitoring Noninvasive Blood Pressure (NIBP)

14.1 NIBP Introduction

The monitor uses the oscillometric method for measuring the non-invasive blood pressure (NIBP). NIBP measurement is based on the principle that pulsatile blood flow through an artery creates oscillations of the arterial wall. The oscillometric device uses a blood pressure cuff to sense these oscillations that appear as tiny pulsations in cuff pressure. The oscillometric method measures the mean pressure and determines the systolic and diastolic pressures.

NIBP monitoring is intended for adult, pediatric and neonatal patients.

NOTE

- **Blood pressure measurements determined with this device are equivalent to those obtained by a trained observer using the cuff/stethoscope auscultatory method or an intra-arterial blood pressure measurement device, within the limits prescribed by the American National Standard: manual, electronic, or automated sphygmomanometers.**
 - **NIBP measurement can be performed during electro-surgery and discharge of defibrillator.**
-

14.2 NIBP Safety Information

WARNING

- **Be sure to select the correct patient category setting for your patient before NIBP measurement. Do not apply the higher adult settings for pediatric or neonatal patients. Otherwise, it may present a safety hazard.**
 - **Do not perform NIBP measurements on patients with sickle-cell disease.**
 - **To avoid further injury, do not apply the NIBP cuff on the limb with a wound.**
 - **Use clinical judgment to determine whether to perform frequent unattended blood pressure measurements on patients with severe blood clotting disorders because of the risk of hematoma in the limb fitted with the cuff.**
 - **To avoid the risk of patient injury, do not apply the NIBP cuff on a limb that has an intravenous infusion or catheter in place. Apply the cuff on another limb if possible.**
 - **Do not apply cuff on the arm on the side of a mastectomy or lymph node clearance.**
 - **Continuous cuff pressure due to connection tubing kinking may cause blood flow interference, and resulting in harmful injury to the patient.**
 - **NIBP reading can be affected by the measurement site, the position of the patient, exercise, or the patient's physiologic condition. If you doubt the NIBP measurements, determine the patient's vital signs by alternative means, and then verify that the monitor is working correctly.**
 - **Taking NIBP measurements exert pressure on the patient's tissue. This can cause skin purpura, ischemia, and neuropathy. Periodically check the cuff site and the limb distal to the cuff for normal color, warmth and sensitivity. If there is a sign of skin change or poor distal circulation, move the cuff to another limb or stop NIBP measurements. Check more frequently when using the STAT mode or using the auto mode at short intervals. Auto NIBP measurements with one and two minute intervals are not recommended for extended periods of time.**
 - **NIBP diagnostic significance must be decided by the physician.**
-

CAUTION

- **Using IABP may cause NIBP, including PR, measurements inaccurate or failed.**
 - **Only use parts and accessories specified in this manual. Follow the instructions for use and adhere to all warnings and cautions.**
-

- Accuracy of NIBP measurement depends on using a cuff of proper size. It is essential to measure limb circumference and choose a cuff with proper size.

14.3 NIBP Measurement Limitations

NIBP measurement may be inaccurate or impossible in the following situations:

- The patient is connected to a heart lung machine.
- Regular arterial pressure pulses are hard to detect
- The patient has cardiac arrhythmias.
- The patient's blood pressure changes dramatically.
- The patient has poor circulation due to severe shock or hypothermia.
- NIBP cuff is applied on an limb with edematous extremity.
- The NIBP cuff is compressed by excessive movement such as shivering, seizures, or convulsions.
- The patient's blood pressure is out of measurement range.

NOTE

- The effectiveness of the sphygmomanometer has not been established in pregnant, including pre-eclamptic patients.

14.4 Measurement Modes

There are four NIBP measurement modes:

- Manual mode: measurement is taken on demand.
- Auto mode: repeated measurements are taken at set interval.
- STAT mode: continually rapid series of measurements are taken over a five-minute period.
- Sequence mode: continually automatic measurement are taken at set durations and intervals.
- Clock mode: automatic measurement is synchronized with the real time clock.

14.5 NIBP Display

The NIBP display shows only numerics.

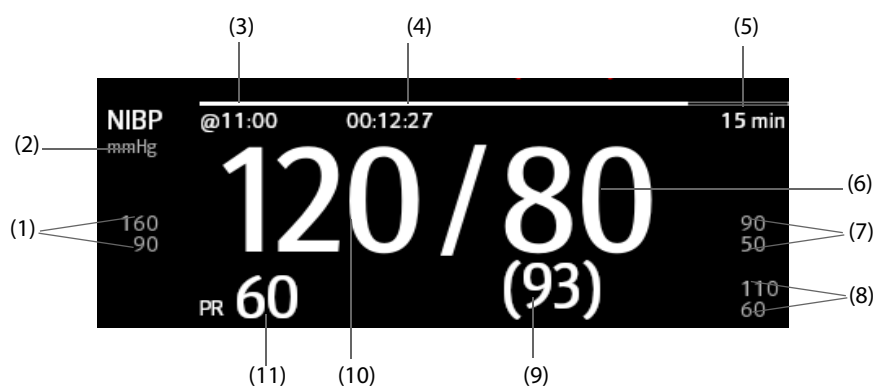

- (1) Systolic pressure alarm limits
- (2) NIBP unit: mmHg or kPa
- (3) The last NIBP measurement time
- (4) Time to the next measurement (for Auto mode and Sequence mode)
- (5) Measurement mode: for Auto NIBP, interval is displayed; for Sequence mode, the current phase and interval are displayed
- (6) Diastolic pressure
- (7) Diastolic pressure alarm limits

(8) Mean pressure alarm limits

(9) Mean pressure (displayed after measurement completed) or cuff pressure (displayed during the measurement)

(10) Systolic pressure

(11) Pulse Rate

NOTE

- **If NIBP measurement fails, “XX” is displayed; if NIBP measurement is not taken, “--” is displayed.**
 - **Outlined NIBP numerics indicate that the measurement is old and exceeds the set time. So these NIBP values are not recommended for reference.**
-

14.6 Preparing for NIBP Measurements

14.6.1 Preparing the Patient for NIBP Measurements

In normal use, perform NIBP measurement on a patient who is in the following position:

- Comfortably seated
- Legs uncrossed
- Feet flat on the floor
- Back, arm and feet supported

NOTE

- **It is recommended that the patient calms down and relaxes as much as possible before performing the measurement and that the patient do not talk during the measurement.**
 - **It is recommended to have the patient sit quietly for several minutes before taking the measurement.**
 - **Other factors that have been shown to result in an overestimation of blood pressure are labored breathing, full bladder, pain etc.**
-

14.6.2 Placing the NIBP Cuff

To place the NIBP cuff, follow this procedure:











1. Verify that the patient category setting is correct. If not, enter the **Patient Management** menu to change patient category. For more information, see *5.3.2 Editing Patient Information*.
2. Connect the air tubing to the NIBP connector.
3. Apply the cuff around the patient's limb directly over the patient's skin as follows:
 - a Determine the patient's limb circumference.
 - b Select an appropriate cuff by referring to the limb circumference marked on the cuff. The width of the cuff should be 40% (50% for neonates) of the limb circumference, or 2/3 of the length of the upper arm or the thigh. The inflatable part of the cuff should be long enough to encircle at least 50% to 80% of the limb.
 - c Apply the cuff to the patient's upper arm or leg and make sure the Φ marking on the cuff matches the artery location. The cuff should fit snugly, but with enough room for two fingers to be placed between the cuff and the patient's arm (on adults), and loosely on neonates with little or no air present within the cuff. Excessive tightness may cause discoloration and ischemia of the limb distal. Make sure that the cuff index line falls within the range markings on the cuff.
 - d Make sure that the middle of the cuff is at the level of the heart. Otherwise correct the measurement by referring the measurement correction formula. For more information, see *14.9.10 Correcting the NIBP Measurements*.
4. Connect the cuff to the air tubing. Check that the air tubing are not kinked or compressed, and air can pass unrestrictedly through the tubing.

CAUTION

- Using a cuff of wrong size, or a cuff with twisted bladder and kinked air tubing, can cause inaccurate measurements.
- Do not touch or apply external pressure against the cuff and air tubing during NIBP measurement. This may cause inaccurate blood pressure values.
- Use care when placing the cuff on an extremity used for monitoring other patient parameters.

14.7 Starting and Stopping NIBP Measurements

Start and stop NIBP measurement by selecting the NIBP quick keys or from the NIBP menu.

Task	By Quick Key	From NIBP menu
Start a manual measurement	NIBP Start/Stop quick key 	Start NIBP button
Start auto NIBP series	NIBP Start/Stop quick key  Make sure to set Interval before starting auto NIBP.	Setup tab → set Interval → Start NIBP button
	NIBP Measure quick key  → select Interval	
Start NIBP sequence measurement	NIBP Measure quick key  → Sequence	Sequence tab → set NIBP sequence → Start NIBP button
Start STAT measurement	NIBP STAT quick key 	STAT button
	NIBP Measure quick key  → STAT	
Stop the current NIBP measurements	NIBP Start/Stop quick key 	Stop NIBP button
End auto NIBP series or NIBP Sequence	NIBP Stop All quick key 	NIBP Stop All button
Stop STAT measurement and end series	NIBP Start/Stop quick key 	Stop NIBP or NIBP Stop All button
	NIBP Stop All quick key 	

14.8 Viewing NIBP Analysis

NIBP analysis provides you a dynamic analysis of NIBP changes and distribution over the time scale. It allows you to know the patient's condition of the latest 24 hours before you entering the NIBP Analysis window.

To view NIBP analysis, follow this procedure:

1. Select the NIBP numeric area to enter the **NIBP** menu.
2. Select the **Setup** tab.
3. Select **Analysis**.

You can also select anywhere in the **NIBP Analysis** window to enter the tabular trends review page. For more information, see *18 Review*.

14.9 Changing NIBP Settings

14.9.1 Setting the NIBP Alarm Properties

To set the NIBP alarm properties, follow this procedure:

1. Select the NIBP numeric area to enter the **NIBP** menu.
2. Select the **Alarm** tab.
3. Enter the password if required.
4. Set alarm properties as desired.

14.9.2 Setting the Initial Cuff Inflation Pressure

To set initial cuff inflation pressure, follow this procedure:

1. Select the NIBP numeric area to enter the **NIBP** menu.
2. Select **Initial Pressure**, and then select the appropriate setting.

NOTE

- **For known hypertensive patients, you need to set initial cuff pressure to a higher value to reduce the measurement time.**
-

14.9.3 Setting the NIBP Interval

For auto NIBP measurement, you need to set the interval between two NIBP measurements. To set the NIBP interval, follow this procedure:

1. Select the NIBP numeric area to enter the **NIBP** menu.
2. Set **Interval**. Selecting **Manual** switches to manual mode.

14.9.4 Selecting NIBP Start Mode

Start mode defines how NIBP auto mode works. To set the start mode, follow this procedure:

1. Select the NIBP numeric area to enter the **NIBP** menu.
2. Set **Start Mode**.
 - ◆ **Clock**: after the first measurement, the monitor automatically synchronizes NIBP automatic measurements with the real time clock. For example, if **Interval** is set to **20 min**, and you start NIBP auto measurement at 14:03, the next measurement will be taken at 14:20, and then at 14:40, 15:00, and so on.
 - ◆ **Interval**: after the first measurement, the monitor automatically repeats measurements at set interval. For example, if **Interval** is set to **20 min**, and you start NIBP auto measurement at 14:03, the next measurement will be taken at 14:23, and then at 14:43, 15:03, and so on.

14.9.5 Enabling the NIBP End Tone

The monitor can issue a reminder tone at the completion of NIBP measurement. The NIBP End Tone is off by default. To switch on the NIBP end tone, follow this procedure:

1. Select the NIBP numeric area to enter the **NIBP** menu.
2. Switch on **NIBP End Tone**.

14.9.6 Setting NIBP Sequence

NIBP sequence measurement can have up to five phases: A, B, C, D, and E. You can individually set the duration and interval of each phase.

To set NIBP sequence, follow this procedure:

1. Select the NIBP numeric area to enter the **NIBP** menu.
2. Select the **Sequence** tab.
3. Set **Duration** and Interval of each phase.

14.9.7 Setting the NIBP Display Format

To set the NIBP display format, follow this procedure:

1. Select the NIBP numeric area to enter the **NIBP** menu.
2. Set **Display Format**.

14.9.8 Setting the NIBP Alarm Limits Display Switch

To set whether to display the alarm limits of diastolic NIBP and mean NIBP, follow this procedure:

1. Select the NIBP numeric area to enter the **NIBP** menu.
2. Switch on or off **Display Alarm Limits**.

14.9.9 Showing/Hiding PR

You can set whether to display the PR value in the NIBP parameter area. To do so, follow this procedure:

1. Select the NIBP numeric area to enter the **NIBP** menu.
2. Switch on or off **Display PR**.

14.9.10 Correcting the NIBP Measurements

The middle of the cuff should be at the level of right atrium. If the limb is not at the heart level, you need to correct the measurement:

- Add 0.75 mmHg (0.10 kPa) to the displayed value for each centimetre higher.
- Deduct 0.75 mmHg (0.10 kPa) to the displayed value for each centimeter lower.

14.10 Assisting Venous Puncture

You can use the NIBP cuff to cause sub-diastolic pressure to block the venous blood vessel and therefore help venous puncture. To assist venous puncture, follow this procedure:

1. Select the **Venipuncture** quick key or select the NIBP numeric area.
2. Set **Venipuncture Pressure**.
3. Select **Venipuncture** at the bottom of the menu.
4. Puncture vein and draw blood sample.
5. Select the **NIBP Start/Stop** quick key to deflate the cuff. If you do not deflate the cuff, the cuff automatically deflates after a period of time (170 seconds for adult and pediatric patient, 85 seconds for neonatal patient).

During venous puncture, pay attention to the cuff pressure and the remaining time displayed in the NIBP numerics area.

14.11 NIBP Maintenance

14.11.1 NIBP Leakage Test

The NIBP leakage test checks the integrity of the system and of the valve. The NIBP leakage test should be performed once every two years or when you doubt the NIBP measurements. The NIBP leakage test should be performed by Mindray-qualified service personnel only.

14.11.2 NIBP Accuracy Test

The NIBP accuracy test should be performed once every two years or when you doubt the NIBP measurements. The NIBP accuracy test should be performed by Mindray-qualified service personnel only.

14.12 NIBP Troubleshooting

For more information, see *D Alarm Messages*.

This page intentionally left blank.

15 Monitoring Invasive Blood Pressure (IBP) (for uMEC 70/uMEC 80/uMEC 120/uMEC 150)

15.1 IBP Introduction

IBP monitoring is intended for adult, pediatric and neonatal patients. PAWP monitoring is only intended for adult and pediatric patients.

You can monitor up to 2 invasive blood pressures.

15.2 IBP Safety Information

WARNING

- **Use only pressure transducers specified in this manual. Never reuse disposable pressure transducers.**
 - **Make sure that the applied parts never contact other conductive parts.**
 - **To reduce the hazard of burns during high-frequency surgical procedure, ensure that the monitor's cables and transducers never come into contact with the high-frequency surgical units.**
 - **When using accessories, their operating temperature should be taken into consideration. For more information, see instructions for use of accessories.**
 - **All invasive procedures involve risks to the patient. Use aseptic technique. Follow catheter manufacturer's instructions.**
 - **Mechanical shock to the invasive blood pressure transducer may cause severe shifts in zero balance and calibration, and cause erroneous readings.**
-
-

CAUTION

- **Using IABP may cause IBP, including PR, measurements inaccurate or failed.**
-

15.3 Preparing for IBP Monitoring

15.3.1 IBP Equipment to Patient Connection

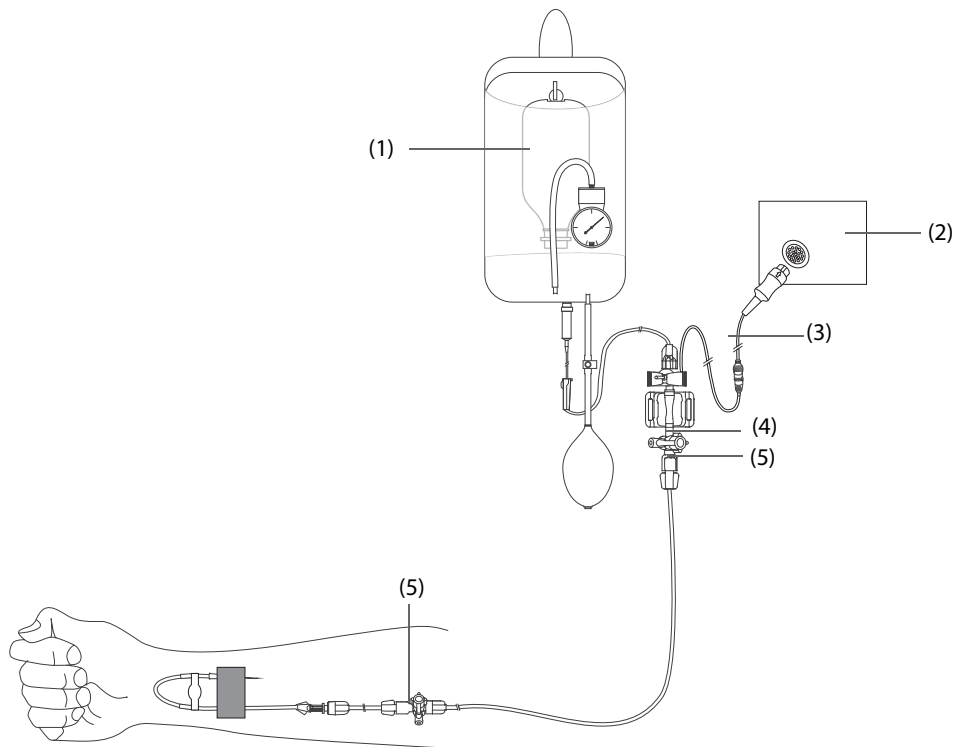

(1) Pressure bag/Infusion pump

(2) IBP connector

(3) IBP cable

(4) IBP transducer

(5) Three-way valve

15.3.2 Measuring an Invasive Blood Pressure

To monitor IBP, follow this procedure:

1. Connect one end of the IBP cable to the IBP cable connector, and the other end to the IBP transducer.
2. Flush the IBP transducer system to exhaust all air from the tubing according to the manufacturer's instructions. Ensure that the system is free of air bubbles.
3. Connect the IBP transducer to the patient, making sure that the transducer is at the same horizontal level as the heart.
4. Select the proper pressure label for currently measured pressure. For more information, see *15.6.2 Changing the Pressure Label*.
5. Zero the IBP transducer. For more information, see *15.3.3 Zeroing the IBP transducer*. After a successful zeroing, turn off the stopcock to the air and turn on the stopcock to the patient.

CAUTION

- **Make sure that all the transducers are zeroed correctly before the IBP measure.**
 - **Make sure that no air bubble exists in the IBP transducer system before the IBP measure.**
 - **When measuring ICP on a sitting patient, place the ICP transducer at the same level with the top of the patient's ear. Incorrect leveling may give incorrect values (not applicable if measuring ICP with the Codman ICP transducer).**
-

15.3.3 Zeroing the IBP transducer

To avoid inaccurate pressure readings, the IBP transducer should be zeroed in accordance with the hospital policy. The IBP transducer should be zeroed in the following conditions:

- The IBP transducer or adapter cable is reconnected.
- The monitor restarts.
- You doubt the readings.
- The monitor displays the prompt message **Zero Required**.

To zero the transducer, follow this procedure:

1. Connect the IBP transducer, the IBP adapter cable and the monitor.
2. Turn off the three-way valve (the one near the transducer) to the patient, in order to vent the transducer to the atmospheric pressure.
3. Zero the transducer by one of the following methods:
 - ◆ Select the numeric area (such as the Art numeric area), and then select **Zero** button.
 - ◆ Select the **Zero IBP** quick key.
4. After the zero calibration is completed, close the stopcock to the air and open the stopcock to the patient.

Zero calibration may fail in case of pressure fluctuation or pressure exceeding the calibration range. If zero calibration fails, follow this procedure:

1. Check that the three-way valve (the one near the transducer) is open to the air.
2. Perform zero calibration again. Do not sway the IBP transducer and tubing during zero calibration.

15.4 Measuring ICP Using the Codman ICP Transducer

15.4.1 Zeroing the Codman ICP transducer

You shall zero the Codman ICP transducer (Model: 82-6653) before use. To zero the ICP transducer, follow this procedure:

1. Connect the ICP transducer, the ICP adapter cable and the monitor.
2. Follow the manufacturer's instructions to prepare the ICP transducer.
3. Zero the ICP transducer: when you see the message **Zero Reference** in the ICP numeric area, select the ICP waveform area or numeric area to enter the **ICP** menu → select the **Zero** tab → select the **Zero** button.
4. Record the zero reference value on the blank area of the ICP transducer for further reference.

If the ICP transducer zero calibration failed or you doubt the zero reference value, perform a zero calibration again.

15.4.2 Measuring ICP

To perform the ICP measurement, follow this procedure:

1. Zero the Codman ICP transducer. For more information, see section *15.4.1 Zeroing the Codman ICP transducer*.
2. Disconnect the ICP transducer and ICP adapter cable. Follow the manufacturer's instructions to apply the ICP transducer to the patient.
3. Reconnect the ICP transducer and ICP adapter cable.
4. Check that the zero reference value displayed on the monitor is consistent with that recorded on the ICP transducer.
 - ◆ Consistent: select **Accept**.
 - ◆ Inconsistent: input the zero reference value recorded on the ICP transducer, and select **Accept**.

If you have to transfer the patient who is taking ICP measurement, check that the target monitor supports the Codman ICP transducer. For more information, see *15.4.1 Zeroing the Codman ICP transducer*. If the target monitor does not support the Codman ICP transducer, do not use it for ICP monitoring.

Follow this procedure to transfer the patient:

1. Disconnect the ICP adapter cable from the monitor.
2. Connect the ICP adapter cable and the target monitor.
3. Check that the zero reference value displayed on the monitor is consistent with that recorded on the ICP transducer.
 - ◆ Consistent: select **Accept**.
 - ◆ Inconsistent: input the zero reference value recorded on the ICP transducer, and select **Accept**.

CAUTION

- **If monitors of different brands are used to zero the Codman ICP transducer, the zero reference values can be different. Use a Mindray monitor to Zero the Codman ICP transducer if you will take ICP measurement using a Mindray monitor. Otherwise the ICP measurement can be inaccurate.**
-

15.5 IBP Display

The IBP measurement is displayed on the monitor as a waveform and numeric pressures. For arterial pressure, the IBP numeric area displays systolic pressure, diastolic pressure and mean pressure. For venous pressure, the IBP numeric area displays only the mean pressure. The figure below shows the waveform and numerics for the Art pressure.

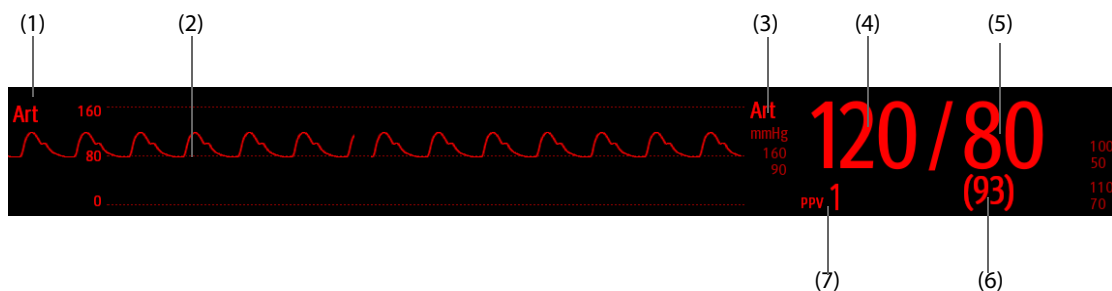

- | | |
|------------------------|-----------------------|
| (1) Pressure label | (2) Waveform |
| (3) Pressure Unit | (4) Systolic pressure |
| (5) Diastolic pressure | (6) Mean pressure |
| (7) PPV measurement | |

15.6 Changing IBP Settings

15.6.1 Changing the IBP Alarm Settings

To change the IBP alarm settings, follow this procedure:

1. Select the IBP numeric area or waveform area to enter the corresponding pressure menu.
2. Select the **Alarm** tab.
3. Enter the password if required.
4. Set the alarm properties.

15.6.2 Changing the Pressure Label

A pressure label is used to define each type of pressure. Therefore, you should select a proper pressure label for the source of the pressure you want to monitor.

To select the pressure label, follow this procedure:

1. Select the IBP numeric area or waveform area to enter the corresponding pressure menu.
2. Select the **Setup** tab.
3. Set **IBP1 Label** or **IBP2 Label**.

Label	Description	Label	Description
PA	Pulmonary artery pressure	CVP	Central venous pressure
Ao	Aortic pressure	LAP	Left atrial pressure
UAP	Umbilical arterial pressure	RAP	Right atrial pressure
BAP	Brachial arterial pressure	ICP	Intracranial pressure
FAP	Femoral arterial pressure	UVP	Umbilical venous pressure
Art	Arterial blood pressure	LV	Left ventricular pressure
CPP	Cerebral perfusion pressure	P1 to P4	Non-specific pressure label

NOTE

- It is not allowed to select the same label for different pressures.

15.6.3 Setting the Pressure Type for Display

For the non-specific pressure (P1, P2, P3 or P4), the displayed pressure type is configurable. To set the displayed pressure type, follow this procedure:

1. Select the numeric area or waveform area of the non-specific pressure to enter the corresponding pressure menu.
2. Select the **Setup** tab.
3. Set **Measure**:
 - ◆ If this non-specific pressure is artery pressure, set the **Measure** to **All**. In this case, its corresponding numeric area displays systolic pressure, diastolic pressure and mean pressure.
 - ◆ If this non-specific pressure is venous pressure, set the **Measure** to **Mean Only**. In this case, its corresponding numeric area displays only the mean pressure.

15.6.4 Changing the Sensitivity

The IBP value displayed on the monitor screen is the average of data collected within a specific time. The shorter the averaging time is, the quicker the monitor responds to changes in the patient's blood pressure, and the higher the sensitivity. Contrarily, the longer the averaging time is, the slower the monitor responds to changes in the patient's blood pressure, the lower the sensitivity, but the measurement accuracy will be improved. For critically ill patients, selecting higher sensitivity will help understanding the patient's state.

To set the sensitivity, follow this procedure:

1. Select the IBP numeric area or waveform area to enter the corresponding pressure menu.
2. Select the **Setup** tab.
3. Set **Sensitivity**.

15.6.5 Setting the IBP Waveform

To set the IBP waveform, follow this procedure:

1. Select the IBP numeric area or waveform area to enter the corresponding pressure menu.
2. Select the **Setup** tab.
3. Set the following properties of the IBP waveform:
 - ◆ **Speed**
 - ◆ **Scale**: if **Auto** is selected, the size of the pressure's waveform will be adjusted automatically.

15.6.6 Setting the Display Format of Artery Pressure

To set the display format of the artery pressure, follow this procedure:

1. Select the numeric area or waveform area of any arterial pressure to enter the corresponding menu.
2. Select the **Setup** tab.
3. Set **Display Format**.

15.6.7 Showing/Hiding the Alarm Limits of Artery Pressure

To set whether to display the alarm limits of the arterial pressure, follow this procedure:

1. Select the numeric area or waveform area of any arterial pressure to enter the corresponding menu.
2. Select the **Setup** tab.
3. Switch on or off **Display Alarm Limits**.

15.6.8 Enabling PPV Measurement

PPV indicates pulse pressure variation. When measuring the arterial pressure (except PA), the PPV measurement is available. To enable the PPV measurement, follow this procedure:

1. Select the IBP numeric area or waveform area to enter the corresponding pressure menu.
2. Select the **PPV Setup** tab.
3. Switch on **PPV Measure**.

You can select PPV source after enabling the PPV measurement.

WARNING

- **The PPV measurement is validated only on adult patients.**
 - **PPV measurement is reliable only for mechanically ventilated patients with no arrhythmias.**
 - **PPV measurements may be inaccurate for patients with a very low respiration rates, low tidal volumes during ventilation, and with acute cor pulmonale.**
 - **The clinical value of the PPV must be determined by the physician.**
-
-

15.6.9 Overlapping IBP Waveforms

The IBP waveforms can be displayed together. To combine IBP waveforms, follow this procedure:

1. Access **Tile Layout** by either of the following ways:
 - ◆ Select the **Screen Setup** quick key → select the **Tile Layout** tab.
 - ◆ Select the **Main Menu** hard key or quick key → from the **Display** column select **Tile Layout**.
2. Select the waveform area where you want to display the overlapped IBP waveforms, and then select the IBP waves to be overlapped on the left side of the same line.
3. Repeat step 2 in another waveform area if needed.
4. Select  to save the setting and exit the window. The main screen will display the overlapped IBP waves.

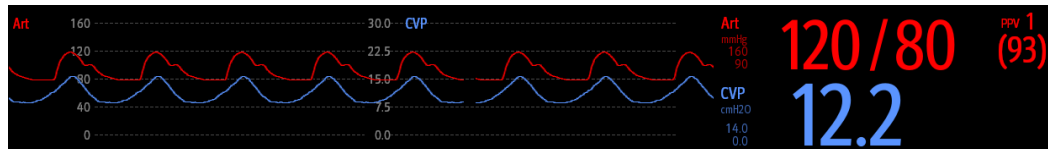

Selecting the overlapped IBP waveforms on the main screen opens the **Overlapping Waveform Setup** menu, where you can make the following settings:

- **Scale**
 - ◆ Set **Left Scale** for the arterial pressure.
 - ◆ Set **Right Scale** for the venous pressure.
 - ◆ Set **CVP Scale** individually if the CVP waveform is combined and CVP unit is different from IBP unit.
 - ◆ Set **ICP Scale** individually if the ICP waveform is combined and ICP unit is different from IBP unit.
 - ◆ Set **PA Scale** individually if the PA waveform is combined.
- Switch on or off **Gridlines** to show or hide gridlines in the overlapped waveform area.
- Set **Speed** for the overlapped waveforms.

NOTE

- **The unit of CVP scale is consistent with CVP parameter unit.**

15.7 Measuring PAWP

PAWP reflects the pressure in the left ventricle at end-diastole. PAWP is derived from a pulmonary artery catheter when the pulmonary artery distal balloon is inflated and the catheter advances and occludes a distal pulmonary artery. PAWP values obtained at the end of the respiration cycle are the most accurate. At this time, the intrathoracic pressure is relatively constant and the respiration artifact is minimal.

WARNING

- **PAWP monitoring is not intended for neonatal patients.**

15.7.1 PAWP Equipment to Patient Connection

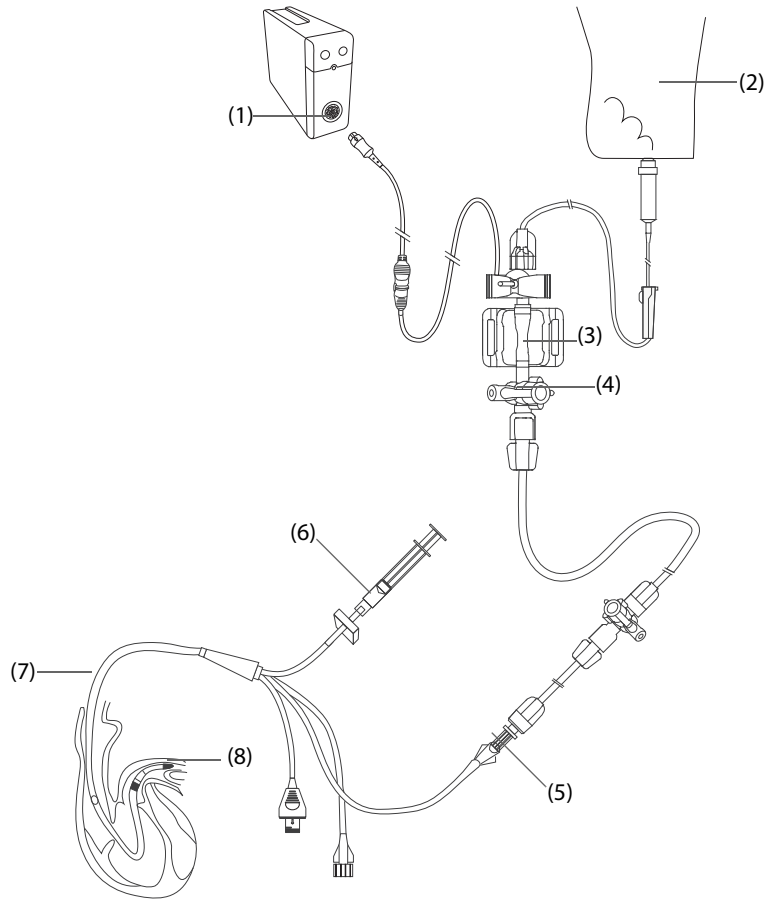

- | | |
|-----------------------------|-----------------------------|
| (1) IBP connector | (2) Flush bag |
| (3) IBP transducer | (4) Three-way valve |
| (5) PA distal port | (6) Balloon inflation valve |
| (7) Thermodilution catheter | (8) Balloon |

15.7.2 Preparing to Measure PAWP

To prepare to monitor PAWP, follow this procedure:

1. Connect the IBP transducer, the IBP cable and the monitor. For more information, see *15.3.2 Measuring an Invasive Blood Pressure*.
2. Follow the manufacturer's instructions to connect the PA port of the thermodilution catheter and the patient end of the IBP transducer.
3. Zero the IBP transducer. For more information, see *15.3.3 Zeroing the IBP transducer*.
4. Set the IBP label to **PA** since the PAWP is measured on PA. For more information, see *15.6.2 Changing the Pressure Label*.

15.7.3 Measuring PAWP

To measure the PAWP, follow this procedure:

1. Select the PA numeric area or waveform area to enter the **PA** menu, and then select **PAWP**.
2. Wedge the flotation catheter into the pulmonary artery by observing the PA waveform changes on the screen, referring to the following figure.

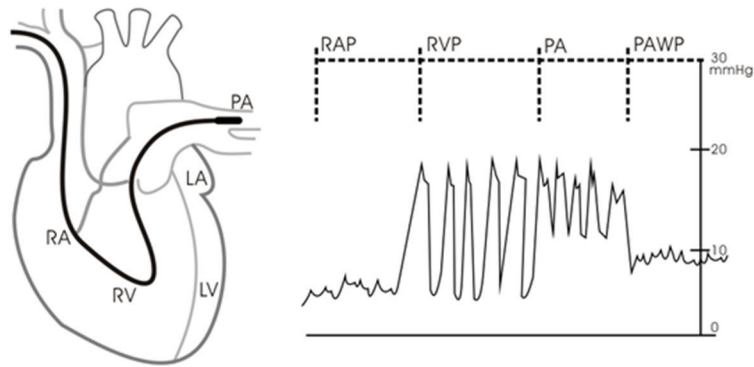

3. Select **Start**.
4. Inflate the balloon and pay attention to PA waveform changes on the screen when the prompt message **Ready For Balloon Deflation** appears.
5. Deflate the balloon when the prompt message **Ready For Balloon Deflation** appears. If the PA waveform is stable yet the monitor still not show the prompt message **Ready For Balloon Deflation**, select the **Freeze** to freeze the waveform, and deflate the balloon.
6. Select **Accept** to save the PAWP value.
7. If you need to start a new measurement, repeat the step 3 to step 6.

If the measurement fails or you need to adjust the PAWP value, you can use the following buttons to adjust the PAWP waveform and measurement.

- Select the up or down arrow button to adjust the PAWP value.
- Select the left or right arrow button to view the frozen waveforms of 40 seconds.
- Select **Accept** to save the PAWP value.

WARNING

- **Follow manufacturer's suggested procedures and hospital policy for PAWP balloon inflation. Inflating the balloon for an extra long time could result in pulmonary hemorrhage or infarction, or both.**
 - **A PAWP value greater than the systolic PA may indicate rupture of the pulmonary artery. Deflate the balloon immediately and report this event according to hospital policy.**
-

NOTE

- **The PA alarm is turned off automatically when the monitor enters the PAWP screen.**
-

15.7.4 Setting the Waveforms of the PAWP Screen

On the **PAWP** screen, select **Setup** to enter the **PAWP Setup** menu. In the **PAWP Setup** menu, you can make the following settings:

- Select **Reference Waveform 1** to set an ECG lead wave as the first reference wave.
- Select **Reference Waveform 2** to set a respiration wave as the second reference wave.
- Select **Speed** to set a sweep speed for the displayed waveforms on the **PAWP** screen.
- Select **Scale** to set the size of the PA waveform on the **PAWP** screen.

15.7.5 Setting the Use PA-D as PAWP Switch

You can set whether PA-D value is used to replace PAWP value for hemodynamic calculation. To do so, follow this procedure:

1. Select the PA numeric area or waveform area to enter the **PA** menu.
2. Select the **Setup** tab.

3. Switch on or off **Use PA-D as PAWP**.

For more information on hemodynamic calculation, see *20.4 Hemodynamic Calculations*.

15.7.6 Performing Hemodynamic Calculation

On the **PAWP** screen, select **Hemo Calcs** to enter the **Hemo Calcs** menu. For more information, see *20.4 Hemodynamic Calculations*.

15.8 IBP Troubleshooting

This section lists the problems that might occur. If you encounter the problems when using the equipment or accessories, check the table below before requesting for services. If the problem persists, contact your service personnel.

NOTE

- For the physiological and technical alarm messages, see *D Alarm Messages*.

Problem	Solution
Cannot see IBP numeric area or waveform area on the main screen	<ol style="list-style-type: none"> 1. Check that the IBP is set to display in the Screen Setup menu. For more information, see <i>3.11.2 Displaying Parameter Numerics and Waveforms</i>. 2. Check that if the IBP parameter switch is enabled. If not, enable the IBP measurement. For more information, see <i>3.11.1 Switching On or Off a Parameter</i>. 3. Check the connection of IBP cable, IBP transducer and the monitor. 4. Check that the stopcock is turned to the correct position. 5. Check that the IBP transducer has been zeroed. For more information, see <i>15.3.3 Zeroing the IBP transducer</i>.
Cannot see systolic pressure and diastolic pressure for P1/P2/P3/P4	Set Measure to All in the P1/P2/P3/P4 setup menu. For more information, see <i>15.6.3 Setting the Pressure Type for Display</i> .
IBP readings seem unstable	<ol style="list-style-type: none"> 1. Make sure there are no air bubbles in the transducer systems. 2. Check that the transducer is properly fixed. 3. Zero the transducer again. 4. Replace a transducer.
Zeroing of IBP channel(s) fails.	<ol style="list-style-type: none"> 1. Ensure that the channels are open to air. 2. Perform zero calibration again. Do not sway the IBP transducer and tubing during zero calibration. For more information, see <i>15.3.3 Zeroing the IBP transducer</i>. 3. If zero calibration still fails, replace the transducer.

16 Monitoring Cardiac Output (C.O.) (for uMEC 70/ uMEC 80/uMEC 120/uMEC 150)

16.1 C.O. Introduction

The monitor uses the thermodilution method to measure the patient's cardiac output (C.O.) and other hemodynamic parameters. Cold solution is injected into the right atrium and the temperature drop is measured at the a downstream site. The C.O. value is calculated based on the curve of temperature change. Because the patient's cardiac output changes continuously, multiple measurements must be taken and averaged to get a reliable C.O. value.

C.O. monitoring is intended for adult patients only.

16.2 C.O. Safety Information

WARNING

- **The C.O. measurement results may be erroneous during electrosurgery.**
 - **All invasive procedures involve risks to the patient. Use aseptic technique and follow catheter manufacturer's instructions.**
 - **Use only accessories specified in this manual. Make sure that the accessories never come into contact with conductive parts.**
 - **C.O. monitoring is not intended for pediatric and neonatal patients.**
-

16.3 C.O. Measurement Limitations

The following factors may influence the accuracy of C.O. measurement:

- temperature of injectate solution
- volume of injectate solution
- baseline of patient's blood temperature
- patient's inspiratory/expiratory cycle
- placement of catheter with relation to proximity of lung field
- the catheter itself
- patient's heart rate and hemodynamic status
- any solution infused with intravenous injection during the C.O. measurement

To obtain accurate C.O. measurements, follow these recommendations:

- Temperature of injectate solution must be at least 10 °C cooler than that of the patient's blood.
- Inject solution at end of expiration.
- Inject solution rapidly and smoothly.
- Finish injection within four to five seconds.

16.4 C.O. Display

The C.O. display shows only C.O., C.I (cardiac index), and TB (blood temperature) in the C.O. numeric area.



- (1) C.O. label
- (2) Primary parameter unit
- (3) Labels and values for primary parameters
- (4) Labels and values for secondary parameters

16.5 C.O. Equipment to Patient Connection

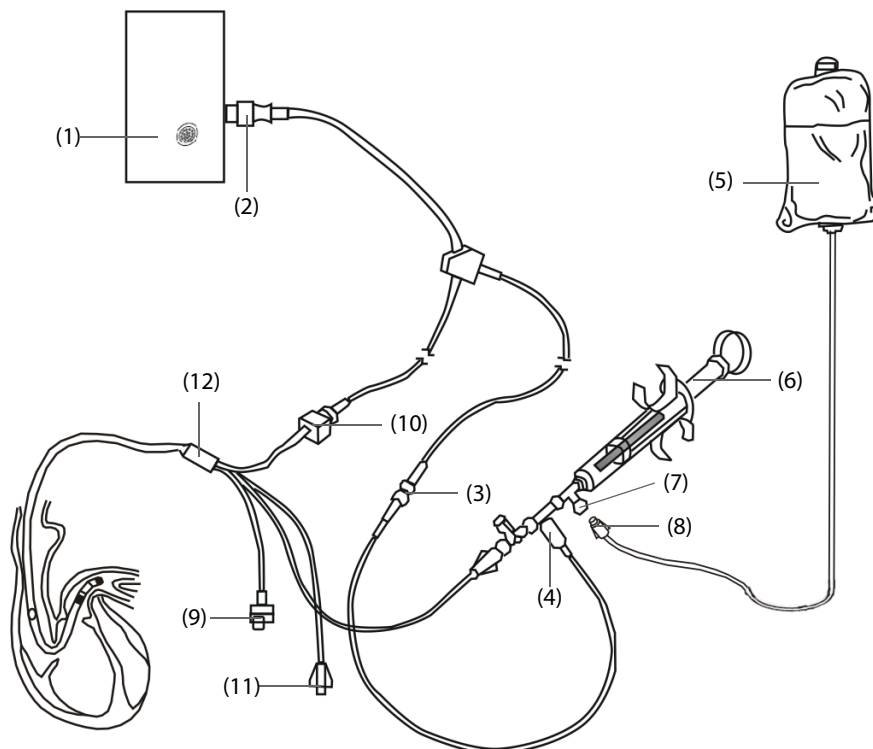

- (1) C.O. module
- (2) 12-pin C.O. cable (Model: CO7702)
- (3) TI cable connector
- (4) Temperature probe
- (5) Injectate solution
- (6) Injectate syringe
- (7) Three-way valve
- (8) Proximal injectate port
- (9) Balloon inflation valve
- (10) Thermistor connector
- (11) PA distal port
- (12) TB cable connector

16.6 Performing C.O. Measurement

16.6.1 Preparing for C.O. Measurement

1. Connect the C.O. cable to the C.O. connector and TB cable connector, making sure the C.O. numeric area is displayed on the monitor's main screen.
2. Follow the hospital's policy and procedures to prepare the patient for the C.O. measurement.
3. Follow the manufacturer's instructions to set up the catheter and other accessories.
4. Check that all the accessories are properly connected.

NOTE

- For an in-line probe setup, make sure the in-line sensor is securely connected to the tubing. For the bath probe setup, make sure the bath probe is correctly sensing the injectate temperature.

16.6.2 Setting C.O. Measurement

Before performing the C.O. measurement, follow this procedure:

1. Select the C.O. numeric area to enter the **C.O. Measure** menu.
2. Select the **Setup**.
3. Perform the following check or setup:
 - ◆ Check if the height and weight are appropriate for your patient. Change if necessary. The patient's height and weight values are required for determining cardiac index (C.I.).
 - ◆ Check that the correct computation constant is entered. The computation constant has a close relationship with the entered injectate volume, injectate probe type (in-line probe or bath probe) and temperature. See the Instruction for Use of pulmonary artery catheter to determine. To change the computation constant, select **Comp Const** and then input the correct value. When a new catheter is used, the computation constant should be adjusted in accordance with the manufacturer's instructions for use.
 - ◆ Switch on or off **Auto TI**. If **Auto TI** is switched on, the system automatically detects the injectate temperature, and **TI** setting is disabled. If **Auto TI** is switched off, you need to input the injectate temperature at **TI**.
 - ◆ Switch on or off **Auto Start**. If **Auto Start** is switched on, the monitor automatically takes the C.O. measurement after establishing a baseline of blood temperature. If **Auto Start** is switched off, you need to click the **Start** button in the **C.O. Measure** window for a new measurement.

16.6.3 Performing C.O. Measurement

To perform the C.O. measurement, follow this procedure:

1. Select the C.O. numeric area to enter the **C.O. Measure** menu.

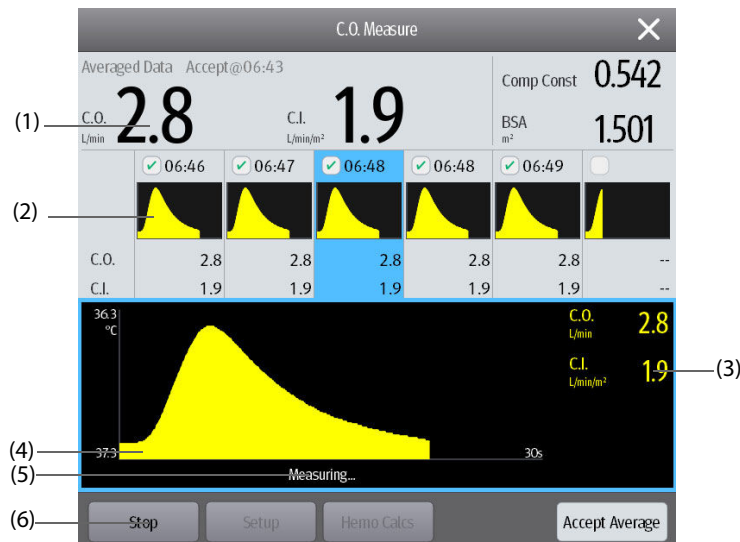

- (1) Average values
- (2) Historical measurement windows
- (3) Current measurement values
- (4) Current C.O. curve
- (5) Prompt message area
- (6) Buttons

2. Proceed as follows to perform the C.O. measure:

- ◆ If **Auto Start** is switched off, select the **Start** button, and then inject the solution quickly when you see the message **Please Wait**. As shown in the figure above, during the measurement, the currently

measured thermodilution curve is displayed. At the end of the measurement, the thermodilution curve is transferred to one of the 6 measurement windows and the monitor prompts you to wait for a certain period of time before starting a new measurement.

- ◆ If **Auto Start** is switched on, inject the solution quickly when you see the message **Ready For New Set Of Measurements**. The monitor consecutively takes C.O. measurements automatically without the need for pressing the **Start** button between two measurements. A new thermodilution measurement is possible as soon as the message **Inject Now!** is displayed on the screen. The monitor automatically detects further thermodilution measurements.
3. Acquire the average value of C.O. and C.I. A maximum of 6 measurements can be stored. Select from the 6 measurement curves and the system will automatically calculate and display the averaged C.O. and C.I. values. Then select the **Accept Average** button to accept and store the averaged values.

When injecting, the stopcock to the thermodilution catheter is open and the stopcock to the injectate solution is closed. After completing the measurement, turn off the stopcock to the thermodilution catheter and turn on the stopcock to the injectate solution, and then draw the injectate solution into the injectate syringe.

The button area also provides you with the following functions:

- Select **Stop** to stop the current measurement.
- Select **Setup** to enter the **C.O.** menu.
- Select **Hemo Calcs** to enter the **Calculations** menu.

NOTE

- **Starting a measurement without blood temperature being stable may cause measurement failure.**
 - **The TB alarms are inactivated during a C.O. measurement, and will be reactivated automatically after the completion of C.O. measurement.**
 - **Please see the Instructions for Use of thermodilution catheter to determine the Comp Const and the volume of injectate solution.**
-

16.7 Changing C.O. Settings

16.7.1 Setting C.O. Alarm Properties

To set the C.O. alarm properties, follow this procedure:

1. Select the C.O. numeric area to enter the **C.O. Measure** menu.
2. Select **Setup** to enter the **C.O.** menu.
3. Select the **Alarm** tab.
4. Enter the password if required.
5. Set alarm properties as desired.

16.7.2 Selecting the Primary C.O. Parameter

You can select C.O. or C.I. as the main C.O. parameter. The measurement of the primary parameter displays in larger numerics. To do so, follow this procedure:

1. Select the C.O. parameter area to enter the **C.O. Measure** menu.
2. Select the **Setup** tab.
3. Set **Primary Parameter**.

16.8 C.O. Troubleshooting

This section lists the problems that might occur. If you encounter the problems when using the equipment or accessories, check the table below before requesting for services. If the problem persists, contact your service personnel.

NOTE

- For the physiological and technical alarm messages, see *D Alarm Messages*.

Problem	Solution
Do not see C.O. numeric area on the main screen	<ol style="list-style-type: none">1. Check that the C.O. is set to display in the Screen Setup menu. For more information, see 3.11.2 <i>Displaying Parameter Numerics and Waveforms</i>.2. Check that if the C.O. parameter switch is enabled. If not, enable the C.O. measurement. For more information, see 3.11.1 <i>Switching On or Off a Parameter</i>.3. Check that the patient type is adult.4. Check the connection of C.O. cable, thermodilution catheter and TI sensor.
C.O. value is inaccurate	<ol style="list-style-type: none">1. Check that the thermodilution catheter is positioned properly.2. Check that the computational constant is proper for current injectate temperature, injectate volume and injectate probe type.3. Inject solution rapidly and smoothly.4. Finish injection within four to five seconds.5. Inject more volume, or inject colder solution.6. Check that the height and weight of patient is properly configured.7. If Auto TI is switched off, check that the entered temperature is correct.
C.O. measurement fails	<ol style="list-style-type: none">1. Inject more volume, or inject colder solution. Make sure that the injectate temperature is at least 10°C colder than the patient blood temperature.2. Finish injection within four to five seconds.3. Check the connection of C.O. cable, thermodilution catheter and TI sensor.

This page intentionally left blank.

17 Monitoring Carbon Dioxide (CO₂)(for uMEC 70/uMEC 80/uMEC 120/uMEC 150)

17.1 CO₂ Introduction

CO₂ monitoring is a continuous, non-invasive technique for determining the concentration of CO₂ in the patient's airway by measuring the absorption of infrared (IR) light of specific wavelengths. CO₂ has its own absorption characteristic and the amount of light passing the gas probe depends on the concentration of the measured CO₂. When a specific band of IR light passes through respiratory gas samples, some of IR light will be absorbed by the CO₂ molecules. The amount of IR light transmitted after it has been passed through the respiratory gas sample is measured with a photodetector. From the amount of IR light measured, the concentration of CO₂ is calculated.

The following two methods are used for CO₂ monitoring:

- Mainstream CO₂ method: the CO₂ sensor is inserted on the airway adapter which is directly connected to the patient's airway. The mainstream CO₂ measurement can be used, with specified accessories, with intubated patients.
- Sidestream/microstream CO₂ method: a sample line is used to take the respiratory gas from the patient's airway. The CO₂ sensor is built into the CO₂ module. The sidestream and microstream CO₂ modules can be used with intubated and non-intubated patients. With intubated patients, the respiratory gas is sampled from the patient's breathing circuit through an airway adapter and an airway sampling line. With non-intubated patients, the gas is sampled through a nasal simple line.

CO₂ monitoring is intended for adult, pediatric and neonatal patients.

17.2 CO₂ Safety Information

WARNING

- **Route all tubing away from the patient's throat to avoid strangulation.**
-

CAUTION

- **Remove the airway sample line from the patient's airway while nebulized medications are being delivered.**
 - **EtCO₂ values measured from the CO₂ module may differ from those of from the blood gas analysis.**
-

NOTE

- **The CO₂ module automatic suppresses physiological alarms until breathing waves have been detected. Make sure that a patient is properly connected when monitoring with the CO₂ module.**
-

17.3 CO₂ Measurement Limitations

The following factors may influence the measurement accuracy:

- Leaks or internal venting of sampled gas
- Mechanical shock
- Cyclic pressure up to 10 kPa (100 cmH₂O)
- Other sources of interference, if any

Measurement accuracy of the sidestream CO₂ module may be affected by the breath rate and inspiration/expiration (I/E) ratio. Measurement accuracy of the microstream CO₂ module may be affected by the breath rate. For more information, see A.13.9 CO₂ Specifications (for uMEC 70/uMEC 80/uMEC 120/uMEC 150).

17.4 CO₂ Display

The CO₂ numeric and waveform area provide FICO₂ measurement, EtCO₂ measurement, awRR measurement, and a CO₂ waveform.

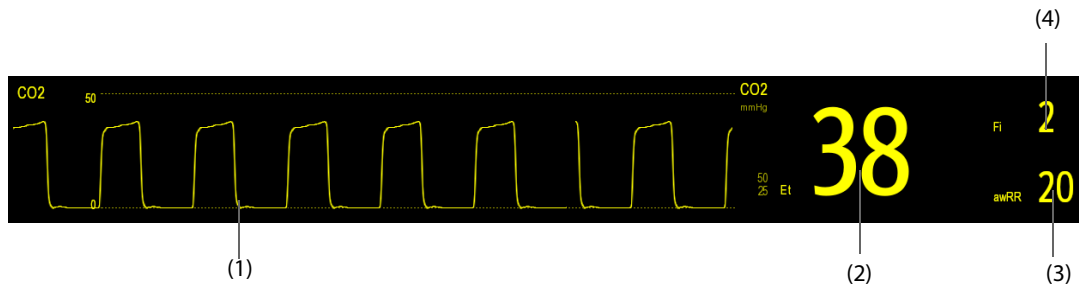

(1) CO₂ waveform

(2) End tidal CO₂ value (EtCO₂)

(3) Airway respiration rate (awRR)

(4) Fraction of inspired CO₂ (FiCO₂)

17.5 Measuring CO₂ Using Sidestream/Microstream CO₂ Module

17.5.1 Preparing to Measure CO₂ Using Sidestream CO₂ Module

To prepare the CO₂ module for measurement, follow this procedure:

1. Select the appropriate gas sample line and watertrap according to the patient category.
2. Connect the DRYLINE II watertrap to the CO₂ module, and connect the gas sample line to the watertrap.

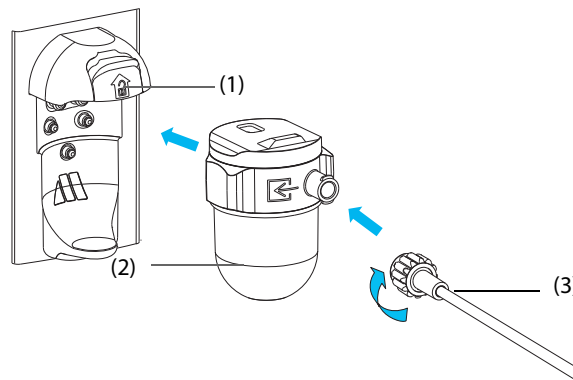

(1) Watertrap receptacle

(2) DRYLINE II watertrap

(3) Gas sample line

3. Connect the other end of the gas sample line to the patient.
 - ◆ For intubated patients requiring an airway adapter, install the airway adapter between the patient circuit and the ventilator Y-piece.

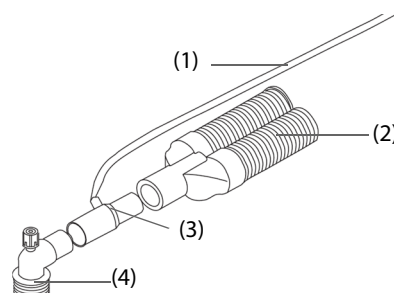

- ◆ For non-intubated patients, place the nasal cannula onto the patient.

(1) Sample line

(2) Connect to the ventilator

(3) Airway adapter

(4) Connect to the patient

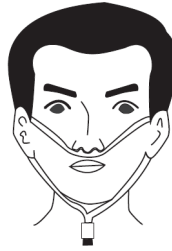

4. Connect the gas outlet to the scavenging system using an exhaust tube.

After the watertrap is connected, it enters measure mode by default and the monitor displays **CO₂ Starting**. CO₂ can be measured after the start-up is complete.

WARNING

- Do not apply adult or pediatric watertrap to the neonate patient. Otherwise, patient injury could result.
 - Connect the gas outlet to the scavenging system when measuring CO₂ using the sidestream CO₂ module.
-
-

CAUTION

- Leakage in the breathing or sampling system may cause the EtCO₂ readings to be significantly low. Always make sure that all the connections are tight and there is no leak in the system.
 - Inspect the airway adapter for a tight connection and proper operation before attaching it to the patient.
 - Squeezing or bending the sample line during the sidestream or microstream CO₂ measurement may cause inaccurate CO₂ reading or no reading.
 - To avoid blocking the airway, empty the DRYLINE II watertrap container whenever half full. Dispose of accumulated fluids in accordance with hospital policy or your local regulations.
 - The DRYLINE II watertrap has a filter preventing bacterium, water and secretions from entering the module. Extended use could destroy the filter in watertrap and fail to stop the bacterium, water and secretions entering the module, result in damaging the gas module and having infection risk. Replacing the DRYLINE II watertrap once a month is recommended.
-

NOTE

- To extend the lifetime of the watertrap and module, disconnect the watertrap from the module and set the operating mode to Standby mode when CO₂ monitoring is not required.
 - The sample rates are different when different types of watertraps are used.
 - The emptying interval of the DRYLINE II adult/pediatric watertrap is 26 hours @ 120 ml/min, sample gas of 37 °C, room temperature of 23 °C, and 100% RH.
 - The emptying interval of the DRYLINE II neonatal watertrap is 35 hours @ 90 ml/min, sample gas of 37 °C, room temperature of 23 °C, and 100% RH.
-

17.5.2 Preparing to Measure CO₂ Using Microstream CO₂ Module

To prepare the CO₂ module for measurement, follow this procedure:

1. Connect one end of the sample line to the microstream CO₂ module.

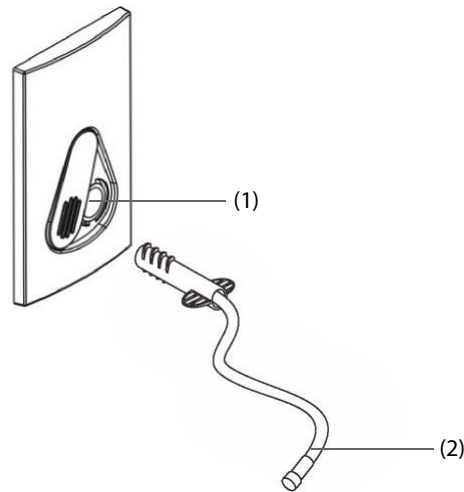

(1) Sample line connector

(2) Sample line

2. Connect the other end of the sample line to the patient.
 - ◆ For intubated patient requiring an airway adapter, install the airway adapter between the patient circuit and the ventilator Y-piece.
 - ◆ For non-intubated patient, place the nasal cannula onto the patient.
 - ◆ For patient prone to mouth breathing, place the oral-nasal cannula onto the patient.
3. Connect the gas outlet to the a scavenging system using an exhaust tube.

After the sample line is connected, it enters measure mode by default and the monitor displays **CO₂ Sensor Warmup**. CO₂ can be measured after the start-up is complete.

CAUTION

- **Connect the gas outlet to the scavenging system when measuring CO₂ using the microstream CO₂ module.**

NOTE

- **Disconnect the sample line from the module when CO₂ monitoring is not required.**
-

17.5.3 Zeroing the Sidestream/Microstream CO₂ Module

The sidestream and microstream CO₂ modules perform a zero calibration automatically when needed. Once the zero calibration is started, the CO₂ module stops measuring and **"Zeroing"** is displayed in the CO₂ numeric area.

After the zero calibration is completed, the CO₂ module reacquires the CO₂ readings. During the reacquisition period, **"Zero Recovering"** is displayed in the CO₂ numeric area. Valid data will reappear 30 seconds after the zero calibration is started. You can hide the display of the **"Zero Recovering"** message, but values displayed during the reacquisition period may not be accurate.

The automatic zero calibration will not start under the following conditions:

- Physiological alarms related to CO₂ are active.
- An apnea alarm is active.
- No breath has been detected for over 30 seconds.

You can also perform the zero calibration manually. For more information, see 23.6.2 *The CO₂ Tab (for uMEC 70/ uMEC 80/uMEC 120/uMEC 150)*.

17.6 Measuring CO₂ Using Mainstream CO₂ Module

17.6.1 Preparing to Measure CO₂ Using Mainstream CO₂ Module

To prepare the CO₂ module for measurement, follow this procedure:

1. Connect the airway adapter to the sensor head.

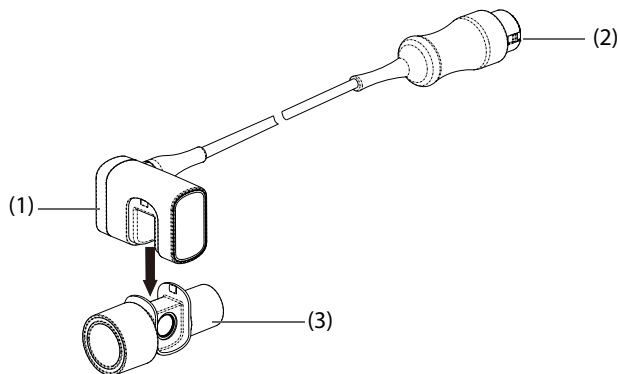

(1) Sensor

(2) Connect to module

(3) Airway adapter

2. Attach the sensor connector to the CO₂ connector on the mainstream CO₂ module.
3. Zero the sensor after the warm-up is finished. For more information, see 17.6.2 *Zeroing the Mainstream CO₂ Sensor*.
4. After the zero calibration is finished, connect the airway as shown below.

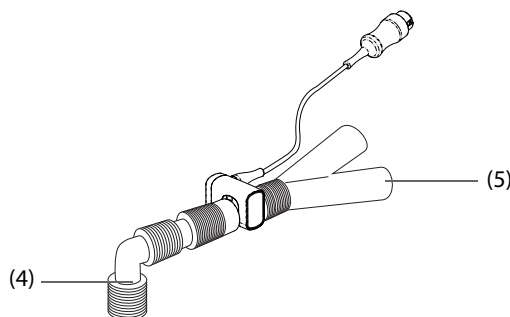

(4) Connect to patient

(5) Connect to ventilator

5. Make sure that no leakages are in the airway and then start a measurement.

NOTE

- **Be sure to set the barometric pressure properly before using the mainstream CO₂ module. Improper settings will result in erroneous CO₂ reading.**
- **Always position the sensor with the adapter in an upright position to avoid collection of fluids in the windows of the adapter. Large concentrations of fluids at this point will obstruct gas analysis.**
- **To avoid dead space, place the sensor as close to the patient as possible.**

17.6.2 Zeroing the Mainstream CO₂ Sensor

For mainstream CO₂ modules, the sensor should be zeroed in the following conditions:

- Before each measurement.
- A new adapter is used.
- Reconnect the sensor to the module.
- The message **CO2 Zero Required** displays. In this case, check the airway adapter for any blockage, e.g. mucus, etc. If a blockage is detected, clear or replace the adapter.

To zero the sensor, follow this procedure:

1. Connect the sensor to the module.
2. In the **CO2** menu, select **Setup** tab.
3. Set the **Operating Mode** to **Measure**. The message **CO2 Sensor Warmup** is displayed.
4. After warm-up is finished, connect the sensor to a clean, dry airway adapter. The adapter should be vented to the air and isolated from CO₂ sources, such as ventilator, the patient's breathing, your own breathing, etc.
5. Select **Zero** in the **CO2** menu. The message **Zeroing** is displayed.

It takes about 15 to 20 seconds. The message disappears when the zero calibration is completed.

WARNING

- **When perform a zero calibration during the measurement, disconnect the sensor from the patient's airway first.**
 - **Do not rely on the readings during CO₂ zeroing.**
-
-

17.7 Changing Settings for All CO₂ Modules

17.7.1 Changing CO₂ Alarm Settings

To change the CO₂ alarm settings, follow this procedure:

1. Select the CO₂ numeric area or waveform area to enter the **CO2** menu.
2. Select the **Alarm** tab.
3. Enter the password if required.
4. Set alarm properties as desired.

17.7.2 Setting the CO₂ Waveform

To set the CO₂ waveform, follow this procedure:

1. Select the CO₂ numeric area or waveform area to enter the **CO2** menu.
2. Select the **Setup** tab.
3. Set **Waveform Type**, **Speed**, **Scale**, or **CO2 Scale** of the CO₂ waveform.

17.7.3 Setting the RR Source

To set the respiration rate (RR) source, follow this procedure:

1. Select the CO₂ numeric area or waveform area to enter the **CO2** menu.
2. Select the **Setup** tab.
3. Set **RR Source**.

When the current RR source does not have valid measurement, the system will automatically switch **RR Source** to **Auto**.

17.7.4 Entering the Standby Mode

You can set the CO₂ module to one of the following modes according to the module status:

- Select **Measure** mode when you use the CO₂ module for monitoring.
- Select **Standby** mode when you do not use the CO₂ module to prolong the service life of the CO₂ module.

The default operating mode is **Measure**. If you are not using the CO₂ module, you can proceed as follows to enter the Standby mode:

1. Select the CO₂ numeric area or waveform area to enter the **CO2** menu.
2. Select the **Setup** tab.
3. Set **Operating Mode** to **Standby**.

17.7.5 Entering the Intubation Mode

When performing intubation during general anesthesia, you can enter the intubation mode in order to reduce unnecessary alarms. To enter the intubation mode, follow this procedure:

1. Select the CO₂ numeric area or waveform area to enter the **CO2** menu.
2. Select **Intubation Mode**.

For the details of the intubation mode, see 8.13 *Intubation Mode*.

17.8 Changing Settings for Sidestream and Microstream CO₂ Module

17.8.1 Setting the Auto Standby

The monitor enters standby mode automatically after the configured period of time if no breath is detected since the last detected breath. To set the auto standby, follow this procedure:

1. Select the CO₂ numeric area or waveform area to enter the **CO2** menu.
2. Select the **Setup** tab.
3. Set **Auto Standby**.

17.8.2 Setting Humidity Compensation

The presence of humidity in breathing circuit may raise the CO₂ reading. For the sidestream and microstream CO₂ module, you can switch humidity compensation on or off to correct the CO₂ reading according to the actual condition.

- Body Temperature and Pressure Saturated Gas (BTPS), or wet gas
- Ambient Temperature and Pressure Dry (ATPD), or dry gas

The CO₂ partial pressure is calculated as follows:

- ATPD: $P_{CO_2}(mmHg) = CO_2(vol\%) \times P_{amb}/100$
- BTPS (sidestream): $P_{CO_2}(mmHg) = CO_2(vol\%) \times (P_{amb} - 47)/100$
- BTPS (microstream): $P_{CO_2}(mmHg) = CO_2(vol\%) \times (1 - 0.03) \times P_{amb}/100$

Where, $P_{CO_2}(mmHg)$ = partial pressure, $vol\%$ = CO₂ concentration, P_{amb} = ambient pressure, and unit is mmHg.

To set the humidity compensation, follow this procedure:

1. Select the CO₂ numeric area or waveform area to enter the **CO2** menu.
2. Select the **Setup** tab.
3. Set **BTPS Compensation**.
 - ◆ Switch on for BTPS.
 - ◆ Switch off for ATPD.

17.9 Setting the Gas Compensation

The presence of interfering gas affects the CO₂ measurement. To get the best possible measuring result, it is needed to set the gas compensation. The configured concentration of the interfering gas should be in accordance with its actual proportion.

For the microstream CO₂ module, gas compensations are not required.

WARNING

- **Make sure to use the appropriate compensations. Inappropriate compensations may cause inaccurate measurement values and result in misdiagnosis.**
-
-

For the sidestream CO₂ module, follow this procedure to set the gas compensation:

1. Select the CO₂ numeric area or waveform area to enter the **CO2** menu.
2. Select the **Setup** tab.
3. Set the compensation according to the actual condition.

For the mainstream CO₂ module, follow this procedure to set the gas compensation:

1. Select the CO₂ numeric area or waveform area to enter the **CO2** menu.
2. Select the **Setup** tab.
3. Set the following compensation according to the actual condition.

■ **Balance Gas**

- ◆ Select **Room Air** when air predominates in the ventilation gas mixture.
- ◆ Select **N2O** when N₂O predominates in the ventilation gas mixture.
- ◆ Select **He** when He predominates in the ventilation gas mixture.

■ **O2 Compensation**

- ◆ Select **Off** when the amount of O₂ is less than 30%.
- ◆ Select an appropriate setting according to the amount of O₂ in the ventilation gas mixture.

- **AG Compensation:** enters the concentration of anesthetic gas present in the ventilation gas mixture. This could compensate for the effect of AG on the readings.

17.10 Choosing a Time Interval for Peak-Picking

For microstream and mainstream CO₂ modules, you can select a time interval for picking the highest CO₂ as the EtCO₂ and the lowest as the FiCO₂.

To set the time interval, follow this procedure:

1. Select the CO₂ numeric area or waveform area to enter the **CO2** menu.
2. Select the **Setup** tab.
3. Set **Maximum Hold**.
4. Toggle between **Single Breath, 10 s, 20 s** and **30 s** if microstream CO₂ module is configured; toggle between **Single Breath, 10 s** and **20 s** if mainstream CO₂ module is configured.
 - ◆ **Single Breath:** EtCO₂ and FiCO₂ are calculated for every breath.
 - ◆ **10 s, 20 s, or 30 s:** EtCO₂ and FiCO₂ are calculated using 10, 20 or 30 seconds of data.

17.11 Changing Barometric Pressure

Both sidestream and microstream CO₂ modules have the function of automatic barometric pressure compensation (the system automatically measures the barometric pressure to which the patient monitor is exposed). However, the mainstream CO₂ module does not have such function. For the mainstream CO₂ module, the default barometric pressure is 760 mmHg. You must modify the barometric pressure based on the actual situation.

This function is password protected. For more information, see *23.11 The Other Settings*.

WARNING

- **Be sure to set the barometric pressure properly before using the mainstream CO₂ module. Improper settings will result in erroneous CO₂ reading.**
-
-

17.12 Performing the Leakage Test

When measuring CO₂ using the sidestream CO₂ module, leakage test is required every time before the CO₂ measurement. To perform the CO₂ leakage test, follow this procedure:

1. Connect the measuring accessories as per section 17.5.1 *Preparing to Measure CO₂ Using Sidestream CO₂ Module*.
2. Wait until the startup finishes. Completely block the gas inlet on the sidestream CO₂ module or on the N1. Then the alarm message "**CO₂ Airway Occluded**" will appear on the screen.
3. Block the gas inlet for another one minute.
4. Select the **Main Menu** hard key or quick key → from the **System** column select **Maintenance** → input the required password → select .
5. Select the **Module** tab → **CO₂** tab.
6. Check that the current flow rate is less than 10ml/min, and the alarm message "**CO₂ Airway Occluded**" does not disappear. This indicates that the module does not leak. If the alarm message disappears, or the flow rate is equal to 10ml/min or greater, it indicates that the module leaks. Perform the leakage test again. If the problem remains, contact your service personnel for help.

17.13 CO₂ Calibration

For sidestream and microstream CO₂ modules, a calibration is needed every year or when the measured values have a great deviation. For mainstream CO₂ module, no calibration is needed.

To calibrate the CO₂ module, contact the service personnel.

CAUTION

- **Connect the gas outlet to the scavenging system when calibrating the CO₂ module.**
-

17.14 CO₂ Troubleshooting

This section lists the problems that might occur. If you encounter the problems when using the equipment or accessories, check the table below before requesting for services. If the problem persists, contact your service personnel.

NOTE

- **For the physiological and technical alarm messages, see *D Alarm Messages*.**
-

17.14.1 Troubleshooting the Sidestream/Microstream CO₂ Module

Problem	Solution
EtCO ₂ measurements too low	<ol style="list-style-type: none">1. Ventilate the room if the environmental CO₂ concentration is too high.2. Check the sample line and connectors for leakage.3. Check the patient status.

17.14.2 Troubleshooting the Mainstream CO₂ Module

Problem	Solution
Elevated baseline	1. Check the patient status. 2. Check the sensor.

17.15 Oridion Information

Microstream

This trademark is registered in Israel, Japan, German and America.

Oridion Patents

The capnography component of this product is covered by one or more of the following US patents: 6,428,483; 6,997,880; 6,437,316; 7,488,229; 7,726,954 and their foreign equivalents. Additional patent applications pending.

No Implied License

Possession or purchase of this device does not convey any express or implied license to use the device with unauthorized CO₂ sampling consumables which would, alone, or in combination with this device, fall within the scope of one or more of the patents relating to this device and/or CO₂ sampling consumable.

18 Review

18.1 Review Overview

The monitor provides the patient's trends to help you evaluate how the patient's condition is developing.

18.2 Review Page

The **Review** page contains tabs to display trend data in tabular, graphic, or other forms.

18.2.1 Accessing the Review Page

To enter the review page, choose any of the following ways:

- Select the **Review** quick key → select the desired tab. If reviewing patient data is password protected, input the monitor's clinical password (local password).
- Select the **Main Menu** hard key or quick key → from the **Review** column select the desired option. If reviewing patient data is password protected, input the monitor's clinical password (local password).

18.2.2 Example Review Page

The review pages have similar structure. The **Graphic Trends** review page is taken as an example.

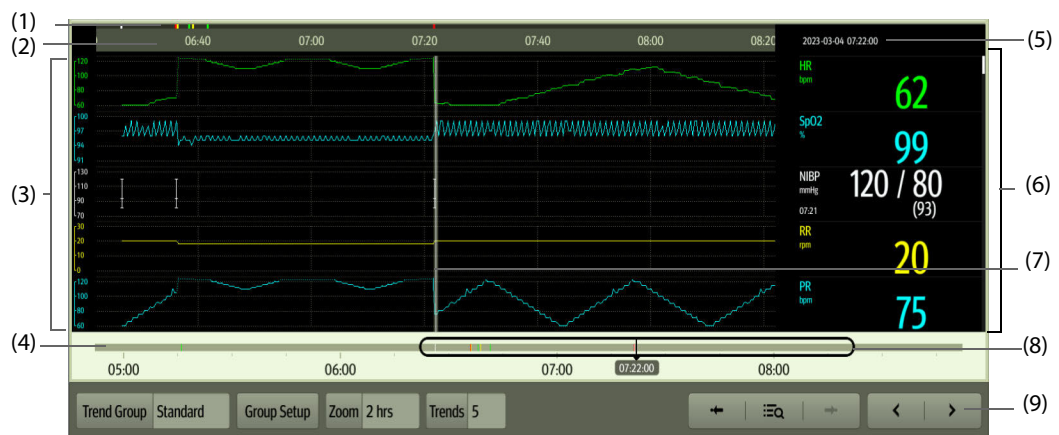





- (1) Event type indicator: different color blocks match different types of events:
 - Red: high priority alarm event
 - Yellow: medium priority or low priority alarm event
 - Green: manual event
 - White: operation-related event
- (2) Current window time line: indicates the time length of the current window.
- (3) Waveform area: displays trend curves. The color of trend curves is consistent with the color of parameter labels.
- (4) Time line: indicates the entire time length.
 - : indicates the time length of reviewable trend data. can be moved within this time length.
 - : indicates the time length of no trend data. cannot be moved within this time length.
 - Different color blocks at the time line indicate events of different types. See the color definition for the event type indicator.
- (5) Event area: displays the event of the cursor time. Selecting the event accesses the event list. If there is no event at the cursor time, the cursor time is displayed.

- (6) Numeric area: displays numeric values at the cursor indicated time. The background color of numeric values matches the alarm priority.
- (7) Cursor
- (8) Slider: indicates the position of current window time in the entire time length. Dragging this button left or right enables you to locate the trend data at a specific time and also refreshes trend data in current window accordingly.
- (9) Button area

18.2.3 Symbols on Review Pages

The following table lists the symbols on review pages.

Symbol	Description
	Slider: indicates the position of current window time in the entire time length. Dragging the slider left or right enables you to locate the trend data at a specific time and also refreshes data in current window accordingly.
	Goes to the previous or next event.
	Event list: displays events in a chronological order. The most recent event is displayed at the top. The number of exclamation symbols before an event matches alarm priority.
	Record button: select it to output patient information and data through the recorder.
	Print button: select it to output patient information and data through the printer.

18.2.4 Common Operations

This section describes common operations for all review pages.



18.2.4.1 Browsing Trend Data

To browse trend data, choose any of the following ways:

- Move the cursor.
- Move the slider .
- Slide your finger on the screen.

18.2.4.2 Viewing Events

To view events, choose either of the following ways:

- Select  and select the desired event.
- Select  to view the previous or next event.

18.2.5 Tabular Trends Review Page

The tabular trends review page displays trend data in a tabular form.

18.2.5.1 Entering the Tabular Trends Review Page

To enter the **Tabular Trends** review page, choose any of the following ways:

- Select the **Review** quick key → select the **Tabular Trends** tab.
- Select the **Main Menu** hard key or quick key → from the **Review** column select **Tabular Trends**.

18.2.5.2 Changing the Tabular Trend Group

To change the tabular trend group, follow this procedure:

1. Enter the **Tabular Trends** review page.

2. Set **Trend Group**.

18.2.5.3 Editing the Tabular Trend Group

The setting of the **Trend Group** defines the contents of displayed and printed trends. To edit the tabular trend group, follow this procedure:

1. Enter the **Tabular Trends** review page.
2. Select **Group Setup** → select the desired tab.

NOTE

- **You cannot edit trend group labeled All or Standard.**
 - **ECG parameter and waveform are always displayed in the first row on the trend page. It cannot be deleted or moved.**
-

18.2.5.4 Changing the Resolution of Trend Data

The resolution of tabular trends defines the interval of displaying trend data. Short interval is suit for patients, for example the neonate, whose clinical situation changes quickly. Longer interval is more appropriate for patients, for example the adult, whose status changes more gradually.

To change the interval of trend data, follow this procedure:

1. Enter the **Tabular Trends** review page.
2. Select **Interval**.
 - ◆ **5 sec or 30 sec:** select to view up to 4 hours of tabular trends at an interval of 5 seconds or 30 seconds.
 - ◆ **1 min, 5 min, 10 min, 15 min, 30 min, 1 hr, 2 hrs, or 3 hrs:** select to view up to 120 hours of tabular trends at selected interval.
 - ◆ Select parameters, such as NIBP, C.O. to view the tabular trends when parameter measurements are acquired.

18.2.5.5 Printing a Tabular Trends Report

To print a tabular trends report, follow this procedure:

1. Enter the tabular trends review page.
2. Select  at the upper left corner of the review page to enter the **Print Setup** menu.
3. Set the tabular trends report as described in 22.6.3 *Setting Tabular Trends Reports*.
4. Select **Print**.

18.2.6 Reviewing the Graphics Trends

The **Graphic Trends** review page displays trend data in a graphic form.

18.2.6.1 Entering the Graphic Trends Review Page

To enter the **Graphic Trends** review page, choose any of the following ways:

- Select the **Review** quick key → select the **Graphic Trends** tab.
- Select the **Main Menu** hard key or quick key → from the **Review** column select **Graphic Trends**.

18.2.6.2 Changing the Graphic Trend Group

To change the graphic trend group, follow this procedure:

1. Enter the **Graphic Trends** review page.
2. Set **Trend Group**.

18.2.6.3 Editing the Graphic Trend Group

The setting of the **Trend Group** defines the contents of displayed and printed trends. To edit the graphic trend group, follow this procedure:

1. Enter the **Graphic Trends** review page.
2. Select  and select **Group Setup**.
3. Select the desired tab.

18.2.6.4 Changing the Resolution of Trend Data

To change the length of trend data displayed on the current screen, follow this procedure:

1. Enter the **Graphic Trends** review page.
2. Select **Zoom**.
 - ◆ **8 min:** the screen displays eight minutes of trend data. You can view the recent one hour data.
 - ◆ **30 min, 1 hr, 2 hrs, 4 hrs:** the screen displays 30 minutes, one hour, two hours, or four hours of trend data. You can view the recent four hour data.
 - ◆ **8 hrs, 12 hrs, 24 hrs, 48 hrs:** the screen displays eight hours, 12 hours, 24 hours, or 48 hours of trend data. You can view the recent 120 hours of data.

18.2.6.5 Changing the Number of Waveforms

To change the number of waveforms displayed on the trend review page, follow this procedure:

1. Enter the **Graphic Trends** review page.
2. Select  and select **Trends**.
3. Set **Trends**.

18.2.6.6 Printing a Graphic Trends Report

Before print a graphic trends report, set the **Graphic Trends** report as described in 22.6.3 *Setting Tabular Trends Reports*.

To print a **Graphic Trends** report, follow this procedure:

1. Enter the **Graphic Trends** review page.
2. Select  to enter the **Print Setup** menu.
3. Select **Print**.

18.2.7 Reviewing Events

The monitor stores events in real time, including technical alarm events, physiological alarm events, manual events, and operational events. When an event occurs, all the measurement numerics and three event-related waveforms 16 seconds before and after the event are stored.

NOTE

-
- **A total loss of power has no impact on the events stored.**
 - **Alarms are saved as events and will be maintained if the equipment is powered down. The time of equipment power down is not recorded as an event and cannot be reviewed.**
 - **Earlier events will be overwritten by later ones if the capacity is reached.**
-

18.2.7.1 Entering the Events Review Page

To enter the **Events** review page, choose any of the following ways:

- Select the **Review** quick key → select the **Events** tab.
- Select the **Main Menu** hard key or quick key → from the **Review** column select **Events**.

18.2.7.2 Configuring the Filter

You can filter events to facilitate event review. To configure the filter, follow this procedure:

1. Enter the **Events** page.
2. Select **Filter**. From the drop-down list, select the desired item.

You can customize two criteria. To do so, follow this procedure:

1. From the **Filter** drop-down list, select **Custom 1** or **Custom 2** to enter the **Filter Setup** menu.
2. Select the **Name** field to edit the name of the custom criterion.
3. Select desired items.

If you want to review events happened around certain time, select  → set the time → select **OK**. Then the cursor jumps to the event happened closest to the defined time.

18.2.7.3 Editing Events

To edit events, follow this procedure:

1. Enter the **Events** page and tick off the desired events.
2. Select  to edit the selected events.
 - ◆ **Lock:** manually lock the event. When the event number reaches its maximum, the locked event will not automatically be deleted by the system.
 - ◆ **Unlock:** unlock the event.
 - ◆ **Delete:** delete the event.
 - ◆ **Note:** enter comments for the event.
 - ◆ **Select All:** select all the events.
 - ◆ **Cancel All:** unselect all the events.
 - ◆ **Show Disabled Arrhythmia Alarms:** this options is disabled by default. Selecting this option displays the arrhythmia events whose alarm switch is turned off.
 - ◆ **Rename:** allow renaming an event name. Only manual events and arrhythmia events can be renamed if enabled by the hospital's settings. For more information, see *23.7 The Review Settings*.

18.2.7.4 Viewing Event Details

To view waveforms and parameter values at the event time, follow this procedure:

1. Enter the **Events** review page.
2. Select **Detail**.

To display beat labels on the first ECG waveform, switch on **Beat Anno:** The white beat labels indicate heart beats classification and may explain suspected, missed, or false arrhythmia calls. Heart beats are classified as follows:



- N = Normal
- V = Ventricular ectopic
- S = Supraventricular premature
- P = Paced
- L = Learning
- ? = Insufficient information to classify beats
- I = Inoperative (for example, Lead Off)
- M = Missed beat

18.2.7.5 Printing Event Reports

You can print event reports either via a printer or via a recorder.

To print event reports, follow this procedure:

1. Enter the **Events** review page.

2. Select  to enter the **Print Setup** menu.
 3. Select the desired options.
 - ◆ **Print All Event List:** print the entire event list.
 - ◆ **Print List of Selected Events:** print the list of selected events.
 - ◆ **Print Detail of Selected Events:** print the details of selected events.
 - ◆ **Print Displayed Event Detail:** print the waveforms and parameters of the currently displayed event.
 - ◆ **Print Overview of Selected Events:** print the overview of selected events.
 4. Select **Print**.
- To print a report via a recorder, select .

18.2.8 Reviewing Full Disclosure

You can review up to 120-hour waveform data on the **Full Disclosure** review page. You can view both the compressed waveforms and numeric values.

NOTE

- **U drive is required to review full disclosure, that is, you need to plug U drive into the monitor and set the save path for the review data as USB Drive. For details on how to set the save path for the review data, see 23.7.5 The Save Path Tab.**

18.2.8.1 Entering the Full Disclosure Review Page

To enter the **Full Disclosure** review page, Choose either of the following ways :

- Select the **Review** quick key → select the **Full Disclosure** tab.
- Select the **Main Menu** hard key or quick key → from the **Review** column select **Full Disclosure**.

18.2.8.2 Selecting Waveforms

Before reviewing compressed waveforms, you must select waveforms you want to store and display. To store and display the desired waveforms, follow this procedure:

1. Enter the **Full Disclosure** review page.
2. Select **Setup** to enter the **Select Waveform** page.
3. Select the **Storage** tab and set the desired waveforms to be stored in the monitor. Select the **Display(Maximum: 3)** tab and set the desired waveforms to be displayed on the **Full Disclosure** page.

NOTE

- **The more waveforms selected in the Storage column, the shorter the waveform storage time. The waveforms may not be stored for 120 hours. Please exert caution when selecting waveforms.**

In case of alarms, the background of compressed waveform at the alarm time is highlighted as follows:

- Red: high alarm priority
- Yellow: medium alarm priority or low alarm priority

18.2.8.3 Setting the Scale and Duration

To set the length and size of displayed compressed waveforms, follow this procedure:

1. Enter the **Full Disclosure** review page.
2. Select , and then select **Scale** to set ECG waveform gain.
3. Select **Duration** to set the length of displayed waveforms.

18.2.8.4 Viewing Details of Compressed Waveforms

To view the full waveforms and numeric values, follow this procedure:

1. Enter the **Full Disclosure** review page.
2. Select **Detail**.

You can perform the following operations on the this page:

- Switch on **Beat Anno**: For more information, see *18.2.7.4 Viewing Event Details*.
- Select **...** and set **Speed** and **ECG Gain**, or **Save As Event**.
- Select **Overview** to switch to the compressed waveform page.

18.2.8.5 Printing the Full Disclosure Waveform Report

To print a compressed waveform report, follow this procedure:

1. Enter the **Full Disclosure** review page.
2. Select  and set the time range for printing.
3. Select **Print**.

18.2.9 OxyCRG Review Page

You can review up to 24 hours of trend curves on the OxyCRG review page. The OxyCRG review functionality is applicable for neonatal monitoring only.

18.2.9.1 Entering the OxyCRG Review Page

To enter the OxyCRG review page, choose any of the following ways:

- From the OxyCRG screen, select the ABD events list area.
- Select the **Review** quick key → select the **OxyCRG** tab.
- Select the **Main Menu** hard key or quick key → from the **Review** column select **OxyCRG**.

NOTE

- **OxyCRG Review Page is available only when Patient Category is set to Neo.**

18.2.9.2 The Display of the OxyCRG Review Page

The following figure shows the OxyCRG screen:

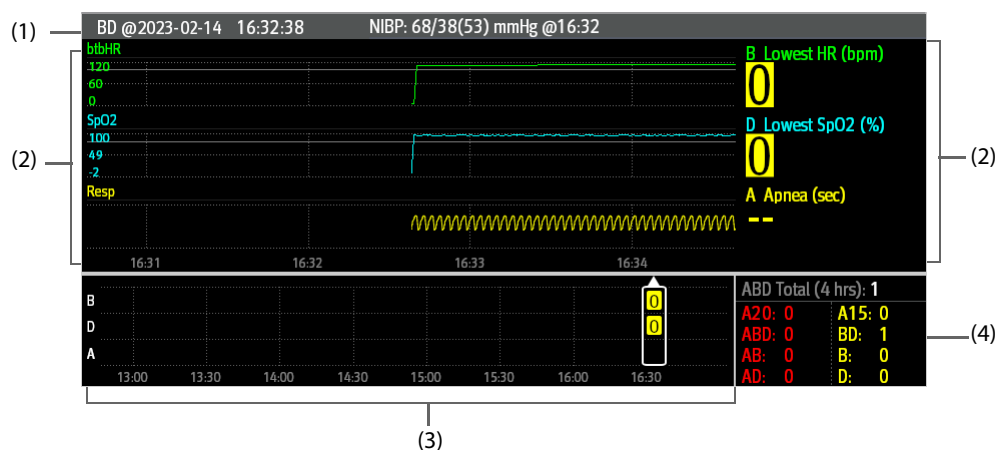

- (1) Event title area: displays information of the selected event, such as the event type and time.
- (2) Event detail area: displays parameter trends, compressed waveform, and parameter values of selected event.
- (3) Event summary area: displays ABD events within the **Zoom** period. The selected event is enclosed in a white frame.

- (4) Event statistics area: displays the total number of ABD events and the numbers of each event within the **Zoom** period.

18.2.9.3 Changing the Resolution of Trend Curves

To set the resolution of trend curves, follow this procedure:

1. Enter the OxyCRG review page.
2. Set **Zoom**.

18.2.9.4 Printing an OxyCRG Review Report

To print an OxyCRG review report, follow this procedure:

1. Enter the OxyCRG review page.
2. Set the desired compressed waveform and duration.
3. Select .

18.2.10 12-Lead ECG Review Page

When 12-lead ECG analysis is performed, you can review the most recent 20 events of 12-lead analysis. For more information, see *10 Resting 12-Lead ECG Analysis*.

18.2.10.1 Entering the 12-Lead Review Page

To enter the 12-lead ECG review page, choose any of the following ways:

- Upon completion of 12-lead ECG analysis, select **Review** from the **12-Lead Interpretation** screen. For more information, see *10 Resting 12-Lead ECG Analysis*.
- Select the **Review** quick key → select **12-Lead ECG**.
- Select the **Main Menu** hard key or quick key → from the **Review** column select **12-Lead ECG**.

18.2.10.2 Setting 12-Lead ECG Waveforms

To set the 12-lead ECG waveforms on the review page, follow this procedure:

1. Enter the 12-lead review page.
2. Set **Speed**, **Gain**, and **Layout**.

18.2.10.3 Printing the 12-Lead ECG Report

To print the 12-Lead ECG report, follow this procedure:

1. Enter the 12-lead review page.
2. Select .
3. Select **Print**.

18.2.11 ST Review Page

When ST analysis is enabled, the monitor saves ST segments and values at an interval of five minutes. You can review the latest 120 hours of ST data.

18.2.11.1 Entering the ST Review Page

To enter the ST review page, choose either of the following ways:

- Select the **Review** quick key → select the **ST** tab.
- Select the **Main Menu** hard key or quick key → from the **Review** column select **ST**.

18.2.11.2 Setting the ST Reference

You can set the currently displayed ST as reference. To do so, follow this procedure:

1. Enter the ST review page.
2. Select **Set Reference**.

NOTE

- **The ST baseline is used as ST reference by default.**
-

18.2.11.3 Displaying/Hiding the ST Reference

To display or hide ST reference, follow this procedure:

1. Enter the ST review page.
2. Select **Display Reference** or **Hide Reference**.

18.2.11.4 Displaying/Hiding Markers

To display or hide markers, follow this procedure:

1. Enter the ST review page.
2. Select **Display Marker** or **Hide Marker**.

18.2.11.5 Printing ST Data

To print ST data, follow this procedure:

1. Enter the ST review page.
2. Select .

18.3 Reviewing Discharged Patients

For discharged patients, you can review the trend data in the review page. You can also review the events and 12-lead ECG analysis results.

18.3.1 Checking the Data of a Discharged Patient

1. Access the **Discharged Patients** dialog box by either of the following ways:
 - ◆ Select the **Discharged Patients** quick key. If viewing discharged patients is password protected, input the user name and password (the user password saved in the MLDAP server).
 - ◆ Select the **Main Menu** hard key or quick key → from the **Patient Management** column select **Discharged Patients**. If viewing discharged patients is password protected, input the user name and password ((the user password saved in the MLDAP server).
2. From the patient list select the desired patient.
3. Select **Detail**. If reviewing patient data is password protected, input the monitor's clinical password (local password).

18.3.2 Checking the Information of a Discharged Patient

1. Access the **Discharged Patients** dialog box by either of the following ways:
 - ◆ Select the **Discharged Patients** quick key. If viewing discharged patients is password protected, input the user name and password (the user password saved in the MLDAP server).
 - ◆ Select the **Main Menu** hard key or quick key → from the **Patient Management** column select **Discharged Patients**. If viewing discharged patients is password protected, input the user name and password ((the user password saved in the MLDAP server).
2. From the patient list select the desired patient.
3. Select **Detail**. If reviewing patient data is password protected, input the monitor's clinical password (local password).

4. Select the  icon to enter the **Patient Management** dialog box.

19 Clinical Assistive Applications (CAA)

The Clinical Assistive Applications (CAA) function integrates some commonly used clinical guidelines and tools into the monitor. It puts the currently monitoring parameter measurements together and provides comprehensive analysis results.

CAA is not intended to replace the competent judgment of a clinician. It must be used in conjunction with observation of clinical signs and symptoms.

19.1 Early Warning Score (EWS)

The Early Warning Scores (EWS) can help you recognize the early sign of deterioration in patients based on vital signs and clinical observations. Recommendations are provided according to the score.

The monitor supports the following scores:

- MEWS (Modified Early Warning Score)
- NEWS (National Early Warning Score)
- NEWS2 (National Early Warning Score 2)
- Custom Score

There are two types of scoring tools:

- **Total score:** A sum of subscores. A subscore is given for each parameter based on the measured or input value. When all the required parameters are measured or input, the subscores are added together to calculate the total score. Each subscore has a color coding to indicate associated level of risk. When the total score is outside of the thresholds, actions are recommended. MEWS, NEWS and NEWS2 can give total scores.
- **IPS (individual parameter score):** A color-coded score is given for each parameter based on the measured or entered value. Each parameter has upper and lower thresholds. When an individual parameter measured or entered is outside of the thresholds, actions are recommended.

Custom Score is based on user-defined parameters. It can be a total score or an IPS, depending on the configuration.

MEWS, NEWS and NEWS2 are intended for adult patients only. The patient category applied to the Custom Score is defined by Mindray Clinical Score Configuration Tool. For more information, see *Mindray Clinical Scoring Config Tool Instruction for Use*.

WARNING

- **EWS should not be used as the sole basis for diagnosis or therapy decisions. It is not intended to replace the competent judgment of a clinician. The EWS scores and recommended actions must be used in conjunction with observation of clinical signs and symptoms.**
- **MEWS and NEWS are not applicable to pregnant woman, COPD (Chronic Obstructive Pulmonary Disease) patients and patients under 16 years old. NEWS2 is not applicable to pregnant woman and patients under 16 years old.**

NOTE

- **A license is required for the EWS function.**
-

19.1.1 Displaying the EWS Numerics Area

To display the EWS numerics area, follow this procedure:

1. Access **Tile Layout** in either of the following ways:
 - ◆ Select the **Screen Setup** quick key → select the **Tile Layout** tab.
 - ◆ Select the **Main Menu** hard key or quick key → from the **Display** column select **Tile Layout**.
2. Select the parameter area where you want to display the EWS score, and then from the popup list select **EWS**.

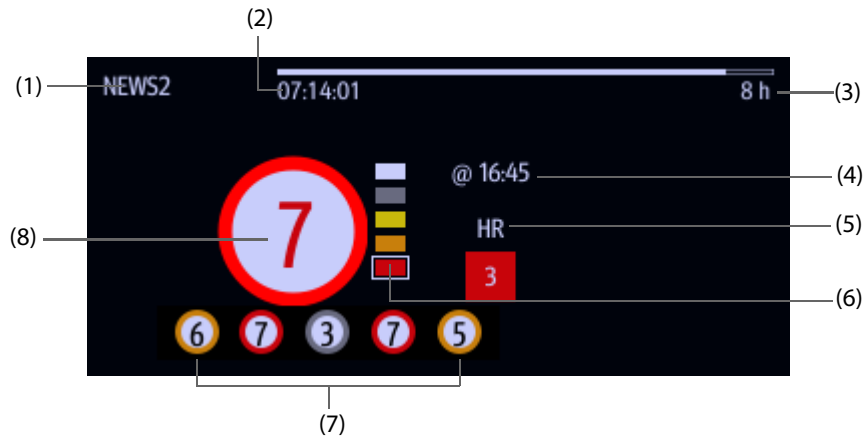

- (1) EWS protocol label
- (2) Scoring countdown: time to the next scoring.
- (3) Scoring interval
- (4) The current scoring time
- (5) Single parameter whose score reaches 3
- (6) Risk level indicator. The level of risk increases from top down. The current level is enclosed by a white square frame. For IPS, this indicator does not display.
- (7) History total score. The rightmost one is the latest history score.
- (8) Total score. The color of the circle indicates the level of risk. For IPS, no score is displayed. Only level of risk is shown: white means normal and red indicates alert.

19.1.2 Accessing the EWS Screen

Access the EWS window in any of the following ways:

- Select the EWS parameter area
- Select the **EWS** quick key.
- Swipe left or right across the touchscreen with two fingers until you switch to the EWS screen.
- Select the **Screen Setup** quick key → select the **Choose Screen** tab → select **EWS**.
- Select the **Main Menu** hard key or quick key → from the **CAA** column select **EWS**.

The following figure shows the EWS screen when the NEWS2 score is used. Your screen may be slightly different due to the configuration.

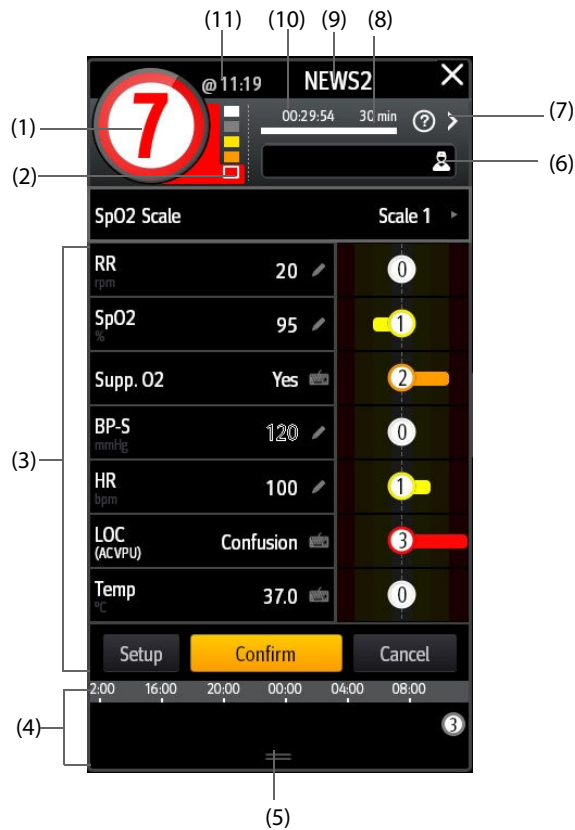

- (1) Total score. The color of the circle indicates the level of risk. For IPS, no numeric score is displayed. Only level of risk is shown: white means normal and red indicates alert by default.
- (2) Risk level indicator. The level of risk increases from top down. The current level is enclosed by a white frame. For IPS, this indicator does not display.
- (3) Parameter area: display the subscore and parameter value of each parameter. The keyboard symbol indicates that the parameter value is manually entered.
- (4) History total scores area: selecting this area or swiping up with a finger can review the trends of total score and each subscore.
- (5) Selecting this button can review the trends of the total score and each subscore.
- (6) Clinician ID (displays only when the Clinician ID is enabled): allows inputting the Clinician ID to associate with the EWS score.
- (7) Select this button to see the clinical response to the current score
- (8) Scoring interval
- (9) EWS protocol label
- (10) Scoring countdown: time to the next scoring.
- (11) The scoring time

19.1.3 Performing EWS Scoring

To perform scoring, follow this procedure:

1. Select **Reset** to clear the previous score and update values of currently monitored parameters and relevant subscores.
2. For NEWS2, set the **SpO2 Scale**.
 - ◆ **Scale 1:** for patient without hypercapnic respiratory failure.
 - ◆ **Scale 2:** for patients with a prescribed oxygen saturation requirement of 88–92% (for example, in patients with hypercapnic respiratory failure).
3. Measure or manually enter other required parameters and observations.

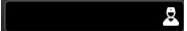
4. If the clinician ID is enabled, input the clinician information by selecting , and then manually entering the information, or by scanning the clinician's barcode.
5. Select **Calculate** to get the total score.
6. If **Score Confirmation** is enabled, select **Confirm** to save current scoring, or select **Cancel** to give up current scoring. For more information, see *19.1.4.2 Setting the Scoring Confirmation Switch*.

CAUTION

- **The decision to use Scale 2 of the SpO2 Scale should be made by a competent clinical decision maker and should be recorded in the patient's clinical notes.**
-

NOTE

- **Before calculating the score, select Reset to clear the previous score.**
 - **The keyboard symbol at the right of the parameter value indicates that the value is manually entered.**
 - **You can get the score only when all required parameters have been measured or entered.**
 - **When a patient is discharged or the monitor is turned off, the clinician ID is cleared.**
-

19.1.4 Changing EWS Settings

19.1.4.1 Changing the Scoring Protocol

The monitor is configured with a default scoring protocol. To change the scoring protocol, follow this procedure:

1. From the EWS page select **Setup**.
2. Set **Score**.

19.1.4.2 Setting the Scoring Confirmation Switch

To select if confirmation is required before saving score, follow this procedure:

1. From the EWS page select **Setup**.
2. Set **Score Confirmation** switch.
 - ◆ **Off:** the monitor automatically saves the scoring result after the scoring is completed.
 - ◆ **On:** you need to confirm that whether the scoring result is saved or not after the scoring is completed.

19.1.4.3 Setting the Manual Data Timeout

The manually input parameter data becomes invalid after a preset time. To set the timeout period for the input data, follow this procedure:

1. From the EWS screen select **Setup**.
2. From the **Manual Data Timeout** area, select a desired parameter and set its timeout period.

NOTE

- **If the data is expired and not updated, the monitor displays the corresponding parameter score in outline font, and gives a timeout alarm.**
-

19.1.4.4 Setting Auto Scoring

The monitor automatically starts scoring at the preset interval. To set auto scoring, follow this procedure:

1. From the EWS screen select **Setup**.
2. Set **Auto Scoring**:
 - ◆ **Interval:** the monitor automatically starts scoring at the preset interval.
 - ◆ **NIBP:** the monitor automatically starts scoring at the completion of each NIBP measurement.

- ◆ **Alarm:** the monitor automatically starts scoring when an alarm occurs to the parameter for scoring.
- ◆ If no option is selected, the monitor does not initiate auto scoring.

19.1.4.5 Setting Auto Scoring Interval

1. From the EWS screen select **Setup**.
2. Set **Interval**:
 - ◆ **By Score:** the monitor automatically starts scoring as per the interval selected for corresponding total score.
 - ◆ **5 min - 24 h:** If **Auto Scoring** is set to **Interval**, the monitor automatically starts scoring as per the selected interval. If **Auto Scoring** is not set to **Interval**, the countdown timer of manual scoring is selected.

19.1.5 Viewing Historical Scores

From the EWS screen, you can view the total score or subscores of the recent 24 hours. To do so, choose either of the following ways:

- Select the history total score area.
- From the history total score area, swipe up with a finger.

For the position of the history total score area, see *19.1.2 Accessing the EWS Screen*.

19.2 Glasgow Coma Scale (GCS)

The Glasgow Coma Scale (GCS) function is based on 1974_Lancet_Teasdale Assessment of Coma and Impaired Consciousness-A Practical Scale. Three aspects of behavior are independently measured: eye opening, verbal response, and motor response. The scores are added together to indicate that patient's level of consciousness.

GCS is intended for adults and pediatric patients.

CAUTION

- **GCS is intended as an adjunct in patient assessment and must be used in conjunction with observation of clinical signs and symptoms.**
 - **GCS is not applied to patients that are sedated, muscularly relaxed, with artificial airway, drunk, or in status epilepsies.**
 - **GCS is not applied to deaf people and patients having language barrier or with mental disorder.**
 - **When applied to children younger than five years old or elder people who are slow, the GCS score might be low.**
-

19.2.1 Displaying the GCS Parameter Area

To display the GCS parameter area, follow this procedure:

1. Access **Tile Layout** in either of the following ways:
 - ◆ Select the **Screen Setup** quick key → select the **Tile Layout** tab.
 - ◆ Select the **Main Menu** hard key or quick key → from the **Display** column select **Tile Layout**.
2. Select the parameter area where you want to display the GCS score, and then from the popup list select **GCS**.

The following figure shows the GCS parameter area.

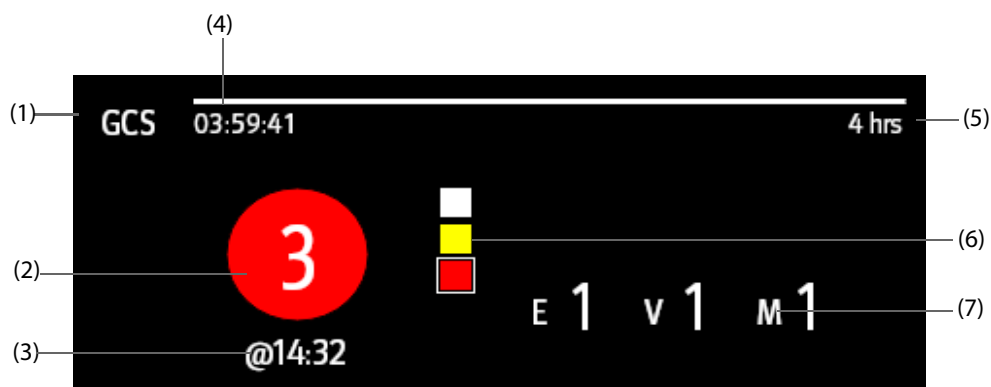

- (1) GCS label
- (2) Total score and level of consciousness. The color of the circle indicates the level of risk.
- (3) Scoring time
- (4) Scoring countdown: time to the next scoring.
- (5) Scoring interval
- (6) Risk level indicator. The level of risk increases from top down. The current level is enclosed by a white square frame.
- (7) Subscores
 - ◆ E: eye opening
 - ◆ V: verbal response
 - ◆ M: motor response

19.2.2 Accessing the GCS Menu

Enter the GCS menu in any of the following ways:

- Select the GCS parameter area
- Select the **GCS** quick key.
- Select the **Main Menu** hard key or quick key → from the **CAA** column select **GCS**.

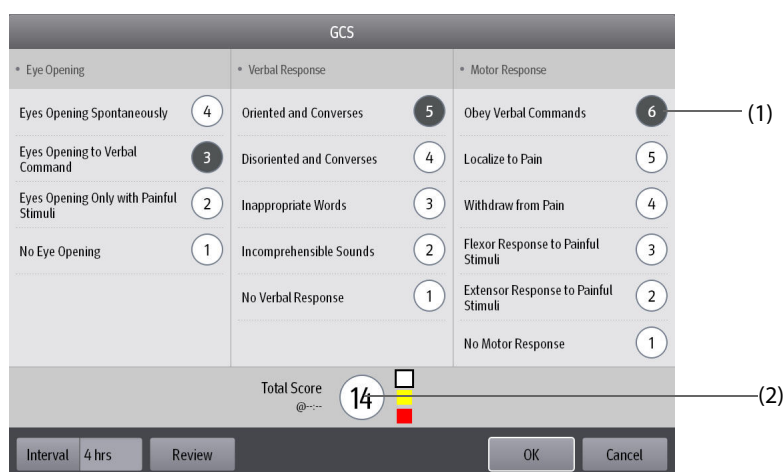

(1) Subscore

(2) Total score

19.2.3 Performing GCS Scoring

To perform scoring, follow this procedure:

1. From the **Eye Opening** area, **Verbal Response** area, and **Motor Response** area, respectively select an item that represents the patient's status.
2. Select **OK** to accept the total score.

The following table lists the default score range and color of relevant consciousness level.

Level	Range	Color	Description
Mild	13-15	White	The brain function is normal or mildly damaged.
Moderate	9-12	Yellow	The brain function is suffered from moderate to severe damage.
Severe	3-8	Red	Can be brain death or remain vegetative.

19.2.4 Setting GCS Scoring Interval

From the **GCS** menu, select **Interval** to set GCS scoring interval. When the scoring interval is reached and you do not perform another scoring, the score will be invalid and displayed as outline fonts.

19.2.5 Reviewing GCS Trend Data

From the **GCS** menu, select **Review** to enter the **Review** menu and view the GCS trend data from the **Tabular Trends**.

19.3 ECG 24h Summary

The ECG 24h Summary provides ECG statistics of the current patient over the latest 24 hours. It also displays the patient's typical ECG strips.

NOTE

- **The ECG 24h Summary function is intended for the current patient. It is not intended for discharged patients.**
- **Pacer statistics is intended for paced patients. Pacer statistics is available only when the Paced setting is Yes.**
- **ST statistics is available only when ST analysis is switched on.**
- **QT statistics is available only when QT analysis is switched on.**
- **Data displayed in the ECG 24h Summary is not recalculated.**
- **A License is required for the ECG 24h Summary function.**

19.3.1 Opening the ECG 24h Summary Window

To open the ECG 24h Summary window, choose either of the following ways:

- Select the **ECG 24h Sum** quick key.
- Select the **Main Menu** hard key or quick key → from the **Summary** column select **ECG 24h Summary**.

19.3.2 The Display of ECG 24h Summary

The following figure is an example of the ECG 24h Summary window:

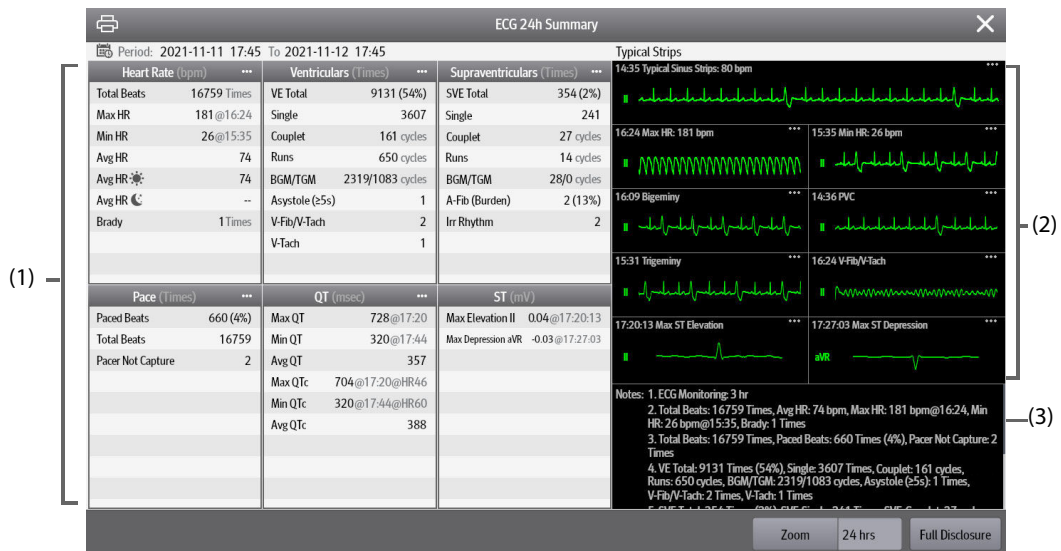

- (1) ECG statistics, including the following items:
 - Statistics of heart rates
 - Statistics of ventricular beats and ventricular events
 - Statistics of supraventricular beats and supraventricular events
 - Statistics of QT/QTc measurements
 - Statistics of maximum ST elevations and depressions
 - Statistics of pace
- (2) Typical ECG strips
- (3) Notes: includes additional information on the ECG 24h Summary

19.3.3 Selecting Typical ECG Strips

Taking V-Tach as an example, to select typical V-Tach waveform, select the currently displayed V-Tach waveform, from the popup list select the desired waveform as typical V-Tach waveform.

If no V-Tach occurs to the patient within 24 hours, an add symbol **+** is displayed in the V-Tach area. You can select the add symbol to display a typical ECG waveform of other event in this area.

19.3.4 Setting the Statistical Duration of the ECG 24h Summary

You can view a maximum of 24 hours of ECG statistics through the ECG 24h Summary. To select the statistical duration, select **Zoom**.

19.3.5 Reviewing the ECG Summary

Selecting any of the statistic area can access corresponding trends and events review. Selecting **Full Disclosure** can review ECG full disclosure waveforms. For more information, see *18 Review*.

20 Calculation

20.1 Calculation Overview

The monitor provides calculation functions. The calculated values, which are not directly measured, are computed based on the values you provide. The calculation feature is independent of other monitoring functions and can be therefore used for patients being monitored by other monitors. Any operation in a calculation window does not affect the patient monitored by the current monitor.

You can perform the following calculations:

- Drug calculations
- Hemodynamic calculations
- Oxygenation calculations
- Ventilation calculations
- Renal calculations

20.2 Calculation Safety Information

WARNING

- **Drug calculations are basing on input values. Always check the correctness of input parameters and the appropriateness of the calculations. Choice and dosage of drugs administered to patients must be decided by the physician in charge.**
 - **Check that the entered values are correct and the calculated values are appropriate. We assume no responsibility for any consequences caused by wrong entries and improper operations.**
-

20.3 Drug Calculations

The monitor provides the drug calculation function.

20.3.1 Performing Drug Calculations

To perform drug calculations, follow this procedure:

1. Access drug calculator by either of the following ways:
 - ◆ Select the **Calculations** quick key → select **Drug** tab.
 - ◆ Select the **Main Menu** hard key or quick key → from the **Calculations** column select **Drug**.
2. Set **Drug Name** and **Patient Category**. If the dose of drug is weight dependent, you must input the patient's weight. The dose calculation program has a library of commonly used drugs, of which Drug A through Drug E are user defined.
3. Enter the known values, for example **Drug Amount** and **Solution Volume**.
4. Select **Calculate**. The calculated values are indicated by red arrows.

NOTE

- **If available, the patient category and weight from the Patient Management menu are automatically entered when you first access drug calculation. You can change the patient category and weight. This will not change the patient category and weight stored in the patient demographic information.**
-

20.3.2 Checking the Titration Table

The titration table shows information on the currently used drugs. Use the titration table to see what dose of a drug your patient will receive at different infusion rates. To access the titration table, follow this procedure:

1. Access drug calculator by either of the following ways:
 - ◆ Select the **Calculations** quick key.
 - ◆ Select the **Main Menu** hard key or quick key → from the **Calculations** column select **Drug**.
2. Select the **Titration Table** tab.
3. Select **Dose Type** to set the type of dose unit in the titration table.
4. Select **Interval** to set the interval between two adjacent titration table items.

You can select how to display the titration table:

- **Dose:** the titration table is listed in the sequence of increased drug dose.
- **Infusion Rate:** the titration table is listed in the sequence of increased infusion rate. Normally the resolution of the infusion rate is one (1). By selecting **Exact Rate** the resolution of the infusion rate can reach 0.01 so that you can display the infusion rate more accurately.

20.3.3 Drug Calculation Formula

Description	Unit	Formula
Dose	Dose/hr Dose/min	$\text{Dose} = \text{Infusion Rate} \times \text{Concentration}$
Dose (weight based)	Dose/kg/hr Dose/kg/min	$\text{Dose (weight based)} = \text{Infusion Rate} \times \text{Concentration} / \text{Weight}$
Drug Amount	g series: mcg, mg, g unit series: Unit, KU, MU mEq series: mEq	$\text{Drug Amount} = \text{Dose} \times \text{Duration}$
Drug Amount (weight based)	g series: mcg, mg, g unit series: Unit, KU, MU mEq series: mEq	$\text{Drug Amount (weight based)} = \text{Dose} \times \text{Duration} \times \text{Weight}$
Duration	hr	$\text{Duration} = \text{Amount} / \text{Dose}$
Duration (weight based)	hr	$\text{Duration (weight based)} = \text{Amount} / (\text{Dose} \times \text{Weight})$
Concentration	mcg/ml, mg/ml, g/ml, Unit/ml, KU/ml, MU/ml, mEq/ml	$\text{Concentration} = \text{Drug Amount} / \text{Solution Volume}$
Solution volume	ml	$\text{Volume} = \text{Infusion Rate} \times \text{Duration}$
Infusion rate	ml/hr	$\text{Infusion Rate} = \text{Dose} / \text{Concentration}$
Infusion rate (weight based)	g·ml/hr	$\text{Infusion Rate} = \text{Dose} \times \text{Weight} / \text{Concentration}$

20.3.4 Titration Table Calculation Formula

Description	Unit	Formula
Infusion Rate	ml/hr	$\text{Infusion Rate} = \text{Dose} / \text{Concentration}$
Infusion Rate (weight based)	ml/hr	$\text{Infusion Rate} = \text{Weight} \times \text{Dose} / \text{Concentration}$
Dose	Dose/hr Dose/min	$\text{Dose} = \text{Infusion Rate} \times \text{Concentration}$
Dose (weight based)	Dose/kg/hr Dose/kg/min	$\text{Dose (weight based)} = \text{INF Rate} \times \text{Concentration} / \text{Weight}$

20.4 Hemodynamic Calculations

The monitor provides the hemodynamic calculation function. The monitor can save the results of up to 10 calculations, which are displayed in groups.

20.4.1 Performing Hemodynamic Calculations

To perform hemodynamic calculation, follow this procedure:

1. Access hemodynamic calculation by either of the following ways:
 - ◆ Select the **Calculations** quick key → **Hemodynamics** tab.
 - ◆ Select the **Main Menu** hard key or quick key → from the **Calculations** column select **Hemodynamics**.
2. Enter the known values. For a patient who is being monitored, the currently measured values are automatically taken.
3. Select **Calculate**.

The calculated value greater than the normal upper limit is indicated by an up arrow "↑". The calculated value lower than the normal lower limit is indicated by a down arrow "↓".

You can select **Range** to show the normal range of each parameter.

20.4.2 Input Parameters for Hemodynamic Calculations

Input Parameter	Label	Unit
cardiac output	C.O.	L/min
heart rate	HR	bpm
pulmonary artery wedge pressure	PAWP	mmHg
artery mean pressure	PMAP	mmHg
pulmonary artery mean pressure	PA-M	mmHg
central venous pressure	CVP	mmHg
end-diastolic volume	EDV	ml
height	Height	cm
weight	Weight	kg

NOTE

- If you enable Use PA-D as PAWP, PA-D value will be used to replace PAWP value for hemodynamic calculation. For more information, see 15.7.5 Setting the Use PA-D as PAWP Switch.

20.4.3 Calculated Parameters and Formulas for Hemodynamic Calculations

Calculated Parameters	Label	Unit	Formula
cardiac index	C.I.	L/min/m ²	C.I. (L/min/m ²) = C.O. (L/min)/BSA (m ²)
body surface area	BSA	m ²	BSA (m ²) = Wt ^{0.425} (kg) × Ht ^{0.725} (cm) × 0.007184
stroke volume	SV	ml	SV (ml) = 1000 × C.O. (L/min)/HR (bpm)
stroke index	SVI	ml/m ²	SVI (ml/m ²) = SV (ml)/BSA (m ²)
systemic vascular resistance	SVR	DS/cm ⁵	SVR (DS/cm ⁵) = 79.96 × [PAMAP (mmHg) - CVP (mmHg)]/C.O. (L/min)
systemic vascular resistance index	SVRI	DS·m ² /cm ⁵	SVRI (DS·m ² /cm ⁵) = SVR (DS/cm ⁵) × BSA (m ²)

Calculated Parameters	Label	Unit	Formula
pulmonary vascular resistance	PVR	DS/cm ⁵	$PVR (DS/cm^5) = 79.96 \times [PAMAP (mmHg) - PAWP (mmHg)] / C.O. (L/min)$
pulmonary vascular resistance index	PVRI	DS·m ² /cm ⁵	$PVRI (DS \cdot m^2/cm^5) = PVR (DS/cm^5) \times BSA (m^2)$
left cardiac work	LCW	kg·m	$LCW (kg \cdot m) = 0.0136 \times PAMAP (mmHg) \times C.O. (L/min)$
left cardiac work index	LCWI	kg·m/m ²	$LCWI (kg \cdot m/m^2) = LCW (kg \cdot m) / BSA (m^2)$
left ventricular stroke work	LVSW	g·m	$LVSW (g \cdot m) = 0.0136 \times PAMAP (mmHg) \times SV (ml)$
left ventricular stroke work index	LVSWI	g·m/m ²	$LVSWI (g \cdot m/m^2) = LVSW (g \cdot m) / BSA (m^2)$
right cardiac work	RCW	kg·m	$RCW (kg \cdot m) = 0.0136 \times PAMAP (mmHg) \times C.O. (L/min)$
right cardiac work index	RCWI	kg·m/m ²	$RCWI (kg \cdot m/m^2) = RCW (kg \cdot m) / BSA (m^2)$
right ventricular stroke work	RVSW	g·m	$RVSW (g \cdot m) = 0.0136 \times PAMAP (mmHg) \times SV (ml)$
right ventricular stroke work index	RVSWI	g·m/m ²	$RVSWI (g \cdot m/m^2) = RVSW (g \cdot m) / BSA (m^2)$
ejection fraction	EF	%	$EF (\%) = 100 \times SV (ml) / EDV (ml)$
End-diastolic volume index	EDVI	ml/m ²	$EDVI (ml/m^2) = EDV (ml) / BSA (m^2)$
End-systolic Volume	ESV	ml	$ESV (ml) = EDV (ml) - SV (ml)$
End-systolic Volume index	ESVI	ml/m ²	$ESVI (ml/m^2) = ESV (ml) / BSA (m^2)$

20.5 Oxygenation Calculations

The monitor provides the oxygenation calculation function. The monitor can save the results of up to 10 calculations, which are displayed in groups.

20.5.1 Performing Oxygenation Calculations

To perform oxygenation calculations, follow this procedure:

1. Access oxygenation calculation by either of the following ways:
 - ◆ Select the **Calculations** quick key → **Oxygenation** tab.
 - ◆ Select the **Main Menu** hard key or quick key → from the **Calculations** column select **Oxygenation**.
2. Enter the known values. For a patient who is being monitored, the currently measured values are automatically taken.
3. Select **Calculate**.

The calculated value greater than the normal upper limit is indicated by an up arrow “↑”. The calculated value lower than the normal lower limit is indicated by a down arrow “↓”.

In the **Oxygenation** page, you can also perform the following operations:

- Select **OxyCont Unit**, **Hb Unit**, and **Pressure Unit**. Then corresponding parameter values will be automatically converted and updated accordingly.
- Select **Range** to show the normal range of each parameter.

20.5.2 Input Parameters for Oxygenation Calculations

Input Parameter	Label	Unit
cardiac output	C.O.	L/min
percentage fraction of inspired oxygen	FiO ₂	%
partial pressure of oxygen in the arteries	PaO ₂	mmHg, kPa
partial pressure of carbon dioxide in the arteries	PaCO ₂	mmHg, kPa
arterial oxygen saturation	SaO ₂	%
partial pressure of oxygen in venous blood	PvO ₂	mmHg, kPa
venous oxygen saturation	SvO ₂	%
hemoglobin	Hb	g/L, g/dl, mmol/L
respiratory quotient	RQ	None
atmospheric pressure	ATMP	mmHg, kPa
height	Height	cm, inch
weight	Weight	kg, lb

20.5.3 Calculated Parameters and Formulas for Oxygenation Calculations

Calculated Parameters	Label	Unit	Formula
body surface area	BSA	m ²	$BSA (m^2) = Wt^{0.425} (kg) \times Ht^{0.725} (cm) \times 0.007184$
oxygen consumption	VO ₂	ml/min	$VO_2 (ml/min) = C(a-v)O_2 (ml/L) \times C.O. (L/min)$
arterial oxygen content	CaO ₂	ml/L, ml/dL	$CaO_2 (ml/L) = 10 \times (0.0134 \times Hb (g/dl) \times SaO_2 (\%)) + 0.031 \times PaO_2 (mmHg)$
venous oxygen content	CvO ₂	ml/L, ml/dL	$CvO_2 (ml/L) = 10 \times (0.0134 \times Hb (g/dl) \times SvO_2 (\%)) + 0.031 \times PvO_2 (mmHg)$
arteriovenous oxygen content difference	C(a-v)O ₂	ml/L, ml/dl	$C(a-v)O_2 (ml/L) = CaO_2 (ml/L) - CvO_2 (ml/L)$
oxygen extraction ratio	O ₂ ER	%	$O_2ER (\%) = 100 \times C(a-v)O_2 (ml/L) / CaO_2 (ml/L)$
oxygen transport	DO ₂	ml/min	$DO_2 (ml/min) = C.O. (L/min) \times CaO_2 (ml/L)$
partial pressure of oxygen in the alveoli	PAO ₂	mmHg, kPa	$PAO_2 (mmHg) = [ATMP (mmHg) - 47 mmHg] \times FiO_2 (\%)/100 - PaCO_2 (mmHg) \times [FiO_2 (\%)/100 + (1 - FiO_2 (\%)/100)/RQ]$
alveolar-arterial oxygen difference	AaDO ₂	mmHg, kPa	$AaDO_2 (mmHg) = PAO_2 (mmHg) - PaO_2 (mmHg)$
capillary oxygen content	CcO ₂	ml/L, ml/dl	$CcO_2 (ml/L) = Hb (g/L) \times 1.34 + 0.031 \times PAO_2 (mmHg)$
venous admixture	QS/QT	%	$QS/QT (\%) = 100 \times [1.34 \times Hb (g/L) \times (1 - SaO_2 (\%)/100) + 0.031 \times (PAO_2 (mmHg) - PaO_2 (mmHg))] / [1.34 \times Hb (g/L) \times (1 - SvO_2 (\%)/100) + 0.031 \times (PAO_2 (mmHg) - PvO_2 (mmHg))]$
oxygen transport index	DO ₂ I	ml/min/m ²	$DO_2I (ml/min/m^2) = CaO_2 (ml/L) \times (C.O. (L/min) / BSA (m^2))$
oxygen consumption	VO ₂ I	ml/min/m ²	$VO_2I (ml/min/m^2) = C(a-v)O_2 (ml/L) \times (C.O. (L/min) / BSA (m^2))$

20.6 Ventilation Calculations

The monitor provides the ventilation calculation function. The monitor can save the results of up to 10 calculations, which are displayed in groups.

20.6.1 Performing Ventilation Calculations

To perform ventilation calculations, follow this procedure:

1. Access ventilation calculation by either of the following ways:
 - ◆ Select the **Calculations** quick key → **Ventilation** tab.
 - ◆ Select the **Main Menu** hard key or quick key → from the **Calculations** column select **Ventilation**.
2. Enter the known values. For a patient who is being monitored, the currently measured values are automatically taken. If the anesthesia machine or ventilator is connected, measured values for ventilation calculation are also automatically taken.
3. Select **Calculate**.

The calculated value greater than the normal upper limit is indicated by an up arrow "↑". The calculated value lower than the normal lower limit is indicated by a down arrow "↓".

On the **Ventilation** page, you can also perform the following operations:

- Select **Pressure Unit**. Then corresponding parameter values will be automatically converted and updated accordingly.
- Select **Range** to show the normal range of each parameter.

20.6.2 Input Parameters for Ventilation Calculations

Input Parameter	Label	Unit
percentage fraction of inspired oxygen	FiO ₂	%
respiration rate	RR	rpm
partial pressure of mixed expiratory CO ₂	PeCO ₂	mmHg, kPa
partial pressure of carbon dioxide in the arteries	PaCO ₂	mmHg, kPa
partial pressure of oxygen in the arteries	PaO ₂	mmHg, kPa
tidal volume	TV	ml
respiratory quotient	RQ	None
atmospheric pressure	ATMP	mmHg, kPa

20.6.3 Calculated Parameters and Formulas for Ventilation Calculations

Calculated Parameters	Label	Unit	Formula
partial pressure of oxygen in the alveoli	PAO ₂	mmHg, kPa	$PAO_2 \text{ (mmHg)} = [ATMP \text{ (mmHg)} - 47 \text{ mmHg}] \times FiO_2 \text{ (\%)/100} - PaCO_2 \text{ (mmHg)} \times [FiO_2 \text{ (\%)/100} + (1 - FiO_2 \text{ (\%)/100})/RQ]$
alveolar-arterial oxygen difference	AaDO ₂	mmHg, kPa	$AaDO_2 \text{ (mmHg)} = PAO_2 \text{ (mmHg)} - PaO_2 \text{ (mmHg)}$
oxygenation ratio	Pa/FiO ₂	mmHg, kPa	$Pa/FiO_2 \text{ (mmHg)} = 100 \times PaO_2 \text{ (mmHg)}/FiO_2 \text{ (\%)}$
arterial to alveolar oxygen ratio	a/AO ₂	%	$a/AO_2 \text{ (\%)} = 100 \times PaO_2 \text{ (mmHg)}/PAO_2 \text{ (mmHg)}$
minute volume	MV	L/min	$MV \text{ (L/min)} = [TV \text{ (ml)} \times RR \text{ (rpm)}]/1000$
volume of physiological dead space	Vd	ml	$Vd \text{ (ml)} = TV \text{ (ml)} \times [1 - PeCO_2 \text{ (mmHg)}/PaCO_2 \text{ (mmHg)}]$

Calculated Parameters	Label	Unit	Formula
physiologic dead space in percent of tidal volume	Vd/Vt	%	$Vd/Vt (\%) = 100 \times Vd (ml)/TV (ml)$
alveolar volume	VA	L/min	$VA (L/min) = [TV (ml) - Vd (ml)] \times RR (rpm)/1000$

20.7 Renal Calculations

The monitor provides the renal calculation function. The monitor can save the results of up to 10 calculations, which are displayed in groups.

20.7.1 Performing Renal Calculations

To perform renal calculations, follow this procedure:

- Access renal calculation by either of the following ways:
 - Select the **Calculations** quick key → select the **Renal** tab.
 - Select the **Main Menu** hard key or quick key → from the **Calculations** column select **Renal**.
- Enter the known values.
- Select **Calculate**.

The calculated value greater than the normal upper limit is indicated by an up arrow "↑". The calculated value lower than the normal lower limit is indicated by a down arrow "↓".

You can select **Range** to show the normal range of each parameter.

20.7.2 Calculated Parameters and Formulas for Renal Calculations

Input Parameter	Label	Unit
urine potassium	URK	mmol/L
urinary sodium	URNa	mmol/L
urine	Urine	ml/24 hrs
plasm osmolality	Posm	mOsm/kgH ₂ O
urine osmolality	Uosm	mOsm/kgH ₂ O
serum sodium	SerNa	mmol/L
creatinine	Cr	μmol/L
urine creatinine	UCr	μmol/L
blood urea nitrogen	BUN	mmol/L
height	Height	cm
weight	Weight	kg

20.7.3 Calculated Parameters and Formulas for Renal Calculations

Calculated Parameters	Label	Unit	Formula
urine sodium excretion	URNaEx	mmol/24 hrs	$URNaEx \text{ (mmol/24 hrs)} = \text{Urine (ml/24 hrs)} \times URNa \text{ (mmol/L)} / 1000$
urine potassium excretion	URKEx	mmol/24 hrs	$URKEx \text{ (mmol/24 hrs)} = \text{Urine (ml/24 hrs)} \times URK \text{ (mmol/L)} / 1000$
sodium potassium ratio	Na/K	%	$Na/K \text{ (\%)} = 100 \times URNa \text{ (mmol/L)} / URK \text{ (mmol/L)}$
clearance of sodium	CNa	ml/24 hrs	$CNa \text{ (ml/24 hrs)} = URNa \text{ (mmol/L)} \times \text{Urine (ml/24 hrs)} / SerNa \text{ (mmol/L)}$
creatinine clearance rate	Clcr	ml/min	$Clcr \text{ (ml/min)} = Ucr \text{ (\mu mol/L)} \times \text{Urine (ml/24 hrs)} / [Cr \text{ (\mu mol/L)} \times (BSA \text{ (m}^2\text{)} / 1.73) \times 1440]$
fractional excretion of sodium	FENa	%	$FENa \text{ (\%)} = 100 \times URNa \text{ (mmol/L)} \times Cr \text{ (\mu mol/L)} / [SerNa \text{ (mmol/L)} \times Ucr \text{ (\mu mol/L)}]$
osmolar clearance	Cosm	ml/min	$Cosm \text{ (ml/min)} = Uosm \text{ (mOsm/kgH}_2\text{O)} \times \text{Urine (ml/24 hrs)} / (Posm \text{ (mOsm/kgH}_2\text{O)} \times 1440)$
free water clearance	CH2O	ml/hr	$CH2O \text{ (ml/hr)} = \text{Urine (ml/24 hrs)} \times [1 - Uosm \text{ (mOsm/kgH}_2\text{O)} / Posm \text{ (mOsm/kgH}_2\text{O)}] / 24$
urine to plasma osmolality ratio	U/P osm	None	$U/P \text{ osm} = Uosm \text{ (mOsm/kgH}_2\text{O)} / Posm \text{ (mOsm/kgH}_2\text{O)}$
blood urea nitrogen creatinine ratio	BUN/Cr*	Mmol/L	$BUN/Cr = 1000 \times BUN \text{ (mmol/L)} / Cr \text{ (\mu mol/L)}$
urine-serum creatinine ratio	U/Cr	None	$U/Cr \text{ (mmol/L)} = Ucr \text{ (\mu mol/L)} / Cr \text{ (\mu mol/L)}$

*: BUN/Cr is a ratio at mol unit system.

21 Recording

21.1 Recorder

The thermal recorder records patient information, measurement data, and up to three waveforms.

The monitor is configured with a built-in recorder.

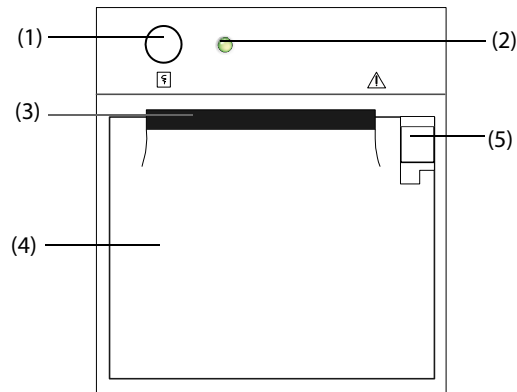



- (1) Start/Stop key: press to start a recording or stop the current recording.
- (2) Module status indicator
 - ◆ On: when the recorder works correctly.
 - ◆ Off: when the monitor is switched off.
 - ◆ Flashes: if an error occurred to the recorder.
- (3) Paper outlet
- (4) Recorder door
- (5) Latch: pull it backward to open the recorder door.

21.2 Starting Recordings

Recordings can be started manually or automatically.

21.2.1 Manually Starting Recordings

To manually start a recording, you can either:

- Press the  hardkey on the front of the recorder.
- Select  on the current page.

21.2.2 Automatic Recordings

In the following conditions, you can set the recorder to automatically start recording:

- At a preset interval. For more information, see *21.5 Setting the Recorder*.
- When a parameter alarm is triggered. For more information, see *21.6 Enabling Auto Recording on Alarm*.

21.3 Stopping Recordings

Recordings can be stopped manually or automatically.

21.3.1 Stopping Recordings Manually

To manually stop a recording, choose either of the following method:

- Press the  hardkey again.
- Select **Clear All Record Tasks** in the **Record Setup** menu.

21.3.2 Stopping Recordings Automatically

Recordings stop automatically in the following conditions:

- The recording is completed.
- The recorder runs out of paper.
- The recorder has an alarm condition.

21.4 Recording Related Flags

You can find the following flags on the recording reports:

- For automatically stopped recordings, there are two columns of asterisks "*" at the end of the report.
- For manually or abnormally stopped recordings, there is one column of asterisks "*" at the end of the report.

21.5 Setting the Recorder

To set the recorder, follow this procedure:

1. Select the **Main Menu** hard key or quick key → from the **Report** column select **Record Setup**.
2. In the **Record Setup** menu, select the desired waveform for **Waveform 1**, **Waveform 2** and **Waveform 3** in turn. The recorder can record up to 3 waveforms at a time.
3. Switch on or off **IBP Overlap** to enable or disable IBP recordings in the overlapping format.
 - ◆ When the **IBP Overlap** is enabled: If two or more waveforms in the selected waveforms for recording are IBP waveforms, the IBP waveforms will be recorded in the overlapping format.
 - ◆ When the **IBP Overlap** is disabled: IBP waveforms will be recorded normally.
4. Select **Recording Duration** to set the duration of real-time recording.
5. Select **Interval** to set the time interval for automatic recording.
6. Select **Recorder Paper Speed** to set the speed for recording waveforms.

21.6 Enabling Auto Recording on Alarm

To initiate automatic recording via recorder when a parameter alarm is triggered, follow this procedure:

1. Access the **Alarm** menu for the desired parameter in one of the following ways:
 - ◆ Select the **Alarm Setup** quick key at the bottom of the screen.
 - ◆ Select the numerics area or waveform area of the desired parameter → select the **Alarm** tab.
 - ◆ Select the **Parameters Setup** quick key → select the desired parameter → select the **Alarm** tab.
2. Switch on **Alarm Outputs**.

NOTE

- **Auto recording on alarm happens only when Print on Alarm is set to Recorder. For more information, see 23.4.6 The Other Tab.**

21.7 Clearing Recording Tasks

To clear recording tasks, follow this procedure:

1. Select the **Main Menu** hard key or quick key → from the **Report** column select **Record Setup**.
2. In the **Record Setup** menu, select **Clear All Record Tasks**. This clears all queued recording tasks and stops the current recording.

21.8 Loading Paper

To load paper, follow this procedure:

1. Pull the latch on the upper right of the recorder to open the recorder door.
2. Insert a new roll into the compartment as shown below. Feed the paper through and pull some paper out from the top of the roller.
3. Close the recorder door.

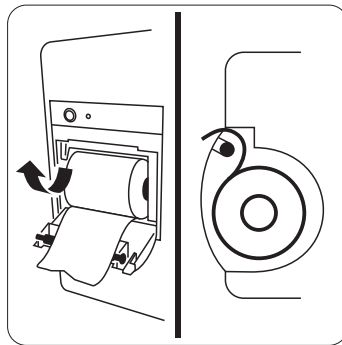

CAUTION

- **Use only specified thermal paper. Otherwise, it may cause damage to the recorder's printhead, the recorder may be unable to print, or poor print quality may result.**
 - **Never pull the recorder paper with force when a recording is in process. Otherwise, it may cause damage to the recorder.**
 - **Do not leave the recorder door open unless you reload paper or remove troubles.**
-

21.9 Removing Paper Jam

If the recorder works incorrectly or produces unusual sounds, check if there is a paper jam first. If a paper jam is detected, follow this procedure to remove it:

1. Open the recorder door.
2. Take out the paper and tear off the draped part.
3. Reload the paper and close the recorder door.

This page intentionally left blank.

22 Printing

The monitor can output patient reports via network printer or printer server.

22.1 Supported Printer

The monitor supports the following printer:

- HP LaserJet Pro M202dw
- HP LaserJet Enterprise M605
- HP LaserJet P4015n
- HP LaserJet Pro 400 M401n
- HP LaserJet 600 M602
- HP LaserJet Enterprise M608
- HP LaserJet Pro M203dw
- HP LaserJet Pro M203dn

NOTE

- **For more details about the printer, see the document accompanying the printer. With product upgrades, the monitor may support more printers and no prior notice will be given. If you have any doubt about the printer you have purchased, contact Mindray.**
-

22.2 End Case Reports

22.2.1 Printing the End Case Report

To print the end case report, choose one of the following ways:

- Select **Print** from the **End Case Report** menu.
- Select **Print End Case Report** when you discharge a patient
- Select the **End Case Report** quick key.

22.2.2 Setting a Report as An End Case Report

The following reports can be set as end case reports:

- Tabular Trends Report
- Graphic Trend Report
- Event Report
- 12-lead Interpretation
- Alarm Limits Report
- Realtime Report
- ECG Report
- ECG Summary

To set a report as an end case report, follow this procedure:

1. Select the **Main Menu** hard key or quick key → from the **Report** column select **End Case Report**.
2. From the **Select Reports** page, select the checkbox before the desired report, for example **ECG Report**.

22.2.3 Setting the End Case Report

To set the end case report, follow this procedure:

1. Select the **Main Menu** hard key or quick key → from the **Report** column select **End Case Report**.
2. From the **Report Setup** page, set the following end case reports:
 - ◆ Select the **Tabular Trends Report**, **Graphic Trends Report**, **Realtime Report**, and **ECG Report** tab, and set these end case report by referring to section 22.6 *Setting Reports*.
 - ◆ Select the **Event Report** tab, and select the event that needs to be printed.
 - ◆ Select the **12-Lead Interpretation** tab, and set the switch of **Median Complex**, **Measurements**, **Interpretation**, or **Interpretation Summary**. For other settings, see 22.6 *Setting Reports*.

22.2.4 Setting the End Case Report Period

To set the end case report print period, follow this procedure:

1. Select the **Main Menu** hard key or quick key → from the **Report** column select **End Case Report**.
2. From the **Select Reports** page, set the **Period**.

NOTE

- End case report print period is calculated from the patient discharged time to the configured period.
- Period setting is applicable to all the end case report.

22.3 Manually Starting a Printing Task

You can start a printing task manually.

22.3.1 Starting Printing from the Current Page

From the current page, select , if available, to start printing.

22.3.2 Printing Realtime Reports

Select  to print a realtime report. You can also print a realtime report from the **Report Setup** page. For more information, see 22.3.3 *Printing General Reports*.

22.3.3 Printing General Reports

You can print the following general reports:

- ECG Report
- Realtime Report
- Tabular Trends Report
- Graphic Trend Report

To print the general reports, follow this procedure:

1. Select the **Main Menu** hard key or quick key → from the **Report** column select **Report Setup**.
2. Select the desired report tab.
3. Check the settings.
4. Select **Print**.

22.4 Automatically Printing Reports

When a parameter alarm switch is set to on and an alarm is triggered for this parameter, you can set a printer to start alarm printing automatically.

To do so, follow this procedure:

1. Access alarm related tabs such as the **Alarm** tab for a parameter in one of the following ways:
 - ◆ Select the **Alarm Setup** quick key.
 - ◆ Select the parameter or waveform area of the desired parameter → select the **Alarm** tab.
 - ◆ Select the **Parameters Setup** quick key → select the desired parameter → select the **Alarm** tab.
 - ◆ Select the **Main Menu** quick key → from the **Parameters** column select **Setup** → select the desired parameter → select the **Alarm** tab.
2. Switch on **Alarm Outputs** for desired parameters.

22.5 Stopping a Printing Task

To stop a printing task, follow this procedure:

1. Select the **Main Menu** hard key or quick key → from the **Report** column select **Print Queue**.
2. Select desired printing tasks and then select **Delete**. Selecting **Delete All** to stop all the printing tasks.

22.6 Setting Reports

This section focuses on how to set ECG reports, realtime reports, tabular trends reports, and graphic trends reports.

22.6.1 Setting ECG Reports

To set ECG reports, follow this procedure:

1. Select the **Main Menu** hard key or quick key → from the **Report** column select **Report Setup**.
2. Select **ECG Report**.
3. Set the desired options. The following table only lists some of the options.

Menu item	Function	Description
Speed	Set the print speed of ECG waveforms	25 mm/sec: prints 25 mm of ECG waveform per second. 50 mm/sec: prints 50 mm of ECG waveform per second.
Auto Interval	Defines the spacing between the ECG waveforms on a printout	On: automatically adjusts the space between waveforms to avoid overlapping.
		Off: each waveform area has the same size on a printout.
Note: This setting is only relevant when 12x1 is selected for 12-Lead Format .		
12-Lead Format	Select the format of 12-lead ECG waveforms on a printout.	<p>12x1: displays 12-lead ECG waveforms on one page in one column.</p> <p>6x2: displays 12-lead ECG waveforms on one page in two columns, with 6 lines in each column.</p> <p>6x2+1: displays 12-lead ECG waveforms on one page in two columns, with 6 lines in each column, and one rhythm lead waveform at the bottom.</p> <p>3x4+1: displays 12-lead ECG waveforms on one page in 4 columns, with 3 lines in each column, and one rhythm lead waveform at the bottom.</p> <p>3x4+3: displays 12-lead ECG waveforms on one page in 4 columns, with 3 lines in each column, and three rhythm lead waveforms at the bottom.</p>

Menu item	Function	Description
Rhythm Lead 1 Rhythm Lead 2 Rhythm Lead 3	Select the lead that will be used as Rhythm Lead 1, 2, or 3.	I, II, III, aVR, aVL, aVF, V1, V2, V3, V4, V5, V6
	Note: This setting is only relevant when 6x2+1, 3x4+1, or 3x4+3 is selected for 12-Lead Format .	
Format Sequence	Select the recording method of ECG report generated by auto measurement	Sequential: 12-lead ECG data are recorded sequentially and displayed in 3 lines and 4 columns with 2.5 seconds of ECG data for each column. Simultaneous: Record simultaneous 12-lead ECG data.

NOTE

- **When Lead Set is set to 3-Lead, the ECG report cannot be printed.**

22.6.2 Setting Realtime Reports

To set tabular realtime reports, follow this procedure:

1. Select the **Main Menu** hard key or quick key → from the **Report** column select **Report Setup**.
2. Select **Realtime Report**.
3. Set the desired options. The following table only lists some of the options.

Menu item	Function	Description
Select Waveform	Select the desired waveform to print	Current Waveforms: prints the realtime report for current waveforms. Selected Waveforms: prints the realtime report for the selected waveforms.

22.6.3 Setting Tabular Trends Reports

To set tabular trends reports, follow this procedure:

1. Select the **Main Menu** hard key or quick key → from the **Report** column select **Report Setup**.
2. Select **Tabular Trends Report**.
3. Set the desired options. The following table only lists some of the options.

Menu Item	Function	Description
Period	Select the period during which a tabular trends report will be printed.	Auto: one page of a tabular trends before the current time will be printed at the selected Interval . All: all stored tabular trends will be printed at the selected Interval . 30 min to 96 hrs: 30 min to 96 hrs of tabular trends before the selected Time will be printed at the selected Interval .
Interval	Select the resolution of the tabular trends printed on a report.	NIBP, EWS, GCS, C.O.: at an interval of acquiring the values of selected parameter. Auto: using the Interval setting of the Tabular Trends review page. 5 sec to 3 hrs: the tabular trends will be printed at the selected Interval .
Report Format	Select the printing principle.	Landscape: parameter values are listed vertically and trend time is listed horizontally.. Portrait: trend time is listed vertically and parameter values are listed horizontally.

22.6.4 Setting Graphic Trends Reports

To set graphic trends reports, follow this procedure:

1. Select the **Main Menu** hard key or quick key → from the **Report** column select Report Setup.
2. Select the **Graphic Trends Report** tab.
3. Set the desired options.

Menu Item	Function	Description
Period	Select the period during which a graphic trends report will be printed.	Auto: one page of a graphic trends before the current time will be printed. All: all stored graphic trends will be printed.. 30 min to 96 hrs: 30 min to 96 hrs of graphic trends before the selected Time will be printed.

22.7 Viewing Printer Status

You can view the status of the recent ten printing tasks in the **Print Queue** window. To view the status of printing tasks, select the **Main Menu** hard key or quick key, from the **Report** column select **Print Queue**.

Each printing task includes the following information:

- Print time
- Report title
- Printer name (when using the printer server) or IP address (when using the network printer)
- Printing status, for example, printing, failed, retrying, and waiting.

22.8 Printer Out of Paper

When the printer runs out of paper, the print request will not be responded. If there are too many print jobs that are not responded, a printer error may occur. In these cases, you need to install paper and then re-send the print request. Restart the printer if necessary.

Therefore, you'd better ensure that there is enough paper in the printer before sending a print request.

This page intentionally left blank.

23 User Maintenance Settings

User maintenance enables you to customize your equipment to best meet your needs. Accessing the **Maintenance** menu is password protected.

This chapter describes the settings and functions in the **Maintenance** menu. The monitor provides different maintenance menus for different user types. The following table lists the access authorization of different users.

User Type	Menu
Clinical professional	Device Location, Patient Management, Alarm, CAA, Module, Review, Print, Unit, Time, Other,
Biotechnical personnel	Device Location, Patient Management, Alarm, CAA, Module, Review, Print, Unit, Time, Other, Authorization Setup, Version, Battery Information, Scanner, Network Setup,
Service personnel	Device Location, Patient Management, Alarm, CAA, Module, Review, Print, Unit, Time, Other, Authorization Setup, Version, Battery Information, Scanner, Network Setup, Factory Maintenance.

CAUTION

- The maintenance settings can only be changed by authorized personnel. Contact your department manager or biomedical engineering department for the passwords used at your facility.

23.1 Accessing the Maintenance Menu

To perform user maintenance, follow this procedure:

1. Select the **Main Menu** quick key → from the **System** column select **Maintenance** → input the required password → select ↵.
2. Select desired tab.

23.2 The Device Location Settings

Menu Item	Default Setting	Description
Monitor Name	/	/
Facility		
Department		
Location	Fixed	<ul style="list-style-type: none">• Fixed: the Patient Management menu displays Bed No. and Room No., but you cannot change them.• Unfixed: you can change Bed No. and Room No. from the Patient Management menu. Bed No. and Room No. are cleared each time you discharge a patient.
Room No.	/	/
Bed No.		

Menu Item	Default Setting	Description
Auto Obtain Bed No.	Off	<p>On: if the monitor is connected to the wired network, the monitor automatically sets the patient's bed number according to the bed number information bonded to the bedside network connector.</p> <p>The Auto Obtain Bed No. function is available only when the switch connected to the monitor supports the LLDP or CDP protocol, and the corresponding protocol is enabled.</p>

23.3 The Patient Management Settings

23.3.1 The Field Tab

Menu Item	Default Setting	Description
Room No	Unselected	Selects which items can be displayed and edited from the Patient Management menu.
Visit Number	Unselected	
Patient ID	Selected	
Middle Name	Unselected	
Race	Unselected	
Age (Gestational Age: Neo)	Selected	
Custom Field 1- Custom Field 4	Unselected	

NOTE

- If the monitor is connected with the CMS, the patient information items and customized fields are loaded from the CMS.

23.3.2 The Find Patient Tab

Menu Item	Default Setting	Description	
Find Patient	All Patients	<ul style="list-style-type: none"> • All Patients: searches from all patients in the CMS or ADT server. • Current Department Patients: searches from the current department in the CMS or ADT server. 	
ADT Query	Facility	Unselected	Selects which criteria can be used to search patients in the ADT server If Find Patient is set to All Patients , you can search from all patients in the ADT server. If Find Patient is set to Current Department Patients , you can only search from the current department in the ADT server.
	Department		
	Room No		
	Bed No		
	Visit Number		
	Patient ID		
	Patient Name		

23.3.3 The Discharge Tab

Menu Item	Default Setting	Description
Auto Discharge When Power Off	Never	Automatically discharges the patient when the monitor is turned off for the designated period of time. Never: not discharge a patient no matter for how long the monitor has been switched off.
Auto delete discharged patients when storage space is full	On	/
Prompt on patient auto deleted	On	On: an alarm is issued when the monitor automatically deletes earlier discharged patients.
Prompt Alarm When Storage Is Nearly Full	Med	Selects whether an alarm is issued when the monitor memory is very low and the priority of this alarm.
Include Patient Demographics When Exporting Patient Data	Off	Selects whether patient demographics is included when exporting the patient data.
Auto Delete Patient Data if Discharged	Auto	Selects whether patient data is deleted when the patient is discharged. <ul style="list-style-type: none"> • Auto: not delete patient data when the patient is discharged. Discharged patient will be deleted when the storage space of the monitor is full. • Right Now: deletes patient data as soon as the patient is discharged. • 7 days: deletes patient data seven days after the patient is discharged. • 1 Month: deletes patient data one month after the patient is discharged.
Clear All Patient Data	/	Deletes all patient information and data. Clearing patient data will discharge the current patient.

23.3.4 The Location Tab

Menu Item	Default Setting	Description
Location 1 - Location 10	/	Selects where the patient goes after patient monitoring stops.

23.3.5 The Display Tab

Menu Item	Default Setting	Description
Primary Screen Display Full Name	On	Selects whether patient name is displayed in the patient information area on the primary display.
Remote View Display Full Name	On	Selects whether patient name is displayed in the patient information area on the remote monitors when this monitor is viewed by other monitors.
Remote View Bedlist Display Full Name	On	Defines whether patient name is displayed in beds list on the remote monitors when this monitor is viewed by other monitors.
Primary Screen Display Full Patient ID	Off	When this option is set on, patient ID is displayed on the alarm/prompt area on the main screen. This function works only when Enhanced Patient Information is switched on.

Menu Item	Default Setting	Description
Enhanced Patient Information	Off	When this option is on and the monitor has only non-exclusive physiological alarms or is in no alarms/prompts or is in standby status, the patient information is enhanced to display.

23.4 The Alarm Settings

23.4.1 The Audio Tab

Menu Item	Default Setting	Description
Minimum Alarm Volume	2	/
Alarm Sound	ISO	Defines the alarm tone pattern to distinguish the heart beat tone, pulse tone, and keystroke tone by frequency.
High Alarm Interval	10 sec	Defines the interval between alarm tones for the ISO mode.
Med Alarm Interval	20 sec	
Low Alarm Interval	20 sec	
Auto Increase Volume	2 Steps	<ul style="list-style-type: none"> • 2 Steps: if an alarm is not reset within the designated delay time after the alarm occurs, the alarm volume automatically increases by two levels. • 1 Step: if an alarm is not reset within the designated delay time after the alarm occurs, the alarm volume automatically increases by one level. • Off: if an alarm is not reset within the designated delay time after the alarm occurs, the volume of the alarm tone does not change.
Increase Volume Delay	20 sec	Defines the delay time of alarm volume escalation

NOTE

- **The alarm volume escalation function is not applied to the latched alarms.**
- **The monitor provides the same alarm tone pattern for the remote device alarms as those for your monitor alarms.**

23.4.2 The Pause/Reset Tab

Section	Menu Item	Default Setting	Description
Pauses	Pause	Alarm Pause	Selects the pause function. <ul style="list-style-type: none"> • Alarm Pause: pauses alarms. • Audio Pause: pauses alarm tones.
	Pause Time	2 min	Selects the alarm pause time. The alarm pause time can be set to 1 min, 2 min, 3 min, or Permanent.
	Pause Priority	All	Selects alarms of what priority can be paused. <ul style="list-style-type: none"> • All: pressing the Alarm Pause quick key pauses all alarms. • Med & Low: pressing the Alarm Pause quick key pauses alarms of medium and low priority. The high priority alarms will not be paused. • Disabled: the Alarm Pause quick key is disabled.
	Pause 5 min	Off	Selects how long the alarm can be paused if switched on.
	Pause 10 min	Off	
	Pause 15 min	Off	
Alarm Reset	Alarm Light	On When Reset	<ul style="list-style-type: none"> • On When Reset: when the alarm system is reset, the alarm tones of the current alarms are switched off, but the alarm lamp remains flashing. • Off When Reset: when the alarm system is reset, both the alarm tone and alarm lamp of the current alarms are switched off.
Reminder Tone	Alarm Reset Reminder	On	Selects the reminder tone rule when the alarm volume is set to zero, or the alarm is reset or switched off. <ul style="list-style-type: none"> • On: the monitor issues reminder tones at a designated interval. • Re-alarm: if the alarm condition persists, the alarms marked with “√” will be regenerated after the designated reminder tone interval. • Off: the monitor does not issue reminder tones at a designated interval. The alarms marked with “√” will be silenced.
	Alarm Off Reminder	On	/
	Reminder Interval	5 min	<ul style="list-style-type: none"> • 10 min: the monitor issues reminder tones every 10 minutes. • 5 min: the monitor issues reminder tones every five minutes. • 3 min: the monitor issues reminder tones every three minutes. • 2 min: the monitor issues reminder tones every two minutes. • 1 min: the monitor issues reminder tones every one minute.

23.4.3 The Latching Tab

Menu Item		Default Setting	Description
Lethal	Visible	Unselected	Selects alarm latching rules: <ul style="list-style-type: none"> • If Visible is selected, you can separately latch visual alarm signal. • Latching audible alarm signal simultaneously latches visual signal. • Selecting alarms of lower priority simultaneously latches higher priority alarms.
	Audible		
High	Visible		
	Audible		
Med	Visible		
	Audible		
Low	Visible		
	Audible		

23.4.4 The Remote View Tab

Menu Item	Default Setting	Description
Reset Remote Bed Alarms	Off	Selects whether you can reset alarms occurring to the remote devices from your monitor. On: the Alarm Reset button appears on the bottom left of the Remote View screen.
Alarm Reset By Other Bed	On	On: alarms on your monitor can be reset by remote devices.
Alarm Reminder	Visible+Audible	Selects what alarm indicators are necessary for the remote devices. <ul style="list-style-type: none"> • Visible+Audible: the monitor provides visual alarm indication, and continuous audible alarm indication if the alarm persists at the remote device. • Visible+Single Tone: the monitor provides visual alarm indication, and a single tone when the alarm occurs at the remote device. • Visible Only: the monitor only provides visual alarm indication.
Alarm Priority	All	Selects what priority of remote device alarms are presented for audible notification <ul style="list-style-type: none"> • All: the monitor sounds if an alarm occurs. • High & Med: the monitor sounds if a high or medium priority alarm occurs. • High Only: the monitor sounds only if a high priority alarm occurs.
Alarm Sound	ISO	Selects the alarm tone pattern for the remote device alarms.
Remote Disconnected Alarm	On	Selects whether an alarm is issued if a remote device is disconnected.

23.4.5 The Nurse Call Tab

Menu Item	Default Setting	Description
Signal Type	Continuous	<ul style="list-style-type: none"> • Pulse: the nurse call signal is a pulse signal and each pulse lasts one second. When multiple alarms simultaneously occur, only one pulse signal is outputted. If an alarm occurs but the previous one is not cleared, a new pulse signal will also be outputted. • Continuous: the nurse call signal lasts until the alarm ends. That is to say the duration of a nurse call signal is equal to that of the alarm condition.
Contact Type	Normally Open	Selects the work mode of the nurse call relay
Alarm Priority	High Only	Selects the priority of alarms sent to the nurse call system
Alarm Type	Physiological Only	Selects the type of alarms sent to the nurse call system.
Receive Call Help	On	Receives the calling signal if a monitor in the same department calls for help.
Only beds from Remote View	Off	Select which calling for help signals the monitor can receive. <ul style="list-style-type: none"> • On: The monitor can only receive the calling for help signals from the remote monitors being viewed. • Off: The monitor can receive the calling for help signals from all the monitors in the same department.

23.4.6 The Other Tab

Section	Menu Item	Default Setting	Description
Alarm Priority	ECG Lead Off	Low	Selects the priority of the ECG lead off alarm.
	SpO2 Sensor Off	Low	Selects the priority of the SpO ₂ sensor off alarm.
	IBP No Sensor(for uMEC 70/uMEC 80/ uMEC 120/uMEC 150)	Med	Selects the priority of the IBP No Sensor alarm.
	CMS/eGW Disconnected	Low	Selects the priority of the CMS and eGateway disconnection alarm.
Alarm Delay	Alarm Delay	6 sec	<ul style="list-style-type: none"> • 1 sec ~15 sec: for continuously measured parameters, the monitor does not represent the alarm if the alarm condition is resolved within the designated delay time. • Off: an alarm is always presented. The setting of Alarm Delay is not applied to the apnea alarms and the ST alarms.
	ST Alarm Delay	30 sec	The monitor does not present the ST alarm if the alarm condition is resolved within the delay time.
Other	Lethal Arrhy Alarms Off	Disable	Selects whether lethal arrhythmia alarms can be switched off. <ul style="list-style-type: none"> • Disable: lethal arrhythmia alarms cannot be switched off. • Enable: lethal arrhythmia alarms can be switched off from the ECG menu.

Section	Menu Item	Default Setting	Description
	SPO2 Desat Alarm Off	Disable	Selects whether the SpO ₂ Desat alarm can be switched off. <ul style="list-style-type: none"> • Disable: the SpO₂ Desat alarm cannot be switched off. • Enable: the SpO₂ Desat alarm can be switched off.
	Apnea Alarm Off	Disable	Selects whether the apnea alarm can be switched off. <ul style="list-style-type: none"> • Disable: the apnea alarm cannot be switched off. • Enable: the apnea alarm can be switched off.
	Arrhy Shield Time	2 min	Alarm light and alarm tone will be disabled for designated period of time when certain arrhythmia alarms are detected. 0: disables this function.
	Intubation Mode Period	2 min	Selects the time for intubation.
	Print on Alarm	Printer	Printer: enables automatic printing via printer when a parameter alarm is triggered. Recorder: enables automatic recording via recorder when a parameter alarm is triggered.
	CMS/eGW Disconnected Alarm	Off	Selects whether an alarm is issued when the monitor is not connected or disconnected from the CMS/eGateway. Off: the "Offline" alarm is not presented when the monitor is not connected or disconnected from the CMS/eGateway.
	Notify Alarm Setting Change	Off	Selects whether the monitor gives a prompt when alarm settings, including alarm limits, priorities, and switches, are changed from the CMS.

23.5 The CAA Settings

23.5.1 The EWS Tab

Menu Item	Default Setting	Description
Clinician ID	Off	Selects whether to allow inputting the clinician ID to associate with the EWS score.
Clinician ID Timeout	10 min	Selects how long the clinician ID will remain valid
Default Adult Score	NEWS	Selects the default scoring tool for different patient categories
Default Ped Score	/	
Default Neo Score	/	
Manage Score	Local	Delete: deletes the selected scoring tools. The monitor provide MEWS, NEWS and NEWS2 by default. You cannot delete them.
	USB Drive	Import: imports the desired scoring tools to the monitor.

23.5.2 The GCS Tab

Menu Item		Default Setting	Description
Mild	High limit	15	Selects the threshold and color of each consciousness level.
	Low limit	13	
	Color	White	
Moderate	High limit	12	
	Low limit	9	
	Color	Yellow	
Severe	High limit	8	
	Low limit	3	
	Color	Red	

23.6 The Module Settings

23.6.1 The ECG Tab

Menu Item	Default Setting	Description
ECG Standard	AHA	Selects the ECG standard according to the leadwires you are using.
QTc Formula	Hodges	<p>Selects the QTc formula used to correct the QT interval for heart rate.</p> <ul style="list-style-type: none"> • Hodges: $QTc = QT + 1.75 \times (\text{HeartRate} - 60)$ • Bazett: $QTc = QT \times \left(\frac{\text{HeartRate}}{60} \right)^{\frac{1}{2}}$ • Fridericia: $QTc = QT \times \left(\frac{\text{HeartRate}}{60} \right)^{\frac{1}{3}}$ • Framingham: $QTc = QT + 154 \times \left(1 - \frac{60}{\text{HeartRate}} \right)$
12-Lead Order	No	Selects whether to send the order of 12-lead interpretation report to the hospital information system while saving the report.
CrozFusionSynTime	20 sec	Selects the period when the Crozfusion function suppresses the false arrhythmia alarms. Selects Off and the Crozfusion function always suppresses the false arrhythmia alarms.
ArrSuppressEvent	Disable	Selects whether to display arrhythmia suppression events in the events review page.
Calibration	/	Select this button to calibrate the ECG module.

23.6.2 The CO2 Tab (for uMEC 70/uMEC 80/uMEC 120/uMEC 150)

Menu Item	Default Setting	Description
Zero Recovery For 30s	On	<ul style="list-style-type: none"> On: After the zero calibration is completed, the CO₂ module reacquires the CO₂ readings. During the reacquisition period, "Zero Recovering" is displayed in the CO₂ numeric area. Off: After the zero calibration is completed, the CO₂ module reacquires the CO₂ readings. During the reacquisition period, "Zero Recovering" is not displayed in the CO₂ numeric area.
Zero	/	Select this button to start zeroing the CO ₂ module.
Gas Temperature	35.0	Select the temperature for the gas in the airway of the mainstream CO ₂ .

23.6.3 The Other Tab

Menu Item	Default Setting	Description
IBP Filter(for uMEC 70/uMEC 80/uMEC 120/uMEC 150)	12.5 Hz	/
PAWP Timeout(for uMEC 70/uMEC 80/uMEC 120/uMEC 150)	15 min	The measurements become outline fonts after a preset time. This avoids older values being misinterpreted as current measurements.
C.O. Timeout(for uMEC 70/uMEC 80/uMEC 120/uMEC 150)	15 min	
NIBP Timeout	15 min	
Outline Font for Suspected Values	Off	Selects whether unreliable HR and SpO ₂ measurements are displayed in outline font. This prevents unreliable measurements from being misinterpreted as normal measurements,

23.7 The Review Settings

23.7.1 The Tabs Tab

Menu Item	Default Setting	Description
Tabular Trends	Selected	Hides the trends you do not need to review if deselected.
Graphic Trends		
Events		
Full Disclosure		
OxyCRG		
12-Lead ECG		
ST		

23.7.2 The Event Tab

Menu Item		Default Setting	Description
Lethal	Lock	Selected	Selects what kind of events will be locked. Locked events will not be deleted.
High		Unselected	
Med			
Low			
Rename Event		On	Selects whether arrhythmia events can be renamed.

23.7.3 The Arrhy Mark Tab

From the **Arrhy Mark** page, you can define whether the compressed ECG waveform segments for arrhythmia events are marked with a specific background color.

23.7.4 The Export Tab

From the **Export** page, select **Export Patient Data**, and then select desired patients from the patient list to export data of selected patients via a USB drive.

23.7.5 The Save Path Tab

From the **Save Path** page, select the path to store review data:

- **Local:** store review data locally in the monitor.
- **USB Drive:** store review data in the U drive users plug into the monitor. When selecting this option, restart the monitor is required in order to make this option effective.

23.8 The Print Settings

23.8.1 The Printer Tab

Menu Item		Default Setting	Description
Connection Type		Printer	Selects you want to output patient reports via the print server or a network printer.
Printer IP Address		0.0.0.0	For printer only.
Paper Size		A4	
Printer Resolution		300 dpi	
Print Server Address		/	For print server only. If the CMS is used as the printer server, set the Port to 6603.
Print Server IP Address		/	
Port		6603	
General Report (for print server only)	Printer	/	Selects the default printer (for paper report only).
	Printer Resolution	/	Selects the resolution for the default printer (for paper report only).
	PDF Resolution	600 dpi	Selects the resolution for the default printer (for PDF report only).
	Print Action	Paper	Selects the media of the reports.
	Color Mode	Color	Select the default printer color.

Menu Item		Default Setting	Description
End Case Report (for print server only)	Printer	/	Selects the default printer (for paper report only).
	Printer Resolution	/	Selects the resolution for the default printer (for paper report only).
	PDF Resolution	600 dpi	Selects the resolution for the default printer (for PDF report only).
	Print Action	Paper	Selects the media of the reports.
	Color Mode	Color	Select the default printer color.
Print on Alarm Report (for print server only)	Printer	/	Selects the default printer (for paper report only).
	Printer Resolution	/	Selects the resolution for the default printer (for paper report only).
	PDF Resolution	600 dpi	Selects the resolution for the default printer (for PDF report only).
	Print Action	Paper	Selects the media of the reports.
	Color Mode	Color	Select the default printer color.
Print Test Page		/	Tests whether the printer works properly.

NOTE

- General reports refer to the reports other than the end case report and realtime alarm report.

23.8.2 The Report Layout Tab

Menu Item	Default Setting	Description
Report Layout	/	Selects the contents and location of the patient information included in non-ECG reports. N/A: refers to no information. Patient information configured in the Report Layout page is not applied to ECG reports.

23.8.3 The ECG Report Tab

Menu Item	Default Setting	Description
Patient Name	/	Selects the patient information you want to display on ECG reports.
Age (Gestational Age: Neo)		
Gender		
Patient ID	Selected	
Visit Number	Unselected	
DOB		
Race		
Medication		
Class		
Physician		
Technician		
Department		
Room No		
Bed No		
12-Lead Order		

23.8.4 The PDF File Name Tab

Menu Item	Default Setting	Description
PDF File Name	/	Selects the name of PDF files. N/A: refers to no information.

23.8.5 The Other Tab

Menu Item	Default Setting	Description
Second Mark (Printer)	On	Selects whether to show second marks on the report output by the printer.
Arrhy Setting(Recorder)	Off	Selects whether to include arrhythmia thresholds and QRS thresholds in the report output by the recorder.

23.9 The Unit Settings

Menu Item	Default Setting	Description
Height Unit	cm	Selects measurement unit for each parameter.
Weight Unit	kg	
ST Unit	mV	
Hb Unit	g/dl	
CVP Unit	cmH2O	
ICP Unit	mmHg	
CO2 Unit	mmHg	

Menu Item	Default Setting	Description
Temp Unit	°C	
Pressure Unit	mmHg	

23.10 The Time Settings

23.10.1 The Time Synchronization Tab

Section	Menu Item	Default Setting	Description
/	Time Zone	UTC- 0 0	Selects the time zone where the monitor belongs.
Nighttime	From	22:00	Selects the night time for heart rate statistics.
	To	06:00	
/	Start NTP Time Sync	Off	On: enables synchronizing the monitor time with the NTP server time.
	Interval	1 hr	Select the time interval for synchronizing the monitor time with the NTP server time.
	Time Server Address	/	The domain name of the time server.
	Time Server	/	The IP address of the time server.
	Network Test	/	Tests whether the NTP server is properly connected.

23.10.2 The Daylight Savings Time Tab

Section	Default Setting	Description
Auto Daylight Savings Time	Off	On: auto starts the daylight saving time.

23.11 The Other Settings

Menu Item	Default Setting	Description	
Barometric Pressure	760 mmHg	For the mainstream CO2 module, enter the value of barometric pressure to which the patient monitor is exposed to. Be sure to set the barometric pressure properly. Improper settings will result in erroneous measurements.	
Notch Frequency	50 Hz	Selects notch filter frequency according to the power line frequency of your country.	
Mouse Sensitivity	5	/	
Clear CMS IP at startup	On	/	
Parameter Output Setup	Baud Rate	Off	Reserved for future use.
	Parity Mode	None	
	Data Bits	8	
	Stop Bits	1	

Menu Item	Default Setting	Description
SpO2 Tone	Mode 1	Selects the SpO ₂ tone mode. The monitor adjusts the QRS tone (pitch tone) according to the SpO ₂ values. The same SpO ₂ tone mode shall be used for the same monitors in a single area.
Language	/	/
Parameters On/Off Config Influenced	On	Selects whether the settings of parameter switches are influenced by configuration
Parameters On/Off Protected	Off	Selects whether setting parameter switches is password protected.
Parameters On/Off	/	Selects what parameters can be monitored.
Browse System Log	/	Selects this button to enter the System Log page, and then select the log classifications you want to view. Selecting Search to view the selected logs. To view logs of certain date and time, select Jump To and define the date and time.
Export System Log	/	Selects this button to export the system log to the USB drive.
Manual Event Edit	OR: Off Other departments: On	Selects whether selecting and editing the name of a manual event is allowed.

23.12 The Authorization Setup Settings

Section	Menu Item	Default Setting	Description
/	Automatic Logout Time	20 sec	Selects timeout period of the MLDAP password for accessing the Maintenance menu, alarm settings and arrhythmia settings. If there is no operation after the specified timeout period is reached, you need to re-enter the password.
Maintenance	User Maintenance	Local Password	Selects the password for accessing the monitor's Maintenance menu. <ul style="list-style-type: none"> • Local Password: the monitor's password for accessing the Maintenance menu is required. • User Password: the user name and password saved in the MLDAP server are required.
	Modify Local Password	/	Changes the monitor's password for accessing the Maintenance menu.

Section	Menu Item	Default Setting	Description
Clinical Setting	Alarm Setup	No Password	Selects the password for changing alarm settings. <ul style="list-style-type: none"> • No Password: changing alarm settings is not password protected. • Local Password: changing alarm switch, alarm limit, and alarm priority is password protected. The monitor's clinical password is required. • User Password: changing alarm switch, alarm limit, and alarm priority is password protected. The user name and password saved in the MLDAP server are required.
	Arrhythmia	No Password	Selects the password for changing arrhythmia settings. <ul style="list-style-type: none"> • No Password: changing arrhythmia settings is not password protected. • Local Password: changing arrhythmia switch, alarm priority, and arrhythmia threshold is password protected. The monitor's clinical password is required. • User Password: changing arrhythmia switch, alarm priority, and arrhythmia threshold is password protected. The user name and password saved in the MLDAP server are required.
	View Discharged Patients	No Password	Selects the password for viewing discharged patients. <ul style="list-style-type: none"> • No Password: viewing discharged patients is not password protected. • User Password: viewing discharged patients is password protected. The user name and password saved in the MLDAP server are required.
	Viewing Patient Review Data	No Password	Selects the password for viewing discharged patients. <ul style="list-style-type: none"> • No Password: reviewing patient data is not password protected. • Local Password: reviewing patient data is password protected. The monitor's clinic password is required.
	Modify Local Password	/	Changes the monitor's clinical password.

23.13 The Version Settings

Tab	Default Setting	Description
Version	/	Displays system software version, module hardware and software version, and firmware version.

23.14 The Battery Information Settings

Tab	Default Setting	Description
Battery	/	Displays battery information.

23.15 The Scanner Settings

23.15.1 The 2D Barcode Tab (for the Mindray Custom 2D Barcode Reader)

Tab	Default Setting	Description
2D Barcode	/	Establishes the relationship between the monitor data and barcode data for selectable patient demographics. For example, the monitor has an option of Ped for patient category. In your hospital barcode, the text may read as Pediatric . You need to input Pediatric for the field Ped to establish their relationship.

23.15.2 The 1D Barcode Tab

Menu Item	Default Setting	Description
Content Fill to	Patient ID	/

23.15.3 The Scanner Information Tab

Menu Item	Default Setting	Description
Scanner Type	2D Scanner	<ul style="list-style-type: none">• 1D Scanner: select this option when you are using a 1D scanner or a 2D scanner other than the Mindray custom 2D scanner.• 2D Scanner: select this option when you are using the Mindray custom scanner.
Data Encoding Type	UTF8	When you set Scanner Type to 2D Scanner , default settings are applied to Data Encoding Type and Data Parse Mode . You do not need to change these settings.
Data Parse Mode	Local	

23.15.4 The Identify Scanner Tab (for the non-Mindray Custom 2D Barcode Reader)

Tab	Default Setting	Description
Identify Scanner	/	When you are using barcode readers other than HS-1R or HS-1M, you should select the barcode reader from the USB device list, so that the monitor can identify the barcode reader. From the USB device list, select the barcode reader you are using.

23.15.5 The Field Tab (for the Mindray Custom 2D Barcode Reader)

Menu Item	Default Setting	Description
Patient ID	Selected	Selects desired patient information to be output by the barcode reader.
First Name		
Last Name		
Patient Category		
Gender		
DOB		
Visit Number	Unselected	
Room No		
Bed No		
Age (Gestational Age: Neo)		
Department		
Custom Field 1 - Custom Field 4		

23.16 The Network Setup Settings

23.16.1 The Network Type Tab

Menu Item	Default Setting	Description
Monitor	Auto	Selects what kind of network your monitor will use. Auto: the monitor automatically identify your network type.

23.16.2 The LAN1 IP Tab

Menu Item	Default Setting	Description
Obtain IP Address Automatically	Selected	Automatically gets the IP address.
Use the Following Address	Unselected	IP Address, Subnet Mask, and Gateway are required.
IP Address	0.0.0.0	
Subnet Mask	0.0.0.0	
Gateway	0.0.0.0	
Obtain DNS address automatically	Selected	Automatically gets the DNS address
Using the Following DNS Address	Unselected	IP addresses of Preferred DNS Server and Alternate DNS Server are required.
Preferred DNS Server	0.0.0.0	
Alternate DNS Server	0.0.0.0	

23.16.3 The WLAN Tab

Menu Item	Default Setting	Description
Add WLAN	/	Add wireless network and set the network in the pop-up menu.

Menu Item		Default Setting	Description
WLAN	Name	/	Input the name of the wireless network.
	SSID	/	/
	Security	WEP OFF	Selects the security method.
	Password	/	Input the password for entering the wireless network.
WLAN IP	Obtain IP Address Automatically	On	Selects whether to enable the function of automatically getting the IP address.
	Use the Following Address	Off	Selects whether inputting the IP Address , Subnet Mask , and Gateway is required.
	IP Address	0.0.0.0	
	Subnet Mask	0.0.0.0	
	Gateway	0.0.0.0	
	Obtain DNS address automatically	On	Selects whether to enable the function of automatically getting the DNS address.
	Using the Following DNS Address	Off	Selects whether inputting the IP address of Preferred DNS Server and Alternate DNS Server is required.
	Preferred DNS Server	0.0.0.0	
Alternate DNS Server	0.0.0.0		
WLAN Setup	WLAN Band	Auto	Auto: automatically identifies the WLAN band.
	2.4G Channel	All	Selects the 2.4G channels.
	5G Channel	All	Selects the 5G channels.
Network Test		/	Tests whether the wireless network is properly connected.
Certificate Management	Local	/	Delete: delete the selected certifications.
	USB Drive	/	Select certifications you want to import from the USB memory, and then select Import: import the desired certifications from the USB memory.

23.16.4 The Central Station Setup Tab

Menu Item		Default Setting	Description
Select CMS		On	Selects whether to enable the CMS selection function for your monitor.
Add Central Station		/	Inputs the name, department, and server address of the CMS. You can add up to 30 CMSs for the monitor.

23.16.5 The Device Discover Tab

Multicast helps device discovery between monitors and between monitors and CMS. Devices in the same multicast group can be mutually discovered.

Menu Item		Default Setting	Description
Multicast TTL		1	/
Multicast Address		225.0.0.8	

Menu Item	Default Setting	Description
Master Server Address	/	
Master Server IP Address	0.0.0.0	
Connected Status	Disconnected	
Network Test	/	Tests whether the master server is properly connected.

23.16.6 The QoS Tab

Menu Item	Default Setting	Description
QoS Level For Realtime Monitoring	0	Selects the service quality of network connection for realtime monitoring, for example parameter measurements and waveforms, alarms, and so on
QoS Level For Others	0	Selects the service quality of network connection for non-realtime monitoring, for example history data, printing, and as on.

23.16.7 The ADT Tab

The ADT (admit-discharge-transfer) gateway is normally deployed in the eGateway. You can obtain patient information from the hospital ADT server through the ADT gateway.

Menu Item	Default Setting	Description
Server Address	192.168.0.100	Input the host name or IP address of the ADT gateway.
IP Address	192.168.0.100	
Port	3502	Input the port of the ADT gateway.
ADT Query	Off	Selects whether patient information can be loaded to the monitor from the ADT server.
Network Test	/	Tests whether the ADT server is properly connected.

23.16.8 The HL7 Configuration Tab

You can send the realtime data, waveforms, and alarms from the monitor to the hospital servers via HL7 protocol. This page also display the server connection status. Licenses are required for sending data, waveforms, and alarms via HL7.

Section	Menu Item	Default Setting	Description
Data + Waveforms	Server Address	/	Inputs the name or IP address for the server receiving the realtime data and waveform.
	Destination IP	0.0.0.0	
	Port	0	/
	Send Data	Off	
	Data Interval	30 sec	
	Send Waveforms	Off	
	Connection Status	Disconnected	

Section	Menu Item	Default Setting	Description
Alarms	Server Address	/	Inputs the name or IP address for the server receiving the alarm data.
	Destination IP	0.0.0.0	
	Port	0	/
	Send Alarms	Off	
	Connection Status	Disconnected	
Compatibility	HL7 Protocol Version	HL7 Protocol Version	Selects the version of the HL7 protocol.

23.16.9 The Information Security Tab

Menu Item	Default Setting	Description
Encryption Connection Type	Only Private Encryption	<ul style="list-style-type: none"> • Only Private Encryption: Mindray private encryption is used to encrypt the transmitted data. You cannot connect devices supporting SSL (secure sockets layer) encryption. • SSL Encryption Priority: for devices supporting SSL encryption, SSL encryption is used when connecting the devices. For devices not supporting SSL encryption, private encryption is used when connecting the devices.
Broadcast Patient Demographics	On	<ul style="list-style-type: none"> • On: when viewing other patients, device location and patient information of remote devices are displayed in the remote device list. • Off: patient information does not display in the remote device list.

23.16.10 The MLDAP Tab

Menu Item	Default Setting	Description
Server Address	/	Inputs the name or IP address for the MLDAP server.
IP Address	0.0.0.0	
Port	0	/
Network Test	/	Tests whether the monitor is properly connected with the MLDAP server.

This page intentionally left blank.

24 Battery

24.1 Battery Introduction

This monitor is designed to operate battery power when the external power supply is not available. The monitor uses mains power as primary power source. In case of mains power failure, the monitor automatically runs on the battery power.

NOTE

- If the power input fails and the monitor runs on the battery power, the display brightness automatically lowers to the dimmest. You can manually adjust the display brightness as required.
-

24.2 Battery Safety Information

WARNING

- Keep batteries out of children's reach.
 - Use only specified battery. Use of a different battery may present a risk of fire or explosion.
 - Keep the batteries in their original package until you are ready to use them.
 - Do not expose batteries to liquid.
 - Do not crush, drop or puncture the battery. Mechanical abuse can lead to internal damage and internal short circuits. If a battery has been dropped or banged against a hard surface, whether damage is externally visible or not, remove the battery from use and dispose of it properly.
 - If the battery shows signs of damage or signs of leakage, replace it immediately.
 - The battery should be charged only in this monitor.
 - Extremely high ambient temperature may cause battery overheat protection, resulting in monitor shutdown.
 - The lithium-ion battery has a service life of three years. Replace your battery when it reaches the end of its service life. Failure to replace the battery may cause serious damage to your equipment from battery overheating.
 - Lithium batteries replaced by inadequately trained personnel could result in a hazard (such as excessive temperatures, fire or explosion).
 - Do not open batteries, heat batteries above 60 °C, incinerate batteries, or short battery terminals. They may ignite, explode, leak or heat up, causing personal injury.
-

CAUTION

- Remove the battery before shipping the monitor or if it will not be used for an extended period of time.
-

24.3 Battery Indications

The battery LED, on-screen battery symbols, and related alarm messages indicate the battery status.

24.3.1 Battery LED





The battery LED indications are as follows:

- Green: the battery is fully charged or being charged.
- Flashing green: the monitor runs on battery power.

- Off: no battery is installed, or the battery malfunctions, or the AC mains is not connected when the monitor is powered off.

24.3.2 Battery Symbols

The on-screen battery symbols indicate the battery status as follows:

-  indicates that the battery works correctly. The green portion represents the remaining charge.
-  indicates that the battery power is low and needs to be charged.
-  indicates that the battery is almost depleted and needs to be charged immediately. Otherwise, the monitor will soon automatically shut down.
-  indicates that the battery is being charged.
-  indicates that no battery is installed or the battery fails.

24.3.3 Battery-related Alarms

The capacity of the battery is limited. When the battery is low, the monitor presents the **Low Battery** alarm, the alarm lamp flashes, and the monitor produces an alarm sound.

If the battery is almost depleted, the monitor presents the **Critically Low Battery** alarm. In this case, immediately connect the AC mains to power the monitor and charge the battery. Otherwise, the monitor will automatically shut down soon.

For more information on battery-related alarms, see *D Alarm Messages*.

24.4 Charging the Battery

The battery is recharged automatically when the monitor is connected to the external power supply.

24.5 Maintaining the Battery

24.5.1 Conditioning the Battery

The performance of batteries deteriorates over time. You should condition the batteries every three months.

If the battery is not conditioned for a prolonged time, its charge indication may not be accurate and you may wrongly evaluate the remaining battery runtime.

To condition a battery, follow this procedure:

1. Disconnect the monitor from the patient and stop all monitoring and measuring procedures.
2. Turn off the monitor, and connect the monitor to the external power supply.
3. Allow the battery to be charged uninterruptedly till it is fully charged.
4. Disconnect the monitor from the external power supply, and turn on the monitor.
5. Allow the monitor to run on the battery until the battery is completely depleted and the monitor automatically shuts down.
6. Connect the monitor to the external power supply again and fully charge the battery again for use or charge it to 40 – 60% for storage.

NOTE

- **Do not use the monitor to monitor the patient during battery conditioning.**
- **Do not keep the battery fully charged without routine conditioning; otherwise, the aging process will be accelerated.**
- **Do not interrupt battery conditioning.**

24.5.2 Checking Battery Performance

The performance of a rechargeable battery deteriorates over time. You should check the battery performance every three months or if you doubt that the battery may fail.

See steps 1 to 5 of *24.5.1 Conditioning the Battery* to check battery performance. The operating time of the battery reflects their performance directly. If the operating time of a battery is noticeably shorter than that stated in the specifications, the battery may reach its service life or malfunction. If the battery performance meets the requirement, fully charge the battery again for use or charge it to 40 – 60% for storage.

NOTE

- **Battery operating time depends on equipment configuration and operation. For example, high display brightness or measuring NIBP repeatedly will shorten the battery operating time.**
-

24.6 Storing Batteries

When storing batteries, make sure that the battery terminals do not come into contact with metal objects. If batteries are stored for an extended period of time, place the batteries in a cool place with a partial charge of 40% to 60% capacity.

Condition the stored batteries every three months. For more information, see *24.5.1 Conditioning the Battery*.

NOTE

- **Remove the battery from the equipment if the equipment is not used for a prolonged time (for example, several weeks). Otherwise the battery may over discharge.**
 - **Storing batteries at high temperature for an extended period of time will significantly shorten their life expectancy.**
 - **The battery storage temperature is between -5 °C and 35 °C. Storing batteries in a cool place can slow the aging process. Ideally the batteries should be stored at 15 °C.**
-

24.7 Recycling Batteries

Discard a battery in the following situations:

- The battery has visual signs of damage.
- The battery fails.
- The battery is aged and its runtime significantly less than the specification.
- The battery service life is reached.

Properly dispose of batteries according to local regulations.

WARNING

- **Do not open batteries, heat batteries above 60 °C, incinerate batteries, or short the battery terminals. They may ignite, explode, leak or heat up, causing personal injury.**
-
-

This page intentionally left blank.

25 Care and Cleaning

25.1 Care and Cleaning Introduction

In this chapter we only describe cleaning and disinfection of the monitor and certain accessories. For the cleaning and disinfection of other reusable accessories, refer to their instructions for use.

25.2 Care and Cleaning Safety Information

WARNING

- **Use only cleaners, disinfectants and methods specified in this chapter. Using unapproved substances or methods may damage the equipment and void the warranty.**
 - **Do not mix disinfecting solutions, as hazardous gases may result.**
 - **Mindray is not liable for the efficacy of the specified cleaners, disinfectants, or methods as a means for controlling infection. Refer to your hospital for infection controlling.**
 - **Be sure to turn off the system and disconnect all power cables from the outlets before cleaning the equipment.**
 - **The responsible hospital or institution shall carry out all cleaning and disinfection procedures specified in this chapter.**
-

CAUTION

- **Never immerse any part of the equipment or accessories in liquids or allow liquid to enter the interior.**
 - **Any contact of cleaners or disinfectants with connectors or metal parts may cause corrosion.**
 - **Do not pour or spray any liquid directly on the equipment or accessories or permit fluid to seep into connections or openings.**
 - **If you spill liquid on the equipment or accessories, disconnect the power supply, dry the equipment, and contact your service personnel.**
 - **Never use abrasive materials (such as steel wool or silver polish), or erosive cleaners (such as acetone or acetone-based cleaners).**
 - **Dilute and use the cleaners or disinfectants according to the manufacturer's instructions.**
 - **Check the equipment after cleaning and disinfecting. If there is any sign of damage, remove it from use.**
-

25.3 Cleaning the Monitor

Clean your equipment on a regular basis. Before cleaning the equipment, consult your hospital's regulations for cleaning the equipment.

To clean the equipment, follow this procedure:

1. Dampen a soft lint-free cloth with water or ethanol (70%).
2. Wring excess liquid from the cloth.
3. Wipe the display screen of the monitor.
4. Wipe the external surface of the monitor with the damp cloth, avoiding the connectors and metal parts.
5. Dry the surface with a clean cloth. Allow the equipment air dry in a ventilated and cool place.

CAUTION

- **During the cleaning procedure, disable the touch operation by switching off the monitor or locking the touchscreen.**
 - **Any contact of cleaners or disinfectants with connectors or metal parts may cause corrosion.**
-

25.4 Disinfecting the Monitor

Disinfect the equipment as required in your hospital's servicing schedule. Cleaning the equipment before disinfecting is recommended. Always dilute and use disinfectants according to the manufacturer's instructions. The following table lists approved disinfectants:

Product Name	Product Type	Manufacturer
PDI Super Sani-Cloth® Germicidal Disposable Wipe	Wipes	PDI Inc.
Ethanol, 70%	Liquid	/
Isopropanol, 70%	Liquid	/
Sodium hypochlorite bleach, 0.5%	Liquid	/
Hydrogen peroxide, 3%	Liquid	/
Rely+On™ Virkon® High Level surface Disinfectant, 1%	Powder	Antec International Ltd
1-Propanol, 50%	Liquid	/

25.5 Cleaning and Disinfecting the Accessories

To clean and disinfect the following accessories, using cleansers, disinfectants, and methods described in this manual:

- NIBP air hose
- SpO₂ cable

For other accessories, you should consult the instructions delivered with the accessories.

CAUTION

- **Fluids entering the NIBP air hose can damage the equipment. When cleaning or disinfecting the NIBP air hose, prevent liquid from entering the hose.**
 - **Periodically inspect the NIBP air hose and connector for signs of wear or deterioration after cleaning or disinfecting the NIBP air hose. Replace the NIBP air hose if you detect a leak. Dispose of damaged NIBP air hose according to local laws for disposal of hospital waste.**
 - **Never immerse or soak the accessories in any liquid.**
 - **Never clean or disinfect the connectors and metal parts.**
 - **Use only Mindray approved cleaners and disinfectants and methods listed in this section to clean or disinfect the accessories. Warranty does not cover damage caused by unapproved substances or methods.**
 - **To avoid long term damage, the accessories should be disinfected only when necessary as determined by your hospital's policy.**
-

25.5.1 Cleaning the Accessories

You should clean the accessories on a regular basis. Before cleaning the accessories, consult your hospital's regulations for cleaning the accessories.

To clean the accessories, follow this procedure:

1. Clean the accessories with a soft cloth moistened with water or ethanol (70%).

2. Wipe off all the cleaner residue with a dry cloth.
3. Allow the accessories to air dry.

25.5.2 Disinfecting the Accessories

We recommend that the accessories should be disinfected only when necessary as determined by your hospital's policy. Cleaning the accessories before disinfecting is recommended.

25.5.2.1 Disinfectants for the NIBP Air Hose

The following table lists approved disinfectants for the NIBP air hose:

Product Name	Product Type	Manufacturer
Glutaraldehyde, 2%	Liquid	/
Ethanol, 70%	Liquid	/
Isopropanol, 70%	Liquid	/

25.5.2.2 Disinfectants for the SpO₂ Cable

The following table lists approved disinfectants for the SpO₂ cables:

Product Name	Product Type	Manufacturer
CIDEX® OPA	Liquid	Gilag GmbH International Advanced Sterilization products
Clorox Dispatch® Hospital Cleaner Disinfectant Towels with Bleach	Wipes	Clorox professional products company
Clorox Healthcare® Bleach Germicidal Wipes	Wipes	Clorox professional products company
Clorox Healthcare® Hydrogen Peroxide Cleaner Disinfectant Wipes	Wipes	Clorox professional products company
Diversey Oxivir® TB Wipes	Wipes	Diversey Inc
PDI Super Sani-Cloth® Germicidal Disposable Wipe	Wipes	PDI Inc.
VIRAGUARD® Hospital Surface Disinfectant Towelette	Wipes	VERIDIEN corporation
Virex® TB	Liquid, spray	Diversey Inc
Glutaraldehyde, 2%	Liquid	/
Ethanol, 70%	Liquid	/
Isopropanol, 70%	Liquid	/
Sodium hypochlorite bleach, 0.5%	Liquid	/
Hydrogen peroxide, 3%	Liquid	/
Rely+On™ Virkon® High Level surface Disinfectant, 1%	Powder	Antec International Ltd
1-Propanol, 50%	Liquid	/

25.6 Sterilization

Do not sterilize the monitor, accessories, or supplies unless otherwise specified in the instructions for use delivered with the accessories and supplies.

25.7 Cleaning the Thermal Print Head

Dirty print head deteriorates printing quality. Check the printout to ensure the printing is legible and dark. Light printing may indicate a dirty print head.

To clean the thermal print head, follow this procedure:

1. Take measures against the static electricity, such as the wrist strap.
2. Remove the recorder module from the module rack.
3. Open the recorder door and remove the recording paper.
4. Gently wipe the print head with cotton swabs dampened with ethanol to remove the dust and foreign particles.
5. Wipe off excess moisture with dry cotton swabs.
6. Allow the print head air dry.
7. Reload the recording paper and close the recorder door.

CAUTION

- **Do not use anything that may destroy the thermal element.**
 - **Do not add unnecessary force to the thermal head.**
 - **The thermal print head gets hot when recording. Do not clean the print head immediately after recording.**
-

25.8 Impact of Improper Cleaning

Using cleaners other than those recommended may have the following impact:

- Product discoloration
- Metal part corrosion
- Brittle and breaking wires, connectors, and equipment housing
- Reduced cable and leadwire life
- Overall system performance degradation
- Equipment malfunction or failure

26 Maintenance

26.1 Maintenance Introduction

Regular maintenance is essential to ensure that the equipment functions properly. This chapter contains information on periodic testing and maintenance.

26.2 Maintenance Safety Information

WARNING

- Follow the maintenance and testing schedule or local regulations to perform testing and maintenance. Not implementing the maintenance schedule may cause equipment failure and possible health hazards.
 - No modification of this equipment is allowed.
 - This equipment contains no user serviceable parts.
 - The safety checks or maintenance involving any disassembly of the equipment should be performed by professional service personnel. Otherwise, undue equipment failure and possible health hazards could result.
 - Do not open batteries, heat batteries to above 60 °C, incinerate batteries, or short the battery terminals. Batteries may ignite, explode, leak or heat up, causing personal injury.
 - The service personnel must be properly qualified and thoroughly familiar with the operation of the equipment.
-

CAUTION

- The equipment and accessories shall not be served or maintained while in use with a patient.
 - If a problem occurs to the equipment, contact the service personnel.
 - Use and store the equipment within the specified temperature, humidity, and elevation ranges.
 - When disposing of the packaging material, be sure to observe the applicable waste control regulations and keep it out of children's reach.
 - At the end of its service life, the equipment, as well as its accessories, must be disposed of in compliance with the guidelines regulating the disposal of such products. If you have any questions concerning disposal of the equipment, please contact Mindray.
-

NOTE

- If needed, contact the manufacture for circuit diagrams, component part lists, descriptions, calibration instructions, or other information concerning the repair of the equipment.
-

26.3 Maintenance and Testing Schedule

Follow the maintenance and testing schedule or local regulations to perform testing and maintenance. Make sure to clean and disinfect the equipment before taking any tests and maintenance

The following table lists the maintenance and testing schedule:

Test/Maintenance Item		Recommended Frequency
Performance Tests		
Visual inspection		Every day, before first use.
Measurement module performance test and calibration		<ol style="list-style-type: none"> 1. If you suspect that the measurement values are incorrect. 2. Follow any repairs or replacement of relevant module. 3. Once a year for the CO₂ test. 4. Once every two years for other parameter module performance tests.
Analog output test		If you suspect that the analog output function does not work properly.
Defibrillation synchronization test		If you suspect that the defibrillation synchronization function does not work properly.
Nurse call test		If you suspect that the nurse call function does not work properly.
Electrical Safety Tests		
Electrical safety tests		Once every two years.
Other Tests		
Power-on test		Before use.
Recorder check		<ol style="list-style-type: none"> 1. When the recorder is used for the first time. 2. Follow any repair or replacement of the recorder.
Network printer tests		<ol style="list-style-type: none"> 1. When first installed. 2. Follow any repair or replacement of the printer.
Battery check	Functionality test	<ol style="list-style-type: none"> 1. When first installed. 2. When battery is replaced.
	Performance test	Every three months or if the battery runtime reduced significantly.

26.4 Checking Version Information

You may be asked for information on monitor and module version.

To view system software version information, select the **Main Menu** hard key or quick key → from the **System** column select **Version**.

You can check system software version, module hardware and software version, and firmware version. For more information, see 23.13 *The Version Settings*.

26.5 Testing Methods and Procedures

Except the following maintenance tasks, all other test and maintenance tasks should be performed by Mindray-qualified service personnel only.

- Regular check, including visual inspection and power-on test
- Printer and recorder tests
- Battery check

If your equipment needs a safety test and performance test, contact the service personnel.

26.5.1 Performing Visual Inspection

Visually inspect the equipment before its first used every day. If you find any signs of damage, remove the equipment from use and contact the service personnel.

Verify that the equipment meets the following requirements:

- Environment and power supply specifications are met.
- The monitor housing and display screen are free from cracks or other damages
- The power cord is not damaged and the insulation is in good condition.
- Connectors, plugs, and cables are not damaged and kinked.
- Power cord and patient cables are securely connected with the equipment and modules.

26.5.2 Performing Power-on Test

The equipment automatically performs a selftest at startup. Check the following items for the power-on test:

- The equipment powers on properly.
- The alarm system works properly.
- The equipment displays properly.

26.5.3 Testing the Recorder

To test the recorder, follow this procedure:

1. Start a recording task to print waveforms and reports.
2. Check that the recorder functions correctly.
3. Check that the printout is clear without missing dots.

26.5.4 Testing the Network Printer

To check the printer, follow this procedure:

1. Start a printing task to print waveforms and reports.
2. Check that the printer is properly connected and functions correctly.
3. Check that the printout is clear without missing dots.

26.5.5 Checking the Battery

For information on battery check, see *24.5.2 Checking Battery Performance*.

26.6 Disposing of the Equipment

Dispose of the monitor and its accessories when its service life is reached. Follow local regulations regarding the disposal of such product.

WARNING

- **Unless otherwise specified, dispose of parts and accessories in accordance with local regulations regarding disposal of hospital waste.**
-
-

This page intentionally left blank.

27 Accessories

The accessories listed in this chapter comply with the requirements of IEC 60601-1-2 when in use with the patient monitor. The accessory material that contacts the patients has undertaken the bio-compatibility test and is verified to be in compliance with ISO 10993-1. For details about the accessories, refer to the instructions for use provided with the accessory.

WARNING

- **Use accessories specified in this chapter. Using other accessories may cause damage to the monitor or not meet the claimed specifications.**
- **Single use accessories are not designed to be reused. Reuse may cause a risk of contamination and affect the measurement accuracy.**

CAUTION

- **The accessories may not meet the performance specifications if stored or used outside the specified temperature and humidity ranges. If accessory performance is degraded due to aging or environmental conditions, contact your service personnel.**
- **Check the accessories and their packages for any sign of damage. Do not use them if any damage is detected.**
- **Use the accessories before the expiry date if their expiry date is indicated.**
- **The disposable accessories shall be disposed of according to hospital's regulations.**

27.1 ECG Accessories

27.1.1 ECG Electrodes

Model	PN	Description	Applicable patient
31499224	0010-10-12304	Electrode, Kendall, 10 pcs/package	Adult
SF06	040-002711-00	Electrode, 5 pcs/package	Adult
SF06	040-007077-00	Electrode, 3 pcs/package	Adult
SF07	040-002833-00	Electrode, Intco	Pediatric, Neonate
31.1245.21	900E-10-04880	Electrode, Kendall, 50 pcs/package	Neonate
EMG-SN10-20×20	040-003254-00	NEO Pre-wired Electrode radio Translucent, AHA	Neonate

27.1.2 12-Pin Separable Trunk Cables

Model	PN	Description	Applicable patient
EV6201	0010-30-42719	ECG cable,12-pin, 3/5-lead, defibrillation-proof AHA/IEC	Adult, Pediatric
EV6202	0010-30-42720	ECG cable,12-pin, 3-lead, defibrillation-proof, AHA/IEC	Neonate, Infant
EV6203	0010-30-42721	ECG cable, 12-lead, defibrillation-proof, AHA	Adult
EV6204	0010-30-42722	ECG cable, 12-lead, defibrillation-proof, IEC	Adult

Model	PN	Description	Applicable patient
EV6211	0010-30-42723	ECG cable, 12-pin, 3/5-lead, ESU-proof, AHA/IEC	Adult, Pediatric
EV6212	0010-30-42724	ECG cable, 12-pin, 3-lead, ESU-proof, AHA/IEC	Neonate, Infant
EV6206	009-005266-00	ECG cable, defibrillation-proof, 3.1 m, T/N series	Adult, Pediatric
EV6216	009-005268-00	ECG cable, ESU-proof, 3.1 m, T/N series	Adult, Pediatric
EV6222	040-000754-00	ECG cable, 12-pin, 3-lead, defibrillation-proof, DIN connector	Neonate

27.1.3 12-Pin Integrative Trunk Cables

Model	PN	Description	Applicable patient
EA6251B	040-000961-00	ECG cable, 12-pin, 5-lead, AHA, snap	Adult, Pediatric
EA6252B	040-000963-00	ECG cable, 12-pin, 5-lead, IEC, snap	Adult, Pediatric
EA6251A	040-000960-00	ECG cable, 12-pin, 5-lead, AHA, clip	Adult, Pediatric
EA6252A	040-000962-00	ECG cable, 12-pin, 5-lead, IEC, clip	Adult, Pediatric
EA6231B	040-000965-00	ECG cable, 12-pin, 3-lead, AHA, snap	Adult, Pediatric
EA6232B	040-000967-00	ECG cable, 12-pin, 3-lead, IEC, snap	Adult, Pediatric
EA6231A	040-000964-00	ECG cable, 12-pin, 3-lead, AHA, clip	Adult, Pediatric
EA6232A	040-000966-00	ECG cable, 12-pin, 3-lead, IEC, clip	Adult, Pediatric
EA6233B	125-000338-00	ECG cable, 12-pin, 3-lead, AHA, snap	Adult, Pediatric
EA6234B	125-000339-00	ECG cable, 12-pin, 3-lead, IEC, snap	Adult, Pediatric

27.1.4 3-lead ECG Leadwires

Model	PN	Description	Length	Applicable patient
EL6305A	0010-30-42896	ECG leadwires, 3-lead, AHA, clip, long	1 m	Neonate, Infant
EL6306A	0010-30-42897	ECG leadwires, 3-lead, IEC, clip, long	1 m	Neonate, Infant
EL6303A	0010-30-42731	ECG leadwires, 3-lead, AHA, clip, long	1 m	Adult, Pediatric
EL6304A	0010-30-42732	ECG leadwires, 3-lead, IEC, clip, long	1 m	Adult, Pediatric
EL6301B	0010-30-42734	ECG leadwires, 3-lead, AHA, snap, long	1 m	Adult, Pediatric
EL6302B	0010-30-42733	ECG leadwires, 3-lead, IEC, snap, long	1 m	Adult, Pediatric
EL6311B	040-000146-00	ECG leadwires, 3-lead, AHA, snap, long, disposable	1 m	Neonate, Infant
EL6312B	040-000147-00	ECG leadwires, 3-lead, IEC, snap, long, disposable	1 m	Neonate, Infant
EL6311A	040-000148-00	ECG leadwires, 3-lead, AHA, snap, long, disposable	1 m	Neonate, Infant
EL6312A	040-000149-00	ECG leadwires, 3-lead, IEC, snap, long, disposable	1 m	Neonate, Infant

27.1.5 5-lead ECG Leadwires

Model	PN	Description	Length	Applicable patient
EL6503A	0010-30-42729	ECG leadwires, 5-lead, AHA, clip, long	1m to 1.4m	Adult, Pediatric
EL6504A	0010-30-42730	ECG leadwires, 5-lead, IEC, clip, long	1m to 1.4m	Adult, Pediatric
EL6501B	0010-30-42735	ECG leadwires, 5-lead, AHA, snap	1m to 1.4m	Adult, Pediatric
EL6502B	0010-30-42736	ECG leadwires, 5-lead, IEC, snap	1m to 1.4m	Adult, Pediatric

27.1.6 6-lead ECG Leadwires

Model	PN	Description	Length	Applicable patient
EY6601B	009-004794-00	ECG leadwires, 6-lead, AHA, snap, 24 inch	24 inch	Adult, Pediatric
EY6602B	009-004795-00	ECG leadwires, 6-lead, AHA, snap, 36 inch	36 inch	Adult, Pediatric
EY6603B	009-004796-00	ECG leadwires, 6-lead, IEC, snap, 24 inch	24 inch	Adult, Pediatric
EY6604B	009-004797-00	ECG leadwires, 6-lead, IEC, snap, 36 inch	36 inch	Adult, Pediatric
EY6601A	009-004798-00	ECG leadwires, 6-lead, AHA, clip, 24 inch	24 inch	Adult, Pediatric
EY6602A	009-004799-00	ECG leadwires, 6-lead, AHA, clip, 36 inch	36 inch	Adult, Pediatric
EY6603A	009-004800-00	ECG leadwires, 6-lead, IEC, clip, 24 inch	24 inch	Adult, Pediatric
EY6604A	009-004801-00	ECG leadwires, 6-lead, IEC, clip, 36 inch	36 inch	Adult, Pediatric

27.1.7 12-lead ECG Leadwires

Model	PN	Description	Length	Applicable patient
EL6801A	0010-30-42902	ECG leadwires, 12-lead, limb lead, AHA, clip	0.8 m	Adult
EL6803A	0010-30-42904	ECG leadwires, 12-lead, chest lead, AHA, clip	0.6 m	Adult
EL6802A	0010-30-42903	ECG leadwires, 12-lead, limb lead, IEC, clip	0.8 m	Adult
EL6804A	0010-30-42905	ECG leadwires, 12-lead, chest lead, IEC, clip	0.6 m	Adult
EL6801B	0010-30-42906	ECG leadwires, 12-lead, limb lead, AHA, snap	0.8 m	Adult
EL6803B	0010-30-42908	ECG leadwires, 12-lead, chest lead, AHA, snap	0.6 m	Adult
EL6802B	0010-30-42907	ECG leadwires, 12-lead, limb lead, IEC, snap	0.8 m	Adult
EL6804B	0010-30-42909	ECG leadwires, 12-lead, chest lead, IEC, snap	0.6 m	Adult

27.2 SpO₂ Accessories

Wavelength emitted by the sensors is between 600 nm and 1000 nm. The maximum photic output consumption of the sensor is less than 18 mW.

The information about the wavelength range and maximum photic output consumption can be especially useful to clinicians, for example, when photodynamic therapy is performed.

27.2.1 Extension Cables

Model	Part No.	Description	Applicable patient
562A	0010-20-42710	7-pin, Mindray	All

27.2.2 SpO₂ Sensors

Model	PN	Description	Applicable patient	Application site
512F	512F-30-28263	Reusable SpO ₂ sensor	Adult	Finger
512FLH	115-012807-00	Reusable SpO ₂ sensor	Adult	Finger
512H	512H-30-79061	Reusable SpO ₂ sensor	Pediatric	Finger
512E	512E-30-90390	Reusable SpO ₂ sensor	Adult	Finger
512G	512G-30-90607	Reusable SpO ₂ sensor	Pediatric	Finger
518B	518B-30-72107	Reusable SpO ₂ sensor	All	Neonate: foot; Adult, pediatric: finger
518BLH	115-050154-00	Reusable SpO ₂ sensor	Neonate	Foot
518BLH	115-020887-00	Reusable SpO ₂ Sensor	All	Neonate: foot; Adult, pediatric: finger
520A	009-005087-00	Disposable SpO ₂ sensor	Adult	Finger
520P	009-005088-00	Disposable SpO ₂ sensor	Pediatric	Finger
520I	009-005089-00	Disposable SpO ₂ sensor	Infant	Toe
520N	009-005090-00	Disposable SpO ₂ sensor	Adult, Neonate	Finger, Foot
521A	009-005091-00	Disposable SpO ₂ sensor	Adult	Finger
521P	009-005092-00	Disposable SpO ₂ sensor	Pediatric	Finger
521I	009-005093-00	Disposable SpO ₂ sensor	Infant	Toe
521N	009-005094-00	Disposable SpO ₂ sensor	Neonate	Foot
518C	040-000407-00	Reusable SpO ₂ Sensor	Neonate	Foot
/	115-004895-00	Disposable bandage, for 518C SpO ₂ sensor	Neonate	/
513A	115-034527-00	Reusable SpO ₂ sensor	Adult, Pediatric	Ear
512K	115-056388-00	Reusable SpO ₂ sensor	Pediatric	Finger, toe

27.3 Temp Accessories

27.3.1 Temp Cable

Model	Part No.	Description	Applicable patient
MR420B	040-001235-00	2-pin extension cable	All

27.3.2 Temp Probes

Model	Part No.	Description	Applicable patient
MR401B	0011-30-37392	Reusable temperature probe, esophageal	Adult
MR402B	0011-30-37394	Reusable temperature probe, esophageal	Pediatric, Infant
MR403B	0011-30-37393	Reusable temperature probe, skin	Adult
MR404B	0011-30-37395	Reusable temperature probe, skin	Pediatric, Infant
MR411	040-003294-00	Disposable temperature probe, esophageal/rectal, general	Adult, Pediatric
MR412	040-003295-00	Disposable temperature probe, skin	All

27.4 NIBP Accessories

27.4.1 NIBP Hoses

Model	Part No.	Description	Applicable patient
CM1908	040-002712-00	Reusable NIBP hose	Adult, Pediatric

27.4.2 Cuffs

Model	Part No.	Description	Limb Circumference (cm)	Bladder Width (cm)	Applicable patient
CM1200	115-002480-00	Reusable cuff	7 - 13	3.8	Small infant
CM1201	0010-30-12157	Reusable cuff	10 - 19	7.2	Infant
CM1202	0010-30-12158	Reusable cuff	18 - 26	9.8	Pediatric
CM1203	0010-30-12159	Reusable cuff	24 - 35	13.1	Adult
CM1204	0010-30-12160	Reusable cuff	33 - 47	16.5	Large adult
CM1205	0010-30-12161	Reusable cuff	46 - 66	20.5	Adult thigh
CM1300	040-000968-00	Reusable cuff, bladderless	7 - 13	3.8	Small infant
CM1301	040-000973-00	Reusable cuff, bladderless	10 - 19	7.2	Infant
CM1302	040-000978-00	Reusable cuff, bladderless	18 - 26	9.8	Pediatric
CM1303	040-000983-00	Reusable cuff, bladderless	24 - 35	13.1	Adult
CM1304	040-000988-00	Reusable cuff, bladderless	33 - 47	16.5	Large adult

Model	Part No.	Description	Limb Circumference (cm)	Bladder Width (cm)	Applicable patient
CM1305	040-000993-00	Reusable cuff, bladderless	46 - 66	20.5	Adult thigh
CM1306	115-015930-00	Reusable cuff, bladderless	24 - 35	13.1	Adult
CM1307	115-015931-00	Reusable cuff, bladderless	33 - 47	16.5	Large adult
CM1501	001B-30-70697	NIBP cuff, single patient use, 10 pcs/box	10 to 19	7.2	Infant
CM1502	001B-30-70698	NIBP cuff, single patient use, 10 pcs/box	18 to 26	9.8	Pediatric
CM1503	001B-30-70699	NIBP cuff, single patient use, 10 pcs/box	25 to 35	13.1	Adult
CM1504	001B-30-70700	NIBP cuff, single patient use, 10 pcs/box	33 to 47	16.5	Adult
CM1505	001B-30-70701	NIBP cuff, single patient use, 10 pcs/box	46 to 66	20.5	Adult thigh
CM1506	115-016969-00	NIBP cuff, single patient use, 10 pcs/box	25 to 35	13.1	Adult
CM1507	115-016970-00	NIBP cuff, single patient use, 10 pcs/box	33 to 47	16.5	Adult
CM1500A	125-000051-00	NIBP cuff, single patient use, size 1, 20 pcs/box	3.1 to 5.7	2.2	Neonate
CM1500B	125-000052-00	NIBP cuff, single patient use, size 2, 20 pcs/box	4.3 to 8.0	2.9	Neonate
CM1500C	125-000053-00	NIBP cuff, single patient use, size 3, 20 pcs/box	5.8 to 10.9	3.8	Neonate
CM1500D	125-000054-00	NIBP cuff, single patient use, size 4, 20 pcs/box	7.1 to 13.1	4.8	Neonate
CM1500E	125-000055-00	NIBP cuff, single patient use, size 5, 20 pcs/box	8 to 15	5.4	Neonate

27.5 IBP Accessories (for uMEC 70/uMEC 80/uMEC 120/uMEC 150)

Model	Part No.	Description	Applicable patient
IM2202	001C-30-70757	12-pin IBP cable, Argon	/
DT-4812	6000-10-02107	IBP transducer, disposable, Argon	Adult, Pediatric, Neonate
682275	0010-10-12156	Transducer/Manifold Mount, Argon	/

Model	Part No.	Description	Applicable patient
IM2201	001C-30-70759	12 Pin IBP cable, ICU Medical	/
42584	0010-10-42638	IBP transducer, disposable, ICU Medical	/
42602	M90-000133---	Steady Rest for IBP Transducer and Clamp, ICU Medical	/
42394	M90-000134---	Steady Rest for IBP Transducer and Clamp, ICU Medical	/
IM2211	0010-21-12179	12 Pin IBP cable, for Edwards, reusable	Adult, Pediatric, Neonate
IM2207	0010-21-43082	12 Pin IBP Cable, for Memscap, SP844 82031 transducer, reusable	Adult, Pediatric, Neonate
IM2206	115-017849-00	12 Pin IBP cable, for Utah, reusable	Adult, Pediatric, Neonate

27.6 C.O. Accessories (for uMEC 70/uMEC 80/uMEC 120/uMEC 150)

Model	Part No.	Description	Applicable patient
CO7702	0010-30-42743	12-pin C.O. cable	/
131F7	6000-10-02183	Dilution hose, Edwards	/
SP4042	6000-10-02079	Disposable TI sensor, BD	/
SP5045	6000-10-02080	Disposable TI sensor housing, BD	/
12mL	040-005992-00	12ml Control Syringe, w/1ml Stop w/ Rotator, disposable	

27.7 CO₂ Accessories (for uMEC 70/uMEC 80/uMEC 120/uMEC 150)

27.7.1 Sidestream CO₂ Accessories

Model	Part No.	Description	Applicable patient
60-15200-00	115-043017-00	Airway sampling line, disposable	Adult, Pediatric
60-15300-00	115-043018-00	Airway sampling line, disposable	Neonate
4000	115-043001-00	Nasal CO ₂ sample cannula, disposable	Adult
4100	115-043002-00	Nasal CO ₂ sample cannula, disposable	Pediatric
4200	115-043003-00	Nasal CO ₂ sample cannula, disposable	Neonate
100-000080-00	115-043024-00	Watertrap, DRYLINE II, reusable	Adult, Pediatric
100-000081-00	115-043025-00	Watertrap, DRYLINE II, reusable	Neonate
60-14100-00	115-043020-00	Airway adapter, straight, disposable	/
60-14200-00	115-043021-00	Airway adapter, elbow, disposable	/
040-001187-00	115-043019-00	Airway adapter, disposable	Neonate

27.7.2 Microstream CO₂ Accessories

Model	Part No.	Description	Usage	Applicable patient
MVA	0010-10-42566	Adt Oral-Nasal CO ₂ FilterLine	Disposable	Adult

Model	Part No.	Description	Usage	Applicable patient
MVP	0010-10-42567	Ped Oral-Nasal CO2 FilterLine	Disposable	Pediatric
MVPNOH	0010-10-42576	Ped Nasal CO2 FilterLine w/O2 H	Disposable	Pediatric
MVAOL	0010-10-42570	Adt Oral-Nasal CO2 FilterLine w/O2 L	Disposable	Adult
MVAO	0010-10-42568	Adt Oral-Nasal CO2 FilterLine w/O2	Disposable	Adult
MVANOH	0010-10-42575	Adt Nasal CO2 FilterLine w/O2 H	Disposable	Adult
MVINH	0010-10-42574	Neo-Inf Nasal CO2 FilterLine H	Disposable	Neonate
MVPO	0010-10-42569	Ped Oral-Nasal CO2 FilterLine w/O2	Disposable	Pediatric
MVPOL	0010-10-42571	Ped Oral-Nasal CO2 FilterLine w/O2 L	Disposable	Pediatric
MVIIIHL	0010-10-42565	Neonatal-Infant Intubated CO2 FilterLine	Disposable	Neonate
MVAIHL	0010-10-42564	Adult-Pediatric Intubated CO2 FilterLine	Disposable	Adult, Pediatric
MVAIL	0010-10-42563	Adult-Pediatric Intubated CO2 FilterLine	Disposable	Adult, Pediatric
MVIIIH	0010-10-42562	Neonatal-Infant Intubated CO2 FilterLine	Disposable	Neonate
MVAIH	0010-10-42561	Adult-Pediatric Intubated CO2 FilterLine	Disposable	Adult, Pediatric
MVAI	0010-10-42560	Adult-Pediatric Intubated CO2 FilterLine	Disposable	Adult, Pediatric
MVPN	0010-10-42578	Pediatric Nasal CO2 FilterLine	Disposable	Pediatric
MVAN	0010-10-42577	Adult Nasal CO2 FilterLine	Disposable	Adult
MVANH	0010-10-42572	Adult Nasal CO2 FilterLine	Disposable	Adult

27.7.3 Mainstream CO₂ Accessories

Model	Part No.	Description	Usage	Applicable patient
GA3701	125-000278-00	Mainstream CO ₂ sensor,2.6m	Reusable	All
GA3201	125-000280-00	Mainstream CO ₂ adapter,10pcs	Disposable	Adult, Pediatric
GA3202	125-000281-00	Mainstream CO ₂ adapter,10pcs	Disposable	Neonate
GA3211	040-006830-00	Mainstream CO ₂ adapter	Reusable	Adult, Pediatric
GA3212	040-006831-00	Mainstream CO ₂ adapter	Reusable	Neonate
GA3801	040-006897-00	Mainstream CO ₂ sensor cable clip,22mm,5pcs	Reusable	/
GA3802	040-006898-00	Mainstream CO ₂ sensor cable clip,10mm,5pcs	Reusable	/

27.8 Mount and Mounting Accessories

Part No.	Description
045-000931-00	iPM/iMEC wall mount bracket
045-003055-00	iPM/iMEC/uMEC series wall mount bracket
045-000924-00	iPM/iMEC rolling stand

Part No.	Description
045-003427-00	GCX M series 12"pivot arm with adapter A
045-004267-00	Rolling stand
045-003053-00	iPM/iMEC/uMEC series basic rolling stand
045-003424-00	Quick release adapter A
115-097386-00	Bedrail hook kit(10&12-inch New uMEC)
115-097387-00	Bedrail clamp kit(10&12-inch New uMEC)
115-097388-00	Bedrail hook kit(15-inch New uMEC)
115-097393-00	Bedrail clamp kit(15-inch New uMEC)

27.9 Miscellaneous Accessories

Part No.	Description
115-092866-00	Lithium battery(LI13S001G)
115-092867-00	Lithium battery(LI23S003H)
009-001075-00	Power cord, 250 V, 10 A, 3 m, Brazil
009-001791-00	Power cord, 250 V, 16 A, 3 m, South Africa
009-002636-00	Power cord, 10 A, 1.5 m, Australia standard
009-007190-00	Power cord, 3 m, India
009-007191-00	Power cord, 1.8 m, Switzerland
509B-10-05996	Power cord, 10 A, 250 V, 1.6 m, China
DA8K-10-14452	Power cord, USA
DA8K-10-14453	Power cord, UK
DA8K-10-14454	Power cord, Europe
1000-21-00122	Grounding cable
009-003116-00	Nurse call cable
009-003117-00	Analog output external cable
009-003118-00	Defibrillator synchronization cable
023-000217-00	USB drive, 4G
023-000218-00	USB drive, 32G
A30-000001---	Thermal paper
009-003648-00	Cable protecting tube
009-003903-00	Accessories management tape
0010-10-42667	Cable management straps
115-008393-00	1D Barcode reader
115-033885-00	1D Barcode reader
115-039575-00	2D Barcode reader, HS-1M, JADAK
115-039635-00	2D Barcode reader, HS-1R, JADAK
115-030320-00	Clinical Scoring Custom CD

Part No.	Description
023-001523-00	HP LaserJet Printer
115-096968-00	Recorder upgrade kit (10-inch New uMEC)
115-096986-00	Recorder upgrade kit(12&15-inch New uMEC)
115-096969-00	WIFI upgrade kit(10-inch New uMEC)
115-096987-00	WIFI upgrade kit(12&15-inch New uMEC)

A Product Specifications

A.1 Monitor Safety Specifications

The monitor is classified, according to IEC 60601-1:

Degree of protection against electrical shock	<ul style="list-style-type: none"> For uMEC 60/uMEC 100: Type CF defibrillation proof for ECG, Resp, SpO₂, NIBP, Temp For uMEC 70/uMEC 80/uMEC 120/uMEC 150: Type CF defibrillation proof for ECG, Resp, SpO₂, NIBP, Temp, IBP, C.O. Type BF defibrillation proof for CO₂
Type of protection against electrical shock	Class I
Degree of protection against harmful ingress of water	main unit: IPX1(protected against harmful effects of vertically falling water drops)
Degree of safety of application in the presence of flammable anesthetic mixture with air or with oxygen or nitrous oxide	The equipment is not suitable for use in the presence of a flammable anesthetic mixture with air or with oxygen or nitrous oxide
Mode of operation	Continuous

A.2 Physical Specifications

Item	W × H × D (mm)	Maximum Weight (kg)	Remark
uMEC 60/uMEC 100 main unit	≤300 mm×210 mm×165 mm	3.5	Standard configuration, standard battery, without accessories, recorder and other modules.
uMEC 70/uMEC 120 main unit	≤350mm×250 mm×180 mm	4	Standard configuration, standard battery, without accessories, recorder and other modules.
uMEC 80/uMEC 150 main unit	≤430 mm×300 mm×190 mm	5	Standard configuration, standard battery, without accessories, recorder and other modules.

A.3 Environmental Specifications

WARNING

- The monitor may not meet the performance specifications if stored or used outside the specified temperature and humidity ranges. If the performance of the equipment is degraded due to aging or environmental conditions, contact your service personnel.
- When the monitor and related products have differing environmental specifications, the effective range for the combined products is that range which is common to the specifications for all products.

NOTE

- The environmental specification of unspecified parameter modules are the same as those of the main unit.

Main Unit

Item	Temperature	Relative Humidity (noncondensing)	Barometric
Operating Condition	0°C to 40°C	15% to 95%	427.5 to 805.5 mmHg (57 to 107.4 kPa)
Storage Condition	-20°C to 60°C	10% to 95%	120 to 805.5 mmHg (16 to 107.4 kPa)
Microstream CO₂ Module (for uMEC 70/uMEC 80/uMEC 120/uMEC 150)			
Item	Temperature	Relative humidity (noncondensing)	Barometric
Operating Condition	0°C to 65°C	0 to 95% @40°C	430 to 805 mmHg (57.3 to 107.3 kPa)
Storage Condition	-40°C to 70°C	0 to 90% @65°C	88 to 805 mmHg (11.7 to 107.3 kPa)
Sidestream CO₂ Module (for uMEC 70/uMEC 80/uMEC 120/uMEC 150)			
Item	Temperature	Relative humidity (noncondensing)	Barometric
Operating Condition	5°C to 40°C	15% to 95%	430 to 790 mmHg (57.3 to 105.3 kPa)
Storage Condition	-20°C to 60°C	10% to 95%	430 to 790 mmHg (57.3 to 105.3 kPa)
Mainstream CO₂ Module (for uMEC 70/uMEC 80/uMEC 120/uMEC 150)			
Item	Temperature	Relative humidity (noncondensing)	Barometric
Operating Condition	0°C to 40°C	10% to 95%	400 to 805.5 mmHg (53.3 to 107.4 kPa)
Storage Condition	-20°C to 60°C	10% to 95%	400 to 805.5 mmHg (53.3 to 107.4 kPa)

A.4 Power Supply Specifications

A.4.1 External Power Supply Specifications

Monitor startup time	≤ 30 s
AC Power	
Input voltage	100 to 240 VAC
Input current	2.0 to 0.9 A
Frequency	50/60 Hz

A.4.2 Battery Specifications

Battery LI13S001G	Type	Rechargeable lithium-Ion battery
	Voltage	10.95V
	Capacity	2600 mAh

Battery LI23S003H	Type	Rechargeable lithium-Ion battery		
	Voltage	10.95V		
	Capacity	5200 mAh		
Run time	Model	uMEC 80/uMEC 150	uMEC 70/uMEC 120	uMEC 60/uMEC 100
	Battery LI13S001G	≥ 4 hours	≥ 4.5 hours	≥ 6 hours
	Battery LI23S003H	≥ 9 hours	≥ 10 hours	≥ 12 hours
	when the monitor is powered by a new fully-charged battery at 25 °C±5 °C with typical configuration (3/5-lead ECG, Resp, SpO ₂ ,Temp, auto NIBP measurements at an interval of 15 minutes, and screen brightness set to 1). Shutdown delay: at least 5 minutes after the low battery alarm first occurs.			
Charge time	Battery LI13S001G	When the monitor is off: <ul style="list-style-type: none"> • No more than 3.5 hours to 90% • No more than 4 hours to 100% When the monitor is on: <ul style="list-style-type: none"> • No more than 5.5 hours to 90% • No more than 6 hours to 100% 		
	Battery LI23S003H	When the monitor is off: <ul style="list-style-type: none"> • No more than 7 hours to 90% • No more than 8 hours to 100% When the monitor is on: <ul style="list-style-type: none"> • No more than 11 hours to 90% • No more than 12 hours to 100% 		

A.5 Display Specifications

Screen type	Color touchscreen	
Screen Size	uMEC 60/uMEC 100:	10.1 inches
	uMEC 70/uMEC 120:	12.1 inches
	uMEC 80/uMEC 150:	15.6 inches
Resolution	uMEC 60/uMEC 100:	1024 x 600 pixels
	uMEC 70/uMEC 120:	1280 x 800 pixels
	uMEC 80/uMEC 150:	1366 x 768 pixels

A.6 Recorder Specifications

Method	Thermal dot array
Horizontal resolution	16 dots/mm (25 mm/s paper speed)
Vertical resolution	8 dots/mm
Paper width	50 mm
Paper speed	25 mm/s, 50 mm/s Accuracy: ±5%
Number of waveform channels	A maximum of 3

A.7 LEDs

Alarm lamp	1 or 2 (two color-coded: red, yellow)
Power-on LED	1 (green)
AC power LED	1 (green)
Battery LED	1 (green)

A.8 Audio Indicator

Speaker	Give alarm tones (45 to 85 dB), reminder tones, key tones, QRS tones; support PITCH TONE and multi-level tone modulation; alarm tones comply with IEC 60601-1-8.
Audio signal	Alarm tone: 655Hz QRS tone: 543Hz Screen-tapping tone: 340 Hz Pulse tone: 117-676Hz (beep-beep-beep. The frequency of the pulse tone decreases as the patient's SpO2 decreases.) NIBP end tone: 650Hz Timer countdown tone: 625Hz

A.9 Monitor Interface Specifications

AC power input	1
Network connector	1, standard RJ45 connectors, 100 Base-TX, IEEE 802.3
USB connector	2, USB 2.0
Multifunctional connector	1
Video output connector	1, 15-pin D-sub
Equipotential grounding terminal	1

A.10 Signal Outputs Specifications

Auxiliary Output	
Standard	Meets the requirements of IEC 60601-1 for short-circuit protection and leakage current
ECG Analog Output	
Bandwidth (-3dB; reference frequency: 10Hz)	Diagnostic mode: 0.05 to 150 Hz Monitor mode: 0.5 to 40 Hz Surgical mode: 1 to 20 Hz ST mode: 0.05 to 40 Hz Emphasis mode: 2 to 18 Hz Customise mode: available high-pass filter frequencies are 0.01Hz, 0.05Hz, 0.15Hz, 0.25Hz, 0.32Hz, 0.5Hz, 0.67Hz; available low-pass filter frequencies are 25Hz, 35Hz, 45Hz, 75Hz, 100Hz, 150Hz.
Maximum QRS delay	25 ms (in diagnostic mode, and non-paced)
Gain (reference frequency 10Hz)	1V/mV (±5%)

Pace enhancement	Signal amplitude: $V_{oh} \geq 2.5V$ Pulse width: $10ms \pm 5\%$ Signal rising and falling time: $\leq 100\mu s$
Nurse Call Signal	
Amplitude	High level: 3.5 to 5 V, $\pm 5\%$, providing a minimum of 10 mA output current; Low level: < 0.5 V, receiving a minimum of 5 mA input current.
Rising and falling time	≤ 1 ms
Defib Sync Pulse	
Output impedance	≤ 100 ohm
Maximum time delay	35 ms (R-wave peak to leading edge of pulse)
Amplitude	High level: 3.5 to 5 V, $\pm 5\%$, providing a maximum of 10 mA output current; Low level: < 0.5 V, receiving a maximum of 5 mA input current.
Pulse width	100 ms $\pm 10\%$
maximum rising and falling time	1 ms
Alarm Output	
Alarm delay time from the monitor to remote equipment	The alarm delay time from the monitor to remote equipment is ≤ 2 seconds, measured at the monitor signal output connector.
Alarm signal sound pressure level range	45 db(A) to 85 db(A) within a range of one meter

A.11 Data Storage

Trends	<ul style="list-style-type: none"> Internal card: up to 4 hours of trend data with the resolution no less than 5 seconds, or up to 120 hours of trend data with the resolution no less than 1 minute, or up to 1200 hours of trend data with the resolution no less than 10 minutes. External card: up to 240 hours of trend data with the resolution no less than 1 minute, or up to 2400 hours' trend data with the resolution no less than 10 minutes.
Events	<ul style="list-style-type: none"> Internal card: 1000 events, including parameter alarms, arrhythmia events, technical alarms, and so on. External card: 5000 events, including parameter alarms, arrhythmia events, technical alarms, and so on. 128 arrhythmia events.
NIBP measurements	<ul style="list-style-type: none"> Internal card: 1600 sets. External card: 5000 sets.
Full-disclosure waveforms	Up to 120 hours for one waveform. The specific storage time depends on the waveforms stored and the number of stored waveforms.
ST view	A maximum of 120 hours of ST segment waveforms. One group of ST segment waveforms is stored every five minutes.
OxyCRG view	Up to 24 hours of OxyCRG events.

A.12 Wi-Fi Specifications

A.12.1 Wi-Fi Technical Specifications

Protocol	IEEE 802.11a/b/g/n/ac
Modulation mode	BPSK, QPSK, 16QAM, 64QAM, 256QAM

Operating frequency	2412 MHz to 2472 MHz 5180 MHz to 5320 MHz, 5500 MHz to 5700 MHz, 5745 MHz to 5825 MHz WARNIGN: SX-SDMAC-2832S+ module supports the DFS channels. When using the DFS channels, Wi-Fi performance stability and roaming time can be undermined due to avoiding interfering with Radar systems. DFS channels are disabled by default and not recommended. The operator should comprehensively assess the risk before using the DFS channels.
Wireless data rate	IEEE 802.11a: 6 Mbps to 54 Mbps IEEE 802.11b: 1 Mbps to 11 Mbps IEEE 802.11g: 6 Mbps to 54 Mbps IEEE 802.11n: MCS0 - MCS7 IEEE 802.11ac: MCS0 - MCS8
Output power	<20 dBm (CE requirements, detection mode: RMS) <30 dBm (FCC requirements, detection mode: peak power)
Operating mode	As station, access AP for data transmission
Data security	Standards: WPA-PSK, WPA2-PSK, WPA-Enterprise, WPA2-Enterprise EAP method: EAP-FAST, EAP-TLS, EAP-TTLS, PEAP-GTC, PEAP-MSCHAPv2, PEAP-TLS, LEAP Encryption: TKIP, AES

A.12.2 Wi-Fi Performance Specifications

WARNING

- **Do perform all network functions of data communication within an enclosed network.**
-

A.12.2.1 System Capacity and Resistance to Wireless Interference

Meets the following requirements:

- All the monitors do not encounter communication loss.
- The total delay of data transmission from the monitor to the CMS: ≤ 2 seconds.
- The delay for monitor-related settings configured at the CMS to be effective: ≤ 2 seconds.
- The total delay of data transmission from one monitor to the other: ≤ 2 seconds.
- The delay for the monitor to reset alarms of another to be effective: ≤ 2 seconds.

Testing conditions are as follows:

- Number of the monitors supported by a single AP: ≤ 16 .
- Each monitor can communicate with the CMS.
- Two monitors are used to view other monitors.
- Only one monitor can transmit history data.
- The weakest strength of the AP signal where the monitor is located is not less than -65 dBm.
- The distance between the interfering devices and the monitor is greater than 20 cm. A Wi-Fi interference (no greater than -85 dBm) in the same channel and a Wi-Fi interference (no greater than -50 dBm) in an adjacent-channel are presented synchronously. The interfering devices include, but are not limited to, 2.4 G wireless devices, cellular mobile networks, microwave ovens, interphones, cordless phones, and ESU equipment. The interfering devices do not include Wi-Fi devices.

A.12.2.2 Wi-Fi Network Stability

The ratio of the communication data loss on the CMS from any monitor does not exceed 0.1% over a 24-hour period. 12 of the 16 monitors connected to the network roam for 30 times.

Testing conditions are as follows:

- Number of the monitors supported by a single AP: ≤ 16.
- Each monitor can communicate with the CMS.
- Two monitors are used to view other monitors.
- Only one monitor can transmit history data.
- The weakest strength of the AP signal where the monitor is located cannot be less than -65 dBm.

A.12.2.3 Distinct Vision Distance

The distinct vision distance between the monitor and the AP is no less than to 50 meters.

A.13 Measurement Specifications

The adjustable range of alarm limits is the same with the measurement range of signals unless otherwise specified.

A.13.1 ECG Specifications

ECG	
Standards	Meet standards of IEC 60601-2-27 and IEC 60601-2-25
Lead set	3-lead: I, II, III 5-lead: I, II, III, aVR, aVL, aVF, V 6-lead: I, II, III, aVR, aVL, aVF, Va, Vb 12-lead: I, II, III, aVR, aVL, aVF, V1 to V6
ECG standard	AHA, IEC
Display sensitivity	1.25 mm/mV (×0.125), 2.5 mm/mV (×0.25), 5 mm/mV (×0.5), 10 mm/mV (×1), 20 mm/mV (×2), 40 mm/mV (×4), Auto, less than 5% error
Sweep speed	6.25 mm/s, 12.5 mm/s, 25 mm/s, 50 mm/s, less than 5% error
Bandwidth (-3dB)	Diagnostic mode: 0.05 to 150 Hz Monitor mode: 0.5 to 40 Hz Surgical mode: 1 to 20 Hz ST mode: 0.05 to 40 Hz Emphasis mode: 2 to 18 Hz Customise mode: available highpass frequencies are 0.01Hz, 0.05Hz, 0.15Hz, 0.25Hz, 0.32Hz, 0.5Hz, 0.67Hz; available lowpass frequencies are 25Hz, 35Hz, 45Hz, 75Hz, 100Hz, 150Hz.
Common mode rejection ratio	Diagnostic mode: >90 dB Monitor mode: >105 dB Surgical mode: >105 dB ST mode: >105 dB Emphasis mode: >105 dB Customise mode: >105 dB when the low-pass frequency < 40 Hz, >90 dB when the low-pass frequency > 40 Hz
Notch filter	50/60 Hz Monitor, surgical, ST, emphasis and customise mode: notch filter turns on automatically Diagnostic mode : notch filter is turned on/off manually
Differential input impedance	≥5 MΩ
Input signal range	±10 mV (peak-to-peak value)
Electrode offset potential tolerance	±800 mV
Input offset current	≤0.1 μA, (drive lead ≤ 1 μA)

Defibrillation protection	Enduring 5000V (360 J) charge without data loss or corruption Baseline recovery time: <5 s (after defibrillation) Polarization recovery time: <10 s Defibrillation energy absorption: ≤10% (100Ω load)
Patient leakage current	<10 uA
Calibration signal	1mV (peak-to-peak value) ±5%
ESU protection	Cut mode: 300 W Coagulate mode: 100 W Recovery time: ≤10 s In compliance with the requirements in clause 202.6.2.101 of IEC 60601-2-27
Pace Pulse	
Pace pulse markers	Pace pulses meeting the following conditions are labelled with a PACE marker: Amplitude: ±2 to ±700 mV Width: 0.1 to 2 ms Rise time: 10 to 100 µs No overshoot
Pace pulse rejection	When tested in accordance with the IEC 60601-2-27: 201.12.1.101.13, the heart rate meter rejects all pulses meeting the following conditions. Amplitude: ±2 to ±700 mV Width: 0.1 to 2 ms Rise time: 10 to 100 µs No overshoot
HR	
Measurement range	Neonate: 10 to 350 bpm Pediatric: 10 to 350 bpm Adult: 10 to 300 bpm
Resolution	1 bpm
Accuracy	±1 bpm or ±1%, whichever is greater.
Sensitivity	200 µV (lead II)
HR averaging method	In compliance with the requirements in Clause 201.7.9.2.9.101 b) 3) of IEC 60601-2-27, the following method is used: If the last 3 consecutive RR intervals are greater than 1200 ms, the 4 most recent RR intervals are averaged to compute the HR. Otherwise, heart rate is computed by subtracting the maximum and minimum ones from the most recent 12 RR intervals and then averaging them. The HR value displayed on the monitor screen is updated no more than one second.
Response to irregular rhythm	In compliance with the requirements in Clause 201.7.9.2.9.101 b) 4) of IEC 60601-2-27, the heart rate after 20 seconds of stabilization is displayed as follows: Ventricular bigeminy (waveform 3a): 80±1 bpm Slow alternating ventricular bigeminy (waveform 3b): 60±1 bpm Rapid alternating ventricular bigeminy (waveform 3c): 120±1 bpm Bidirectional systoles (waveform 3d): 90±2 bpm
Response time to heart rate change	Meets the requirements of IEC 60601-2-27: Clause 201.7.9.2.9.101 b) 5). From 80 to 120 bpm: less than 11 s From 80 to 40 bpm: less than 11 s

Time to alarm for tachycardia	Meets the requirements in Clause 201.7.9.2.9.101 b) 6) of IEC 60601-2-27.	
	Waveform	
	4ah-range:	<11 s
	4a-range:	<11 s
	4ad-range:	<11 s
	4bh-range:	<11 s
	4b-range:	<11 s
	4bd-range:	<11 s
Tall T-wave rejection capability	When the test is performed based on Clause 201.12.1.101.17 of IEC 60601-2-27, the heart rate calculation is not affected for QRS of 100 ms duration, T-wave duration of 180 ms and amplitude lower than 1.2 mV, and QT interval of 350 ms.	
Arrhythmia Analysis Classifications	Asystole, V-Fib/V-Tach, V-Tach, Vent Brady, Extreme Tachy, Extreme Brady, Vent Rhythm, PVCs/min, Pauses/min, Couplet, Bigeminy, Trigeminy, R on T, Run PVCs, PVC, Tachy, Brady, Missed Beat, Pacer Not Pacing, Pacer Not Capture, Multiform PVC, Nonsus V-Tach, Pause, Irr Rhythm, A-Fib, SVT, SVCs/min	
ST Segment Analysis		
Measurement range	-2.5 to 2.5 mV RTI	
Accuracy	-0.8 to 0.8 mV: ± 0.02 mV or $\pm 10\%$, whichever is greater. Beyond this range: Not specified.	
Resolution	0.01 mV	
QT/QTc Analysis		
Measurement range	QT: 200 to 800 ms QTc: 200 to 800 ms QT-HR: 15 to 150 bpm for adult, 15 to 180 bpm for pediatric and neonate	
Accuracy	QT: ± 30 ms	
Resolution	QT: 4 ms QTc: 1 ms	
Alarm limit	Range	Step
HR High	HR ≤ 40 bpm: (low limit + 2 bpm) to 40 bpm HR > 40 bpm: (low limit + 5 bpm) to 295 bpm	HR ≤ 40 bpm: 1 bpm HR > 40 bpm: 5 bpm
HR Low	HR ≤ 40 bpm: 16 bpm to (high limit - 2 bpm) HR > 40 bpm: 40 bpm to (high limit - 5 bpm)	
ST High	(low limit + 0.2 mV) to 2.0 mV (ST alarm mode: Absolute) 0 mV to 2.0 mV (ST alarm mode: Relative)	0.05 mV
ST Low	-2.0 mV to (high limit - 0.2 mV) (ST alarm mode: Absolute) -2.0 mV to 0 mV (ST alarm mode: Relative)	
QTc High	200 to 800 ms	10 ms
Δ QTc High	30 to 200 ms	

A.13.2 Resp Specifications

Technique	Trans-thoracic impedance
Lead	Options are lead I, II and Auto.

Respiration excitation waveform	<300 μ A RMS, 64 kHz (\pm 10%)	
Minimum respiration impedance threshold	0.3 Ω	
Baseline impedance range	200 to 2500 Ω (using an ECG cable with 1k Ω resistance)	
Bandwidth	0.2 to 2.5 Hz (-3 dB)	
Sweep speed	3mm/s, 6.25 mm/s, 12.5 mm/s, 25 mm/s or 50 mm/s, less than 5% error	
Respiration Rate		
Measurement range	<ul style="list-style-type: none"> When RR source is CO₂ or ECG: 0 to 200 rpm When RR source is SPO₂ (for adults only): 4 to 70 rpm 	
Resolution	1 rpm	
Accuracy	<ul style="list-style-type: none"> When RR source is CO₂ or ECG: 0 to 120 rpm: \pm1 rpm 121 to 200 rpm: \pm2 rpm When RR source is SPO₂(for adults only): Arms: \leq3rpm; mean deviation:[-1,1] rpm 	
Apnea alarm time	10 s, 15 s, 20 s, 25 s, 30 s, 35 s, 40 s	
Alarm limit	Range (rpm)	Step (rpm)
RR High	Adult, Pediatric: RR \leq 20 (low limit + 2) to 20 RR>20 (low limit + 5) to 100 Neonate: RR \leq 20 (low limit + 2) to 20 RR>20 (low limit + 5) to 150	RR \leq 20: 1 RR>20: 5
RR Low	RR \leq 20: 0 to (high limit - 2) RR>20: 20 to (high limit - 5)	

A.13.3 SpO₂ Specifications

Alarm limit	Range (%)	Step (%)
SpO ₂ High	(low limit + 2) to 100	1
SpO ₂ Low	(Desat+1) to (high limit - 2)	
SpO ₂ Desat Low	0 to (low limit - 1)	1

SpO₂ Module

Standards	Meet standards of ISO 80601-2-61
*Measurement accuracy verification: The SpO ₂ accuracy has been verified in human experiments by comparing with arterial blood sample reference measured with a CO-oximeter. Pulse oximeter measurement are statistically distributed and about two-thirds of the measurements are expected to come within the specified accuracy range compared to CO-oximeter measurements.	
Measurement range	0 to 100%
Resolution	1%
Response time	< 30 s (normal perfusion, no disturbance, SpO ₂ value sudden changes from 70% to 100%)

Accuracy	70 to 100%: $\pm 2\%$ ABS (adult/pediatric mode) 70 to 100%: $\pm 3\%$ ABS (neonate mode) 0% to 69%: Not specified.		
* One percent was added to the accuracies for neonatal sensors to account for accuracy variation due to properties of fetal hemoglobin. Studies were performed to validate the accuracy of Pulse Oximeter with neonatal SpO ₂ sensors by contrast with a CO-Oximeter. Some neonates aged from 1 day to 30 days with a gestation age of 22 weeks to full term were involved in this study. The statistical analysis of data of this study shows the accuracy (Arms) is within the stated accuracy specification. Please see the following table.			
Sensor type	Totally neonates	Data	Arms
518B	97 (51 male & 46 female)	200 pairs	2.38%
520N	122 (65 male & 57 female)	200 pairs	2.88%
The Pulse Oximeter with neonatal SpO ₂ sensors was also validated on adult subjects.			
Refreshing rate	≤ 2 s		
Sensitivity	High, Medium, Low		
PI			
Measurement range	0.05 to 20%		
Resolution	0.05%~9.99%: 0.01% 10.0%~20.0%: 0.1%		

A.13.4 PR Specifications

Alarm limit	Range	Step
PR High	PR \leq 40bpm: (low limit + 2 bpm) to 40 bpm PR > 40 bpm: (low limit + 5 bpm) to 295 bpm	PR \leq 40: 1 PR>40: 5
PR Low	PR \leq 40bpm: 16 bpm to (high limit - 2 bpm) PR > 40 bpm: 40 bpm to (high limit - 5 bpm)	

PR from SpO₂ Module

Measurement range	20 to 300 bpm
Resolution	1 bpm
Response time	<30 s (normal perfusion, no disturbance, PR value sudden changes from 25 to 240bpm)
Accuracy	± 3 bpm
Refreshing rate	≤ 2 s

PR from IBP Module (for uMEC 70/uMEC 80/uMEC 120/uMEC 150)

Measurement range	20 to 350 bpm
Resolution	1 bpm
Accuracy	± 1 bpm or $\pm 1\%$, whichever is greater

A.13.5 Temp Specifications

Standard	Meet the standard of ISO 80601-2-56
----------	-------------------------------------

Technique	Thermal resistance	
Operating mode	Direct mode	
Measurement range	0 to 50 °C (32 to 122 °F)	
Resolution	0.1 °C	
Accuracy	±0.1 °C or ±0.2 °F (excluding probe error)	
Refreshing rate	≤2s	
Minimum time for accurate measurement	Body surface: <100 s Body cavity: <80 s	
Alarm limit	Range	Step
TXXHigh (XX refers to temperature site)	(low limit +1.0) to 50.0 °C (low limit +2.0) to 122.0 °F	0.1 °C 0.1 °F
TXXLow (XX refers to temperature site)	0.1 to (high limit - 1.0) °C 32.2 to (high limit - 2.0) °F	
ΔT High	0.1 to 50.0 °C 0.2 to 90.0 °F	

A.13.6 NIBP Specifications

Standard	Meet standard of IEC 80601-2-30			
Technique	Oscillometry			
Mode of operation	Manual, Auto, STAT, Sequence, Clock			
Auto mode repetition intervals	1min,2min,2.5min,3min,5min,10min,15min,20min,30min,1h,1.5h,2h,3h,4h,8h			
STAT mode cycle time	5 min			
Max measurement time	Adult, Pediatric: 120 s Neonate: 90 s			
Heart rate range	30 to 300 bpm			
Measurement ranges (mmHg)		Adult	Pediatric	Neonate
	Systolic:	25 to 290	25 to 240	25 to 140
	Diastolic:	10 to 250	10 to 220	10 to 115
	Mean:	15 to 260	15 to 225	15 to 125
Accuracy	Max mean error: ±5 mmHg Max standard deviation: 8 mmHg			
Resolution	1mmHg			
Initial cuff inflation pressure range (mmHg)	Adult: 80 to 280 Pediatric: 80 to 210 Neonate: 60 to 140			
Default initial cuff inflation pressure (mmHg)	Adult: 160 Pediatric: 140 Neonate: 90			
Software overpressure protection	Adult: 297±3 mmHg Pediatric: 297±3 mmHg Neonate: 147±3 mmHg			
Hardware overpressure protection	Adult: ≤330 mmHg Pediatric: ≤330 mmHg Neonate: ≤165 mmHg			

Static pressure measurement range	0 mmHg to 300 mmHg	
Static pressure measurement accuracy	±3 mmHg	
PR		
Measurement range	30 to 300 bpm	
Resolution	1 bpm	
Accuracy	±3bpm or ±3%, whichever is greater	
Alarm limit	Range (mmHg)	Step (mmHg)
NIBP-S High	Adult: (low limit + 5) to 285 Pediatric: (low limit + 5) to 235 Neonate: (low limit + 5) to 135	NIBP ≤ 50: 1 NIBP > 50: 5
NIBP-S Low	26 to (high limit - 5)	
NIBP-M High	Adult: (low limit + 5) to 260 Pediatric: (low limit + 5) to 225 Neonate: (low limit + 5) to 125	
NIBP-M Low	16 to (high limit - 5)	
NIBP-D High	Adult: (low limit + 5) to 250 Pediatric: (low limit + 5) to 220 Neonate: (low limit + 5) to 115	
NIBP-D Low	11 to (high limit - 5)	
NIBP-S Extreme High	NIBP-S high limit < 50 Adult: (NIBP-S high limit + 1) to 290 Pediatric: (NIBP-S high limit + 1) to 240 Neonate: (NIBP-S high limit + 1) to 140 NIBP-S high limit ≥ 50 Adult: (NIBP-S high limit + 5) to 290 Pediatric: (NIBP-S high limit + 5) to 240 Neonate: (NIBP-S high limit + 5) to 140	NIBP ≤ 50: 1 NIBP > 50: 5
NIBP-S Extreme Low	NIBP-S low limit ≤ 50 25 to (NIBP-S low limit - 1) NIBP-S low limit > 50 25 to (NIBP-S low limit - 5)	
NIBP-M Extreme High	NIBP-M high limit < 50 Adult: (NIBP-M high limit + 1) to 260 Pediatric: (NIBP-M high limit + 1) to 215 Neonate: (NIBP-M high limit + 1) to 125 NIBP-M high limit ≥ 50 Adult: (NIBP-M high limit + 5) to 260 Pediatric: (NIBP-M high limit + 5) to 215 Neonate: (NIBP-M high limit + 5) to 125	
NIBP-M Extreme Low	NIBP-M low limit ≤ 50 15 to (NIBP-M low limit - 1) NIBP-M low limit > 50 15 to (NIBP-M low limit - 5)	

NIBP-D Extreme High	NIBP-D high limit < 50 Adult: (NIBP-D high limit + 1) to 250 Pediatric: (NIBP-D high limit + 1) to 200 Neonate: (NIBP-D high limit + 1) to 115 NIBP-D high limit ≥ 50 Adult: (NIBP-D high limit + 5) to 250 Pediatric: (NIBP-D high limit + 5) to 200 Neonate: (NIBP-D high limit + 5) to 115	NIBP ≤ 50: 1 NIBP > 50: 5
NIBP-D Extreme Low	NIBP-D low limit ≤ 50 10 to (NIBP-D low limit - 1) NIBP-D low limit > 50 10 to (NIBP-D low limit - 5)	

*Measurement accuracy verification: In adult and pediatric modes, the blood pressure measurements measured with this device are in compliance with the Standard for Non-invasive sphygmomanometers (ISO 81060-2) in terms of mean error and standard deviation by comparing with intra-arterial or auscultatory measurements (depending on the configuration) in a typical patient population. For auscultatory reference, the 5th Korotkoff sound was used to determine the diastolic pressure.

In neonatal mode, the blood pressure measurements measured with this device are in compliance with the American National Standard for Non-invasive sphygmomanometers (ISO 81060-2) in terms of mean error and standard deviation by comparing with intra-arterial measurements (depending on the configuration) in a typical patient population.

A.13.7 IBP Specifications (for uMEC 70/uMEC 80/uMEC 120/uMEC 150)

Standard	Meet the standard of IEC 60601-2-34	
Technique	Direct invasive measurement	
IBP		
Measurement range	-50 to 360 mmHg	
Resolution	1 mmHg	
Accuracy	±2% or ±1 mmHg, whichever is greater (excluding sensor error)	
Refreshing rate	≤2 s	
PPV		
Measurement range	0% ~ 50%	
Pressure transducer		
Excitement voltage	5 VDC, ±2%	
Sensitivity	5 μV/V/mmHg	
Zero adjustment range	±200 mmHg	
Impedance range	300 to 3000Ω	
Volume displacement	<0.04 mm ³ /100 mmHg	
Alarm limit	Range (mmHg)	Step (mmHg)

Sys High	IBP ≤ 50: (low limit + 2) to 50 IBP > 50: (low limit + 5) to 355	IBP ≤ 50: 1 IBP > 50: 5
Mean High		
Dia High		
Sys Low	IBP ≤ 50: -49 to (high limit - 2) IBP > 50: 50 to (high limit - 5)	
Mean Low		
Dia Low		
Art-S Extreme High	High limit < 50: (High limit+ 1) to 360 High limit ≥ 50: (High limit+ 5) to 360	IBP ≤ 50: 1 IBP > 50: 5
Art-M Extreme High		
Art-D Extreme High		
Art-S Extreme Low	low limit ≤ 50: -50 to (low limit- 1) low limit > 50: 50 to (low limit- 5)	
Art-M Extreme Low		
Art-D Extreme Low		

A.13.8 C.O. Specifications (for uMEC 70/uMEC 80/uMEC 120/uMEC 150)

Standard	Meet the standard of ISO 80601-2-56	
Measurement method	Thermodilution method	
Measurement range	C.O.: 0.1 to 20 L/min TB: 23 to 43 °C TI: 0 to 27 °C	
Resolution	C.O.: 0.1 L/min TB, TI: 0.1 °C	
Accuracy	C.O.: ±5% or ±0.1 L/min, whichever is greater TB, TI: ±0.1 °C (without sensor)	
TB Operating mode	Direct mode	
Minimum time for accurate TB measurement	10 s	
Repeatability	C.O.: ±2% or ±0.1 L/min, whichever is greater	
Alarm range	TB: 23 to 43 °C	
Alarm limit	Range	Step
TB High	(low limit + 1) to 43 °C (low limit + 2) to 109.4 °F	0.1 °C 0.1 °F
TB Low	23 to (high limit - 1) °C 73.4 to (high limit - 2) °F	

A.13.9 CO₂ Specifications (for uMEC 70/uMEC 80/uMEC 120/uMEC 150)

Measurement mode	Sidestream, microstream, mainstream	
Technique	Infrared absorption	
Apnea time	10 s, 15 s, 20 s, 25 s, 30 s, 35 s, 40 s	
Alarm limit	Range	Step

EtCO ₂ High	(low limit + 2) to 99 mmHg	1 mmHg
EtCO ₂ Low	1 to (high limit - 2)mmHg	
FiCO ₂ High	1 to 99 mmHg	

Sidestream CO₂ Module

Standard	Meet the standard of ISO 80601-2-55	
CO ₂ Measurement range	0 to 150 mmHg	
CO ₂ absolute accuracy*	Full accuracy mode: 0 to 40 mmHg: ± 2 mmHg 41 to 76 mmHg: ±5% of reading 77 to 150 mmHg: ±10% of reading ISO accuracy mode: add ±2mmHg to the full accuracy mode	
Inaccuracy specifications are affected by the breath rate and I:E. The EtCO ₂ accuracy is within specification for breath rate ≤ 60 rpm and I/E ratio ≤ 1:1, or breath rate ≤ 30 rpm and I/E ratio ≤ 2:1.		
CO ₂ resolution	1 mmHg	
Accuracy drift	Meet the requirement for measurement accuracy within 6 hours	
Sample flowrate tolerance	±15% or ±15 ml/min, whichever is greater.	
Start-up time	Maximum: 90 s	
Response time	Measured with a DRYLINE II neonatal watertrap and a 2.5-meter neonatal sampling line: ≤5.0 s @ 70 ml/min ≤4.5 s @ 90 ml/min Measured with a DRYLINE II adult watertrap and a 2.5-meter adult sampling line: ≤5.0 s @ 120 ml/min	
Rise time	Measured with a DRYLINE II neonatal watertrap and a 2.5-meter neonatal sampling line: ≤250 ms@70 ml/min. ≤250 ms@90 ml/min. Measured with a DRYLINE II adult watertrap and a 2.5-meter adult sampling line: ≤300 ms@120 ml/min	
awRR measurement range	0 to 150 rpm	
awRR measurement precision	≤60 rpm: ±1 61 to 150 rpm: ±2	
awRR resolution	1 rpm	
Data sample rate	50 Hz	
Effect of interference gases on CO₂ measurements		
Gas	Concentration (%)	Quantitative effect*
N ₂ O	≤60	±1 mmHg
Hal	≤4	
Sev	≤5	
Iso	≤5	
Enf	≤5	
Des	≤15	±2 mmHg

O ₂	≤100	±1 mmHg
*: means an extra error should be added in case of gas interference when CO ₂ measurements are performed between 0 to 40mmHg.		

Microstream CO₂ Module

Standard	Meet the standard of ISO 80601-2-55	
CO ₂ Measurement range	0 to 99 mmHg	
Accuracy*	0 to 38 mmHg:	±2 mmHg
	39 to 99 mmHg:	±5% of the reading (8% increased in error for every 1 mmHg if the reading is more than 38 mmHg)
Accuracy drift	Meet the requirement for measurement accuracy within 6 hours	
* Accuracy applies for respiration rate up to 80 rpm. For respiration rate above 80 rpm and EtCO ₂ exceeding 18 mmHg, the accuracy is 4 mmHg or ±12% of the reading, whichever is greater. For respiration rate above 60 rpm, the above accuracy can be achieved by using the FilterLine H Set for Infant/Neonatal (Model: 006324). In the presence of interfering gases, the above accuracy is maintained to within 4%.		
Resolution	1 mmHg	
Sample flow rate	50 ⁺¹⁵ _{-7.5} ml/min	
Initialization time	30 s (typical) 180 s (maximum)	
Response time	Measured with a 2-meter sampling line: Response time 4.3 s, rise time 190 ms. Measured with a 4-meter sampling line: Response time 5.5 s, rise time 210 ms.	
awRR measurement range	0 to 150 rpm	
awRR measurement accuracy	0 to 70 rpm:	±1 rpm
	71 to 120 rpm:	±2 rpm
	121 to 150 rpm:	±3 rpm
awRR resolution	1 rpm	
Data sample rate	40 Hz	

Mainstream CO₂ Module

Standard	Meet the standard of ISO 80601-2-55	
CO ₂ Measurement range	0 to 150 mmHg	
Accuracy	0 to 40 mmHg:	±2 mmHg
	41 to 70 mmHg:	±5% of the reading
	71 to 100 mmHg:	±8% of the reading
	101 to 150 mmHg:	±10% of the reading
Accuracy drift	Meet the requirement for measurement accuracy within 6 hours	
Resolution	1 mmHg	
Rise time	<60 ms	
Response time	<2 s	
Data sample rate	100 Hz	
awRR measurement range	0 to 150 rpm	
awRR measurement accuracy	±1 rpm	

A.14 Software Operating Environment

Software operating environment: Linux, OpenSSL.

B EMC and Radio Regulatory Compliance

B.1 EMC

The system complies with the EMC standard IEC60601-1-2:2020.

WARNING

- **The use of unapproved accessories may diminish system performance.**
- **Use of components, accessories, probes, and cables other than those specified may result in increased emission or decreased immunity of system.**
- **The system needs special precautions regarding EMC and needs to be installed and put into service according to the EMC information provided below.**
- **Use of this equipment adjacent to or stacked with other equipment should be avoided because it could result in improper operation. If such use is necessary, this equipment and the other equipment should be observed to verify that they are operating normally.**
- **Use of accessories, transducers and cables other than those specified or provided by the manufacturer of this equipment could result in increased electromagnetic emissions or decreased electromagnetic immunity of this equipment and result in improper operation.**
- **Portable RF communications equipment (including peripherals such as antenna cables and external antennas) should be used no closer than 30 cm (12 inches) to any part of the system, including cables specified by the manufacturer. Otherwise, degradation of the performance of this equipment could result.**
- **Other devices may interfere with this equipment even though they meet the requirements of CISPR.**
- **When the input signal is below the minimum amplitude provided in technical specifications, erroneous measurements could result.**
- **Use of portable or mobile communications devices can degrade the performance of the equipment.**
- **This device is intended for use in professional healthcare facility environment. If it is used in special environment, such as magnetic resonance imaging environment, the equipment/system may be disrupted by the operation of nearby equipment.**

If the system is operated within the electromagnetic environment listed in TABLE EMC-2, EMC-3 and TABLE EMC-4, the system will remain safe and will provide the following basic performances:

- Operating mode
- Accuracy
- Function
- Accessories identification
- Data stored
- Alarm
- Detect for connection

TABLE EMC-1

GUIDANCE AND MINDRAY DECLARATION—ELECTROMAGNETIC EMISSIONS		
The system is intended for use in the electromagnetic environment specified below. The customer or the user of system should assure that it is used in such an environment.		
EMISSIONS TEST	COMPLIANCE	ELECTROMAGNETIC ENVIROMENT – GUIDANCE
RF Emissions CISPR 11	Group 1	The system uses RF energy only for its internal function. Therefore, its RF emissions are very low and are not likely to cause any interference in nearby electronic equipment.

GUIDANCE AND MINDRAY DECLARATION—ELECTROMAGNETIC EMISSIONS		
RF Emissions CISPR 11	Class A	The system is suitable for use in all establishments other than domestic and those directly connected to the public low-voltage power supply network that supplies buildings used for domestic purposes.
Harmonic Emissions IEC 61000-3-2	Not applicable	
Voltage Fluctuations/ Flicker Emissions IEC 61000-3-3	Not applicable	

TABLE EMC-2

GUIDANCE AND MINDRAY DECLARATION—ELECTROMAGNETIC IMMUNITY			
The system is intended for use in the electromagnetic environment specified below. The customer or the user of system should assure that it is used in such an environment.			
IMMUNITY TEST	IEC 60601 TEST LEVEL	COMPLIANCE LEVEL	ELECTROMAGNETIC ENVIROMENT – GUIDANCE
Electrostatic Discharge (ESD) IEC 61000-4-2	±8 kV contact; ±2 kV, ±4 kV, ±8 kV, ±15 kV air	±8 kV contact; ±2 kV, ±4 kV, ±8 kV, ±15 kV air	Floors should be wood, concrete or ceramic tile. If floors are covered with synthetic material, the relative humidity should be at least 30%.
Electrical fast Transient / burst IEC 61000-4-4	±2 kV for power supply lines; ±1 kV for input/ output lines	±2 kV for power supply lines; ±1 kV for input/ output lines	Mains power quality should be that of a typical commercial or hospital environment.
Surge IEC 61000-4-5	±0,5 kV, ±1 kV line(s) to line(s); ±0,5 kV, ±1 kV, ±2 kV line(s) to earth	±0,5 kV, ±1 kV line(s) to line(s); ±0,5 kV, ±1 kV, ±2 kV line(s) to earth	Mains power quality should be that of a typical commercial or hospital environment.
Voltage dips, Short interruptions and voltage variation on power supply input voltage IEC 61000-4-11	0 % U_T ; 0,5 cycle At 0°, 45°, 90°, 135°, 180°, 225°, 270° and 315° 0 % U_T ; 1 cycle 70% U_T for 25/30 cycle at 0° 0 % U_T ; 250/300 cycle	0 % U_T ; 0,5 cycle At 0°, 45°, 90°, 135°, 180°, 225°, 270° and 315° 0 % U_T ; 1 cycle 70% U_T for 25/30 cycle at 0° 0 % U_T ; 250/300 cycle	Mains power quality should be that of a typical commercial or hospital environment. If you require continued operation during power mains interruptions, it is recommended that our product be powered from an uninterruptible power supply or a battery.
Power frequency (50/60 HZ) magnetic field IEC 61000-4-8	30 A/m	30 A/m	Power frequency magnetic fields should be at levels characteristic of a typical location in a typical commercial or hospital environment.
NOTE: U_T is the A.C. mains voltage prior to application of the test level.			

TABLE EMC-3

GUIDANCE AND MINDRAY DECLARATION—ELECTROMAGNETIC IMMUNITY			
The system is intended for use in the electromagnetic environment specified below. The customer or the user of system should assure that it is used in such an environment.			
IMMUNITY TEST	IEC 60601 TEST LEVEL	COMPLIANCE LEVEL	ELECTROMAGNETIC ENVIROMENT – GUIDANCE

GUIDANCE AND MINDRAY DECLARATION—ELECTROMAGNETIC IMMUNITY			
Conducted RF IEC 61000-4-6	3 Vrms 0,15 MHz – 80 MHz 6 Vrms in ISM bands ^a between 0,15 MHz and 80 MHz	3 Vrms 0,15 MHz – 80 MHz 6 Vrms in ISM bands ^a between 0,15 MHz and 80 MHz	Portable and mobile RF communications equipment should be used no closer to any part of system, including cables, than the recommended separation distance calculated from the equation applicable to the frequency of the transmitter. Recommended separation distance: $d = 1.2 \times \sqrt{P}$ 0,15 MHz to 80 MHz $d = 2 \times \sqrt{P}$ 0,15 MHz to 80 MHz $d = 1.2 \times \sqrt{P}$ 80 MHz to 800 MHz $d = 2.3 \times \sqrt{P}$ 800 MHz to 2.7GHz Where, P is the maximum output power rating of the transmitter in watts (W) according to the transmitter manufacturer and d is the recommended separation distance in meters (m).
Radiated RF IEC 61000-4-3	3 V/m 80MHz - 2.7GHz	3 V/m 80MHz - 2.7GHz	Field strengths from fixed RF transmitters, as determined by an electromagnetic site survey ^b , should be less than the compliance level in each frequency range ^c . Interference may occur in the vicinity of equipment marked with the following symbol: 
<p>Note 1: At 80 MHz and 800 MHz, the higher frequency range applies.</p> <p>Note 2: These guidelines may not apply in all situations. Electromagnetic propagation is affected by absorption and reflection from structures, objects and people.</p> <p>^aThe ISM (industrial, scientific, and medical) bands between 150 kHz and 80 MHz are 6,765 MHz to 6,795 MHz; 13,553 MHz to 13,567 MHz; 26,957 MHz to 27,283 MHz; and 40,66 MHz to 40,70 MHz. The amateur radio bands between 0,15 MHz and 80 MHz are 1,8 MHz to 2,0 MHz, 3,5 MHz to 4,0 MHz, 5,3 MHz to 5,4 MHz, 7 MHz to 7,3 MHz, 10,1 MHz to 10,15 MHz, 14 MHz to 14,2 MHz, 18,07 MHz to 18,17 MHz, 21,0 MHz to 21,4 MHz, 24,89 MHz to 24,99 MHz, 28,0 MHz to 29,7 MHz and 50,0 MHz to 54,0 MHz.</p> <p>^b Field strengths from fixed transmitters, such as base stations for radio (cellular/cordless) telephones and land mobile radios, amateur radio, AM and FM radio broadcast and TV broadcast cannot be predicted theoretically with accuracy. To assess the electromagnetic environment due to fixed RF transmitters, an electromagnetic site survey should be considered. If the measured field strength in the location in which the device is used exceeds the applicable RF compliance level above, the device should be observed to verify normal operation. If abnormal performance is observed, additional measures may be necessary, such as re-orienting or relocating the device.</p> <p>^c Over the frequency ranges 150 kHz to 80 MHz, field strengths should be less than 3V/m.</p>			

TABLE EMC-4

GUIDANCE AND MINDRAY DECLARATION—ELECTROMAGNETIC IMMUNITY			
The system is intended for use in the electromagnetic environment specified below. The customer or the user of system should assure that it is used in such an environment.			
IMMUNITY TEST	IEC 60601 TEST LEVEL	COMPLIANCE LEVEL	ELECTROMAGNETIC ENVIROMENT – GUIDANCE
Proximity magnetic fields IEC 61000-4-39	65 A/m 134,4 kHz Pulse modulation 2,1 kHz	65 A/m 134,4 kHz Pulse modulation 2,1 kHz	/
	7,5 A/m 13,56 MHz Pulse modulation 50 kHz	7,5 A/m 13,56 MHz Pulse modulation 50 kHz	

TABLE EMC-5 Test specifications and minimum distances

Recommended separation distances between portable and mobile RF communications equipment and Patient Monitor						
<p>The system is intended for use in an electromagnetic environment in which radiated RF disturbances are controlled. The customer or the user of Patient Monitor can help prevent electromagnetic interference by maintaining a minimum distance between portable and mobile RF communications equipment (transmitters) and the Patient Monitor as recommended below, according to the maximum output power of the communications equipment. Portable and mobile radio communications equipment (e.g. two-way radio, cellular/ cordless telephones and similar equipment) should be used no closer to any part of this system, including cables, than determined according to the following method:</p>						
Test frequency (MHz)	Band (MHz)	Service	Modulation	Maximum power (W)	Distance (m)	Immunity test level (V/m)
385	380 - 390	TETRA 400	Pulse modulation 18Hz	1.8	0.3	27
450	430 -470	GMRS 460 FRS 460	FM ±5 kHz deviation 1 kHz sine	2	0.3	28
710	704 - 787	LTE Band 13,17	Pulse modulation 217 Hz	0.2	0.3	9
745						
780						
810	800 - 960	GSM 800/ 900, tetra 800, iDEN 820, CDMA 850, LTE Band 5	Pulse modulation 18 Hz	2	0.3	28
870						
930						
1720	1700 -1990	GSM 1800, CDMA 1900, GSM 1900, DECT, LTE Band 1, 3,4,25,UMTS	Pulse modulation 217 Hz	2	0.3	28
1845						
1970						
2450	2400 -2570	Bluetooth, WLAN, 802.11 b/g/n, RFID 2450, LTE Band 7	Pulse modulation 217 Hz	2	0.3	28
5240	5100 -5800	WLAN, 802.11 a/n	Pulse modulation 217 Hz	0.2	0.3	9
5500						
5785						

TABLE EMC-6

RECOMMENDED SEPARATION DISTANCES BETWEEN PORTABLE AND MOBILE RF COMMUNICATION DEVICE AND THE SYSTEM				
The system is intended for use in an electromagnetic environment in which radiated RF disturbance are controlled. The customer or the user of system can help prevent electromagnetic interference by maintaining a minimum distance between portable and mobile RF communication equipment (transmitters) and system as recommended below, according to the maximum output power of the communication equipment.				
Rated Maximum Output power of Transmitter (W)	Separation Distance According to Frequency of Transmitter			
	150kHz -80MHz Out ISM bands $d=1.2 \sqrt{P}$	150kHz -80MHz in ISM bands $d=2 \sqrt{P}$	80MHz-800MHz $d=1.2 \sqrt{P}$	800MHz-2.7GHz $d=2.3 \sqrt{P}$
0.01	0.12	0.2	0.12	0.23
0.1	0.38	0.64	0.38	0.73
1	1.2	2	1.2	2.3
10	3.8	6.4	3.8	7.3
100	12	20	12	23
For transmitters at a maximum output power not listed above, the recommended separation distanced in meters (m) can be determined using the equation applicable to the frequency of the transmitter, where P is the maximum output power rating of the transmitter in watts (W) according to the transmitter manufacturer.				
Note 1: At 80 MHz and 800 MHz, the higher frequency range applies.				
Note 2: These guidelines may not apply in all situations. Electromagnetic propagation is affected by absorption and reflection from structures, objects and people.				

B.2 Radio Regulatory Compliance



The radio device used in this product is in compliance with the essential requirements and other relevant provisions of Directive 2014/53/EU.

This device complies with part 15 of the FCC Rules and with RSS-210 of Industry Canada. Operation is subject to the condition that this device does not cause harmful interference.

This device must accept any interference received, including interference that may cause undesired operation.

WARNING

- **Keep a distance of at least 20cm away from the monitor when Wi-Fi function is in use.**
-

This page intentionally left blank.

C Default Settings

C.1 Parameters Default Settings

C.1.1 ECG, Arrhythmia, ST and QT Default Settings

C.1.1.1 ECG Default Settings

Item		Default Setting
HR/PR	Alarm switch (On/Off)	On
	High limit	Adult: 120 bpm Pediatric: 160 bpm Neonate: 200 bpm
	Low limit	Adult: 50 bpm Pediatric: 75 bpm Neonate: 100 bpm
	Priority	Med
	Alarm Outputs	Off
	Alarm Source	Auto
Extreme Tachy	Alarm switch (On/Off)	On
	High limit	Adult: 160 bpm Pediatric: 180 bpm Neonate: 220 bpm
	Priority	High
	Alarm Outputs	Off
Extreme Brady	Alarm switch (On/Off)	On
	Low limit	Adult: 35 bpm Pediatric: 50 bpm Neonate: 60 bpm
	Priority	High
	Alarm Outputs	Off
Alarm Source		Auto
ECG1		II
ECG2 (5-lead, 6-lead, 12-lead)		V, Va, V1
Va (for 6-lead only)		Va
Vb (for 6-lead only)		Vb
ECG Gain		×1
Speed		25 mm/sec
Filter		Monitor
Notch Filter		On
Lead Set		Auto

Item	Default Setting
D12L (for 6-lead only)	Off
Smart Lead	On
Baseline Drift Removal	On
Waveform Layout	Standard
CrozFusion	On
Display CrozFusion	Off
QRS Volume	2
QRS Threshold	0.16 mV
Paced	Adult: Unspecified Pediatric/Neonate: No
Pacer Reject	Off

C.1.1.2 Arrhythmia Default Settings

Arrhythmia Alarm Default Settings

Item	Alarm Switch	Priority	Alarm Outputs
Asystole	On	High, unadjustable	Off
V-Fib/V-Tach	On	High, unadjustable	Off
V-Tach	On	High, unadjustable	Off
Vent Brady	On	High, unadjustable	Off
Extreme Tachy	On	High, unadjustable	Off
Extreme Brady	On	High, unadjustable	Off
R on T	Off	Med	Off
Run PVCs	Off	Low	Off
Couplet	Off	Prompt	Off
Multiform PVC	Off	Med	Off
PVC	Off	Prompt	Off
Bigeminy	Off	Med	Off
Trigeminy	Off	Med	Off
Tachy	Off	Med	Off
Brady	Off	Med	Off
Pacer Not Capture	Off	Prompt	Off
Pacer Not Pacing	Off	Prompt	Off
Missed Beat	Off	Prompt	Off
Nonsus V-Tach	Off	Med	Off
Vent Rhythm	Off	Med	Off
Pause	Off	Low	Off
Irr Rhythm	Off	Prompt	Off
A-Fib	Off	Prompt	Off
PVCs/min	Off	Med	Off

Item	Alarm Switch	Priority	Alarm Outputs
Pauses/min	Off	Med	Off
SVT	Off	Med	Off
SVCs/min	Off	Med	Off

Arrhythmia Threshold Default Settings

Item	Adult	Pediatric	Neonate
Asystole Delay	5 sec	5 sec	5 sec
Tachy	120 bpm	160 bpm	200 bpm
Brady	50 bpm	75 bpm	100 bpm
Extreme Tachy	160 bpm	180 bpm	220 bpm
Extreme Brady	35 bpm	50 bpm	60 bpm
Multif PVCs Window	15 beats	15 beats	15 beats
PVCs/min	10	10	10
Pauses/min	8	8	8
Pause Threshold	2.0 sec	2.0 sec	2.0 sec
AF/Irr Rhy End Time	2 min	2 min	2 min
V-Tach Rate	130 bpm	130 bpm	160 bpm
V-Brady Rate	40 bpm	40 bpm	40 bpm
V-Tach PVCs	6	6	6
V-Brady PVCs	5	5	5
SVT SVCs	5	5	5
SVT HR	180 bpm	200 bpm	210 bpm
SVCs/min	10	10	10
Refractory Period 1	3 min	3 min	3 min
Refractory Period 2	10 min	10 min	10 min

C.1.1.3 ST Default Settings

Item	Default Setting	
ST Alarm Mode	Absolute	
ST-I, ST-II, ST-III, ST-aVR, ST-aVL, ST-aVF, ST-V1, ST-V2, ST-V3, ST-V4, ST-V5, ST-V6, ST-Va, ST-Vb (ST Alarm Mode set to Absolute)	Alarm switch (On/Off)	Off
	High limit	0.2 mV
	Low limit	-0.2 mV
	Priority	Med
	Alarm Outputs	Off

Item		Default Setting
ST Single, ST Dual (ST Alarm Mode set to Relative)	Alarm switch (On/Off)	Off
	High limit	0.1 mV
	Low limit	-0.1 mV
	Priority	Med
	Alarm Outputs	Off
ST Analysis		Off
ST Segment		Auto
Show Markers		Off
ST Point		J+60 ms
Auto Adjust		On
J		48
ISO		-80

C.1.1.4 QT Default Settings

Item		Default Setting
QTc	Alarm switch (On/Off)	Off
	High limit	Adult: 500 Pediatric: 480 Neonate: 460
	Priority	Med
	Alarm Outputs	Off
ΔQTc	Alarm switch (On/Off)	Off
	High limit	60
	Priority	Med
	Alarm Outputs	Off
QT Analysis		Off
QT Leads		All

C.1.2 Respiration Default Settings

Item		Default Setting
RR	Alarm switch (On/Off)	On
	High limit	Adult: 30 Pediatric: 30 Neonate: 100
	Low limit	Adult: 8 Pediatric: 8 Neonate: 30
	Priority	Med
	Alarm Outputs	Off

Item		Default Setting
Apnea	Alarm switch (On/Off)	On
	Priority	High, unadjustable
	Alarm Outputs	Off
Apnea Delay		Adult: 20 sec Pediatric: 20 sec Neonate: 15 sec
RR Source		Auto
Resp Lead		Adult: Auto Pediatric: Auto Neonate: II
Gain		×2
Speed		6.25 mm/s
Auto Threshold Detection		On

C.1.3 SpO₂ Default Settings

Item		Default Setting
SpO2	Alarm switch (On/Off)	On
	High limit	Adult: 100% Pediatric: 100% Neonate: 95%
	Low limit	90%
	Priority	Med
	Alarm Outputs	Off
SpO2 Desat	Alarm switch (On/Off)	On
	Low limit	80%
	Priority	High
	Alarm Outputs	Off
NIBP Simul		Off
Sensitivity		Med
Display PI		Off
Speed		25 mm/s

Item		Default Setting
PR	Alarm switch (On/Off)	On
	High limit	Adult: 120 Pediatric: 160 Neonate: 200
	Low limit	Adult: 50 Pediatric: 75 Neonate: 100
	Priority	Med
	Alarm Outputs	Off
	Alarm Source	Auto
	PR Source	Auto
	QRS Volume	2
	Display PR	Off

C.1.4 Temperature Default Settings

Item		Default Setting
TXX (XX refers to temperature site)	Alarm switch (On/Off)	On
	High limit	38.0 °C
	Low limit	35.0 °C
	Priority	Med
	Alarm Outputs	Off
ΔT	Alarm switch (On/Off)	On
	High limit	2.0 °C
	Priority	Med
	Alarm Outputs	Off

C.1.5 NIBP Default Settings

Item		Default Setting
NIBP-S	Alarm switch (On/Off)	On
	High limit	Adult: 160 mmHg Pediatric: 120 mmHg Neonate: 90 mmHg
	Low limit	Adult: 90 mmHg Pediatric: 70 mmHg Neonate: 40 mmHg
	Priority	Med
	Alarm Outputs	Off

Item		Default Setting
NIBP-D	Alarm switch (On/Off)	On
	High limit	Adult: 90 mmHg Pediatric: 70 mmHg Neonate: 60 mmHg
	Low limit	Adult: 50 mmHg Pediatric: 40 mmHg Neonate: 20 mmHg
	Priority	Med
	Alarm Outputs	Off
NIBP-M	Alarm switch (On/Off)	On
	High limit	Adult: 110 mmHg Pediatric: 90 mmHg Neonate: 70 mmHg
	Low limit	Adult: 60 mmHg Pediatric: 50 mmHg Neonate: 25 mmHg
	Priority	Med
	Alarm Outputs	Off
NIBP-S Extreme	Alarm switch (On/Off)	On
	High limit	Adult: 175 mmHg Pediatric: 130 mmHg Neonate: 95 mmHg
	Low limit	Adult: 75 mmHg Pediatric: 60 mmHg Neonate: 35 mmHg
	Priority	High
	Alarm Outputs	Off
NIBP-D Extreme	Alarm switch (On/Off)	On
	High limit	Adult: 105 mmHg Pediatric: 80 mmHg Neonate: 65 mmHg
	Low limit	Adult: 35 mmHg Pediatric: 30 mmHg Neonate: 15 mmHg
	Priority	High
	Alarm Outputs	Off
NIBP-M Extreme	Alarm switch (On/Off)	On
	High limit	Adult: 125 mmHg Pediatric: 100 mmHg Neonate: 75 mmHg
	Low limit	Adult: 45 mmHg Pediatric: 40 mmHg Neonate: 20 mmHg
	Priority	High
	Alarm Outputs	Off

Item	Default Setting
Initial Pressure	Adult: 160 mmHg Pediatric: 140 mmHg Neonate: 90 mmHg
Interval	15 min
Start Mode	Clock
NIBP End Tone	Off
Venipuncture Pressure	Auto
Display Format	Sys/Dia(Mean)
Display Alarm Limits	Off
Display PR	Off

C.1.6 IBP Default Settings (for uMEC 70/uMEC 80/uMEC 120/uMEC 150)

Item	Default Setting	
IBP-S	Alarm switch (On/Off)	On
	High limit	<ul style="list-style-type: none"> ■ Art/Ao/UAP/BAP/FAP/LV/P1/P2 arterial pressure Adult: 160 mmHg Pediatric: 120 mmHg Neonate: 90 mmHg ■ PA Adult: 35 mmHg Pediatric, Neonate: 60 mmHg
	Low limit	<ul style="list-style-type: none"> ■ Art/Ao/UAP/BAP/FAP/LV/P1/P2 arterial pressure Adult: 90 mmHg Pediatric: 70 mmHg Neonate: 55 mmHg ■ PA Adult: 10 mmHg Pediatric, Neonate: 24 mmHg
	Priority	Med
	Alarm Outputs	Off

Item		Default Setting
IBP-D	Alarm switch (On/Off)	On
	High limit	<ul style="list-style-type: none"> ■ Art/Ao/UAP/BAP/FAP/LV/P1/P2 arterial pressure Adult: 90 mmHg Pediatric: 70 mmHg Neonate: 60 mmHg ■ PA Adult: 16 mmHg Pediatric, Neonate: 4 mmHg
	Low limit	<ul style="list-style-type: none"> ■ Art/Ao/UAP/BAP/FAP/LV/P1/P2 arterial pressure Adult: 50 mmHg Pediatric: 40 mmHg Neonate: 20 mmHg ■ PA Adult: 0 mmHg Pediatric, Neonate: -4 mmHg
	Priority	Med
	Alarm Outputs	Off
IBP-M	Alarm switch (On/Off)	On
	High limit	<ul style="list-style-type: none"> ■ Art/Ao/UAP/BAP/FAP/LV/P1/P2 arterial pressure Adult: 110 mmHg Pediatric: 90 mmHg Neonate: 70 mmHg ■ PA Adult: 20 mmHg Pediatric, Neonate: 26 mmHg ■ ICP/RAP/LAP/UVP/P3/P4 venous pressure Adult: 10 mmHg Pediatric, Neonate: 4 mmHg ■ CVP Adult: 14 cmH₂O Pediatric, Neonate: 5 cmH₂O
	Low limit	<ul style="list-style-type: none"> ■ Art/Ao/UAP/BAP/FAP/LV/P1/P2 arterial pressure Adult: 70 mmHg Pediatric: 50 mmHg Neonate: 35 mmHg ■ PA Adult: 0 mmHg Pediatric, Neonate: 12 mmHg ■ ICP/RAP/LAP/UVP/P3/P4 venous pressure Adult: 0 mmHg Pediatric, Neonate: 0 mmHg ■ CVP Adult: 0 cmH₂O Pediatric, Neonate: 0 cmH₂O
	Priority	Med
	Alarm Outputs	Off

Item		Default Setting
Art-S Extreme	Alarm switch (On/Off)	Off
	High limit	Adult: 175 mmHg Pediatric: 130 mmHg Neonate: 95 mmHg
	Low limit	Adult: 75 mmHg Pediatric: 60 mmHg Neonate: 50 mmHg
	Priority	High
	Alarm Outputs	Off
Art-D Extreme	Alarm switch (On/Off)	Off
	High limit	Adult: 105 mmHg Pediatric: 80 mmHg Neonate: 65 mmHg
	Low limit	Adult: 35mmHg Pediatric: 30 mmHg Neonate: 15 mmHg
	Priority	High
	Alarm Outputs	Off
Art-M Extreme	Alarm switch (On/Off)	Off
	High limit	Adult: 125 mmHg Pediatric: 100 mmHg Neonate: 75 mmHg
	Low limit	Adult: 55 mmHg Pediatric: 40 mmHg Neonate: 30 mmHg
	Priority	High
	Alarm Outputs	Off
CPP	Alarm switch (On/Off)	On
	High limit	Adult: 130 mmHg Pediatric: 100 mmHg Neonate: 90 mmHg
	Low limit	Adult: 50 mmHg Pediatric: 40 mmHg Neonate: 30 mmHg
	Priority	Med
	Alarm Outputs	Off
Measure (for P1, P2)		All
Measure (for P3, P4)		Mean Only
Sensitivity		Med
Speed		25 mm/sec

Item		Default Setting
Scale	ICP/RAP/LAP/UV venous pressure	0-20 mmHg
	Art/Ao/BAP/FAP/LV/P1/ P2 arterial pressure	0-160 mmHg
	UAP/P3/P4 venous pressure	0-80 mmHg
	PA/CVP	PA: 0-30 mmHg CVP: 0-30 cmH ₂ O
PPV Measure		Off
PPV Source		Auto
PAWP	Reference Waveform 1	II
	Reference Waveform 2	Resp
	Speed	12.5 mm/sec
	PA Scale (mmHg)	0-30
Overlapping Waveform Setup	Left Scale (mmHg)	0-160
	Right Scale (mmHg)	0-20
	CVP Scale (cmH ₂ O)	0-30
	ICP Scale (mmHg)	0-20
	PA Scale (mmHg)	0-30
	Speed	25 mm/sec
	Gridlines	Off
Display Format		Sys/Dia(Mean)
Display Alarm Limits		Off
Use PA-D as PAWP		Off

C.1.7 C.O. Default Settings (for uMEC 70/uMEC 80/uMEC 120/uMEC 150)

Item		Default Setting
TB	Alarm switch (On/Off)	On
	High limit	39.0 °C
	Low limit	36.0 °C
	Priority	Med
	Alarm Outputs	Off
Comp Const		0.542
Auto Start		On
Auto TI		On

C.1.8 CO₂ Default Settings (for uMEC 70/uMEC 80/uMEC 120/uMEC 150)

C.1.8.1 General Settings

Item		Default Setting
EtCO ₂	Alarm switch (On/Off)	On
	High limit	Adult, Pediatric: 50 mmHg Neonate: 45 mmHg
	Low limit	Adult, Pediatric: 25mmHg Neonate: 30mmHg
	Priority	Med
	Alarm Outputs	Off
FiCO ₂	Alarm switch (On/Off)	On
	High limit	4 mmHg
	Priority	Med
	Alarm Outputs	Off
Apnea Delay		Adult, Pediatric: 20 s Neonate: 15 s
RR Source		Auto
Speed		6.25 mm/s
Scale		50 mmHg
Waveform Type		Draw

C.1.8.2 Sidestream CO₂ Default Settings

Item	Default Setting
BTPS Compensation	Off
O ₂ Compensation	21%
AG Compensation	0%
N ₂ O Compensation	0%
Auto Standby	60 min
Operating Mode	Measure

C.1.8.3 Microstream CO₂ Default Settings

Item	Default Setting
BTPS Compensation	Off
Maximum Hold	20 sec
Auto Standby	Off
Operating Mode	Measure

C.1.8.4 Mainstream CO₂ Default Settings

Item	Default Setting
Maximum Hold	10 sec
O2 Compensation	Off
Balance Gas	Room Air
AG Type	Sev
AG Compensation	0%
Operating Mode	Measure

C.2 Routine Default Settings

C.2.1 Alarm Default Settings

Item	Default Setting
Alarm Volume	2
High Alarm Volume	Alarm Volume+2
Reminder Volume	2
Apnea Delay	Adult: 20 sec Pediatric: 20 sec Neonate: 15 sec
Printing Duration On Alarm	20 sec
Auto Limits for New Patient	On

C.2.2 Review Default Settings

Item	Default Setting	
Tabular Trends	Trend Group	Standard
	Interval	30 min
Graphic Trends	Trend Group	Standard
	Zoom	8 hrs
	Trends	5
Events	Filter	All
	Beat Anno:	Off
	Speed	25 mm/s
	Gain	×1
Full Disclosure	Display(Maximum: 3)	II
	Storage	II
	Duration	1 min
	Scale	×1
	Beat Anno:	Off
	Speed	25 mm/sec
	Gain	×1

Item		Default Setting
12-Lead ECG	Speed	25 mm/sec
	Gain	×1
	Layout	3×4+1

C.2.3 Minitrends Default Settings

Item	Default Setting
Alarm Statistics	On
Alarm Statistics Duration	8 hrs
Minitrend Length	2 hrs
Routine Vital	Manual
Time (for Routine Vital set to Auto)	08:00
Interval (for Routine Vital set to Auto)	8 hrs

C.2.4 OxyCRG Default Settings

Item		Default Setting
Parameters Setup	Trend1	btbHR
	Trend2	SpO2
	Compressed	Resp
Event	Threshold (HR)	100
	Duration (HR)	0
	Threshold (SpO2)	80
	Duration (SpO2)	0
	Apnea	20 sec
	Event Storage Format	2 min+2 min

C.2.5 Remote View Default Settings

Item	Default Setting
Rollup Alarm Beds	Off
Rollup Interval	Off
Alarm Priority	High Only
Switch Bed Prompt Voice	Off

C.2.6 Display Default Settings

Item		Default Setting
Primary Screen	Choose Screen	Normal Screen

Item		Default Setting
Display	Screen Lock Duration	Permanent
	Brightness	5
	Brightness On Battery	1
Night Mode	Brightness	Auto
	All Mute	Off
	Alarm Volume	2
	QRS Volume	0
	Key Volume	0
	Reminder Volume	1
	NIBP End Tone	Off
	Stop NIBP	Off
	Auto Night Mode	Off
	Night Time Period	22:00 - 6:00

C.2.7 Report Default Settings

C.2.7.1 Report Setup

Item		Default Setting
ECG Report	Amplitude	10 mm/mV
	Speed	25 mm/sec
	Auto Interval	Off
	12-Lead Format	3×4+1
	Rhythm Lead 1	II
	Rhythm Lead 2	V2
	Rhythm Lead 3	V5
	Format Sequence	Sequential
Realtime Report	Speed	Auto
	Select Waveform	Current Waveforms
Tabular Trends Report	Period	Auto
	Interval	Auto
	Report Format	Landscape
	Trend Group	Standard
Graphic Trends	Period	Auto
	Trend Group	Standard

C.2.7.2 Record Setup

Item	Default Setting
Waveform 1	I

Item	Default Setting
Waveform 2	II
Waveform 3	Off
IBP Overlap	Off
Recording Duration	8 sec
Interval	Off
Recorder Paper Speed	25 mm/sec

C.2.8 Calculations Default Settings

Item		Default Setting	
Drug	Calculator	Weight Based	Off
		Drug Amount	mcg
		Solution Volume	ml
		Dose	mcg/min
		Concentration	mcg/ml
		Infusion Time	hr
		Infusion Rate	ml/hr
	Titration Table	Dose Type	Dose/hr
Interval		1	
Oxygenation	OxyCont Unit		ml/L
	Hb Unit		g/dl
	Pressure Unit		mmHg
Ventilation	Pressure Unit		mmHg

C.2.9 System Time Default Settings

Item	Default Setting
Date Format	yyyy-mm-dd
24-Hour Time	On
Daylight Savings Time	Off

D Alarm Messages

D.1 Physiological Alarm Messages

This section lists physiological alarms, their default priority, and the actions that can be taken when an alarm occurs.

D.1.1 General Physiological Alarm Messages

Alarm messages	Default priority	Cause and solution
XX High	Med	XX value has risen above the high alarm limit or fallen below the low alarm limit. Check the patient's condition and check if the patient category and alarm limit settings are correct.
XX Low	Med	

Note: XX represents a measurement or parameter label, such as HR, NIBP, PVCs, RR, SpO₂, PR, and so on.

D.1.2 Arrhythmia Alarm Messages

Alarm message	Default priority
Asystole	High
V-Fib/V-Tach	High
V-Tach	High
Vent Brady	High
Extreme Tachy	High
Extreme Brady	High
PVCs/min	Med
Pauses/min	Med
R on T	Med
Bigeminy	Med
Trigeminy	Med
Tachy	Med
Brady	Med
Multiform PVC	Med
Vent Rhythm	Med
Nonsus V-Tach	Med
Run PVCs	Low
Pause	Low
Couplet	Prompt
PVC	Prompt
Irr Rhythm	Prompt
Pacer Not Pacing	Prompt
Pacer Not Capture	Prompt

Alarm message	Default priority
Missed Beat	Prompt
A-Fib	Prompt
SVT	Med
SVCs/min High	Med

Note: When arrhythmia alarms occur, check the patient's condition and the ECG connections.

D.1.3 ST Physiological Alarm Messages

ST alarm mode	Alarm messages	Default priority	Cause and solution
Absolute	ST-XX High	Med	The ST value of respective ECG lead has risen above the high alarm limit or fallen below the low alarm limit. Check the patient's condition and check if the patient category and alarm limit settings are correct.
	ST-XX Low	Med	
Relative	ST Single	Med	ST value of any ECG leads has risen above the high alarm limit or fallen below the low alarm limit. Check the patient's condition and check if the patient category and alarm limit settings are correct.
	ST Dual	Med	ST values of two or more ECG leads have risen above the high alarm limit or fallen below the low alarm limit. Check the patient's condition and check if the patient category and alarm limit settings are correct.

Note: XX represents the ECG lead label.

D.1.4 Resp Physiological Alarm Messages

Alarm message	Default priority	Cause and solution
Resp Artifact	High	The patient's heartbeat has interfered with his respiration. Check the patient's condition and the Resp connections.
Apnea	High	The respiration signal was so weak that the monitor cannot perform respiration analysis. Check the patient's condition, module and patient connections.

D.1.5 SpO₂ Physiological Alarm Messages

Alarm message	Default priority	Cause and solution
SpO ₂ Desat	High	The SpO ₂ value falls below the desaturation alarm limit. Check the patient's condition and check if the alarm limit settings are correct.

D.1.6 PR Physiological Alarm Messages

Alarm message	Default priority	Cause and solution
No Pulse	High	The pulse signal was so weak that the monitor cannot perform pulse analysis. Check the patient's condition, SpO ₂ sensor and measurement site.

D.1.7 NIBP Physiological Alarm Messages

Alarm message	Default priority	Cause and solution
NIBP-S Extremely High/ NIBP-D Extremely High/ NIBP-M Extremely High	High	The NIBP value is higher than the NIBP Extreme alarm high limit. Check the patient's condition and check if the alarm limit settings are correct.
NIBP-S Extremely Low/ NIBP-D Extremely Low/ NIBP-M Extremely Low	High	The NIBP value is lower than the NIBP Extreme alarm low limit. Check the patient's condition and check if the alarm limit settings are correct.

D.1.8 IBP Physiological Alarm Messages (for uMEC 70/uMEC 80/uMEC 120/uMEC 150)

Alarm message	Default priority	Cause and solution
Art-S Extremely High/ Art-D Extremely High/ Art-M Extremely High	High	The Art value is higher than the Art Extreme alarm high limit. Check the patient's condition and check if the alarm limit settings are correct.
Art-S Extremely Low/ Art-D Extremely Low/ Art-M Extremely Low	High	The Art value is lower than the Art Extreme alarm low limit. Check the patient's condition and check if the alarm limit settings are correct.

D.2 Technical Alarm Messages

This section lists technical alarms, their default priority, indication on alarm reset, and the actions that can be taken when an alarm occurs.

Technical alarms give different alarm indicators when the alarm system is reset. In this section we classify the technical alarms into three categories for easy clarification:

- A: technical alarms are cleared. The monitor gives no alarm indications.
- B: technical alarms are changed to the prompt messages.
- C: the alarm is silenced and a √ appears before the alarm message.

In the following tables we will use A, B, and C to refer to the indications on alarm reset.

D.2.1 General Technical Alarm Messages

Alarm message	Default priority	Indication on alarm reset	Cause and solution
XX Module Error	High	C	XX module does not work properly. Restart the monitor, if the alarm persists, contact your service personnel.

Note: XX represents a measurement or parameter label, such as HR, RR, SpO₂, EtCO₂, and so on.

D.2.2 ECG Technical Alarm Messages

Alarm message	Default priority	Indication on alarm reset	Cause and solution
ECG Noisy	Low/Prompt	A	The ECG signal is noisy. Check for any possible sources of signal noise around the cable and electrode, and check the patient for excessive motion.

Alarm message	Default priority	Indication on alarm reset	Cause and solution
ECG Amplitude Too Small	Low	C	The ECG amplitude does not reach the detected threshold. Check for any possible source of interference around the cable and electrode.
ECG Lead Off	Low	B	The electrode has become detached from the patient or the lead wire has become disconnected from the adapter cable. Check the connections of the electrodes and leadwires.
ECG XX Lead Off	Low	B	The electrode has become detached from the patient or the lead wire has become disconnected from the adapter cable. Check the connections of the electrodes and leadwires.
ECG Signal Invalid	Low	A	Patient skin impedance is too high. Check ECG electrode application.
ECG Learning	Prompt	/	ECG learning is manually or automatically triggered.
Cannot Analyze QT	Prompt	/	/
D12L Not Available	Prompt	C	The current Va and Vb combination does not support D12L. Choose an available Va and Vb combination. For more information, see 9.5 Using 6-lead Placement to Derive 12-lead ECG (D12L).

Note: XX represents ECG lead name, for example RL, LL, V, Va, Vb, and so on.

D.2.3 Resp Technical Alarm Messages

Alarm message	Default priority	Indication on alarm reset	Cause and solution
Resp Interference	Prompt	/	The respiration circuit is disturbed. Check for any possible sources of signal noise.
Electrode Poor Contact	Prompt	/	Check the electrode application. Reposition or replace the electrodes if necessary.

D.2.4 SpO₂ Technical Alarm Messages

Alarm message	Default priority	Indication on alarm reset	Cause and solution
SpO ₂ Sensor Off	Low	B	The SpO ₂ sensor has become detached from the patient or the module. Check the sensor connection. If the alarm persists, replace the sensor.
SpO ₂ No Sensor	Low	A	The SpO ₂ extension cable is detached from the SpO ₂ module, or the SpO ₂ sensor is detached from the SpO ₂ extension cable. Check the SpO ₂ cable and the sensor connection. If the alarm persists, replace the sensor.
SpO ₂ Excess Light	Low	C	Ambient light is too strong. Move the sensor to a place with lower level of ambient light or cover the sensor to minimize the ambient light.
SpO ₂ No Pulse	Low	C	The SpO ₂ sensor failed to obtain pulse signal. Check the patient's condition and replace the sensor application site. If the alarm persists, replace the sensor.

Alarm message	Default priority	Indication on alarm reset	Cause and solution
SpO2 Sensor Incompatible	Low	C	Incompatible or an unspecified SpO ₂ sensor is used. Use specified sensors.
SpO2 Low Signal Quality	Low	C	1. Check the sensor and sensor position. 2. Make sure the patient is not shivering or moving. 3. The patient's pulse may be too low to be measured.
SpO2 Interference	Low	C	The SpO ₂ signal has been interfered. Check for any possible sources of signal noise and check the patient for excessive motion.
SpO2 Sensor Error	Low	C	Replace the sensor and measure again.
SpO2 Searching Pulse	Prompt	/	SpO ₂ is searching for pulse.
SpO2 Low Perfusion	Prompt	/	The SpO ₂ sensor is not properly placed or the patient's perfusion index is too low. 1. Check the sensor and sensor position. 2. Reposition the sensor if necessary.

D.2.5 Temp Technical Alarm Messages

Alarm message	Default priority	Indication on alarm reset	Cause and solution
T XX Sensor Off	Low	A	Check the sensor connection and reconnect the sensor.

Note: XX represents a temperature site, for example skin, core, axil, T1, and so on.

D.2.6 NIBP Technical Alarm Messages

Alarm message	Default priority	Indication on alarm reset	Cause and solution
NIBP Cuff Loose	Low	A	There is a leak in the cuff or air tubing. Use a cuff of correct type based on the patient size. Apply the cuff and connect the air tubing as instructed in the manual.
NIBP Cuff or Airway Leak	Low	A	Check the NIBP cuff and pump for leakages.
NIBP Airway Error	Low	A	The air tubing may be occluded. Check the air tubing for an occlusion or kinking. If the alarm persists, contact your service personnel.
NIBP Weak Signal	Low	A	The patient's pulse is weak or the cuff is loose. Check the patient's condition and replace the cuff application site.
NIBP Overrange	Low	A	The measured NIBP value exceeds the module measurement range. Check the patient's condition.
NIBP Excessive Motion	Low	A	Check the patient's condition and reduce patient motion.
NIBP Cuff Overpressure	Low	A	The NIBP airway may be occluded. Check the airway and measure again. If the alarm persists, contact your service personnel.

Alarm message	Default priority	Indication on alarm reset	Cause and solution
NIBP Timeout	Low	A	The measurement time exceeds 120 seconds in the adult or pediatric mode, or exceeds 90 seconds in the neonatal mode, and the BP value cannot be obtained. Check the patient's condition and NIBP connections, or replace the cuff and measure again.
NIBP Cuff and Patient Mismatch	Low	A	The cuff type mismatches the patient category. Verify the patient category or replace the cuff if necessary. If patient category is correct, check that the tubing is not bent and the airway is not occluded.
NIBP Airway Leak	Low	A	Airway leakage is found during the NIBP leakage test. Check the NIBP cuff and pump for leakages.

D.2.7 IBP Technical Alarm Messages (for uMEC 70/uMEC 80/uMEC 120/uMEC 150)

Alarm message	Default priority	Indication on alarm reset	Cause and solution
XX Sensor Error	Med	C	The IBP sensor fails. Replace the sensor.
XX No Sensor	Med	A	The IBP patient cable and/or corresponding IBP sensor is not connected or detached. Check the cable and sensor connection.
XX No Pulse	Low	A	The catheter may be occluded. Please flush the catheter.
XX Disconnected	High	C	The liquid way is disconnected from the patient, or the three-way valve is open to the air. Check the connection of the liquid way, or check the valve is open to the patient. If the alarm persists, contact your service personnel.

Note: XX represents an IBP label, for example PA, CVP, FAP, P1, and so on.

D.2.8 C.O. Technical Alarm Messages (for uMEC 70/uMEC 80/uMEC 120/uMEC 150)

Alarm message	Default priority	Indication on alarm reset	Cause and solution
TB Sensor Off	Low	A	Check the sensor connection and reconnect the sensor.
TI Sensor Off	Low	A	Check the sensor connection and reconnect the sensor.

D.2.9 CO₂ Technical Alarm Messages (for uMEC 70/uMEC 80/uMEC 120/uMEC 150)

Alarm message	Default priority	Indication on alarm reset	Cause and solution
CO ₂ Module High Temp	Low	C	Ambient temperature is too high or there is a module failure. 1. Lower the operating temperature. 2. Restart the monitor. 3. If the alarm persists, the CO ₂ module may fail, contact your service personnel.

Alarm message	Default priority	Indication on alarm reset	Cause and solution
CO2 Module Low Temp	Low	C	Ambient temperature is too low or there is a module failure. 1. Raise the operating temperature. 2. Restart the monitor. 3. If the alarm persists, the CO ₂ module may fail, contact your service personnel.
CO2 Zero Failed	Low	C	For mainstream CO ₂ module, check the connections between the adapter and CO ₂ transducer. Wait till the sensor's temperature becomes stabilized, and then perform a zero calibration again. For sidestream CO ₂ module, restart the monitor. If the alarm persists, contact your service personnel.
CO2 No Watertrap	Low	B	Check the watertrap connections.
CO2 High Airway Pressure	Low	C	1. Check the airway pressure settings of the ventilator/anesthesia machine. 2. Disconnect the module from the ventilator/anesthesia machine. 3. Restart the monitor. 4. If the alarm persists, contact your service personnel.
CO2 Low Airway Pressure	Low	C	1. Check the airway pressure settings of the ventilator/anesthesia machine. 2. Disconnect the monitor from the ventilator/anesthesia machine. 3. Restart the monitor. 4. If the alarm persists, contact your service personnel.
High Barometric	Low	C	The ambient pressure exceeds the operating pressure range or CO ₂ module fails. 1. Make sure that the ambient pressure meets the specifications, and check for sources that affect the ambient pressure. 2. Restart the monitor. 3. If the alarm persists, contact your service personnel.
Low Barometric	Low	C	The ambient pressure exceeds the operating pressure range or CO ₂ module fails. 1. Make sure that the ambient pressure meets the specifications, and check for sources that affect the ambient pressure. 2. Restart the monitor. 3. If the alarm persists, contact your service personnel.
CO2 Airway Occluded	Low	C	1. Check if the sample line is kinked or occluded. 2. Replace the sample line. 3. Restart the monitor. 4. If the alarm persists, contact your service personnel.
CO2 No Filterline	Low	A	Make sure that the filterline is connected.
CO2 Calibration Required	Low	C	Perform a calibration.

Alarm message	Default priority	Indication on alarm reset	Cause and solution
CO2 Airway Error	Low	C	1. Check if the sample line is kinked or occluded. 2. Replace the sample line. 3. Restart the monitor. 4. If the alarm persists, contact your service personnel.
CO2 Adapter Error	Low	A	Check, clean or replace the airway adapter. Perform a zero calibration.
CO2 No Sensor	Low	A	Make sure that the CO ₂ transducer is connected.
CO2: Change Watertrap	Low	C	Replace the watertrap.
CO2 Watertrap and Patient Mismatch	Low	C	Check the patient category and use a correct watertrap.

D.2.10 EWS Technical Alarms

Alarm message	Default priority	Indication on alarm reset	Cause and solution
EWS param XX is timeout	Low	A	The manually input parameter is timeout. Input a parameter numeric again.
EWS score needs to be confirmed	Low	A	Confirm to save or give up current score.

XX represents RR, SpO₂, Supp. O₂, Temp, BP, HR, Consciousness, Blood Sugar, Urine Output, Catheter, Pain Score, Pain, EtCO₂, Airway, or Customer defined parameter.

D.2.11 Power Supply Technical Alarm Messages

Alarm message	Default priority	Indication on alarm reset	Cause and solution
Low Battery	Med	C	Connect the monitor to the external power supply and allow the batteries to charge.
Critically Low Battery	High	C	Connect the monitor to the external power supply and allow the batteries to charge.
Power Board Comm Error	High	C	Restart the monitor. If the alarm persists, contact your service personnel.
Battery Error	High	C	The battery may fail. Contact your service personnel.
RT Clock Need Reset	High	C	Contact your service personnel.
RT Clock Not Exist	High	C	Contact your service personnel.
XX V Too High	High	C	There is a problem with the system power supply. Restart the monitor.
XX V Too Low	High	C	

Note: XX represents 2.5 V, 3.3 V, 5 V, or 12 V.

D.2.12 Recorder Technical Alarm Messages

Alarm message	Default priority	Indication on alarm reset	Cause and solution
Recorder Init Error	Low	A	An error occurred during the recorder initialization. If the alarm persists, contact your service personnel.
Recorder Comm Error	Low	A	Restart the monitor if not solved. If the alarm persists, contact your service personnel.
Recorder Head Hot: Please Wait	Low	C	The recorder has been working for too long time. Stop the recording and resume the recording till the recorder's print head cools down.
Recorder Initializing	Prompt	/	Wait until the recorder initialization is completed.
Recorder Out Of Paper	Prompt	/	The recorder paper is not loaded or the recorder door is not closed. Check the recorder, load the recorder paper or close the recorder door.
Recorder Busy	Prompt	/	The buffer queue for recording is full.

D.2.13 Printer Technical Alarm Messages

Alarm message	Default priority	Indication on alarm reset	Cause and solution
Printer Buffer Full	Prompt	/	The printer buffer is full. Wait till the printer finishes the printing task.
Fail	Prompt	/	The printer runs out of paper or cannot be connected. Check the printer.
Printing Stopped	Prompt	/	Printing is manually stopped.
Printer Unavailable	Prompt	/	The printer may fail. Check the printer.
PDF storage space is nearly full	Prompt	/	Delete the files saved under the PDF file path to release storage space. Otherwise you cannot save new PDF files.
Error storing PDF file	Prompt	/	The PDF file path settings on the printer server and the PDFCreator are not consistent or the PDF storage space is full. Check the PDF file path settings for consistency, or delete the files saved under the PDF file path to release storage space.
Change the print server language to be consistent with this monitor	Prompt	/	Verify that the language settings of the printer server and the monitor are consistent, Otherwise you cannot perform printing.
Print Server Disconnected	Prompt	/	Check that the monitor is properly connected with the printer server.

D.2.14 Technical Alarm Messages Related to Networked Monitoring

Alarm message	Default priority	Indication on alarm reset	Cause and solution
CMS/eGW Disconnected	Low	B	The monitor is disconnected from the CMS. Check the network connection.
View Bed XX YY-ZZ, Network Disconnected.	Low	A	The network is interrupted when the monitor is viewing the remote device. Check the network connection.

Alarm message	Default priority	Indication on alarm reset	Cause and solution
Viewed by Bed XX YY-ZZ, Network Disconnected.	Low	A	The network is interrupted when the monitor is viewed by another remote device. Check the network connection.
WLAN IP Address Conflict	Low	C	Wireless network IP network conflicts. Check the network settings.
LAN1 IP Address Conflict	Low	C	Wired network LAN1 IP network conflicts. Check the network settings.
Fail To Get WLAN IP Address	Low	C	Unable to automatically obtain the wireless network IP address. Check the network settings.
Fail To Get LAN1 IP Address	Low	C	Unable to automatically obtain the wired network LAN1 IP address. Check the network settings.

Note: XX refers to the department name, YY refers to the room number, and ZZ refers to the bed number.

D.2.15 Other System Technical Alarm Messages

Alarm message	Default priority	Indication on alarm reset	Cause and solution
Storage Error	High	C	The storage card fails or files are damaged. Restart the monitor to format the storage card. If the alarm persists, contact your service personnel.
Loading Default Config Failed	Low	A	The default configuration is not correctly loaded. The monitor will restore to the factory default configuration for the current patient category.
XX Measurement has been closed (XX refers to the module label)	Prompt	/	The parameter module is disabled. Switch on the module if you want to use it. For more information, see 3.11.1 <i>Switching On or Off a Parameter</i> .
The display setup for XX is disabled. (XX refers to the parameter label)	Prompt	/	The parameter of the newly inserted module is not displayed on the screen. Select a desired area to display the parameter numerics and waveforms. For more information, see 3.11.2 <i>Displaying Parameter Numerics and Waveforms</i> .
The patient data storage space is nearly full. Please delete some discharged patients.	Med	B	Delete unnecessary earlier discharged patient.

E Electrical Safety Inspection

The following electrical safety tests are recommended as part of a comprehensive preventive maintenance program. They are a proven means of detecting abnormalities that, if undetected, could prove dangerous to either the patient or the operator. Additional tests may be required according to local regulations.

All tests can be performed using commercially available safety analyzer test equipment. These procedures assume the use of a 601PROXL International Safety Analyzer or equivalent safety analyzer. Other popular testers complying with IEC 60601-1 used in Europe, such as Fluke, Metron, or Gerb, may require modifications to the procedure. Please follow the instructions of the analyzer manufacturer.

The electrical safety inspection should be periodically performed every two years. The safety analyzer also proves to be an excellent troubleshooting tool to detect abnormalities of line voltage and grounding, as well as total current loads.

E.1 Power Cord Plug

Test Item		Acceptance Criteria
The power plug	The power plug pins	No broken or bent pin. No discolored pins.
	The plug body	No physical damage to the plug body.
	The strain relief	No physical damage to the strain relief. No plug warmth for device in use.
	The power plug	No loose connections.
The power cord		No physical damage to the cord. No deterioration to the cord.
		For devices with detachable power cords, inspect the connection at the device.
		For devices with non-detachable power cords, inspect the strain relief at the device.

E.2 Device Enclosure and Accessories

E.2.1 Visual Inspection

Test Item	Acceptance Criteria
The enclosure and accessories	No physical damage to the enclosure and accessories.
	No physical damage to meters, switches, connectors, etc.
	No residue of fluid spillage (e.g., water, coffee, chemicals, etc.).
	No loose or missing parts (e.g., knobs, dials, terminals, etc.).

E.2.2 Contextual Inspection

Test Item	Acceptance Criteria
The enclosure and accessories	No unusual noises (e.g., a rattle inside the case).
	No unusual smells (e.g., burning or smoky smells, particularly from ventilation holes).
	No taped notes that may suggest device deficiencies or operator concerns.

E.3 Device Labeling

Check the labels provided by the manufacturer or the healthcare facilities are present and legible.

- Main unit label
- Integrated warning labels

E.4 Protective Earth Resistance

1. Plug the probes of the analyzer into the device's protective earth terminal and protective earth terminal of the AC power cord.
2. Test the earth resistance with a current of 25 A.
3. Verify the resistance is less than limits.

LIMITS

For all countries, $R = 0.2 \Omega$ Maximum

E.5 Earth Leakage Test

Run an Earth Leakage test on the device being tested before performing any other leakage tests.

The following outlet conditions apply when performing the Earth Leakage test:

- normal polarity (Normal Condition),
- reverse polarity (Normal Condition),
- normal polarity with open neutral (Single Fault Condition),
- reverse polarity with open neutral (Single Fault Condition)

LIMITS

For UL60601-1,

- ◆ 300 μ A in Normal Condition
- ◆ 1000 μ A in Single Fault Condition

For IEC60601-1,

- ◆ 500 μ A in Normal Condition
- ◆ 1000 μ A in Single Fault Condition

E.6 Patient Leakage Current

Patient leakage currents are measured between a selected applied part and mains earth. All measurements have a true RMS only

The following outlet conditions apply when performing the Patient Leakage Current test.

- normal polarity (Normal Condition);
- reverse polarity (Normal Condition),
- normal polarity with open neutral (Single Fault Condition);
- reverse polarity with open neutral (Single Fault Condition).
- normal polarity with open earth (Single Fault Condition);
- reverse polarity with open earth (Single Fault Condition).

LIMITS

For  CF applied parts

- ◆ 10 μ A in Normal Condition
- ◆ 50 μ A in Single Fault Condition

For  BF applied parts

- ◆ 100 μA in Normal Condition
- ◆ 500 μA in Single Fault Condition



E.7 Mains on Applied Part Leakage

The Mains on Applied Part test applies a test voltage, which is 110% of the mains voltage, through a limiting resistance, to selected applied part terminals. Current measurements are then taken between the selected applied part and earth. Measurements are taken with the test voltage (110% of mains) to applied parts in the normal and reverse polarity conditions

The following outlet conditions apply when performing the Mains on Applied Part test.

- Normal Polarity;
- Reversed Polarity

LIMITS

- ◆ For  CF applied parts: 50 μA
- ◆ For  BF applied parts: 5000 μA

E.8 Patient Auxiliary Current

Patient Auxiliary currents are measured between any selected Applied Part connector and the remaining Applied Part connectors. All measurements may have a true RMS only response.

The following outlet conditions apply when performing the Patient Auxiliary Current test.

- normal polarity (Normal Condition);
- reverse polarity (Normal Condition),
- normal polarity with open neutral (Single Fault Condition);
- reverse polarity with open neutral (Single Fault Condition).
- normal polarity with open earth (Single Fault Condition);
- reverse polarity with open earth (Single Fault Condition).

LIMITS

For  CF applied parts,

- ◆ 10 μA in Normal Condition
- ◆ 50 μA in Single Fault Condition

For  BF applied parts,

- ◆ 100 μA in Normal Condition
- ◆ 500 μA in Single Fault Condition

NOTE

-
- **Make sure the safety analyzer is authorized comply with requirement of IEC60601-1.**
 - **Follow the instructions of the analyzer manufacturer.**
-

This page intentionally left blank.

F Electronic Interface

The technical descriptions of the monitor, with a wireless or wired electronic interface, are as follows:

Electronic Interface	Specification
VGA	D-sub interface, complied with RS343 electrical standards.
Network connector	TCP/IP protocol bottom layer. HL7 protocol application layer. Calibration protocol of TCP/IP. RJ45 interface, supporting wired network 10 M/100 M, and complied with technical standard IEEE802.3. The intended information flow is from the equipment to the CMS or the server in the client site.
WI-FI	TCP/IP protocol bottom layer. HL7 protocol application layer. Calibration protocol of TCP/IP. The intended information flow is from the equipment to the CMS or the server in the client site.
USB	Type A interface, complied with USB 2.0 standard. Fixed time synchronization pulse specified by the USB protocol.
ECG	Mindray ECG connector
SpO2	Mindray SpO2 connector
NIBP	Mindray NIBP connector
Temp	Mindray Temp connector
IBP	Mindray IBP connector
C.O.	Mindray C.O. connector
Mainstream CO2	Mindray CO2 connector

This page intentionally left blank.

G An ECG Wave Recognition Method for Mindray Resting 12-lead ECG Analysis Algorithm

G.1 Preprocessing

Initially, a 50Hz or 60Hz notch filter should have been applied within the acquiring device. The ECG data is then filtered to minimize the effects of noise. The next step is to calculate a difference of each lead. And then choose the best 3 leads based on the amplitude of ECG. Combining the ECG data and the difference in these best 3 leads, the QRS locations are derived.

G.2 QRS typing

For each lead, the QRS complexes is compared each other, if the QRS width, RR Interval, and the morphology of QRS complex are similar, the QRS complexes are classified to the same class. Synthesizing QRS class of all the 12 leads, the beats are classified to different classes.

G.3 Selection of required QRS class

If more than one class of beat is present, then a decision has to be made as to which morphology will be used for the averaging procedure. A complex logic is used and the required QRS class is regarded as being conducted in the normal sequence through the ventricles.

G.4 Averaging

All beats in the selected class are averaged. First the alignment points are detected, and then all corresponding aligned points are straight averaged.

G.5 Wave measurement

From the 12 average beats, first the peak of QRS is determined, and then considering the amplitude and the slope, the QRS onset and termination are determined.

In each individual lead, the QRS onset is taken as the baseline and hence Q, R, S, R' waves are measured with respect to the QRS onset.

A sorting algorithm is then applied to all 12 onsets to determine the global QRS onset as follows. The two earliest onsets are excluded and the next onset that also lies within 10ms of two before that is then selected as the overall onset. The reverse process is used to find the overall QRS termination but the interval limit is changed from 10ms to 16ms. The isoelectric segment at the beginning of a QRS complex which is a flat segment between the globe QRS onset and individual lead QRS onset are exclude from the first component of the QRS, the same process is used for the isoelectric segment at the end of a QRS complex.

G.6 QRS components

Within the QRS complex, the amplitude and duration of the various Q, R, S, R' waves are then measured. In keeping with the CSE recommendations, the minimum wave acceptable has to have a duration >8 ms and an amplitude >20 μ V. The global QRS duration is from global QRS onset to the global QRS termination.

G.7 ST segment

The ST segment measurements are made at J point, and at equal intervals throughout the ST segment.

G.8 P and T waves

P wave is searched in the interval preceding the QRS complex. A P wave may not be found in certain arrhythmias. P onset and termination are determined basing on the amplitude and slope. The globe P onset and termination is used over all 12 leads because in many leads the p wave amplitude may be too low. The baseline for P wave amplitude measurement respect to P onset.

T termination is determined also depend on the amplitude and slope. The global T termination is derived similarly to the globe QRS termination. The other components of the ECG waveform (ST and T) amplitudes are also measured with respect to QRS onset.

G.9 Evaluation results of absolute interval and wave duration measurements

MEASUREMENT	Mean Difference (ms)	Acceptable standard (ms)	Standard Deviation (ms)	Acceptable standard (ms)
P DURATION	-10	±10	2.256	SD<=8
QRS DURATION	-0.143	±6	2.413	SD<=5
PR INTERVAL	-8.286	±10	1.729	SD<=8
QT INTERVAL	1.385	±12	6.501	SD<=10
Q DURATION	-0.108	±6	4.241	SD<=5
R DURATION	3.020	±6	2.710	SD<=5
S DURATION	-3.282	±6	3.396	SD<=5

G.10 Evaluation results of interval measurements on biological ECGs

Measurement	Mean Difference (ms)	Acceptable standard (ms)	Standard Deviation (ms)	Acceptable standard (ms)
P Duration	-2.708	±10	10.194	SD <=15
QRS Duration	-9.750	±10	6.676	SD <=10
PQ Interval	2.458	±10	7.182	SD <=10
QT Interval	-4.500	±25	14.483	SD <=30

G.11 Evaluation results of stability of measurements against noise

Global Measurement	Type of Added Noise	Disclosed Differences	
		Mean Difference (ms)	Standard Deviation (ms)
P Duration	High Frequency	1.4	9.192
P Duration	Line Frequency (50Hz)	-0.2	8.404
P Duration	Line Frequency (60Hz)	0.8	5.181
P Duration	Base-Line	4.2	8.244
QRS Duration	High Frequency	-0.6	2.119
QRS Duration	Line Frequency (50Hz)	0	0.943
QRS Duration	Line Frequency (60Hz)	0.4	1.265
QRS Duration	Base-Line	0.8	3.553
QT Interval	High Frequency	-2.2	6.070

Global Measurement	Type of Added Noise	Disclosed Differences	
		Mean Difference (ms)	Standard Deviation (ms)
QT Interval	Line Frequency (50Hz)	-1.4	6.867
QT Interval	Line Frequency (60Hz)	2.4	3.978
QT Interval	Base-Line	0.6	3.134

This page intentionally left blank.

H Units, Symbols and Abbreviations

H.1 Units

Abbreviation	In Full
μA	microampere
μV	microvolt
μs	microsecond
A	ampere
Ah	ampere hour
bpm	beat per minute
bps	bit per second
°C	centigrade
cc	cubic centimeter
cm	centimeter
dB	decibel
DS	dyne second
°F	Fahrenheit
g	gram
GHz	gigahertz
GTT	gutta
h	hour
Hz	hertz
in	inch
k	kilo
kg	kilogram
kPa	kilopascal
L	litre
lb	pound
m	meter
mAh	milliampere hour
Mb	mega byte
mcg	microgram
mEq	milli-equivalents
mg	milligram
min	minute
ml	milliliter
mm	millimeter

Abbreviation	In Full
mmHg	millimeters of mercury
cmH ₂ O	centimeters of water
ms	millisecond
mV	millivolt
mW	milliwatt
MΩ	megaohm
nm	nanometer
rpm	breaths per minute
s	second
V	volt
VA	volt ampere
Ω	ohm
W	watt

H.2 Symbols

Symbol	Explanation
-	minus
-	negative
%	percent
/	per; divide; or
~	to
+	plus
=	equal to
<	less than
>	greater than
≤	less than or equal to
≥	greater than or equal to
±	plus or minus
×	multiply
©	copyright

H.3 Abbreviations

Abbreviation	In Full
AaDO ₂	alveolar-arterial oxygen gradient
AC	alternating current
Adu	adult
AHA	American Heart Association
Ao	aortic pressure
Art	arterial
ATMP	barometric pressure
aVF	left foot augmented lead
aVL	left arm augmented lead
aVR	right arm augmented lead
awRR	airway respiratory rate
BSA	body surface area
BT	blood temperature
BTPS	body temperature and pressure, saturated
CAA	Clinical Assistive Application
CaO ₂	arterial oxygen content
CCU	cardiac (coronary) care unit
CE	Conformité Européenne
C.I.	cardiac index
CIS	clinical information system
CISPR	International Special Committee on Radio Interference
CMS	central monitoring system
C.O.	cardiac output
CO ₂	carbon dioxide
COHb	carboxyhemoglobin
COPD	chronic obstructive pulmonary disease
CVP	central venous pressure
DC	direct current
Des	desflurane
Dia	diastolic
dpi	dot per inch
DVI	digital video interface
ECG	electrocardiograph
EDV	end-diastolic volume
EEC	European Economic Community
EMC	electromagnetic compatibility
EMI	electromagnetic interference

Abbreviation	In Full
Enf	enflurane
ESU	electrosurgical unit
EtCO ₂	end-tidal carbon dioxide
EWS	Early Warning Score
FAP	femoral arterial pressure
FCC	Federal Communication Commission
FDA	Food and Drug Administration
Fi	fraction of inspired
FICO ₂	fraction of inspired carbon oxygen
GCS	Glasgow Coma Scale
GEDV	global end diastolic volume
GEDI	global end diastolic volume index
GEF	global ejection fraction
Hal	halothane
HIS	hospital information system
HR	heart rate
IABP	intra-aortic balloon pump
IBP	invasive blood pressure
ICP	intracranial pressure
ICU	intensive care unit
ID	identification
I:E	inspiratory time: expiratory time ratio
IEC	International Electrotechnical Commission
IEEE	Institute of Electrical and Electronic Engineers
IP	internet protocol
IPS	individual parameter score
Iso	isoflurane
LA	left arm
LAP	left atrial pressure
LCD	liquid crystal display
LDAP	Lightweight Directory Access Protocol
LED	light emitting diode
LL	left leg
LVS _W	left ventricular stroke work
LVS _W I	left ventricular stroke work index
MAC	minimum alveolar concentration
MetHb	methemoglobin
MEWS	Modified Early Warning Score
MLDAP	Mindray LDAP, Mindray Lightweight Directory Access Protocol

Abbreviation	In Full
MRI	magnetic resonance imaging
N/A	not applied
N ₂ O	nitrous oxide
Neo	neonate
NEWS	National Early Warning Score
NIBP	noninvasive blood pressure
O ₂	oxygen
O ₂ %	oxygen concentration
OR	operating room
oxyCRG	oxygen cardio-respirogram
PA	pulmonary artery
PAWP	pulmonary artery wedge pressure
Ped	pediatric
Pleth	plethysmogram
PPV	pulse pressure variation
PR	pulse rate
PVC	premature ventricular contraction
RA	right arm
RAP	right atrial pressure
Raw	airway resistance
Rec	record, recording
Resp	respiration
RL	right leg
RQ	respiratory quotient
RR	respiration rate
SEF	spectral edge frequency
Sev	sevoflurane
SI	stroke index
SlopeCO ₂	Slope of the alveolar plateau
SpO ₂	arterial oxygen saturation from pulse oximetry
SQI	signal quality index
SR	suppression ratio
SV	stroke volume
SVI	stroke volume index
SVR	systemic vascular resistance
SVRI	systemic vascular resistance index
Sync	synchronization
Sys	systolic pressure
TB	Blood Temperature

Abbreviation	In Full
TD	temperature difference
Temp	temperature
TFC	thoracic fluid content
TI	injectate temperature
TP	total power
TV	tidal volume
UAP	umbilical arterial pressure
USB	universal serial bus
UVP	umbilical venous pressure
VAC	volts alternating current
VO ₂	O ₂ consumption for one breath
VO ₂ I	oxygen consumption index

Declaration of Conformity

Declaration of Conformity V1.0

Declaration of Conformity



Manufacturer: Shenzhen Mindray Bio-Medical Electronics Co., Ltd.
Mindray Building, Keji 12th Road South, High-tech Industrial Park,
Nanshan, Shenzhen, 518057, P. R. China

EC-Representative: Shanghai International Holding Corp. GmbH (Europe)
Eiffestraße 80
20537 Hamburg, Germany

Product: Patient monitor

Model: uMEC 30 / uMEC 60 / uMEC 70 / uMEC 80 / uMEC 100 / uMEC 120
/ uMEC 150

We herewith declare under our sole responsibility that the above mentioned products meet the provisions of the Council Directive 2014/53/EU concerning radio equipment.

All supporting documentation is retained under the premises of the manufacturer.

Standards Applied:

<input checked="" type="checkbox"/> EN 60601-1:2006+A1:2013+A2:2021	<input checked="" type="checkbox"/> EN 60601-1-2:2015/A1:2021
<input checked="" type="checkbox"/> EN IEC 62311:2020	<input checked="" type="checkbox"/> ETSI EN 301 489-1 V2.2.3
<input checked="" type="checkbox"/> ETSI EN 301 489-17 V3.2.4	<input checked="" type="checkbox"/> ETSI EN 300 328 V2.2.2
<input checked="" type="checkbox"/> ETSI EN 301 893 V2.1.1	

Start of CE-Marking:

2023.7.7

Place, Date of Issue:

Shenzhen, 2023.7.7

Signature:

Name of Authorized Signatory: Mr. Wang Xinhong

Position Held in Company:

Deputy Director, Technical Regulation

This page intentionally left blank.



Accessories and Consumables

CATALOGUE

2024.07

www.mindray.com

P/N:ENG-Accessories and Consumables Catalogue-210210X160P-20240717
©2024 Shenzhen Mindray Bio-Medical Electronics Co.,Ltd. All rights reserved.





Welcome to the Mindray Accessories Catalogue

This catalogue will provide you with the parts and accessories that connect to your Mindray Patient Monitor, Electrocardiograph, Defibrillator. Each Mindray product is the product of a special brand of patient focused, clinician-friendly design. For this reason, you can expect the same service, focus and quality with our parts and accessories.

Finding the Right Part

This catalog has been designed to make finding the right part easy. Chapters are organized by specific parameter categories. Simply locate the type of part you are looking for under the appropriate category.

Note:

This catalog is not an Operating Instructions Manual. This catalog will assist you in identifying the correct parts and accessories to connect to your Mindray product, please refer to the Operating Instructions Manual.

Warnings, Precautions and Notes can also be found in the Operating Instructions.

Patient Monitor Accessories

ECG	2
SpO ₂	22
NIBP	36
mWear	52
TEMP	56
CO ₂	67
AG	82
IBP	86
RM	91
C.O.	94
ICG	98
BIS	99
ESI	100
PICCO ₂	102
CCO	106
aEEG	107
ANI	111
NMT	112
rSO ₂	115
Mounting	116
Rolling stands	127
Others	129
Accessories Management	132
Barcode Scanner	133

01

02

Defibrillator Accessories

134

03

Electrocardiograph Accessories

154



Patient Monitor Accessories

ECG Accessories







Integrated ECG Cable

- Integrated design, convenient for use and maintenance
- Meeting the requirements of EC53
- Outstanding shielding property and anti-interference performance, protecting ECG signal from being interfered
- Excellent defibrillation-proof performance, well protecting the equipment
- Flexible and durable cables
- Outstanding cable material, enduring repeated cleaning and disinfection
- Latex free



Integrated ECG Cables - IEC

For BeneVision, ePM, uMEC series monitors, BeneHeart defibrillator, uMED 20

Picture	Model	Part No.	No. Description	Purchasing Unit
	EA6252B	040-000963-00	ECG cable and wires (integrative): Adu/Ped, 12 Pin 5-Lead, Defib-Proof, IEC, Snap, 3.6 m	Each
	EA6232B	040-000967-00	ECG cable and wires (integrative): Adu/Ped, 12 Pin 3-Lead, Defib-Proof, IEC, Snap, 3.6 m	Each
	EA6252A	040-000962-00	ECG cable and wires (integrative): Adu/Ped, 12 Pin 5-Lead, Defib-Proof, IEC, Clip, 3.6 m	Each
	EA6232A	040-000966-00	ECG cable and wires (integrative): Adu/Ped, 12 Pin 3-Lead, Defib-Proof, IEC, Clip, 3.6 m	Each

Electrode

- Latex free
- DEHP free
- Good biocompatibility, avoiding allergic reactions to patient

Picture	Model	Part No.	No. Description	Purchasing Unit
	H124SG	900E-10-04880	Neonatal ECG Electrode (Kendall, H124SG)	50pcs/pouch
		040-002711-00	Adult ECG electrode (INTCO)	5 pcs/pouch
		040-002833-00	Pediatric/Neonatal ECG electrode (INTCO)	30 pcs/pouch

Match with 3-lead Neonatal cables (040-000754-00)



Picture	Model	Part No.	No. Description	Purchasing Unit
	0406062	040-003254-00	Disposable neonatal 3-lead pre-wired electrode, radio translucent, AHA, 60 cm	50 pouch/box (3 pcs/pouch)

Mindray SpO₂ Sensor

Finger-Clip Sensor (Reusable)

- Ergonomic design, precise engineering and clinical testing guaranteeing reliable measurement
- High quality photoelectric element, ensuring precise measurement
- Well anti-electromagnetic interference, suitable for complex electrical environment
- Perfect performance against light interference, can be used in environment of strong light
- ESU-proof, ensuring SpO₂ signals not interfered during operation
- Strict electric safety specification, guaranteeing safety for use
- Few pit structure, not easily staining, convenient for cleaning
- Outstanding cable jacket, enduring repeated cleaning and disinfection
- Latex free
- Good biocompatibility, avoiding allergic reactions to patient

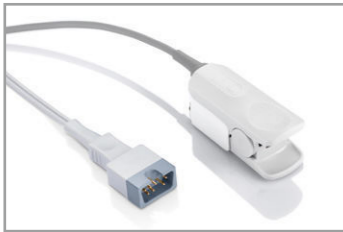

For all Mindray SpO₂ Cables and PM-50/60 pulse oximeter

Picture	Model	Part No.	No. Description	Purchasing Unit
	512F	512F-30-28263	Reusable sensor, adult, finger-clip, 1.1 m, >30 kg	Each
	512H	512H-30-79061	Reusable sensor, pediatric, finger-clip, 1.1 m, 10-30 kg	Each

Finger-Tip Sensor (Reusable)

- Ergonomic design, precise engineering and clinical testing guaranteeing reliable measurement
- High quality photoelectric element, ensuring precise measurement
- Well anti-electromagnetic interference, suitable for complex electrical environment
- Perfect performance against light interference, can be used in environment of strong light
- ESU-proof, ensuring SpO₂ signals not interfered during operation
- Strict electric safety specification, guaranteeing safety for use
- Silicone rubber sheath, not likely to break in case of drop, hardly sensor off
- Few pit structure, not likely staining, convenient for cleaning
- Outstanding cable jacket, enduring repeated cleaning and disinfection
- Latex free
- Good biocompatibility, avoiding allergic reactions to patient

For all Mindray SpO₂ Cables and PM-50/60 pulse oximeter

Picture	Model	Part No.	No. Description	Purchasing Unit
	512E	512E-30-90390	Reusable sensor, adult, finger-tip, 1.1 m, >30 kg	Each
	512G	512G-30-90607	Reusable sensor, pediatric, finger-tip, 1.2 m, 10-30 kg	Each



Adapted with the tubing (6200-30-09688, 115-012522-00, 040-002712-00)

Picture	Model	Part No.	No. Description	Purchasing Unit
	CM1905	040-000688-00	NIBP Cuff Tubing Adapter (Adult tubing to Neonate cuff)	Each

CM1200 Series

- Soft and comfortable. Low hazard to skin even if a long-term use
- Easy to clean. The cuff wrap can not be damped or stained by liquid if duly cleaned
- Pilling-proof. Not deform even if for long-term use
- TPU bladder ensures good air tightness and long life
- Latex free, PVC free
- Good biocompatibility, free from biological hazard to skin

Connected with the tubing 6200-30-09688, 115-012522-00 and 040-002712-00

Picture	Model	Part No.	No. Description	Purchasing Unit
	CM1200	115-002480-00	Reusable cuff, Small Inf, 7-13cm - ISO80369	Each
	CM1201	0010-30-12157	Reusable cuff, Inf, 10-19cm, with connector - ISO80369	Each

Picture	Model	Part No.	No. Description	Purchasing Unit
	CM1202	0010-30-12158	Reusable cuff, Child, 18-26cm, with connector - ISO80369	Each
	CM1203	0010-30-12159	Reusable cuff, Adu, 25-35cm, with connector - ISO80369	Each
	CM1204	0010-30-12160	Reusable cuff, Large Adu, 33-47cm, with connector - ISO80369	Each
	CM1205	0010-30-12161	Reusable cuff, Thigh, 46-66cm, with connector - ISO80369	Each



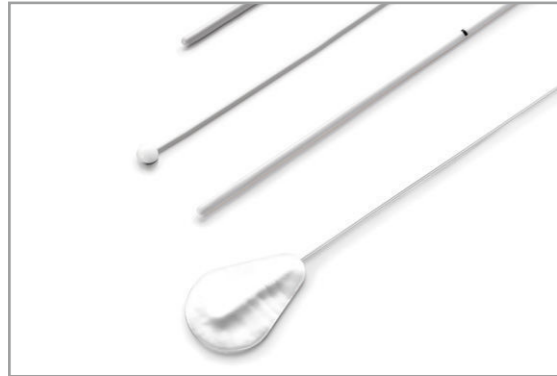

Temperature Accessories



Reusable Temperature Probes

- Available in Rectal/Esophageal and Skin Surface Styles
- Flexible and durable cables
- Outstanding cable material, enduring repeated cleaning and disinfection
- Latex free
- Good biocompatibility, avoiding allergic reactions to patient

For BeneVision, ePM, uMEC, series monitors, BeneHeart defibrillator

Picture	Model	Part No.	No. Description	Purchasing Unit
	MR401B	0011-30-37392	Reusable Temp Probe, Adu, Esophageal/Rectal, 2 Pin, 3 m	Each
	MR402B	0011-30-37394	Reusable Temp Probe, Ped/Neo, Esophageal/Rectal, 2 Pin, 3 m	Each
	MR403B	0011-30-37393	Reusable Temp Probe, Adu, Skin, 2 Pin, 3.6 m	Each
	MR404B	0011-30-37395	Reusable Temp Probe, Ped/Neo, Skin, 2 Pin, 3.6 m	Each