

**Ohrspekula : Ear specula
Spéculums auriculaires
Espéculos auriculares
Specoli auricolari**



Toynbee ○ 1:1 ○ 1:1 ○ 1:1 ○ 1:1

	Fig. 1	Fig. 2	Fig. 3	Fig. 4
	4.5 mm Ø	5.5 mm Ø	6.5 mm Ø	7.5 mm Ø
36 mm – 1½"	ES 15-10-01	ES 15-10-02	ES 15-10-03	ES 15-10-04

Satz, für Erwachsene
Set, for adults







Richnau Holmgren ○ 1:1 ○ 1:1 ○ 1:1 ○ 1:1

	Fig. 0	Fig. 1	Fig. 2	Fig. 3
	3 mm Ø	4 mm Ø	5 mm Ø	6 mm Ø
	ES 15-15-01	ES 15-15-02	ES 15-15-03	ES 15-15-04





Ohrspekula : Ear specula
Spéculums auriculaires : Espéculos auriculares
Specoli auricolari



Gruber	 1:1	 1:1	 1:1	 1:1
	Fig. 1	Fig. 2	Fig. 3	Fig. 4
	a = 4.5 mm	a = 5.5 mm	a = 6.5 mm	a = 7.5 mm
	ES 15-20-01	ES 15-20-02	ES 15-20-03	ES 15-20-04







Satz für Erwachsene
Set for adults



Gruber	 1:1	 1:1	 1:1	 1:1
	Fig. 1	Fig. 2	Fig. 3	Fig. 4
	4.5 mm Ø	5.5 mm Ø	6.5 mm Ø	7.5 mm Ø
	ES 15-25-01	ES 15-25-02	ES 15-25-03	ES 15-25-04





Satz für Erwachsene
Set for adults



Zoller	 1:1	 1:1	 1:1	 1:1	 1:1	 1:1
	Fig. 1	Fig. 2	Fig. 3	Fig. 4	Fig. 5	Fig. 6
	5.5 x 6.5 mm	6.5 x 7.5 mm	7.5 x 8.5 mm	8.5 x 9.5 mm	9.5 x 10.5 mm	10.5 x 11.5 mm
	ES 15-30-01	ES 15-30-02	ES 15-30-03	ES 15-30-04	ES 15-30-05	ES 15-30-06

Satz für Erwachsene, schwarz
Set for adults, black







Politzer	 1:1	 1:1	 1:1	 1:1
	Fig. 1	Fig. 2	Fig. 3	Fig. 4
	2 mm Ø	3 mm Ø	4 mm Ø	5 mm Ø
	ES 15-35-01	ES 15-35-02	ES 15-35-03	ES 15-35-04

Satz für Erwachsene
Set for adults



Ohrspekula : Ear specula
Spéculums auriculaires : Espéculos auriculares
Specoli auricolari



Boucheron	 1:1	 1:1	 1:1	 1:1
	Fig. 1	Fig. 2	Fig. 3	Fig. 4
	4.5 mm Ø	5.5 mm Ø	6.5 mm Ø	7.5 mm Ø
	ES 15-40-01	ES 15-40-02	ES 15-40-03	ES 15-40-04





Satz für Erwachsene
Set for adults



Boucheron	 1:1	 1:1	 1:1
	Fig. 0	Fig. 1	Fig. 2
	3.0 mm Ø	4.5 mm Ø	5.5 mm Ø
	ES 15-45-01	ES 15-45-02	ES 15-45-03





Satz für Kinder
Set for children



Hartmann	 1:1	 1:1	 1:1	 1:1
	Fig. 1	Fig. 2	Fig. 3	Fig. 4
	4.5 mm Ø	5.5 mm Ø	6.5 mm Ø	7.5 mm Ø
	ES 15-50-01	ES 15-50-02	ES 15-50-03	ES 15-50-04

Satz für Erwachsene
Set for adults











Hartmann	 1:1	 1:1	 1:1	 1:1	 1:1
	Fig. 1	Fig. 2	Fig. 3	Fig. 4	Fig. 5
	2.0 mm Ø	3.5 mm Ø	5.0 mm Ø	6.5 mm Ø	7.5 mm Ø
	ES 15-55-01	ES 15-55-02	ES 15-55-03	ES 15-55-04	ES 15-55-05

Satz für Erwachsene, schwarz
Set for adults, black









Ohrküiretten : Ear currettes
Curettes auriculaires : Curetas auriculares
Curette auricolari



Buck



								
1:1	1:1	1:1	1:1	1:1	1:1	1:1	1:1	
Fig. 000	Fig. 00	Fig. 0	Fig. 1	Fig. 2	Fig. 3	Fig. 4	Fig. 5	
165mm-6 ¹ / ₂ "	EC 15-10-01	EC 15-10-02	EC 15-10-03	EC 15-10-04	EC 15-10-05	EC 15-10-06	EC 15-10-07	EC 15-10-08

stumpf
blunt
 mousse
 roma
 smussa

								
1:1	1:1	1:1	1:1	1:1	1:1	1:1	1:1	
Fig. 000	Fig. 00	Fig. 0	Fig. 1	Fig. 2	Fig. 3	Fig. 4	Fig. 5	
165mm-6 ¹ / ₂ "	EC 15-15-01	EC 15-15-02	EC 15-15-03	EC 15-15-04	EC 15-15-05	EC 15-15-06	EC 15-15-07	EC 15-15-08

scharf
sharp
 tranchante
 cortante
 tagliente

1:1









  **Abbildungen zeigen den Außendurchmesser.**
Pictures show the outer diameter.

Illustrations représentent le diamètre externe.
 Ilustraciones presentan el diametro externo. Le
 illustrazioni mostrano il diamentro esterno.









Ohrküretten : Ear cures
Curettes auriculaires : Curetas auriculares
Curette auricolari



Buck

								
1:1	1:1	1:1	1:1	1:1	1:1	1:1	1:1	
Fig. 000	Fig. 00	Fig. 0	Fig. 1	Fig. 2	Fig. 3	Fig. 4	Fig. 5	
165 mm–6 1/2"	EC 15-20-01	EC 15-20-02	EC 15-20-03	EC 15-20-04	EC 15-20-05	EC 15-20-06	EC 15-20-07	EC 15-20-08

gebogen, stumpf
curved, blunt
 courbe, tranchante
 curva, cortante
 curva, smussa

								
1:1	1:1	1:1	1:1	1:1	1:1	1:1	1:1	
Fig. 000	Fig. 00	Fig. 0	Fig. 1	Fig. 2	Fig. 3	Fig. 4	Fig. 5	
165 mm–6 1/2"	EC 15-25-01	EC 15-25-01	EC 15-25-01	EC 15-25-01	EC 15-25-01	EC 15-25-01	EC 15-25-01	EC 15-25-01

gebogen, scharf
curved sharp
 courbe, pointue
 curva, aguda
 curva, tagliente

1:1

Ohrküretten und scharfe Löffel
Ear cures and sharp spoons
Curettes auriculaires et cuillères tranchantes
Curetas y cucharillas auriculares cortantes
Curette auricolari e cucchiari taglienti



Langenbeck
 130 mm – 5"
 EC 15-30-01
 stumpf
 blunt



Jansen
 170 mm – 6³/₄"
 EC 15-35-01
 scharf
 sharp



Gross
 120 mm – 4³/₄"
 EC 15-40-01
 scharf, voll
 sharp, not fenestrated



Jansen
 120 mm – 4³/₄"
 EC 15-45-01
 stumpf, gefenstert
 blunt, fenestrated





Jansen
 160 mm – 6¹/₄"
 EC 15-50-01
 scharf
 sharp

Ohrschlingen – Hähchen
Ear loops – hooks
Anses – crochets auriculaires
Asas – ganchos auriculares
Anse – uncini auricolari





1:2

Billeau	 1:1	 1:1	 1:1
165 mm – 6½"	EH 15-10-01	EH 15-10-02	EH 15-10-03









1:2

Lucae	 1:1	 1:1	 1:1
140 mm – 5½"	EH 15-15-01	EH 15-15-02	EH 15-15-03



1:2

Wagener	 1:1	 1:1	 1:1	 1:1	 1:1	 1:1	 1:1
140 mm – 5½"	EH 15-20-01	EH 15-20-02	EH 15-20-03	EH 15-20-04	EH 15-20-05	EH 15-20-06	EH 15-20-07

Ohrhäkchen - Messer
Ear hooks - knives
Crochets - couteaux auriculaires
Ganchos - cuchillos auriculares
Uncini - coltelli auricolari

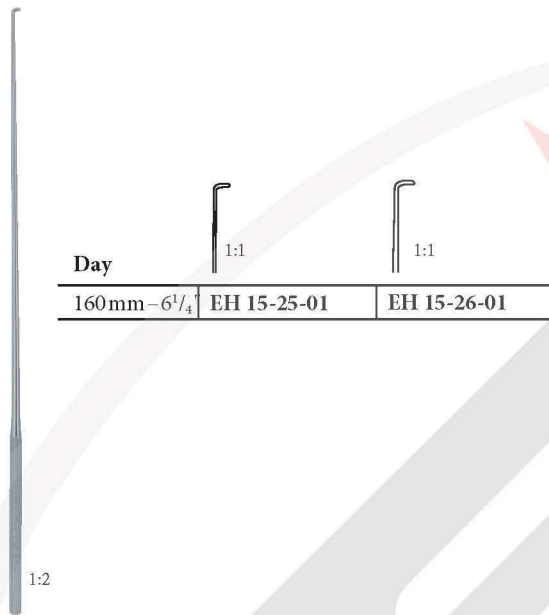

Muck
 135 mm - 5¹/₄" | EH 15-30-01



Gerzog-sexton
 170 mm - 6³/₄" | EH 15-35-01

Parazentesenadeln
Paracentesis needles
Aiguilles de paracentèse
Agujas para paracentesis
Aghi per paracentesi

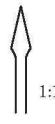

1:1
Politzer
 150 mm - 6"
 PN 15-10-01



1:1
Gerzog
 160 mm - 6 1/4"
 PN 15-15-01



1:1
Buck
 160 mm - 6 1/4"
 PN 15-20-01



1:2
Lucae
 180 mm - 7" | PN 15-25-01 | PN 15-26-01



1:2
Lucae
 190 mm - 7 1/2"
 PN 15-30-01



1:2
Politzer
 170 mm - 6 3/4"
 PN 15-35-01



1:2
Politzer
 160 mm - 6 1/4" | PN 15-40-01 | 160 mm - 6 1/4" | PN 15-45-01



Nadel senkrecht | **Nadel waagrecht**
Needle vertical | **Needle horizontal**

Ohrpolypenschnürer
Ear polypus snares
Serre noeuds auriculaires
Polipótomos auriculares
Serranodi auricolari



	10 m - 33 ft.
0.3 mm Ø	EP 15-10-01
0.4 mm Ø	EP 15-10-02



0.2 mm Ø x 75 mm	EP 15-15-01
0.3 mm Ø x 100 mm	EP 15-15-02

in Bündeln mit 12 Stück
in bundles of 12 pieces



Krause 1:2
 160 mm - 6¹/₄" **EP 15-100-01**



Krause-Voss 1:2
 160 mm - 6¹/₄" **EP 15-105-01**



Lange-Wilde 1:2
 170 mm - 6³/₄" **EP 15-110-01**

Ohrpolypenzangen : Ear polypus forceps
Pinces pour polypes auriculaires : Pinzas para pólipos auriculares
Pinze per polipi auricolari

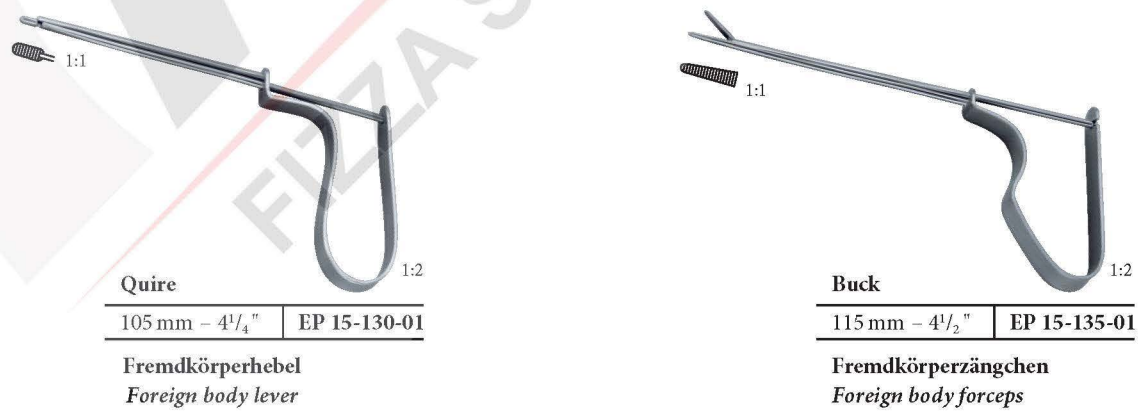
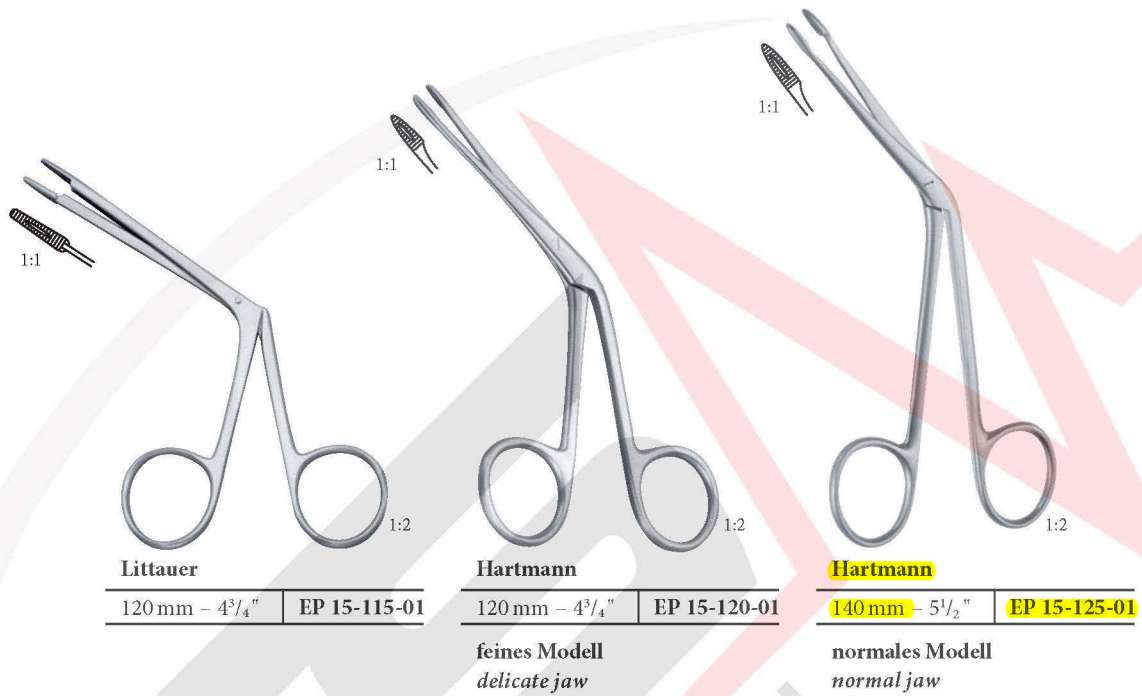

Ohrzängchen : Ear forceps
Pincés auriculaires : Pinzas auriculares
Pinze auricolari



Hartmann-Wullstein

x = 85 mm - 3 1/4"	EF 15-100-01
--------------------	--------------



Hartmann-Wullstein

	1 mm Ø
x = 85 mm - 3 1/4"	EF 15-105-01



Hartmann

x = 85 mm - 3 1/4"	EF 15-110-01
x = 140 mm - 5 1/2"	EF 15-110-02
x = 160 mm - 6 1/4"	EF 15-110-03



Haetmann

x = 85 mm - 3 1/4"	EF 15-115-01
x = 140 mm - 5 1/2"	EF 15-115-01

1x2

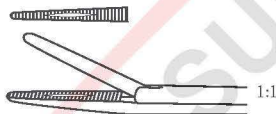

Hartmann-Noyes

x = 90 mm - 3 1/2"	EF 15-120-01
--------------------	--------------

Struempel



x = 85 mm - 3 1/4"	
0°	EF 15-125-01



45°	EF 15-125-02
-----	--------------



90°	EF 15-125-03
-----	--------------



Hartmann-Weingartner

x = 85 mm - 3 1/4"	EF 15-130-01
--------------------	--------------



Hartmann

x = 85 mm - 3 1/4"	
2.0 mm Ø	EF 15-135-01
2.5 mm Ø	EF 15-135-02
3.0 mm Ø	EF 15-135-03

Ohrzängchen : Ear forceps
Pinces auriculaires : Pinzas auriculares
Pinze auricolari



Hartmann

4x0,4 mm, 80 mm	EF 15-140-01
4x0,5 mm, 80 mm	EF 15-140-02



SURGERY HNO – ENT

Mikro-Ohrzängchen : *Micro ear forceps*
 Micro pinces auriculaires : *Micro-pinzas auriculares*
 Micro-pinze auricolari



McGee



3.5 mm x 0.8 mm | EF 15-145-01

Drahtbiegezängchen
Wire bending forceps

Fuller



80 mm – 3 1/4" | EF 15-150-01

Einführungszängchen für Teflonprothesen
Introducing forceps for teflon prosthesis

Dieter

x = 80 mm – 3 1/4"



EF 15-155-01

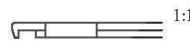

EF 15-155-02

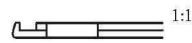

EF 15-155-03

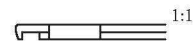

EF 15-155-04

Hammerkopffzängchen
Malleus nipper

oben schneidend



unten schneidend
down-cutting



rechts schneidend
right-cutting

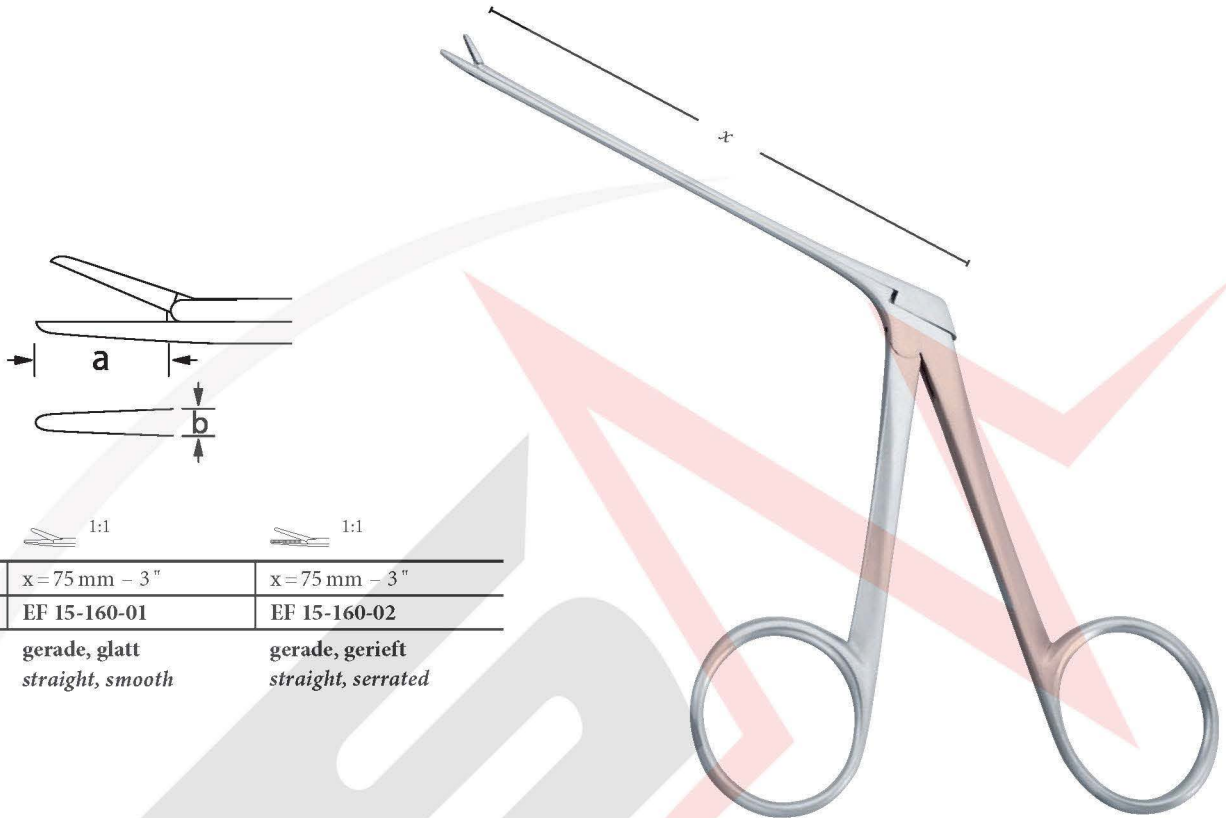

links schneidend

Mikro-Ohrzängchen : Micro ear forceps
Micro pinces auriculaires : Micro-pinzas auriculares
Micro-pinze auricolari



Mini McGee		 1:1	 1:1
a x b	x = 75 mm – 3"	x = 75 mm – 3"	x = 75 mm – 3"
3.5 mm x 0.6 mm	EF 15-160-01	EF 15-160-02	
	gerade, glatt <i>straight, smooth</i>	gerade, gerieft <i>straight, serrated</i>	

	 1:1	 1:1	 1:1
a x b	x = 75 mm – 3"	x = 75 mm – 3"	x = 75 mm – 3"
3.5 mm x 0.6 mm	EF 15-161-01	EF 15-161-02	EF 15-161-03
4.0 mm x 0.8 mm	EF 15-162-01	EF 15-162-02	EF 15-162-03
	gerade, glatt <i>straight, smooth</i>	gerade, gerieft <i>straight, serrated</i>	aufgebogen, gerieft <i>curved upwards, serrated</i>

	 1:1	 1:1	 1:1
a x b	x = 75 mm – 3"	x = 75 mm – 3"	x = 75 mm – 3"
3.5 mm x 0.6 mm	EF 15-163-01	EF 15-163-02	EF 15-163-03
4.0 mm x 0.8 mm	EF 15-164-01	EF 15-164-02	EF 15-164-03
	rechts gebogen, gerieft <i>curved to right, serrated</i>	links gebogen, gerieft <i>curved to left, serrated</i>	abwärts gebogen, gerieft <i>angled down, serrated</i>

Mikro-Löffelzängchen : *Micro cup forceps*

Micro pinces auriculaires à cuillère : Micro-pinzas auriculares a cucharilla

Micro-pinze auricolari a cucchiaio

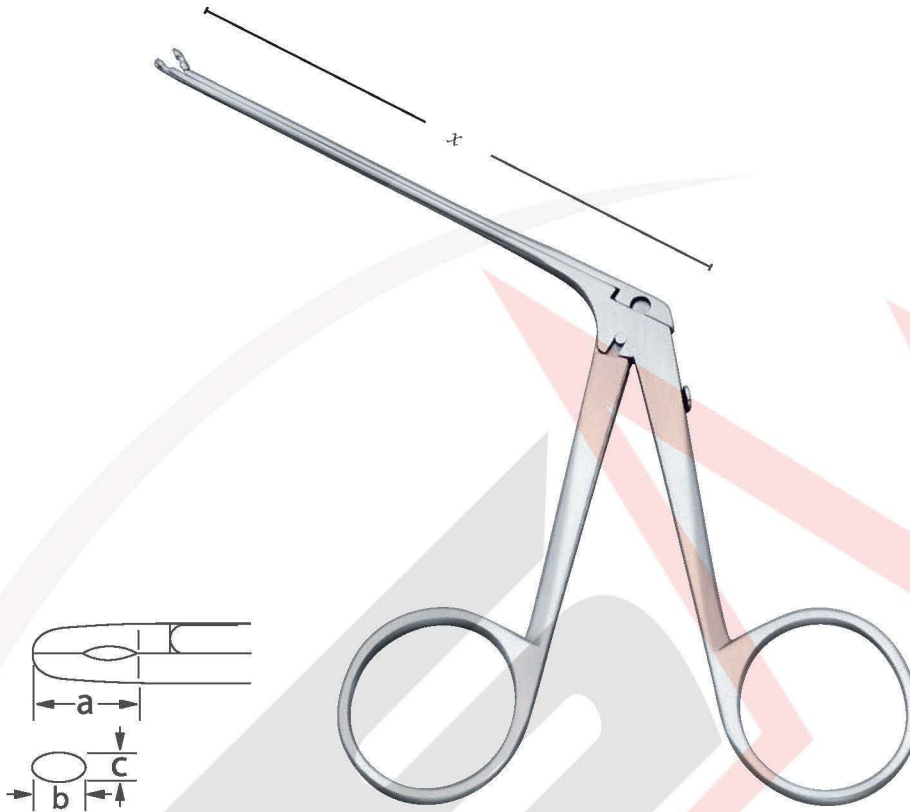

	x = 75 mm - 3"	x = 75 mm - 3"	x = 75 mm - 3"
a=4.0mm b=1.0mm x c=0.9	EF 15-165-01	EF 15-165-02	EF 15-165-03

mm	gerade, oval <i>straight, oval</i>	aufgebogen, oval <i>curved upwards, oval</i>	links gebogen, oval <i>curved to left, oval</i>
----	---------------------------------------	---	--



	x = 75 mm - 3"	x = 75 mm - 3"
a=4.0mm b=1.0mm x c=0.9	EF 15-166-01	EF 15-166-02





mm	rechts gebogen, oval <i>curved to right, oval</i>	abwärts gebogen, oval <i>curved downwards, oval</i>
----	--	--

Mikro-Löffelzängchen : *Micro cup forceps*

Micro pinces auriculaires à cuillère : Micro-pinzas auriculares a cucharilla



Micro-pinze auricolari a cucchiaio

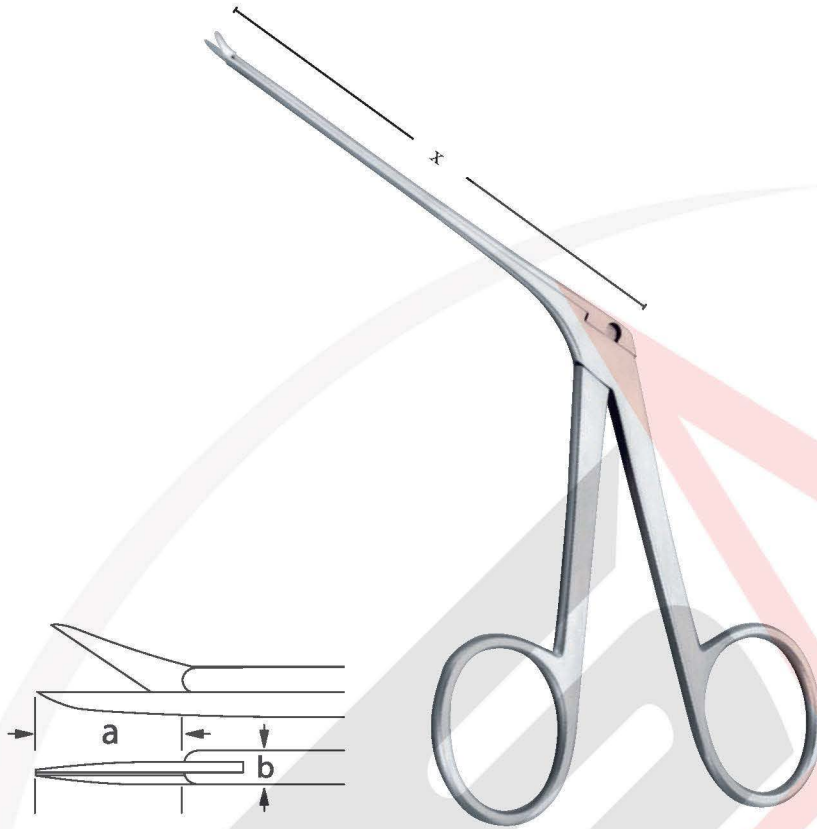

	1:1		1:1
	x = 80 mm - 3 ¹ / ₄ "		x = 80 mm - 3 ¹ / ₄ "
a = 3.5 mm b = 0.6 mm x c = 0.5 mm	EF 15-170-01		EF 15-170-02
a = 4.0 mm b = 1.0 mm x c = 0.9 mm	EF 15-171-01		EF 15-171-02
	gerade, oval straight, oval		aufgebogen, oval curved upwards, oval
	1:1		1:1
	x = 80 mm - 3 ¹ / ₄ "		x = 80 mm - 3 ¹ / ₄ "
a = 3.5 mm b = 0.6 mm x c = 0.5 mm	EF 15-175-01		EF 15-175-02
a = 4.0 mm b = 1.0 mm x c = 0.9 mm	EF 15-176-01		EF 15-176-02
	rechts gebogen, oval curved to right, oval		aufgebogen, oval curved to left, oval

Mikro-Ohrscheren : Micro ear scissors
Micro ciseaux auriculaires : Micro-tijeras para oídos
Micro-forbici auricolari



Belucci		Belucci	
	 1:1	 1:1	
a x b	x = 75 mm – 3"	x = 75 mm – 3"	
4.0 mm x 0.8 mm	EF 15-180-01	EF 15-180-02	
sehr fein very fine	gerade, spitz/spitz straight, sharp/sharp	aufgebogen, stumpf/stumpf curved upwards, blunt/blunt	

	 1:1	 1:1	
a x b	x = 75 mm – 3"	x = 75 mm – 3"	
4.0 mm x 0.8 mm	EF 15-181-01	EF 15-181-02	
sehr fein very fine	rechts gebogen, spitz/spitz curved to right, sharp/sharp	links gebogen, spitz/spitz curved to left, sharp/sharp	



	 1:1	
	x = 75 mm – 3"	
4.0 mm x 0.8 mm	EF 15-181-03	
sehr fein very fine	gerade, spitz/stumpf straight, sharp/blunt	

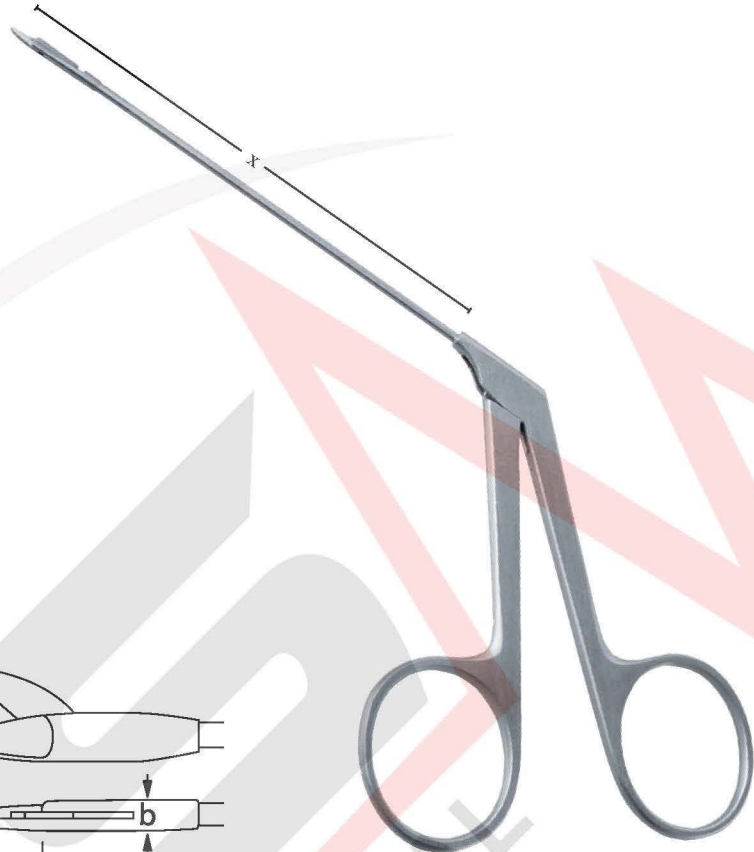

Mikro-Ohrscheren : *Micro ear scissors*

Micro ciseaux auriculaires : *Micro-tijeras para oidos*

Micro-forbici auricolari



Wullstein	 1:1	 1:1
a x b	x = 80 mm - 3 ¹ / ₄ "	x = 80 mm - 3 ¹ / ₄ "
4.0 mm x 0.8 mm	ES 15-185-01	ES 15-185-02
	gerade, spitz/spitz <i>straight, sharp/sharp</i>	aufgebogen, spitz/spitz <i>curved upwards, sharp/sharp</i>

Wullstein	 1:1	 1:1
a x b	x = 80 mm - 3 ¹ / ₄ "	x = 80 mm - 3 ¹ / ₄ "
4.0 mm x 0.8 mm	ES 15-186-01	ES 15-186-02
	rechts gebogen, spitz/spitz <i>curved to right, sharp/sharp</i>	links gebogen, spitz/spitz <i>curved to left, sharp/sharp</i>

Ohr Mikro-Raspatorien und Sonden : *Micro ear-raspatories and probes*
Micro-raspatori e sonde auricolari

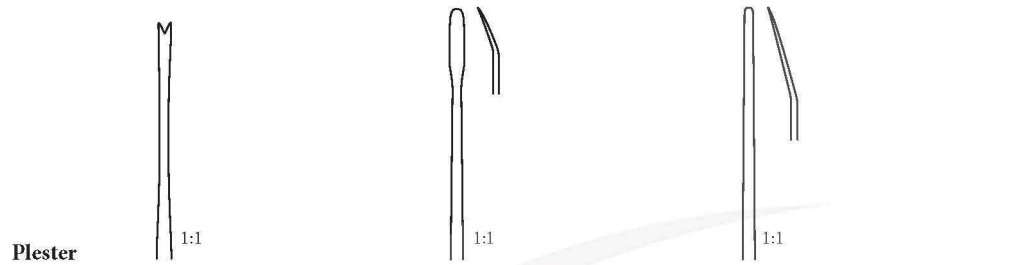

Plester			
160 mm – 6 ¹ / ₄ "	EP15-190-01	EP 15-190-02	EP 15-190-03
	Führungsgabel <i>Wire guide</i>	Raspatorium <i>Raspatory</i>	Elevatorium <i>Elevator</i>

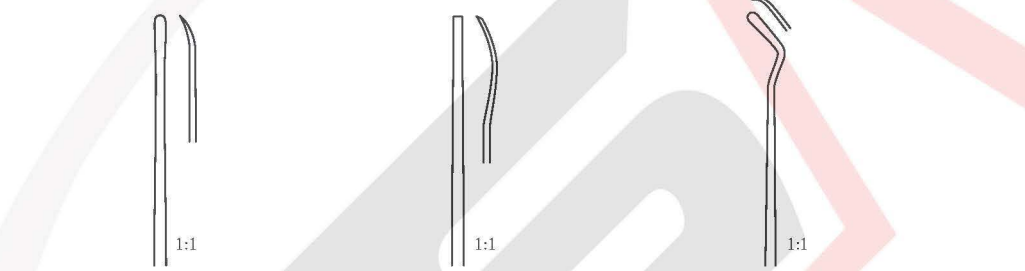

	1.8 mm	1.0 mm	
160 mm – 6 ¹ / ₄ "	EP 15-195-01	EP 15-195-02	EP 15-195-03
	Raspatorium <i>Raspatory</i>	Raspatorium <i>Raspatory</i>	Dissektor, doppelt links gebogen <i>Dissector, double curved left</i>

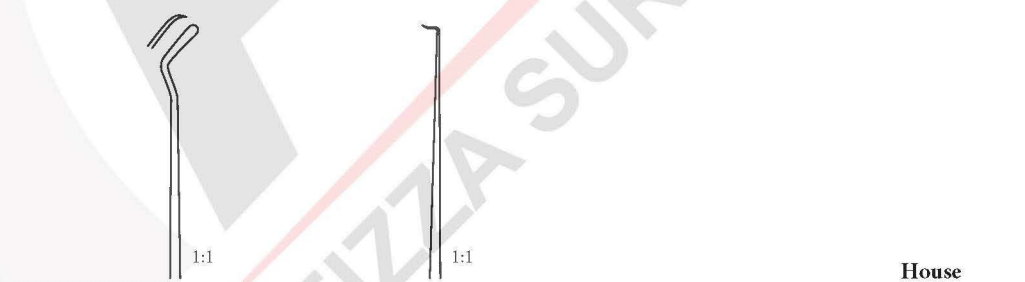

160 mm – 6 ¹ / ₄ "	EP 15-200-01	EP 15-200-02
	Dissektor, doppelt rechts gebogen <i>Dissector, double curved right</i>	Handinstrument zum Andrücken von Drahtprothesen <i>Instrument for placing wire prothesis</i>





House	
	160 mm – 6 ¹ / ₄ "
3.5 mm	EP 15-205-01
4.0 mm	EP 15-205-02
4.5 mm	EP 15-205-03
5.0 mm	EP 15-205-04

Messsonde
Measuring rod





Ohrsichelmesser – Rundschnittmesser
Ear sickleknives – Circular cutting knife
Couteaux faucilles – Couteaux ronds
Cuchillos en forma de hoz – Cuchillos redondos
Coltelli auricolari







Rosen

			
1:1	1:1	1:1	1:1
1.5 mm Ø – 90°	45°	45°	
160 mm – 6 1/4"	EK 15-210-01	EK 15-210-02	EK 15-210-03
Rundschnittmesser <i>Circular cutting</i>	Trommelfellmesse <i>r Tympanum knife</i>	Lanzenmesser <i>Lancet knife</i>	Lanzenmesser <i>Lancet knife</i>

Schuknecht

			
1:1	1:1	1:1	1:1
160 mm – 6 1/4"	EK 15-215-01	EK 15-215-02	EK 15-220-01
Rollermesser, parallel <i>Roller knife, parallel</i>	Rollermesser, rechtwinklig <i>Roller knife, right angled</i>	Sichelmesser, leicht gebogen <i>Sickle knife, slightly curved</i>	Diszisionsmesser, gerade <i>Discision knife, straight</i>

Plester

			
1:1	1:1	1:1	1:1
160 mm – 6 1/4"	EK 15-225-01	45°	160 mm – 6 1/4"
Lappenmesser <i>Flap knife</i>		3.0 mm Ø	EK 15-230-01
		2.6 mm Ø	EK 15-230-02
		2.0 mm Ø	EK 15-230-03
		1.5 mm Ø	EK 15-230-04
		1.0 mm Ø	EK 15-230-05
			Rundschnittmesser <i>Circular cutting Knife</i>

Zollner

	1 mm	1 mm
160 mm – 6 1/4"	EK 15-235-01	EK 15-235-02
	Raspatorium <i>Raspatory</i>	Raspatorium <i>Raspatory</i>

Mikro-Ohrinstrumente : Instruments for micro ear-surgery
Instrumentes pour la micro-chirurgie auriculaire
Instrumentos para la micro-cirugia auricular
Strumenti per micro-chirurgia auricolare



1:1

Zöllner

90°

EM 15-240-01

Rundschnittmesser, nach oben gebogen
Round knife, angled up



1:1

90°

EM 15-240-02

Rundschnittmesser, nach unten gebogen
Round knife, angled down



1:1

EM 15-240-03

Sichelmesser, nach oben gebogen
Sickle knife, angled up



1:1

EM 15-240-04

Sichelmesser, nach unten gebogen
Sickle knife, angled down



1:1

EM 15-240-05

Lanzenmesser, links gebogen
Lancet knife, curved to left



1:1

EM 15-240-06

Lanzenmesser, rechts gebogen
Lancet knife, curved to right



1:1

EM 15-240-07

Raspatorium, links gebogen
Raspatory, curved to left



1:1

EM 15-240-08

Raspatorium, rechts gebogen
Raspatory, curved to right



1:1

EM 15-240-09

Führungsgabel
Wire guide

Mikro-Ohrinstrumente
Instruments for micro ear-surgery
Instrumentos para la micro-chirurgie auriculaire
Instrumentos para la micro-cirugía auricular
Strumenti per micro-chirurgia auricolare

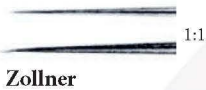

Zollner



EM 15-245-01	EM 15-245-02	EM 15-245-03
--------------	--------------	--------------

Nadel fein, gerade, spitz
Needle fine, straight, sharp

Häkchen, nach oben gebogen
Hook, angled up

Häkchen, nach unten gebogen
Hook, angled down



EM 15-245-04	EM 15-245-05	EM 15-245-06
--------------	--------------	--------------

Häkchen, nach oben gebogen
Hook, angled up

Häkchen, nach unten gebogen
Hook, angled down

Häkchen, nach oben gebogen
Hook, angled up



EM 15-245-07	EM 15-245-08	EM 15-245-09
--------------	--------------	--------------

Häkchen, nach unten gebogen
Hook, angled down

Häkchen, rund nach oben gebogen
Hook, curved up

Häkchen, rund nach unten gebogen
Hook, curved down

Stimmgabeln : Tuning forks

Diapasons : Diapasones

Diapasoni



Lucae

c 128

TF 15-250-01

verschiebbar bis h
variable up to h (engl. b)

Rydel-Seiffer

C64 / c 128

TF15-255-01

mit Dämpfer C64, ohne Dämpfer c 128
with clamps C64, without clamps c 128

French

C₂16

TF 15-260-01

C₁32

TF 15-261-01

Stimmgabeln : Tuning forks

Diapasons : Diapasones

Diapasoni



Hartmann

C 64	c 128	c ¹ 256	a ¹ 440
TF 15-265-01	TF 15-265-02	TF 15-265-03	TF 15-270-01

Lärmtrommel	Assourdiseur
Noise drum	Aparato de ruido
	Assordatore



Barany

ND 15-275-01

Stimmgabeln : Tuning forks

Diapasons : Diapasones

Diapasoni



Hartmann

c 128	c ¹ 256	c ² 512	c ³ 1024	c ⁴ 2048	C ⁵ 4096
TF 15-280-01	TF 15-280-02	TF 15-280-03	TF 15-280-04	TF 15-280-05	TF 15-280-06

Stimmgabeln : Tuning forks

Diapasons : Diapasones

Diapasoni



SURGERY HNO – ENT

Mikro-Ohrnadeln und Häkchen : *Micro ear-needles and hooks*
Micro-aiguilles et crochets auriculaires : Micro-agujas y ganchos auriculares
Micro-uncini ed aghi auricolari



160 mm – 6 ¹ / ₄ "
MN 15-290-01

Nadel fein, gerade, spitz
Needle fine, straight, sharp



160 mm – 6 ¹ / ₄ "
MN 15-290-02

Nadel, leicht gebogen, spitz
Needle, slightly curved, sharp



160 mm – 6 ¹ / ₄ "
MN 15-290-03

Nadel, stark gebogen, spitz
Needle, strong curved, sharp

Shambaugh



	160 mm – 6 ¹ / ₄ "	160 mm – 6 ¹ / ₄ "
	45°	90°
0.4 mm	MH 15-295-01	MH 15-296-01
0.6 mm	MH 15-295-02	MH 15-296-02
0.8 mm	MH 15-295-03	MH 15-296-03
1.0 mm	MH 15-295-04	MH 15-296-04

Häkchen, abgewinkelt
Hook, angled



	160 mm – 6 ¹ / ₄ "
1.0 mm	MH 15-300-01
2.5 mm	MH 15-300-02

Häkchen, retrograd gebogen
Hook, retrograd



	0.6 mm
160 mm – 6 ¹ / ₄ "	MH 15-301-01

Häkchen, retrograd gebogen
Hook, retrograd

1:1



Plester	
0.4 mm – 90°	MH 15-305-01

Fussplattenhäkchen, abgewinkelt, stumpf
Foot plate hook, angled, blunt



Plester	
0.4 mm – 45°	MH 15-310-01

Antrum Häkchen, aufgewinkelt, stumpf
Antrum hook, angled, blunt

Barbara



MH 15-315-01	MH 15-315-02	MH 15-315-03
---------------------	---------------------	---------------------

spitz/gerade **stumpf/gewinkelt** **spitz/gebogen**
sharp/straight *blunt/angled* *sharp/curved*

SURGERY HNO – ENT

Mikro-Ohrnadeln und Häkchen : Micro ear-needles and hooks
Micro-aiguilles et crochets auriculaires : Micro-agujas y ganchos auriculares
Micro-uncini ed aghi auricolari

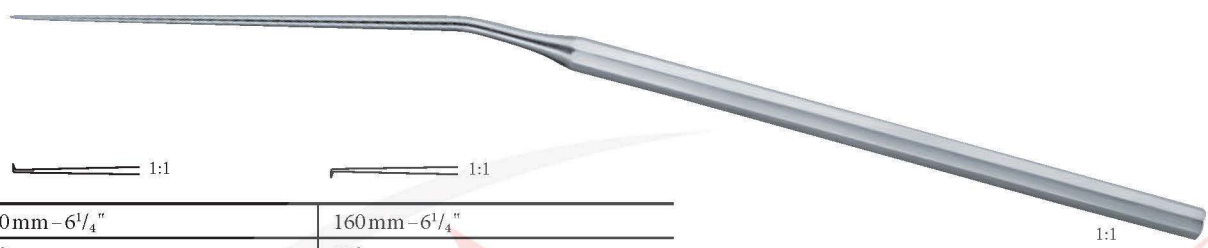

Shambaugh

	160mm – 6 ¹ / ₄ "	160mm – 6 ¹ / ₄ "
	90°	90°
0.3 mm	MH 15-320-01	MH 15-321-01
0.6 mm	MH 15-320-02	MH 15-321-02
1.0 mm	MH 15-320-03	MH 15-321-03

Häkchen, nach oben gebogen
Hook, curved up

Häkchen, nach unten gebogen
Hook, curved down

McGee

	160mm – 6 ¹ / ₄ "	160mm – 6 ¹ / ₄ "
0.5 mm	MH 15-325-01	MH 15-330-01
1.0 mm	MH 15-325-02	MH 15-330-02

Häkchen, rund, nach oben gebogen
Hook, round, curved up

Häkchen, rund, nach unten gebogen
Hook, round, curved down

Barbara

	0.5 mm
155 mm – 6"	MH 15-335-01

Rosen

	0.5 mm
160 mm – 6 ¹ / ₄ "	MN 15-340-01

Nadel, leicht gebogen
Needle, slightly curved

McGee

	160mm – 6 ¹ / ₄ "	160mm – 6 ¹ / ₄ "	160mm – 6 ¹ / ₄ "	160mm – 6 ¹ / ₄ "
	25°	25°	45°	45°
0.3 mm	MH 15-345-01	MH 15-346-01	MH 15-347-01	MH 15-348-01
0.6 mm	MH 15-345-01	MH 15-346-02	MH 15-347-02	MH 15-348-02
1.0 mm	MH 15-345-01	MH 15-346-03	MH 15-347-03	MH 15-348-03

Häkchen, nach oben gebogen
Hook, curved up





Häkchen, nach unten gebogen
Hook, curved down

Häkchen, nach oben gebogen
Hook, curved up

Häkchen, nach unten gebogen
Hook, curved down

Mikro-hrraspatorien : Micro ear-raspatories
Micro-raspateurs auriculaires : Micro-raspatorias auriculares
Micro-raspatori auricolari



Fisch	 1:1	 1:1	 1:1	 1:1
	155 mm - 6"	155 mm - 6"	155 mm - 6"	155 mm - 6"
	ER 15-10-01	ER 15-10-02	ER 15-10-03	ER 15-10-04
	rechts abgewinkelt <i>angled to the right</i>	links abgewinkelt <i>angled to the left</i>	rechts abgewinkelt <i>angled to the right</i>	links abgewinkelt <i>angled to the left</i>

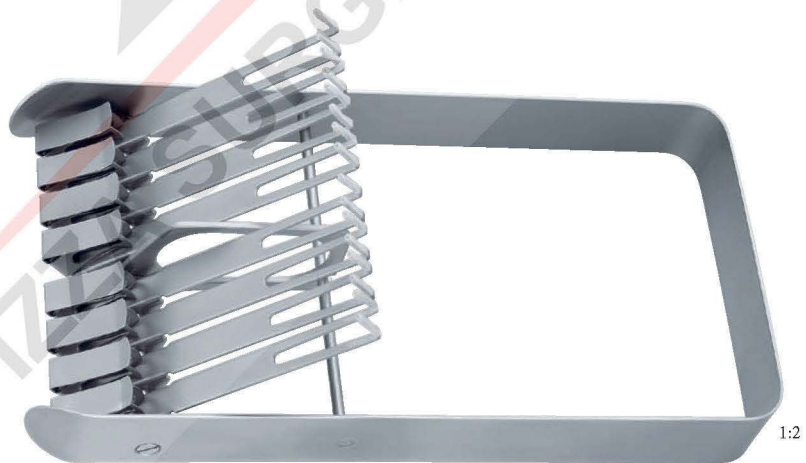

ER 15-15-01

Rack für 8 Mikro-Ohr-Instrumente mit Sechs- oder Achtkantgriff
 Rack for 8 each micro ear instruments with hexagonal or octagonal handle

Mikro-Ohröffel : Micro ear-spoons
Micro-curettes auriculaires : Micro-curetas auriculares
Micro-cucchiai auricolari



House
 170 mm – 6³/₄" | MS 15-20-01

Löffel, stark gebogen
Spoon, strong curved

170 mm – 6³/₄" | MS 15-25-01

Löffel, leicht gebogen
Spoon, slightly curves



Shea

1:1

	1.5 mm x 2.5 mm	1.5 mm x 2.5 mm
160mm – 6 ¹ / ₄ "	MS 15-30-01	MS 15-35-01

gerade
straight



1:1

gebogen
curved



Mikro-Ohrlöffel : Micro ear-spoons
Micro-curettes auriculaires : Micro-curetas auriculares
Micro-cucchiai auricolari



Sinus spoon
 190mm – 7¹/₂" | **MS 15-33-01**
 9,5x4 mm angular bend, elongated

Sinus spoon
 190mm – 7¹/₂" | **MS 15-34-01**
 6x3 mm forehead spoon, hard curved,



House	 1:1	 1:1
	1.0 mm Ø und 1.2 mm Ø	1.5 mm Ø und 1.8 mm Ø
150 mm – 6"	MS 15-45-01	MS 15-50-01
	Löffel, leicht gebogen <i>Spoon, slightly curved</i>	Löffel, leicht gebogen <i>Spoon, slightly curves</i>

1:1

House	 1:1	 1:1
	1.0 mm Ø und 1.2 mm Ø	1.5 mm Ø und 1.8 mm Ø
150 mm – 6"	MS 15-35-01	MS 15-40-01
	Löffel stark gebogen <i>Spoon strong curved</i>	Löffel stark gebogen <i>Spoon strong curves</i>



1:1

Mikro-Ohrmeissel und Hämmer : *Micro ear-chisels and hammers*
Micro burins et marteaux auriculaires : Micro cincels y martillos para orejas
Micro scalpelli e martelli per orecchio

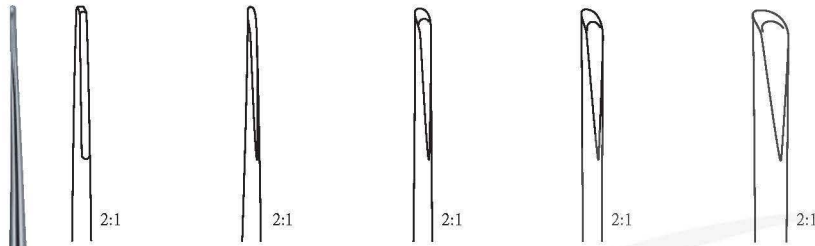

Heermann

0.7 mm	0.7 mm	1.0 mm	1.5 mm	3.0 mm
MS 15-55-01	MS 15-55-02	MS 15-55-03	MS 15-55-04	MS 15-55-05
Flachmeissel	Hohlmeissel	Hohlmeissel	Hohlmeissel	Hohlmeissel



1:1



Heermann
MS 15-60-01



1:2

Heermann

195 mm – 7 ³ / ₄ "	MC 15-65-01
--	-------------

Hammer, Metall
Metal hammer



1:2

Cottle

	250 g
190 mm – 7 ¹ / ₂ "	MH 15-70-01

Hammer, Metall
Metal hammer

Ohr raspatorien : Ear-raspatories
Raspateurs auriculaires : Raspatorias auriculares
Raspatori auricolari



Wullstein

160mm – 6 1/4"	ER 15-20-01	ER 15-21-01
----------------	-------------	-------------

gerade <i>straight</i>	gebogen <i>curved</i>
----------------------------------	---------------------------------



Rosen

	2.5 mm	1.5 mm
--	--------	--------

175 mm – 7"	ER 15-25-01	ER 15-30-01
-------------	-------------	-------------

bajonettförmig <i>bayonet shaped</i>	bajonettförmig <i>bayonet shaped</i>
--	--

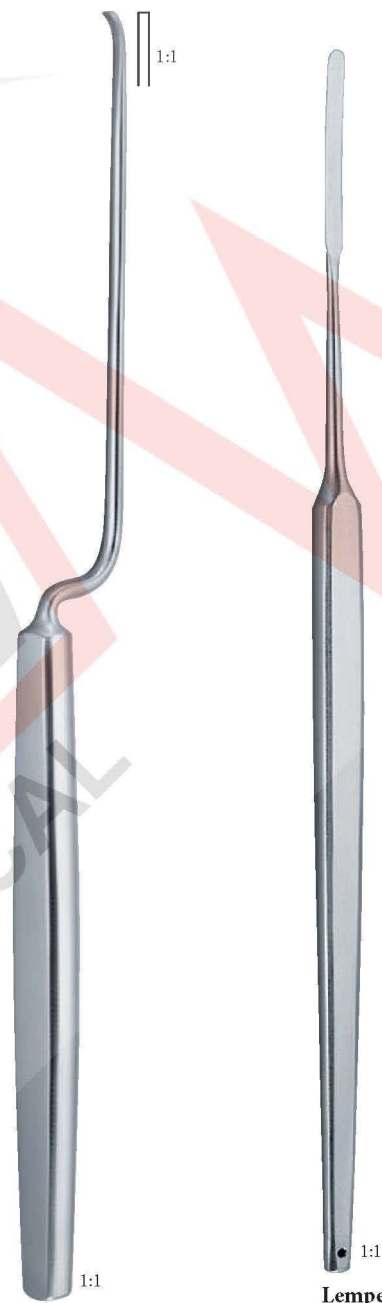

Lempert

ER 15-35-01

160mm – 6 1/4"
3.0 mm

SURGERY HNO – ENT

Ohr-Knochenstanzen : *Bone-rongeurs*

Rongeurs auriculaires : *Pinzas osteótomos auriculares*





Conchotomi auricolari



Citelli

x = 60 mm	170 mm – 6 ³ / ₄ ”
 1.5 mm	BR 15-10-01
 2.2 mm	BR 15-10-02
 3.0 mm	BR 15-10-03



Kerrison				
200 mm – 8”	3 x 3 mm	4 x 4 mm	5 x 5 mm	6 x 6 mm
x = 80 mm	BR 15-15-01	BR 15-15-02	BR 15-15-03	BR 15-15-04

SURGERY HNO – ENT

Ohr-Knochenstanzen : *Bone-rongeurs*

Rongeurs auriculaires : Pinzas osteótomos auriculares

Conchotomi auricolari

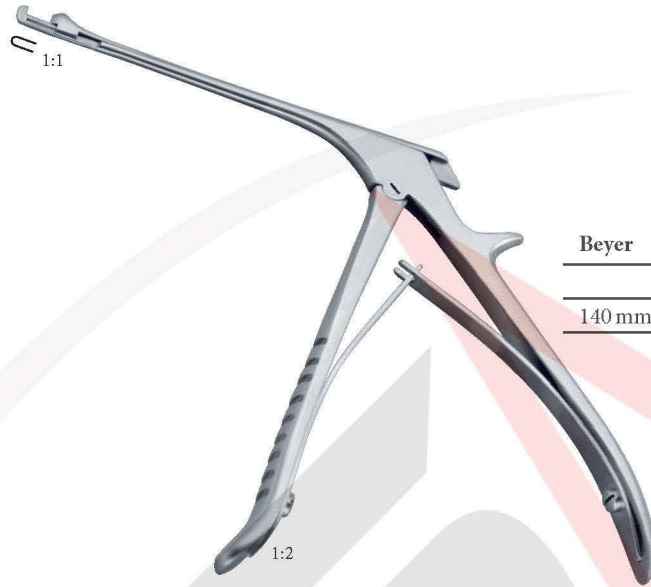

Beyer

	1 mm
140 mm – 5 ¹ / ₂ "	BR 15-20-01



Beyer

	2 mm
190 mm – 7 ¹ / ₂ "	BR 15-25-01

Bohrer : Burrs
Fraises : Brocas
Perforatori

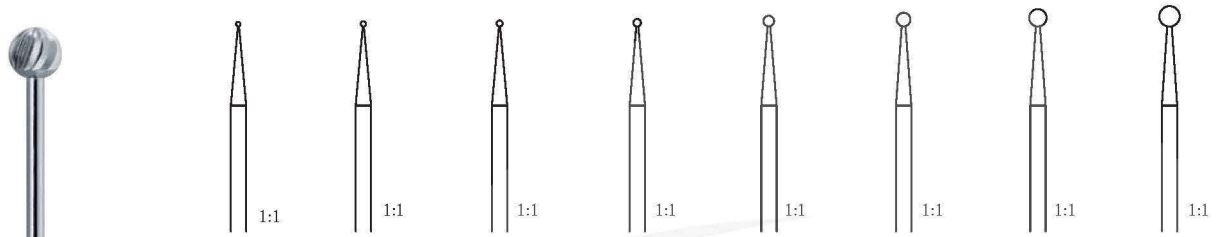

Rosen-Bohrer

	0.6 mm Ø	0.7 mm Ø	0.8 mm Ø	1.0 mm Ø	1.4 mm Ø	1.8 mm Ø	2.3 mm Ø	2.7 mm Ø
70 mm – 2 ³ / ₄ "	EB 15-10-01	EB 15-10-02	EB 15-10-03	EB 15-10-04	EB 15-10-05	EB 15-10-06	EB 15-10-07	EB 15-10-08

„Rosen“-Bohrer, 70 mm lang, Schaft-Ø 2.35 mm, rostfrei
 “Rosen” burrs, 70 mm long, shank diameter 2.35 mm, stainless

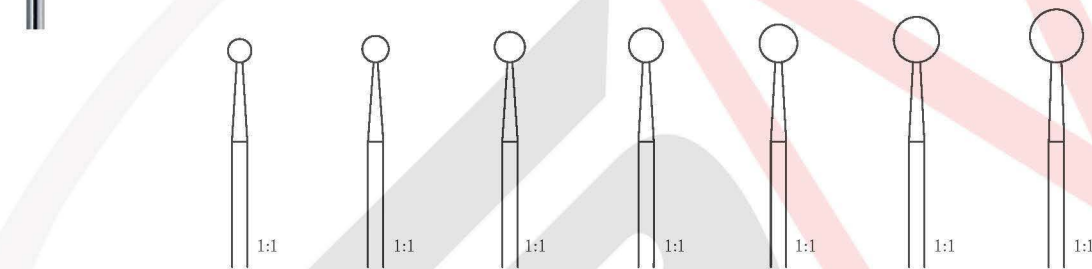

	3.1 mm Ø	3.5 mm Ø	4.0 mm Ø	4.5 mm Ø	5.0 mm Ø	6.0 mm Ø	7.0 mm Ø
70 mm – 2 ³ / ₄ "	EB 15-10-09	EB 15-10-10	EB 15-10-11	EB 15-10-12	EB 15-10-13	EB 15-10-14	EB 15-10-15

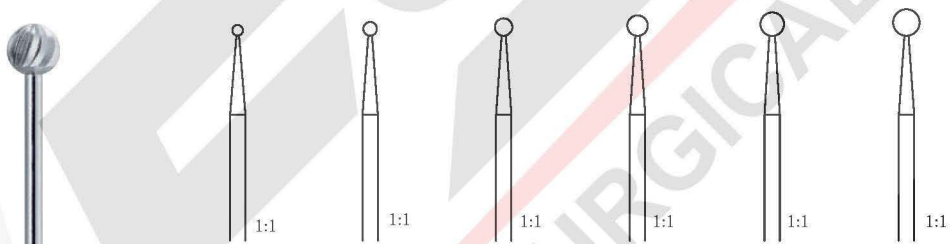

Rosen-Bohrer

	1.4 mm Ø	1.8 mm Ø	2.3 mm Ø	2.7 mm Ø	3.1 mm Ø	3.5 mm Ø
95 mm – 3 ³ / ₄ "	EB 15-15-01	EB 15-15-02	EB 15-15-03	EB 15-15-04	EB 15-15-05	EB 15-15-06

„Rosen“-Bohrer, 95 mm lang, Schaft-Ø 2.35 mm, rostfrei
 “Rosen” burrs, 95 mm long, shank diameter 2.35 mm, stainless

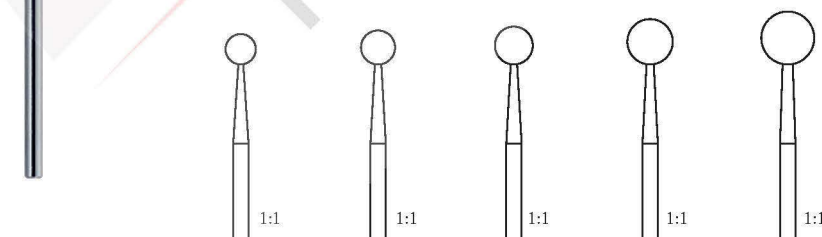

	4.0 mm Ø	4.5 mm Ø	5.0 mm Ø	6.0 mm Ø	7.0 mm Ø
95 mm – 3 ³ / ₄ "	EB 15-15-07	EB 15-15-08	EB 15-15-09	EB 15-15-10	EB 15-15-11

Bohrer : Burrs

Fraises : Brocas

Perforatori

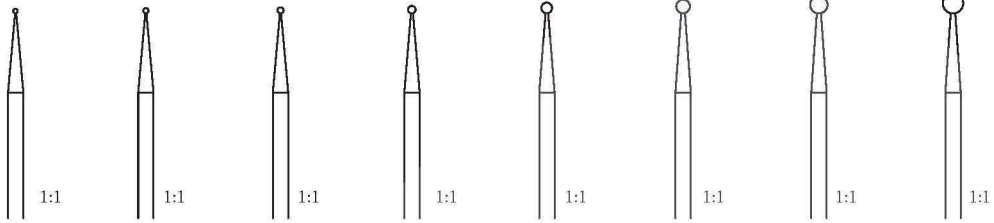

Diamant bohrer

	0.6 mm Ø	0.7 mm Ø	0.8 mm Ø	1.0 mm Ø	1.5 mm Ø	1.8 mm Ø	2.3 mm Ø	2.7 mm Ø
70 mm – 2 ³ / ₄ "	EB 15-20-01	EB 15-20-02	EB 15-20-03	EB 15-20-04	EB 15-20-05	EB 15-20-06	EB 15-20-07	EB 15-20-08

Diamantbohrer, 70mm lang, Schaft-Ø 2.35 mm

Diamond dust polishing burrs, 70 mm long, shank diameter 2.35 mm

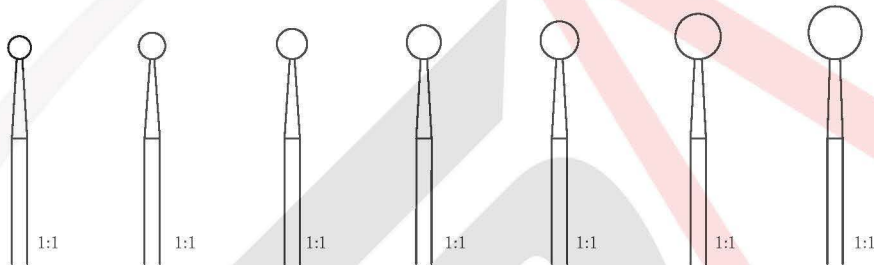

	3.0 mm Ø	3.5 mm Ø	4.0 mm Ø	4.5 mm Ø	5.0 mm Ø	6.0 mm Ø	7.0 mm Ø
70 mm – 2 ³ / ₄ "	EB 15-20-10	EB 15-20-11	EB 15-20-12	EB 15-20-13	EB 15-20-14	EB 15-20-15	EB 15-20-16

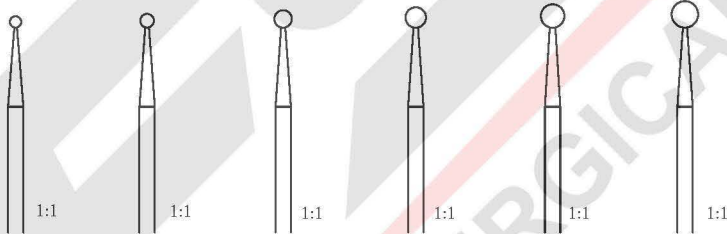

Diamant bohrer

	1.5 mm Ø	1.8 mm Ø	2.3 mm Ø	2.7 mm Ø	3.0 mm Ø	3.5 mm Ø
95 mm – 3 ³ / ₄ "	EB 15-25-01	EB 15-25-02	EB 15-25-03	EB 15-25-04	EB 15-25-05	EB 15-25-06

Diamantbohrer, 95 mm lang, Schaft-Ø 2.35 mm

Diamond dust polishing burrs, 95 mm long, shank diameter 2.35 mm

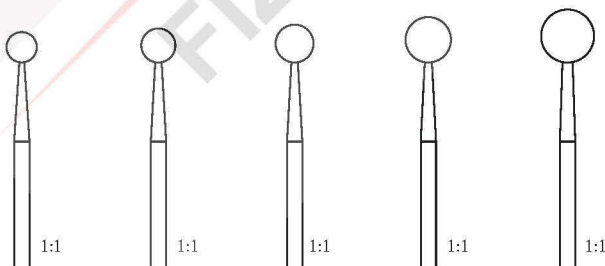

	4.0 mm Ø	4.5 mm Ø	5.0 mm Ø	6.0 mm Ø	7.0 mm Ø
95 mm – 3 ³ / ₄ "	EB 15-25-07	EB 15-25-08	EB 15-25-09	EB 15-25-10	EB 15-25-11

SURGERY HNO – ENT

Nasenspekula : *Nasal specula*
Spéculums nasaux : Especulos nasales
Specoli nasali



**Thudichum
(Goldsmith)**

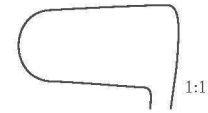
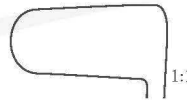

	21 mm x 9.5 mm	21 mm x 10.5 mm	21 mm x 11.5 mm
65 mm – 2 1/2"	NS 15-10-01	NS 15-10-02	NS 15-10-03



Hartmann

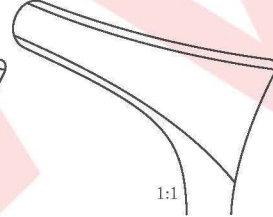
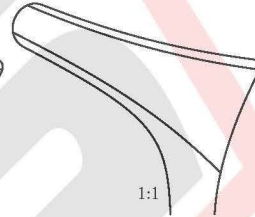
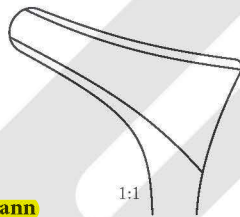

160 mm – 6 1/4"	NS 15-15-01	NS 15-15-02	NS 15-15-03
-----------------	-------------	-------------	-------------



Hartmann-Halle

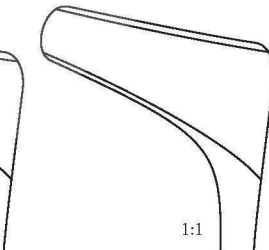
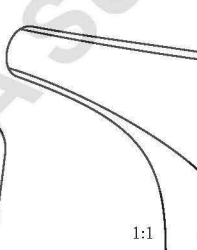
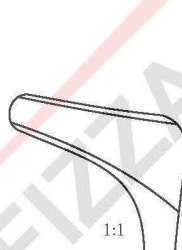

150 mm – 6"	NS 15-20-01	NS 15-20-02	NS 15-20-03
-------------	-------------	-------------	-------------

SURGERY HNO – ENT

Nasenspekula : Nasal specula
Spéculums nasaux : Especulos nasales
Specoli nasali



Tieck-Halle

135 mm – 5¹/₄"

NS 15-25-01

für Säuglinge
for babies

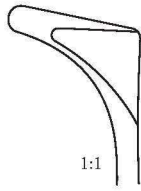

Schwarz

140 mm – 5¹/₂"

NS 15-30-01

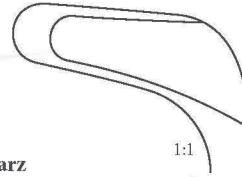

Killian

130 mm – 5"

x = 35 mm
NS 15-35-01

x = 50 mm
NS 15-35-02

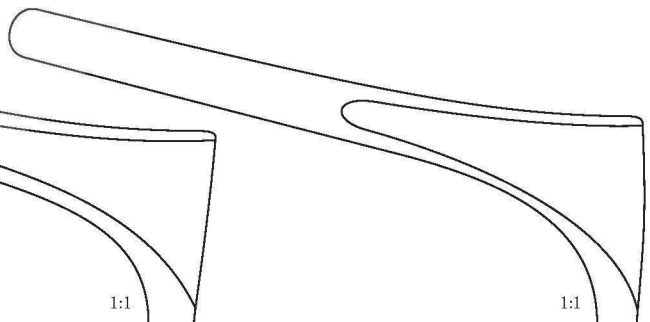
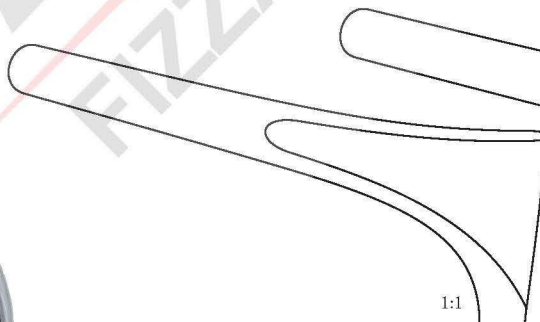
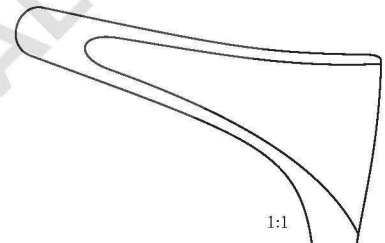
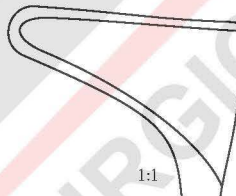

130 mm – 5"

x = 75 mm
NS 15-35-03

x = 90 mm
NS 15-35-04

SURGERY HNO – ENT

Nasenspekula : *Nasal specula*
Spéculum nasaux : Especulos nasales
Specoli nasali



Beckmann

150 mm – 6"

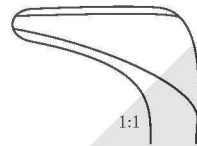

NS 15-40-01

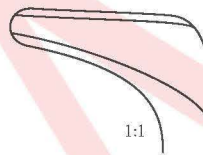

NS 15-40-02

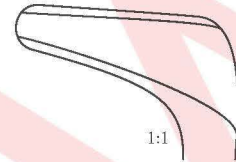

NS 15-40-03



Mod. Wien

145 mm – 5³/₄"

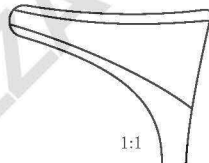

NS 15-45-01

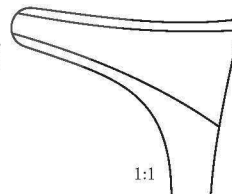

NS 15-45-02

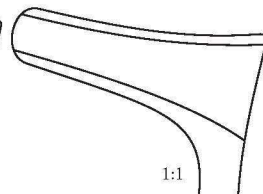

NS 15-45-03

SURGERY HNO – ENT

Nasenspekula : Nasal specula
Spéculum nasaux : Especulos nasales
Specoli nasali

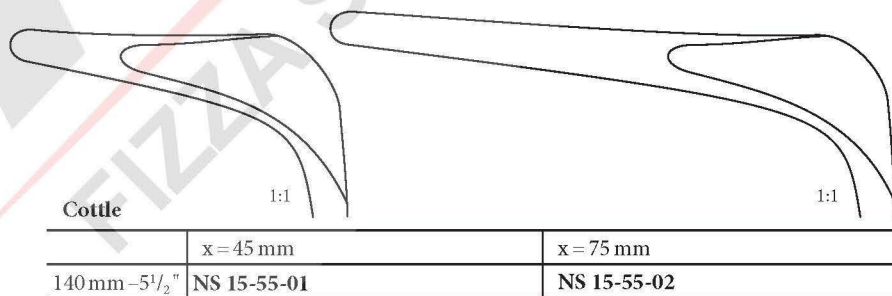
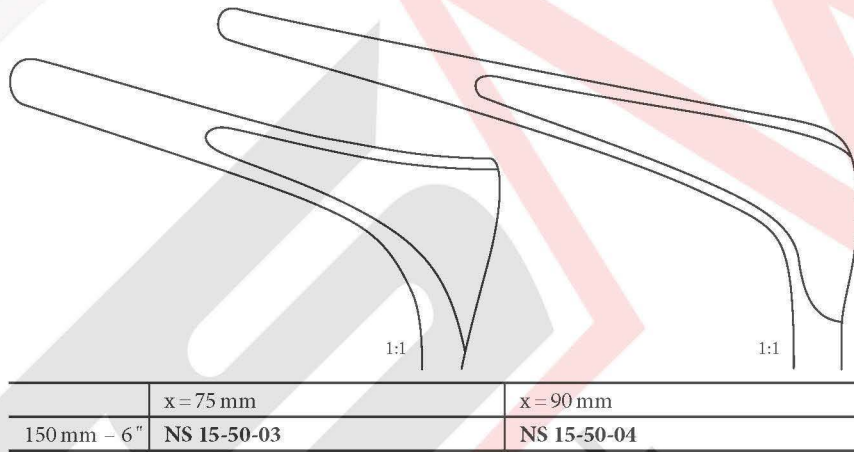
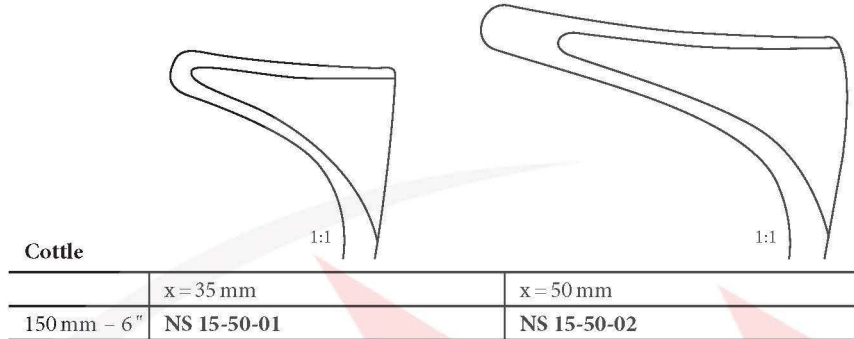

schwarz verchromt
black, chrome plated

SURGERY HNO – ENT

Nasenpolypenzangen – Septumzangen : Nasal polypus and septum forceps
Pinces à polypes et la cloison nasale : Pinzas para pólipos y el tabique nasal
Pinze per polipi e setto nasale



Westmacott
 200 mm – 8" | NF 15-10-01

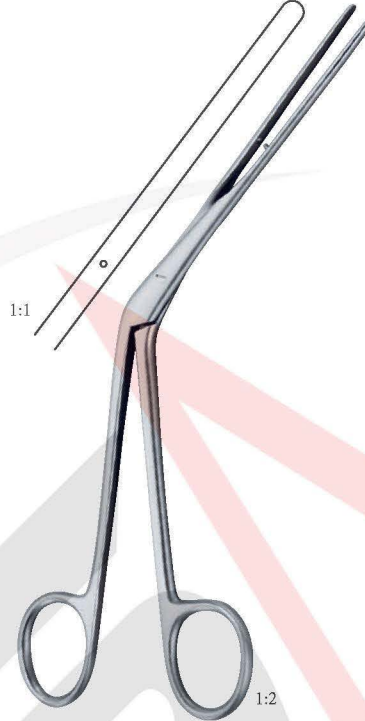

Lubet-Barbon
 200 mm – 8" | NF 15-15-01



Hartmann
 160 mm – 6¹/₄" | NF 15-20-01
 200 mm – 8" | NF 15-20-02

Nasentamponzange : Nasal dressing forceps
Pince à pansement pour le nez : Pinza nasale para tamponiamento
Pinza per tamponamento nasale

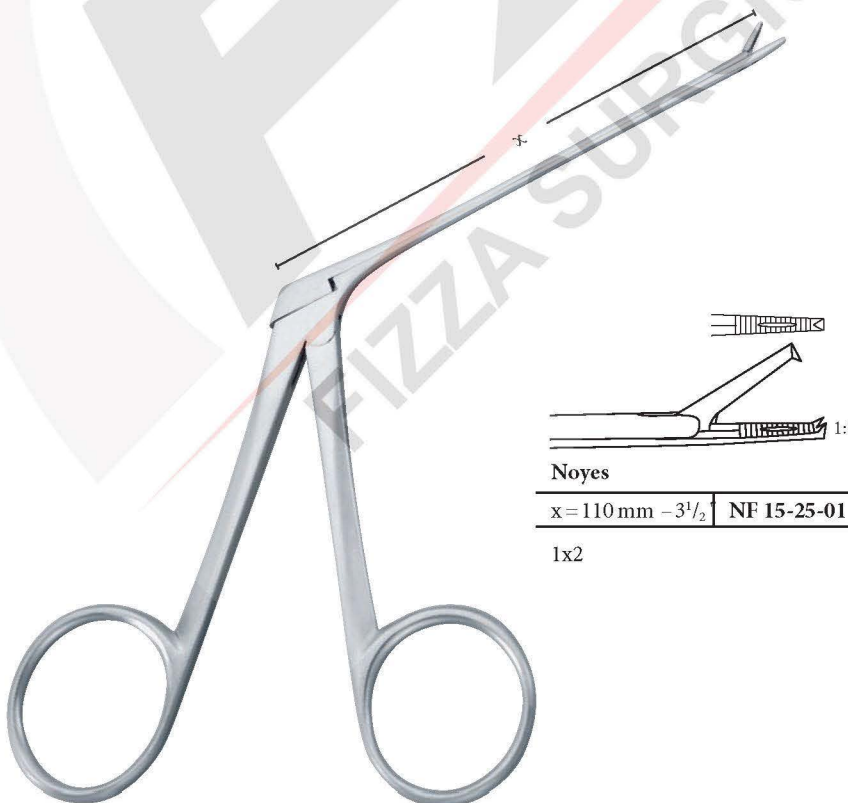

Noyes
 x = 110 mm – 3¹/₂" | NF 15-25-01
 1x2

SURGERY HNO – ENT

Nasenpolypenzangen – Septumzangen : Nasal polypus and septum forceps
Pinces à polypes et la cloison nasale : Pinzas para pólipos y el tabique nasal
Pinze per polipi e setto nasale



Tilley

140 mm – 5½"	NF 15-20-01
--------------	-------------



HEymann-Knight

180 mm – 7"	NF 15-25-01
-------------	-------------



Craig

180 mm – 7"	NF 15-30-01
-------------	-------------

SURGERY HNO - ENT

Nasenpolypenzangen : *Nasal polypus*

Pinces à polypes nasales : *Pinzas para pólipos nasales*

Pinze per polipi nasali



Heymann



1:1



1:1



1:1

180 mm - 7"	NF 15-35-01	NF 15-35-02	NF 15-35-03
-------------	-------------	-------------	-------------

1:2



Littauer

180 mm - 7"	NF 15-40-01
-------------	-------------

1:2



Knight

180 mm - 7"	NF 15-45-01
-------------	-------------

1:2

SURGERY HNO – ENT

Scharfe Nasenzangen : *Nasal cutting forceps*

Pinces coupantes pour le nez : Pinzas nasales cortantes

Pinze taglianti per naso



Luc	1:1		1:1	
	Fig. 1	Fig. 2	Fig. 1	Fig. 2
200 mm – 8"	NF 15-50-01	NF 15-50-02	NF 15-51-01	NF 15-51-02
	gefenstert fenestrated		voll plaine	



Takahashi		
1:1	1:1	1:1
	3.5 mm x 10 mm	3.5 mm x 10 mm
x = 120 mm – 4 ³ / ₄ "	NF 15-55-01	NF 15-55-02

SURGERY HNO – ENT

Scharfe Nasenzangen : *Nasal cutting forceps*

Pinces coupantes pour le nez : Pinzas nasales cortantes

Pinze taglienti per naso



Bruenings

190 mm – 7½"



NF 15-60-01



NF 15-60-02



NF 15-60-03



NF 15-60-04

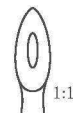

Weil

NF 15-65-01

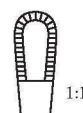

Watson-Williams

NF 15-65-02



Weil

NF 15-65-03

x=120mm – 4¾"

SURGERY HNO - ENT

Scharfe Nasenzangen : Nasal cutting forceps

Pinces coupantes pour le nez : Pinzas nasales cortantes

Pinze taglienti per naso

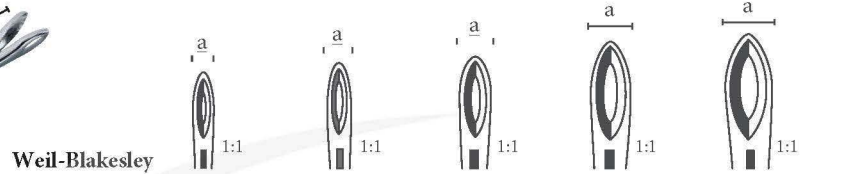
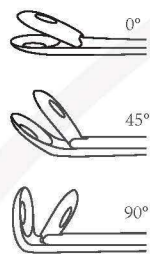

Weil-Blakesley					
	Fig. 1	Fig. 2	Fig. 3	Fig. 4	Fig. 5
	a=3.0 mm	a=3.6 mm	a=4.2 mm	a=4.8 mm	a=5.8 mm
x=120 mm - 4 ³ / ₄ "	NF 15-70-01	NF 15-70-02	NF 15-70-03	NF 15-70-04	NF 15-70-05

x=120 mm - 4 ³ / ₄ "	NF 15-71-01	NF 15-71-02	NF 15-71-03	NF 15-71-04	
--	-------------	-------------	-------------	-------------	--

x=120 mm - 4 ³ / ₄ "	NF 15-72-01	NF 15-72-02	NF 15-72-03		
--	-------------	-------------	-------------	--	--

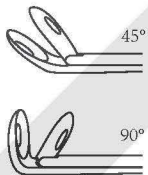
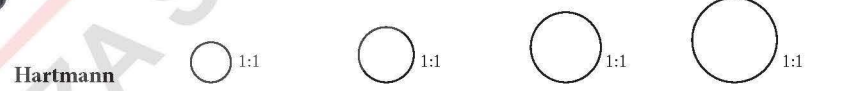

	Fig. 1	Fig. 2	Fig. 3	Fig. 4	Fig. 5
	a=3.0 mm	a=3.6 mm	a=4.2 mm	a=4.8 mm	a=5.8 mm

x=180 mm - 7"	NF 15-73-01	NF 15-73-02	NF 15-73-03	NF 15-73-04	NF 15-73-05
---------------	-------------	-------------	-------------	-------------	-------------

x=180 mm - 7"	NF 15-74-01	NF 15-74-02	NF 15-74-03	NF 15-74-04	
---------------	-------------	-------------	-------------	-------------	--



Hartmann				
x=120 mm - 4 ³ / ₄ "	NF 15-75-01	NF 15-75-02	NF 15-75-03	NF 15-75-04

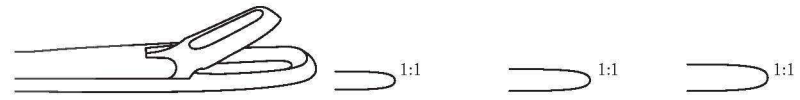

	Fig. 1	Fig. 2	Fig. 3
	2.0 x 10.0 mm	2.5 x 12.0 mm	3.0 x 14.0 mm
x=120 mm - 4 ³ / ₄ "	NF 15-80-01	NF 15-80-02	NF 15-80-03



11,5x3,5 mm

Mackay-Gruenwald
x=130 mm - 4³/₄" | **NF 15-76-01**

FS
FIZZA SURGICAL

SURGERY HNO - ENT

Scharfe Nasenzangen : Nasal cutting forceps

Pincès coupantes pour le nez : Pinzas nasales cortantes

Pinze taglienti per naso



Schmeden

x = 120 mm - 4³/₄"



1:1

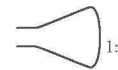

1:1



1:1

	NF 15-85-01	NF 15-85-02	NF 15-85-03
--	-------------	-------------	-------------



Tomati

x = 120 mm - 4³/₄"

NF 15-90-01

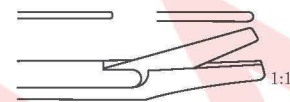

Struycken

	0.9 mm	1.2 mm
x = 120 mm - 4 ³ / ₄ "	NF 15-95-01	NF 15-95-02



Henke

x = 120 mm - 4³/₄"

NF 15-100-01

Nasenschere : Nasal scissors

Ciseaux nasales : Tijera nasal

Forbice nasale

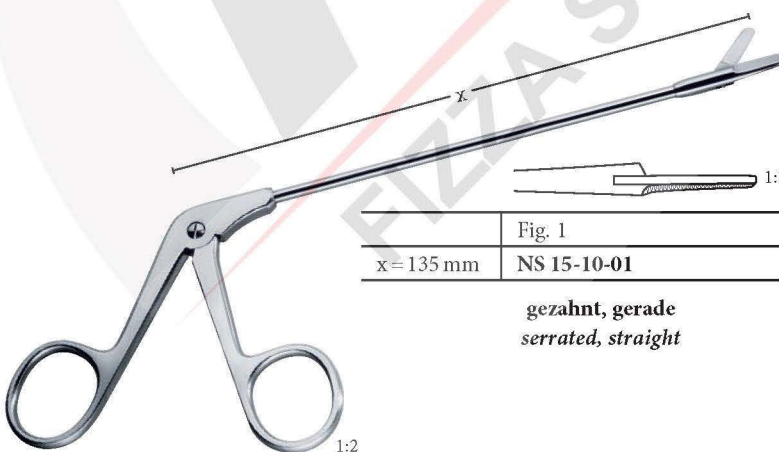

Fig. 1

NS 15-10-01

gezahnt, gerade
serrated, straight



Fig. 2

NS 15-10-02

gezahnt, rechts
serrated, right



Fig. 3

NS 15-10-03

gezahnt, links
serrated, left

x = 135 mm	NS 15-10-01	NS 15-10-02	NS 15-10-03
------------	-------------	-------------	-------------

SURGERY HNO – ENT

Scharfe Nasenzangen : Nasal cutting forceps
Pinces coupantes pour le nez : Pinzas nasales cortantes
Pinze taglienti per naso

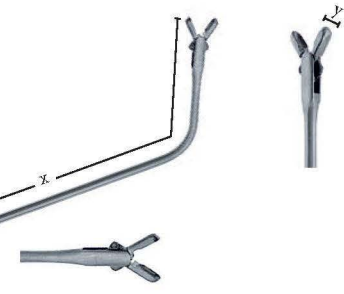

	y = 3 mm
x = 100 mm – 4"	NF 15-105-01

gerade vertikal, doppelt beweglich
straight vertical, double action



	y = 3 mm
x = 100 mm – 4"	NF 15-105-02

gerade hor., doppelt beweglich
straight hor., double action



	y = 3 mm
x = 100 mm – 4"	NF 15-105-03

gerade hor., einfach beweglich, kurz
straight hor., single action, short



	y = 3 mm
x = 100 mm – 4"	NF 15-105-04

45° vertikal, doppelt beweglich
45° vertical, double action



	y = 3 mm
x = 100 mm – 4"	NF 15-105-05

45° hor., doppelt beweglich
45° hor., double action



	y = 3 mm
x = 100 mm – 4"	NF 15-105-06

45° vert., einfach beweglich, kurz
45° vert., single action, short



	y = 3 mm
x = 100 mm – 4"	NF 15-105-07

70° vertikal, doppelt beweglich
70° vertical, double action



	y = 3 mm
x = 100 mm – 4"	NF 15-105-08

70° hor., doppelt beweglich
70° hor., double action



	y = 3 mm
x = 100 mm – 4"	NF 15-105-09

110° hor., doppelt beweglich
110° hor., double action

	y = 3 mm
x = 100 mm – 4"	NF 15-105-10

70° vert., einfach beweglich, kurz
70° vert., single action, short

	y = 3 mm
x = 100 mm – 4"	NF 15-105-11

70° hor., einfach beweglich
70° hor., single action

Scharfe Nasenzangen : *Nasal cutting forceps*
 Pincés coupantes pour le nez : *Pinzas nasales cortantes*
 Pinze taglianti per naso

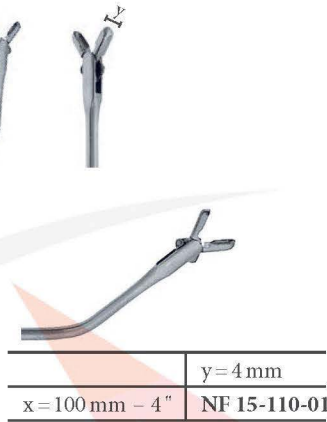

45° vertikal, doppelt beweglich
 45° vertical, double action

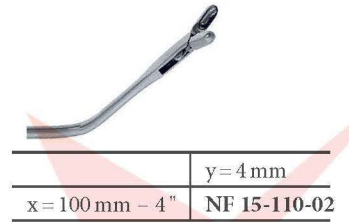

45° hor., doppelt beweglich, kurz
 45° hor., double action, short



45° vertikal, einfach beweglich, kurz
 45° vertical, single action, short short

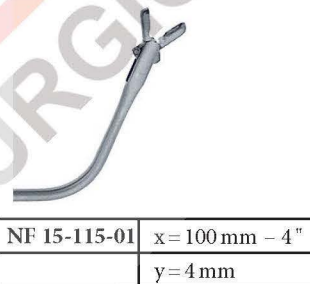

70° vertikal, doppelt beweglich
 70° vertical, double action

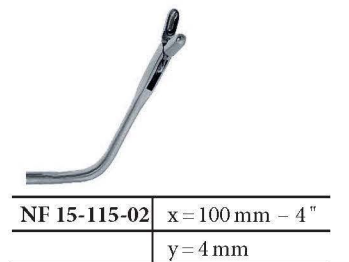

70° hor., doppelt beweglich, kurz
 70° hor., double action, short

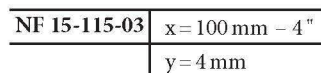

70° vertikal, einfach beweglich, kurz
 70° vertical, single action, short short

SURGERY HNO - ENT

Zirkular Stanze : *Circular forceps*

Pince circulaire : *Pinza circular*

Pinza a taglio circolare

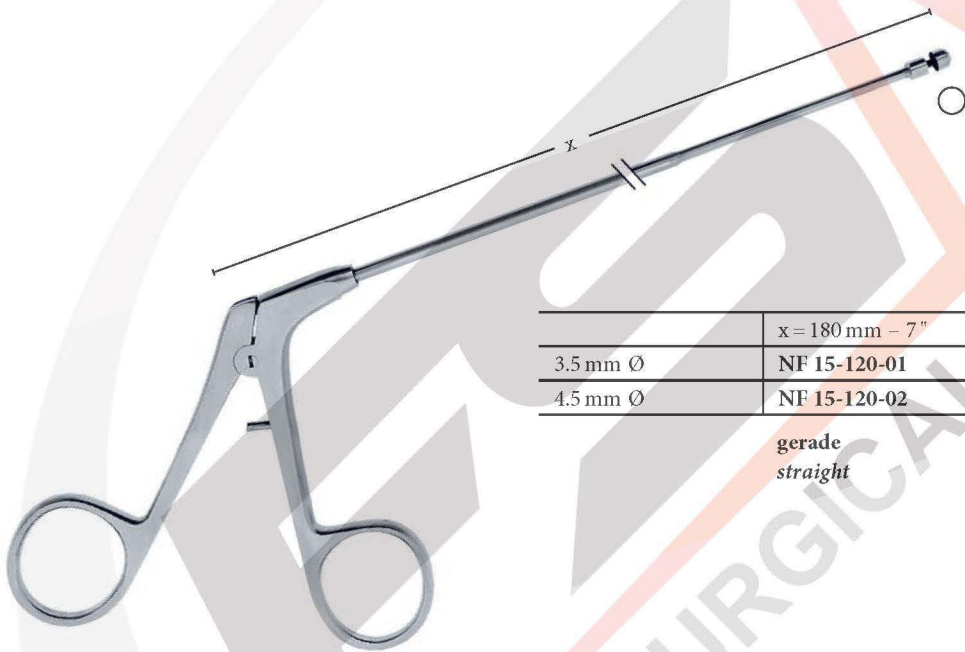

	x = 180 mm - 7"	x = 180 mm - 7"
3.5 mm Ø	NF 15-120-01	NF 15-120-01
4.5 mm Ø	NF 15-120-02	NF 15-120-02

gerade
straight

aufgebogen
curved upwards

SURGERY HNO - ENT

Antrumstanze : Antrum punch

Pince pour l'antrum : Pinza antrum

Pinze antrum

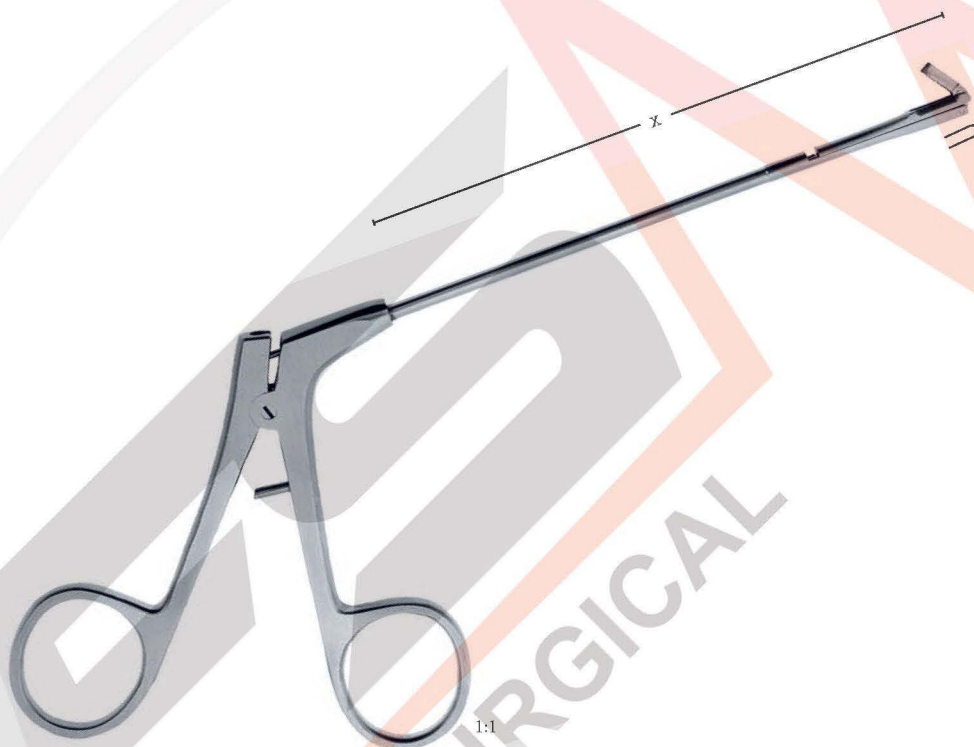

Ostrum

x = 100 mm	Fig. 1	Fig. 2	Fig. 3
1.5 mm x 4.5 mm	AP 15-10-01	AP 15-10-02	AP 15-10-03
	rückwärts nach oben schneidend backward, up-cutting	rückwärts nach rechts schneidend backward, cut to the right	rückwärts nach links schneidend backward, cut to the left

Keilbeinstanzen : Punches sphenoid bone

Pinces pour le sinus sphénoïdal : Pinzas para esfenoides

Pinze sfenoidali taglienti

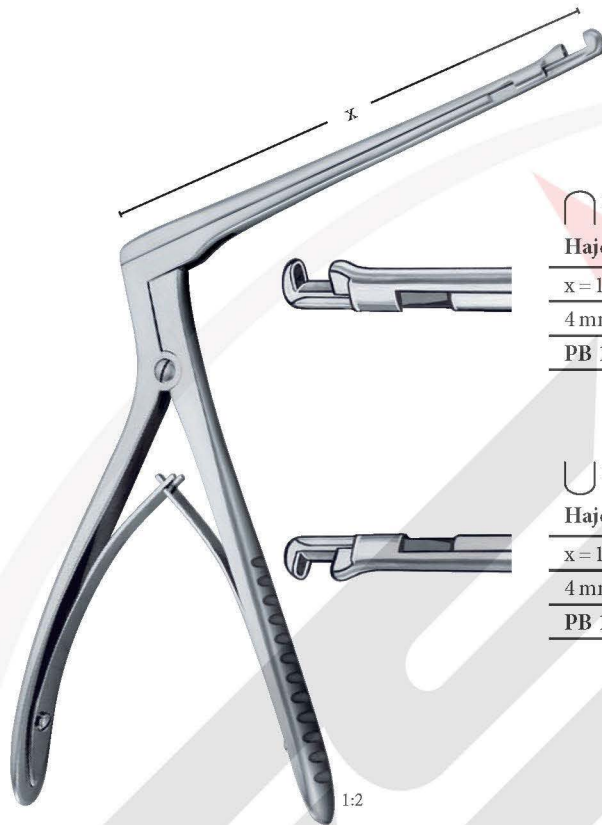

1:1

Hajek

x = 140 mm – 5 1/2"

4 mm x 4 mm

PB 15-10-01

1:1

Hajek-Kofler

x = 140 mm – 5 1/2"

3.5 mm x 3.5 mm

PB 15-10-02

1:1

Hajek

x = 140 mm – 5 1/2"

4 mm x 4 mm

PB 15-15-01

1:1

Hajek-Kofler

x = 140 mm – 5 1/2"

3.5 mm x 3.5 mm

PB 15-15-02

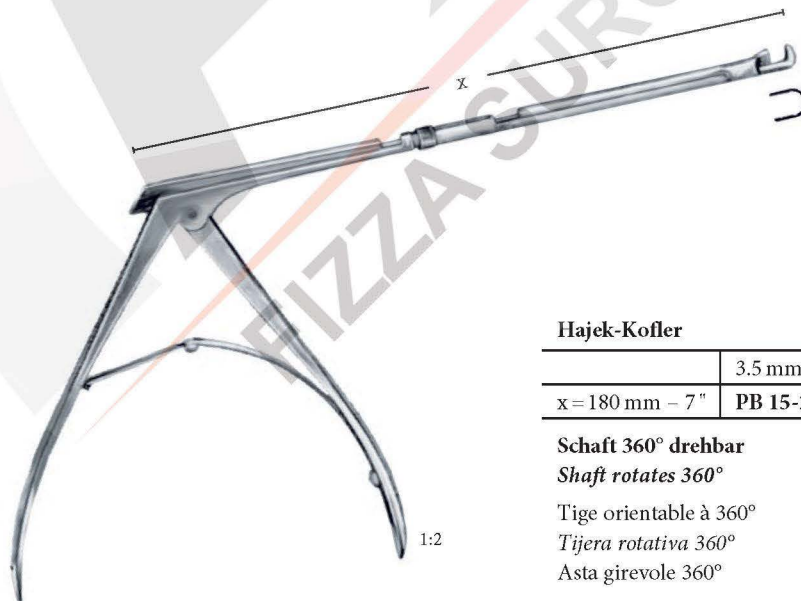

Hajek-Kofler

3.5 mm

x = 180 mm – 7" **PB 15-20-01**

Schaft 360° drehbar

Shaft rotates 360°

Tige orientable à 360°

Tijera rotativa 360°

Asta girevole 360°

SURGERY HNO – ENT

Keilbeinstanzen : *Punches sphenoid bone*

Pinces pour sinus sphénoïdal : Pinzas para esfenoides

Pinze sfenoidali taglienti



Hajek-Claus

200 mm – 8"

PB 15-25-01



Kerrison

x = 90 mm – 3 1/2"

200 mm – 8"

4 mm x 4 mm

PB 15-30-01

5 mm x 5 mm

PB 15-30-02

6 mm x 6 mm

PB 15-30-03

SURGERY HNO – ENT

Nasenpolypenschnürer : Nasal polypus snares
Serre noeuds pour polypes : Polipótomos nasales
Serranodi nasali



0.3 mm Ø x 100 mm	NP 15-10-01
-------------------	-------------

in Bündeln mit 12 Stück
in bundles of 12 pieces



Krause

260 mm – 10 ¹ / ₄ "	NP 15-15-01
---	-------------



Krause-Voss

260 mm – 10 ¹ / ₄ "	NP 15-20-01
---	-------------

mit 2 Aufsätzen
with 2 inserts



Lange-Wilde

240 mm – 9 ¹ / ₂ "	NP 15-25-01
--	-------------

SURGERY HNO – ENT

Nasennmesser : Nasal knives

Bistouris pour nez : Cuchillos nasales

Bisturi per naso



Fomon

165 mm – 6 1/2"

NK 15-10-01

1:2



1:2

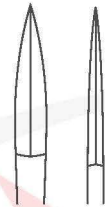

1:1



1:1



1:1



1:1

Joseph

	Fig. 1	Fig. 2	Fig. 1	Fig. 2
160 mm – 6 1/4"	NK 15-15-01	NK 15-15-02	NK 15-15-03	NK 15-15-04

scharf/spitz
sharp/sharp

gerade
straight

gebogen
curved

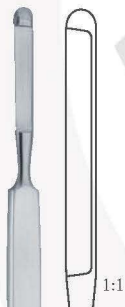

1:2

Joseph

140 mm – 5 1/2"

NK 15-20-01

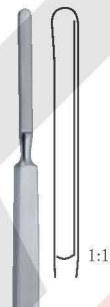

1:2

Cottle

150 mm – 6"

NK 15-25-01



1:2

Joseph

175 mm – 7"

NK 15-30-01



1:2

Bruenings

165 mm – 6 1/2"

NK 15-35-01

NK 15-40-01

Ersatzklinge
Spare blade

SURGERY HNO - ENT

Nasenmesser : *Nasal knives*

Bistouris pour nez : *Cuchillos nasales*

Bisturi per naso

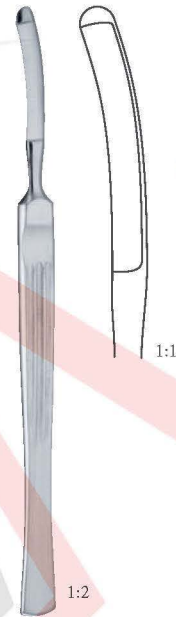

Freer

190 mm - 6 $\frac{1}{2}$ "	NK 15-45-01	NK 15-46-01
----------------------------	-------------	-------------

Converse

160 mm - 6 $\frac{1}{4}$ "	NK 15-50-01
----------------------------	-------------



Freer

150 mm - 6"	NK 15-55-01
-------------	-------------



Freer

150 mm - 6"	NK 15-60-01
-------------	-------------



Freer

150 mm - 6"	NK 15-65-01
-------------	-------------

SURGERY HNO – ENT

Tonsillenmesser : *Tonsil knives*

Couteaux à tonsils : *Bisturis para amigdales*

Bisturi per tonsille



1:2



1:2



1:2

Freer

210mm – 8 ¹ / ₄ "	TK 15-10-01	TK 15-10-02
---	-------------	-------------

200 mm – 8"

TK 15-15-01

Sichelmesser

Sickle knife



1:2

Bruenings

230 mm – 9"

TK 15-20-01



1:2

Abraham

220 mm – 8³/₄"

TK 15-25-01



1:2

Fischer

230 mm – 9"

TK 15-30-01

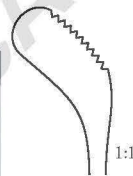

1:1



1:2

200 mm – 8"

TK 15-35-01

scharf
sharp

SURGERY HNO – ENT

Antrumküretten : Antrum curettes
Curettes d'antrum : Curetas para el antrum
Curette per antrum

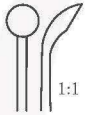

1:1



1:1

200 mm – 8"
 AC 15-10-01

200 mm – 8"
 AC 15-10-02



1:1

200 mm – 8"
 7mmx11mm
 AC 15-15-01



1:1



1:2

Pratt
 210 mm – 8 1/4"
 AC 15-20-01



1:1



1:2

Faulkner
 210 mm – 8 1/4"
 AC 15-25-01

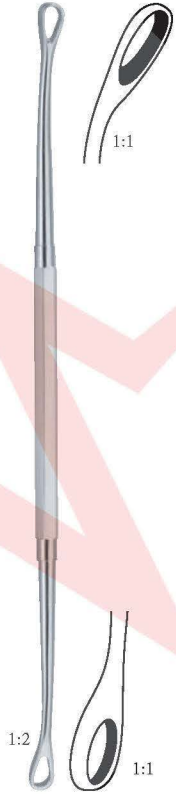

1:1



1:2

Coakley
 200 mm – 8"
 AC 15-30-01



1:2



1:1



1:1



1:1



1:1



1:1

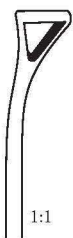

1:1

Coakley

	Fig. 1	Fig. 2	Fig. 3	Fig. 4	Fig. 5	Fig. 6
170 mm – 6 3/4"	AC 15-35-01	AC 15-35-02	AC 15-35-03	AC 15-35-04	AC 15-35-05	AC 15-35-06
AC 15-35-00	x	x	x	x	x	x

Satz
Set

Septumlevatorien – Raspatorien : *Septum elevators – raspatories*
Elevadores – legras para el tabique nasal : *Elevatori – periostotomi per setto*
Elevateurs – rugines pour la cloison nasale

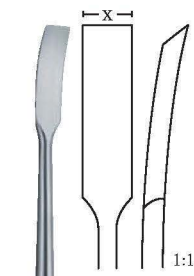

x

1:1



1:2

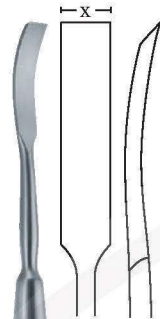

x

1:1



1:2

Lempert

	205 mm – 8"	180 mm – 7"
x = 6 mm	SE 15-10-01	SE 15-10-02

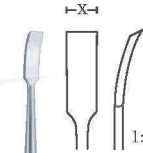

x

1:1



1:2

Freer

	x = 4 mm
160 mm – 6 1/4"	SE 15-15-01



1:1



1:2

Cottle

	x = 8 mm
190 mm – 7 1/2"	SE 15-20-01

scharf
sharp



x

1:1



1:2

Joseph

	x = 5 mm
160 mm – 6 1/4"	SE 15-25-01

Periost Elevatorien
Periostal elevators



4 mm

1/2



1/2

Joseph

	x = 4 mm
165 mm, 6 1/2"	SE 15-26-01



Sewall

200 mm - 8"	SE 15-30-01
-------------	-------------

Antrum Elevatorium
Antrum Elevator



Halle

180 mm - 7"	SE 15-35-01
-------------	-------------

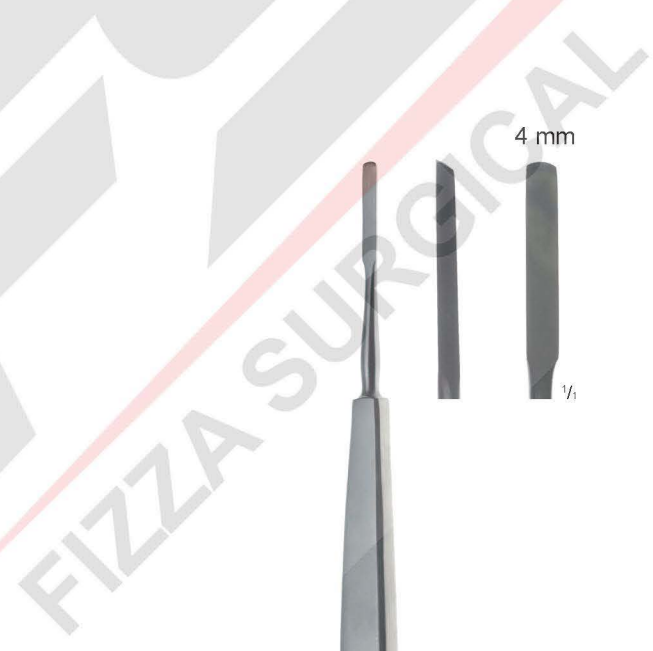

FOMON

170 mm, 6 3/4"	SE 15-35-01
----------------	-------------

LEMPERT

185 mm, 7 1/4"	SE 15-35-01
----------------	-------------

Septumelevatorien – Raspatorien : *Septum elevators – raspatories*
Elevadores – legras para el tabique nasal : Elevatori – periostotomi per setto
Elevateurs – rugines pour la cloison nasale

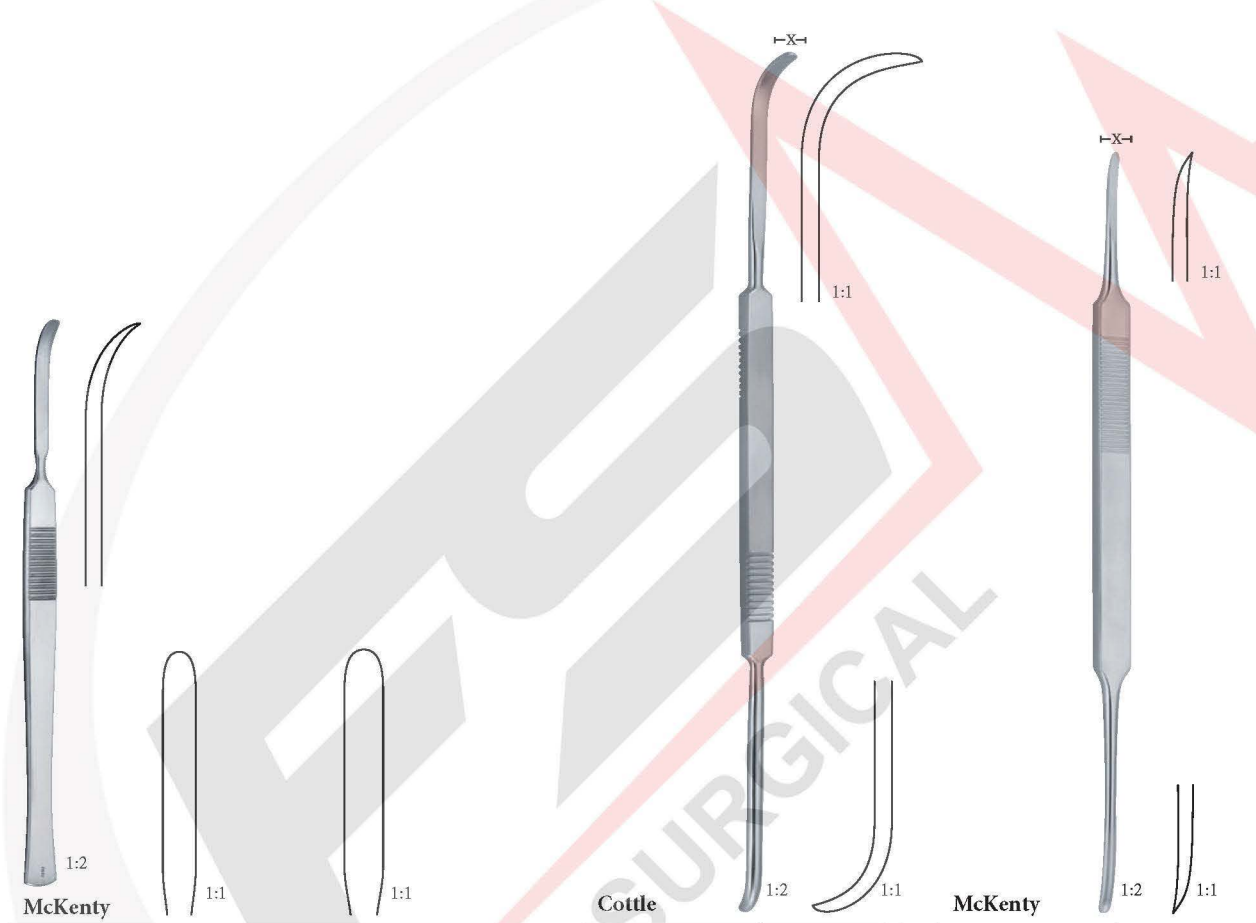

McKenty

	4 mm	5 mm
150 mm – 6"	SE 15-40-01	SE 15-40-02

scharf
sharp

Cottle

	x = 5 mm
235 mm – 9 1/4"	SE 15-45-01

scharf
sharp

McKenty

	x = 4 mm
205 mm – 8"	SE 15-50-01

scharf
sharp

SURGERY HNO – ENT

Septumelevatorien – Raspatorien : *Septum elevators – raspatories*
 Elevadores – legras para el tabique nasal : *Elevatori – periostotomi per setto*
 Elevateurs – rugines pour la cloison nasale



Killian	x = 4 mm	Killian	x = 4.5 mm	Freer	SE 15-65-01	Freer	SE 15-70-01
180 mm – 7"	SE 15-55-01	230 mm – 9"	SE 15-60-01	190 mm – 7½"		180 mm – 7"	
scharf/stumpf sharp/blunt		scharf/stumpf sharp/blunt		stumpf blunt		scharf/stumpf sharp/blunt	

SURGERY HNO – ENT

Septum elevatorien – Raspatorien : *Septum elevators – raspatories*
 Elevadores – legras para el tabique nasal : *Elevatori – periostotomi per setto*
 Elevateurs – rugines pour la cloison nasale



Freer
 205 mm – 8" | SE 15-75-01

scharf/stumpf
sharp/blunt



Freer
 195 mm – 7³/₄" | SE 15-76-01

scharf/stumpf
sharp/blunt



Pennington
 215 mm – 8¹/₂" | SE 15-80-01

stumpf
blunt



Joseph-Masing
 215 mm – 8¹/₂" | SE 15-85-01

scharf
sharp

Periostelevatorien : Periosteal elevators

Elevateurs pour la périoste : Legras para periostio

Elevatori per il periosto

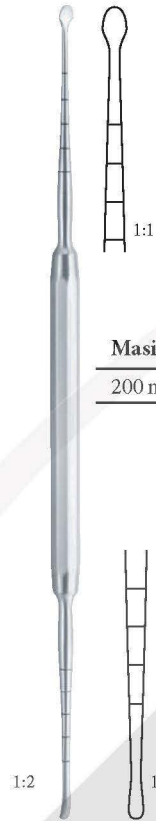

Masing

200 mm – 8"	PE 15-10-01
-------------	-------------



Ballenger-Hajek

190 mm – 7 ¹ / ₄ "	PE 15-15-01
220 mm – 8 ³ / ₄ "	PE 15-15-02



Cottle

220 mm – 8 ³ / ₄ "	PE 15-20-01
--	-------------

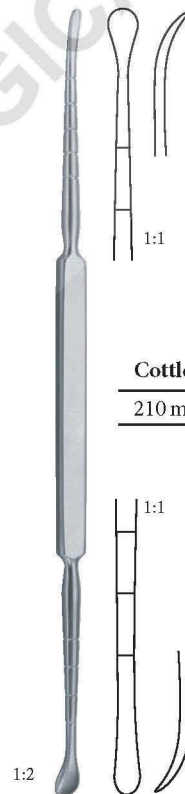

Cottle

210 mm – 8 ¹ / ₄ "	PE 15-25-01
--	-------------

SURGERY HNO – ENT

Septumelevatorien : *Septum elevators*

Elevateurs pour la cloison nasale : *Elevadores para el tabique nasal*

Elevatori per setto



1:2

Boies

190 mm – 7½"	SE 15-90-01
--------------	-------------

Nasenfraktur Elevatorium, stumpf
Nasal fracture elevator, blunt



1:2

Goldman

170 mm – 6¾"	SE 15-95-01
--------------	-------------

Septumfraktur Elevatorium
Septum displacer



Watson-Cheyne

130 mm – 5"	190 mm – 7½"
SE 15-100-01	SE 15-101-01

Raspatorium
Raspatory



SURGERY HNO – ENT

Nasensägen : Nasal saws
 Scies nasales : Sierras nasales
 Seghe nasali



Joseph

190 mm – 7 ¹ / ₂ ”	190 mm – 7 ¹ / ₂ ”
NS 15-100-01	NS 15-100-02

Joseph

190 mm – 7 ¹ / ₂ ”
NS 15-105-01

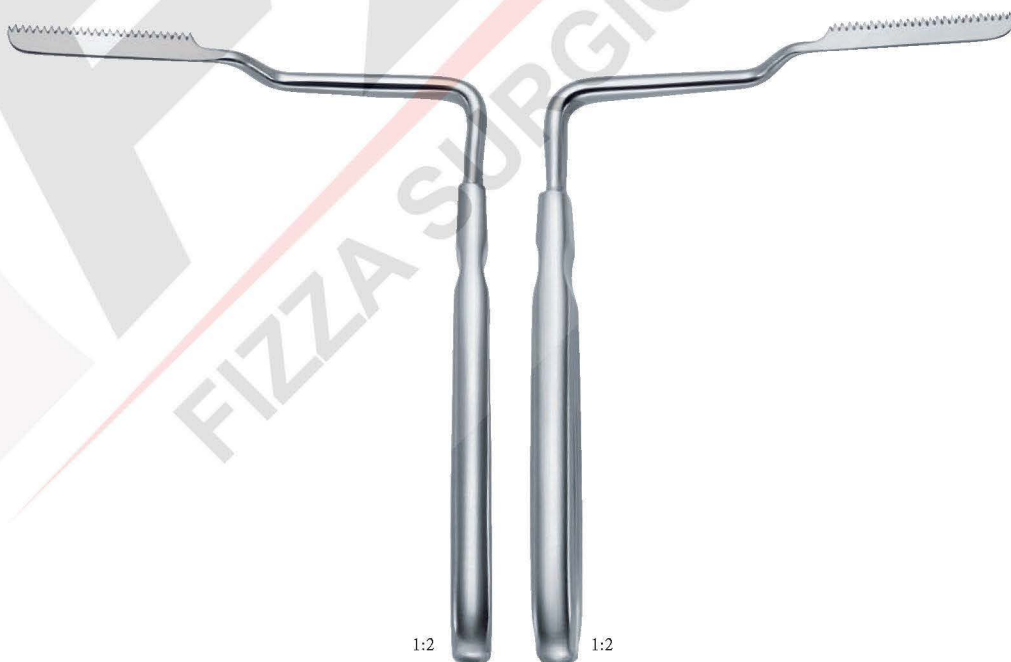

Joseph

170 mm – 6 ³ / ₄ ”	170 mm – 6 ³ / ₄ ”
NS 15-110-01	NS 15-111-01

Nasenraspeln : *Nasal rasps*
 Râpes nasales : *Limas nasales*
 Raspe nasali

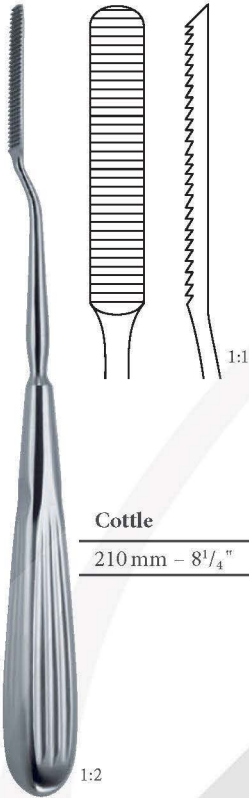

Cottle

210 mm - 8 ¹ / ₄ "	NR 15-10-01
--	-------------

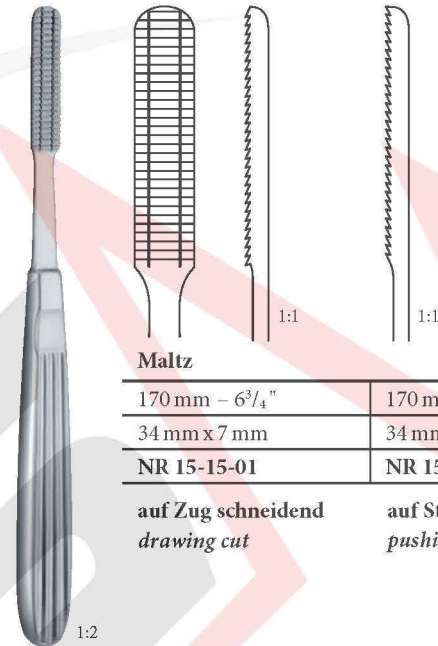

Maltz

170 mm - 6 ³ / ₄ "	170 mm - 6 ³ / ₄ "
34 mm x 7 mm	34 mm x 7 mm
NR 15-15-01	NR 15-16-01

auf Zug schneidend
drawing cut

auf Stoss schneidend
pushing cut

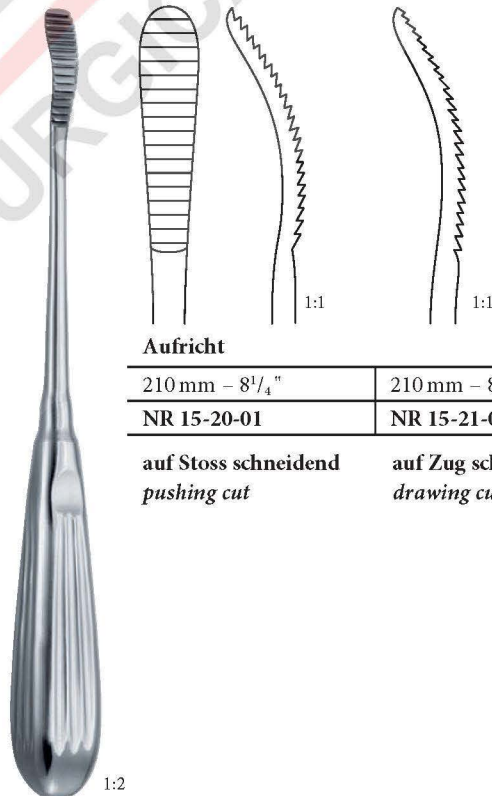

Aufrecht

210 mm - 8 ¹ / ₄ "	210 mm - 8 ¹ / ₄ "
NR 15-20-01	NR 15-21-01

auf Stoss schneidend
pushing cut

auf Zug schneidend
drawing cut

Nasenraspeln : Nasal rasps
Râpes nasales : Limas nasales
Raspe nasali

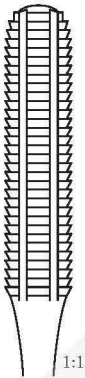
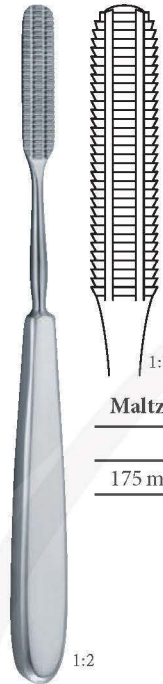

Maltz

	40 mm x 9 mm
175 mm - 7"	NR 15-25-01

1:2



Wiener

	Ø 3.5 mm	Ø 3.5 mm
180 mm - 7"	NR 15-30-01	NR 15-31-01

1:2



1:1

1:1

Antrum Raspeln

Antrum rasps

Râpes pour le fosse nasale

Limas para el antrum

Raspe per antrum



1:2



Gallaher

160 mm - 6 1/4"	160 mm - 6 1/4"	160 mm - 6 1/4"
NR 15-37-01	NR 15-35-01	NR 15-36-01

1:1

1:1

1:1



1:2



1:1

1:1

Fomom

210 mm - 8 1/4"
NR 15-40-01

SURGERY HNO - ENT

Raspeln mit Hartmetall : Rasps with tungsten carbide

Râpes avec inserts de carbure de tungstène : Limas con carburo de tungsteno

Raspe con tungsteno

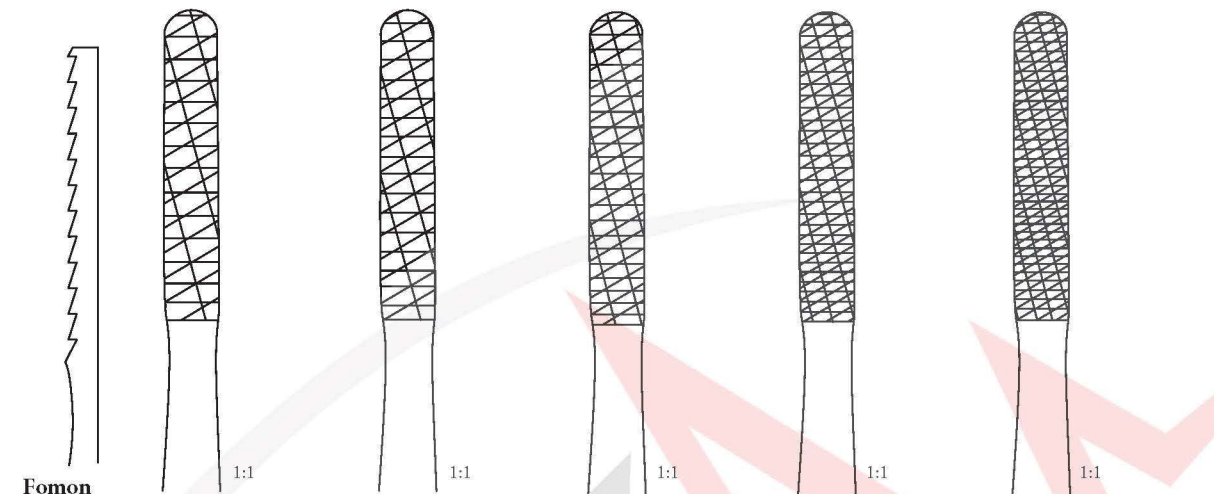

Fomon

	Fig. 1	Fig. 3	Fig. 5	Fig. 7	Fig. 9
Zähne : Teeth	12	16	24	36	52
200 mm - 8"	NR 15-45-01 TC	NR 15-45-02 TC	NR 15-45-03 TC	NR 15-45-04 TC	NR 15-45-05 TC

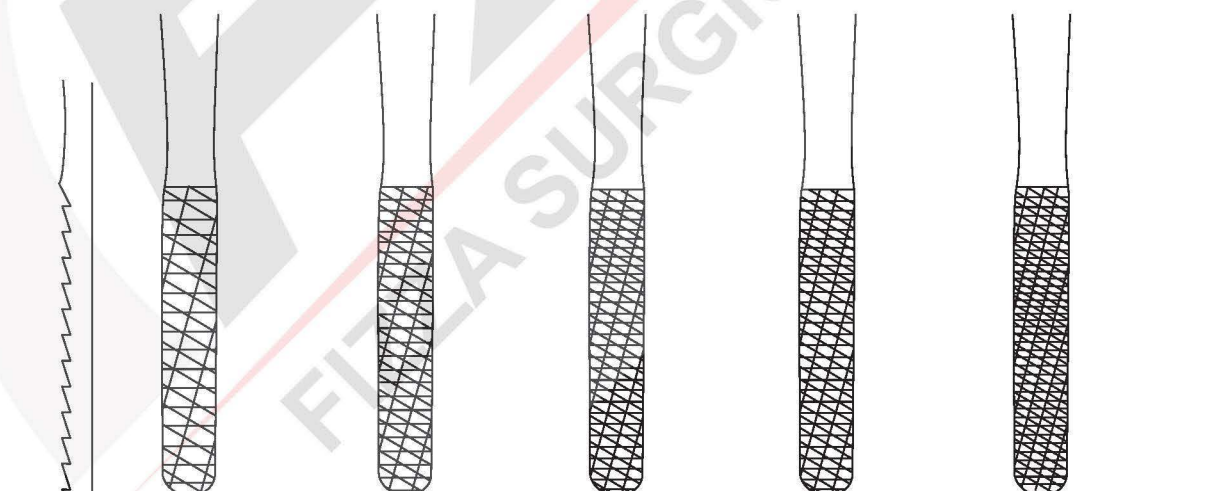

Fomon TC

	Fig. 2	Fig. 4	Fig. 6	Fig. 8	Fig. 10
Zähne : Teeth	14	20	30	44	62

Zähne
Teeth



1:1