

Certificate

**Quality Management System
EN ISO 13485:2016**

Registration No.: SX 1178843-1

Organization: MED TRUST Handelsges.m.b.H.
Gewerbepark 10
7221 Marz
Austria

Scope: Design and development, manufacturing and distribution of blood pressure monitors and non-active medical devices for injection and infusion and pricking devices as well as in vitro diagnostic devices for self-testing

The Certification Body of TÜV Rheinland LGA Products GmbH certifies that the organization has established and applies a quality management system for medical devices. Proof has been furnished that the requirements specified in the abovementioned standard are fulfilled. The quality management system is subject to yearly surveillance.

Report No.: 1106979-40
Effective date: 2022-05-11
Expiry date: 2025-05-01
Issue date: 2022-05-11



Dipl.-Ing. Anja Fechner
TÜV Rheinland LGA Products GmbH
Tillystraße 2 · 90431 Nürnberg · Germany

EC Certificate



Full Quality Assurance System
Directive 98/79/EC on In Vitro Diagnostic Medical Devices,
Annex IV excluding (4, 6)

Registration No.: HL 1178843-1

Manufacturer: MED TRUST Handelsges.m.b.H.
Gewerbepark 10
7221 Marz
Austria

Products: In-vitro-Diagnostic Monitoring Systems for Self-Testing

Products included:

- Blood Glucose Meters
- Blood Glucose and Cholesterol Meters
- Blood Glucose and Ketone Meters
- Blood Glucose, Cholesterol and Uric Acid Meters
- HbA1c Meters
- Glucose Control Solutions
- Cholesterol Control Solutions
- Ketone Control Solutions
- Uric Acid Control Solutions
- HbA1c Control Solutions
- Glucose Test Strips
- Cholesterol Test Strips
- Ketone Test Strips
- Uric Acid Test Strips
- HbA1c Test Strips

Replaces Certificate, Registration No.: HL 60146513 0001

The Notified Body hereby declares that the requirements of Annex IV, excluding section 4 and 6 of the directive 98/79/EC have been met for the listed products. The above named manufacturer has established and applies a quality assurance system, which is subject to periodic surveillance, defined by Annex IV, section 5 of the aforementioned directive. For placing on the market of List A devices covered by this certificate an EC design-examination certificate according to Annex IV, section 4 and a verification of manufactured products according to section 6 is required.

Report No.: 1104380-20

Effective date: 11.03.2022

Expiry date: 26.05.2025

Issue date: 11.03.2022



Katja Mierisch
TÜV Rheinland LGA Products GmbH
Tillystraße 2 · 90431 Nürnberg · Germany

TÜV Rheinland LGA Products GmbH is a Notified Body according to Directive 98/79/EC concerning in vitro diagnostic medical devices with the identification number 0197.

EC Certificate
Directive 93/42/EEC Annex V
Production Quality Assurance
Medical Devices

Registration No.: DD 60141729 0001

Report No.: 21246563 023

Manufacturer: MED TRUST Handelsges.m.b.H.
Gewerbepark 10
7221 Marz
Österreich

Products: (see attachment for products included)

Expiry Date: 2024-05-26

The Notified Body hereby declares that the requirements of Annex V of the directive 93/42/EEC have been met for the listed products. The above named manufacturer has established and applies a quality assurance system, which is subject to periodic surveillance, defined by Annex V, section 4 of the aforementioned directive. For placing on the market of class IIb and class III devices covered by this certificate an EC type-examination certificate according to Annex III is required.

Effective Date: 2019-09-24

Date: 2019-09-24

Notified Body

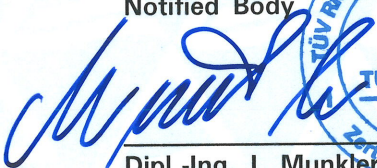

Dipl.-Ing. I. Munkler

TÜV Rheinland LGA Products GmbH - Tillystraße 2 - 90431 Nürnberg
TÜV Rheinland LGA Products GmbH is a Notified Body according to Directive 93/42/EEC concerning medical devices with the identification number 0197.

TÜV Rheinland
LGA Products GmbH
Tillystraße 2, 90431 Nürnberg

**Attachment to
Certificate**

Registration No.: DD 60141729 0001
Report No.: 21246563 023

Manufacturer: MED TRUST Handelsges.m.b.H.
Gewerbepark 10
7221 Marz
Österreich

Products included:



- Disposable Syringes
- Blood Lancets
- Hypodermic Needles
- Electronic Blood Pressure Monitors

Date: 2019-09-24

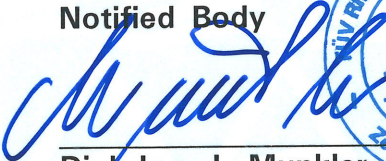
Notified Body



Dipl.-Ing. I. Munkler

Gültig ab:	15.04.2021	KONFORMITÄTSERKLÄRUNG DECLARATION OF CONFORMITY	 THE MEDICAL SERVICES COMPANY
Revisionsnr.	05		
Erstellt	MIT		
Geprüft	BAR		
Freigegeben	ZWE		
Seite:	Seite 1 von 2	RG0005	
Vertraulichkeit:		Dieses Dokument und jede enthaltene Information sind Eigentum der Firma MED TRUST Handelsgesellschaft m.b.H. Zugang nur für einen definierten Personenkreis. This document and all information contained herein is proprietary of MED TRUST Handelsgesellschaft m.b.H. Access only for a defined group of people.	



Hersteller/Manufacturer:

MED TRUST Handelsges.m.b.H.
Gewerbepark 10
7221 Marz
AUSTRIA

Produktspezifikation / Product details:	Produkttyp / Product Type: Blood glucose/cholesterol/uric acid monitoring systems, meters	
Artikelnummer / Article number	WELL600TW	Wellion LUNA trio, white, mg/dl
Produktname / Product name	WELL600TWMM	Wellion LUNA trio, white, mmol/l
Produktbeschreibung / Product description	WELL600TB	Wellion LUNA trio, black, mg/dl
	WELL600TBMM	Wellion LUNA trio, black, mmol/l
	WELL600TP	Wellion LUNA trio, pink, mg/dl
	WELL600TPMM	Wellion LUNA trio, pink, mmol/l
	WELL600TY	Wellion LUNA trio, yellow, mg/dl
	WELL600TYMM	Wellion LUNA trio, yellow, mmol/l
Klassifikation nach / Classification according	Annex II, List B, Self-testing	
Umfang / Scope	Diese Konformitätserklärung gilt ausschließlich in Verbindung mit einem chargenbezogenen Freigabedokument. This Declaration of Conformity applies only in conjunction with a batch-related release document.	

Konformitätsbewertung / Assessment details:

Benannte Stelle / Notified body	TÜV Rheinland LGA Products GmbH Tillystraße 2 90431 Nürnberg Deutschland
Verfahren nach / Procedure according to	IVDD 98/79/EC, Annex IV, excluding sections 4 and 6
Zertifikate/ Certificates	HL 1178843-1

Gültig ab:	15.04.2021	KONFORMITÄTSERKLÄRUNG DECLARATION OF CONFORMITY	 <small>THE MEDICAL SERVICES COMPANY</small>
Revisionsnr.	05		
Erstellt	MIT		
Gepprüft	BAR		
Freigegeben	ZWE		
Seite:	Seite 2 von 2	RG0005	
Vertraulichkeit:		Dieses Dokument und jede enthaltene Information sind Eigentum der Firma MED TRUST Handelsgesellschaft m.b.H. Zugang nur für einen definierten Personenkreis. This document and all information contained herein is proprietary of MED TRUST Handelsgesellschaft m.b.H. Access only for a defined group of people.	

Harmonisierte Normen / Harmonized standards* Aktueller Stand per / Current status per: 16.05.2022

EN ISO 13485:2016, EN ISO 15197:2015, EN ISO 14971:2012, EN ISO 17511:2003, EN ISO 18113-1:2011, EN ISO 18113-2:2011, EN ISO 18113-3:2011, EN ISO 18113-4:2011, EN ISO 18113-5:2011, EN ISO 15223-1:2016, EN 13532:2002, EN 13612:2002/AC:2002, EN ISO 23640:2015, EN 13975:2003, EN ISO 18153:2003

*) <https://ec.europa.eu/growth/single-market/european-standards/harmonised-standards/iv-diagnostic-medical-devices/>

Wir erklären in alleiniger Verantwortung, dass die oben beschriebenen Produkte den einschlägigen Bestimmungen der Medizinprodukte-Richtlinie 98/79/EC und deren Umsetzungen in nationale Gesetze entsprechen. Die Produkte werden mit CE-Kennzeichnung versehen.

Die Produkte entsprechen den anzuwendenden Normen in der jeweils gültigen Form.

We declare under sole responsibility that the products described above meet the provisions of the directive 98/79/EC and its transpositions in national laws, which apply to it. The products are CE marked.

The products comply with the applicable standards in its actual version.



Gültig bis / Valid until: 26.05.2024



Marz, 16.05.2022

Ort, Datum / Place, Date

Mag.oec. Jeleⁿa Suver, QM Department

Name, Unterschrift / Name, Signature
Abteilung / Department



Gültig ab:	15.04.2021	KONFORMITÄTSERKLÄRUNG DECLARATION OF CONFORMITY	 THE MEDICAL SERVICES COMPANY
Revisionsnr.	05		
Erstellt	MIT		
Geprüft	BAR		
Freigegeben	ZWE		
Seite:	Seite 1 von 2	RG0005	
Vertraulichkeit:		Dieses Dokument und jede enthaltene Information sind Eigentum der Firma MED TRUST Handelsgesellschaft m.b.H. Zugang nur für einen definierten Personenkreis. This document and all information contained herein is proprietary of MED TRUST Handelsgesellschaft m.b.H. Access only for a defined group of people.	

Hersteller/Manufacturer:

MED TRUST Handelsges.m.b.H.
Gewerbepark 10
7221 Marz
AUSTRIA

Produktspezifikation / Product details:	Produkttyp / Product Type: Blood glucose/cholesterol/uric acid monitoring systems, test strips	
Artikelnummer / Article number	WELL610	Wellion LUNA TEST STRIPS 10 GLU
Produktname / Product name	WELL612	Wellion LUNA TEST STRIPS 25 GLU
Produktbeschreibung / Product description	WELL615	Wellion LUNA TEST STRIPS 50 GLU
	WELL610_FOIL	Wellion LUNA TEST STRIPS 10GLU
	WELL612_FOIL	Wellion LUNA TEST STRIPS 25 GLU
	WELL615_FOIL	Wellion LUNA TEST STRIPS 50 GLU
	WELL610CHOL	Wellion LUNA TEST STRIPS 10 CHOL
	WELL611CHOL	Wellion LUNA TEST STRIPS 5 CHOL
	WELL612CHOL	Wellion LUNA TEST STRIPS 25 CHOL
	WELL610UA	Wellion LUNA TEST STRIPS 10 UA
	WELL612UA	Wellion LUNA TEST STRIPS 25 UA
	Klassifikation nach / Classification according Umfang / Scope	Annex II, List B, Self-testing Diese Konformitätserklärung gilt ausschließlich in Verbindung mit einem chargenbezogenen Freigabedokument. This Declaration of Conformity applies only in conjunction with a batch-related release document.



Konformitätsbewertung / Assessment details:

Benannte Stelle / Notified body	TÜV Rheinland LGA Products GmbH Tillystraße 2 90431 Nürnberg Deutschland
Verfahren nach / Procedure according to	IVDD 98/79/EC, Annex IV, excluding sections 4 and 6
Zertifikate/ Certificates	HL 1178843-1

Harmonisierte Normen / Harmonized standards* Aktueller Stand per / Current status per: 16.05.2022

EN ISO 13485:2016, EN ISO 15197:2015, EN ISO 14971:2012, EN ISO 17511:2003, EN ISO 18113-1:2011, EN ISO 18113-2:2011, EN ISO 18113-3:2011, EN ISO 18113-4:2011, EN ISO 18113-5:2011, EN ISO 15223-1:2016, EN 13532:2002, EN 13612:2002/AC:2002, EN ISO 23640:2015, EN 13975:2003, EN ISO 18153:2003

*) <https://ec.europa.eu/growth/single-market/european-standards/harmonised-standards/iv-diagnostic-medical-devices/>

Gültig ab:	15.04.2021	KONFORMITÄTSERKLÄRUNG DECLARATION OF CONFORMITY	 <small>THE MEDICAL SERVICES COMPANY</small>
Revisionsnr.	05		
Erstellt	MIT	RG0005	
Gepüft	BAR		
Freigegeben	ZWE		
Seite:	Seite 2 von 2		
Vertraulichkeit:		Dieses Dokument und jede enthaltene Information sind Eigentum der Firma MED TRUST Handelsgesellschaft m.b.H. Zugang nur für einen definierten Personenkreis. This document and all information contained herein is proprietary of MED TRUST Handelsgesellschaft m.b.H. Access only for a defined group of people.	

Wir erklären in alleiniger Verantwortung, dass die oben beschriebenen Produkte den einschlägigen Bestimmungen der Medizinprodukte-Richtlinie 98/79/EC und deren Umsetzungen in nationale Gesetze entsprechen. Die Produkte werden mit CE-Kennzeichnung versehen.

Die Produkte entsprechen den anzuwendenden Normen in der jeweils gültigen Form.

We declare under sole responsibility that the products described above meet the provisions of the directive 98/79/EC and its transpositions in national laws, which apply to it. The products are CE marked.

The products comply with the applicable standards in its actual version.



Gültig bis / Valid until: 26.05.2024

Marz, 16.05.2022

Ort, Datum / Place, Date



MED TRUST HANDELSGES. M.B.H.
A-7221 MARZ; GEWERBE PARK 10

Mag. o.c.c. Jelena Suver, QM/Department

Name, Unterschrift / Name, Signature
Abteilung / Department



Gültig ab:	20.04.2021	KONFORMITÄTSERKLÄRUNG DECLARATION OF CONFORMITY	 THE MEDICAL SERVICES COMPANY
Revisionsnr.	05		
Erstellt	MIT		
Geprüft	BAR		
Freigegeben	ZWE		
Seite:	Seite 1 von 2	RG0043	
Vertraulichkeit:		Dieses Dokument und jede enthaltene Information sind Eigentum der Firma MED TRUST Handelsgesellschaft m.b.H. Zugang nur für einen definierten Personenkreis. This document and all information contained herein is proprietary of MED TRUST Handelsgesellschaft m.b.H. Access only for a defined group of people.	

Hersteller/Manufacturer:
MED TRUST Handelsges.m.b.H.
Gewerbepark 10
A-7221 Marz

Produktspezifikation / Product details:		Produkttyp / Product Type: Blood lancets
Artikelnummer / Article number	WELL210	Wellion LANCETS 28G, 10ct
Produktname / Product name	WELL240	Wellion LANCETS 28G, 25ct
Produktbeschreibung / Product description	WELL250	Wellion LANCETS 28G, 50ct
	WELL208	Wellion LANCETS 28G, 100ct
	WELL200	Wellion LANCETS 28G, 200ct
	WELL213	Wellion LANCETS 33G, 10ct
	WELL253	Wellion LANCETS 33G, 50ct
	WELL207	Wellion LANCETS 33G, 100ct
	WELL203	Wellion LANCETS 33G, 200ct
	WELL240HH	Wellion LANCETS 28G, 25ct
	WELL250HH	Wellion LANCETS 28G, 50ct
	WELL208HH	Wellion LANCETS 28G, 100ct
WELL200HH	Wellion LANCETS 28G, 200ct	
WELL210HH	Wellion LANCETS 28G, 10ct	
WELL253HH	Wellion LANCETS 33G, 50ct	
WELL207HH	Wellion LANCETS 33G, 100ct	
WELL203HH	Wellion LANCETS 33G, 200ct	
WELL213HH	Wellion LANCETS 33G, 10ct	
Klassifikation nach / Classification according Umfang / Scope	Annex IX, <i>Class IIa, Rule 6</i>	Diese Konformitätserklärung gilt ausschließlich in Verbindung mit einem chargenbezogenen Freigabedokument. This Declaration of Conformity applies only in conjunction with a batch-related release document.

Konformitätsbewertung / Assessment details:

Benannte Stelle / Notified body	TÜV Rheinland LGA Products GmbH Tillystraße 2 90431 Nürnberg Deutschland
Verfahren nach / procedure according to	MDD 93/42/EEC, Anhang/Annex VII in Verbindung mit/combined with Anhang/Annex V
Zertifikate/ Certificates	DD 60141729 0001

Gültig ab:	20.04.2021	KONFORMITÄTSERKLÄRUNG DECLARATION OF CONFORMITY	 THE MEDICAL SERVICES COMPANY
Revisionsnr.	05		
Erstellt	MIT		
Geprüft	BAR		
Freigegeben	ZWE		
Seite:	Seite 2 von 2	RG0043	
Vertraulichkeit:		Dieses Dokument und jede enthaltene Information sind Eigentum der Firma MED TRUST Handelsgesellschaft m.b.H. Zugang nur für einen definierten Personenkreis. This document and all information contained herein is proprietary of MED TRUST Handelsgesellschaft m.b.H. Access only for a defined group of people.	

Harmonisierte Normen / Harmonized standards*

Aktueller Stand per / Current status per: 20.05.2021

EN ISO 13485:2016, EN ISO 14971:2012, EN ISO 10993-1:2009, EN ISO 10993-5:2009, EN ISO 10993-11:2018, EN ISO 15223-1:2016, EN 1041:2008, EN ISO 11607-1:2009, EN ISO 11607-2:2006, EN ISO 11737-1:2006/AC:2009, EN ISO 11737-2:2009, EN ISO 11137-1:2015, EN 556-1:2001/AC:2006

*) https://ec.europa.eu/growth/single-market/european-standards/harmonised-standards/medical-devices_en

Wir erklären in alleiniger Verantwortung, dass die oben beschriebenen Produkte den einschlägigen Bestimmungen der Medizinprodukte-Richtlinie 93/42/EWG und deren Umsetzungen in nationale Gesetze entsprechen. Die Produkte werden mit CE-Kennzeichnung versehen.

Die Produkte entsprechen den anzuwendenden Normen in der jeweils gültigen Form.

We declare under sole responsibility that the products described above meet the provisions of the directive 93/42/EEC and its transpositions in national laws which apply to it. The products are CE marked.

The products comply with the applicable standards in its actual version.

CE 0197

Gültig bis / Valid until: 27.05.2023



Marz, 20.05.2021

Ort, Datum / Place, Date

Doris Steiger / QM

Name, Unterschrift / Name, Signature
Abteilung / Department

MED TRUST HANDELSGES.M.B.H.
A-7221 MARZ; GEWERBEPARK 10
TEL: 02626/63190 FAX: 02626/64190-77

Valid from:	02.07.2020	Product Description and Specification	 THE MEDICAL SERVICES COMPANY
Revisionnr	08		
Created	FEI		
Checked	FIG		
Approved	FEI		
Pages:	Seite 1 von 5		
Confidentiality:		This document and all information contained herein is proprietary of MED TRUST Handelsgesellschaft m.b.H.	



Product trade name and general description of the product:

Wellion LUNA trio monitoring system is a portable, battery-powered devices, used together with Wellion LUNA glucose or cholesterol or uric acid test strips to measure glucose or cholesterol or uric acid in fresh capillary whole blood.

Manufacturer: MED TRUST Handelsges.m.b.H.
Gewerbepark 10
7221 MARZ
AUSTRIA

Overview of products/ product groups/ product variants:

Products	Article no./	Names	UDI-DI
	Meters		
	WELL600TW	Wellion LUNA trio meter white mg	n.a.
	WELL600TB	Wellion LUNA trio meter black mg	n.a.
	WELL600TP	Wellion LUNA trio meter pink mg	n.a.
	WELL600TY	Wellion LUNA trio meter yellow mg	n.a.
	WELL600TWMM	Wellion LUNA trio meter white mmol	n.a.
	WELL600TBMM	Wellion LUNA trio meter black mmol	n.a.
	WELL600TPMM	Wellion LUNA trio meter pink mmol	n.a.
	WELL600TYMM	Wellion LUNA trio meter yellow mmol	n.a.
	Test strips		
	WELL610	Wellion LUNA GLU test strips 10ct	n.a.
	WELL612	Wellion LUNA GLU test strips 25ct	n.a.
	WELL615	Wellion LUNA GLU test strips 50ct	n.a.
	WELL610CHOL	Wellion LUNA CHOL test strips 10ct	n.a.
	WELL612CHOL	Wellion LUNA CHOL test strips 25ct	n.a.
	WELL610UA	Wellion LUNA UA test strips 10ct	n.a.
	WELL612UA	Wellion LUNA UA test strips 25ct	n.a.
	Control solutions		
	WELL670	Wellion LUNA GLU control solution 0	n.a.
	WELL675	Wellion LUNA GLU control solution 1	n.a.
	WELL680	Wellion LUNA GLU control solution 2	n.a.
	WELL675CHOL	Wellion LUNA CHOL control solution 1	n.a.
	WELL680CHOL	Wellion LUNA CHOL control solution 2	n.a.
	WELL675UA	Wellion LUNA UA control solution 1	n.a.
Product group	Blood glucose, cholesterol, uric acid monitoring systems (meters, test strips, control solutions)		

Valid from:	02.07.2020	Product Description and Specification	
Revisionnr	08		
Created	FEI		
Checked	FIG		
Approved	FEI		
Pages:	Seite 2 von 5	RG0037	
Confidentiality:		This document and all information contained herein is proprietary of MED TRUST Handelsgesellschaft m.b.H.	

Visual appearance of Wellion LUNA trio meters and of three types of test strips:



Wellion LUNA trio meters, all colours



Wellion LUNA glucose test strip



Wellion LUNA cholesterol test strip



Wellion LUNA uric acid test strip



Basis-UDI-DI: n.a.

Product description:

The Wellion LUNA trio glucose (GLU), cholesterol (CHOL), uric acid (UA) monitoring system is intended for the quantitative measurement of glucose, cholesterol or uric acid in fresh capillary whole blood samples drawn from the fingertips, forearm, or palm. Testing is done outside the body (in vitro diagnostic use). It is intended for both self-testing use by people and professional use by healthcare professionals in a clinical setting, as an aid to monitoring levels in Diabetes mellitus or monitoring the blood cholesterol or uric acid values. It is not intended for the diagnosis of Diabetes disease or other diseases caused by altered cholesterol or uric acid values or for neonatal use.

UMDNS/GMDN classification (if applicable):

Product	EDMA code
----------------	------------------

Valid from:	02.07.2020	Product Description and Specification	RG0037	
Revisionnr	08			
Created	FEI			
Checked	FIG			
Approved	FEI			
Pages:	Seite 3 von 5			
Confidentiality:		This document and all information contained herein is proprietary of MED TRUST Handelsgesellschaft m.b.H.		

Wellion LUNA trio meters	21 07 10 01 00
Wellion LUNA UA test strips	11 70 01 06 00
Wellion LUNA UA control solution	11 50 02 90 00
Wellion LUNA GLU test strips	11 70 01 01 00
Wellion LUNA GLU control solutions	11 50 02 05 00
Wellion LUNA CHOL test strips	11 70 01 02 00
Wellion LUNA CHOL control solutions	11 50 02 02 00

Raw materials:

Meters:

Polycarbonate (lens), Acrylonitrile butadiene styrene (front case, buttons, back case, battery cover), rubber (foot pad),

Test Strips:

Polyethylene terephthalate (PET) and adhesive, Glucose oxidase (for glucose test strips), Cholesterol esterase, Cholesterol oxidase, Cholesterol peroxidase (for cholesterol test strips), uric acid (for uric acid test strips) and other ingredients (buffer, mediator, surfactant, stabilizer, etc.),

Control solutions:



Glucose, water, sodium benzoate, and fast red violet LB salt

Cholesterol, water, isopropanol, glycerol

Uric acid, dipotassium phosphate salt (buffer, additive), sodium benzoate (preserve agent)

Product Technical specifications:

Characteristics	Wellion LUNA trio blood glucose / cholesterol / uric acid monitoring system
Test strips shelf life	24 months (glucose), 18 months (cholesterol), 20 months (uric acid)
Test strips use life	12 months (glucose, when used only 25 times/12 months), 3 months (cholesterol, uric acid),
Test strips storage conditions	4°C - 30°C (39 - 86°F) (glucose, cholesterol, uric acid)
Ejection button	yes
Control solution	Wellion LUNA level 0, level 1, level 2 glucose control solutions Wellion LUNA level 1 and level 2 cholesterol control solutions Wellion LUNA level 2 uric acid control solution
Control solution shelf life	12 months
Control solution use life	3 months
Control solution storage conditions	Room temperature (10°C - 30°C) (39 - 86°F)

Valid from:	02.07.2020	Product Description and Specification	 THE MEDICAL SERVICES COMPANY
Revisionnr	08		
Created	FEI		
Checked	FIG		
Approved	FEI		
Pages:	Seite 4 von 5	RG0037	
Confidentiality:		This document and all information contained herein is proprietary of MED TRUST Handelsgesellschaft m.b.H.	

Measurement range	20 - 600 mg/dL (1.1 - 33.3 mmol/L) for glucose 100 - 400 mg/dL (2.59 - 10.35 mmol/L) for cholesterol 3 - 20 mg/dL (0.18 - 1.19 mmol/L) for uric acid
Sample volume	≥ 0.5 µl for glucose ≥ 0.8 µl for cholesterol ≥ 1 µl for uric acid
Test time	5 seconds (glucose) 26 seconds (cholesterol) 15 seconds (uric acid)
Hematocrit Limitation	25% - 60% (glucose) 35% - 50% (cholesterol) 30% - 50% (uric acid)
Altitude Limitation	3048 meters
Operation Environment	Temperature: 4°C - 45°C; RH: 10 - 90% (glucose) Temperature: 10°C - 40°C; RH: 10 - 90% (cholesterol, uric acid)
Memory Capabilities	360 test results (glucose), 50 test results (cholesterol, uric acid)
Battery Life	Approximately 1000 tests (glucose)
Power Source	One CR2032 3V Lithium coin battery
Dimension	87L x 58W x 23H mm
Weight	About 50g (incl. battery)

Accessories for the device, other devices and other products that are not medical devices, which are intended to be used in combination with it: n.a.



Exact software version (if applicable): V621

Designation / Classification:

The device is used for measurement of blood glucose, cholesterol or uric acid concentration in capillary blood samples. Therefore the Wellion LUNA trio blood glucose, cholesterol, uric acid monitoring system is classified according to Directive 98/79/EC, Annex II, List B.

Description of the principles of operation of the device and its mode of action:

The Wellion LUNA trio meter and its variants together with the Wellion LUNA GLU, CHOL, and UA test strips are designed to allow rapid measurement of blood glucose, cholesterol or uric acid by using an electrochemical detection technique. The Wellion LUNA trio monitoring system employs a disposable dry reagent strip technology. Specimen is applied to the tip of the strip and is automatically drawn into the reaction zone, then starts to react. During the reaction, electrons will be transferred to the electrode surface and generates a current. The amount of the current is proportional to the amount of glucose, cholesterol or uric acid present in the blood sample. The meter shows the test result within 5 seconds (glucose), 26 seconds (cholesterol) or 15 seconds (uric acid).



Valid from:	02.07.2020	Product Description and Specification	 THE MEDICAL SERVICES COMPANY
Revisionnr	08		
Created	FEI		
Checked	FIG		
Approved	FEI		
Pages:	Seite 5 von 5	RG0037	
Confidentiality:		This document and all information contained herein is proprietary of MED TRUST Handelsgesellschaft m.b.H.	

Revision History

Rev No	Date of change/name of author	Description of change
00-03	-	older template without revision history
04	22.07.2020, Ulrike Mitteregger	adding more detailed information according to new requirements of MDR (EU) 2017/745, adding revision history data
05	23.04.2021, Ulrike Mitteregger	Adding appearance of meters and three types of test strips

Date: 23.04.2021

Approved: Ulrike Mitteregger

Valid from:	02.07.2020	Product Description and Specification	 THE MEDICAL SERVICES COMPANY
Revisionnr	08		
Created	FEI		
Checked	FIG		
Approved	FEI		
Pages:	Seite 1 von 5	RG0037	
Confidentiality:		This document and all information contained herein is proprietary of MED TRUST Handelsgesellschaft m.b.H.	

Product trade name and general description of the product:

Wellion lancets are used to puncture skin to obtain capillary blood samples.

Manufacturer: *name and address*

MED TRUST Handelsges.m.b.H.
Gewerbepark 10, 7221 Marz, Austria

Tel : +43 02626 64190
Fax: +43 02626 64190-77

Overview of products/ product groups/ product variants: *Name, Reference Number*



Name	Reference number	Gauge	Packaging size (pcs)
Wellion lancets	WELL240HH	28	25
Wellion lancets	WELL250HH	28	50
Wellion lancets	WELL208HH	28	100
Wellion lancets	WELL200HH	28	200
Wellion lancets	WELL210HH	28	10
Wellion lancets	WELL253HH	33	50
Wellion lancets	WELL207HH	33	100
Wellion lancets	WELL203HH	33	200
Wellion lancets	WELL213HH	23	10

Basis-UDI-DI: n.a.

Product description: *including its intended use, indication(s), contraindication(s) and warnings, the intended patient group, intended user group and the medical conditions to be diagnosed/treated/monitored*

The sterile lancets are intended to be used together with a lancing device for skin puncture to obtain capillary blood samples for various medical testings, mainly for blood glucose level determination in diabetic people.

Wellion lancets are composed of three components: needle, main body and protective cap. Needle holder is a plastic part that enclosed the needle.

Valid from:	02.07.2020	Product Description and Specification	 THE MEDICAL SERVICES COMPANY
Revisionnr	08		
Created	FEI		
Checked	FIG		
Approved	FEI		
Pages:	Seite 2 von 5	RG0037	
Confidentiality:		This document and all information contained herein is proprietary of MED TRUST Handelsgesellschaft m.b.H.	



The Wellion lancets are sterilized by gamma irradiation.
The expiry date of the Wellion lancets is five years from the date of sterilization.

Intended use:

The sterile lancets (use with lancing device), is a single use, sterile medical device, which is designed for use of micro blood sampling puncture to obtain capillary blood samples from the fingertip.

The sterile lancet (using with lancing lancet) is home use device.

Contraindications/Warnings:

- Do not use lancet if protective cap is broken.
- Do not re-use lancet.
- Discard used lancet in appropriate container.

Intended patient group/intended user group:



Sterile lancets are home used products, which can be used by patients themselves.

UMDNS/GMDN classification (if applicable): UMDNS code: 10440

Raw materials:

The plastic (PE) that enclosed the needle is made from LDPE, the needle is made from stainless steel.

Lancet parts	Material
Needle	The needle is made of stainless steel. Stainless steel grade: SUS304
Needle holder (needle holder is the plastic that enclosed the needle)	The needle holder is made from LDPE, EVA and color master batch. LDPE grade: 2102TN00, JMC993P EVA grade: EVA14-2

Valid from:	02.07.2020	Product Description and Specification	RG0037	
Revisionnr	08			
Created	FEI			
Checked	FIG			
Approved	FEI			
Pages:	Seite 3 von 5	This document and all information contained herein is proprietary of MED TRUST Handelsgesellschaft m.b.H.		
Confidentiality:				

Product Technical specifications: *characteristics, dimensions and performance attributes of the device*

In general, Wellion Lancets consists of needle, main body and protective cap.

- 1-Needle
- 2-Main body
- 3-Protective cap

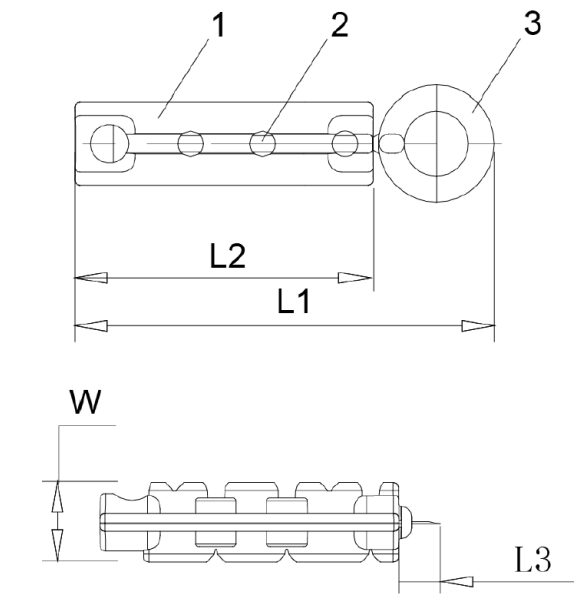



Specifications:

Gauge (G)	Total length (L1)	Handle length (L2)	Needle expose length (L3)	Handle length (W)	Needle diameter
28 G	32,0 ±1,5mm	22,9 ±0,3mm	3,2 ±0,3mm	6,4 ± 0,3mm	0,36 mm± 0,01 mm
33 G	32,0 ±1,5mm	22,9 ±0,3mm	3,2 ±0,3mm	6,4 ± 0,3mm	0,21 mm± 0,01 mm

Accessories for the device, other devices and other products that are not medical devices, which are intended to be used in combination with it:

Wellion lancets are intended to be used together with a lancing device.

Exact software version (if applicable): n.a.

Valid from:	02.07.2020	Product Description and Specification	
Revisionnr	08		
Created	FEI		
Checked	FIG		
Approved	FEI		
Pages:	Seite 4 von 5	RG0037	
Confidentiality:		This document and all information contained herein is proprietary of MED TRUST Handelsgesellschaft m.b.H.	

Designation / Classification: *Justification for the designation as a medical device and description of the classification of the device including justification for on the applied classification rule(s), exact identification of the applied indent, statement for the classification*

The Wellion lancets for single use are classified as class IIa products in accordance with Rule 6 specified in Annex IX of the Medical Device Directive 93/42/EEC.

The lancets are surgically invasive devices intended for transient use.

They are NOT intended to



- specifically for control, diagnose, monitor or correct a defect of the heart or of the central circulatory system through direct contact with these parts of the body
- be reusable surgical instruments
- specifically for use in direct contact with the central nervous system
- supply energy in the form of ionising radiation
- have a biological effect or to be wholly or mainly absorbed
- administer medicines by means of a delivery system, if this is done in a manner that is potentially hazardous taking account of the mode of application

therefore they are classified as class IIa in accordance with Rule 6 specified in Annex IX of MDD 93/42/EEC.

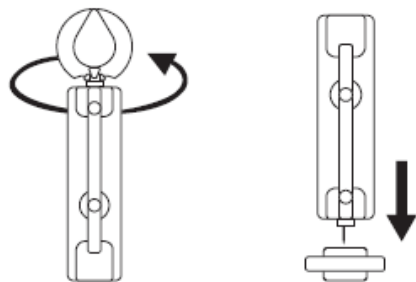
Description of the principles of operation of the device and its mode of action:



1. Wash hands with soap, dry thoroughly.
2. Select fingertip site, slightly off-center.
3. Remove the cover cap of lancing device and then insert the lancet.
4. Remove protective lancet cover and put the cover cap back on the lancing device, trigger the lancing device for puncture of the skin.
5. Afterwards, remove protective cap from lancing device, recap the lancet, discard in appropriate container.

Valid from:	02.07.2020	Product Description and Specification	RG0037	
Revisionnr	08			
Created	FEI			
Checked	FIG			
Approved	FEI			
Pages:	Seite 5 von 5	This document and all information contained herein is proprietary of MED TRUST Handelsgesellschaft m.b.H.		
Confidentiality:				

Instruction for use: pictures on the box:

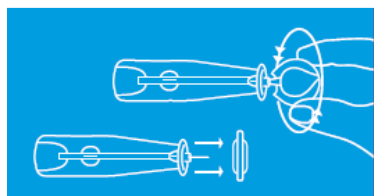

No separate instructions for use are needed for Wellion lancets. Due to the ease of use of the product, it is not necessary to include separate instructions for use, the pictures on the packaging are completely sufficient for the safe use of the product.

Revision History

Rev No	Date of change/name of author	Description of change
00	03.06.2020 Dr. Andrea Feiler	Creation of document
01	11.08.2020 Dr. Andrea Feiler	Transfer into new template of RG0037; Clearer structure, more detailed description of the product; method of sterilization added; picture of product and picture of the box (IFU) added

(First line retrospectively recorded from old record - the date of the creation of Rev. 00 lies before the creation of rev 08 of this form- RG0037 Product description and Specification)

Date: 11.08.2020

Approved: Dr. Andrea Feiler



Wellion[®]



DIABETES - UND GESUNDHEITS PRODUKTE
DIABETES AND HEALTH PRODUCTS





Ihre ÖSTERREICHISCHE Gesundheitsmarke
Your AUSTRIAN Health Brand

Durch unseren persönlichen Kontakt zu Menschen mit Diabetes wissen wir, welche Wünsche und Bedürfnisse im Alltag bestehen um das Leben mit Diabetes optimal gestalten zu können. Unter der Marke Wellion stehen unseren Kunden zahlreiche Qualitätsprodukte, die speziell für Diabetiker entwickelt wurden, zur Verfügung. Bei der Entwicklung unserer Produkte setzen wir auf laufendes und umfassendes Qualitätsmanagement. Die EN ISO 13485:2016 Norm ist die Basis für unsere hochwertigen und innovativen Produkte der Marke Wellion.

Through our personal contact to people with diabetes we know their needs and wants regarding their daily routine - it is our goal to make their life with diabetes easier.

Under the brand Wellion we provide numerous quality products to our customers that are specially designed for diabetics. When developing our products we focus on ongoing and comprehensive quality management. The EN ISO 13485:2016 norm is the basis for high-quality and innovative Wellion products.

EN ISO
15197:2015 

Die Wellion® Geräte erfüllen alle Kriterien der neuen
EN ISO 15197:2015

*The Wellion® devices fulfill all criteria of the new
EN ISO 15197:2015*

Wir sind laufend bemüht, die Wellion Linie um neue, innovative Produkte zu erweitern.

We constantly strive to expand the Wellion product line with new, innovative products.





wellion

LUNA*erica*



wellion

GALILEO_{GLU/KET}



GALILEO_{GLU/CHOL}



wellion

GALILEO*compact*

✓	✓	✓
✓	-	✓
-	✓	-
5 GLU, 26 CHOL 15 Harnsäure / Uric Acid	5 GLU 8 KET	5 GLU 90 CHOL
0,5 µl GLU, 0,8 µl CHOL 1,0 µl Harnsäure / Uric Acid	0,5 µl GLU 0,8 µl KET	0,5 µl GLU 3,6 µl CHOL
GOD	GOD	GOD
✓	✓	✓
-	✓	-
-	✓	-
✓	✓ Plus-Version	-
-	-	-
-	✓	-
-	✓	-
360 GLU, 50 CHOL 50 Harnsäure / Uric Acid	500 GLU 100 KET	500 GLU 100 CHOL
7, 14, 21, 28 - GLU	1, 7, 14, 30, 60, 90 - GLU	7, 14, 30
-	3 GLU, 3 KET	3 GLU, 3 CHOL
Dose / vial	GLU - Dose / vial KET - Folie / foil	GLU - Dose / vial CHOL - Folie / foil
9 Monate / months	12 Monate / months	12 Monate / months
-	-	-

LUNA

1 Gerät - 3 Messwerte
1 meter - 3 parameters

GALILEO

3 Geräte - 1 GLU Teststreifen
3 meters - 1 GLU test strip

wellion®

LUNA^{trio}



Drei Werte in ansprechendem Design

- Misst Blutzucker, Cholesterin und Harnsäure
- Handliche Form und gut lesbares Display
- Mit Auswurf-taste für benutzte Teststreifen
- Anti-Rutsch-Noppen
- Alle Messwerte werden automatisch gespeichert und lassen sich einfach abrufen

Three values in an appealing design

- Measures Blood Glucose, Cholesterol and Uric Acid
- Handy shape and easy to read display
- With eject button for used test strips
- Anti-slip nubs
- All readings are stored automatically and are easy to recall

Wellion LUNA Glukose Teststreifen / glucose test strips

Inhalt / Content	Artikelnummer / Article number	PhzNr AT	PhzNr DE
10 Stk	WELL610	4041042	00865680
50 Stk	WELL615	4041059	00865697

Wellion LUNA Cholesterin Teststreifen / cholesterol test strips

Inhalt / Content	Artikelnummer / Article number	PhzNr AT	PhzNr DE
5 Stk	WELL611CHOL	4097396	04857683
10 Stk	WELL610CHOL	4041065	00866053

Wellion LUNA Harnsäure Teststreifen / uric acid test strips

Inhalt / Content	Artikelnummer / Article number	PhzNr AT	PhzNr DE
10 Stk	WELL610UA	5210883	16151712



Die Wellion® LUNA Trio Blutzuckermessgeräte erfüllen alle Kriterien der neuen EN ISO 15197:2015.

The Wellion® LUNA Trio Blood Glucose Meters fulfill all criteria of the new EN ISO 15197:2015.



GROSSE, GUT LESBARE ZIFFERN
LARGE, CLEAR DIGITS



1000 MESSUNGEN BATTERIELEBENSDAUER
1000 TESTS BATTERY LIFE



AUSWURFTASTE
EJECT BUTTON



1x CR2032 BATTERIEN
1X CR2032 BATTERIES



DURCHSCHNITTSWERTE
AVERAGES



USB-ANSCHLUSS
USB-CONNECTION

BLUTZUCKER BLOOD GLUCOSE



KEIN KODIEREN
NO CODE



5 SEKUNDEN MESSDAUER
5 SECONDS TESTING TIME



360 SPEICHERWERTE
360 RESULTS IN MEMORY



0,5 MIKROLITER BLUT
0,5 MICRO LITER BLOOD

CHOLESTERIN CHOLESTEROL



CODE-STREIFEN
CODE-STRIP



26 SEKUNDEN MESSDAUER
26 SECONDS TESTING TIME



50 SPEICHERWERTE
50 RESULTS IN MEMORY



0,8 MIKROLITER BLUT
0,8 MICRO LITER BLOOD

HARNSÄURE URIC ACID



CODE-STREIFEN
CODE-STRIP



15 SEKUNDEN MESSDAUER
15 SECONDS TESTING TIME



50 SPEICHERWERTE
50 RESULTS IN MEMORY



1,0 MIKROLITER BLUT
1,0 MICRO LITER BLOOD



LUNA *trio*



wellion® LANCETS



Lanzetten sind
Einmalprodukte!
Do not reuse lancets!

Perfekter Schliff für eine sanfte Blutgewinnung

- Sterile Lanzette
- Ultrafeine Nadel für geringes Schmerzempfinden
- In zwei Nadelstärken erhältlich (28G, 33G)
- 33G Lanzette zur Blutgewinnung speziell bei Kindern und empfindlichen Personen geeignet

Perfect cut for gentle blood sampling

- Sterile lancet
- Ultra-fine needle minimizes pain
- In two different needle sizes (28G, 33G) available
- Super fine 33G lancet and therefore optimal for children and people with very sensitive skin.

Kopf eines Kugelschreibers Kopf einer Stecknadel 28G Lanzette 33G Lanzette
Ball-pen tip Pin head lancet lancet

2,5-fach vergrößerte Darstellung des Durchmessers
Diameter zoomed 2,5-times.

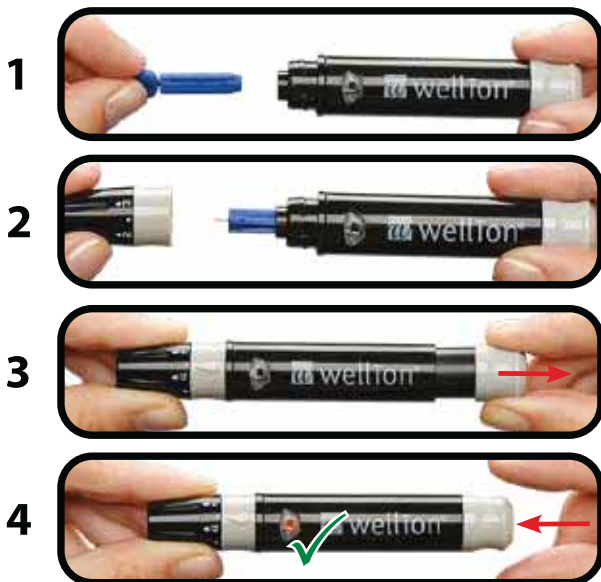

Nadelstärke needle size	Inhalt content	Art.Nr.	PhzNr AT	PhzNr DE
28G	50 Stk	WELL250	3144691	05014202
	100 Stk	WELL208	3387471	05485491
	200 Stk	WELL200	2480079	05014225
33G	50 Stk	WELL253	3144716	05014171
	100 Stk	WELL207	3387502	05485516
	200 Stk	WELL203	3144722	05014194



w wellion®



Ihre ÖSTERREICHISCHE Gesundheitsmarke
Your AUSTRIAN health brand



**Unser Bestreben ist es, Patienten und Partnern
das Leben zu erleichtern.**

Mit innovativen Ideen, Beratung und Service.

*We endeavour to make life easier for
patients and partners.*

Through innovative ideas, advice and service.

ÖSTERREICH:
MED TRUST Handelsges.m.b.H.
Gewerbepark 10 • 7221 Marz
Tel.: (+43)02626/64190 • Fax: DW 77
e-mail: office@medtrust.at
www.medtrust.at • www.wellion.at



DEUTSCHLAND:
MED TRUST GmbH
Bergener Ring 17-19 • 01458 Ottendorf - Okrilla
Tel.: (+49)035205/469-10 • Fax: DW 19
e-mail: office@medtrust.de
www.medtrust.de • www.wellion.eu/de