



EN

# **VWR Advanced Series Instruction Manual**

## **Hotplates, Stirrers, Hotplate-Stirrers**

## Table of Contents

1. INTRODUCTION .....	2
1.1. Safety Information .....	2
1.1. Consignes de sécurité .....	3
1.2. Intended Use .....	3
1.3. Package Contents .....	4
1.4. Installation .....	4
1.5. Overview .....	5
1.5.1 Dimensions .....	5
1.5.2 Device Setup .....	11
1.5.3 Display (Hotplate-Stirrers) .....	15
1.5.4 Display (Hotplate) .....	16
1.5.5 Display (Stirrer) .....	17
2. OPERATION .....	18
2.1 Getting Ready .....	18
2.2 Standby Mode .....	18
2.3 Controlling the Stirrer .....	19
2.4 Controlling the Top Plate Heater .....	20
2.5 Using the External Probe .....	22
2.6 The Settings Menu .....	23
2.6.1 Accessing / Exiting .....	23
2.6.2 Features .....	23
2.6.3 Structure & Defaults .....	24
2.7 Using the Single Point Calibration Feature .....	25
2.8 Enabling / Disabling the Beeper .....	29
2.9 Changing the Power Recovery Setting .....	30
2.10 Reset to Factory Default Settings .....	31
3. MAINTENANCE .....	33
3.1 Troubleshooting .....	33
3.2 Service Information .....	34
4. Technical Details .....	34
5. Compliance .....	35
5. Conformité .....	36
LIMITED WARRANTY .....	37
6. Replacement Parts .....	38
Declaration of Conformity .....	41

## 1. INTRODUCTION

This manual contains installation, operation and maintenance instructions for the VWR Advanced Series. Please read the manual completely before using.

### 1.1. Safety Information

Safety notes are marked with signal words and warning symbols. These show safety issues and warnings. Ignoring the safety notes may lead to personal injury, damage to the instrument, malfunctions and false results.

**WARNING** For a hazardous situation with medium risk, possibly resulting in severe injuries or death if not avoided.

**CAUTION** For a hazardous situation with low risk, resulting in damage to the device or the property or in loss of data, or minor or medium injuries if not avoided.

**ATTENTION** For important information about the product. May lead to equipment damage if not avoided.

**NOTE** For useful information about the product.

#### Warning Symbols



General hazard



Caution, hot surface



Electrical shock hazard

#### Safety Precautions



**WARNING! DO NOT** use the Hotplate-Stirrer / Hotplate / Stirrer in explosive atmospheres or with materials that could cause a hazardous environment from processing. Keep in mind the material flash point relative to the target temperature that has been set. Also, the user should be aware that the protection provided by the equipment may be impaired if used with accessories not provided by the manufacturer.

Always operate unit on a level surface for best performance and maximum safety.

**DO NOT** lift unit by the top plate.



**CAUTION!** To avoid electrical shock, completely cut off power to the unit by disconnecting the power cord from the wall outlet. Disconnect unit from the power supply prior to maintenance and servicing. Spills should be removed promptly after the unit has cooled down. **DO NOT** immerse the unit for cleaning. Alkalis spills, hydrofluoric acid or phosphoric acid spills may damage the unit and lead to thermal failure.



**CAUTION!** The top plate can reach 500°C; **DO NOT** touch the heated surface. Use caution at all times. Keep the unit away from explosive vapors and clear of papers, drapery, and other flammable materials. Keep the power cord away from the heater plate.



**CAUTION!** The rear panel of the 10x10-120V unit runs hot to the touch. Avoid contact during operation. Allow unit to cool before touching the rear panel.

**DO NOT** operate the unit at high temperatures without a vessel/sample on the top plate.

**DO NOT** operate the unit if it shows sign of electrical or mechanical damage.

**WARNING!** Units are NOT explosion proof. Use caution when heating volatile materials.



Earth Ground – Protective Conductor Terminal. Protective earthing of the equipment is achieved via connection of the provided power cord to a compatible grounded power outlet.



Alternating Current

## 1.1 Consignes de sécurité

Les consignes de sécurité sont signalées par des mots et des symboles d'avertissement. Elles présentent des risques et des avertissements. Le non-respect des consignes de sécurité peut entraîner des blessures, des dysfonctionnements, de faux résultats ou endommager l'instrument.

DANGER	Pour une situation dangereuse à risque modéré qui, si elle n'est pas évitée, peut entraîner des blessures graves ou la mort.
ATTENTION	Pour une situation dangereuse à faible risque qui, si elle n'est pas évitée, peut endommager l'appareil ou son environnement, causer une perte de données, ou entraîner des blessures mineures ou modérées.
AVERTISSEMENT	Pour des informations importantes sur le produit. Les ignorer peut endommager le produit.
REMARQUE	Pour des renseignements utiles sur le produit.

### Symboles d'avertissement



Risque général



Attention, surface chaude



Risque de décharge électrique

### Précautions d'emploi



**DANGER ! N'UTILISEZ PAS** l'agitateur chauffant dans des atmosphères explosives ou avec des matériaux dont le traitement pourrait produire un environnement dangereux. Gardez à l'esprit le rapport entre le point d'éclair du matériau et la température cible qui a été déterminée. De plus, l'utilisateur doit être conscient que la protection fournie par l'équipement peut être compromise s'il est utilisé avec des accessoires non fournis par le fabricant.

Pour de meilleures performances et une sécurité maximale, utilisez toujours l'appareil sur une surface de niveau.

**NE PAS** soulever l'appareil par la plaque chauffante.



**ATTENTION !** Pour éviter tout choc électrique, couper complètement l'alimentation électrique de l'appareil en débranchant le cordon d'alimentation de la prise murale. Débrancher de l'alimentation électrique avant la maintenance et l'entretien.

Les déversements de liquide doivent être retirés rapidement après le refroidissement de l'appareil.

**NE PAS** immerger l'appareil pour le nettoyage. Les déversements d'alcalis, d'acide fluorhydrique ou d'acide phosphorique peuvent endommager l'appareil et entraîner une défaillance thermique.



**ATTENTION !** La plaque chauffante peut atteindre 500 °C, **NE PAS** toucher la surface chauffée. Faites preuve de prudence à tout moment. Gardez l'appareil à l'écart des vapeurs explosives et des papiers, des tissus et autres matériaux inflammables. Maintenez le cordon d'alimentation éloigné de la plaque chauffante.



**ATTENTION !** Le panneau arrière du modèle 10x10-120V peut devenir très chaud. Évitez tout contact pendant le fonctionnement. Laissez l'appareil refroidir avant de toucher le panneau arrière.

**NE PAS** utiliser l'appareil à des températures élevées sans un récipient ou un échantillon sur la plaque chauffante.

**NE PAS** utiliser l'appareil s'il présente des signes de dommages électriques ou mécaniques.

**DANGER !** Les appareils ne sont PAS à l'épreuve des explosions. Soyez prudent lorsque vous chauffez des matières volatiles.



Mise à la terre - Borne du conducteur de protection. La protection de l'équipement par mise à la terre est réalisée par le branchement du cordon d'alimentation fourni à une prise compatible reliée à la terre.



Courant alternatif

## 1.2. Intended Use

The VWR Hotplate-Stirrer / Hotplate / Stirrer are intended for general laboratory use. Safety cannot be guaranteed if used outside of the intended use.

### 1.3. Package Contents

- Hotplate-Stirrer / Hotplate / Stirrer Unit
- Power Cord (pre-attached for 10x10-120V units)
- Stir Bar (40 x 8 mm) ((Stirring models only))
- Instruction Manual

### 1.4. Installation

Upon receiving the VWR Hotplate-Stirrer / Hotplate / Stirrer check to ensure that no damage has occurred during shipment. It is important that any damage that occurred in transport is detected at the time of unpacking. If you do find such damage, the carrier must be notified immediately.

After unpacking, place the Hotplate-Stirrer / Hotplate / Stirrer on a level bench or table, away from explosive vapors. Ensure that the surface on which the unit is placed will withstand typical heat produced by the unit and place the unit a minimum of six (6) inches from vertical surfaces. Do not position the equipment such that it is difficult to disconnect the power cord during use. Always place the unit on a sturdy work surface.

The Hotplate-Stirrer / Hotplate / Stirrer is supplied with a 3 conductor, grounded power cord that should be plugged into a matching standard grounded outlet. If the cord supplied does not meet your needs, please use an approved power cord that has ratings equal or exceeding those of the originally provided cord and that complies with the local/national regulations of the country in which the equipment is to be used. Replacement of the plug must be made by a qualified electrician.

## 1.5. Overview

### 1.5.1 Dimensions

#### Round Top Hotplate-Stirrer



Overall dimensions (L x W x H)	26.7 x 17.3 x 12.7 cm (10.5 x 6.8 x 5")
Top plate dimensions:	Ø 13.5 cm (5.3")
Top plate material:	Aluminum
Electrical (50/60 Hz):	120 volts ±10%: 8.3 amps: 996 watts 230 volts ±10%: 4.6 amps: 1058 watts
Fuses:	10A time-delay, 5x20mm, 250VAC
Temperature range:	Ambient +5° to 380°C
Temperature stability of top plate <sup>+</sup> :	± 3% > 100°C, ± 2% ≤ 100°C
Temperature stability with temperature probe <sup>++</sup> :	± 1% > 100°C, ± 1°C ≤ 100°C
Stir capacity:	10 L
Speed range:	60 to 1600 rpm
Speed stability:	± 2%
Weight capacity:	Up to 19.9 kg (44 lbs)
Ship weight:	2.3 kg (5.1 lbs)

**Note:** + 2" diameter center of top plate

++ Conditions permitting. Variations in temperature measurement process, vessel, ambient, and sample will impact actual performance. To improve accuracy of the system, please use the Single Point Calibration feature, more information in section 2.7

**7×7 Hotplate-Stirrer**

Overall dimensions (L x W x H)	30.7 x 22.4 x 12.2 cm (12.2 x 8.8 x 4.8")
Top plate dimensions:	17.8 x 17.8 cm (7 x 7")
Top plate material:	Ceramic
Electrical (50/60 Hz):	120 volts ±10%: 10.0 amps: 1200 watts 230 volts ±10%: 6.0 amps: 1380 watts
Fuses:	10A time-delay, 5x20mm, 250VAC
Temperature range:	Ambient +5° to 500°C
Temperature stability of top plate <sup>+</sup> :	± 3% > 100°C, ± 2% ≤ 100°C
Temperature stability with temperature probe <sup>++</sup> :	± 1% > 100°C, ± 1°C ≤ 100°C
Stir capacity:	10 L
Speed range:	60 to 1600 rpm
Speed stability:	± 2%
Weight capacity:	Up to 18.1 kg (40 lbs)
Ship weight:	3.5 kg (7.8 lbs)

**Note:** + 2" diameter center of top plate

++ Conditions permitting. Variations in temperature measurement process, vessel, ambient, and sample will impact actual performance. To improve accuracy of the system, please use the Single Point Calibration feature, more information in section 2.7

**7x7 Hotplate-Stirrer**

Overall dimensions (L x W x H)	30.7 x 22.4 x 12.2 cm (12.2 x 8.8 x 4.8")
Top plate dimensions:	17.8 x 17.8 cm (7 x 7")
Top plate material:	Aluminum
Electrical (50/60 Hz):	120 volts $\pm 10\%$ : 10.0 amps: 1200 watts 230 volts $\pm 10\%$ : 6.0 amps: 1380 watts
Fuses:	10A time-delay, 5x20mm, 250VAC
Temperature range:	Ambient $+5^\circ$ to $340^\circ\text{C}$
Temperature stability of top plate <sup>+</sup> :	$\pm 3\%$ $> 100^\circ\text{C}$ , $\pm 2\%$ $\leq 100^\circ\text{C}$
Temperature stability with temperature probe <sup>++</sup> :	$\pm 1\%$ $> 100^\circ\text{C}$ , $\pm 1^\circ\text{C}$ $\leq 100^\circ\text{C}$
Stir capacity:	10 L
Speed range:	60 to 1600 rpm
Speed stability:	$\pm 2\%$
Weight capacity:	Up to 18.1 kg (40 lbs)
Ship weight:	3.4 kg (7.4 lbs)

**Note:** + 2" diameter center of top plate

++ Conditions permitting. Variations in temperature measurement process, vessel, ambient, and sample will impact actual performance. To improve accuracy of the system, please use the Single Point Calibration feature, more information in section 2.7

**7x7 Hotplate**

Overall dimensions (L x W x H)	30.7 x 22.4 x 12.2 cm (12.1 x 8.8 x 4.8")
Top plate dimensions:	17.8 x 17.8 cm (7 x 7")
Top plate material:	Ceramic
Electrical (50/60 Hz):	120 volts $\pm 10\%$ : 10.0 amps: 1200 watts 230 volts $\pm 10\%$ : 6.0 amps: 1380 watts
Fuses:	10A time-delay, 5x20mm, 250VAC
Temperature range:	Ambient $+5^\circ$ to $500^\circ\text{C}$
Temperature stability of top plate <sup>+</sup> :	$\pm 3\%$ $> 100^\circ\text{C}$ , $\pm 2\%$ $\leq 100^\circ\text{C}$
Temperature stability with temperature probe <sup>++</sup> :	$\pm 1\%$ $> 100^\circ\text{C}$ , $\pm 1^\circ\text{C}$ $\leq 100^\circ\text{C}$
Weight capacity:	Up to 18.1 kg (40 lbs)
Ship weight:	2.8 kg (6.2 lbs)

**Note:** + 2" diameter center of top plate

++ Conditions permitting. Variations in temperature measurement process, vessel, ambient, and sample will impact actual performance. To improve accuracy of the system, please use the Single Point Calibration feature, more information in section 2.7

**7x7 Stirrer**

Overall dimensions (L x W x H)	30.7 x 22.4 x 12.2 cm (12.1 x 8.8 x 4.8")
Top plate dimensions:	17.8 x 17.8 cm (7 x 7")
Top plate material:	Ceramic or Resin
Electrical (50/60 Hz):	120 volts $\pm$ 10%: 1.0 amps: 120 watts 230 volts $\pm$ 10%: 0.5 amps: 115 watts
Fuses:	5A quick-acting, 5x20mm, 250VAC
Stir capacity:	10 L
Speed range:	60 to 1600 rpm
Speed stability:	$\pm$ 2%
Weight capacity:	Up to 18.1 kg (40 lbs)
Ship weight:	3.5 kg (7.8 lbs) Ceramic, or 2.5 kg (5.5lbs) Resin

**10X10 Hotplate-Stirrer**

Overall dimensions (L x W x H)	42.2 x 28.6 x 12.2 cm (16.3 x 11.25 x 4.8")
Top plate dimensions:	25.4 x 25.4 cm (10 x 10")
Top plate material:	Ceramic
Electrical (50/60 Hz):	120 volts $\pm 10\%$ : 11.2 amps: 1344 watts 230 volts $\pm 10\%$ : 7.0 amps: 1610 watts
Fuses:	120 volts: 15A quick-acting, 6.3x32mm, 125VAC 230 volts: 10A time-delay, 5x20mm, 250VAC
Temperature range:	Ambient +5° to 500°C
Temperature stability of top plate+:	$\pm 3\%$ > 100°C, $\pm 2\%$ $\leq$ 100°C
Temperature stability with temperature probe++:	$\pm 1\%$ > 100°C, $\pm 1^\circ\text{C}$ $\leq$ 100°C
Stir capacity:	13 L
Speed range:	60 to 1600 rpm
Speed stability:	$\pm 2\%$
Weight capacity:	Up to 18.1 kg (50 lbs)
Ship weight:	5.7 kg (12.6 lbs)

**Note:** + 2" diameter center of top plate

++ Conditions permitting. Variations in temperature measurement process, vessel, ambient, and sample will impact actual performance. To improve accuracy of the system, please use the Single Point Calibration feature, more information in section 2.7

## 1.5.2 Device Setup

### Hotplate-Stirrer (Round Top, 7x7, 10x10-230V)



- A. Display Screen**
- B. Standby Indicator**
- C. Left Knob:** Controls temperature and settings menu
- D. Right Knob:** Controls speed
- E. External RTD Probe Port**



- F. Fuse**
- G. Power Entry Module (PEM)**
- H. Threaded Knob for Accessory Rod**
- I. Standby Switch**
- J. Feet:** Not adjustable

**Hotplate-Stirrer (10x10-120V)**

**A. Display Screen**

**B. Standby Indicator**

**C. Left Knob:** Controls temperature and settings menu

**D. Right Knob:** Controls speed

**E. External RTD Probe Port**



**G. Power Cord**

**H. Threaded Knob for Accessory Rod**

**I. Standby Switch**

**J. Feet:** Not adjustable

**Hotplate (7x7)**

**A. Display Screen**

**B. Standby Indicator**

**C. Knob:** Controls temperature and settings menu

**E. External RTD Probe Port**

**F. Fuse**



**G. Power Entry Module (PEM)**

**H. Threaded Knob for Accessory Rod**

**I. Standby Switch**

**J. Feet:** Not adjustable

**Stirrer (7x7)**

- A. Display Screen**
- B. Standby Indicator**
- D. Knob:** Controls speed
- F. Fuse**



- G. Power Entry Module (PEM)**
- H. Threaded Knob for Accessory Rod**
- I. Standby Switch**
- J. Feet:** Not adjustable

### 1.5.3 Display (Hotplate-Stirrers)

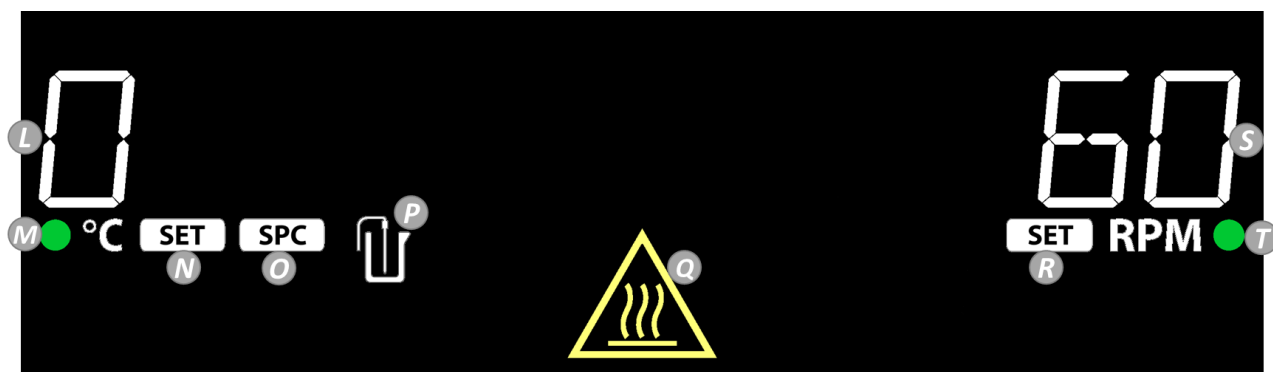

- L. Heater Temperature:** Switches to external probe temperature when the probe is plugged in and P is illuminated.
- M. Heater Indicator:** Illuminates when heater is running.
- N. Heat Setting Indicator:** Switches Heater Temperature (L) to Heat Setting when illuminated.
- O. Single Point Calibration Icon**
- P. External Probe Icon**
- Q. Hot Top Caution Indicator:** Illuminates when the heater is  $\geq 40^{\circ}\text{C}$ .
- R. Speed Setting Indicator:** Illuminates until stirrer reaches the Speed Setting (S).
- S. Speed Setting**
- T. Stirrer Indicator:** Illuminates when stirrer is running

### 1.5.4 Display (Hotplate)

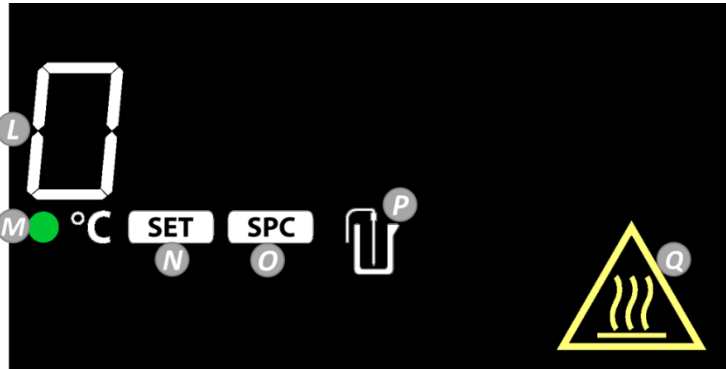

- L. Heater Temperature:** Switches to external probe temperature when the probe is plugged in and P is illuminated.
- M. Heater Indicator:** Illuminates when heater is running.
- N. Heat Setting Indicator:** Switches Heater Temperature (L) to Heat Setting when illuminated.
- O. Single Point Calibration Icon**
- P. External Probe Icon**
- Q. Hot Top Caution Indicator:** Illuminates when the heater is  $\geq 40^{\circ}\text{C}$ .

### 1.5.5 Display (Stirrer)



**R. Speed Setting Indicator:** Illuminates until stirrer reaches the Speed Setting (S).

**S. Speed Setting**

**T. Stirrer Indicator:** Illuminates when stirrer is running

## 2 OPERATION

### 2.1 Getting Ready

To get ready:

1. Plug the female end of the provided power cord into PEM (G) on the rear side of the unit.
2. Plug the male end of the power cord into a matching standard grounded outlet.
3. The unit will beep once and the screen will illuminate with three displays:

- a) The first will display the unit type (left) and the software version (right).
- b) The second will display the unit's electrical power (left) and frequency (right).
- c) The third will be the unit's main operating screen.

**Note:** If the third screen is blank and the red standby indicator (B) to the left of the screen is illuminated, the unit is in standby mode.

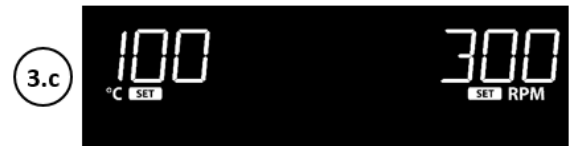

### 2.2 Standby Mode

1. The rocker switch (I) on the right side of the unit controls standby mode.
2. When the unit is switched off:
  - a) All heating and stirring functions will turn off.
  - b) The screen will be blank and the standby indicator (B) to the left of the screen will be illuminated.

If the heater temperature is above 40°C, the hot top caution indicator will remain illuminated as well as the current top plate temperature and "HOT".

3. When the unit is switched on:
  - a) All heating and stirring functions will remain off.
  - b) The main operating screen will return. Previous heating and stirring settings will be displayed.
  - c) The unit is ready for normal use.



## 2.3 Controlling the Stirrer

1. Rotate the right knob (D) to control the speed setting (S).

- a) Clockwise rotation will increase the speed setting (S).
- b) Counterclockwise rotation will decrease the speed setting (S).



2. To turn on the stirrer, press and hold the right knob (D) until the unit beeps and the stirrer indicator (T) illuminates.

- a) The unit will beep once to confirm the stirrer has been turned on.
- b) The stirrer indicator (T) next to the "RPM" symbol will blink to indicate that the stirrer is on and ramping to the target speed.
- c) Once the stirrer has reached the target speed, the speed setting indicator (R) will disappear and the stirrer indicator (T) will stop blinking and remain illuminated.



3. To change the speed setting while the stirrer is on:

- a) Rotate the right knob (D) to the new speed setting.

The speed setting (S) will blink to indicate that the speed setting is not confirmed.



- b) Briefly press the right knob (D) to confirm the new speed setting.

The speed setting (S) will stop blinking once the new setting is confirmed.



**Note:** If the speed setting (S) remains idle without confirmation for 6 seconds, it will reset to the current setting.

4. To turn off the stirrer, press and hold the right knob (D) until the unit beeps and the stirrer indicator (T) disappears.

- a) The unit will beep once to confirm the stirrer has been turned off.
- b) The stirrer indicator (T) next to the "RPM" symbol will disappear to indicate that the stirrer is off.
- c) The speed setting indicator (R) will illuminate.



### STIRRING OPERATING TIPS

The stirrer increases speed at a steady rate until the setpoint is reached. If the stirrer is not reaching its setpoint: 1) the stir bar may be too large, 2) the liquid may be too viscous, 3) the setpoint speed may need to be reduced. Additionally, the magnetic strength of stir bars reduce over time and may need to be replaced.

When heating and stirring a reaction vessel within an oil bath or similar set-up, the stirring function will stir up to approximately one inch (2.5 cm) from the top plate. The stirring speed will vary according to liquid viscosity, spin bar length, and distance from top plate. Adjust one or all of these to achieve the desired stirring speed. For example: the closer the reaction vessel is to the top plate, the stronger the magnetic connection between the unit and the stir bar.

### 2.4 Controlling the Top Plate Heater

1. Rotate the left knob (C) to control the heat setting (L).

- a) Clockwise rotation will increase the heat setting (L).
- b) Counterclockwise rotation will decrease the heat setting (L).

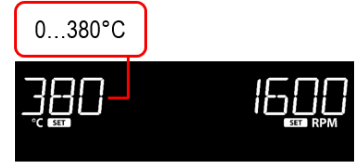

2. To turn on the heater, press and hold the left knob (C) until the unit beeps and the heater indicator (M) illuminates.

- a) The unit will beep once to confirm the heater has been turned on.
- b) The heater indicator (M) will illuminate next to the “°C” symbol to indicate that the heater is running.

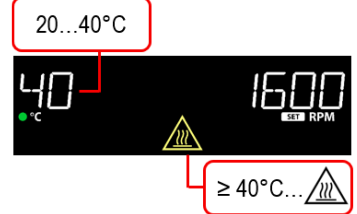

- c) The current heater temperature (L) will be alternately displayed with the heat setting (L) in the top left region of the screen.
- d) When the heater temperature (L) is above 40°C, the hot top caution indicator (Q) will be illuminated.

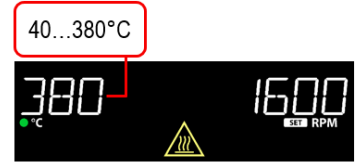

3. To change the heat setting (L) while the heater is on:

- a) Rotate the left knob (C) to the new heat setting.

The heat setting (L) will blink to indicate that the heat setting is not confirmed.

The heat setting indicator (N) will illuminate.

- b) Briefly press the left knob (C) to confirm the new heat setting.

The heat setting (L) will stop blinking once the new setting is confirmed.

If the heat setting (L) remains idle without confirmation for 6 seconds, it will reset to the current setting.

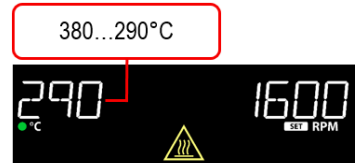
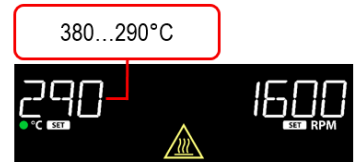

4. To turn off the heater, press and hold the left knob (C) until the unit beeps and the heater indicator (M) disappears.

- a) The unit will beep once to confirm the heater has been turned off.
- b) The heater indicator (M) next to the “°C” symbol will disappear to indicate that the heater is off.

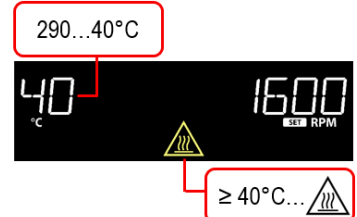

**CAUTION: This does not mean that the top plate is safe to touch.**

- c) Once the heater temperature (L) cools below 40°C, the hot top caution indicator (Q) will disappear.

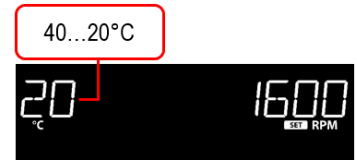

## HEATING OPERATING TIPS

### Overshoot:

The unit may overshoot the temperature up to 10°C before stabilizing at the setpoint. The two methods to minimize overshoot are:

1. Metal containers minimize overshoot.

**CAUTION! When heating metal containers on a ceramic top plate, it is recommended to use the lowest temperature setting possible to limit thermal stress to the ceramic top plate.**

2. If a glass vessel is used, anticipate overshoot. Start with a temperature setpoint 5 to 10°C below the desired temperature. When the temperature stabilizes at this lower setting, increase the heater to the final temperature. Overshoot is then reduced to about 1°C.

The temperature display on the units show the actual temperature of the heater, not the top plate or the sample. The vessel contents being heated may be at a lower temperature depending on the size and thermal conductivity of the vessel. It may be beneficial to monitor the temperature of the vessel contents and adjust the setpoint temperature accordingly. If you need precise control, use the VWR External Temperature Probe.

### Typical Time to Boil Water

The chart below is an example of an approximate time to boil for the specified amount of water in a specific vessel. These values are only approximate and can vary from unit to unit. Values are based on 23°C water in an ambient environment of 23°C.

Unit Size	Heater Temp. Limit	Volume of Water	Typical Time to Boil
Round Top	380°C	1L in 2L Beaker	≈ 24 min
7×7	500°C	1L in 2L Beaker	≈ 21 min
7x7 AL	340°C	1L in 2L Beaker	≈ 30 min
10×10	500°C	1L in 2L Beaker	≈ 25 min

## 2.5 Using the External Probe

1. Connect the VWR External Temperature Probe to the external RTD probe port (E) on the rear panel of the unit.

Once the VWR External Temperature Probe is connected, the external probe icon (P) will illuminate.

2. The temperature display (L) will now show the temperature of the external probe instead of the heater.

The hot top caution indicator (Q) will still illuminate once the heater temperature reaches 40°C.

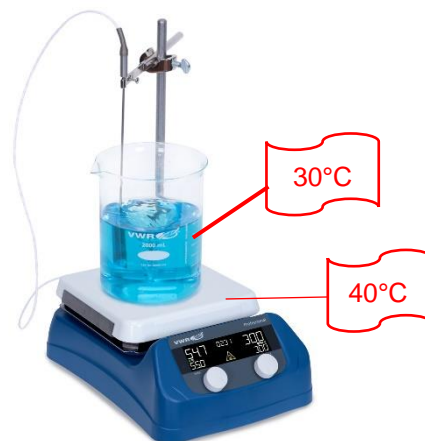

**Note:** When using the VWR External Temperature Probe, the temperature setpoint should be adjusted to the desired sample temperature. If the temperature setpoint is higher than the sample can achieve, an E7 will occur (see Troubleshooting section). Reduce sample volume or temperature setpoint value. For Example: Water has a theoretical temperature limit of 100°C (boiling). A temperature setpoint greater than 100°C will cause an E7 error.

3. If the VWR External Temperature Probe is inserted into the external RTD probe port (E) while the heater is running:

- a) The heater will shut off.
- b) The unit will display an E7 error.
- c) The unit will beep 10 times.
- d) All stirring functions will remain operational.

3.b

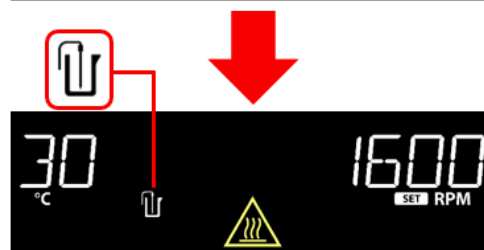

4. If the VWR External Temperature Probe is removed from the external RTD probe port (E) while the heater is running:

- a) The heater will shut off.
- b) The unit will display an E4 error.
- c) The unit will beep 10 times.
- d) All stirring functions will remain operational.

4.b



**Note:** To clear an E4 or E7 error code, flip the standby switch (I) off and back on. The unit will be ready for normal use.

## 2.6 The Settings Menu

### 2.6.1 Accessing / Exiting

The settings menu and the following features are only accessible in Hotplate and Hotplate-Stirrer units.

- To access the settings menu, press and hold the left knob (C) until 'MENU' appears on the screen.

- Continue to hold the left knob (C) after the unit beeps and the heater indicator (M) illuminates.

The heater will not turn on unless the left knob (C) is released before 'MENU' appears.

- The settings menu cannot be accessed while the heater or the stirrer is running.
- The "MENU" icon will appear briefly then proceed to the top level of the settings menu.



- Rotate the left knob (C) to navigate the different menu options and briefly press the left knob (C) to select / enter / edit the displayed setting.
- To exit the menu from the top level, rotate the left knob (C) clockwise until the "EXIT" icon is displayed and briefly press the left knob (C).

The unit will return to the main operating screen.

**Note:**

To exit the menu at any time, flip the standby switch (I) off and back on. The unit will be ready for normal use.

Turning off the unit will not reset / change the settings.



### 2.6.2 Features

The top level of the settings menu has the following features:

- "CAL" – Single Point Calibration

Single Point Calibration (SPC) improves the accuracy of the heater at user-selected temperature points. Up to 3 points (Plate) and 3 points (Probe) can be stored.

- "SYS" – System Settings

System Settings allows the user set additional features, such as Enabling / Disabling the Beeper, Changing the Power Recovery Setting, and Resetting to Factory Default Settings.

- "EXIT"

The unit will save the current settings and return to the main operating screen.



2.6.3 Structure & Defaults

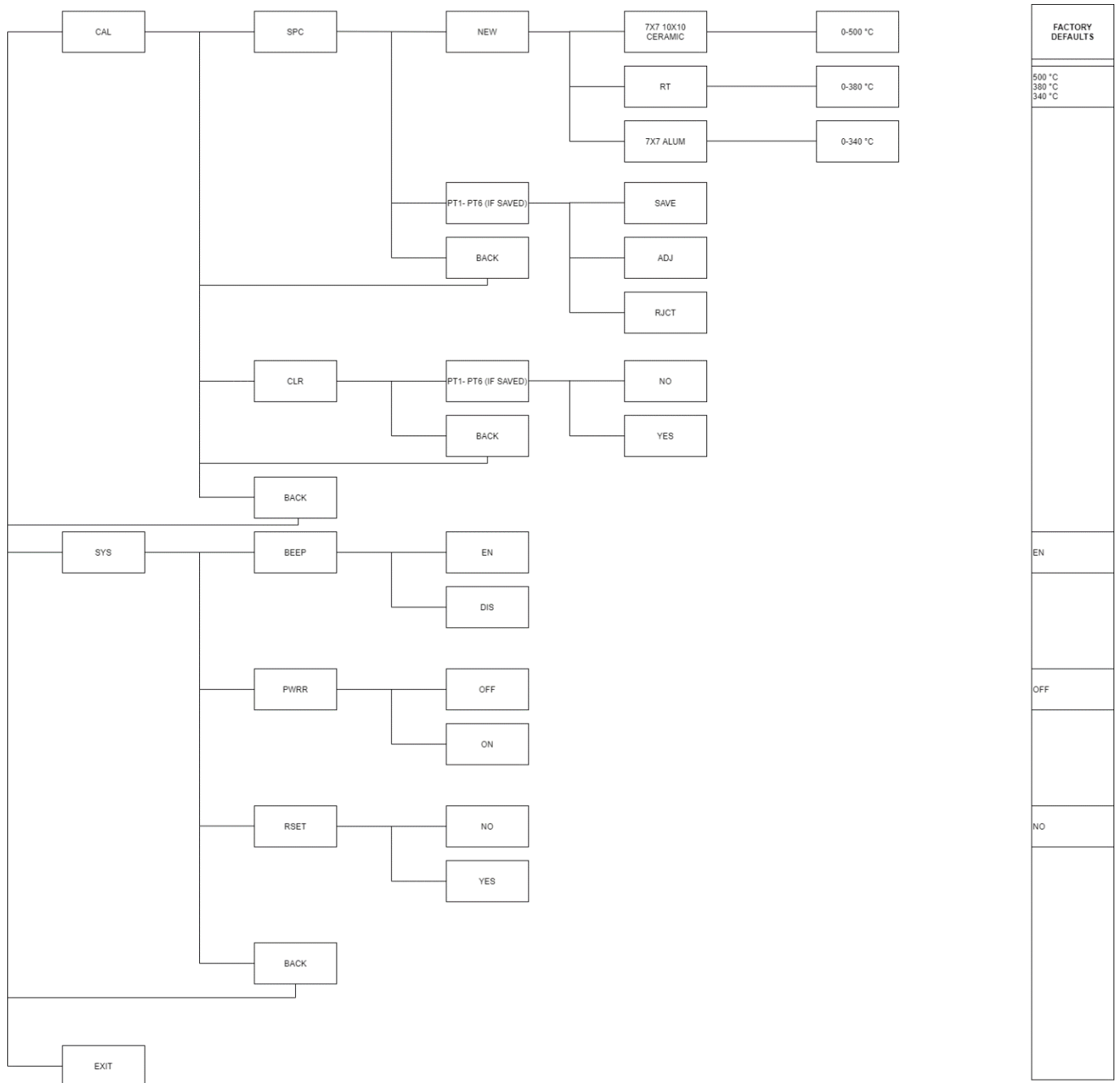

## 2.7 Using the Single Point Calibration Feature

Single Point Calibration (SPC) improves the accuracy of the heater at user-selected temperature points. Up to 1 point (Plate) and 1 point (Probe) can be stored at once.

1. To control the Single Point Calibration Feature, the unit must first be in the top level of the settings menu.



Menu



2. Rotate the left knob (C) to scroll to the 'CAL' feature.



3. Briefly press the left knob (C) to enter the Calibration settings menu.



4. Briefly press the left knob (C) to enter SPC settings menu.



5. Briefly press the left knob (C) again to change the temperature of the SPC.

The heat setting (L) will begin to blink to indicate that it can be modified.



6. Rotate the left knob (C) to scroll to the desired temperature.



7. Press and hold the left knob (C) until the unit beeps and the heater indicator (M) illuminates to begin SPC at that temperature.

- a) The unit will begin to heat to the set temperature.
- b) The 'SPC' icon (O) will blink to indicate that the SPC is running.
- c) The left (C) and right (D) knobs will be disabled until SPC is complete.
- d) If the external probe is connected, the stirrer will turn on at 300 rpm. (This only applies to Hotplate-Stirrer units.)
- e) To cancel SPC while it is running, turn off the unit with the standby switch (I) on the right side of the unit.

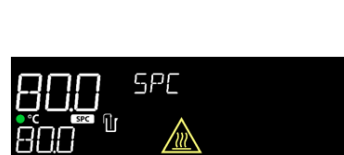

8. Once the unit has reached the calibration temperature, the SPC icon (O) and the heat setting will blink.
9. With a secondary temperature measurement device, measure the temperature of the top plate or the heated sample at the location of the external probe (if using probe control).

10. Rotate the left knob (C) to scroll to the measured temperature from the secondary temperature measurement device.



11. Briefly press the left knob (C) to select the new temperature calibration point.



12. The unit will begin to regulate temperature with compensated error.

When this is complete, the 'SAVE' icon will appear at the heat setting.



13. Measure the temperature at the same location as step 9.

14. Rotate the left knob (C) to:

- a) 'SAVE' – to retain calibration (stirring will stop if using probe control).
- b) 'ADJ' – to prompt fine tuning of calibration (return to step 10).
- c) 'RJCT' – to cancel the SPC process and return to the SPC menu.



15. Briefly press left knob (C) to select the desired menu option.

1



16. To adjust a calibrated temperature, return to the SPC menu (steps 1-4).



17. Rotate the left knob (C) to scroll to the desired SPC point.



18. Press and hold the left knob (C) until the unit beeps to begin SPC at that temperature.
- If the probe is connected, the unit will not run plate SPC points. Likewise, if the probe is disconnected, the unit will not run probe SPC points.
  - The unit will begin to heat to the set temperature.
  - The 'SPC' icon (O) will blink to indicate that the SPC is running.
  - The left (C) and right (D) knobs will be disabled until SPC is complete.
  - If the external probe is connected, the stirrer will turn on at 300 rpm. (This only applies to Hotplate-Stirrer units.)
  - To cancel SPC while it is running, turn off the unit with the standby switch (I) on the right side of the unit.



19. Repeat steps 8-15.

20. To clear a calibrated temperature point, return to the Calibration settings menu (step 1-3).



21. Rotate the left knob (C) to scroll to the 'CLR' feature.



22. Briefly press the left knob (C) to enter the Clear SPC menu.

If there are no stored SPC points, select 'BACK' to return to previous screen.



23. Rotate left knob (C) to scroll to the desired SPC point.

SPC points are stored in ascending order by temperature.



24. Briefly press the left knob (C) to select the point to clear.



25. Rotate the left knob (C) to confirm selection:

- 'YES' – to clear the selected SPC point.
- 'NO' – to return to Calibration settings menu.



26. Briefly press the left knob (C) to confirm selection and return to the Calibration settings menu.



27. To heat to a calibrated temperature, return to the main operating screen.



28. Rotate the left knob (C) to scroll the heat setting (L) to the desired calibrated temperature.

Notice that the 'SPC' icon (O) appears.

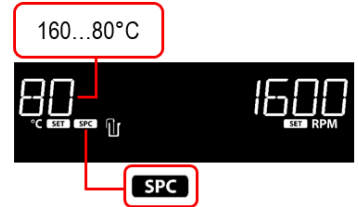

29. Press and hold the left knob (C) until the unit beeps and the heater indicator (M) illuminates.

The unit will heat to the adjusted temperature as calibrated.



## 2.8 Enabling / Disabling the Beeper

Disabling the Beeper Setting will prevent beeps in the following scenarios:

- Starting and Stopping the Heater
- Starting and Stopping the Stirrer
- When the heater reaches the set temperature
- Starting Single Point Calibration (SPC)

1. To control the Beeper Setting, the unit must first be in the top level of the settings menu.



Menu

MENU

2. Rotate the left knob (C) to scroll to the 'SYS' (System) setting.



SYS

3. Briefly press the left knob (C) to enter the System settings menu.



BEEP  
EN

4. Briefly press the left knob (C) to change the beeper setting.



BEEP  
EN

5. Rotate the left knob (C) to scroll to the desired beeper setting.

EN for enable and DIS for disable.



EN...DIS

BEEP  
DIS

6. Briefly press the left knob (C) to confirm the desired beeper setting.



BEEP  
DIS

7. Rotate the left knob (C) to the "BACK" icon.



BACK

8. Briefly press the left knob (C) to return to the top level of the settings menu.



SYS

9. Rotate the left knob (C) to scroll to the 'EXIT' icon.



10. Briefly press the left knob (C) to return to the main operating screen.

**Note:** There is not an icon to indicate that the beeper has been disabled.

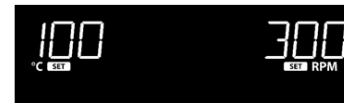

## 2.9 Changing the Power Recovery Setting

Power Recovery is an optional feature that allows the unit to automatically restart heater and stirrer functions when power is returned to the unit after a disconnect. By default, this feature is turned off.

1. To control the Power Recovery Feature, the unit must first be in the top level of the settings menu.



Menu

2. Use the left knob (C) to scroll to the 'SYS' (System) setting.



3. Briefly press the left knob (C) to enter the System settings menu.



4. Rotate the left knob (C) to the "PWRR" (Power Recovery) setting.



5. Briefly press the left knob (C) to change the Power Recovery settings.

The current Power Recovery setting will begin to blink.



6. Rotate the left knob (C) to scroll to the desired Power Recovery setting.

'OFF' – heating and stirring functions will need to be manually restarted after power restoration.

'ON' – heating and stirring functions will automatically restart upon power restoration.



7. Briefly press the left knob (C) to confirm the Power Recovery setting.



8. Rotate the left knob (C) to the "BACK" icon.



BACK

9. Briefly press the left knob (C) to return to the top level of the settings menu.



SYS

10. Rotate the left knob (C) to scroll to 'EXIT'.



EXIT

11. Briefly press the left knob (C) to return to the main operating screen.

**Note:** There is not an icon on the display to indicate that Power Recovery has been activated.



100 °C SET 300 RPM

## 2.10 Reset to Factory Default Settings

Resetting the unit to Factory Default Settings will do the following:

- Clear all single point calibration (SPC) temperatures.
- Turn off Power Recovery.
- Re-enable the beeper setting.

1. To reset the unit to factory default settings, the unit must first be in the top level of the settings menu.



Menu

MENU

2. Rotate the left knob (C) to scroll to the 'SYS' (System) setting.



SYS

3. Briefly press the left knob (C) to enter the System settings menu.



BEEP EN

4. Rotate the left knob (C) to the "RSET" (Reset) setting.



RSET

5. Briefly press the left knob (C) to change the Reset settings.

The current Reset setting will begin to blink.

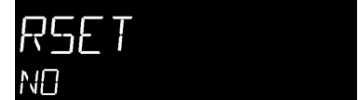

6. Rotate the left knob (C) to scroll to the desired Reset setting.

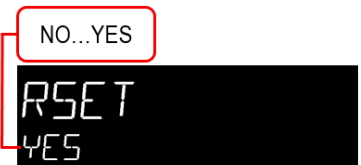

7. Press and hold the left knob (C) until the unit beeps to confirm the Reset setting.

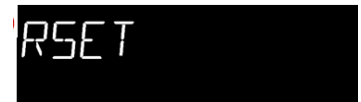

8. Rotate the left knob (C) to the "BACK" icon.



9. Briefly press the left knob (C) to return to the top level of the settings menu.



10. Rotate the left knob (C) to scroll to 'EXIT'.



11. Briefly press the left knob (C) to return to the main operating screen.

**Note:** There is not an icon on the display to indicate that the unit has been reset to factory default settings.

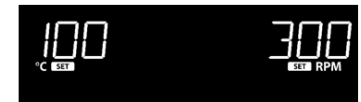

### 3 MAINTENANCE

The Hotplate-Stirrer / Hotplate / Stirrer is built for long, trouble-free, dependable service. No lubrication or other technical user maintenance is required. It needs no user maintenance beyond keeping the surfaces clean. The unit should be given the care normally required for any electrical appliance. Avoid wetting or unnecessary exposure to fumes. Spills should be removed promptly after the unit has cooled down. Before using any cleaning or decontamination method except as noted in this section, users should check with the manufacturer that the proposed method will not damage the equipment. Do not use a cleaning agent or solvent on the front panel which is abrasive or harmful to glass, nor one which is flammable. Always ensure the power is disconnected from the unit prior to any cleaning. If the unit ever requires service, contact your VWR representative. The user is responsible for carrying out appropriate decontamination if hazardous material is spilled onto or into the equipment

#### CLEANING CERAMIC TOPS:

First remove any burnt-on deposits or spills from the top plate with a scraper (similar to scraping paint off of windowpanes). For your safety, please wear an insulated mitt when using a metal scraper. When the top plate has cooled, apply a few dabs of a non-abrasive cleaner over the surface with a damp paper towel. As a final step, clean with water, and wipe surface with a clean, dry paper towel.

#### CLEANING ALUMINUM TOPS:

For simple dust and dirt, clean the aluminum top by using a damp cloth with soap and water. For more stubborn deposits, try using a flat edge wooden spatula to scrape off as much as possible. For more stubborn stains, try using a couple of tablespoons of white vinegar to two pints of water and mix well. Dip a clean cloth into the mixture and gently rub the exterior of the aluminum surface. Generally, it is not a good idea to use abrasive pads or cleaners on aluminum, as the metal will scratch easily. If you must use some type of abrasive, try applying baking soda to the surface and then rubbing with a moist cloth. This will work as well as most scouring pads and is less like to create deep scratches in the surface. Be careful not to use steel wool or scouring pads as they can leave the aluminum riddled with little scratches that make it harder to clean in the future. If you feel you must use steel wool, use the finest grade you can find and use as sparingly as possible with as little pressure as possible. Go with the grain rather than using circular motions.

#### 3.1 Troubleshooting

The following table lists common problems and possible causes and remedies. If the problem persists, contact VWR or your authorized dealer.

Error*	Cause of Error	How to Fix
Unit fails to power on	Missing or blown fuse	Add or replace fuse as necessary.
E1	Plate RTD open	Not fixable by user, please contact VWR.
E2	Plate RTD short	Not fixable by user, please contact VWR.
E3	No stirring motion / cannot reach speed	Not fixable by user, please contact VWR.
E4	Probe RTD open (Removing the probe while the unit is heating)	Switch unit to standby, then return to normal operating mode.
E5	Probe RTD short (Malfunctioning probe)	Switch unit to standby, remove the probe from the unit, then return to normal operating mode.
E6	A/D lock error	Not fixable by user, please contact VWR.
E7	User Probe Error (Plugging the probe into the unit while it is heating)	Switch unit to standby, then return to normal operating mode.
E8	Plate over temperature	Not fixable by user, please contact VWR.
E9	Plate under temperature	Not fixable by user, please contact VWR.
E10	Triac fault	Not fixable by user, please contact VWR.

\*Note: Error code instances will stop equipment operation by default.

### 3.2 Service Information

If the troubleshooting section does not resolve or describe your problem, contact your authorized VWR service agent. For service assistance or technical support in the United States call toll-free 1-888-897-5463 between 8:00 AM and 5:30PM EST. A VWR product service specialist will be available to provide assistance. Outside the USA, please visit our website, <https://vwr.com> to locate the VWR office nearest you.

Serial Number: \_\_\_\_\_

Date of Purchase: \_\_\_\_\_

Supplier: \_\_\_\_\_

## 4 Technical Details

### Operating Conditions: Indoor use only.

Temperature: 5 to 40°C (41 to 104°F)

Humidity: 20% to 80% relative humidity, non-condensing

Altitude: 0 to 2000 m (6,562 ft) above sea level

### Non-Operating Storage:





Temperature: -20 to 65°C (-4 to 149°F)

Humidity: 20% to 80% relative humidity, non-condensing

Installation Category II and Pollution Degree 2 in accordance with IEC 664

## 5 Compliance

Compliance to the following standards is indicated by the corresponding mark on the product.

Mark	Standard
	VWR Corporation declares that the Advanced series hotplates, stirrers, and hotplate-stirrers comply with directives 2011/65/EU, (EU) 2015/863, 2014/30/EU, 2014/35/EU, and standards EN 50581, EN 61010-2-010, EN 61010-2-051, EN 61326-1. The full text of the EU declaration of conformity is available at the following internet address: <a href="https://vwr.com">https://vwr.com</a> .
	This product complies with directive 2012/19/EU. Please dispose of this product in accordance with local regulations at the collecting point specified for electrical and electronic equipment. For disposal instructions in Europe, refer to <a href="https://vwr.com">https://vwr.com</a> .
	EN 61326-1
	CAN/CSA C22 261010-1, CAN/CSA C22 261010-2-010, CAN/CSA C22 261010-2-051 UL 61010-1, UL 61010-2-010, UL 61010-2-051

### Global Notice

Warning: This is a Class A product. In a domestic environment this product may cause radio interference in which case the user may be required to take adequate measures.

### Canada Notice

This Class A digital apparatus complies with Canadian ICES-003.

### FCC Notice

NOTE: This equipment has been tested and found to comply with the limits for a Class A digital device, pursuant to Part 15 of the FCC Rules. These limits are designed to provide reasonable protection against harmful interference when the equipment is operated in a commercial environment. This equipment generates, uses, and can radiate radio frequency energy and, if not installed and used in accordance with the instruction manual, may cause harmful interference to radio communications. Operation of this equipment in a residential area is likely to cause harmful interference in which case the user will be required to correct the interference at his own expense.

Changes or modifications not expressly approved by VWR Corporation could void the user's authority to operate the equipment.

## EQUIPMENT DISPOSAL







This equipment must not be disposed of with unsorted waste. It is your responsibility to correctly dispose of the equipment at life-cycle-end by handing it over to an authorized facility for separate collection and recycling. It is also your responsibility to decontaminate the equipment in case of biological, chemical, and/or radiological contamination, so as to protect the persons involved in the disposal and recycling of the equipment from health hazards.

For more information about where you can drop off your waste of equipment, please contact your local dealer from whom you originally purchased this equipment. By doing so, you will help to conserve natural and environmental resources and you will ensure that your equipment is recycled in a manner that protects human health.

## 5 Conformité

La conformité aux normes suivantes est indiquée par le symbol correspondant sur le produit.

Symbol	Norme
	VWR Corporation déclare que les plaques chauffantes, agitateurs et agitateurs-chauffants de la série Advanced sont conformes aux directives 2011/65/EU, (EU) 2015/863, 2014/30/EE, 2014/35/EU et aux normes EN 50581, EN 61010-2-010, EN 61010-2-051, EN 61326-1. Le texte intégral de la déclaration de conformité de l'UE est disponible à l'adresse Internet suivante: <a href="https://vwr.com">https://vwr.com</a> .
	Ce produit est conforme à la directive 2012/19/EU. Veuillez vous débarrasser de ce produit conformément à la réglementation locale au point de collecte prévu pour les équipements électriques et électroniques.  Pour les instructions de mise au rebut en Europe, consultez <a href="https://vwr.com">https://vwr.com</a> .
	EN 61326-1
	CAN/CSA C22 261010-1, CAN/CSA C22 261010-2-010, CAN/CSA C22 261010-2-051 UL 61010-1, UL 61010-2-010, UL 61010-2-051

### Notification mondiale

Avertissement: Il s'agit d'un produit de classe A. Dans un environnement domestique, ce produit peut entraîner des interférences radio, obligeant l'utilisateur à prendre les mesures qui s'imposent.

### Notification pour le Canada

Cet appareil numérique de classe A est conforme à la norme canadienne NMB-003.

### Notification relative à la FCC

REMARQUE: Cet équipement a été testé et déclaré conforme aux contraintes d'un appareil numérique de classe A, conformément à la partie 15 des règles de la FCC. Ces contraintes visent à assurer une protection suffisante contre les interférences nuisibles lorsque l'équipement est utilisé dans un environnement commercial. Cet équipement produit, utilise et peut émettre de l'énergie radioélectrique, et s'il n'est pas installé et utilisé conformément au mode d'emploi, peut provoquer des interférences nuisibles aux communications radio. L'utilisation de cet équipement dans une zone résidentielle est susceptible de provoquer des interférences nuisibles, auquel cas l'utilisateur sera tenu de corriger ces interférences à ses propres frais.

Les changements ou modifications non expressément approuvés par VWR Corporation pourraient annuler le droit de l'utilisateur à utiliser l'équipement.

## ÉLIMINATION DE L'ÉQUIPEMENT



Cet équipement ne doit pas être éliminé avec les déchets non triés. Il est de votre responsabilité d'éliminer correctement l'équipement à la fin de son cycle de vie en le remettant à un établissement agréé pour une collecte et un recyclage séparés. Il est également de votre responsabilité de décontaminer l'équipement en cas de contamination biologique, chimique et/ou radiologique, afin de protéger les personnes chargées de l'élimination et du recyclage de l'équipement contre tout risque pour leur santé.

Pour plus d'informations sur les endroits où vous pouvez déposer vos équipements, veuillez contacter le revendeur local auprès duquel vous avez initialement acheté cet équipement. Ce faisant, vous contribuerez à préserver les ressources naturelles et environnementales et vous veillerez à ce que votre matériel soit recyclé d'une manière qui protège la santé humaine.

## LIMITED WARRANTY

VWR products are warranted against defects in materials and workmanship from the date of delivery through the duration of the warranty period of five (5) years. During the warranty period VWR will repair, or, at its option, replace any component(s) that proves to be defective at no charge, provided that the product is returned, freight prepaid, to VWR.

This warranty does not apply if the product has been damaged by accident or misuse, exposed to radioactive or corrosive materials, has foreign material penetrating to the inside of the product, or as a result of service or modification by other than VWR. In lieu of a properly returned warranty registration card, the warranty period shall begin on the date of shipment to the authorized dealer. No other express or implied warranty is given by VWR Corporation. VWR Corporation shall not be liable for any consequential damages.

As warranty legislation differs from state to state and country to country, please contact VWR or your local VWR dealer for further details.

## 6 Replacement Parts

### Round Top Replacement Parts

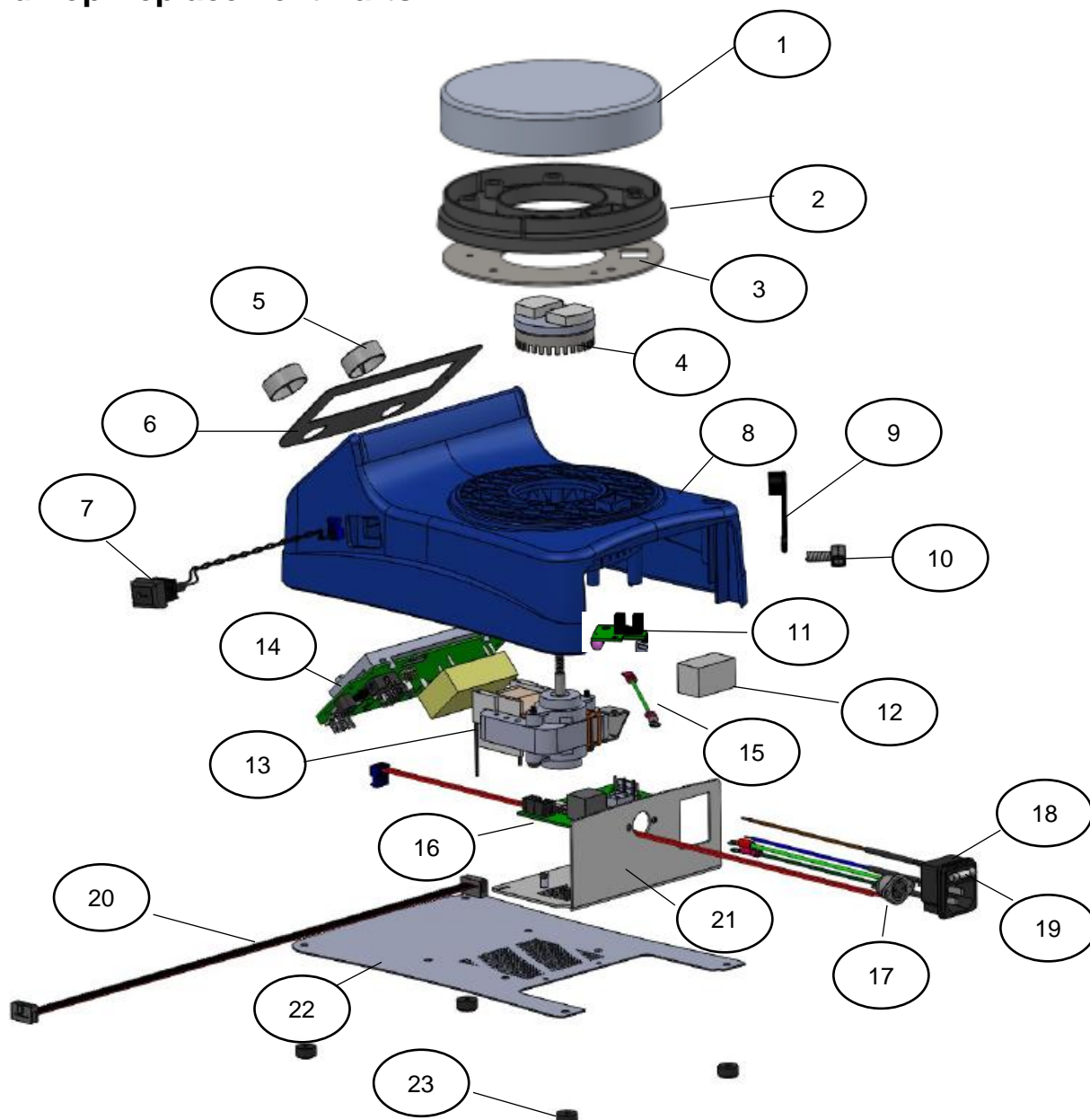

- |   |  |
|---|--|
| <p>1. Top plate assembly</p> <ul style="list-style-type: none"> <li>a. Hotplate stirrer 120V (30500474)</li> <li>b. Hotplate stirrer 230V (30500475)</li> </ul> <p>2. Plastic heat shield: (30589581)</p> <p>3. Metal heat shield: (30589573)</p> <p>4. Magnet: (30589595)</p> <p>5. Knob: (80855226)</p> <p>6. Front panel overlay: (80856819)</p> <p>7. Rocker switch: (30589612)</p> <p>8. Enclosure: (80855225)</p> <p>9. Thumbscrew: (83040109)</p> <p>10. Accessory rod plug: (30589594)</p> <p>11. Encoder board: (30589605)</p> <p>12. Ferrite (230V only): (83040121)</p> <p>13. Motor:</p> <ul style="list-style-type: none"> <li>a. 120V Hotplate-Stirrer (80856744)</li> <li>b. 230V Hotplate-Stirrer (30589606)</li> </ul> | <p>14. PCBA: (30589602)</p> <p>15. Ground jumper: (30589958)</p> <p>16. Heater board: (30589603)</p> <p>17. External probe wire: (30589611)</p> <p>18. Power entry module:</p> <ul style="list-style-type: none"> <li>a. 120V Hotplate-Stirrer/ Hotplate (80856749)</li> <li>b. 230V Hotplate-Stirrer/ Hotplate (30472272)</li> </ul> <p>19. 10 amp fuse: (83040122)</p> <p>20. Ribbon cable 9": (30589607)</p> <p>21. Rear panel: (30589576)</p> <p>22. Base plate: (80855222)</p> <p>23. Feet: (83040117)</p> <p>24. Detachable 92" (234cm) Power Cord (Not Shown)</p> <ul style="list-style-type: none"> <li>a. US Plug (120V) (80856139)</li> <li>b. Euro Plug (230V) (12120761)</li> <li>c. UK Plug (230V) (12120312)</li> </ul> <p>25. EU to Swiss Plug Adapter (30532012) (Not Shown)</p> |
|---|--|

## 7x7 Replacement Parts

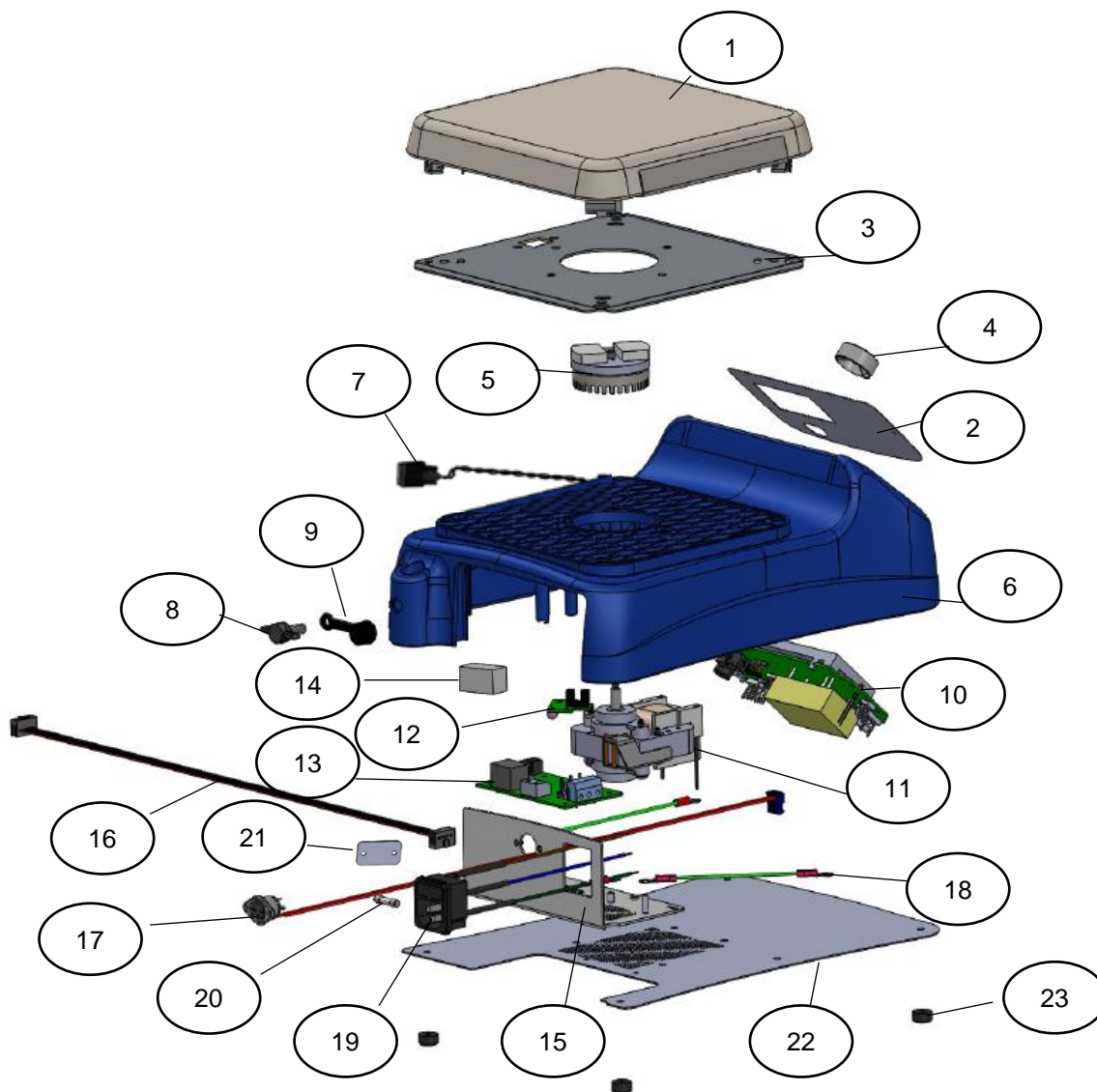

<ol style="list-style-type: none"> <li>1. Top plate assembly               <ol style="list-style-type: none"> <li>a. Hotplate Stirrer/ Hotplate 120V <b>(30500476)</b></li> <li>b. Hotplate Stirrer/ Hotplate 230V <b>(30500477)</b></li> <li>c. Stirrer Ceramic <b>(30500479)</b></li> <li>d. <b>Stirrer, Resin (80864864)</b></li> </ol> </li> <li>2. Front panel overlay               <ol style="list-style-type: none"> <li>a. 120V/230V Advanced Hotplate-Stirrer <b>(80856819)</b></li> <li>b. 120V/230V Hotplate <b>(80856821)</b></li> <li>c. 120V/230V Stirrer <b>(80856822)</b></li> </ol> </li> <li>3. Heat shield: <b>(30589564)</b></li> <li>4. Knob: <b>(80855226)</b></li> <li>5. Magnet: <b>(30589595)</b></li> <li>6. Enclosure: <b>(80855223)</b></li> <li>7. Rocker switch: <b>(30589612)</b></li> <li>8. Thumbscrew: <b>(83040109)</b></li> <li>9. Accessory rod plug: <b>(30589594)</b></li> <li>10. PCBA: <b>(30589602)</b></li> <li>11. Motor:               <ol style="list-style-type: none"> <li>a. 120V Hotplate-Stirrer <b>(80856744)</b></li> <li>b. 230V Hotplate-Stirrer <b>(30589606)</b></li> </ol> </li> </ol>	<ol style="list-style-type: none"> <li>12. Encoder board: <b>(30589605)</b></li> <li>13. Heater board: <b>(30589603)</b></li> <li>14. Ferrite (230V only): <b>(83040121)</b></li> <li>15. Rear panel: <b>(30589576)</b></li> <li>16. Ribbon cable 16": <b>(30589609)</b></li> <li>17. External probe wire: <b>(30589611)</b></li> <li>18. Ground jumper: <b>(30589958)</b></li> <li>19. Power entry module:               <ol style="list-style-type: none"> <li>a. 120V Hotplate-Stirrer/ Hotplate <b>(80856749)</b></li> <li>b. 230V Hotplate-Stirrer/ Hotplate <b>(30472272)</b></li> <li>c. 120V Stirrer <b>(80856754)</b></li> <li>d. 230V Stirrer <b>(30472273)</b></li> </ol> </li> <li>20. Fuse:               <ol style="list-style-type: none"> <li>a. 120V/230V Hotplate/ Hotplate-Stirrer (10 Amp)<b>(83040122)</b></li> <li>b. 120V/230V Stirrer (5 Amp) <b>(83040120)</b></li> </ol> </li> <li>21. Cap probe opening (Stirrer Only): <b>(80855180)</b></li> <li>22. Base plate: <b>(80855220)</b></li> <li>23. Feet: <b>(83040117)</b></li> <li>24. Detachable 92" (234cm) Power Cord (Not Shown)               <ol style="list-style-type: none"> <li>a. US Plug (120V) <b>(80856139)</b></li> <li>b. Euro Plug (230V) <b>(12120761)</b></li> <li>c. UK Plug (230V) <b>(12120312)</b></li> </ol> </li> <li>25. EU to Swiss Plug Adapter <b>(30532012)</b> (Not Shown)</li> </ol>
---	---

## 10x10 Replacement Parts

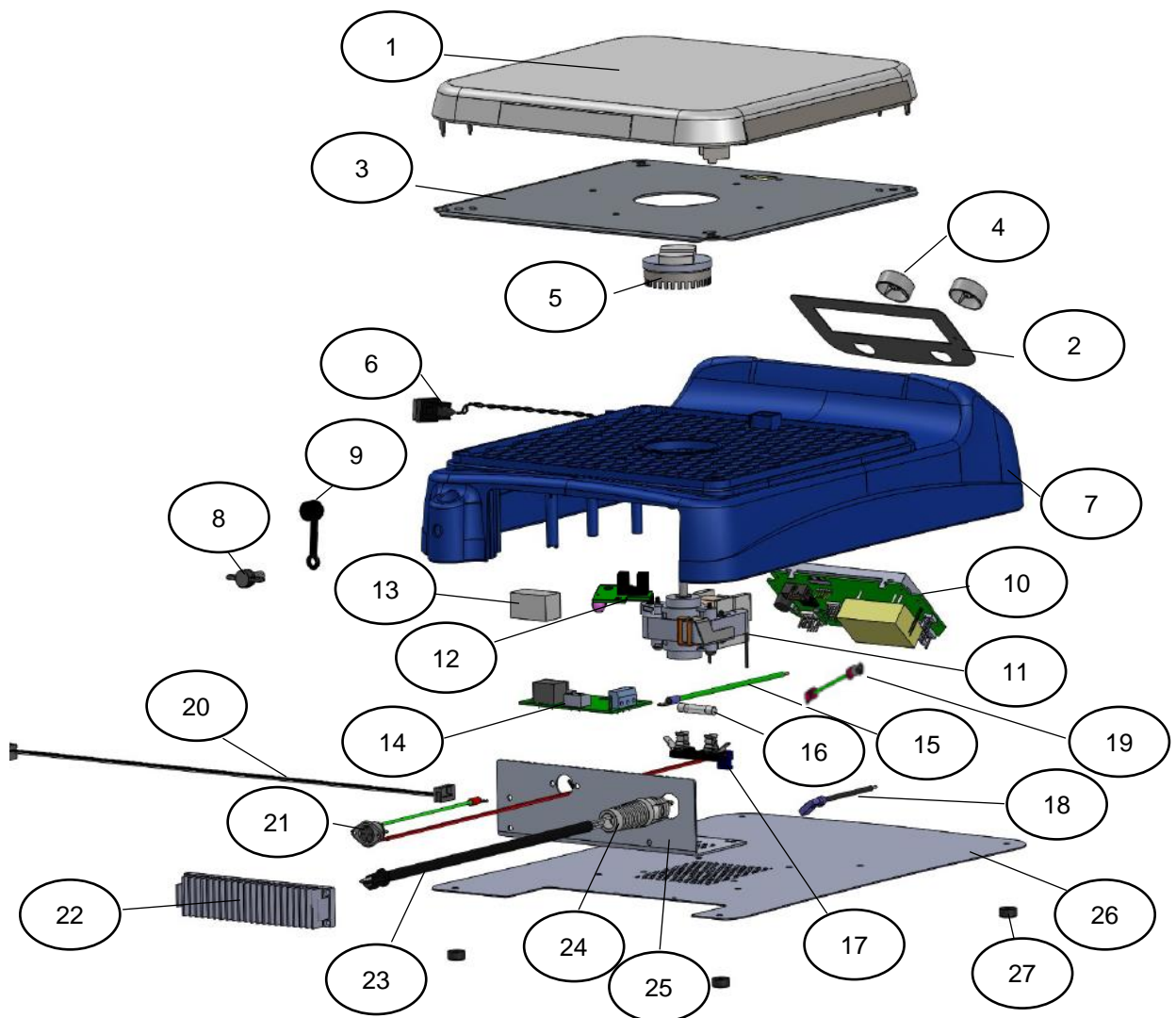

- |   |  |
|---|--|
| <p>1) Top plate assembly:<br/>           a) Hotplate stirrer 120V (<b>30500480</b>)<br/>           b) Hotplate stirrer 230V (<b>30500481</b>)</p> <p>2) Front panel overlay: (<b>80856819</b>)</p> <p>3) Heat Shield: (<b>30589565</b>)</p> <p>4) Knobs: (<b>80855226</b>)</p> <p>5) Magnet: (<b>30589595</b>)</p> <p>6) Rocker switch: (<b>30589612</b>)</p> <p>7) Enclosure: (<b>80855224</b>)</p> <p>8) Thumb screw: (<b>83040109</b>)</p> <p>9) Accessory rod plug: (<b>30589594</b>)</p> <p>10) PCBA: (<b>30589602</b>)</p> <p>11) Motor:<br/>           a) 120V Hotplate-Stirrer (<b>80856744</b>)<br/>           b) 230V Hotplate-Stirrer (<b>30589606</b>)</p> <p>12) Encoder board: (<b>30589605</b>)</p> <p>13) Ferrite (230V only): (<b>83040121</b>)</p> <p>14) Heater board: (<b>30589603</b>)</p> <p>15) Ground wire (120V only): (<b>80856738</b>)</p> | <p>16) Fuse:<br/>           a) 120V Hotplate-Stirrer (15 Amp) (<b>80856721</b>)<br/>           b) 230V Hotplate-Stirrer (10 Amp) (<b>83040122</b>)</p> <p>17) Fuse holder (120V only): (<b>80856737</b>)</p> <p>18) Black wire assembly (120V only): (<b>80856739</b>)</p> <p>19) Ground jumper: (<b>30589958</b>)</p> <p>20) Ribbon Cable 16": (<b>30589609</b>)</p> <p>21) External probe wire: (<b>30589611</b>)</p> <p>22) Heatsink (120V only): (<b>80855217</b>)</p> <p>23) Power entry module:<br/>           a) 120V Hotplate-Stirrer (<b>80856756</b>)<br/>           b) 230V Hotplate-Stirrer (<b>30472272</b>)</p> <p>24) Strain relief (120V Only): (<b>80856880</b>)</p> <p>25) Rear panel:<br/>           a) 120V Hotplate-Stirrer (<b>80855197</b>)<br/>           b) 230V Hotplate-Stirrer (<b>30589577</b>)</p> <p>26) Base plate: (<b>80855221</b>)</p> <p>27) Feet: (<b>83040117</b>)</p> <p>28) Detachable 92" (234cm) Power Cord (Not Shown)<br/>           a) US Plug (120V) (<b>80856139</b>)<br/>           b) Euro Plug (230V) (<b>12120761</b>)<br/>           c) UK Plug (230V) (<b>12120312</b>)</p> <p>29) EU to Swiss Plug Adapter (<b>30532012</b>) (Not Shown)</p> |
|---|--|



# EU DECLARATION OF CONFORMITY

We: Troemner LLC  
201 Wolf Drive  
Thorofare, NJ 08086  
USA

Declare under our sole responsibility that the product(s):

Model/Type:

- Hot Plate Stirrer Round-Top 230-Volt (985VWRAHSEUA)
- Hot Plate Stirrer 18x18 cm 230-Volt:  
(985VW7AHSEUA, 985VW7CHSEUP, 985VW7CHSEUA, 985VW7CHSEUP-C)
- Hot Plate Stirrer 25x25 cm 230-Volt:  
(985VW0CHSEUA, 985VW0CHSEUP, 985VW0CHSEUP-C)
- Hot Plate 18x18 cm 230-Volt (985VW7CHPEUA)
- Stirrer 18x18 cm 230-Volt (985VW7CSTEUA, 985VW7RSTEUA)

conform with the following applicable relevant European directives and standards:

Directive	Harmonized Standards
EMC: 2014/30/EU	EN 61326-1:2013
LVD: 2014/35/EU	EN 61010-1: 2010/A1:2019 EN 61010-2-010:2014 EN 61010-2-051:2015
RoHS: 2011/65/EU, (EU)2015/863	EN IEC 63000:2018

Date of original issue: December 7, 2020  
Revised Date: August 26, 2022

Stephen J. Krupsky, Electrical Engineer

Josh Suh, General Manager



## UK DECLARATION OF CONFORMITY

We: Troemner LLC  
201 Wolf Drive  
Thorofare, NJ 08086  
USA

Declare under our sole responsibility that the product(s):

Model/Type:

Hot Plate Stirrer Round-Top 230-Volt (985VWRAHSEUA)  
Hot Plate Stirrer 18x18 cm 230-Volt:  
(985VW7AHSEUA, 985VW7CHSEUP, 985VW7CHSEUA, 985VW7CHSEUP-C)  
Hot Plate Stirrer 25x25 cm 230-Volt:  
(985VW0CHSEUA, 985VW0CHSEUP, 985VW0CHSEUP-C)  
Hot Plate 18x18 cm 230-Volt (985VW7CHPEUA)  
Stirrer 18x18 cm 230-Volt (985VW7CSTEUA, 985VW7RSTEUA)

conform with the following applicable relevant UK statutory requirements and standards:

UK Legislation	Standards
Electromagnetic Compatibility Regulations 2016	EN 61326-1:2013
Electrical Equipment (Safety) Regulations 2016	EN 61010-1: 2010/A1:2019 EN 61010-2-010:2014 EN 61010-2-051:2015
The Restriction of the Use of Certain Hazardous Substances in Electrical and Electronic Equipment Regulations 2012	EN IEC 63000:2018

Date of original issue: August 19, 2021  
Revised Date: August 26, 2022

Stephen J. Krupsky, Electrical Engineer

Josh Suh, General Manager



VWR International  
One Radnor Corporate Center  
Building One, Suite 200  
100 Matsonford Road  
Radnor, PA 19087 USA  
Tel: 1 855 282 6867  
Fax: 1 610 573 2650  
With offices worldwide  
[www.VWR.com](http://www.VWR.com)



2021 VWR Corporation, all rights reserved.

80850761 586120 RevE