

INSPIRAL



**STAINLESS STEEL
HOSPITAL FURNITURE
2020**

INSPIRAL

STAINLESS STEEL
HOSPITAL FURNITURE



Contents

CART SYSTEMS

Hospital Cart	6
Hospital Cart Accessories	8
Emergency Cart	10
Nursing Cart	11
Anesthesia Cart	11
Medication Cart	12
Mobile Medicine Shelf	12
Isolation Cart	13
Endoscopy Cart	13

HAND WASHING & HYGIENE

Scrub Sinks	15
Brush Dispenser	18
Soap and Disinfectant Dispenser	19
Paper Towel Dispenser	19
Configured Cabinets	20
Medical Cabinets	22
Wall Mounted Medical Cabinets	25
Cabinet with Drawers	26
Bronchoscope Endoscope Cabinet	27
Cap, Bonnet and Mask Cabinet	27
Mobile Hook Rails	28

STORAGE & SHELF SYSTEMS

Shelving Systems	30
ABS Modules	32
Storage and Retrieval Trolleys	34
Slipper Trolley	41
Sit Over Bench	41
Shelves	42

WASHING & INSPECTION & PACKAGING

Negatoscopes	44
Medicine Cabinets	45
Hanger Trolley	45
Ultrasonic Cleaning Unit	46
Illuminated Inspection Table	48
Plaster Table	48
Pediatric Plaster Table	49
Instrument Washing Sink	49
Baby Washing Table	50

Endoscopy Washing and Storage Table	50
Packaging Table	51
Sealing Devices	52

STAINLESS STEEL TROLLEYS & TABLES

Surgical Instrument Trolley	53
Falcate Table	53
Mayo Table	54
Paper Trolley	55
Instrument Table	56
Equipment Trolley	56
Laundry Trolley	57
Dressing Trolley	57
Instrument Trolley	58
Nested Table Trolley	58
Medical Waste Trolley	59
Transportation Trolley	59
Housekeeping Trolley	60
Bowl Trolley	61
Waste Bins and Kick Bucket	61

HOSPITAL ACCESSORIES

Shower Seat	62
Disabled Grab Bars	62
Surgeon Step Stool	63
Pass Through Windows	63
Cylinder Trolley	63
Examination Table	64
Hospital Screens	64
IV Stands	65
Hydraulic Stool	66
Kidney Trays and Bowls	67
Trommels	67
Waste Bin	67

SPECIAL NEED PRODUCTS

UV-C Flow Gemicidal Lamp	68
Morgue Units	69
Autopsy Tables	70
Body Washing Table	70
Lift for Morgue	71

STAINLESS STEEL HOSPITAL FURNITURE





Hospital Cart

There are different cart types for the healthcare industry in the vertical sense. Inspital Hospital Cart can be easily customized for different purposes: Emergency Cart, Nursing Cart, Anesthesia Cart, Medication Cart



1) ABS top tray, easy to clean 2) Holder, easy to handle 3) Color options for side walls 4) Aluminum corner profiles
5) Accessory rail 7) Durable bumpers 6) ABS base tray 8) Medical grade castors

Hospital Cart can be customized with: drawer quantity (5 or 6 drawers), drawer design (basket, tray, separators), various color options for drawer handles and side walls



Inox
Stainless Steel
A.C; AB20.60S (6 drawers)
A.C; AB20.50S (5 drawers)



RAL 9016
White
A.C; AB20.60W (6 drawers)
A.C; AB20.50W (5 drawers)



RAL 1018
Yellow
A.C; AB20.60Y (6 drawers)
A.C; AB20.50Y (5 drawers)



RAL 5015
Blue
A.C; AB20.60B (6 drawers)
A.C; AB20.50B (5 drawers)



RAL 6011
Green
A.C; AB20.60G (6 drawers)
A.C; AB20.50G (5 drawers)



RAL 3020
Red
A.C; AB20.60R (6 drawers)
A.C; AB20.50R (5 drawers)

Hospital Cart Accessories



IV Stand

Article Codes	L (mm)	W (mm)	H (mm)	Explanation
SK00.01	Ø20	620 min	680 max	S. Steel



Medicine Box

Article Codes	L (mm)	W (mm)	Explanation
RF91.04	600	416	2 x 4 Containers
RF91.05	600	326	2 x 5 Containers
RF91.06	600	230	2 x 6 Containers



Defibrillator Tray

Article Codes	L (mm)	W (mm)	H (mm)	Explanation
SK00.02	315	365	250	S. Steel



Glove Tray

Article Codes	L (mm)	W (mm)	H (mm)	Explanation
SK00.03	150	275	100	S. Steel



Disposable Waste Bin

Article Codes	L (mm)	H (mm)	Explanation
SK00.04	Ø 125	145	Plastic



Waste Bin

Article Codes	L (mm)	W (mm)	H (mm)	Explanation
SK00.05	175	215	315	S. Steel



Oxygen Cylinder Holder

Article Codes	L (mm)	W (mm)	H (mm)	Explanation
SK00.06	200	150	400	S. Steel



Soap Dispenser

Article Codes	L (mm)	W (mm)	H (mm)	Explanation
SK10.11	210	92	330	Aluminum Plastic



Tissue Dispenser

Article Codes	L (mm)	W (mm)	H (mm)	Explanation
SK00.07	600	400	50	S. Steel



CPR Board

Article Codes	L (mm)	W (mm)	T (mm)	Explanation
SK00.08	650	450	8	Compact



Lock System

Article Codes	L (mm)	W (mm)	H (mm)	Explanation
SK00.09		80	730	Plastic - S. Steel
AB00.22	9	28	30	Plastic Lock 50 Pcs



Portable Suction Units

Article Codes	L (mm)	W (mm)	H (mm)	Explanation
SU60	180	380	300	Mobile 220 VAC



1) Defibrillator tray 2) Drawer 3) Oxygen cylinder holder 4) IV stand 5) ABS top tray
6) Soap dispenser 7) Waste bin 8) Tray with dividers

Emergency Cart A.C; AB11.60

- Customized for Emergency and Intensive Care
- Optimized equipment handling for immediate treatment
- Aluminum frame, stainless steel accessory rails, compact drawers
- Defibrillator tray, IV stand, waste bin, CPR board
- 6 drawers with lock

Emergency Cart A.C; AB10.60



Article Codes	L(mm)	W(mm)	H(mm)	Explanation
AB11.60	860	520	1060	Incl. All Accessories
AB12.60	860	520	1060	Without Defibrillator
AB20.60-W	860	520	1060	6 Drawers White
SK00.05	175	215	315	Waste Bin
SK10.11	210	92	330	Soap Dispenser
SK00.06	200	150	400	Oxygen Cylinder Holder
SK00.02	315	265	250	Defibrillator Tray
SK00.01	Ø20	620	680	IV Stand
SK00.08	8	450	650	CPR Board
SK26.01	145	440	325	Defibrillator
SK26.02	150	250	250	Ambu
SK26.03	100	300	250	Laryngoscope
SK26.04	Ø130	210	500	Flowmeter and Oxygen Tube
ABB.067	9	28	30	Plastic Lock 50 Pcs

Article Codes	L(mm)	W(mm)	H(mm)	Explanation
AB10.60	860	520	1060	Incl. All Accessories
AB20.60-W	860	520	1060	6 Drawers White
SK00.05	175	215	315	Waste Bin
SK00.03	150	275	100	Glove Tray
SK00.02	315	265	250	Defibrillator Tray
SK00.01	Ø20	620	680	IV Stand
SK00.08	8	450	650	CPR Board
SK00.06	200	150	400	Oxygen Cylinder Holder
ABB.067	9	28	30	Plastic Lock 50 Pcs



Nursing Cart A.C; AB10.66

- Aluminum mainframe and laminated compact drawers
- Easy to handle & easy to clean
- Trays are available in 50 mm, 100 mm and 200 mm heights
- 4 pcs 125 mm castors 2 with brake
- Accessories: IV stand, glove tray and waste bin

Article Codes	L (mm)	W (mm)	H (mm)	Explanation
AB10.66	860	520	1060	Incl. All Accessories
AB20.60-B	860	520	1060	6 Drawers Blue
SK00.05	175	215	315	Waste Bin
SK00.03	150	275	100	Glove Tray
SK00.01	Ø20	620	680	IV Stand
SK00.08	8	450	650	CPR Board
ABB.067	9	28	30	Plastic Lock 50 Pcs



Anesthesia Cart A.C; AB10.50

- Aluminum mainframe and laminated compact drawers
- Monoblock mainframe
- Easy to handle & easy to clean
- Trays are available in 50 mm, 100 mm and 200 mm heights
- 4 pcs 125 mm castors 2 with brake
- Accessories: medicine boxes, sharp container

Article Codes	L (mm)	W (mm)	H (mm)	Explanation
AB10.50	860	520	960	Incl. All Accessories
AB20.50-W	860	520	960	5 Drawers-White
RF91.05	600	326	-	Medicine Box 2x5
SK00.04	Ø 125	145	-	Disposable Waste Bin
SK00.08	8	450	650	CPR Board
ABB.067	9	28	30	Plastic Lock 50 Pcs





Medication Cart

- Aluminum rigid mainframe
- 8 rows medication drawers with lock
- Total 40 pcs (AB40.40) or 32 pcs (AB40.32) medication drawers
- Adjustable medication drawer separators enable modular and efficient usage
- Central lock system
- 2 options with stainless steel and powder coated
- 4 pcs 125 mm castors 2 with brake

Article Codes	L (mm)	W (mm)	H (mm)	Explanation
AB40.32	700	460	1030	32 Unit Dose
AB40.40	700	460	1030	40 Unit Dose

Medication Drawers

Article Codes	L (mm)	W (mm)	H (mm)	Explanation
RF70.80	292	60	72	Shelf
RF70.20	292	60	112	Shelf
RF71.80	-	-	80	Divider
RF71.20	-	-	120	Divider



Mobile Medicine Shelf

- Stainless steel mainframe
- Mobility for optimized needs
- Adjustable drawer angles for easy use
- Various options with separators and baskets
- 4 pcs 125 mm castors 2 with brake

Article Codes	L (mm)	W (mm)	H (mm)	Explanation
AB41.32	850	420	1760	45 Unit Dose



Isolation Cart

- Aluminum mainframe and laminated compact drawers
- 9 drawers, integrated plastic separators & baskets in drawers
- 4 pcs 125 mm castors 2 with brake

Article Codes	L (mm)	W (mm)	H (mm)	Explanation
AB20.90	780	520	1800	9 Drawers



Endoscopy Cart

- Users can organize small instruments easily thanks to the 24 different sections formed by separators
- Stock control possibility at any moment thanks to the glass doors
- In the full cabinet, there are;
 - 2 pcs ABS basket in the dimensions of 600x400x200 mm
 - 5 pcs ABS tray in the dimensions of 600x400x100 mm
 - 3 pcs ABS tray in the dimensions of 600x400x50 mm
- Shelf dividers in each basket suitable for horizontal and vertical division
- 4 pcs 125 mm castors 2 with brake

Article Codes	L (mm)	W (mm)	H (mm)	Explanation
AB30.00	780	520	1700	Full
AB30.01	780	520	1700	Without Baskets



Faucets

- Water and soap faucets are designed to keep hand sanitation
- High-grade chrome plating for long life span
- Equipped with water saver

Sink

- Designed to prevent splash during washing
- Easy to clean, hygienic surfaces

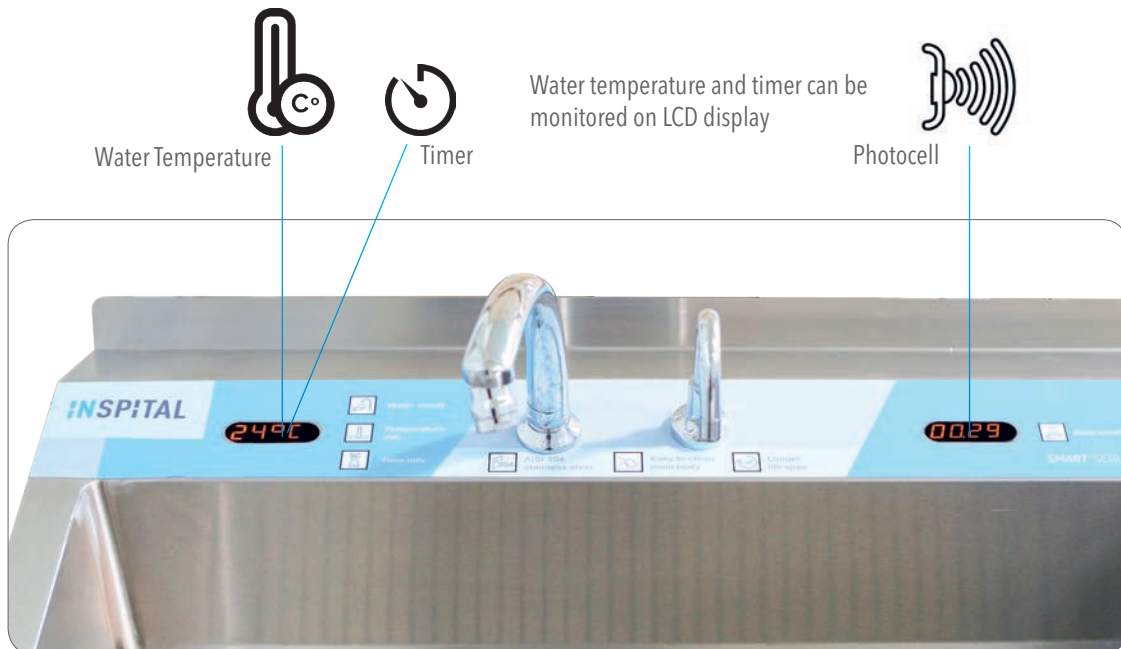



SK60.20



SK60.10

Scrub Sinks

- Made of stainless steel designed to be used by the surgery team for hand and nail cleaning before entering the sterile zone
- Photocell display screen that shows the temperature and duration of water alternatively from each faucet
- Specially designed with antibacterial materials to meet international hygienic norms
- Photocell and knee controlled water flow and knee controlled soap flow at each station
- Thermostatic mixing valve for cold and hot water
- Designed with round concave corners for easy to clean

Floor Type

Article Codes	L (mm)	W (mm)	H (mm)	Explanation
SK60.10	800	635	1180	Single, Water Photocell
SK60.20	1600	635	1180	Double, Water Photocell
SK60.30	2200	635	1180	Triple, Water Photocell
SK61.10	800	635	1180	Single, Water-Soap Photocell
SK61.20	1600	635	1180	Double, Water-Soap Photocell
SK61.30	2200	635	1180	Triple, Water-Soap Photocell

Wall Type

Article Codes	L (mm)	W (mm)	H (mm)	Explanation
SK60.11	800	635	880	Single, Water Photocell
SK60.22	1600	635	880	Double, Water Photocell
SK60.33	2200	635	880	Triple, Water Photocell
SK61.11	800	635	880	Single, Water-Soap Photocell
SK61.22	1600	635	880	Double, Water-Soap Photocell
SK61.33	2200	635	880	Triple, Water-Soap Photocell



Water temperature and timer can be monitored on LCD display

Scrub Sinks

- Antibacterial acrylic sink surface designed to be used by surgery team for hand and nail cleaning before entering the zone
- Photocell display screen that shows the temperature and duration of water alternatively from each faucet
- Specially designed with antibacterial materials to meet international hygienic norms
- Thermostatic mixing valve for cold and hot water
- Photocell and manually controlled water flow options
- Made of stainless steel

Article Codes	L (mm)	W (mm)	H (mm)	Explanation
SK90.01	700	790	660	Single, Photocell
SK90.11	700	790	660	Single, Manual
SK90.02	700	1500	660	Double, Photocell
SK90.12	700	1500	660	Double, Manual



Scrub Sinks

- Made of stainless steel
- Wall mounted scrub sink
- 200 mm sink depth
- Drain trap included
- Optional wall mounted accessories : Water Taps, Soap and Disinfectant Dispenser, Brush Dispenser, Paper Towel Dispenser.

Article Codes	L (mm)	W (mm)	H (mm)	Explanation	
SK70.10	800	520	450	Single	Faucet Mounted on Sink
SK70.20	1600	520	450	Double	
SK70.30	2200	520	450	Triple	
SK71.10	800	520	450	Single	Faucet Mounted on Wall (W/O Faucet)
SK71.20	1600	520	450	Double	
SK71.30	2200	520	450	Triple	



Scrub Sink

- Made of stainless steel
- Compact, wall mounted design
- Specially designed button to start the flow without hand contact

Article Codes	L (mm)	W (mm)	H (mm)
SK70.50	450	500	240



Mobile Scrub Sink

- Made of stainless steel and MDF
- Clean water and waste water tanks
- Independent usage with battery operated pumps
- Integrated soap dispenser
- Easy to move with 4 castors

Article Codes	L (mm)	W (mm)	H (mm)
SK90.10	430	450	1150



Brush Dispenser

- Dispenser for keeping disposable brushes
- Three channel body made of stainless steel
- Total 30 disposable brush capacity
- Wall mounted

Article Codes	L (mm)	W (mm)	H (mm)
SK20.00	250	120	400



SK10.10



SK10.11

Soap and Disinfectant Dispenser

SK10.10

- Photocell controlled
- Adjustable soap amount and long battery life with low energy consumption
- Hygienic and anodized aluminum body
- Autoclavable pump system
- Wall mounted

SK10.11

- Elbow operated
- Stainless steel cover
- Refillable soap and disinfectant
- Wall mounted

Article Codes	L (mm)	W (mm)	H (mm)	Explanation
SK10.10	92	210	330	1 L
SK10.11	100	195	350	1 L



Paper Towel Dispenser

- Made of stainless steel
- Wall mounted paper dispenser

Article Codes	L (mm)	W (mm)	H (mm)
SK00.51	90	325	260



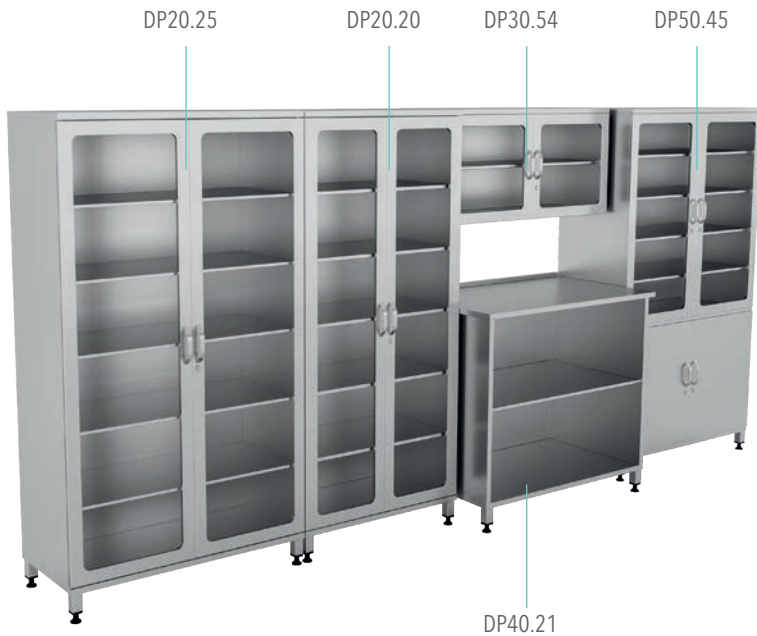

A.C; DP90.20

Configured Cabinets A.C; DP90.20

- Made of stainless steel
- Configured Cabinets are created by the selecting units from Medical Cabinets
- Various Configured Cabinets can be created by different combination of Medical Cabinets

Article Codes	L (mm)	W (mm)	H (mm)	Explanation
DP90.20	3800	750	1800	Complete Set Cabinets
DP20.25	1000	450	1800	Glass Doors Cabinets
DP20.20	800	450	1800	Glass Doors Cabinets
DP40.21	1000	600	850	Closed Shelf Cabinets
DP30.54	1000	350	500	Glass Cover Cabinets
DP50.45	1000	450	1800	Glass Doors Cabinets



A.C; DP90.10

Configured Cabinets A.C; DP90.10

- Made of stainless steel
- Configured Cabinets are created by the selecting units from Medical Cabinets
- Various Configured Cabinets can be created by different combination of Medical Cabinets

Article Codes	L (mm)	W (mm)	H (mm)	Explanation
DP90.10	1980	780	1800	Complete Set Cabinets
DP20.25 x 2pcs	1000	450	1800	Glass Doors Cabinets
DP30.54	1000	350	500	Glass Cover Cabinets
DP80.10	1000	600	850	Cabinet Cabinets



Configured Cabinets A.C; DP90.30

- Made of stainless steel
- Configured Cabinets are created by the selecting units from Medical Cabinets
- Various Configured Cabinets can be created by different combination of Medical Cabinets

Article Codes	L (mm)	W (mm)	H (mm)	Explanation
DP90.30	1800	600	1800	Complete Set Cabinets
DP40.15 x 2	1200	600	850	Cupboards Cabinets
DP30.21 x 2	1200	350	500	Cabinet
DP50.75	500	450	1800	Glass Doors Cabinets

A.C; DP90.30

DP40.15



Configured Cabinets A.C; DP90.40

- Made of stainless steel
- Configured Cabinets are created by the selecting units from Medical Cabinets
- Various Configured Cabinets can be created by different combination of Medical Cabinets

Article Codes	L (mm)	W (mm)	H (mm)	Explanation
DP90.40	1800	600	1800	Complete Set Cabinets
DP80.10	1000	600	850	Cabinet Cabinets
DP30.54	1000	350	500	Glass Cover Cabinets
DP50.45	1000	450	1800	Glass Doors Cabinets

A.C; DP90.40

DP80.10



A.C; DP20.55

Medical Cabinets

- Made of stainless steel
- Doors with lock and handle
- 5 adjustable shelves
- Adjustable rubber feet
- Easy to use sliding doors
- Glass side panels to view shelves from the outside

Article Codes	L (mm)	W (mm)	H (mm)	Explanation
DP20.15	1200	450	1800	Sliding Doors
DP20.20	800	450	1800	Glass Doors
DP20.25	1000	450	1800	Glass Doors
DP20.35	1200	450	1800	Sliding Doors
DP20.40	800	450	1800	Glass Doors
DP20.45	1000	450	1800	Glass Doors
DP20.55	1200	450	1800	Sliding Doors
DP20.60	400	450	1800	Single Doors
DP20.65	500	450	1800	Single Doors



A.C; DP20.15



A.C; DP20.20
DP20.25



A.C; DP20.35



A.C; DP20.40
DP20.45



A.C; DP20.60
DP20.65



A.C; DP50.50
DP50.55

Medical Cabinets

- Made of stainless steel
- Upper part with glass side panels and glass door
- Doors with lock and handle
- Upper part with 4 adjustable shelves
- Lower part with one fixed shelf
- Adjustable rubber feet

Article Codes	L(mm)	W(mm)	H(mm)	Explanation
DP50.15	1200	450	1800	Sliding Doors
DP50.25	1200	450	1800	Sliding Doors
DP50.30	800	450	1800	Full Doors
DP50.35	1000	450	1800	Full Doors
DP50.40	800	450	1800	Glass Doors
DP50.45	1000	450	1800	Glass Doors
DP50.10	1000	450	1800	With Drawer
DP50.20	1000	450	1800	With Drawer
DP50.50	800	450	1800	Glass Doors
DP50.55	1000	450	1800	Glass Doors
DP50.65	1200	450	1800	Sliding Doors
DP50.70	400	450	1800	Single Doors
DP50.75	500	450	1800	Single Doors



A.C; DP50.25



A.C; DP50.35
DP50.30



A.C; DP50.40
DP50.45



A.C; DP50.10



A.C; DP50.20



A.C; DP50.15



A.C; DP50.65



A.C; DP50.70
DP50.75



Medical Cabinets

- Made of stainless steel
- Various types for different purposes and applications
- Adjustable rubber feet

Article Codes(mm) (LxHxU)	Closed Shelf	Cupboards	Cabinet Drawer	Sliding Cupboard	Profile Footed	Open Shelf	Sinks
600x600x850	DP40.14	DP40.13	-	-	MS10.40	MS10.30	-
800x600x850	DP40.20	DP40.10	-	-	MS10.41	MS10.31	-
1000x600x850	DP40.21	DP40.11	DP80.10	-	MS10.42	MS10.32	SK50.20 Single
1200x600x850	DP40.22	DP40.15	DP80.11	DP40.30	MS10.43	MS10.33	SK50.21 Single
1400x600x850	DP40.23	-	DP80.12	DP40.31	MS10.44	MS10.34	SK50.22 Double
1600x600x850		-	-	DP40.32	MS10.45	MS10.35	SK50.10 Double
1800x600x850		-	-	-	-	-	SK50.11 Double



Closed shelf



Cupboards



Cabinet drawer



Sliding cupboard



Profile footed



Open shelf

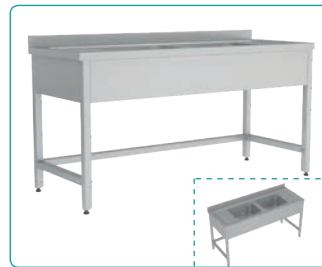

Sink double



Sink single



Glass cover

Wall Mounted Medical Cabinets

- Made of stainless steel
- Wall mounted
- 2 options with sliding door with lock and standard door with lock
- Internal 1 shelf

Article Codes(mm) (LxHxU)	Sliding, Without Glass	Cupboards	Glass Cover	Capless Shelves	Sliding Glass With Cover
600x350x500	-	DP30.26	DP30.41	DP30.52	-
800x350x500	-	DP30.27	DP30.10	DP30.53	-
1000x350x500	-	DP30.28	DP30.11	DP30.54	-
1200x350x500	DP30.21	-	-	DP30.55	DP30.31



Sliding,
without glass



Cupboards



Glass cover



Capless shelves



Sliding glass with cover



Cabinet with Drawers

- 2 options with stainless steel or powder coated sheet steel mainframe
- Adjustable shelf angels for easy use
- Adjustable rubber feet
- Glass door with lock
- In the full double cabinet, there are;
 - 6 pcs ABS baskets in the dimensions of 600x400x200 mm
 - 4 pcs ABS trays in the dimensions of 600x400x100 mm
 - 6 pcs ABS trays in the dimensions of 600x400x50 mm
- Single, double door & transverse, longitudinal shelf arrangement options
- In the full single cabinet, there are;
 - 3 pcs ABS baskets in the dimensions of 600x400x200 mm
 - 4 pcs ABS trays in the dimensions of 600x400x100 mm
 - 4 pcs ABS trays in the dimensions of 600x400x50 mm
- There is a shelf divider in each basket and tray which divides both horizontally and vertically



Article Codes	L (mm)	W (mm)	H (mm)	Explanation (Double)
DP10.10	995	650	1800	Full, Electrostatic Paint
DP10.15	995	650	1800	Null, Electrostatic Paint
DP10.20	995	650	1800	Full, Stainless Steel
DP10.25	995	650	1800	Null, Stainless Steel
Article Codes	L (mm)	W (mm)	H (mm)	Explanation (Single)
DP10.30	715	450	1800	Full, Electrostatic Paint
DP10.35	715	450	1800	Null, Electrostatic Paint
DP10.40	715	450	1800	Full, Stainless Steel
DP10.45	715 </td <td>450</td> <td>1800</td> <td>Null, Stainless Steel</td>	450	1800	Null, Stainless Steel



Bronchoscope Endoscope Cabinet

- Made of stainless steel
- Designed to keep the flexible endoscope systems safely
- 5 pcs rail system for easy endoscope hanging
- Inner tray for water collecting
- Glass door with lock
- Adjustable rubber feet

Article Codes	L (mm)	W (mm)	H (mm)
DP10.50	665	471	2215



Cap, Bonnet and Mask Cabinet

- Made of stainless steel
- Designed to use at the entrance of operating rooms and ICU's
- Separate divisions for clean caps, bonnets, masks etc
- Cabinet for used items
- Adjustable rubber feet

Article Codes	L (mm)	W (mm)	H (mm)
DP40.40	655	420	1560





Mobile Hook Rail, Orthopedic Type

Article Codes	Qty	Explanation
AB90.30	1	Complete Set
AB90.10	1	Hook Trolley
RF40.30	1	Basket, Small
RF40.35	2	Basket, Large



Mobile Hook Rail, Anaesthetic Type

Article Codes	Qty	Explanation
AB90.40	1	Complete Set
AB90.20	1	Hook Trolley
RF40.30	2	Basket, Small
RF40.35	4	Basket, Large



Mobile Hook Rail, Operating Type

Article Codes	Qty	Explanation
AB90.50	1	Complete Set
AB90.10	1	Hook Trolley
RF00.30	1	Suture Tray
RF40.30	1	Basket, Small
RF40.35	1	Basket, Large
RF00.50	1	Multi-purpose Shelf



Wall Mounted Hook Rail, General Type

Article Codes	Qty	Explanation
RF10.50	1	Complete Set
AB90.00	1	Hook Trolley
RF00.30	1	Suture Tray
RF40.30	1	Basket, Small
RF90.55	1	Medicine Box,
RF00.50	1	Multi-purpose Shelf



Double Sided

Article Codes	L (mm)	W (mm)	H (mm)
AB90.10	600	850	1700



Single Sided

Article Codes	L (mm)	W (mm)	H (mm)
AB90.20	600	700	1700

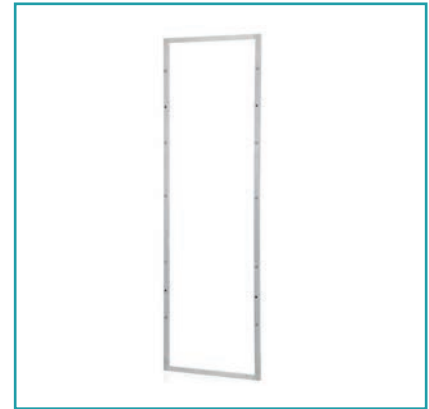

Hook Rail Wall Mounted

Article Codes	L (mm)	W (mm)	H (mm)
AB90.00	600	600	1700



Sterile Goods Basket

Article Codes	L (mm)	W (mm)	H (mm)
RF40.30 Small	600	300	200
RF40.35 Large	600	350	300



Suture Storage

Article Codes	L (mm)	W (mm)	H (mm)
RF00.30	600	136	290



Multi-purpose Barrier Storage

Article Codes	L (mm)	W (mm)	H (mm)
RF00.40	600	360	170



Multi-purpose Storage

Article Codes	L (mm)	W (mm)	H (mm)
RF00.50	600	310	255



Cap - Bonnet Storage

Article Codes	L (mm)	W (mm)	H (mm)
RF00.60	600	340	380



Shoe Holder

Article Codes	L (mm)	W (mm)	H (mm)
RF00.80	600	237	115

Shelving Systems

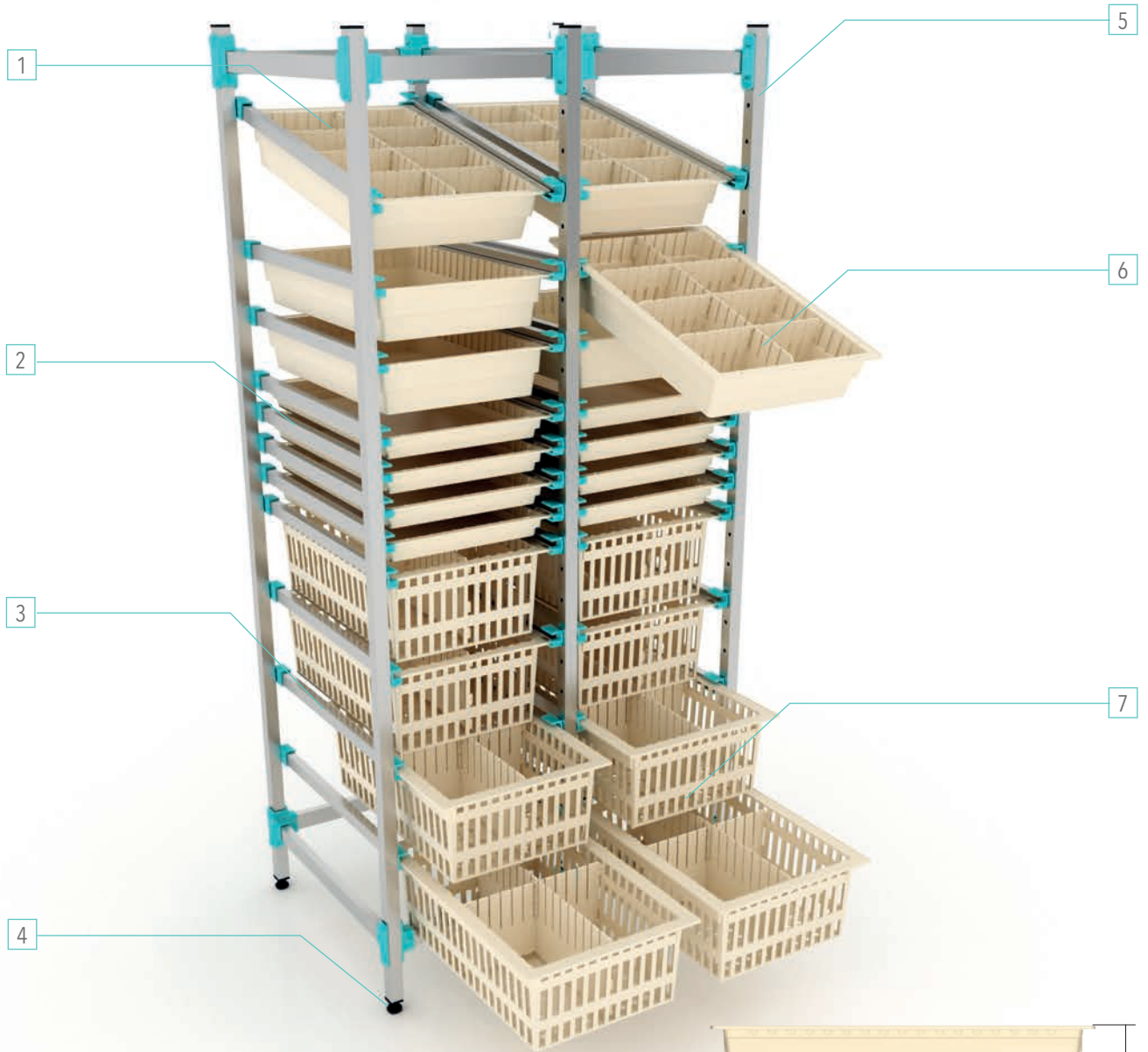

- High density storage
- Adjustable tray rails
- Expandable durable aluminum frame
- Horizontal and angled tray positioning
- Long edge or short edge models are available



3 size options for trays & baskets (50, 100 and 200 mm)

- 1) Modular separators and dividers 2) Easy to position tray holders 3) Easy to clean body 4) Adjustable rubber feet
 5) Durable aluminum frame 6) Adjustable tray angles 7) Easy movement of trays and baskets

Shelving Systems

Shelving Systems can be configured to fulfill user need. There are multiple size and type options as well as long edge and short edge orientation alternatives



Short Edge Type



Long Edge Type

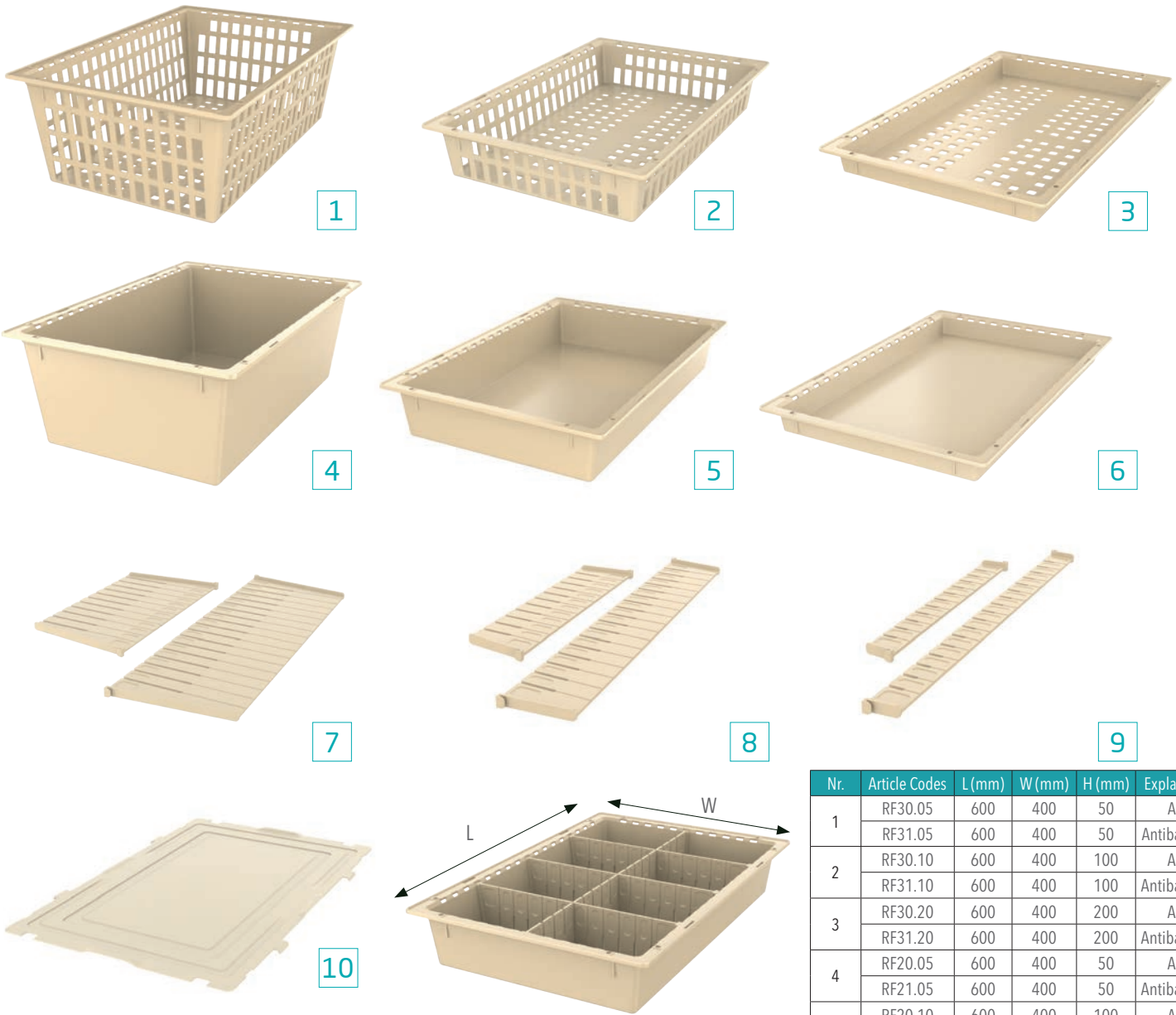

ABS Modules and Abs Modular Baskets, 600 × 400 mm

- Made of ABS, cream color
- Modular baskets and structures can be stacked and stored
- Sealed base for protection; leaks, dust, particles
- Optional perforated base for special needs
- Easy mounting for label holders
- Easy dividing with separators if needed
- Designed with safety stop system for telescopic rails
- External dimensions are designed to meet healthcare industry standards

Nr.	Article Codes	L (mm)	W (mm)	H (mm)	Explanation
1	RF30.05	600	400	50	ABS
	RF31.05	600	400	50	Antibacterial
2	RF30.10	600	400	100	ABS
	RF31.10	600	400	100	Antibacterial
3	RF30.20	600	400	200	ABS
	RF31.20	600	400	200	Antibacterial
4	RF20.05	600	400	50	ABS
	RF21.05	600	400	50	Antibacterial
5	RF20.10	600	400	100	ABS
	RF21.10	600	400	100	Antibacterial
6	RF20.20	600	400	200	ABS
	RF21.20	600	400	200	Antibacterial
10	RF40.01	600	400	10	ABS
	RF41.01	600	400	10	Antibacterial

Short and Long Dividers

Nr.	Article Codes	L (mm)	W (mm)	Explanation
7	RF60.05	400	50	ABS
8	RF60.10	400	100	ABS
9	RF60.20	400	200	ABS
7	RF61.05	600	50	ABS
8	RF61.10	600	100	ABS
9	RF61.20	600	200	ABS
7	RF62.05	400	50	Antibacterial
8	RF62.10	400	100	Antibacterial
9	RF62.20	400	200	Antibacterial
7	RF63.05	600	50	Antibacterial
8	RF63.10	600	100	Antibacterial
9	RF63.20	600	200	Antibacterial

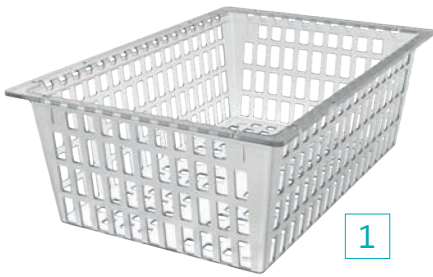

1



2



3

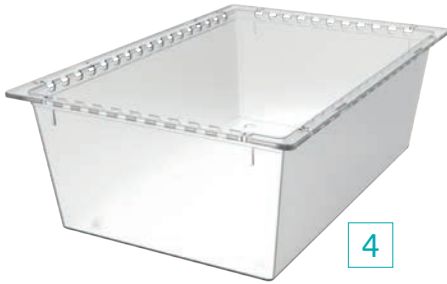

4



5



6



7



8

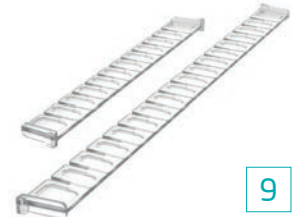

9

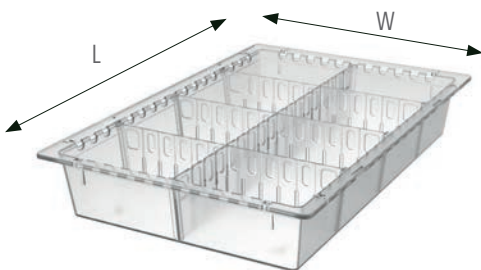

Nr.	Article Codes	L (mm)	W (mm)	H (mm)	Explanation
1	RF32.05	600	400	50	PC
2	RF32.10	600	400	100	PC
3	RF32.20	600	400	200	PC
4	RF22.05	600	400	50	PC
5	RF22.10	600	400	100	PC
6	RF22.20	600	400	200	PC

Short and Long Dividers

Nr.	Article Codes	L (mm)	W (mm)	Explanation
7	RF64.05	400	50	PC
8	RF64.10	400	100	PC
9	RF64.20	400	200	PC
7	RF65.05	600	50	PC
8	RF65.10	600	100	PC
9	RF65.20	600	200	PC

PC Modules, PC Modular Baskets and PC Dividers, 600 × 400 mm

- Made of PC, transparent
- Modular baskets and structures can be stacked and stored
- Sealed base for protection; leaks, dust, particles
- Optional perforated base for special needs
- Easy mounting for label holders
- Easy dividing with separators if needed
- Designed with safety stop system for telescopic rails
- External dimensions are designed to meet healthcare industry standards

Storage and Retrieval Trolleys

Storage Trolley and Retrieval Trolley are designed for hygienic storage of laundry, treatment equipment, consumables, durable equipment and transport to different units within the clinic when required.



- 1) Designed for modular baskets in various height and depth
- 2) 4 castors structure for maximum mobility, includes a brake system
- 3) Standard material is plastic coated steel
- 4) Designed for hanging rails for adjustable angle
- 5) Easy cleaning





Full



Full



Null



Null

Long Edge Type

Article Codes	L (mm)	W (mm)	H (mm)	Explanation
RF22.91	660	450	1760	Single-Full
RF22.92	1320	450	1760	Double-Full
RF22.93	1965	450	1760	Triple-Full
RF22.94	2610	450	1760	Quad-Full
RF23.91	660	450	1760	Single-Null
RF23.92	1320	450	1760	Double-Null
RF23.93	1965	450	1760	Triple-Null
RF23.94	2610	450	1760	Quad-Null

Short Edge Type

Article Codes	L (mm)	W (mm)	H (mm)	Explanation
RF24.91	475	650	1760	Single-Full
RF24.92	920	650	1760	Double-Full
RF24.93	1365	650	1760	Triple-Full
RF24.94	1810	650	1760	Quad-Full
RF25.91	475	650	1760	Single-Null
RF25.92	920	650	1760	Double-Null
RF25.93	1365	650	1760	Triple-Null
RF25.94	1810	650	1760	Quad-Null



- 1) Designed for modular baskets in various height and depth
- 2) 4 castors structure for maximum mobility, includes a brake system.
- 3) Standard material is plastic coated steel
- 4) Designed for hanging rails for adjustable angle
- 5) Easy cleaning

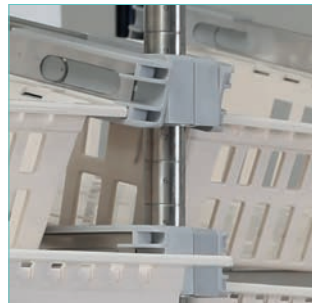



Wire Shelves

- Designed to suit for every area in the hospital
- Stainless steel frame for durability and easy cleaning
- Adjustable shelf angles
- Modular structure to build different size solution

Long Edge Type

Article Codes	L (mm)	W (mm)	H (mm)	Explanation
RF26.91	675	460	1810	Single-Full
RF26.92	1320	460	1810	Double-Full
RF26.93	1965	460	2000	Triple-Full
RF26.94	2610	460	2000	Quad-Full
RF27.91	675	460	2000	Single-Full+Shelves
RF27.92	1320	460	2000	Double-Full+Shelves
RF27.93	1965	460	2000	Triple-Full+Shelves
RF27.94	2610	460	2000	Quad-Full+Shelves
RF28.91	675	460	2000	Single-Null
RF28.92	1320	460	2000	Double-Null
RF28.93	1965	460	2000	Triple-Null
RF28.94	2610	460	2000	Quad-Null
RF29.91	675	460	2000	Single-Null+Shelves
RF29.92	1320	460	2000	Double-Null+Shelves
RF29.93	1965	460	2000	Triple-Null+Shelves
RF29.94	2610	460	2000	Quad-Null+Shelves

STAINLESS STEEL HOSPITAL FURNITURE

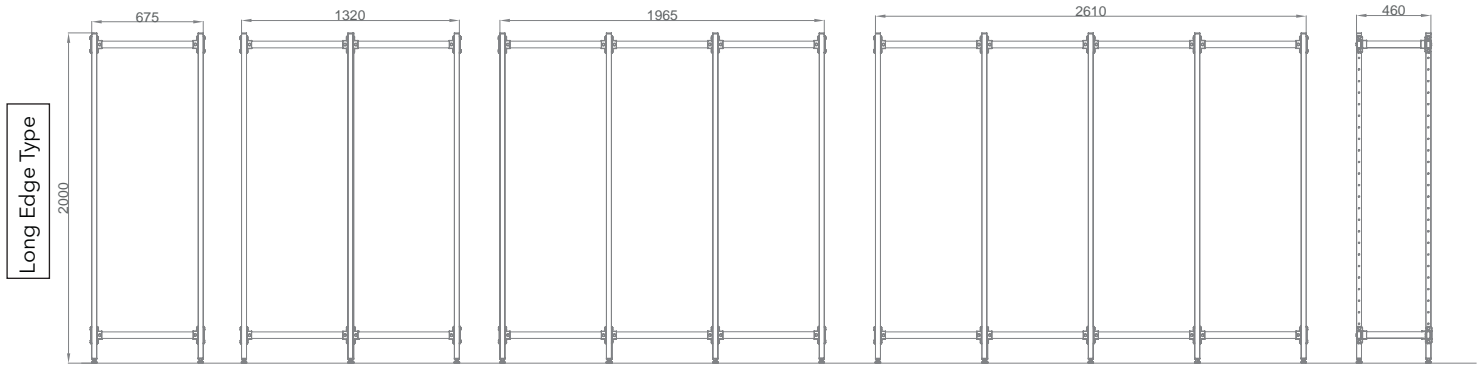

Single

Double

Triple

Quad

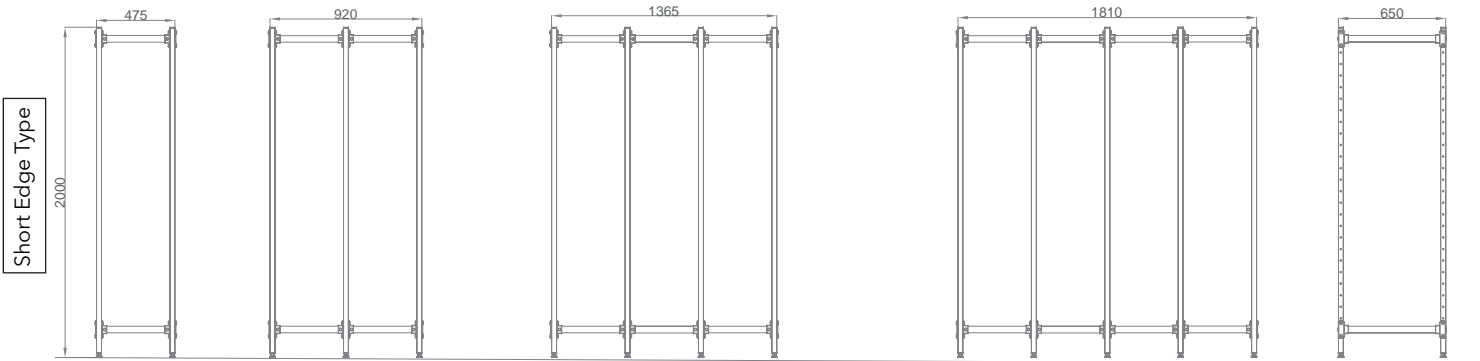

Short Edge Type

Article Codes	L (mm)	W (mm)	H (mm)	Explanation
RF00.91	475	650	2000	Single
RF00.92	920	650	2000	Double
RF00.93	1365	650	2000	Triple
RF00.94	1810	650	2000	Quad

Long Edge Type

Article Codes	L (mm)	W (mm)	H (mm)	Explanation
RF10.91	675	460	2000	Single
RF10.92	1320	460	2000	Double
RF10.93	1965	460	2000	Triple
RF10.94	2610	460	2000	Quad

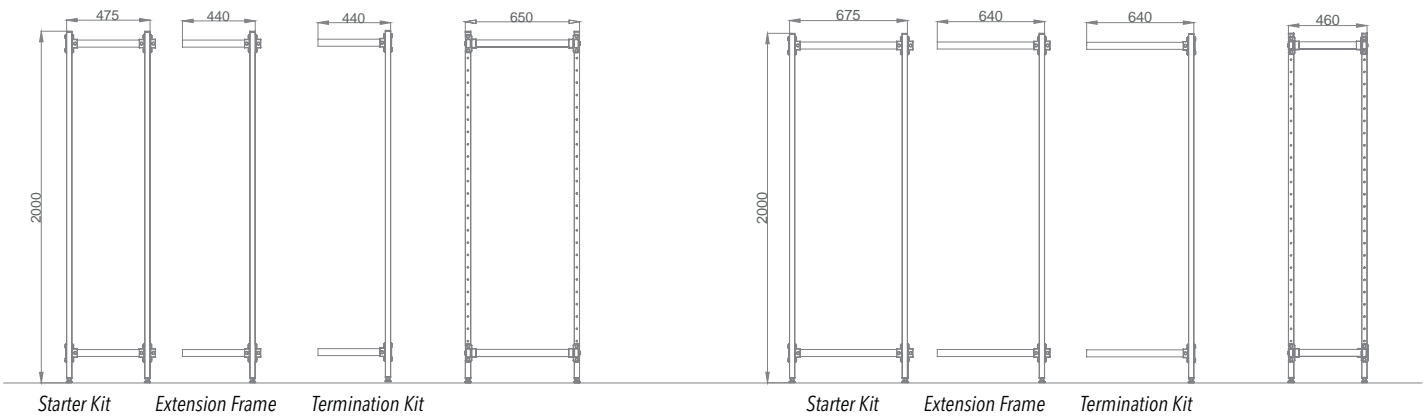

Starter Kit

Extension Frame

Termination Kit

Starter Kit

Extension Frame

Termination Kit

Short Edge Type

Article Codes	L (mm)	W (mm)	H (mm)	Explanation
RF00.25	675	650	2000	Starter Kit
RF00.26	1375	650	2000	Extension Frame
RF00.27	1965	650	2000	Termination Kit

Long Edge Type

Article Codes	L (mm)	W (mm)	H (mm)	Explanation
RF10.25	675	460	2000	Starter Kit
RF10.26	640	460	2000	Extension Frame
RF10.27	1965	460	2000	Termination Kit



- Shelving Systems provides 30% to 45% more efficient space in storage area
- Finding the correct supplies in Inspital Shelving Systems is much easier compared with classical bulk storage
- Clear line of sight enables users to reach correct supply in shorter time
- Fully retractable baskets and trays enables easy access to desired supply with less effort
- Shelving Systems can be easily extended by adding extension frames according to storage room architecture

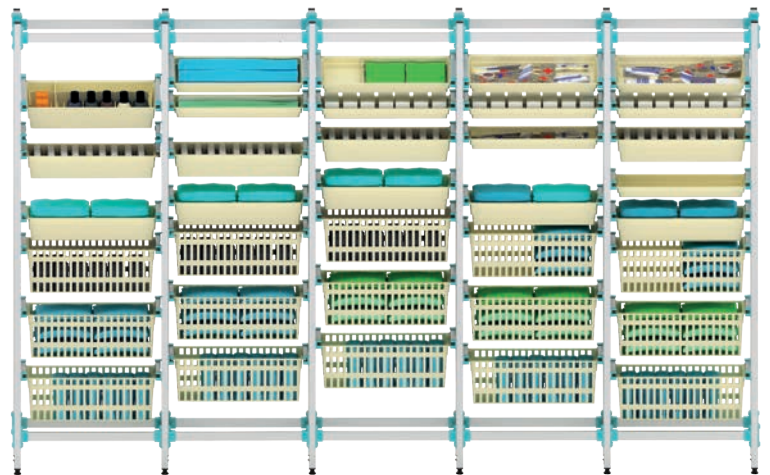

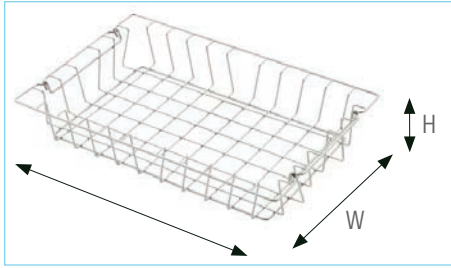

Wire Basket

Article Codes	L (mm)	W (mm)	H (mm)	Explanation
RF40.05	600	400	50	S. Steel
RF40.10	600	400	100	S. Steel
RF40.20	600	400	200	S. Steel

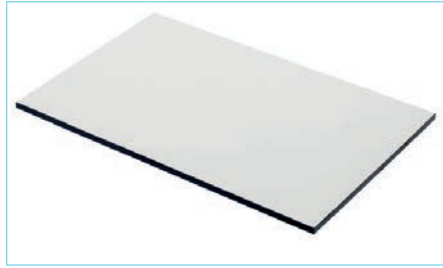

Compact Shelf

Article Codes	L (mm)	W (mm)	H (mm)	Explanation
RF45.10	600	400	10	Compact

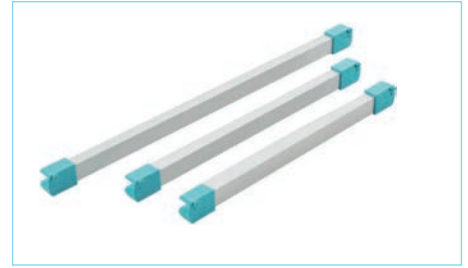

Shelf Rail

Article Codes	L (mm)	W (mm)	Explanation
RF50.95	695	30	Long (Angle)
RF50.20	620	30	Long (Flat)
RF55.95	495	30	Short (Angle)
RF55.20	420	30	Short (Flat)

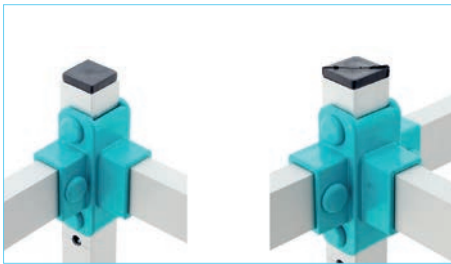

Shelf Connection Part and Profile Clamp

Article Codes	Explanation
RF01.22	2S, 3 Screwed
RF01.33	3S, 4 Screwed
RF05.05	Profile Clamp



Castor

Article Codes	H (mm)	Explanation
TK20.75	75	With Brake
TK10.75	75	Without Brake

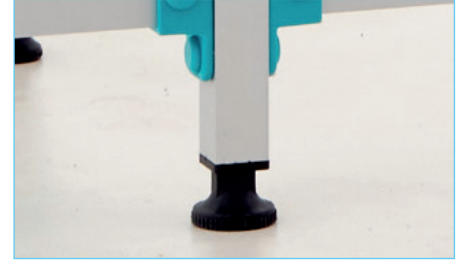

Adjustable Rubber Foot

Article Codes	Explanation
RF30.30	30x30 mm



Side Panel

Article Codes	L (mm)	W (mm)	Explanation
RF80.40	400	600	Short, ABS
RF80.60	600	400	Long, ABS
RF81.40	400	600	Short, Polycarbonate
RF81.60	600	400	Long, Polycarbonate
RF82.40	400	600	Short, Antibacterial
RF82.60	600	400	Long, Antibacterial



Medicine Box

Article Codes	L (mm)	W (mm)	H (mm)	Explanation
RF90.04	600	168	206	4
RF90.05	600	133	165	5
RF90.06	600	92	114	6



Labelling Options

Article Codes	Explanation
RF01.00	Label of 100
RF01.01	Intermediate Label
RF01.02	Outer Label



Slipper Trolley

- Made of stainless steel
- 4 pcs 75 mm castors 2 with brake
- 24 pairs of slipper capacity
- 4 castors 2 of them with brake

Article Codes	L (mm)	W (mm)	H (mm)
RF10.60	995	565	1825



Sit Over Bench

- Made of stainless steel
- Cabinet for shoes
- Adjustable rubber feet
- Modular

Article Codes	L (mm)	W (mm)	H (mm)	Explanation
DP60.04	600	400	600	4 Pairs
DP60.06	850	400	600	6 Pairs
DP60.08	1100	400	600	8 Pairs
DP60.10	1350	400	600	10 Pairs



Classic Shelves

- 5 pcs fixed flat shelves
- Shelves on 140 mm legs with level adjustment
- Made of stainless steel

Article Codes	L (mm)	W (mm)	H (mm)
RF10.70	600	500	1800
RF10.61	800	500	1800
RF10.71	1000	500	1800
RF10.72	1200	500	1800



Wire Shelves

- Designed to be used in operating theatres and sterilization departments
- Stainless steel shelf columns
- 4 adjustable shelves
- Demountable
- Fixed and mobile options

Article Codes	L (mm)	W (mm)	H (mm)	Explanation
AB90.70	1220	460	1830	Fixed
AB90.71	1220	460	1830	Mobile
AB90.72	1520	460	1830	Fixed
AB90.73	1520	460	1830	Mobile
AB90.74	1220	610	1830	Fixed
AB90.75	1220	610	1830	Mobile
AB90.76	1520	610	1830	Fixed
AB90.77	1520	610	1830	Mobile





Stainless Steel Shelves

Article Codes	L (mm)	W (mm)	H (mm)	Explanation
AB90.80	1220	460	1830	Fixed
AB90.81	1220	460	1830	Mobile
AB90.82	1520	460	1830	Fixed
AB90.83	1520	460	1830	Mobile
AB90.84	1220	610	1830	Fixed
AB90.85	1220	610	1830	Mobile
AB90.86	1520	610	1830	Fixed
AB90.87	1520	610	1830	Mobile



Plastic Shelves

Article Codes	L (mm)	W (mm)	H (mm)	Explanation
RF10.80	1220	460	1830	Fixed
RF10.81	1220	460	1830	Mobile
RF10.82	1520	460	1830	Fixed
RF10.83	1520	460	1830	Mobile
RF10.84	1220	530	1830	Fixed
RF10.85	1220	530	1830	Mobile
RF10.86	1520	530	1830	Fixed
RF10.87	1520	530	1830	Mobile



Negatoscopes

- Fully LED panel for homogenous and bright illumination
- 9600 K color temperature for suitable viewing
- Slim design with only 45 mm thickness
- Single, double and triple banks are available
- superior light uniformity $\geq 90\%$
- Absolutely no light flickering

Article Codes	L (mm)	H (mm)	Explanation
NG10.00	495	510	Single
NG20.00	850	510	Double
NG30.00	1200	510	Triple

Electrical Properties:w

- Brightness : 4500 cd/m²
- Power Consumption : ≤ 30 W / bank
- Input : 220-240 VAC
- Light Uniformity : $>90\%$
- Color Temperature : >9600 K
- Light Source : Matrix LED back-light, long life 100,000 hours
- Dimming : Digital dimming, each bank has its individual dimmer
- Screen : Acrylic



NG10.00

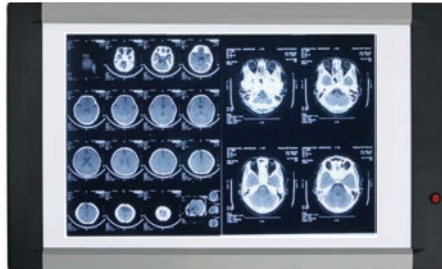

NG20.00

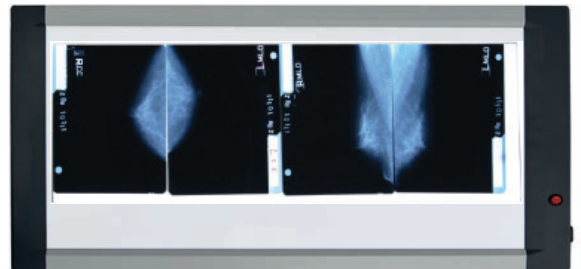

NG30.00



Medicine Cabinets

- Made of stainless steel
- Digital lock
- Floor and wall mounted

Article Codes	L (mm)	W (mm)	H (mm)
DP70.10	210	270	300
DP70.11	300	300	600
DP70.12	500	300	600
DP70.13	800	500	1500



Digital Lock



Hanger Trolley

- Made of stainless steel
- 4 castors 2 of them with brake

Article Codes	L (mm)	W (mm)	H (mm)
AB90.15	1500	550	1700
AB90.12	1200	550	1700





Ultrasonic Cleaning Unit

- Made of stainless steel to be used in the decontamination areas of sterilization units of hospitals in line with user expectations
- 1 or 2 washing sinks option
- Ultrasonic washing section
- 3 cabinets with double doors each
- Faucets with hot & cold water connections for each sink
- Air/water gun with 8 different nozzle options

Article Codes	L (mm)	W (mm)	H (mm)	Explanation
SK80.70	1800	600	900	Double Sink
SK80.71	2700	600	900	Triple Sink



Single Basket & Ultrasonic Washing Technology

- Effective cleaning by ultrasonic wave technology preventing deformation of micro instruments used during operation
- Wire basket with handle facilitating rinse of disinfectants on surgery instruments with its filtering function

Air/Water Gun System

- Compressed air/water gun positioned at both sinks, enabling safe decontamination in lumen instruments used during operation



Ultrasonic Cleaning Unit

- Made of stainless steel
- 12 L capacity, table top system
- 200 W powerful ultrasonic system
- 500 W heating power
- Digital ultrasonic timer (0-100 min)
- Digitally controlled powerful heating system (max 100° C)
- Basket size: 260x200x160 mm

Article Codes	L (mm)	W (mm)	H (mm)	Explanation
SK80.73	310	250	420	Mobil



Compressed Air and Water Gun

- Made of stainless material
- 8 different nozzle options
- Compression control with trigger

Article Codes

SK80.72

Illuminated Inspection Table

- Made of stainless steel
- Designed to make an inspection on sterile units
- 4 pcs 75 mm castors two with brake

Article Codes	L (mm)	W (mm)	H (mm)
AB80.50	1400	600	850
AB80.51	1400	900	900



Plaster Table

- Made of stainless steel
- Sink with gypsum trap
- Sink dimension: 450x450x150 mm
- Upraised edge design to keep fluid in
- Water tap excluded
- Adjustable rubber feet

Article Codes	L (mm)	W (mm)	H (mm)
SK30.10	1650	600	850





Pediatric Plaster Table

- Designed to be used for pelvi pedal plaster applications
- Suitable for adjust various height and length

Article Codes	L (mm)	W (mm)	H (mm)
SK25.05	1010	860-520	320-400



Instrument Washing Sink

- Made of stainless steel
- Large sink design for easy washing
- 40 mm backside wall protection barrier
- Adjustable rubber feet

Article Codes	L (mm)	W (mm)	H (mm)
SK40.10	900	600	850
SK40.11	1400	600	850
SK40.12	1900	600	850



Baby Washing Table

- Made of stainless steel to be used in delivery services
- 2 independent faucets. One is photocell controlled and other one is manually controlled pull-out faucet
- 3 drawers, 1 cabinet and 2 shelves
- Baby scale is included
- Adjustable rubber feet

Article Codes	L (mm)	W (mm)	H (mm)
SK80.10	1650	650	1100



Endoscopy Washing and Storage Table

- Made of stainless steel
- Upraised edge design to protect the wall
- Pullable and extendable faucet for easy cleaning
- 4 drawers and 1 cabinet
- Leakproof drawers for safe storage
- Adjustable rubber feet

Article Codes	L (mm)	W (mm)	H (mm)
SK80.15	1300	750	850





Packaging Table

- Stainless steel design to be used in decontamination areas
- Electrically adjustable table height
- 5 electrical sockets
- LED lighting bar on top
- 1 drawer and 1 cabinet with door
- 2 stainless steel wire baskets
- 1 folder holder
- Computer shelf
- Adjustable rubber feet

Article Codes	L (mm)	W (mm)	H (mm)
MS50.50	1500	700	2000



Packaging Table

- Made of stainless steel
- With drawer (AB50.50) and w/o drawer (AB90.90) models
- Smooth wide packing surface
- Single tray (AB50.50) and double tray (AB90.90) models
- 4 pcs 125 mm castors 2 of them with brake

Article Codes	L (mm)	W (mm)	H (mm)	Explanation
AB90.90	1525	810	865	Double Tray, w/o Drawer
AB50.50	1500	700	2000	Single Tray, w Drawer





Rotary Sealing Device

- Automatic rotary sealing
- Ribbed sealing system
- Reproducible sealing process
- Max power: 390 W
- High sealing speed (10 m/min)
- Seal seam width: 10 mm
- Overheat protection

Article Codes	L (mm)	W (mm)	H (mm)	Explanation
SK21.00	560	260	160	Microprocessor



Impulse Sealing Device

- Microprocessor controlled impulse heat sealing system
- No power consumption when not in use
- Adjustable sealing time
- No heating-up time, immediately ready for use
- Automatic sealing time control
- Overheat protection
- 450 mm extra wide seam seal length
- Seal seam width: 8 mm
- Made of stainless steel chasing cover

Article Codes	L (mm)	W (mm)	H (mm)
SK22.00	555	310	220



Surgical Instrument Trolley

- Made of stainless steel
- 2 removable containers with lid. Large one 500x300x100 mm and small one 300x150x200 mm
- Rigid handle for easy to move
- 4 pcs 75 mm castors 3 with brake

Article Codes	L (mm)	W (mm)	H (mm)
AB90.92	860	440	850



Falcate Table

- Made of stainless steel for operating and intervention rooms
- 2 shelves in shape of falcate
- Upper tray with barrier
- 6 pcs castors 3 of them with brake

Article Codes	L (mm)	W (mm)	H (mm)
AB00.40	1700	450	1000



Mayo Table - Hydraulic

- Made of stainless steel
- Designed concave corners for easy to clean
- Rotating top tray
- Hydraulic controlled by the foot pedal
- 3 pcs 75 mm castors 2 with brake

Article Codes	L (mm)	W (mm)	H (mm)	Explanation
MS10.51	540	740	740-1130	Hydraulic



Mayo Table - Mechanical

- Made of stainless steel
- Designed concave corners for easy to clean
- Rotating top tray
- Mechanically controlled by hand
- 3 pcs 75 mm castors 2 with brake

Article Codes	L (mm)	W (mm)	H (mm)	Explanation
MS10.50	540	740	970-1410	Mechanic



Paper Trolley

- Made of stainless steel
- Designed to transportation and storage for fabrics and papers
- 4 pcs 80 mm castors 2 of them with brake

Article Codes	L (mm)	W (mm)	H (mm)
AB90.91	1100	500	1000



AB50.55

Open Trolley

- Mainframe is made of stainless steel
- 2 options with fixed stainless steel top shelf and 4 adjustable ABS trays or 5 adjustable ABS trays without fixed top shelf
- 4 pcs 75 mm castors 2 with brake

Article Codes	L (mm)	W (mm)	H (mm)
AB50.44	870	450	700
AB50.55	870	450	680



AB50.44

Instrument Table



- Made of stainless steel
- Designed for operating and intervention rooms by considering user's expectations
- Upper tray is designed with barriers on 3 sides
- 4 pcs 75 mm castors 2 with brake

Article Codes	L (mm)	W (mm)	H (mm)	Explanation
AB61.90	900	650	870	With Barrier
AB61.80	800	600	870	With Barrier
AB61.70	700	550	870	With Barrier
AB60.90	900	650	850	W/o Barrier
AB60.80	800	600	850	W/o Barrier
AB60.70	700	550	850	W/o Barrier

Equipment Trolley



- Made of stainless steel
- Designed to be used in operating and intervention rooms
- Handles in both sides for easy to move
- Bumpers on both castors
- 4 pcs castors 2 of them with brake

Article Codes	L (mm)	W (mm)	H (mm)	Explanation
AB62.20	870	550	910	Double Shelf
AB62.30	870	550	910	Triple Shelf



Equipment Trolley



- Made of stainless steel
- Designed to be used in operating and intervention rooms.
- Integrated 6 fold medicine boxes
- Integrated ABS tray
- Handles in both sides for easy to move
- 2 shelves
- Bumpers on both castors
- 4 castors 2 of them with brake

Article Codes	L (mm)	W (mm)	H (mm)
AB62.10	870	550	910



Back view



AB70.20



AB70.30

Utility Trolley

- Made of electrostatic painted steel
- Shelves are made of MDF
- Handles in both sides for easy to move
- Bumpers on both castors
- 4 castors 2 of them with brake

Article Codes	L (mm)	W (mm)	H (mm)	Explanation
AB70.20	910	530	900	Double Shelf
AB70.30	910	530	900	Triple Shelf



Laundry Trolley

- Made of electrostatic painted steel
- Easy to install strong and large size bag
- Bumpers on both castors
- Handles in both sides for easy to move
- 4 castors 2 of them with brake

Article Codes	L (mm)	W (mm)	H (mm)
AB75.05	910	530	900

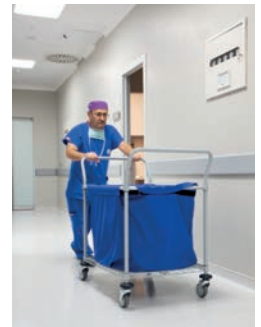

Dressing Trolley

- Made of electrostatic painted steel
- 2 wire baskets
- Bumpers on both castors
- Handles in both sides for easy to move
- 4 castors 2 of them with brake

Article Codes	L (mm)	W (mm)	H (mm)
AB75.15	880	460	860



Instrument Trolley

- Made of stainless steel
- Designed for operating and intervention rooms
- 4 pcs 75 mm castors 2 with brake
- Bumpers on both casters
- Curved corners

Article Codes	L (mm)	W (mm)	H (mm)
AB00.21	900	650	850
AB00.23	800	600	850
AB00.22	700	550	850



Nested Table Trolley

- Made of stainless steel
- Nested type, space efficient storage
- 4 pcs 75 mm castors 2 with brake

Article Codes	L (mm)	W (mm)	H (mm)
AB00.10	1100	550	1000
AB00.11	1000	500	950
AB00.12	900	450	900
AB00.13	800	400	850



Instrument Trolley with Drawer

- Made of stainless steel
- 1 drawer and 2 trays with barriers
- Both trays has barriers on three sides
- Bumpers on both casters
- 4 pcs 75 mm castors 2 with brake

Article Codes	L (mm)	W (mm)	H (mm)
AB00.30	450	480	890



Medical Waste Trolley

- Made of stainless steel to be used in operating and intervention rooms
- 345 L internal capacity with integrated relief valve at the bottom
- 2 doors on top surface
- 4 castors 2 of them with brake

Article Codes	L (mm)	W (mm)	H (mm)
AB00.50	1225	610	960



Transportation Trolley

- Made of stainless steel
- Designed to be used for transportation of sterilization equipment
- Double wing doors with 270°
- Hermetic doors with silicone gasket and lock
- 2 shelves inside
- Handles in both sides for easy to move
- 4 pcs 125 mm castors 2 with brake

Article Codes	L (mm)	W (mm)	H (mm)
AB90.95	960	680	1240
AB90.96	1260	680	1240



Transport Trolley

- Made of stainless steel
- Loading capacity 50 kg
- Handles in one side for easy to move
- 4 pcs 125 mm castors 2 with brake

Article Codes	L (mm)	W (mm)	H (mm)
AB90.93	1200	600	960
AB90.94	900	600	910



AB90.99

Housekeeping Trolley

- Made of stainless steel
- Options: single, double, triple bags
- Metal foot pedals to open the lids
- Specially designed clips for to hold plastic bags
- Options for lid colors
- 4 pcs 75 mm castors 2 with brake

Article Codes	L (mm)	W (mm)	H (mm)	Explanation
AB90.97	400	440	950	Single
AB90.98	700	440	950	Double
AB90.99	1000	440	950	Triple



Durable base tray to support the weight of larger bags

AB90.98



Single, double and triple basket alternatives are available for different departments of the hospital

Hygienic no-touch lid opening by foot pedal

AB90.97



Different lid color options for each basket





Bowl Trolley

- Made of stainless steel
- 2 options with single or double bowl
- Lower tray
- Optional MR compatibility
- 4 pcs 75 mm castors 2 with brake

Article Codes	L (mm)	W (mm)	H (mm)	Explanation
AB90.04	350	350	850	Single
AB90.05	350	700	850	Double



Waste Bins and Kick Bucket

- Made of stainless steel
- Lid and carriage handle (AB90.01, AB90.02)
- Rubber coated metal bumper
- Optional MR compatibility
- 4 pcs 75 mm castors 2 with brake

Article Codes	L (mm)	H min (mm)	Explanation
AB90.01	350	350	20 L
AB90.02	530	530	50 L
AB90.03	400	200	No Lid





Shower Seat

- Stainless steel mainframe and wooden sitting surface
- Foldable
- Wall mounted

Article Codes	L (mm)	W (mm)
SK23.00	350	400



Disabled Grab Rail

- Stainless steel
- Vertically flodable when not in use

Article Codes	L (mm)	W (mm)	D (mm)
SK24.00	200	760	Ø32



Disabled Grab Bar

- Stainless steel

Article Codes	L (mm)	D (mm)
SK25.03	300	Ø32
SK25.04	400	Ø32
SK25.05	500	Ø32
SK25.06	600	Ø32
SK25.09	900	Ø32
SK25.12	1200	Ø32



BS10.20



BS10.10
BS10.11

Surgeon Step Stool

- Made of stainless steel
- Non-slip, wide surface for easy use

Article Codes	L (mm)	W (mm)	H (mm)	Explanation
BS10.10	600	350	180	Single Step
BS10.11	600	350	260	Single Step
BS10.20	600	560	400	Double Step



SK00.80



SK00.81

Pass Through Windows

- Tempered glass
- Adjustable width according to wall thickness
- Optional two way electronic lock

Article Codes	L (mm)	H min (mm)	Explanation
SK00.81	880	950	Double Window
SK00.80	800	950	Single Window
SK00.82	800	950	Electronic Lock



Cylinder Trolley

- Made of stainless steel
- Suitable for 10 L cylinders
- Single and double cylinders options
- Fixing belt for each cylinders
- Bumpers on each castors
- 4 pcs75 mm castors two of them with brake

Article Codes	L min (mm)	H min (mm)	H max (mm)	Explanation
SK00.70	590	410	850	Double
SK00.71	350	410	850	Single

Examination Table

- Made of stainless steel mainframe
- Antibacterial leather coated foam (32 density)
- Adjustable head section
- Foldable legs
- Adjustable rubber feet

Article Codes	L (mm)	W (mm)	H (mm)
SK00.62	1800	600	800



SK00.60

Hospital Screens

- PVC and Fabric Panel options with electrostatic painted frame
- 2 Options with 3 panels or 4 panels collapsible screen
- Mobile, easy to move system

Article Codes	L (mm)	W (mm)	H (mm)	Explanation
SK00.60	1860	380	1700	3 - Panel-PVC
SK00.61	2500	380	1700	4 - Panel-PVC
SK00.63	1860	380	1700	3 - Panel-Fabric
SK00.64	2500	380	1700	4 - Panel-Fabric



SK00.61



SR10.40

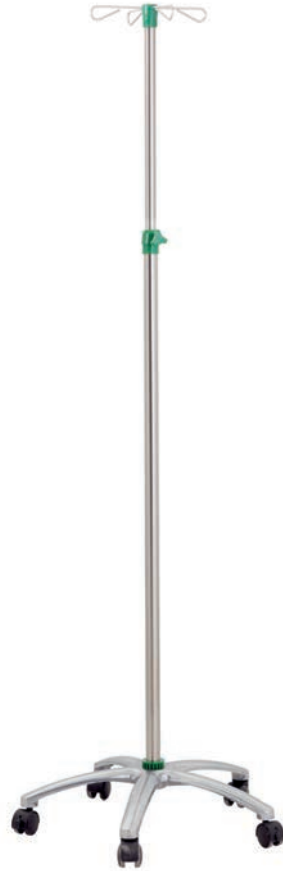

SR10.50



SR10.60

IV Stands

- Made of stainless steel
- Hook height can be adjusted between 1200-2100 mm
- 4 hooks to hang IV
- Infusion devices mountable body structure
- 2 options with plastic or chrome plated star base
- Star base with five castors two with brake

Article Codes	L min (mm)	H min (mm)	H max (mm)
SR10.40	590	1200	2100
SR10.50	590	1200	2100
SR10.60	320	1370	2470



Hydraulic Stool

- Hydraulic height adjustment
- PU seat
- Reinforced and chrome plated star base options
- Optional lower stools with min 410 mm and max 550 mm heights



A. Codes	H min	H max	Explanation
TB10.60	470 mm	600 mm	Plastic Base Hand Controlled
TB30.60			Chromed Base Hand Controlled
TB50.70			Chromed Base Foot Controlled



A. Codes	H min	H max	Explanation
TB10.55	470 mm	600 mm	Plastic Base Hand Controlled
TB30.55			Chromed Base Hand Controlled
TB60.70			Chromed Base Foot Controlled



A. Codes	H min	H max	Explanation
TB20.60	470 mm	600 mm	Plastic Base Hand Controlled
TB40.60			Chromed Base Hand Controlled
TB70.70			Chromed Base Foot Controlled



A. Codes	H min	H max	Explanation
TB20.55	470 mm	600 mm	Plastic Base Hand Controlled
TB40.55			Chromed Base Hand Controlled
TB80.70			Chromed Base Foot Controlled



SK00.20
SK00.21



SK00.30
SK00.31

Kidney Trays and Bowls

- Made of stainless steel

Article Codes	L (mm)	W (mm)	H (mm)	Explanation
SK00.20	320	220	45	Tray with Lid
SK00.21	280	180	45	Tray with Lid

Article Codes	L (mm)	Explanation
SK00.30	250	Kidney Bowl Small
SK00.31	300	Kidney Bowl Large



Trommels

- Made of stainless steel
- Suitable for sterilization

Article Codes	L (mm)	H min (mm)
SK00.10	150	190
SK00.11	190	190
SK00.12	240	240
SK00.13	290	240
SK00.14	320	240
SK00.15	360	240
SK00.16	390	240



Waste Bin

- Made of stainless steel to be used in operation and intervention rooms
- 2 Options with 11 L or 48 L capacity

Article Codes	L (mm)	W (mm)	H (mm)	Explanation
SK00.40	200	180	380	11 L
SK00.41	300	350	610	48 L



Inductive work time counter

Purified air



UV-C flow chamber

Contaminated air

UV-C Flow Germicidal Lamps

System disinfects the air by the UV germicidal lamp located in the disinfection chamber. It takes the contaminated air on one side and gives the purified air on other side. Models with external UV lamp provides a wider range of effective area.

Types of housing:

- Stainless steel (INOX)
- Coated aluminium sheet
- Coated carbon steel sheet
- Any RAL color available on request
- Custom mounting elements available on request

Mounting options:

Supply Voltage :230 V, 50 Hz
 Power consumption :115 W
 Lamp Type :2x55 W / 2x30 W
 Useful lifetime of the bulb :Min 8000 h
 Lamp weight type :8,5 Kg
 Cover type :IP 20
 Made of stainless steel

Article Codes	L (mm)	W (mm)	H (mm)	Explanation
LP20.55	1112	135	210	55 W
LP20.30	1112	135	210	30 W
LP40.55	1112	135	210	Ext. UV Lamp, 55 W
LP40.30	1112	135	210	Ext. UV Lamp, 30 W

Disinfection of the air by means of UV-C radiation in the flow germicidal lamps is carried out inside a disinfection chamber. Contaminated air is drawn by a fan - through a filter catching dust and other contaminations-into the disinfection chamber. The UV-C tube intensity and a time during which air remains in the disinfection chamber are selected so that air blown out from the lamp is practically free of microorganisms. Velocity of air flow through the disinfection chamber is therefore selected as a compromise between a desire to disinfect the greatest volume of air per time unit and germicidal effectiveness. It should also be noted that the forced flow of air results in a smooth circulation of air in the room and thus disinfection of air in the whole room.



Morgue Unit

- Double drawers
- Side way loading
- Made of stainless steel

Temperature Scale : -5/+10°C
 Operation Temperature : +2/+4°C
 Power : 800-1600 W
 Illumination : 36 W floresan
 Defrost : Full automatic
 Air Flow : Fan controlled
 Temperature Isolation : PU isolation
 Voltage : 220-240 V/50-60 Hz

Article Codes	L (mm)	W (mm)	H (mm)	Explanation
MG40.10	2400	800	1000+350	Single
MG40.20	2400	800	1600+350	Double



MG50.30



MG50.20

Morgue Unit

- Double drawers
- Front way loading
- Made of stainless steel

Temperature Scale : -5/+10°C
 Operation Temperature : +2/+4°C
 Power : 800-1600 W
 Illumination : 36 W floresan
 Defrost : Full automatic
 Air Flow : Fan controlled
 Temperature Isolation : PU isolation
 Voltage : 220-240 V/50-60 Hz

Article Codes	L (mm)	W (mm)	H (mm)	Explanation
MG50.20	2400	800	1600+350	Double
MG50.30	2400	800	2200+350	Triple



Rotating Autopsy Table

- Made of stainless steel
- Shower and washing unit
- Fixed base and 350° rotatable corpse tray

Article Codes	L (mm)	W (mm)	H (mm)
MG80.10	2250	1000	850



Autopsy Table

- Made of stainless steel
- Vacuum system operates with water
- Compressed air and water spray gun
- Garbage grinder (optional)
- Two integrated electric sockets

Article Codes	L (mm)	W (mm)	H (mm)
MG70.10	2800	900	900



Body Washing Table

- Made of stainless steel
- Top tray is designed for easy draining
- Cabinet with door on the leg part

Article Codes	L (mm)	W (mm)	H (mm)
MG60.10	2000	900	920



Lift for Morgue

- Made of stainless steel
- Designed to lift the corpse to 2nd and 3rd floor cells
- Designed to be easily guided by pushing handle
- 4 pcs 125 mm castors two brake
- Manual hydraulic lift system

Article Codes	L (mm)	W (mm)	H (mm)
MG90.10	2100	700	350-1750

INSPIITAL

**INSPIITAL Medical
Technology GmbH**

Kalkumer Str. 125

40468 Düsseldorf, GERMANY

Tel: +49 211 680 20 53-54

Fax: +49 211 680 20 55

www.inspital.com

info@inspital.com