

OPIS

FURNIZARE BUNURI IN CADRUL PROIECTULUI BIBLIOTECHE ROMD00084 (ECHIPAMENTE IT (30200000-1), MOBILIER (39100000-3), SOFTWARE EDUCATIONAL SI SISTEME INFORMATICE (48000000-8), KITURI VR SI ECHIPAMENTE MULTIMEDIA (32320000-2)

LOT 2 MOBILIER - ILUSTRARI

Nr. crt.	DENUMIRE PRODUS ILUSTRAT	Pag.
1	OPIS	1
2	PREZENTARE PROCEDURĂ	2
3	BIROU MODULAR FĂRĂ SCAUN	3
4	PARAVAN MODULAR FONOAORBANT ȘI SEPARATOR VIZUAL	4
5	PUPITRU MODULAR PENTRU SISTEME ALL-IN-ONE	5
6	FOTOLIU	6
7	ANSAMBLU MOBILIER DE COLȚ PENTRU STUDIO PODCAST	7
8	MĂSUȚĂ PODCAST	8
9	SCAUN REGLABIL	9
10	BIBLIOTECĂ DESCHISĂ	10
11	FOTOLIU PUF	11
12	CORP MOBILIER CU BĂNCUȚE 1667×450×2000 MM	12
13	CORP MOBILIER CU RAFTURI (UNITATE MODULARĂ)	13
14	BIBLIOTECĂ MODEL CURB CU ZONĂ DE ȘEZUT	14
15	MĂSUȚĂ JOASĂ	15
16	DULAP MODULAR DE COLȚ CU 24 CASETE INDIVIDUALE	16
17	CUIER PERETE CU FORME ATIPICE ȘI COLANTARE PEREȚI (MIN. 40MP)	17
18	BIROU INDIVIDUAL	18
19	SCAUN BIROU ERGONOMIC	19
20	STAȚIE DE ÎNCĂRCARE SMART PRO	20
21	DULAP PENTRU ECHIPAMENTE AUDIOVIZUALE	21
22	SERVANTĂ ȘI SUPORT TABLĂ INTERACTIVĂ	22
23	ETAJERE PENTRU CĂRȚI (SET 10 BUC.)	23
24	MASĂ PENTRU 8 PERSOANE (MASĂ ÎNALTĂ)	24

ANEXĂ – ILUSTRĂȚII PRODUSE OFERTATE

LOT 2 – MOBILIER

Procedura:

Furnizare bunuri în cadrul proiectului BiblioTech ROMD00084

Referință:

ROMD00084/2026/L2

Autoritate contractantă:

Biblioteca Națională a Republicii Moldova

Ofertant:

GRAPHTEC DESIGN S.R.L.

Iunie 2026

Produs nr. 1

Birou modular (fără scaun)

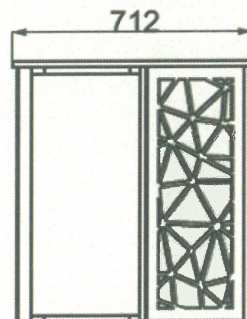
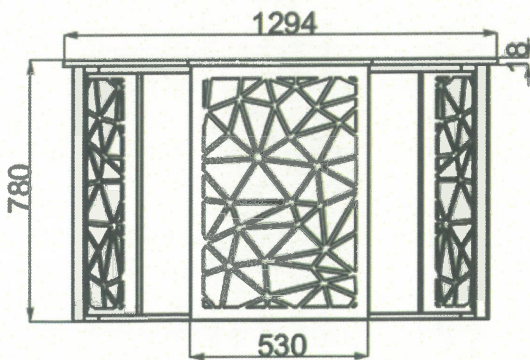
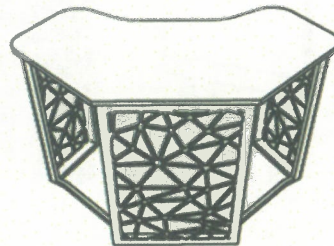
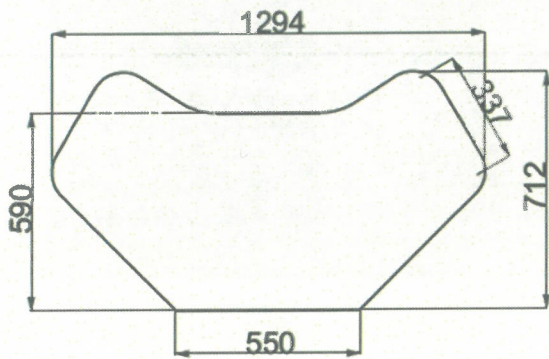

Produs nr. 2

Paravan modular fonoabsorbant și separator vizual

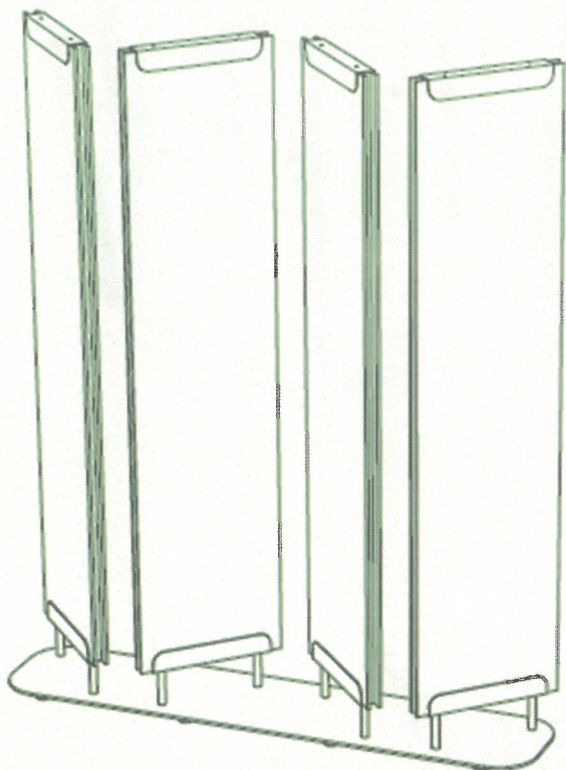

Produs nr.3

Pupitru modular pentru sisteme All-in-One

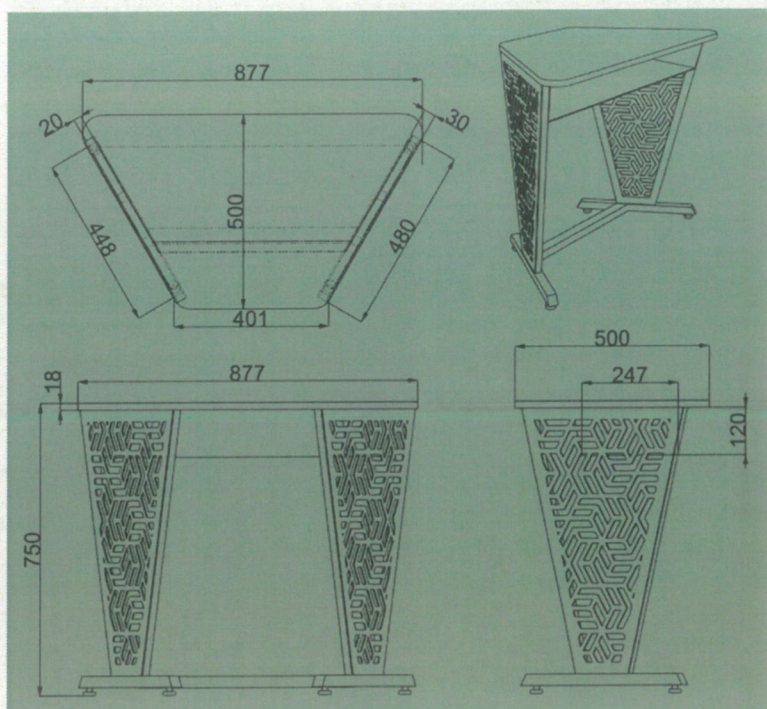
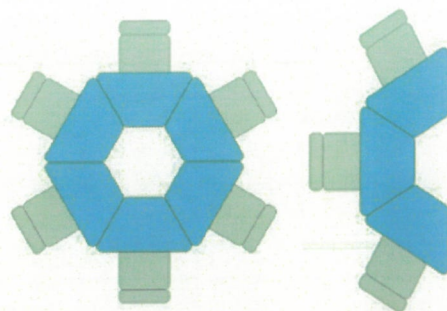

Prodis nr.4

Fotoliu



Produs nr.5

Ansamblu mobilier de colț pentru studio podcast



Produs nr.6

Măsuță podcast



Produs nr.7

Scaun reglabil



Produs nr.8

Biblioteca deschisă

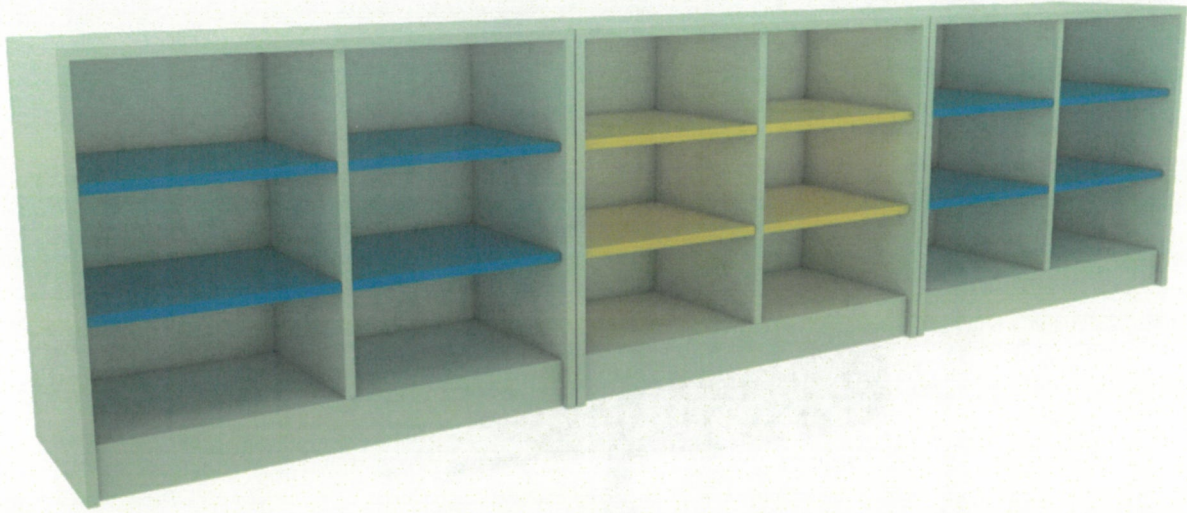

Produs nr.9

Fotoliu puf (beanbag)



Produs nr.10

Corp mobilier cu băncuțe 1667×450×2000 mm



Produs nr.11

Corp mobilier cu rafturi (unitate modulară)



Produs nr.12

Biblioteca model curb cu zonă de șezut

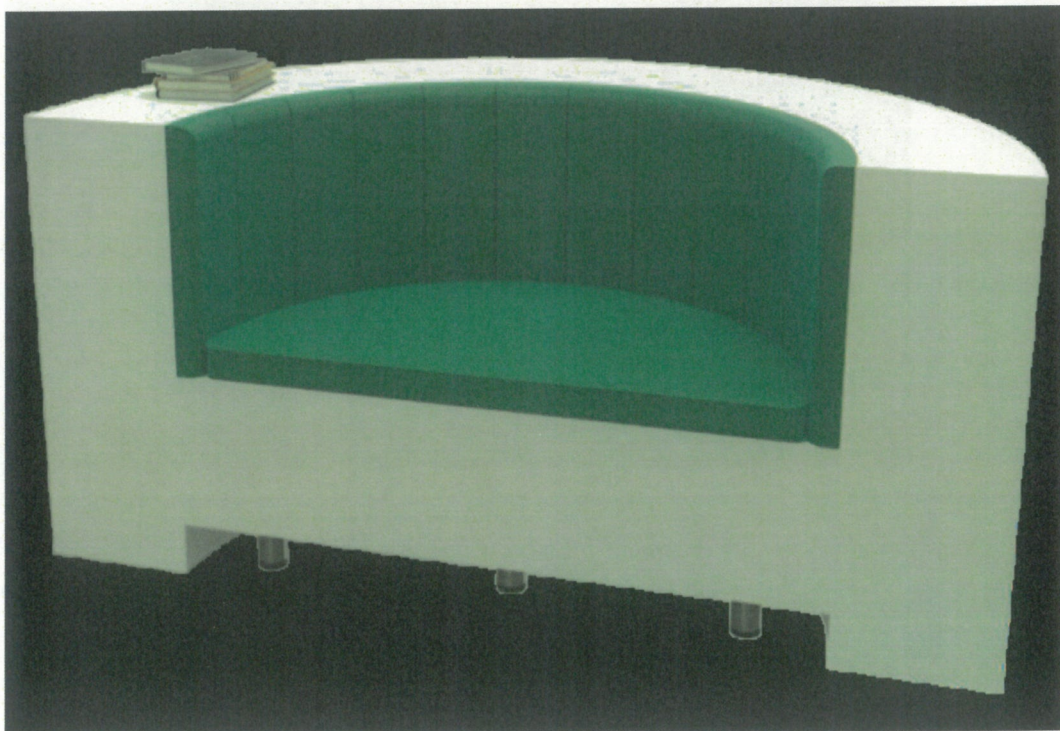
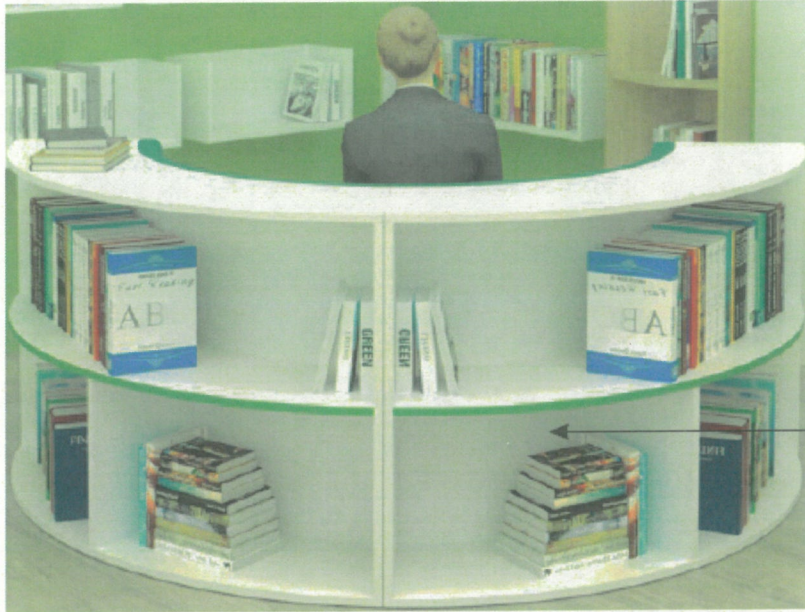

Produs nr.13

Măsuță joasă

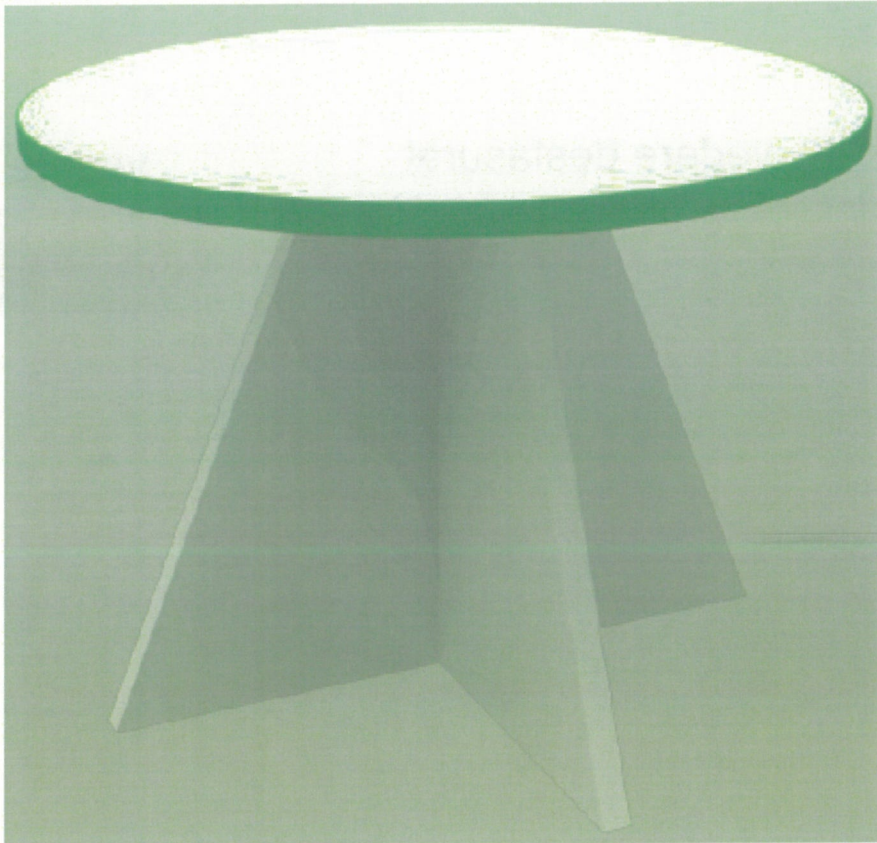

Produs nr.13

Dulap modular de colț cu 24 casete individuale

vedere desfasurat



h 1918
24 locuri

vedere de sus



Produs nr.14

Cuier perete cu forme atipice și colantare pereți (min. 40 mp)

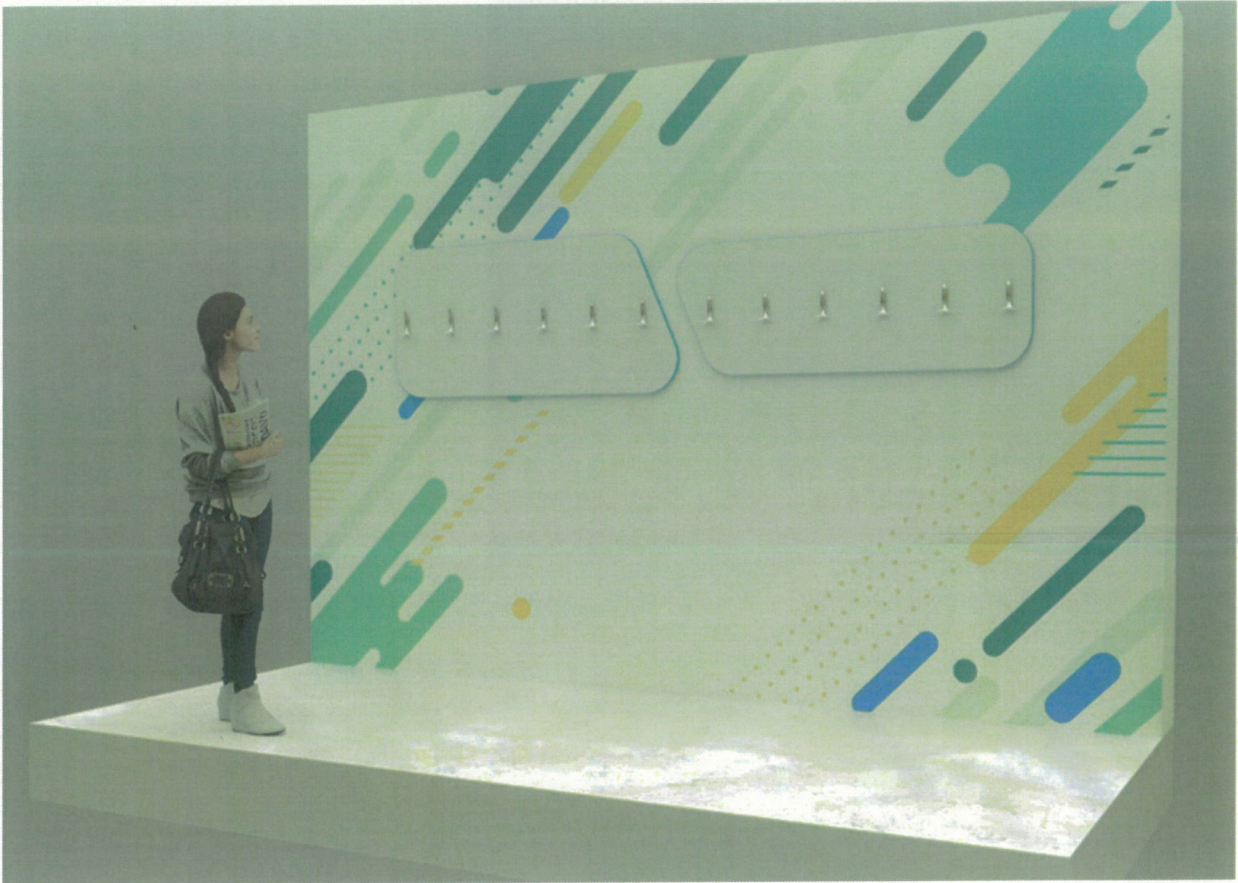

Produs nr.15

Birou individual

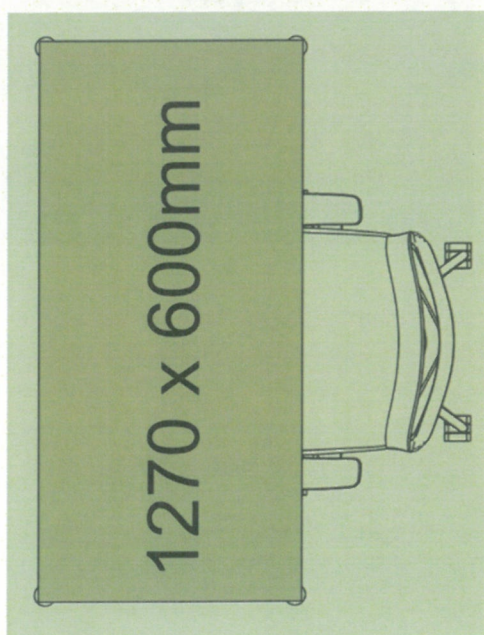

Produs nr.16

Scaun de birou ergonomic



Produs nr.17

Stație de încărcare Smart Pro

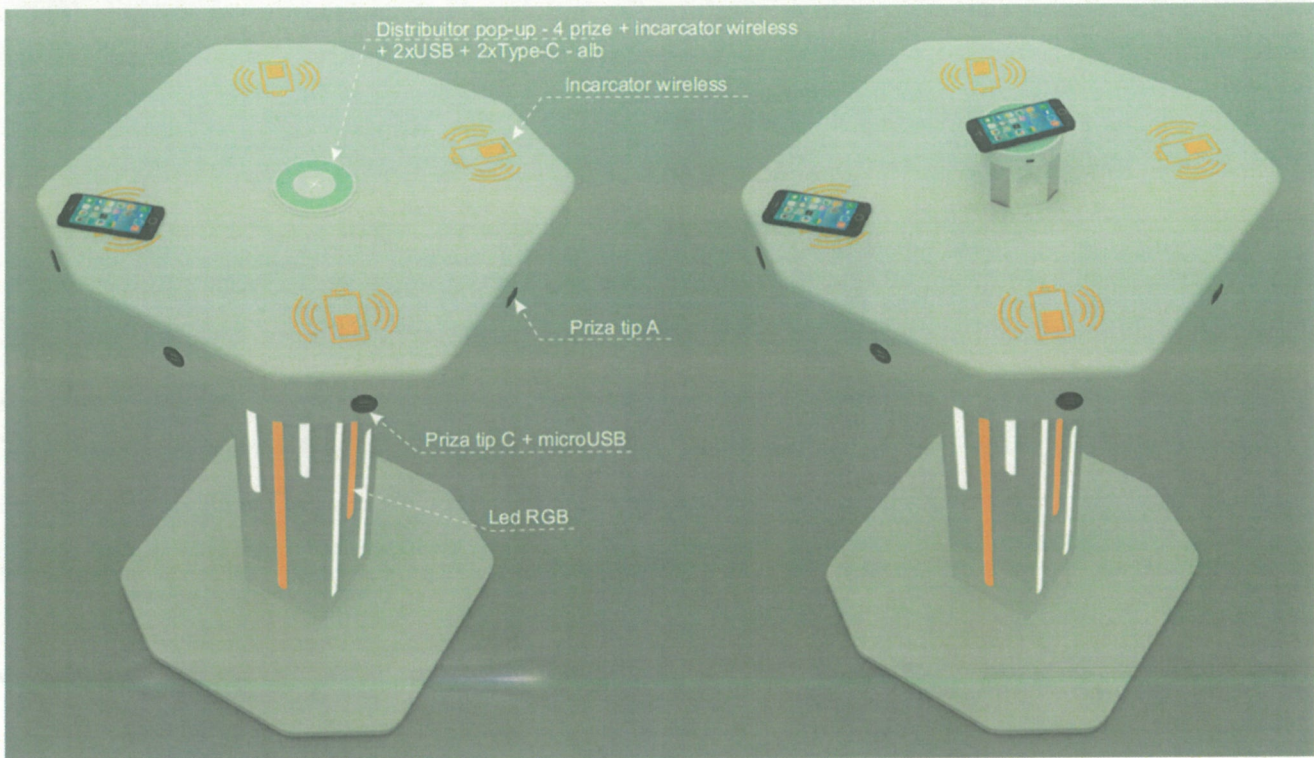

Produs nr.18

Dulap pentru echipamente audiovizuale



Produs nr.19

Servantă și suport tablă interactivă



Produs nr.20

Etajere pentru cărți (set 10 buc.)



Produs nr.21

Masă pentru 8 persoane (masă înaltă)

