

MANI®

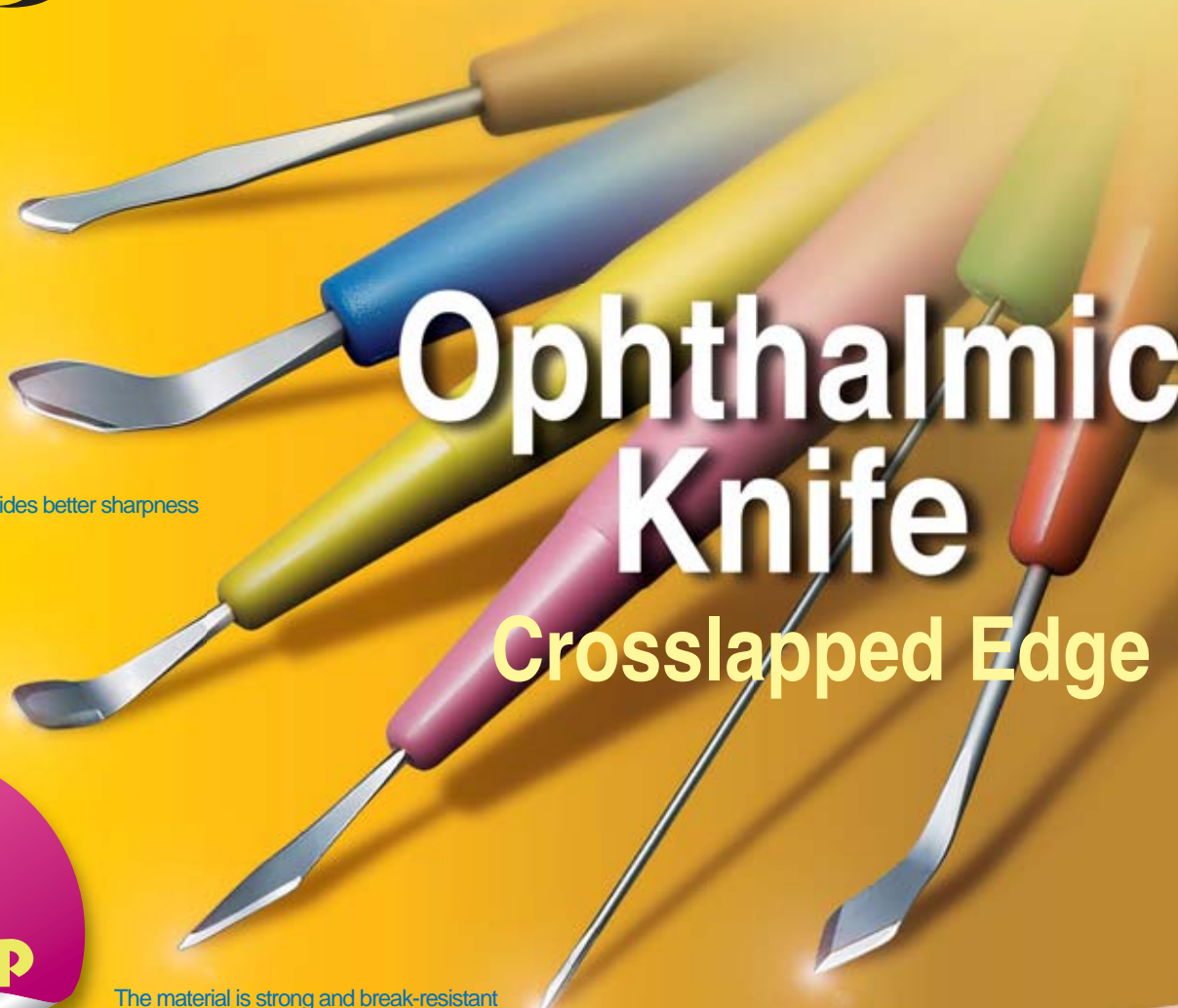

Ophthalmic Knife

Crosslapped Edge

Crosslapped edge provides better sharpness

**New
Line Up**

The material is strong and break-resistant
MANI®'s original hard fiber stainless steel



MANI® Ophthalmic Knife

■ Straight Knife

6pcs/box

○Main Application: Scleral groove incision, Side port

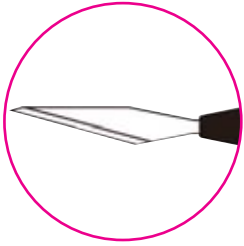

MST



Actual size

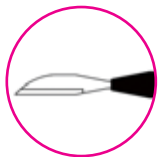

Straight 0°

Product Name	ORDER#
Straight 0°	MST00
Straight 15°	MST15
Straight 22.5°	MST22
Straight 30°	MST30
Straight 45°	MST45

■ Marking Straight Knife

6pcs/box

○Main Application: Scleral groove incision, Side port

NEW

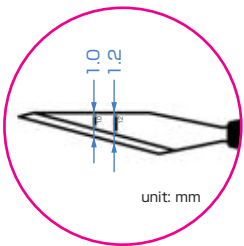

MST-MK

Marking lines at 1.0mm and 1.2 mm from the blade tip assist to make an accurate width of side port.



Actual size

Product Name	ORDER#
Straight 15° (Marking)	MST15MK
Straight 22.5° (Marking)	MST22MK

■ Safety Straight Knife

6pcs/box

○Main Application: Scleral groove incision, Side port

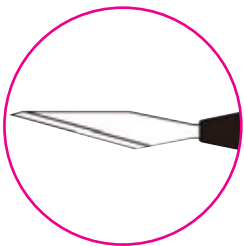

MST-SK



Actual size

Product Name	ORDER#
Straight 15° (Safety)	MST15SK
Straight 22.5° (Safety)	MST22SK
Straight 30° (Safety)	MST30SK

※For handling of MANI® Safety Knife, please refer to the back cover.

The crosslapped edge made of MANI®'s original hard fiber stainless steel produces the ultimate sharpness.

Slit Knife

Angle = 45°

6pcs/box

○Main Application: Corneal Incision, Scleral Incision

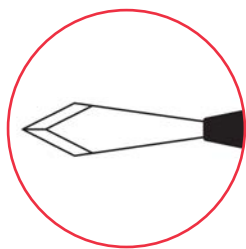

MSL·MSS



Actual size

Product Name	ORDER#
Slit Angled 1.0mm	MSL10
Slit Angled 1.1mm	MSL11
Slit Angled 1.2mm	MSL12
Slit Angled 1.3mm	MSL13
Slit Angled 1.4mm	MSL14
Slit Angled 1.6mm	MSL16
Slit Angled 1.8mm	MSL18
Slit Angled 1.9mm	MSL19
Slit Angled 2.0mm	MSL20
Slit Angled 2.1mm	MSL21
Slit Angled 2.2mm	MSL22
Slit Angled 2.3mm	MSL23
Slit Angled 2.4mm	MSL24
Slit Angled 2.5mm	MSL25
Slit Angled 2.65mm	MSL26
Slit Angled 2.75mm	MSL27
Slit Angled 2.8mm	MSL28
Slit Angled 2.9mm	MSL29
Slit Angled 3.0mm	MSL30
Slit Angled 3.2mm	MSL32
Slit Angled 3.5mm	MSL35
Slit Straight 1.0mm	MSS10
Slit Straight 2.8mm	MSS28
Slit Straight 3.0mm	MSS30

MANI® Ophthalmic Knife

Short-Head Slit Knife

Angle = 45°

6pcs/box

NEW

○Main Application: Corneal Incision, Scleral Incision

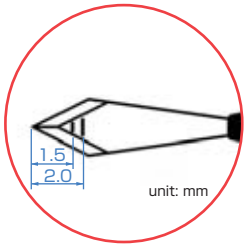

MSL-SH
(with Marking)



Actual size

Product Name	ORDER#
Slit Angled 2.0mm (Short-Head)	MSL20SH
Slit Angled 2.1mm (Short-Head)	MSL21SH
Slit Angled 2.2mm (Short-Head)	MSL22SH
Slit Angled 2.3mm (Short-Head)	MSL23SH
Slit Angled 2.4mm (Short-Head)	MSL24SH
Slit Angled 2.5mm (Short-Head)	MSL25SH
Slit Angled 2.65mm (Short-Head)	MSL26SH
Slit Angled 2.75mm (Short-Head)	MSL27SH
Slit Angled 2.8mm (Short-Head)	MSL28SH
Slit Angled 2.9mm (Short-Head)	MSL29SH
Slit Angled 3.0mm (Short-Head)	MSL30SH

Comparison with conventional knives

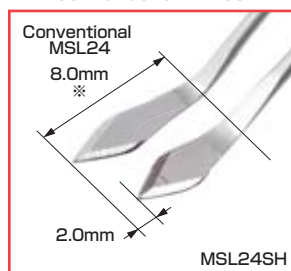

★Extreme Sharpness, Simple Operation, High Visibility

Position of Knife Angle moved 2mm towards the tip and the blade became smaller with extreme sharpness as our conventional models. Effective for a patient who has sunken/deep-set eye (enophthalmos) or narrow lid fissure.

Less possibility of contacting with eye speculum and drapes. In addition, marking lines at 1.5mm and 2.0mm from the blade tip enable simple operation for creating tunnel.

※MSL20~24SH= (8mm→6mm) MSL25~30SH= (9mm→7mm)

★Example of use of the marking lines

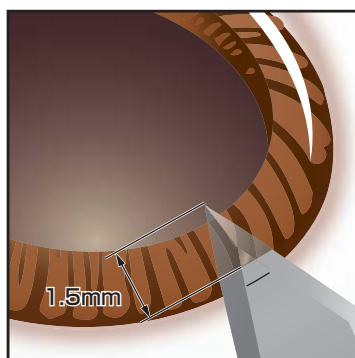

Corneal Incision

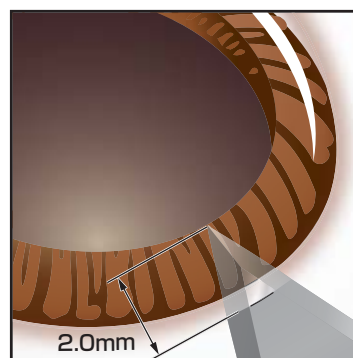

Scleral Incision

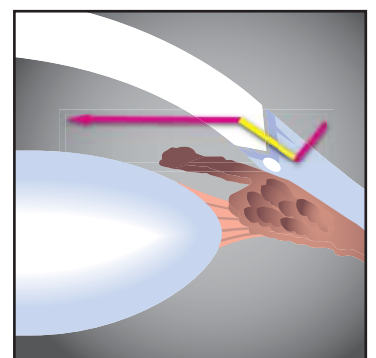

Perforation towards anterior chamber using the marking lines as an indicator.

The crosslapped edge made of MANI®'s original hard fiber stainless steel produces the ultimate sharpness.

■ Safety Slit Knife

Angle = 45°

6pcs/box

○Main Application: Corneal Incision, Scleral Incision

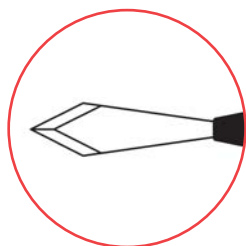

MSL-SK



Actual size

Product Name	ORDER#
Slit Angled 1.0mm (Safety)	MSL10SK
Slit Angled 1.2mm (Safety)	MSL12SK
Slit Angled 1.4mm (Safety)	MSL14SK
Slit Angled 1.8mm (Safety)	MSL18SK
Slit Angled 2.0mm (Safety)	MSL20SK
Slit Angled 2.2mm (Safety)	MSL22SK
Slit Angled 2.3mm (Safety)	MSL23SK
Slit Angled 2.4mm (Safety)	MSL24SK
Slit Angled 2.5mm (Safety)	MSL25SK
Slit Angled 2.65mm (Safety)	MSL26SK
Slit Angled 2.75mm (Safety)	MSL27SK
Slit Angled 2.8mm (Safety)	MSL28SK
Slit Angled 3.0mm (Safety)	MSL30SK
Slit Angled 3.2mm (Safety)	MSL32SK

*For handling of MANI® Safety Knife, please refer to the back cover.

MANI® Ophthalmic Knife

■ Arched Knife Angle = 45°

6pcs/box

○Main Application: Corneal Incision

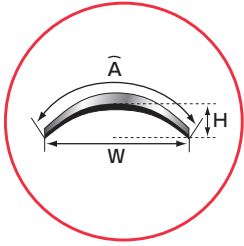

MSL-AB



Actual size

Product Name (Blade Width)	ORDER#
Slit Angled 1.8mm Arched (Ā 1.8mm W 1.7mm H 0.3mm)	MSL18AB
Slit Angled 2.0mm Arched (Ā 2.0mm W 1.85mm H 0.35mm)	MSL20AB
Slit Angled 2.2mm Arched (Ā 2.2mm W 2.05mm H 0.35mm)	MSL22AB
Slit Angled 2.5mm Arched (Ā 2.5mm W 2.4mm H 0.35mm)	MSL25AB
Slit Angled 2.65mm Arched (Ā 2.65mm W 2.5mm H 0.35mm)	MSL26AB
Slit Angled 2.8mm Arched (Ā 2.8mm W 2.6mm H 0.4mm)	MSL28AB
Slit Angled 3.0mm Arched (Ā 3.0mm W 2.8mm H 0.45mm)	MSL30AB
Slit Angled 3.2mm Arched (Ā 3.2mm W 3.0mm H 0.55mm)	MSL32AB
Slit Angled 3.4mm Arched (Ā 3.4mm W 3.2mm H 0.55mm)	MSL34AB

※Better self-closing incision. Low risk of infection.

★Arched Knife is a slit knife designed for clear corneal incision with IOL injector system.

Please refer to the width in order to find your best size.

If you are using MSL24 (2.4mm) now, MSL25AB should be the correct choice as its width (W) is 2.4mm.

The incision location is different from that of normal "flat" knife because the arched knife has a three-dimensional blade.

Please make sure that your Phaco tip and Injector fit properly with the arched knife you chose. We recommend to try the compatibility between the arched knife & your Injector at a wet lab in order to find the right size from our line-up.

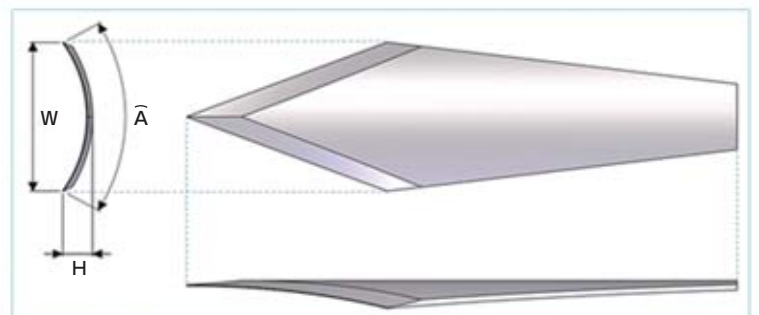

**IT IS UNABLE TO MAKE THE WOUND WIDER AFTER THE INCISION
BECAUSE OF INCISION SHAPE.**

Please read Instruction for Use carefully before use.

The crosslapped edge made of MANI®'s original hard fiber stainless steel produces the ultimate sharpness.

MVR Knife

Angle = 45°

6pcs/box

○Main Application: Side port, Scleral port

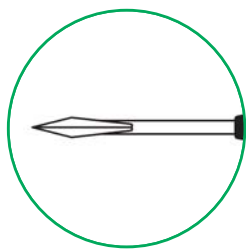

MVR•MPK



Actual size

Product Name (Blade Width)	ORDER#
MVR-Lance 19G (1.5mm)	MVR19
MVR-Lance 20G (1.2mm)	MVR20
MVR-Lance 23G (0.9mm)	MVR23
MVR-Lance 24G (0.8mm)	MVR24
MVR-Lance 25G (0.55mm) Insertable into 23G infusion cannula and be used for membrane peeling.	MVR25
MVR-Angled 19G (1.5mm)	MVR19A
MVR-Angled 20G (1.2mm)	MVR20A
MVR-Angled 21G (1.1mm)	MVR21A
MVR-Angled 23G (0.9mm) ★	MVR23A
MVR-Angled 24G (0.8mm)	MVR24A
MVR-Angled 23G (0.7mm) ★	MVR23AD
Port Knife 25G (0.45mm) Insertable into 25G infusion cannula and be used for membrane peeling.	MPK25
Port Knife 27G (0.40mm) Insertable into 27G infusion cannula and be used for membrane peeling.	MPK27

★ Similar ORDER#. The difference is blade width.

Safety MVR Knife

Angle = 45°

6pcs/box

○Main Application: Side port, Scleral port

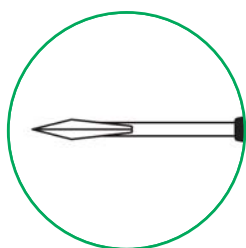

MVR-SK



Actual size

Product Name (Blade Width)	ORDER#
MVR-Angled 20G (1.2mm) (Safety)	MVR20ASK
MVR-Angled 21G (1.1mm) (Safety)	MVR21ASK
MVR-Angled 23G (0.9mm) (Safety)	MVR23ASK
MVR-Angled 24G (0.8mm) (Safety)	MVR24ASK

※For handling of MANI® Safety Knife, please refer to the back cover.

MANI® Ophthalmic Knife

Crescent Knife

Angle = 60°

6pcs/box

○Main Application: Scleral tunnel, Scleral flap

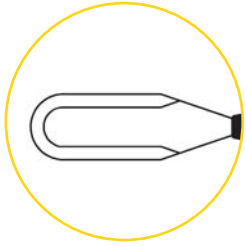

MCU·MCD
MCS



Actual size

Product Name (Blade Width)	ORDER#
Crescent Bevel Up (2.3mm)	MCU26
Crescent Bevel Up (2.0mm)	MCU20
Crescent Bevel Down (2.3mm)	MCD26
Crescent Straight (2.3mm)	MCS26

Short-Head Crescent Knife

Angle = 60°

6pcs/box

○Main Application: Scleral tunnel, Scleral flap

NEW

Conventional MCU26

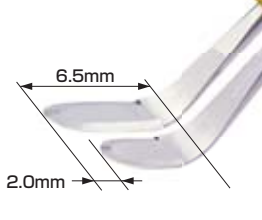

MCU26SH

Comparison with
conventional products



Actual size

Product Name (Blade Width)	ORDER#
Crescent Bevel Up (2.3mm) (Short-Head)	MCU26SH
Crescent Bevel Up (2.0mm) (Short-Head)	MCU20SH

Mini Crescent Knife

Angle = 25°

6pcs/box

○Main Application: Scleral flap

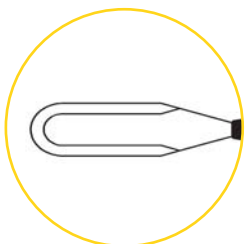

MCB



Actual size

Product Name (Blade Width)	ORDER#
Crescent Double Bevel (1.0mm)	MCB10
Crescent Double Bevel (1.25mm)	MCB12

The crosslapped edge made of MANI®'s original hard fiber stainless steel produces the ultimate sharpness.

Safety Crescent Knife

Angle = 60°

6pcs/box

○Main Application: Scleral tunnel, Scleral flap

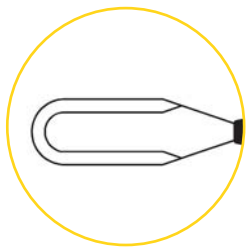

MCU-SK



Actual size

Product Name (Blade Width)	ORDER#
Crescent Bevel Up (2.3mm) (Safety)	MCU26SK
Crescent Bevel Up (2.0mm) (Safety)	MCU20SK

※For handling of MANI® Safety Knife, please refer to the back cover.

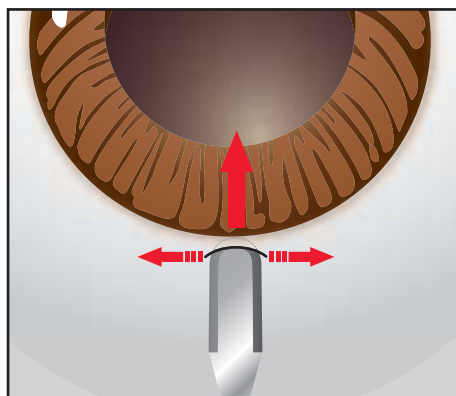

Insert the Knife into the 1st scleral incision and forward the blade into clear cornea with shifting blade from side to side.

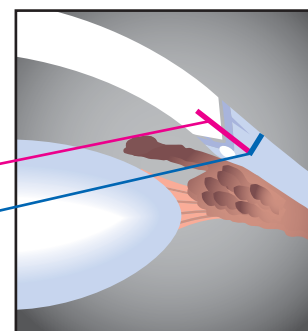

2nd Scleral pocket

1st Scleral Incision

R Slit Knife (Implant)

Angle = 45°

6pcs/box

○Main Application: IOL enlargement

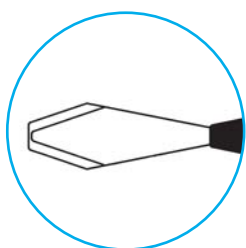

MRS



Actual size

Product Name	ORDER#
R Slit Angled 2.6mm	MRS26
R Slit Angled 3.2mm	MRS32
R Slit Angled 3.5mm	MRS35
R Slit Angled 3.75mm	MRS37
R Slit Angled 4.1mm	MRS41
R Slit Angled 5.2mm	MRS52
R Slit Angled 5.5mm	MRS55

MANI[®] Ophthalmic Knife

Golf/Scleral Knife

6pcs/box

○Main Application: Scleral flap, Pterygium

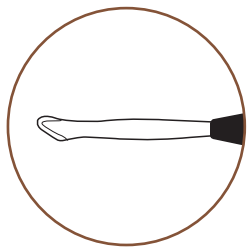

MGL



Actual size

Product Name	ORDER#
Golf/Scleral 2.4mm	MGL24

LRI Knife

6pcs/box

○Main Application: Limbal relaxing incision (LRI)

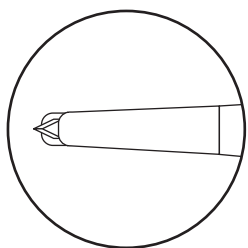

MLR



Actual size

Product Name (Blade Width)	ORDER#
LRI 500µm (0.50mm)	MLR50
LRI 550µm (0.55mm)	MLR55
LRI 600µm (0.60mm)	MLR60
LRI 650µm (0.65mm)	MLR65

Depth Knife

6pcs/box

○Main Application: Scleral groove incision

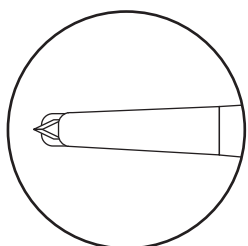

MDP



Actual size

Product Name (Blade Width)	ORDER#
Depth 300µm (0.30mm)	MDP30
Depth 350µm (0.35mm)	MDP35

The crosslapped edge made of MANI®'s original hard fiber stainless steel produces the ultimate sharpness.

Ultimate Sharpness

MANI® Ophthalmic Knife

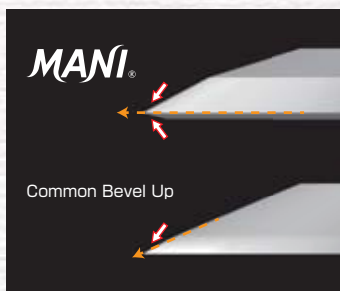

General image of Bevel

Bevel Shape (patented)

MANI® original bevel shape is applied for the knives. By polishing the blade slightly from the back side, the shape provides excellent sharpness, better usability and better stability on trajectory.

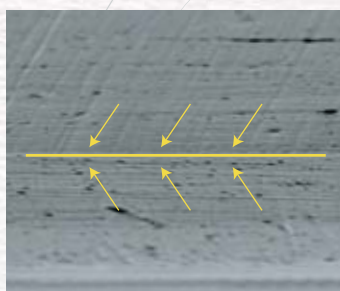

MANI® crosslapped edge

The edge and Bevel generate "Ultimate Sharpness"

Crosslapped Edge

MANI®'s fine-processing technique has created the crosslapped edge, which provides excellent sharpness and consistent quality. (Crosslapped edge: polishing direction is vertical of the edge)

Stainless Steel Superior In Safety



Structure of MANI® hard fiber stainless steel



Structure of common stainless steel

MANI®'s original hard fiber stainless steel (austenite stainless steel) provides reliable strength on the tip and ensure thin but solid edge. (Edge thickness of MANI® slit and crescent knife: 0.14mm)

Color-Coded Handles Allow Easy Identification

The color is different depending on the tip shape.

Non-Glare Treatment (patented)

To maintain the sharpness, Non-Glare treatment was processed on knives except its edge and back side.

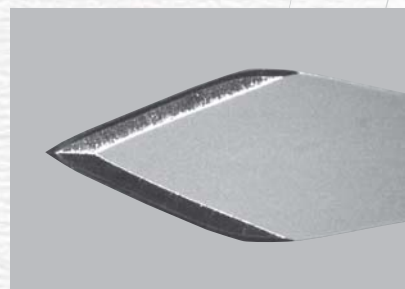

MANI® slit knife - front side (Non-Glare)

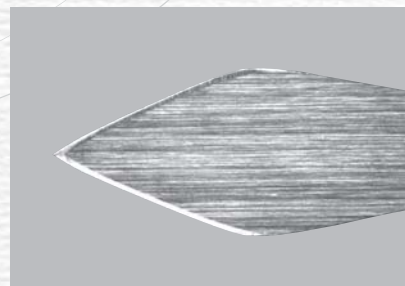

MANI® slit knife - back side (without Non-Glare)

Handling of the case

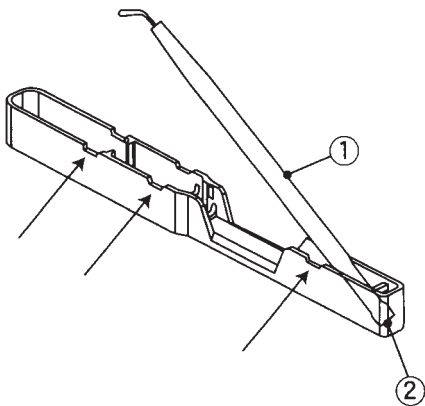

[Taking out the knife]

Pick up point ① to pull out knife from the case.

[CAUTION]

Be careful about unexpected tip collision between the case. Sharpness will be lost.

[Replacing the knife]

Set back point ② to the bottom of the case.
Then place knife down until it clicks.

Handling of the safety knife

[Exposing the blade]

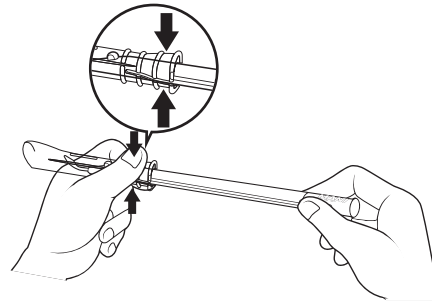

a. Hold the rear end of the cover to unlock.

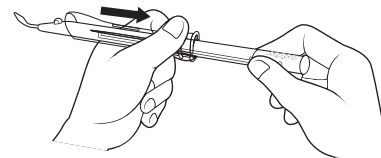

b. Keep holding and slide it towards the rear.

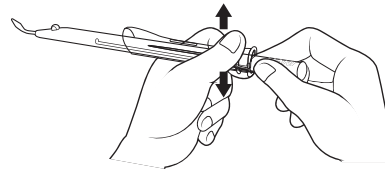

c. Slide the cover until it stops and release hold to lock.

[Stowing the blade]

- Hold the rear end of the cover to release the lock.
- Slide the cover forward till the end.
- Release hold to lock.
(Reverse steps of Exposing to stow the blade)



Distributed by

STERILE **EO** ② Do not reuse
⚠ Read instructions before use.

CE 0197