



Surgical Units

Endoscopic Equipment & Accessories

Our Vision

"True to our vision **INNOVATING TRADITION**, it has always been our goal to not only provide our customers and healthcare professionals with an industry-leading value proposition through continuous innovation in our products and processes.

Ackermann

We believe that it is equally important to not lose sight of our roots and to preserve the craftsmanship that has been perfected over generations as an established family business. This enables us to maintain a productive and sustainable home for our staff and to improve clinical outcomes every single day in over 100 countries around the world."

Peter Grassl, CEO

+ 20k SKUs

As **Full-Range-System Manufacturer** we are able to provide you with a coherent product portfolio - from endoscopy to ligation, from implantology to general surgery.

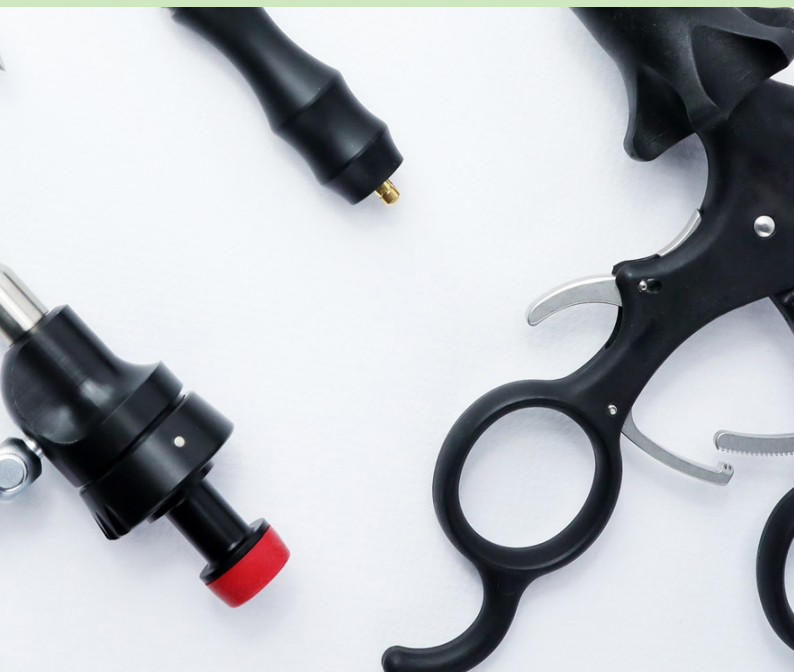

Capabilities

+ Manufacturing

Surgical Instruments, Units, Implants, Optics

+ Regulatory

ISO 13485:2016, US FDA, CFDA, ANVISA,
COFEPRIS

+ Service

+ R&D

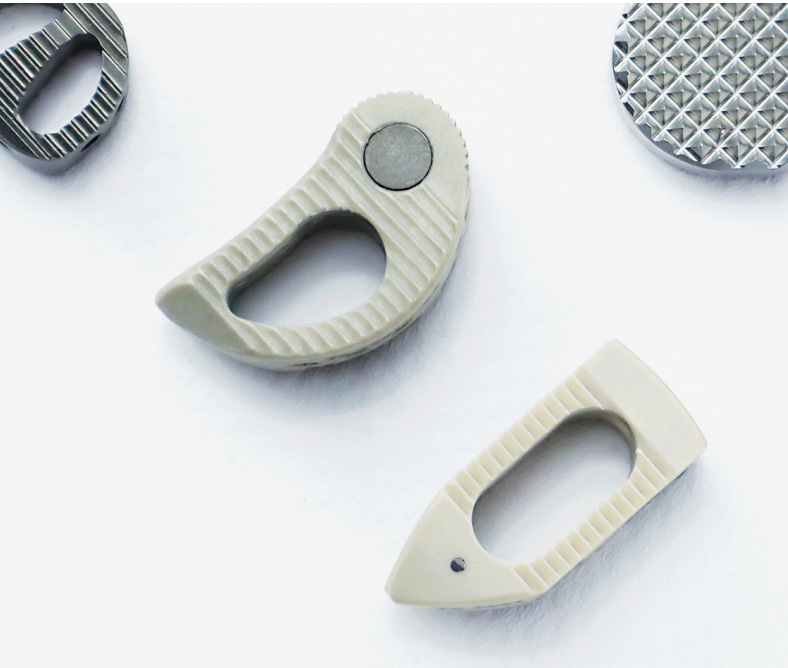

Global Player

Sales subsidiaries located in
Greece, India, USA & Mexico



Serving over
100
Countries

More than
80
Employees



3
Manufacturing
Sites

400
Strategic
Partners



Table of Contents

Product Range at a Glance



Endoscopic Tower Systems

Endoscopic 4k Tower System	p. 6
Endoscopic Fusion™ Tower System	p. 7

Endoscopic Cameras

Apollo™ 4k UHD Camera	p. 8
Fusion+™ 3CMOS FullHD Camera	p. 10
Fusion™ 1CMOS FullHD Camera	p. 12
Duo™ FullHD Camera & LED Lightsource	p. 14
Connect™ 1CMOS Portable Camera	p. 16

Lightsources

Fusion™ LED Lightsource	p. 18
Compact LED Lightsource	p. 20
Connect™ Portable LED Lightsource	p. 21
Accessories for Lightsources	p. 22

Insufflator

Fusion™ CO ₂ Insufflator	p. 24
Accessories for Insufflator	p. 25

Suction-Irrigation Pumps

Double Roller Pump for Laparoscopy	p. 28
Membrane Pump for Laparoscopy	p. 30
Double Roller Pump for Arthroscopy	p. 32
Single Roller Pumps Arthro/ Uro/ Gyn/ Spine	p. 34

High-Frequency Surgical Units

High-Frequency Surgical Units at a Glance	p. 36
HF-Unit, 700-Series	p. 38
HF-Unit, 400-Series	p. 40
HF-Unit, 300-Series	p. 42
HF-Unit, 120-Series	p. 44
Accessories for HF Surgical Units	p. 46

Shaver System

Shaver System	p. 48
Accessories for Shaver System	p. 49
Reusable Shaver Blades	p. 50

Medical Monitors

4k Medical Monitors

Premium 4k 55" Monitor	p. 52
Premium 4k 31" Monitor	p. 52
Eco 4k 55" Monitor	p. 53
Eco 4k 31" Monitor	p. 53

FullHD Medical Monitors

Premium FullHD 27" Monitor	p. 54
Eco FullHD 26" Monitor	p. 55

Equipment Trolleys

Premium Equipment Trolley	p. 56
Eco Equipment Trolley	p. 56
Accessories for Equipment Trolleys	p. 57
HF Equipment Trolley	p. 57



4k Endoscopic Tower System

Ordering Information and Recommendations

- 1x Ackermann Apollo™ Ultra HD 4k Camera # 16-2092
- 1x Ackermann Fusion™ LED Lightsource # 16-2029
- 1x High performance fibre light cable # 11-1161
- 1x Adaptor lightsource-side # 11-1147-100
- 1x Adaptor scope-side # 11-1146-100
- 1x Ackermann Fusion™ Insufflator # 16-2045
- 1x Sterile tubing set with Y-adaptor and filter, single-use (PU = 10 pcs.) # 16-2040-100YD
- 1x High pressure hose for insufflators, DIN-index-plug (DIN 477-1) on bottle side # 16-2040-2001
- 1x Double Roller Pump for Laparoscopy # 16-2080
- 1x Pneumatic double footswitch for 16-2080 # 16-2080-1000
- 1x High frequency surgical unit, 500W (220V) # 16-2000-700
- 1x Neutral electrode for adults # 16-2000-1212FL
- 1x Double footswitch, multiswitch 6-pin, 5m # 16-2002-1217
- 1x Premium 4k Monitor 31" # 16-2034-31B
- 1x Equipment trolley with wheels and drawer # 15-1740
- 1x Holder for 3 L / 5 L / 10 L gas bottles (max. Ø 145 mm / 20 kg) # 15-1741-100
- 1x Flexible flat screen holding arm for trolley # 15-1741-200
- 1x Camera head holder, C-mount # 15-1741-400

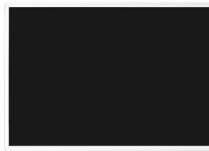

Fusion™ Endoscopic Tower System

Ordering Information and Recommendations

1x Ackermann Fusion™ FullHD 1CMOS NTSC/PAL Camera incl. CCU and USB Recording/Archive	# 16-2090
1x Zoom endoscope coupler, c-mount, for Fusion™ Camera System	# 15-1702ZM
1x Ackermann Fusion™ LED Lightsource	# 16-2029
1x High performance fibre light cable	# 11-1161
1x Adaptor lightsource-side	# 11-1147-100
1x Adaptor scope-side	# 11-1146-100
1x Ackermann Fusion™ Insufflator	# 16-2045
1x Sterile tubing set with Y-adapter and filter, single-use (PU = 10 pcs.)	# 16-2040-100YD
1x High pressure hose for insufflators, DIN-index-plug (DIN 477-1) on bottle side	# 16-2040-2001
1x Double Roller Pump for Laparoscopy	# 16-2080
1x Pneumatic double footswitch for 16-2080	# 16-2080-1000
1x High frequency surgical unit, 500W (220V)	# 16-2000-700
1x Neutral electrode for adults	# 16-2000-1212FL
1x Double footswitch, multiswitch 6-pin, 5m	# 16-2002-1217
1x Eco 4k Monitor 31"	# 16-2034-31NT
1x Equipment trolley with wheels and drawer	# 15-1740
1x Holder for 3 L / 5 L / 10 L gas bottles (max. Ø 145 mm / 20 kg)	# 15-1741-100
1x Flexible flat screen holding arm for trolley	# 15-1741-200
1x Camera head holder, C-mount	# 15-1741-400

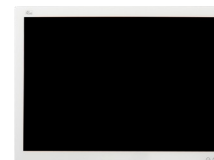

Apollo™ 4k UHD

Endoscopic Camera System

- **4k UHD camera technology**
- **Image enhancement of color and structure**
- **Zoom, freeze & smoke correction**
- **10 User presets for surgical application**

- Ackermann Apollo™ is a true 3840 x 2160p 4k UHD Camera solution incl. CCU, USB recording, archive and zoom coupler
- Up to 10 user profiles
- Preset speciality programs: LAP, ARTHRO, URO, ENT, GYN, FLEX
- 4 buttons on the camera head
- Various different outputs
- Multi-lingual menu
- Peripheral triggerings for keybords and external devices
- True FullHD recording with external USB storage device
- Recommended to use with screens supplied by Ackermann and Ackermann 4k UHD scopes



Technical Specifications

Item # 16-2092 / Apollo™ 4k UHD Camera, incl. CCU and USB Recording / Archive and Zoom Coupler

Camera Control Unit	
White balance	Automated white balance
Options	Image and video capture
Data management	True FullHD recording with external USB storage device
User profiles	Up to 10
Device protection	2 x T3.15 A
Delivered with	CCU, camera head, mains cable, HDMI cable, instructions for use
Video outputs	1 x HDMI 4k (3840 x 2160); 1 x HDMI Full HD (1920 x 1080); 1 x SDI 4k (4 x BNC)(3840 x 2160); 1 x SDI Full HD (1 x BNC)(1920 x 1080)
Video formats	HDMI output: 3840x2160/59.94p, 3840x2160/50p, 1920x1080/59.94p, 1920x1080/59.94i, 1920x1080/50p, 1920x1080/50i SDI output: 3840x2160/59.94p, 3840x2160/50p, 1080/59.94p, 1080/59.94i, 1080/50p, 1080/50i
Dimensions	360 x 124 x 335 mm
Weight	6.2 kg
Electric power supply	100 - 240 VAC @ 50 Hz-60 Hz
Power consumption	50 VA

Camera Head	
Sensor	3 x 1/3"
Resolution	UHD 3840 x 2160
Definition	1600 lines
Acquisition	16:9 format
Buttons	4 push buttons
Sensor dimensions	43(D)x85.7 mm(L) without grommet
Sensor weight	200 g
Cable length	3.05 m
Noise	154 dB

Fusion+ 3CMOS FullHD

Endoscopic Camera System

- **Native FullHD 1080p resolution and 3CMOS sensor**
- **Integrated USB recording and Zoom Coupler**
- **Touchless instantaneous personalization by NFC cards**
- **Compatible with FullHD and 4k scopes & monitors**



- Ackermann Fusion+ is a native 1080p FullHD 3CMOS Camera solution incl. CCU, USB recording, archive and integrated HD 15-35 mm zoom coupler
- Device calibration in less than 1 sec. with Fusion™ NFC Cards, PAL/NTSC encoding in one device
- Realtime optimization
- Preset speciality programs: LAP, ARTHRO, URO, ENT, GYN, FLEX
- 3 fully programmable buttons
- 360° monofilament camera cable connector
- Various different outputs
- Peripheral triggerings for keyboards and external devices
- 14 Languages - more on request
- Integrated communication with Ackermann Fusion™ LED lightsource and insufflator
- Recommended to use with screens supplied by Ackermann and Ackermann FullHD scopes

Technical Specifications

Item # 16-2091 / Fusion™ 3CMOS FullHD NTSC/PAL Camera

Camera Control Unit	
Touchscreen	7" LCD touchscreen with 16:9 format
RF transmitter	RFID; Frequency 13.56 MHz; OOK; Power 70 mW (+18dBm)
Communication	Integrated communication module; Contactless technology; Fusion Cards
Data management	Native FullHD recording with external USB storage device
User profiles	Unlimited, with up to 5 personal presets
Digital zoom	Up to 2.5 x
Functions	Automatic white balance; Compensation of defective pixels; Freeze, mirror, gain functions; Brightness, details, red and blue gains, gamma, color adjustments; Noise reduction (on/low/high) adjustments; Electronic anti-moiré filter for flexible endoscopes
Fuses	2 T2,5AL - 250 V fuses (Marked UL/CSA only)
Instructions for use	Always available on screen
Video outputs	CVBS: 1.0 V [P-P] / 75 ohms, Negative Sync; Y/C: Y: 1.0 V [P-P] / 75 ohms, C: 0.286 V [P-P] (NTSC), C: 0.3 V [P-P] V [P-P] (PAL) / 75 ohms, Negative Sync; RGB: 3 x 0.7 V [P-P] & 0.3 V [P-P] / 75 ohms; HD-SDI: 0.8 V [P-P] / 75 ohms SMPTE292M; DVI-D: 3 x 0.7 Vcc & 0.3 Vcc / 75 ohms
Dimensions	310 x 136 x 385 mm
Weight	4.3 kg
Electric power supply	100 - 230 VAC @ 50 Hz-60 Hz
Power consumption	38 - 50 VA

Camera Head	
Sensor and coupler	3CMOS technology 1/3" FullHD with integrated 15 - 35 mm HD zoom coupler
Resolution and definition	HDTV 1080p format: 1920 x 1080 pixels with 1080 lines
Buttons	3 fully programmable buttons
Electronic shutter	Automatic or adjustable (1/50 to 1/100000)
Sensor weight	270 g
Sensitivity	5 lux
Dimensions	149 x 53 mm
Cable length	3 m
Noise	54 dB

Fusion™ 1 CMOS FullHD

Endoscopic Camera System

- FullHD **Exmor™** CMOS Sensor camera technology
- Integrated USB recording
- Compatible with 4k monitors
- Touchless instantaneous personalization by NFC cards



- True FullHD – No upscaling
- 360° monofilament camera cable connector
- Various different outputs incl. 2xHD-SDI, which, can be converted to 3D-SDI outputs
- Peripheral triggerings for keyboards and external devices
- Device calibration in less than 1 sec. with Fusion™ NFC Cards, PAL/NTSC encoding in one device
- Realtime optimization
- 16 Languages – more on request
- Preset speciality programs: LAP, ARTHRO, URO, ENT, CYSTO, FLEX
- Unlimited user profiles
- Integrated communication with Ackermann Fusion™ LED lightsource and insufflator
- Recommended to use with screens supplied by Ackermann and Ackermann FullHD scopes
- Demountable camera head for use with HD zoom coupler
- Control via 3 programmable buttons easy to reach and providing a minimum of 8 functions

Recommended Accessories

Zoom endoscope coupler, C-mount, focal length 16-34 mm, for Ackermann Fusion™

Item no.

15-1702ZM



Technical Specifications

Item # 16-2090 / Fusion™ 1CMOS FullHD NTSC/PAL Camera

Camera Control Unit	
Touchscreen	7" LCD touchscreen with 16:10 format
RF transmitter	RFID; Frequency 13.56 MHz; OOK; Power 70 mW(+18dBm)
Communication	Integrated communication module; Contactless technology; Fusion Cards
Data management	True FullHD recording with external USB storage device
User profiles	Unlimited
Sensors	Integrated light sensor
Instructions for use	Always available on screen
Video outputs	CVBS: 1.0 V [P-P] / 75 ohms, Negative Sync; Y/C: Y: 1.0 V [P-P] / 75 ohms, C: 0.286 V [P-P] (NTSC), C: 0.3 V [P-P] V [P-P] (PAL) / 75 ohms, Negative Sync; RGB: 3 x 0.7 V [P-P] & 0.3 V [P-P] / 75 ohms; HD-SDI, 3G-SDI: 0.8 V [P-P] / 75 ohms SMPTE292M, SMPTE425M-A; DVI-D
Dimensions	310 x 136 x 385 mm
Weight	4.2 kg
Electric power supply	100 - 240 VAC @ 50 Hz - 60 Hz
Power consumption	50 VA

Camera Head	
Sensor	1CMOS technology 1/3" FullHD
Resolution	True FullHD 1920 x 1080 pixels; 4k ready with compatible screens
Definition	1080 lines
Optical interface and focal length	Depends on coupler
Acquisition	16:9 format
Scan mode	Progressive scan technology
Sensitivity	0.1 lux
Sensor dimensions	149(D) x 53 mm (H)
Sensor weight	260 g
Cable length	3 m
Noise	57 dB
Sterilization	Steris and Sterrad 100NX

Duo™ FullHD & LED

Endoscopic Camera & Lightsource

- **FullHD 1CMOS camera technology**
- **LED lightsource 180W Xenon equivalent**
- **3 programmable buttons on camera head**
- **Integrated USB recording**
- **2 in 1 compact solution**

- Ideal for small cavity: URO, ENT, HYSTERO, ARTHRO
- 1920 x 1080p high-quality image
- 50.000 hours LED life-time
- Integrated USB record
- Intuitive navigation
- Portable solution
- Pre-, intra- and post-operative use
- Controllable via 3 programmable buttons easy to reach and providing a minimum of 8 functions



Recommended Accessories

HD Coupler, C-mount, focal length 24 mm, for Ackermann Duo™

Item no.

15-1702CLD



Technical Specifications

Item # 16-2009 / Duo™ 1CMOS FullHD Camera & LED Lightsource

Camera Control Unit + LED

Automatic white balance	Save function to memorize the settings
Video Outputs: 1 HDMI; 1 HD-SDI/3G-SDI; 1 USB 3.0 micro B	Reset function to restore to the factory settings
Recommended USB stick format: FAT32	Digital zoom up to 2.5x
Electronic iris shutter	FullHD Images recorder integrated(USB)/ Format .tiff
Compatible with Ackermann, Storz ¹ and Olympus ¹ light cables	Touchscreen with intuitive interface
LED lightsource technology equivalent to 180 W Xenon	17 languages
Manual adjustment of the light intensity	Dimensions: 260 x 100 x 215 mm
Anti-blinding feature with light cable detection	Weight: 1.9 kg
Automatic thermal protection system	Protection type: IPX0(not drip-proof)
LED life time up to 50.000 hours	Power supply: 100 - 240 VAC / 50 - 60 Hz
Colour temperature: 5.000 K	Power consumption: 85 - 95 VA
Brightness, details, red and blue gains, color adjustments	2 x T 1.6 A - 250 V fuses(Marked UL/CSA only)
Gain Off / Low / High	Continuous service
On-screen displayed adjustments	

Camera Head

1x CMOS Exmor R™ technology 1/2" FullHD sensor
3 programmable buttons
Resolution: 1920 x 1080 pixels
Definition: 1080 lines
Cable length: 2.99 m
Dimensions: 130 x 47 mm
Weight (camera head only): 152 g
Protection type: (waterproof)

Coupler

24 mm HD coupler
C-mount, scope holder with locking mechanism
Weight: 87 g
Protection type: (waterproof)

Connect™ 1CMOS FullHD

Portable Camera System

- For image display on regular Laptops and Desktop PCs
- Ideal for use with 16-2099 portable LED lightsource



- 1/2" 1CMOS sensor with 1920 x 1080p resolution
- USB 3.0 output: Extremely fast, no image latency and optimal image quality
- Electronic shutter
- 3 buttons to control white balance, photo and video capture, digital zoom and anti-moire filter function for fiberscopes
- Adaptable with any C-mount coupler to get the perfect image size as needed
- Automatic detection of colour temperature
- ABS-PC waterproof camera head with immersible USB connector
- Fully compatible to all rigid and flexible scopes
- Automatic white balance
- Compact and user friendly
- Video enhancement

Technical Specifications

Item # 16-2098 / Connect™ 1/2" 1CMOS FullHD Portable Camera

Resolution	1920 x 1080 pixels
Definition	470 lines
Sensitivity	0,1 lux
Noise ratio	52 dB
Latence	< 150 ms
Electronic shutter	1/25 à 1/30.000 sec.
Exposure	Automatic
White balance	Automatic
Video enhancement	Yes
Sensor size	L = 87 mm
Weight	200 g
Cable length	2.95 m
Power consumption	2.5 VA



16-2092

▲
MENU
+
▼

WB
BOOST
USER

STANDBY
⏻

Ackermann
4K
SST 160µm

16-2092

Fusion™ LED

Lightsource

- **LED lightsource 300 W Xenon equivalent**
- **Automatic light cable detection**
- **Automatic light adjustment**



- Proven LED technology with 50.000h at 10 years life for an average use of 300h per month
- Supplied with Ackermann, Storz¹ and Olympus¹ adaptors
- Recommended to use with Ackermann fibre optic light cables
- 7" LCD touchscreen with 16:10 format
- Direct light control via camera head
- Perfectly suited for large cavity procedures, e.g. LAP

Technical Specifications

Item # 16-2029 / Ackermann Fusion™ LED Lightsource, 300 W Xenon equivalent

Touchscreen	7" LCD touchscreen with 16:9 format
Light technology	LED equivalent to 300 W Xenon or more
Colour temperature	> 6500° K
LED life duration	40.000 hours
Adapters unit side (supplied)	Ackermann; Storz ¹ ; Olympus ¹
Iris	Electronic
Light adjustment	Manual; Automatic
Integrated	Anti-blinding system; Detector of light cable; Automatic thermal protection system
Dimensions	310 x 136 x 385 mm
Weight	5 kg
Electric power supply	100 - 230 VAC @ 50 Hz - 60 Hz
Power consumption	160 VA
Instructions for use	Always available on screen



Ackermann®

LED LIGHTSOURCE

FUSION

smart unit
fusion

16-2029

Ackermann®

CAMERA

FUSION



smart unit
fusion

16-2090

Ackermann®
Finest Surgical Technology

Ackermann®

Ackermann®

Compact LED

Lightsource

- **LED lightsource 180 W Xenon equivalent**
- **Automatic light cable detection**
- **OLED display**

- Standby function
- Light intensity memory
- Anti-blooming system
- Automatic overheating protection
- Intuitive adjustment of light intensity
- LED lifetime of up to 50.000 hours
- Power level memory
- Color temperature 6.500°K



Technical Specifications

Item # **16-2028** / Compact LED Lightsource, 180 W Xenon equivalent

Lamp type	LED
Performance	LED equivalent to 180 W Xenon
Color temperature	>6500° K
LED life duration	50.000 hours
Main voltage	100 - 230 VAC
Power consumption	140 VA
Frequency	50 - 60 Hz
Dimensions	300 x 300 x 66 mm
Weight	3 kg
Fuses	T 800 mA - 250V

Connect™ Portable LED

Lightsource



- **User-friendly plug and play technology**
- **Compact and powerful**
- **Ideal for use with 16-2098 portable camera**

- LED lifetime up to 50.000 hours
- Quick and easy adjustment of light intensity with only one single button
- Illuminating power comparable to a 100 W Xenon lightsource
- Reduced heat emission
- Light cable detection
- Anti-blooming system
- Automatic overheating protection
- Compatible with all Ackermann light cables
- Standby function

Technical Specifications

Item # 16-2099 / Connect™ Portable LED Lightsource

Lamp type	LED
Performance	Equivalent to 100 W Xenon
Light intensity	Automatic
Color temperature	> 4500° K
Lamp life duration	50.000 hours
Main voltage	100 - 240 VAC
Power consumption	30 VA
Frequency	50 - 60 Hz
Dimensions	180 x 95 x 35 mm
Weight	320 g
Transformer	12 V DC

High-Performance Fiber Light Cables

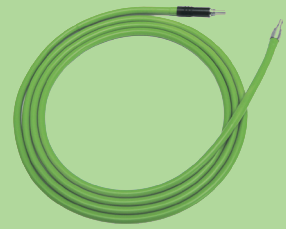

	Length			Item no.
	1.8 m	2.4 m	3 m	
High-performance fiber light cable, Ø 4.8 mm	•			11-1168
High-performance fiber light cable, Ø 4.8 mm		•		11-1167
High-performance fiber light cable, Ø 4.8 mm			•	11-1161

Standard Fiber Light Cables





	Length			Item no.
	1.8 m	2.3 m	3 m	
Standard fiber light cable, Ø 3.5 mm	•			11-1150
Standard fiber light cable, Ø 3.5 mm		•		11-1151
Standard fiber light cable, Ø 3.5 mm			•	11-1152

Light Cable Testers







	Type			Item no.
	Ackermann / Storz ¹	Wolf ¹	Olympus ¹	
Light cable tester	•			11-16000CB
Light cable tester		•		11-16000CBWOL
Light cable tester			•	11-16000CBOLYWA

Scope-side Adapters

	Type			Item no.
	Ackermann / Storz ¹	Wolf ¹	ACMI ¹ / Circon ¹ /Stryker ¹	
Scope-side adapter				11-1146-100
Scope-side adapter	•	•		11-1146-200
Scope-side adapter			•	11-1146-300

Lightsource-side Adapters

	Type				Item no.
	Ackermann / Storz ¹	Wolf ¹	ACMI ¹ / Circon ¹ /Stryker ¹	Olympus ¹	
Lightsource-side adapter					11-1147-100
Lightsource-side adapter	•	•			11-1147-200
Lightsource-side adapter			•		11-1147-300
Lightsource-side adapter				•	11-1147-400

Fusion™ CO₂

Insufflator

- **Insufflation featuring automatic flow management**
- **Remaining insufflation time displayed in minutes**
- **Insufflation range of 2 L/min - 45 L/min**



- Controllable with Ackermann Fusion™ camera head
- Internatl heating system
- Automatic detection of change-over to high and low flow rate
- Equipped with external desufflation valve to manage overpressure and cross-contamination
- Recommended to use with Ackermann high pressure hose and compatible only with Ackermann insufflation tubings (reusable and single use)
- Ideal for low pressure (8-9 mmHg) as well as bariatric procedures

Technical Specifications

Item # **16-2045** / Ackermann Fusion CO₂ Insufflator, 45 L

Touchscreen	7" LCD touchscreen with 16:10 format
Displays	Immediate flow rate; Pressure in cavity; Total volume of CO ₂ used; Low cylinder levels; Insufflation time in minutes
CO ₂ gas supply system	US 7/16" connector
Pressure range	CO ₂ cylinder 10 to 60 bars; Central gas wall plug 3 to 5 bars
Maximum flow rate	45L/min in high-flow mode; 2L /min in low flow mode
Pressure setting and accuracy	0 to 25 mmHg; 1 mmHg
Gas evacuation	External valve
Automatic functions	Pressure management; High flow mode to compensate deflation; Detection of CO ₂ cylinders and wall plugs
Additional parameters	Integrated bariatric insufflation parameters
Dimensions	310 x 136 x 385 mm
Weight	8 kg
Electric power supply	100 - 230 VAC @ 50 Hz - 60 Hz
Power consumption	75 VA
Instructions for use	Always available on screen

Accessories included with Unit

	Item no.
External filter for CO ₂ bottles & wrench	16-2045-300
Power cord	16-2045-400
Instructions for use	n/a

Patient Tubing Sets

	Item no.
Sterile tubing set with Y-adapter and filter, single-use (PU = 10 pcs.) Recommended	16-2040-100YD
Reusable tubing set with Y-adapter, autoclavable, without filter	16-2040-100Y
Sterile filter for autoclavable tubing set, single-use (PU = 10 pcs.)	16-2040-200



High Pressure Hoses with Bottle Connectors

	Item no.
High pressure hose for insufflators, US-plug (UNF 7/16) on bottle side	16-2040-2000
High pressure hose for insufflators, DIN-index-plug (DIN 477-1) on bottle side Recommended	16-2040-2001
High pressure hose for insufflators, PIN-index-plug on bottle side	16-2040-2002



Low Pressure Hoses with Wall Connectors

	Item no.
Hose for low pressure central CO ₂ supply, DIN wall plug	16-2040-2005
Hose for low pressure central CO ₂ supply, AFNOR wall plug	16-2040-2006
Hose for low pressure central CO ₂ supply, NIST wall plug	16-2040-2007

CO₂ Bottle

	Item no.
CO ₂ bottle for insufflators, 0.75 kg-201	15-1711-700



Double Roller Pump

Laparoscopy

- **Double roller pump efficiently and precisely controls suction and irrigation**
- **Designed for the application in the abdomen**

- Visual control and monitoring of flow rates of up to 3L/min
- Color coded tubing sets and accessories
- Optional foot switch available



Technical Specifications

Item # 16-2080 / Double Roller Pump for Laparoscopy

Irrigation capacity	0 - 3.000 ml/min
Suction capacity	0 - 3.000 ml/min
Maximal pressure	0 - 1.000 mmHg
Main voltage	100 - 240 VAC
Power consumption	36 VA
Frequency	50 - 60 Hz
Dimensions	300 x 93 x 260 mm
Weight	6.5 kg
Fuses	T3, 15 A

Accessories included with Unit

	Item no.
Patient tubing set, reusable, autoclavable	16-2080-100
Adapter tube, autoclavable	16-2080-203
Pneumatic manual control handpiece, autoclavable	16-2080-200
Suction-/Irrigation cannula, Ø 5 mm	16-2080-201
Suction-/Irrigation cannula, Ø 10 mm	16-2080-202
Double-lumen control tube, autoclavable	16-2080-204
Power Cord	16-2080-300
Spare Fuses (2 pcs.)	16-2080-400
Instructions for use	n/a

Optional Accessories

	Item no.
Pneumatic double footswitch for 16-2080	16-2080-1000

Membrane Pump

Laparoscopy

- **Membrane suction-irrigation pump designed for the use in large body cavities**
- **Pre-configurable set points for maximum pressure values**
- Visual control and monitoring of flow rates of up to 3L/min
- Color coded tubing sets and accessories
- Optional foot switch available

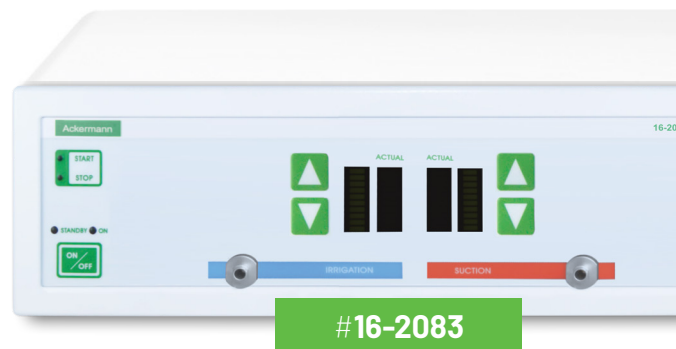

Technical Specifications

Item # **16-2083** / Membrane Pump for Laparoscopy

Irrigation capacity	0 - 3.000 ml/min
Suction capacity	0 - 3.000 ml/min
Maximal pressure	750 mmHg
Maximal vacuum	-525 mmHg
Main voltage	100 - 230 VAC
Power consumption	40 VA
Frequency	50 - 60 Hz
Dimensions	304 x 115 x 345 mm (without bottle holders) 560 x 115 x 345 mm (with bottle holders)
Weight	9 kg
Fuses	T3, 15 A
Optional	Footswitch

Accessories included with Unit

	Item no.
Irrigation tubing set, autoclavable	16-2083-102
Suction tubing set, autoclavable	16-2083-103
Liquid container with overflow valve, autoclavable	16-2083-101
Holding device for 1l-bottle	16-2083-106
Holding device for 2l-bottle	16-2083-107
Injection spike, autoclavable	16-2083-109
2 Hydrophobic sterile filters, disposable	n/a
Power Cord	16-2083-104
Spare Fuses (2x)	16-2083-105
Instructions for use	n/a

Optional Accessories

	Item no.
Hydrophobic sterile filter, disposable, pack of 10 pcs. Recommended	16-2083-108
Footswitch for 16-2083	16-2083-110

Double Roller Pump

Arthroscopy

- **Double roller pump efficiently and precisely controls suction and irrigation**
- **Designed for Arthroscopic procedures**
- **Synchronized suction and irrigation flow to prevent joints from collapsing**
- **Footswitch included to also control a lavage function**

- Visual control and monitoring of flow rates of up to 2.5L/min
- Color coded tubing sets and accessories



Technical Specifications

Item # **16-2082** / Double Roller Pump for Arthroscopy

Irrigation capacity	0 - 2.500 ml/min
Suction capacity	0 - 1.000 ml/min
Pressure range	10 - 200 mmHg
Main voltage	100 - 230 VAC
Power consumption	80 VA
Frequency	50 - 60 Hz
Dimensions	304 x 125 x 365 mm
Weight	11 kg
Fuses	T3, 15 A - 250 V

Accessories included with Unit

	Item no.
Patient tubing set, reusable, autoclavable	16-2082-100
Pneumatic double footswitch for 16-2082	16-2082-500
Power cord	16-2082-600
Spare fuses (2 pcs.)	16-2082-700
Instructions for use	n/a

Optional Accessories

	Item no.
Irrigation tubing set, disposable, single-use (PU = 20 pcs.)	16-2082-200
Patient tubing set, disposable, single-use (PU = 40 pcs.)	16-2082-300
Measuring chamber with pump segment, autoclavable	16-2082-400

Single Roller Pumps

Arthro, Uro, Gyn & Spine

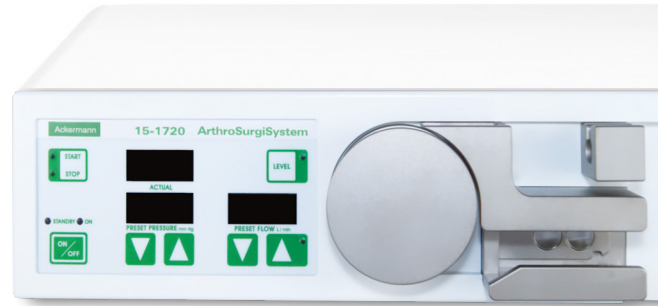

- **Single roller pump for controlled fluid management**
- **Universal design pre-configured to match perfectly suited parameters for each specialty**
- **Leakage liquid compensation**
- Touch free pressure measurement
- Visual control and monitoring of flow rates and preset pressures

Technical Specifications

Single Roller Pump for Urology / Spine / Hysteroscopy / Arthroscopy

	Application				Item no.
	Urology	Spine	Hysteroscopy	Arthroscopy	
Single Roller Pump	•				15-1715
Single Roller Pump		•			15-1718
Single Roller Pump			•		15-1719
Single Roller Pump				•	15-1720
Irrigation capacity	0 - 1.000 ml/min (15-1715) 0 - 0.750 ml/min (15-1718) 0 - 0.500 ml/min (15-1719) 0 - 1.500 ml/min (15-1720)				
Pressure range	10 - 150 mmHg (15-1715) 10 - 100 mmHg (15-1718) 10 - 200 mmHg (15-1719) 10 - 150 mmHg (15-1720)				
Main voltage	100 - 230 VAC				
Power consumption	80 VA				
Frequency	50 - 60 Hz				
Dimensions	304 x 115 x 345 mm				
Weight	7 kg				
Fuses	T3, 15 A - 250 V				

Accessories included with Unit

	Item no.
Irrigation tubing set, reusable, autoclavable	15-1720-100N
Power cord	15-1720-800
Spare fuses (2 pcs.)	15-1720-900
Instructions for use	n/a

Optional Accessories

	Item no.
Irrigation tubing set, disposable, single-use (PU = 20 pcs.)	15-1720-300DN
Patient tubing set, disposable, single-use (PU = 40 pcs.)	15-1720-301DN
Measuring chamber with pump segment, autoclavable	15-1720-500N

High-Frequency Surgical Units

Models at a Glance



HF-Unit, 700-Series

High-End Solution with Touchscreen(ARG/VS/DIA)



HF-Unit, 400-Series

High-End Solution (VS/DIA)



HF-Unit, 300-Series

Standard Solution (DIA)







HF-Unit, 120-Series

Economy Solution (DIA)

Comparison Chart

For Technical Parameters of HF-Units

	 16-2000-120-220V	 16-2000-300	 16-2000-400	 16-2000-700
Monopolar cut	•	•	•	•
Monopolar coagulation	•	•	•	•
Bipolar coagulation	•	•	•	•
Bipolar autostart/autostop		•	•	•
Bipolar cut in liquids			•	•
Argon coagulation and cutting				•
VesSeal technology				•
Endoscopic program			•	•
Endo-detect system				•
Autotest	•	•	•	•
Neutral electrode monitoring	•	•	•	•
Real-time monitoring of all parameters	•		•	•
Multiswitch			•	•
LCD touchscreen				•
LED display	•	•	•	
Programmable			•	•
Monopolar output	•	•	••	
Bipolar output	•	•	•	••



HF-Unit, 700-Series

High-End with Touchscreen (ARG/VS/DIA)



- **Automatic power adjustment**
 - **Real-time monitoring of output parameters**
 - **10" high-resolution color touch screen**
 - **Up to 100 user presets**
- Integrated brightness adjustment of the screen
 - Different languages incorporated
 - Power monitor
 - Overload protection
 - Specialist modes for specific applications in urology, arthroscopy and laparoscopy
 - Communication with the user in different languages, voice Communication commands inform about the diathermy operating status
 - Once switched on, the unit performs a comprehensive internal autotest, with detailed results displayed
 - The neutral electrode monitoring controls the quality of the application
 - Monopolar cutting: pure, with haemostasis, cutting with desiccation, and for procedures in liquid environment (urology, arthroscopy)
 - Monopolar coagulation: soft, forced, spray, hybrid, standard argon, endoscopic and pulse argon
 - Bipolar cutting: standard and for procedures in liquids environment (urology, arthroscopy)
 - Bipolar coagulation: soft, forced and for procedures in liquid environment (urology, arthroscopy) endoscopic cutting and coagulation modes
 - Argon coagulation and cutting

Recommended Accessories

	Item no.	
Double footswitch, multiswitch, 6-pin, 5 m	16-2002-1217	
Equipment trolley for HF-unit	16-2000-1500	

Technical Specifications

Item # 16-2000-700 / High-End High-Frequency Surgical Unit with Touchscreen, ARG/ VS/ DIA, 400 W(220 V)

Monopolar cutting		Monopolar coagulation	
Pure monopolar cutting	400 W for 200 Ω	Soft monopolar coagulation	180 W for 50 Ω
Blend monopolar cutting I	180 W for 200 Ω	Forced monopolar coagulation	180 W for 300 Ω
Blend monopolar cutting II	150 W for 200 Ω	Spray monopolar coagulation	80 W for 1250 Ω
Blend monopolar cutting III	150 W for 200 Ω	Hybrid monopolar coagulation	180 W for 200 Ω
Urological monopolar cutting	400 W for 200 Ω	Argon monopolar coagulation	80 W for 1250 Ω
Endoscopic monopolar cutting	400 W for 200 Ω	Argon pulse coagulation	80 W for 1250 Ω
Argon monopolar cutting	350 W for 200 Ω		
Bipolar cutting		Bipolar coagulation	
Bipolar cutting(4 levels)	150 W for 200 Ω	Bipolar coagulation	120 W for 50 Ω
Urological bipolar cutting	400 W for 50 Ω	AutoStart / Autostop	Automatic start / stop of bi. coa.
Argon		VesSeal	
Gas type	Pure argon ≥ 4.8 /99.998%	Urological	300 W for 50 Ω
Inlet gas pressure	0.3-0.5 MPa	Autostop	Automatic stop of sealing process, when achieving the optimal effect
Gas outflow	0.1-9.9 l/min, reg. 0.1 l/min		
Pressure gauge	Reducer on argon cylinder		
Safety features			
Protection against electric shock	I CF		
Low-frequency leakage currents	According to EN 60601-1		
High-frequency leakage currents	According to EN 60601-2-2		
Generator operation frequency	333 kHz		
Defibrillation impulse resistance	According to 60601-1		
NEM System	Neutral electrode control		
Autotest	Self-test of generator and accessories after switching the power on, service codes display		
Overload	Generator overload protection		
Weight and dimensions		Power supply	
Dimensions	495 x 415 x 225 mm	Supply voltage	220-240 V +/- 10% 50/60 Hz
Weight	12.2 kg	Rated power input	1080 VA

HF-Unit, 400-Series

High-End Solution (VS/DIA)

- **Bipolar resection**
- **Endoscopic program**
- **Automatic power adjustment**
- **Neutral electrode monitoring**
- **Overload protection**



- Offers a variety of operating modes for open procedures, as well as endoscopy and laparoscopy
- It enables monopolar (footswitch or handle) and bipolar operation
- Additional functions for specialized procedures in urology, arthroscopy and laparoscopy
- The neutral electrode monitoring controls the quality of the application
- Constant control via real-time monitoring of all parameters
- 5 volume levels
- Up to 9 personal presets
- Easy to clean flat front panel with push buttons
- Multifunction footswitch allows remote changing of the settings with a single press of a footswitch
- 2 monopolar, 1 bipolar output
- Special endoscopic cutting modes necessary to remove polyps and the procedure of papillotomy
- Monopolar cutting: pure, blend cutting (3 levels), urological cutting, endoscopic cutting
- Monopolar coagulation: soft, forced, spray, hybrid
- Bipolar cutting: cutting with 4 different levels of haemostasis, urological cutting
- Bipolar coagulation with AutoStart / AutoStop mode

Recommended Accessories

	Item no.	
Double footswitch, 6-pin, 5 m	16-2000-1217	
Equipment trolley for HF-unit	16-2000-1500	

Technical Specifications

Item # 16-2000-400 / High-End High-Frequency Surgical Unit, 400W(220V)

Monopolar cutting		Monopolar coagulation	
Pure monopolar cutting	400 W for 200 Ω	Soft monopolar coagulation	180 W for 50 Ω
Blend monopolar cutting I	180 W for 200 Ω	Forced monopolar coagulation	180 W for 200 Ω
Blend monopolar cutting II	150 W for 200 Ω	Spray monopolar coagulation	80 W for 1250 Ω
Blend monopolar cutting III	150 W for 200 Ω	Hybrid monopolar coagulation	180 W for 200 Ω
Urological monopolar cutting	400 W for 200 Ω		
Endoscopic monopolar cutting	400 W for 200 Ω		
Bipolar cutting		Bipolar coagulation	
Bipolar cutting (4 levels)	150 W for 200 Ω	Bipolar coagulation	100 W for 50 Ω
Urological bipolar cutting	400 W for 50 Ω	AutoStart / Autostop	Automatic start / stop of bi. coa.
Safety features			
Protection against electric shock	I CF		
Low-frequency leakage currents	According to EN 60601-1		
High-frequency leakage currents	According to EN 60601-2-2		
Generator operation frequency	333 kHz		
Defibrillation impulse resistance	According to 60601-1		
NEM System	Neutral electrode control		
Autotest	Self-test of generator and accessories after switching the power on, service codes display		
Overload	Generator overload protection		
Weight and dimensions		Power supply	
Dimensions	410 (L) x 415 (W) x 180 (H) mm	Supply voltage	220-240 V +/- 10% 50/60 Hz
Weight	9.8 kg	Rated power input	1080 VA

HF-Unit, 300-Series

Standard Solution

- **Monopolar modes**
- **Bipolar mode**
- **Bipolar AutoStart**
- **Bipolar AutoStop**
- **Automatic power adjustment**
- **PowerStart**
- **Neutral electrode monitoring**
- **Overload protection**

- Bipolar coagulation controlled with footswitch or automatically with AutoStart or AutoStop function
- The unit is equipped with a power start system which facilitates the start of a procedure cutting
- The neutral electrode monitoring controls the quality of the application
- Designed for outpatient surgery centers
- Once switched on, the unit performs a comprehensive internal Autotest, with detailed results displayed
- PowerStart system for a simplified beginning of cutting process
- Monopolar cutting: pure, blend
- Monopolar coagulation: soft, forced
- Bipolar coagulation with automatic start and stop bipolar coagulation



Recommended Accessories

	Item no.	
Double footswitch, 6-pin, 5 m	16-2000-1217	
Equipment trolley for HF-unit	16-2000-1500	

Technical Specifications

Item # 16-2000-300 / High-Frequency Surgical Unit, 350 W(220 V)

Monopolar cutting	
Pure monopolar cutting	250 W for 300 Ω
Blend monopolar cutting	250 W for 300 Ω
Monopolar coagulation	
Soft monopolar coagulation	150 W for 50 Ω
Forced monopolar coagulation	150 W for 300 Ω
Bipolar coagulation	
Bipolar coagulation	100 W for 50 Ω
AutoStart / Autostop	Automatic start and stop of bipolar coagulation
Safety features	
Protection against electric shock	I CF
Low-frequency leakage currents	According to EN 60601-1
High-frequency leakage currents	According to EN 60601-2-2
Generator operation frequency	357 kHz
Defibrillation impulse resistance	According to 60601-1
NEM System	Neutral electrode control
Autotest	Self-test of generator and accessories after switching the power on, service codes display
Overload	Generator overload protection
Weight and dimensions	
Dimensions	380 x 340 x 165 mm
Weight	6.8 kg
Power supply	
Supply voltage	220-240 V +/- 10% 50/60 Hz
Rated power input	450 VA

HF-Unit, 120-Series

Economy Solution

- **Modern design**
- **Automatic power adjustment**
- **Excellent performance**
- **Monopolar modes**
- **Bipolar mode**
- **Neutral electrode monitoring**
- **Overload protection**
- **Footswitch recognition**

- Separate control panels for operation in monopolar cut and coagulation, and bipolar coagulation
- The unit is equipped with a power start system which facilitates the start of a procedure cutting
- Once switched on, the unit performs a comprehensive internal Autotest, with detailed results displayed
- Excellent choice for gynecological, dermatological and cosmetological surgeries, as well as for small surgical procedures for outpatient clinics
- Monopolar cutting: pure, blend
- Monopolar coagulation: soft, forced
- Bipolar coagulation



Recommended Accessories

	Item no.	
Double footswitch, 6-pin, 5 m	16-2000-1217	
Equipment trolley for HF-unit	16-2000-1500	

Technical Specifications

Item # **16-2000-120-220V** / Economy High-Frequency Surgical Unit, 120 W(220 V)

Monopolar cutting	
Pure monopolar cutting	120 W for 300 Ω
Blend monopolar cutting	120 W for 300 Ω
Monopolar coagulation	
Soft monopolar coagulation	150 W for 50 Ω
Forced monopolar coagulation	150 W for 300 Ω
Bipolar coagulation	
Bipolar coagulation	120 W for 50 Ω
Safety features	
Protection against electric shock	I CF
Low-frequency leakage currents	According to EN 60601-1
High-frequency leakage currents	According to EN 60601-2-2
Generator operation frequency	333 kHz
Defibrillation impulse resistance	According to 60601-1
NEM System	Neutral electrode control
Autotest	Self-test of generator and accessories after switching the power on, service codes display
Overload	Generator overload protection
Weight and dimensions	
Dimensions	330 x 285 x 105 mm
Weight	3.5 kg
Power supply	
Supply voltage	220-240 V +/- 10% 50/60 Hz
Rated power input	480 VA

Neutral Electrodes & Accessories

	Item no.
Neutral electrode for adults, flat plug, reusable	16-2000-1212FL
Neutral electrode for children, flat plug, reusable	16-2000-1212SMFL
Rubber band for fixation of neutral electrodes, 1.5 m	16-2000-1238



Argon Cylinders & Accessories

	Item no.
Argon cylinder, 5 L, DIN 477/6	16-2001-100
Argon cylinder, 10 L, DIN 477/6	16-2001-101
Argon pressure regulator, DIN 477/6	16-2001-200



Ackermann® HF-GENERATOR
16-2000-700

OUT1

OUT2

OUT3

OUT4

argon

neutral



Arthroscopy

Shaver Unit

- **Fully controllable rotational and oscillation speed**
 - **Three oscillation modes: light, medium and aggressive**
 - **Automatic handpiece detection memorizing previously used parameters**
 - **Overload protection**
 - **Speed range of 800 to 8.000 RPM**
-
- To be used with up to two ergonomic, autoclavable handpieces simultaneously
 - Conveniently controllable by foot switch
 - Handpieces with automatic or manual lock
 - Compatible with Ackermann shaver blades



Technical Specifications

Item # **16-2050** / Arthroscopic Shaver Unit incl. Footswitch and Handpiece

Shaver Unit

Input voltage	100 - 240 VAC
Frequency voltage	50 - 60 Hz
Main voltage	100 - 240 VAC
Dimensions	306 x 96 x 330 mm
Weight	5.1 kg
Class of protection	B type

Handpiece

Length	185 mm
Weight	400 g
Blades chuck	Manual locking
Speed range	800 - 8.000 RPM (± 10%)
Oscillate cycle	Light (0.5 sec.), medium (0.3 sec.), aggressive (0.2 sec.)
Cable length	3 m
Sterilization method	Steam sterilization: 134°C

Footswitch

Dimensions	215 x 280 x 28 mm
Weight	2.45 kg
Cable length	3 m
Casing safety standard	IPX8



Accessories included with Unit

	Item no.
Handpiece for 16-2050	16-2050-100
Footswitch for 16-2050	16-2050-200
Power cord	16-2050-300
Instructions for use	n/a



Full Radius Resector

For Ackermann / Arthrex¹ Shaver Systems



	Diameter			Item no.
	Ø 3.5 mm	Ø 4.5 mm	Ø 5.5 mm	
Full radius resector, plain sheath tip, plain inner tip, reusable			•	15-1722-100ART
Full radius resector, plain sheath tip, plain inner tip, reusable		•		15-1722-101ART
Full radius resector, plain sheath tip, plain inner tip, reusable	•			15-1722-102ART

Meniscus Cutter

For Ackermann / Arthrex¹ Shaver Systems



	Diameter			Item no.
	Ø 3.5 mm	Ø 4.5 mm	Ø 5.5 mm	
Meniscus cutter, serrated sheath tip, plain inner tip, reusable			•	15-1722-200ART
Meniscus cutter, serrated sheath tip, plain inner tip, reusable		•		15-1722-201ART
Meniscus cutter, serrated sheath tip, plain inner tip, reusable	•			15-1722-202ART

Aggressive Full Radius Resector

For Ackermann / Arthrex¹ Shaver Systems



	Diameter			Item no.
	Ø 3.5 mm	Ø 4.5 mm	Ø 5.5 mm	
Aggressive full rad. resect., plain sheath tip, serr. inner tip, reusable			•	15-1722-300ART
Aggressive full rad. resect., plain sheath tip, serr. inner tip, reusable		•		15-1722-301ART
Aggressive full rad. resect., plain sheath tip, serr. inner tip, reusable	•			15-1722-302ART

Incisor

For Ackermann / Arthrex¹ Shaver Systems



	Diameter			Item no.
	Ø 3.5 mm	Ø 4.5 mm	Ø 5.5 mm	
Incisor, serrated sheath tip, serrated inner tip, reusable			•	15-1722-400ART
Incisor, serrated sheath tip, serrated inner tip, reusable		•		15-1722-401ART
Incisor, serrated sheath tip, serrated inner tip, reusable	•			15-1722-402ART

Round Burr

For Ackermann / Arthrex¹ Shaver Systems



	Item no.
Round burr, drill, Ø 5.5 mm, reusable	15-1722-500ART

Tapered Burr

For Ackermann / Arthrex¹ Shaver Systems



	Item no.
Tapered burr, drill, Ø 5.5 mm, reusable	15-1722-600ART

Oval Burr

For Ackermann / Arthrex¹ Shaver Systems



	Item no.
Oval burr, drill, Ø 5.5 mm, reusable	15-1722-700ART

Premium 4k

Medical Monitors

Recommended for Ackermann Apollo™

Featuring:

- Video processing optimized for low latency and noise reduction
- Picture-in-picture and picture-by-picture
- Image mirror and rotation
- Failover mode
- Screen clone on DVI out
- FHD input upscaled to UHD
- Legacy signals accepted
- DC power output

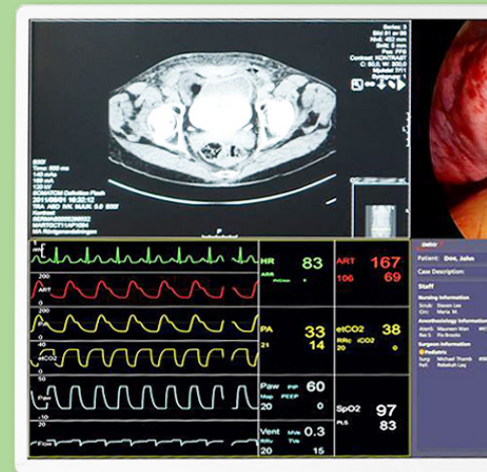

Technical Specifications

	16-2034-31B	16-2034-55B
Panel	31" TFT AM LCD / IPS-PRO technology / LED backlight	55" TFT AM LCD / IPS-PRO technology / LED backlight
Resolution	4096 x 2160 pixels	3840 x 2160 pixels
Aspect ratio	17:9	16:9
Video inputs	4k-UHD input selectable among: 1x DP 1.1, 2x DP 1.1, 1x DP 1.2 MST, 2x HDMI FHD input (upscaled to UHD): 1x DVI, 1x 3G-SDI	4k-UHD input selectable among: 1x DP 1.1, 2x DP 1.1, 1x DP 1.2 MST, 2x HDMI 2.0 FHD input (upscaled to UHD): 1x DVI, 1x 3G-SDI
Video outputs	1x 3G-SDI (input loop through), 1x DVI (screen clone downscaled to FHD)	1x 3G-SDI (input loop through) 1x DVI (screen clone downscaled to FHD)
Dimensions	777 x 472 x 93 mm	1259 x 733 x 87 mm
Weight	12.1 kg	4.2 kg
VESA	100 x 100 mm + 200 mm x 100 mm	200 x 200 mm + 600 mm x 200 mm

Recommended Accessories

	Item no.
Monitorstand for 26" / 31" / 32" monitor	16-2033HD-26FUSS



Eco 4k

Medical Monitors

Recommended for Ackermann Fusion™

Featuring:

- Bonded front filter for higher brightness and contrast ratio
- State-of-the-art surgical visualization, the best possible image
- Ready, out of the box, for advanced digital OR installations
- Flush-front glass surface, fast and easy to clean
- Slim profile and narrow bezel for a streamlined design
- Excellent color and detail reproduction on a large screen
- Wide selection of signal input choices
- Built in multi-window layouts

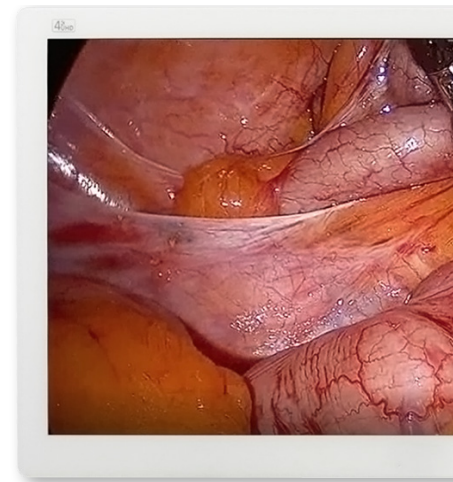

Technical Specifications

	16-2034-31NT	16-2034-55NT
Panel	31" TFT LCD(LED)	55" TFT LCD(LED)
Resolution	4096 x 2160 pixels	3840 x 2160 pixels
Aspect ratio	17:9	16:9
Video inputs	1 x HDMI 2.0, 1 x DP 1.2(SST), 1 x DP 1.2(MST), 1 x DVI (single link)	1 x HDMI 2.0, 2 x DP 1.2(SST), 4(Quad) x DVI (single link), 4(Quad) x SDI (3G)
Video outputs	1 x DP 1.2(SST), 1 x DVI (single link)	1 x DP 1.2(SST)
Dimensions	773.1 x 453.6 x 75.5 mm	1278 x 756 x 82.5 mm
Weight	10.62 kg	36.65 kg
VESA	100 x 100 mm + 200 mm x 100 mm	600 x 400 mm + 600 x 200 mm

Recommended Accessories

	Item no.	
Monitorstand for 26" / 31" / 32" monitor	16-2033HD-26FUSS	

Premium FullHD

Medical Monitor

Recommended for Ackermann Duo™

Featuring:

- 27" FHD IPS display (1920x1080)
- sRGB 115%(deep red)
- Brightness stabilization
- Dust- and waterproof
- Protection glass
- Flicker safe



Technical Specifications

Item # 16-2033HD-27LG / Premium FullHD Monitor 27", without Monitorstand

Panel	27" FHD IPS Display
Resolution	1920 x 1080 pixels
Aspect ratio	16:9
Video inputs	HDMI(1.4) x 1, S-Video x 1, 3G-SDI x 1, DVI-I x 1 (compatible with D-sub & component via adapter)
Video outputs	3G-SDI x 1, DVI-I x 1
Dimensions	658.8 x 426 x 60 mm
Weight	7.7 kg
VESA	VESA 100 x 100 mm + 200 mm x 100 mm

Recommended Accessories

	Item no.
Monitorstand for 26" / 31" / 32" monitor	16-2033HD-26FUSS



Eco FullHD

Medical Monitor

Featuring:

- Rapid signal detection, robust mode tables
- Flush-front glass for better cleaning and sterilization practices
- Accepts popular signal types including:
DVI-D, SDI (SD/HD/3GSDI), VGA, C-Video, S-Video, and Component
- Intuitive and full-featured menu settings
- Image pan, zoom, freeze, picture-in-picture



Technical Specifications

Item # **16-2033HD-26NT** / Eco FullHD Monitor 26", without Monitorstand

Panel	26" TFT LCD(LED)
Resolution	1920 x 1080 pixels
Aspect ratio	16:9
Video inputs	1x DVI-D 1, 1x DVI-D 2 (fiber optional), 1x VGA (D-sub), 1x SD/HD/3G-SDI (BNC), 1x C-Video (BNC), 1x S-Video (Y/C)(2 x BNC), 1x Component (RGBS, YPbPr)(5 x BNC)
Video outputs	1x DVI-D, 1x SD/HD/3G-SDI (BNC)
Dimensions	640 x 402 x 78 mm
Weight	8.44 kg
VESA	VESA 100 x 100 mm + 200 mm x 100 mm

Recommended Accessories

	Item no.	
Monitorstand for 26" / 31" / 32" monitor	16-2033HD-26FUSS	

Premium Equipment

Trolley

Featuring:

- Monitor holder on crossbeam (14 - 18 kg)
- Removable rear panel
- Side panels for integrated cable management
- 4 shelves
- Drawer
- 4 twin swivel casters with break



Eco Equipment

Trolley

Featuring:

- Side panels for integrated cable management
- 5 shelves
- Drawer
- 4 twin swivel casters with break



Optional Accessories

	For use with		Item no.
	15-1740	15-1741	
Holder for 3 L / 5 L / 10 L gas bottles (max. Ø 145 mm / 20 kg)	•	•	15-1741-100
Adjustable monitor holding arm (VESA 75 / 100, max. 10 kg)	•	•	15-1741-200
8-plug socket strip with mount and power cord (5 m)	•	•	15-1741-300
Camera head holder, C-mount	•	•	15-1741-400
Adjustable arm with tubing clamps (900 mm swing range, max. 1 kg)	•	•	15-1741-500
Adjustable infusion stand (max. 4 x 2 kg, 870 mm)	•	•	15-1741-600
Storage basket, (max. 3 kg, 305 x 205 x 150 mm)	•	•	15-1741-700
Isolating transformer (1000VA)	•		15-1740-992

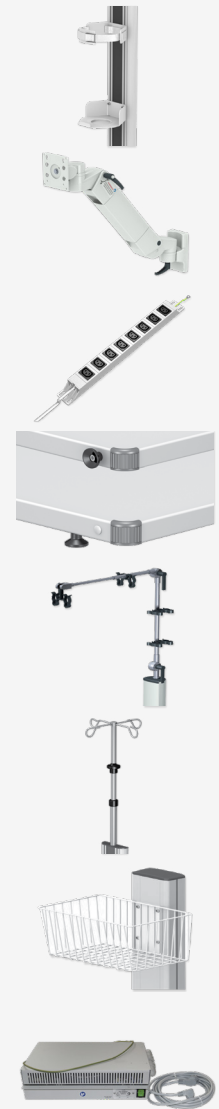

HF Equipment Trolley

	Item no.
Equipment trolley for HF-unit	16-2000-1500



Alphanumeric Index

Item Numbers at a Glance

Numeric Item #		15-1722-301ART	50		53, 54, 55
11-1146-100	6, 7, 23	15-1722-302ART	50	16-2033HD-26NT	53, 55
11-1146-200	23	15-1722-400ART	51	16-2033HD-27LG	54
11-1146-300	23	15-1722-401ART	51	16-2033HD-27NT	52
11-1147-100	6, 7, 23	15-1722-402ART	51	16-2034-31B	6, 52
11-1147-200	23	15-1722-500ART	51	16-2034-31NT	7, 53
11-1147-300	23	15-1722-600ART	51	16-2034-55B	52
11-1147-400	23	15-1722-700ART	51	16-2034-55NT	53
11-1150	22	15-1740	6, 7, 56, 57	16-2040-100Y	25
11-1151	22	15-1740-992	57	16-2040-100YD	6, 7, 25
11-1152	22	15-1741	56, 57	16-2040-200	25
11-1161	6, 7, 22	15-1741-100	6, 7, 57	16-2040-2000	25
11-1167	22	15-1741-200	6, 7, 57	16-2040-2001	6, 7, 25
11-1168	22	15-1741-300	57	16-2040-2002	25
11-16000CB	22	15-1741-400	6, 7, 57	16-2040-2005	26
11-16000CBOLYWA	22	15-1741-500	57	16-2040-2006	26
11-16000CBWOL	22	15-1741-600	57	16-2040-2007	26
15-1702CLD	14	15-1741-700	57	16-2045	6, 7, 24
15-1702ZM	7, 12	16-2000-120	44	16-2045-300	25
15-1711-700	26	16-2000-120-220V	36, 37	16-2045-400	25
15-1715	34	16-2000-300	36, 37, 42	16-2050	48, 49
15-1718	34	16-2000-400	36, 37, 40	16-2050-100	49
15-1719	34	16-2000-700	6, 7, 36, 37, 38	16-2050-200	49
15-1720	34	16-2000-1212FL	6, 7, 46	16-2050-300	49
15-1720-100N	35	16-2000-1212SMFL	46	16-2080	6, 7, 28, 29
15-1720-300DN	35	16-2000-1217	40, 42, 44	16-2080-100	29
15-1720-301DN	35	16-2000-1238	46	16-2080-200	29
15-1720-500N	35	16-2000-1500	38, 40, 42, 44, 57	16-2080-201	29
15-1720-800	35			16-2080-202	29
15-1720-900	35	16-2001-100	46	16-2080-203	29
15-1722-100ART	50	16-2001-101	46	16-2080-204	29
15-1722-101ART	50	16-2001-200	46	16-2080-300	29
15-1722-102ART	50	16-2002-1217	6, 7, 38	16-2080-400	29
15-1722-200ART	50	16-2009	14	16-2080-1000	6, 7, 29
15-1722-201ART	50	16-2028	20	16-2082	32, 33
15-1722-202ART	50	16-2029	6, 7, 18	16-2082-100	33
15-1722-300ART	50	16-2033HD-26FUSS	52,	16-2082-200	33

16-2082-300	33
16-2082-400	33
16-2082-500	33
16-2082-600	33
16-2082-700	33
16-2083	30,31
16-2083-101	31
16-2083-102	31
16-2083-103	31
16-2083-104	31
16-2083-105	31
16-2083-106	31
16-2083-107	31
16-2083-108	31
16-2083-109	31
16-2083-110	31
16-2090	7, 12
16-2091	10
16-2092	6, 8
16-2098	16
16-2099	21

¹Any companies mentioned in this catalogue including their brand names and related products are protected under intellectual property laws. The use of them does not imply any affiliation with or endorsement by them.

²Specifications, design and accessories in this catalogue are subject to change without any notice or obligation on the part of the manufacturer.

Copyright by Ackermann Instrumente GmbH. All rights reserved. Specifications, design and accessories in this catalogue are subject to change without any notice or obligation on the part of the manufacturer. No part may be copied or reproduced in any form. Revision 04/22



www.ackermannsurgical.com



Ackermann Instrumente GmbH
Eisenbahnstrasse 65-67
78604 Rietheim-Weilheim, Germany