

7.3 Tomosynthesis Reconstruction

Even after the study of Tomosynthesis is ended, the TOMOS reconstructed image can be created. The reconstruction conditions can be edited from those used in the study.

- 1 Select the desired TOMOS acquired image on the [Image List] window.
When selecting the list item, it is highlighted.
When selecting the thumbnail image, the selection border surrounds the thumbnail.
- 2 Click [TOMOS].

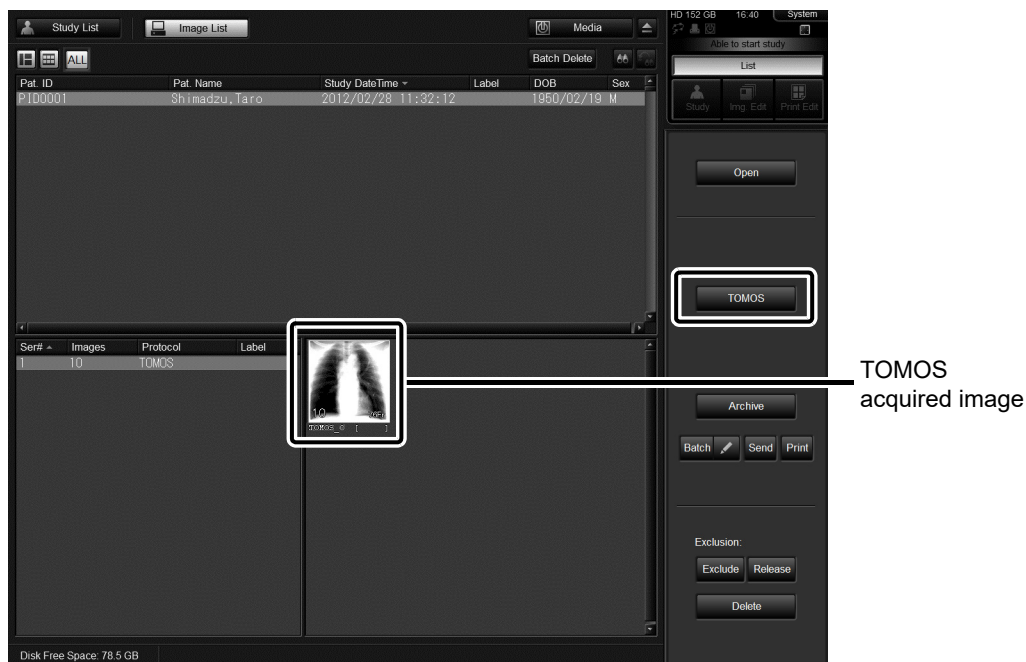



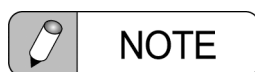

The [TOMO-Reconstruction] window appears.



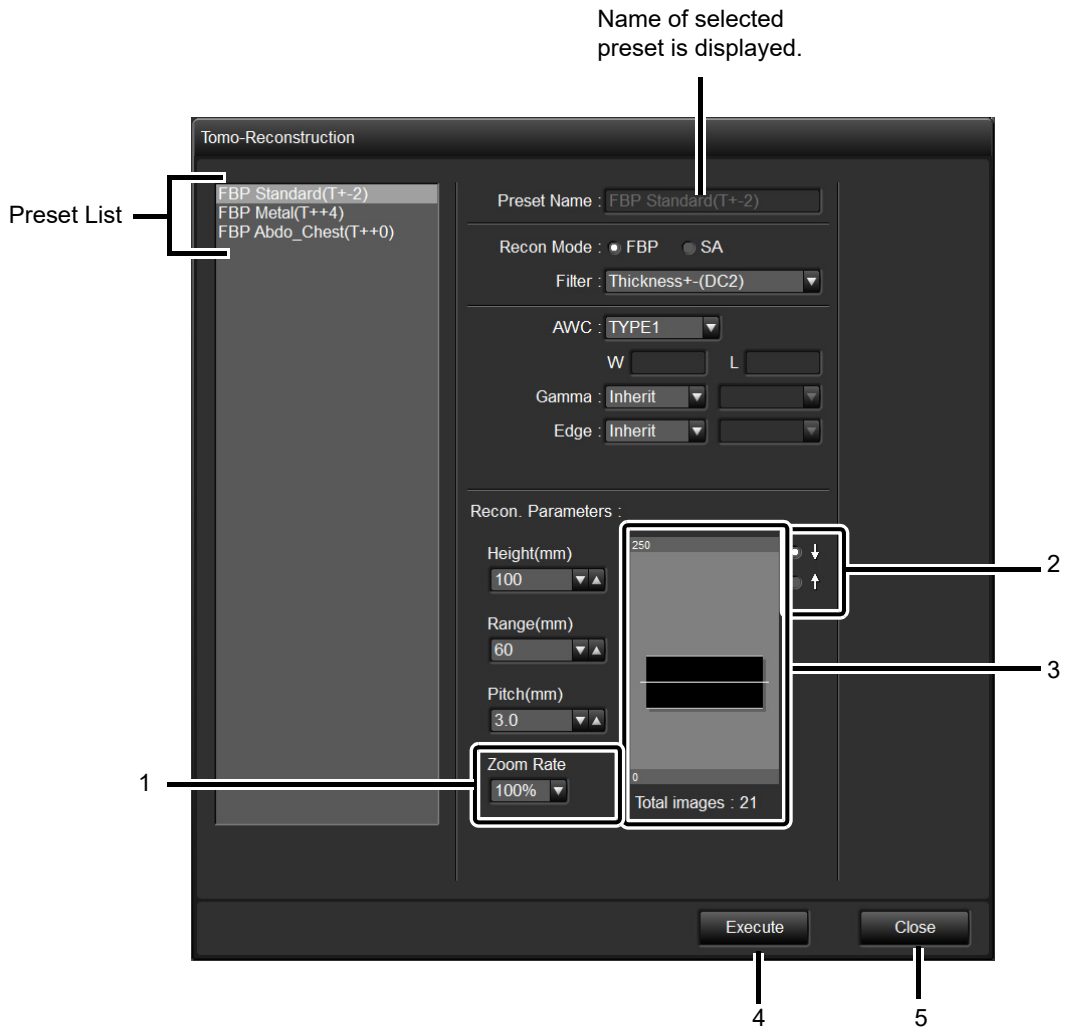

If a list containing multiple images or an image other than a TOMOS acquired image is selected, a confirmation window is displayed. Reselect the correct image.

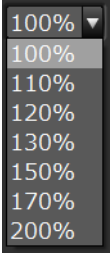
 7.3.1 "Error Message"

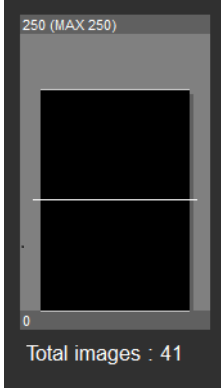

No.	Item	Function
1		<p>[Zoom Rate]</p> <p>Specifies the enlargement factor to apply to the reconstructed image. Either enters a value in the box or selects from the list.</p> 
2		<p>Image creation order</p> <p>Specifies the order in which reconstructed images are created.</p> <p>If [↑] is selected, images are reconstructed in order from the cross section closest to the tabletop.</p> <p>If [↓] is selected, images are reconstructed in order from the cross section furthest from the tabletop.</p>

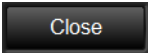
No.	Item	Function
3		<p>Spatial Index</p> <p>Shows the height and range specified in a range of 0 to 250 mm as an rectangle. Refer to the below for the height and range setting.</p> <p> "How to Set Hight and Range" on page 7-15</p> <p>[Total images]</p> <p>Shows the number of reconstructed image that will be created with the reconstruction parameter on the [TOMO-Reconstruction] window.</p>
4		<p>[Execute]</p> <p>Performs reconstruction with the current parameter.</p>
5		<p>[Close]</p> <p>Closes the [TOMO-Reconstruction] window.</p>

Refer to the section below for [Recon Mode], [AWC], [Gamma] and [Edge].

 13.7.1 "Tomosynthesis Presets"

Refer to the section below for [Height], [Range], and [Pitch].

 "TOMOS (Option)" on page 13-46

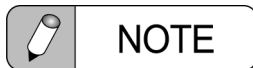

When selecting a preset not matching the conditions used in the actual study, a proper reconstructed image might not be created.

How to Set Hight and Range

Follow the procedure below to set the height and range with the Spatial index.

Fig.1

Example) Height 100

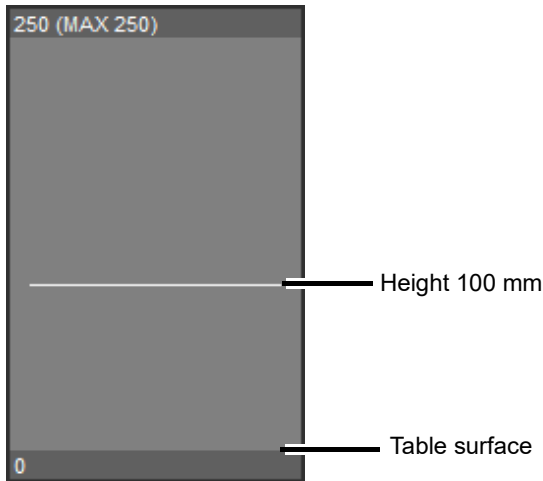

- The spatial index shows the reconstruction range according to the [Height] and [Range] values on the [Tomo-Reconstruction] window. The lower end shows the table surface.
- First, input into the [Height] box the height of the central cross section as a distance in mm from the table surface. The setup range is from 0 mm to 250 mm, in increments of 1 mm. The white line corresponding to the input appears on the spatial index (Fig. 1).

Fig.2

Example) Height 100 mm

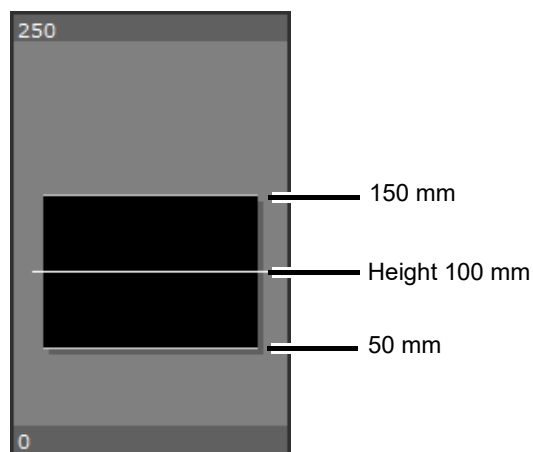

- Next, set the reconstruction range. It becomes vertically elongated from the central cross section specified in [Height]. The setup range is from 0 mm to 300 mm, in increments of 1 mm. The black rectangle area showing the reconstruction range corresponding to input appears on the spatial index (Figure 2).

The [Range] must be less than twice the value specified in [Height] since it is impossible to set the lower end of the range below the table (Fig. 3).

Fig.3

Example) Height 100 mm
Range 200 mm (maximum at 100 mm of height)

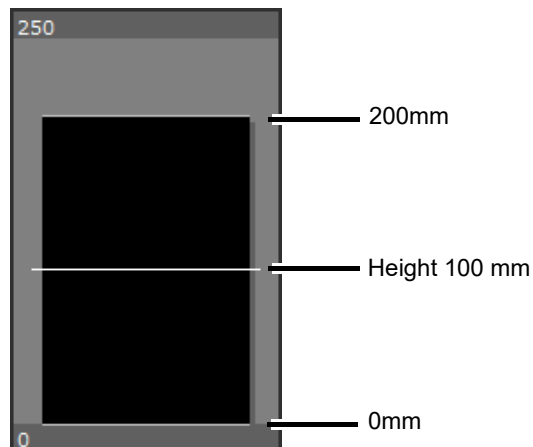

- Set the conditions as appropriate, and click [Execute].
The reconstruction processing is started in the background processing.

During Tomosynthesis reconstruction, the [Check Processing Status] button lights up. Click it to check its status.

When processing is completed, the light goes off.

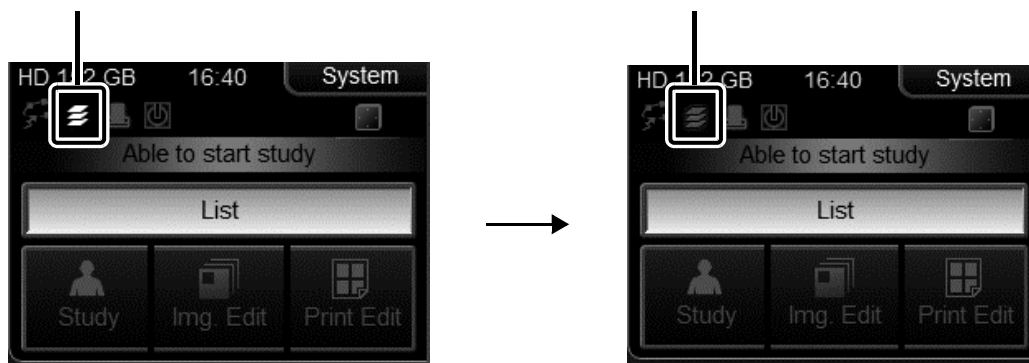

When the processing is completed, the created reconstructed image appears in the [Image List] window. To check the created image, double-click it or select it and click [Open].



"TOMOS_O" indicates the acquired image with Tomosynthesis.

"TOMOS" indicates the reconstructed image.