



Ray

RAYSCAN 



Lower dose

- Quick scan times
- Pulsed X-ray technology
- Multiple scan modes

3 Dedicated detectors

- Reliable performance
- No damage
- Long life span

Easy upgrade

- Ready to upgrade CBCT & Cephalometric
- Remote calibration and updates

Intelligent operation

- Ingenious cooling by ATCT
- Auto alignment
- Minimized preparation time
- Remote update

Technology for Convenience
make it easy, with Ray





Easy to Read LED - Color coded exposure status

Intuitive user interface



Convenient wireless remote control



Designed for Optimized Workflow
make it simple, with Ray



Lower dose

The RAYSCAN α is designed with cutting edge detectors and pulsed X-ray technology. Various 2D panoramic modes provide the relevant clinical data you need to make accurate diagnoses. Proprietary CBCT reconstruction, Adaptive Moving Focus, and noise reduction technologies provide high quality images at optimized radiation exposure.

Super-Fast Scan Times

4 second cephalometric scans reduce dose by over 80%*

Cutting edge cephalometric imaging technology results in fast scan times for orthodontic procedures. The high performance Cadmium Telluride (CdTe) detector allows for the capture of excellent cephalometric images at a reduced radiation dose. Short exposure times reduce the risk of retakes associated with patient movement.

* Compared to former products



Pulsed X-ray

Radiation dose is reduced through cycling off the generator during data transfer from the sensor. Operation of pulsed X-ray needs high frequency of generator. RAYSCAN α is designed to implement over 100 kHz for the operation of pulsed X-ray.

Intuitive interface

Simplified user interface provides an intuitive imaging workflow.

- Various scan mode with a simple selection on the main display : Standard, Tooth/Full mode Segmentation, Bitewing, Orthogonal, Sinus, TMJ
- Tooth mode has less dose compared to a full mode panoramic.
- Automatically selected dental arch and X-ray exposure condition according to patient's age

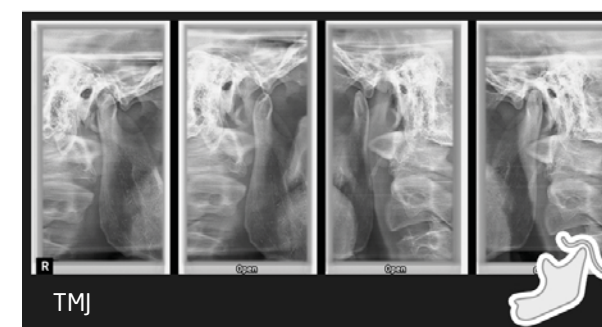
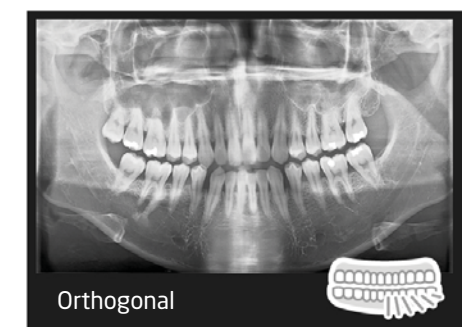
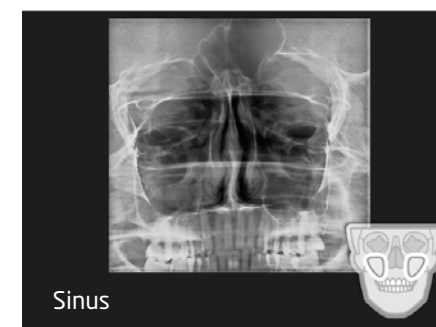
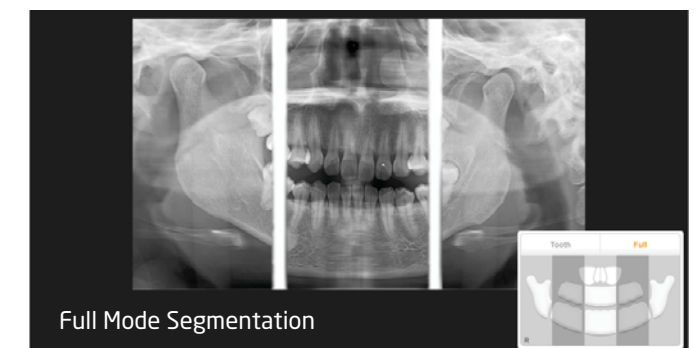
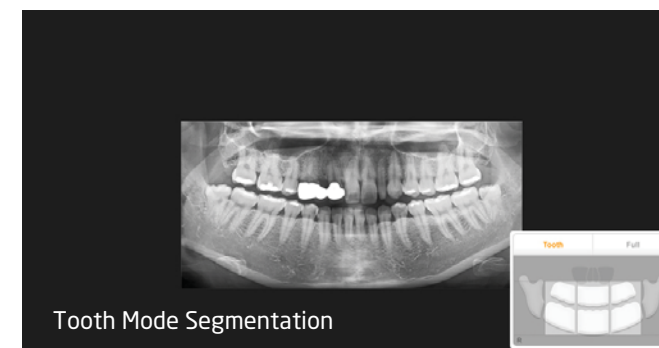

Excellent image quality through advanced technology

AMF (Adaptive Moving Focus)

RAYSCAN α utilizes Adaptive Moving Focus Technology to configure the panoramic image layer and optimize the signal to noise ratio(SNR) to produce high quality images.

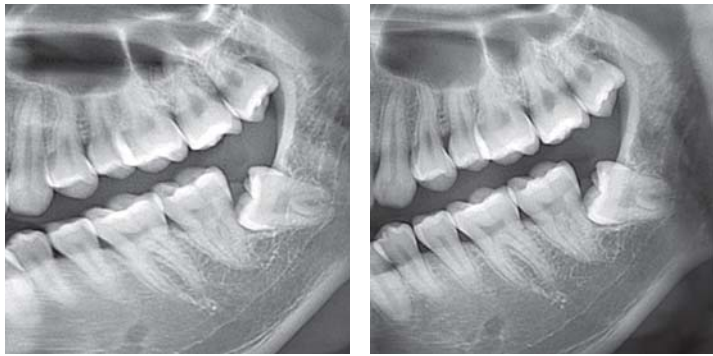

[off] [on]

Denoising

Proprietary noise reduction technology enhances image quality.

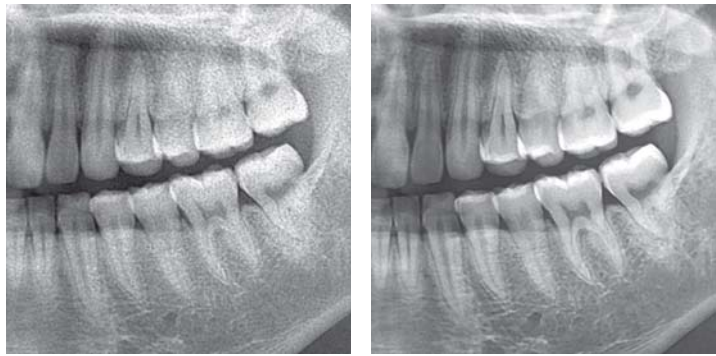

[off] [on]

MAR (Metal Artifact Reduction)

Our own CBCT reconstruction technology significantly reduces metal artifacts such as stars and shadows caused by X-ray scatter with no additional procedure and time. With the same time, RAYSCAN α provides more information around metal for accurate diagnosis.

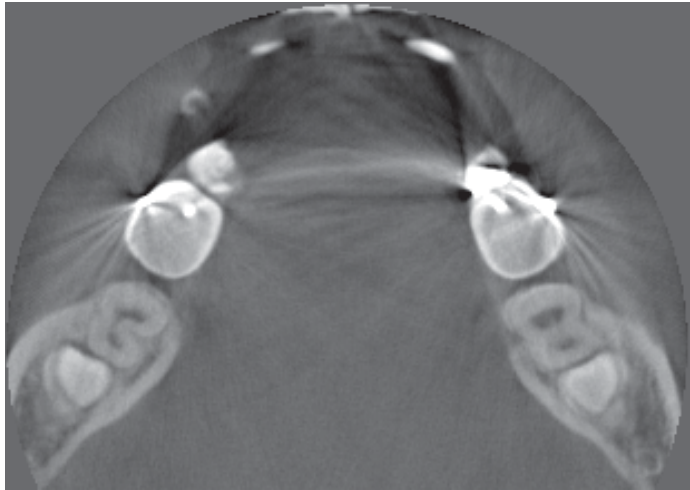

[off]

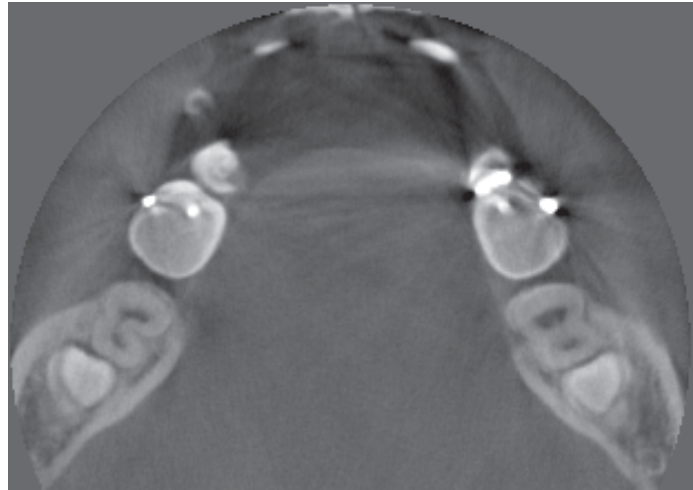

[on]

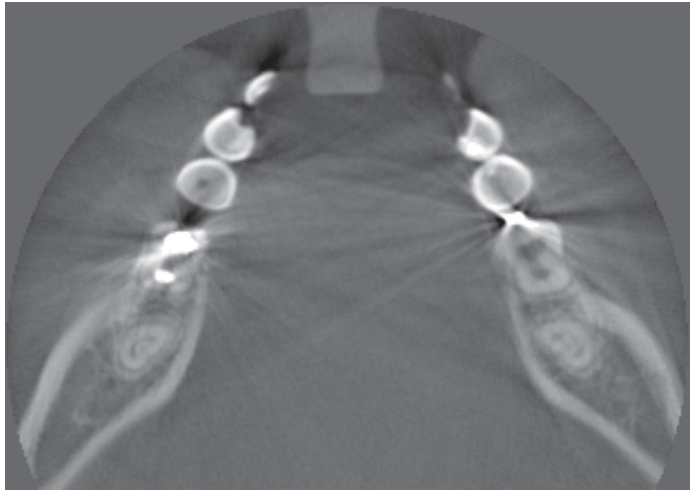

[off]

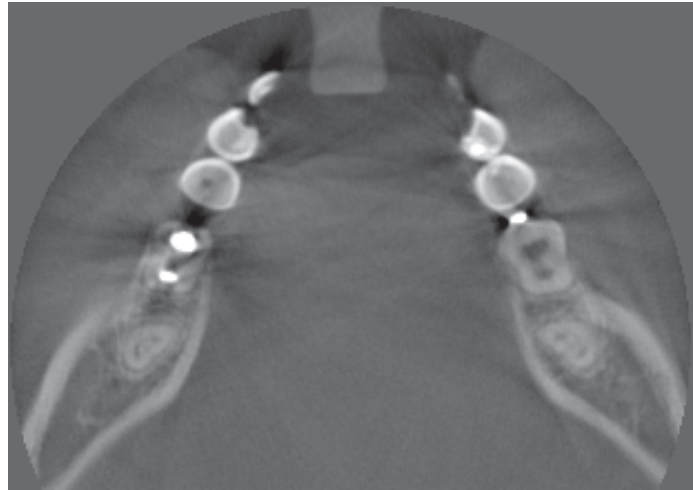

[on]

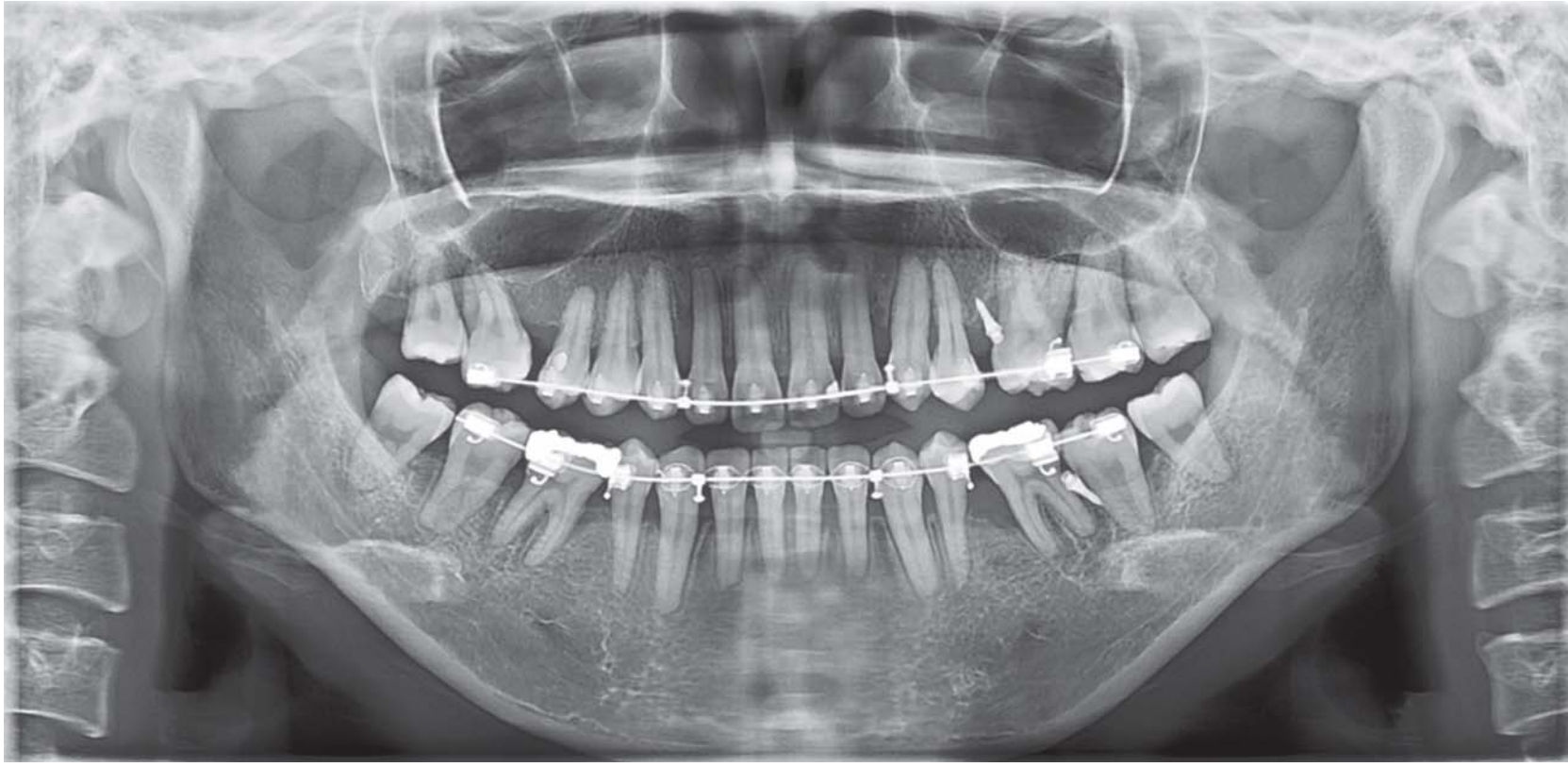

2D Imaging Software

Key Features

- Integrated dental image management
- Touch environment considered simple UI
- 16 bits full imaging system with DICOM 3.0
- Supports TWAIN-compliant input devices

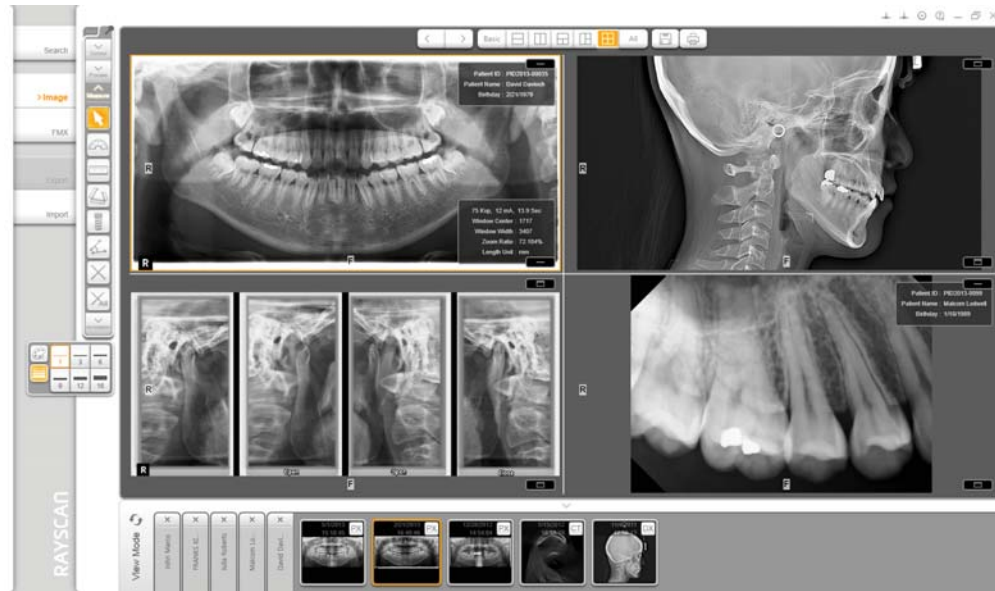

Web Viewer - Optional

Key Features

- Convenient use in tablet & smart phone
- Optimal viewing experience by responsive web design
- No need to install software



3D Imaging Software

Key Features

- Panoramic image & Cross-Sectional image
- Excellent 3D image with shading technology
- Nerve canal drawing & implant simulation
- DICOM print & CD/DVD burning

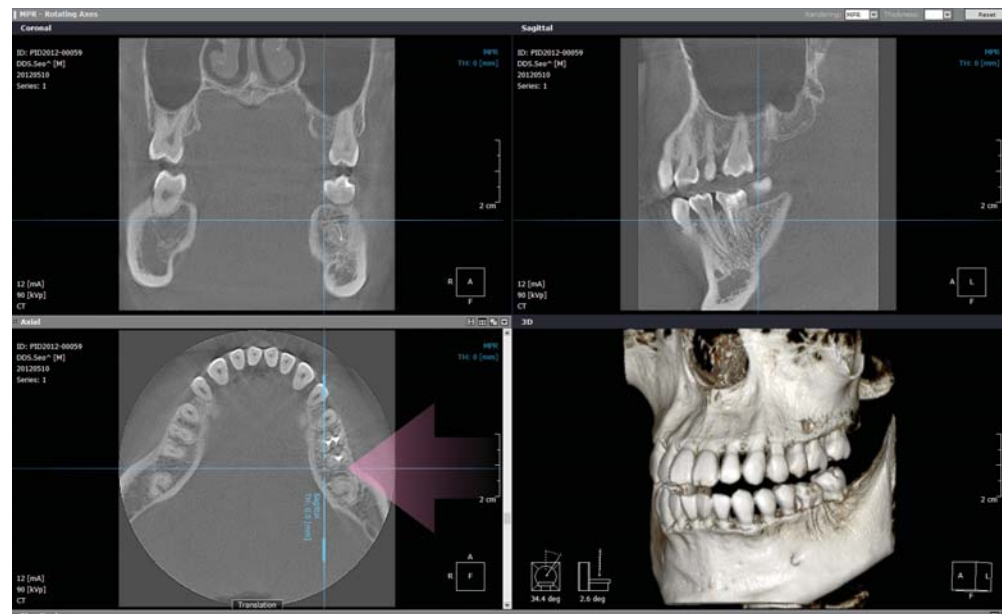

Please note that as a generic viewing application RAYSCAN^{web} is not suited for diagnostic purposes. However it is an excellent tool for communication a diagnosis made at SMARTDent for desktop.



ATCT (Adaptive Tube Cooling Time)

- Continuous acquisition without forced cooling prevents image downgrading

Auto Alignment

- All alignment components are automatically re-positioned

Minimized preparation time

- Provides psychological stability of the patient, reducing moving artifact of images

Wireless Remote Control

- Easy positioning system

be comfortable, with Ray

All patient position can be controlled by [Wireless Remote Control](#)

Technical Specifications

RAYSCAN α

Type	Panoramic, Cephalometric, Cone Beam CT
Patient positioning	Standing (wheelchair accessible)
Focal spot	0.5mm
Tube voltage	60~90kVp
Tube current	4~17mA
Weight	RAYSCAN α -P & 3D: 150kg ($\pm 10\%$) / RAYSCAN α -SC & SM3D: 177.5kg ($\pm 10\%$)

	CBCT	Panoramic	Cephalometric (Scan type)
Detector type	CMOS	CMOS	CdTe
F.O.V	9x9cm	-	Max. 26x24cm
Voxel size (CT)	0.143~0.286 mm ³	-	-
Scan time	14sec	Max. 14sec	Min. 4.0sec

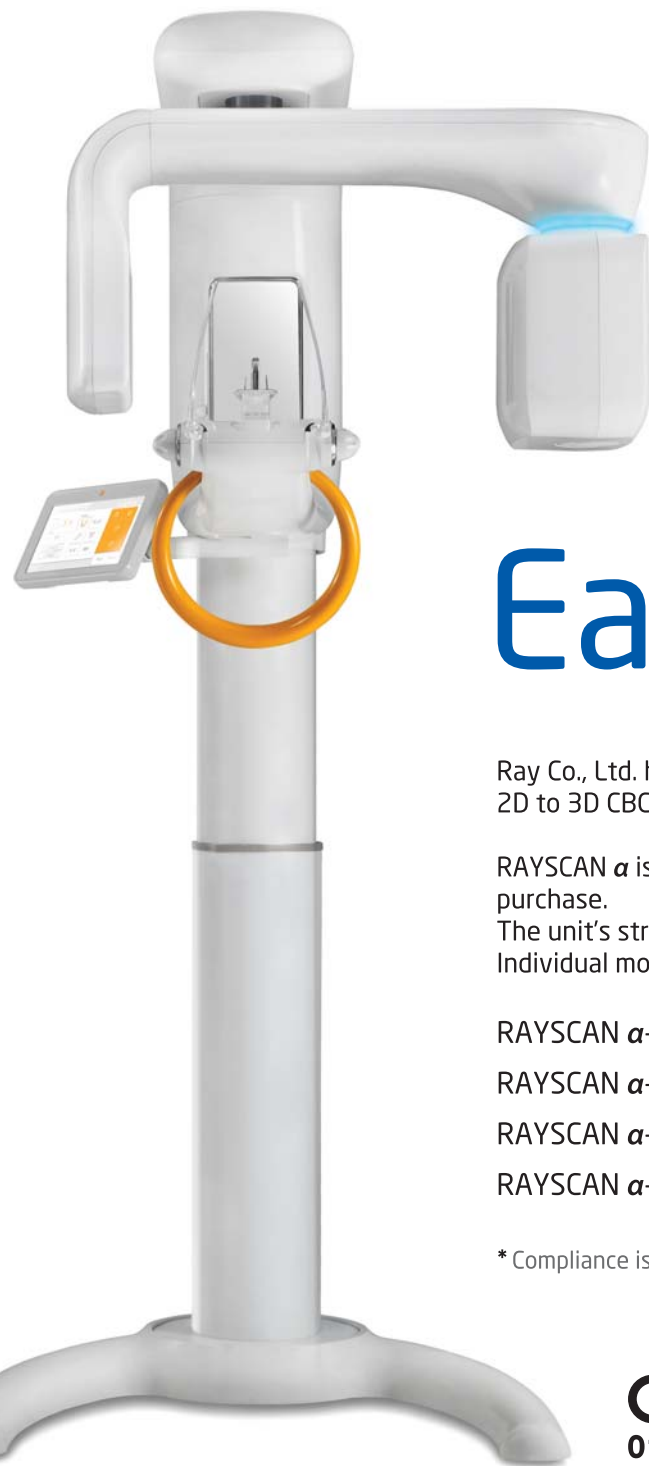
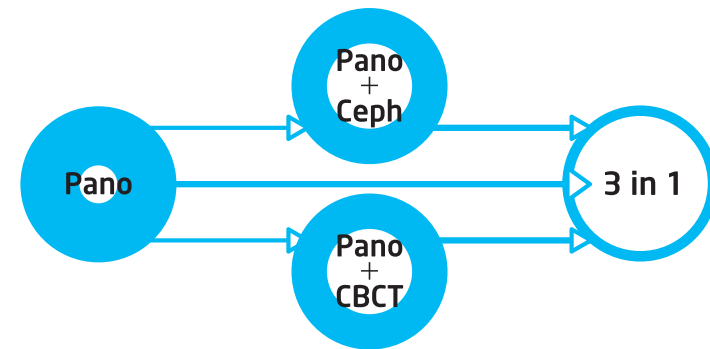

Easy Upgrade

Ray Co., Ltd. has the best solution for you if you are considering upgrade of units; 2D to 3D CBCT or 2D panoramic with cephalometric system.*

RAYSCAN α is designed to have dental clinics in mind for the upgrade from the first purchase.

The unit's structure allows fast & easy conversion to different structure of units. Individual models can be produced before delivery or upgraded later.

RAYSCAN α -P (Panoramic only)

RAYSCAN α -SC (Panoramic & Cephalometric)

RAYSCAN α -3D (Panoramic & CBCT)

RAYSCAN α -SM3D (Panoramic & Cephalometric & CBCT)

* Compliance issue may be different depending on the country.



FDA registration

Dimensions (Unit:mm)

Suggested Operating Space



RAYSCAN α -P (Pano) / RAYSCAN α -3D (Pano + CT)

Top View

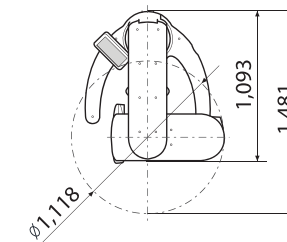

Front View

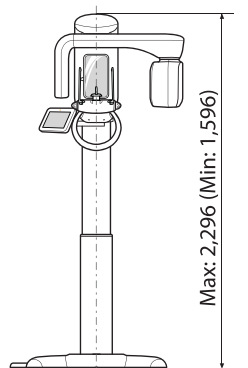

RAYSCAN α -SC (Pano + Scan ceph) / RAYSCAN α -SM3D (Pano + CT + Scan ceph)

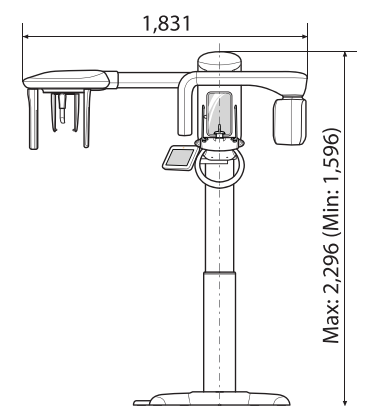
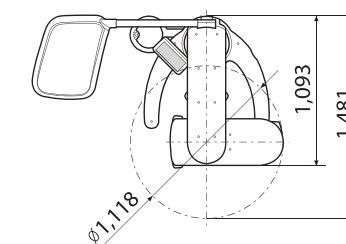

better life, with Ray



Ray Co., Ltd.
332-7, Samsung 1-ro, Hwaseong-si, Gyeonggi-do, 18380, Korea
Phone +82.31.605.1000
Email ray_overseas@raymedical.co.kr
Web www.raymedical.com

RBS-A01 (rev.4)
Design and specifications are subject to change without notice

For Children 2014