

Specificatie Tehnica Completata

Modelul:OP-C5; Producator: Optomic ESPANA S.A., Tara: Spania

Specificarea tehnică deplină solicitată de către autoritatea contractantă	Specificarea tehnică deplină propusa de către autoritatea ofertanta
<p>Colposcop Cod 261000 Descriere Colposcopia este o metodă de diagnostic neinvazivă. Împreună cu examenul citocitologic și histologic colposcopia stă la baza diagnosticului precoce al cancerului de col uterin, permițând o decizie terapeutică în timp util și urmărirea fazelor tratamentului. Parametrul Specificația Sursă de lumină Tip halogen sau LED</p> <p>Putere $\geq 150W$ (pentru LED, echivalen)</p> <p>Timp de viață lampă $\geq 500h$</p> <p>Suprafața rezistentă la prelucrarea chimică Axa de rotație ≥ 2</p> <p>Înălțime reglabil</p> <p>Lampă de rezervă ≥ 1</p> <p>Unghi de rotație ≥ 300 grade</p> <p>Unghiul de iluminare reglabil Obiectiv Înălțimea față de podea min ≥ 500 pina la ≥ 1160 mm</p> <p>Mișcarea orizontală ≥ 950 mm Binoculare da Compatibil cu linie histeroscopie da Zoom 4, 6, 10, 16, si 25X Zoom optic Lentilă ≥ 18 Suport Mobil da Diametru roți ≥ 6 cm Frână ≥ 2 Alimentarea 220-240V, 50-60Hz Filtru verde da</p>	<p>Colposcop DA Cod 261000 Descriere Colposcopia este o metodă de diagnostic neinvazivă. Împreună cu examenul citocitologic și histologic colposcopia stă la baza diagnosticului precoce al cancerului de col uterin, permițând o decizie terapeutică în timp util și urmărirea fazelor tratamentului. DA Parametrul Specificația Sursă de lumină Tip LED DA Separata de colposcop instalat pe bratul suportului mobil Putere $\geq 150W$ (pentru LED, echivalen) DA 10.000 Klux Ref FIBROLUX LED HP pag. 2 Timp de viață lampă 60.000 h Ref FIBROLUX LED HP pag. 2 Suprafața rezistentă la prelucrarea chimică Axa de rotație ≥ 2 DA Ref.USER MANUL OP-C5 pagina 19 Înălțime reglabil DA Ref.USER MANUL OP-C5 pagina 19 Lampă de rezervă ≥ 1 Pentru LED nu este necesar timpul find de 1000 de ori mai re fata de cel cu halogen Unghi de rotație ≥ 300 grade DA Ref.USER MANUL OP-C5 pagina 19 Unghiul de iluminare reglabil DA Obiectiv Înălțimea față de podea min 710 mm pina la 995 mm la inaltimea. DA DA Ref.USER MANUL OP-C5 pagina 19 Mișcarea orizontală ≥ 950 mm DA Binoculare DA Compatibil cu linie histeroscopie DA Zoom de 2.5 x pina la 27 x in 10 pasi DA Zoom optic Lentilă 27 x DA Suport Mobil DA Diametru roți ≥ 6 cm DA Frână 5 - DA pentru toate rotile Alimentarea 220-240V, 50-60Hz DA Filtru verde DA prezent</p>



Declaration of Conformity *Declaración de Conformidad*

OPTOMIC ESPAÑA, S.A.
Madroño 4 F - P. Ind. La Mina
28770 Colmenar Viejo, Madrid
SPAIN

Declares under its solely responsibility that the Class I product, according to rule 10:
Declara bajo su exclusiva responsabilidad que el producto de Clase I, según la regla 10:

COLPOSCOPE (ANNEX I) **COLPOSCOPIO (ANEXO I)**

is in conformity with the legislation of Regulation 2017/745 concerning Medical Devices and complies with the standards included in the technical documentation. / *es conforme a las disposiciones del Reglamento 2017/745 relativas a Productos Sanitarios y cumple con las normas incluidas en la documentación técnica.*

Our Quality Management System, with its continuing certification, guarantees that our products meet the required quality demands. / *Nuestro Sistema de Gestión de Calidad, con su certificación continua, garantiza que nuestros productos cumplen con las exigencias de calidad requeridas.*

Intended use: Optical instrument that allows to obtain an enlarged image of the area to be examined. It has a LED lighting system. The equipment is mainly used for diagnostic purposes in the specialty of Gynecology. / *Finalidad prevista: Instrumento óptico que permite obtener una imagen aumentada de la zona a examinar. Cuenta con un sistema de iluminación led. El equipo se emplea principalmente con fines diagnósticos en la especialidad de Ginecología.*

SRN: ES-MF-000003235
Basic UDI-DI / *UDI-DI básico*: 843604158 0111 2B

Date of issue / *Fecha de emisión*: 26/05/2021

Valid until / *Válido hasta*: 28/07/2023

P.O.
JRF

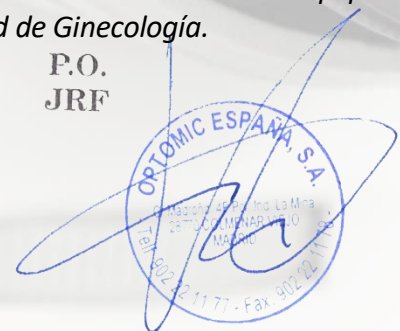

Jorge Rial Ferrario
General Manager
In/En Colmenar Viejo, Spain

**ANNEX I TO DECLARATION OF CONFORMITY:
COLPOSCOPE**

**ANEXO I DE LA DECLARACIÓN DE CONFORMIDAD:
COLPOSCOPIO**

REF.	DESCRIPTION	DESCRIPCIÓN
19503007	OP-C12 COLPOSCOPE (45º)	COLPOSCOPIO OP-C12 (45º)
19503014	OP-C16 COLPOSCOPE (45º)	COLPOSCOPIO OP-C16 (45º)
19643612	OP-C5 COLPOSCOPE	COLPOSCOPIO OP-C5
19423307	OP-C2L COLPOSCOPE	COLPOSCOPIO OP-C2L
19423314	OP-C2 COLPOSCOPE	COLPOSCOPIO OP-C2

Date of issue / Fecha de emisión: 26/05/2021

Valid until / Válido hasta: 28/07/2023

P.O.
JRF



Jorge Rial Ferrario
General Manager
In/En Colmenar Viejo, Spain



Declaration of Conformity *Declaración de Conformidad*

OPTOMIC ESPAÑA, S.A.
Madroño 4 F - P. Ind. La Mina
28770 Colmenar Viejo, Madrid
SPAIN

Declares under its sole responsibility that the Class I product, according to rule 13:
Declara bajo su exclusiva responsabilidad que el producto de Clase I, según regla 13:

BEAM SPLITTER (ANNEX I) DIVISOR DE IMAGEN (ANEXO I)

is in conformity with the legislation of Regulation 2017/745 concerning Medical Devices and complies with the standards included in the technical documentation. / *es conforme a las disposiciones del Reglamento 2017/745 relativas a Productos Sanitarios y cumple con las normas incluidas en la documentación técnica.*

Our Quality Management System, with its continuing certification, guarantees that our products meet the required quality demands. / *Nuestro Sistema de Gestión de Calidad, con su certificación continua, garantiza que nuestros productos cumplen con las exigencias de calidad requeridas.*

Intended use: The beam splitters visualize the images from the Microscope/Colposcope on monitors and electronic devices. / *Finalidad prevista: Los divisores de imagen visualizan las imágenes provenientes del Microscopio/Colposcopio en monitores y soportes electrónicos.*

SRN: ES-MF-000003235

Basic UDI-DI / *UDI-DI básico*: 843604158 0414 2Y

Date of issue / *Fecha de emisión*: 26/05/2021

Valid until / *Válido hasta*: 28/07/2023

P.O.
JRF



Jorge Rial Ferrario
General Manager
In/En Colmenar Viejo, Spain

**ANNEX I TO DECLARATION OF CONFORMITY:
BEAM SPLITTER**

**ANEXO I DE LA DECLARACIÓN DE CONFORMIDAD:
DIVISOR DE IMAGEN**

REF.	DESCRIPTION	DESCRIPCIÓN
71003128	OP-TV.DC BEAM SPLITTER F/SONY	DIVISOR DE IMAGEN OP-TV.DC P/SONY
71003255	OP-TV CLICK BEAM SPLITTER	DIVISOR DE IMAGEN OP-TV CLICK
71003288	OP-TV BEAM SPLITTER	DIVISOR DE IMAGEN OP-TV
71003302	OP-TV8 BEAM SPLITTER (PAL)	DIVISOR DE IMAGEN OP-TV8 PAL
71003316	OP-TV10 HD BEAM SPLITTER	DIVISOR DE IMAGEN OP-TV10 HD
71003614	OP-TV PHONE BEAM SPLITTER	DIVISOR DE IMAGEN OP-TV PHONE
71003321	INDEPENDENT POWER SUPPLY FOR OP-TV8	DIVISOR DE IMAGEN CAJA INDEPENDIENTE P/ OP-TV8
71003322	INDEPENDENT POWER SUPPLY FOR OP-TV10HD	DIVISOR DE IMAGEN CAJA INDEPENDIENTE P/ OP-TV10HD
71003128	OP-TV.DC BEAM SPLITTER F/SONY	DIVISOR DE IMAGEN OP-TV.DC P/SONY

Date of issue / Fecha de emisión:

26/05/2021

Valid until / Válido hasta:

28/07/2023

P.O.
JRF



Jorge Rial Ferrario
General Manager
In/En Colmenar Viejo, Spain

LED COLD LIGHT SOURCE FIBROLUX LED HP

HIGH POWER LED LIGHT SOURCE

- Extensive LED lifespan:
60.000 hours
- Two colour temperatures:
white or warm
- Power supply for camera,
monitor and PC



The FIBROLUX LED HP developed by OPTOMIC is a versatile light source used in endoscopy, microscopy and colposcopy. One of its unique features is the possibility of choosing between white and warm light, adapting to the preference and needs of each doctor.

LED COLD LIGHT SOURCE FIBROLUX LED HP

	TECHNICAL FEATURES
LED LIFESPAN	Over 60.000 hours
LIGHT POWER	10.000 Klux
COLOUR TEMPERATURES	6.000°K and 4.750°K
SWING-IN FILTERS	Green or amber (depending on specialty) and warm light
VENTILATION SYSTEM	Double and with automatic speed
FIBER OPTIC CONNECTION	Storz (other types optional)
CONNECTIONS	2 x 12v DC outputs 1 x AC power output (max. 5A) 1 x remote stand-by output (for foot pedal)
MATERIAL	Aluminium casing
POWER SUPPLY	100 – 240v AC / 50/60 Hz
DIMENSIONS	150 x 120 x 290mm
WEIGHT	4,5 kg



Swing-in filters



Fiber optic connection



Rear panel

High performance light

The powerful illumination is achieved through a distinctive optical light condensation system, composed of four lenses, that makes the light highly intense.



Two light colours

For a maximum illumination comfort and an improved colour reproduction, the user can choose between two colour temperatures; intense white light (6.000°K) or warm daylight (4.500°K).

Multiple connection possibilities

In the rear of the light source, two 12V DC outputs allow for the connection of a camera or a monitor. An AC power output for external devices, as for example PC, laptop or monitor, is also available. Optionally, a foot pedal can be connected in order to turn on and off the device remotely.

The minimal cabling results in an easy and tidy installation.

Energy efficient unit

The FIBROLUX LED HP is a low energy consumption device. With a LED lamp lifespan of more than 60.000 hours, the need of frequent lamp replacements is eliminated, enabling the doctor to work without annoying interruptions and to save in consumables.

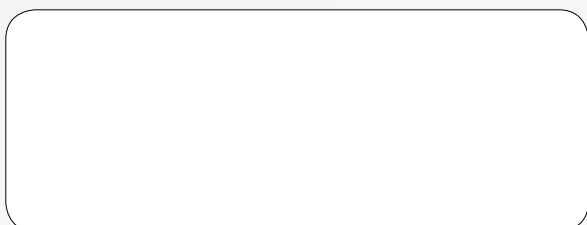

TÜV SÜD TÜV SÜD TÜV SÜD TÜV SÜD TÜV SÜD TÜV SÜD TÜV SÜD TÜV SÜD TÜV SÜD TÜV SÜD TÜV SÜD TÜV SÜD TÜV SÜD TÜV SÜD TÜV SÜD
ZERTIFIKAT ◆ CERTIFICATE ◆ 認證證書 ◆ CERTIFICADO ◆ CERTIFICAT



Product Service

Certificate

No. Q5 034400 0015 Rev. 01

Holder of Certificate:



OPTOMIC ESPAÑA, S.A.

Madroño 4 F- P. Ind. La Mina
28770 Colmenar Viejo, Madrid
SPAIN

Facility(ies):

OPTOMIC ESPAÑA, S.A.
Madroño 4 F- P. Ind. La Mina, 28770 Colmenar Viejo, Madrid,
SPAIN

Certification Mark:



Scope of Certificate:

Design and Development, Production, Distribution, Sale and Technical Service of Microscopes, Colposcopes, Rigid and Flexible Endoscopes, Cold Light Sources, Camera Systems, Optic Systems, Diagnostic Workstations, Cameras for Endoscopy, Examination Chairs, Stroboscopes and Sale of Medical Equipment

Applied Standard(s):

EN ISO 13485:2016
Medical devices - Quality management systems -
Requirements for regulatory purposes
(ISO 13485:2016)
DIN EN ISO 13485:2016

The Certification Body of TÜV SÜD Product Service GmbH certifies that the company mentioned above has established and is maintaining a quality management system, which meets the requirements of the listed standard(s). See also notes overleaf.

Report No.: 713162857

Valid from: 2020-07-29

Valid until: 2023-07-28

Date, 2020-05-20

Christoph Dicks
Head of Certification/Notified Body

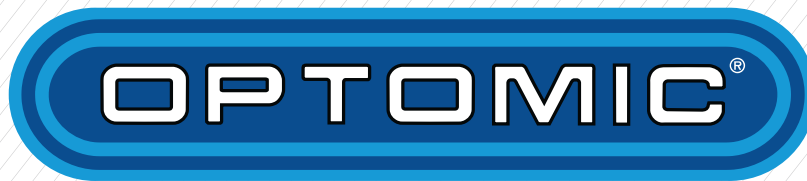

producing quality

USER AND SERVICE MANUAL

OP-C5 COLPOSCOPE













Rev 3.8. - 13/01/2016



USER MANUAL

Equipment:
Serial number:

SAFETY SYMBOLS AND SIGNS

	Caution
	Warning
	Device type B
	Equipotential
	Stand by
	Manufacturer
	Serial number
	Direct current
	Waste product of electric and electronic devices
	Luminosity, brightness
	Operation instructions
	Alternating current
	Polarity

OPTOMIC ESPAÑA S.A. reserves all rights to change the design and specifications contained in this manual without prior notice.

INDEX

		PAGE
0.	NOMENCLATURE	4
1.	APPLICABILITY	5
2.	INSTALLATION	6
3.	FUNCTIONS AND MOVEMENTS	7
4.	PRIOR REVISION	8
5.	START-UP	9
6.	ADJUSTMENT PRIOR TO USE	9
7.	CHANGING A LAMP	10
8.	CHANGING A FUSE	10
9.	MAINTENANCE	11
10.	WARNINGS	13
11.	TROUBLESHOOTING CHART	15
12.	TECHNICAL SPECIFICATIONS	16
13.	CONNECTION OF THE VIDEO SYSTEM	17
14.	MAINTENANCE CHART	18
15.	ILLUSTRATIONS	19
16.	NOTES	31

0. - NOMENCLATURE

- | | |
|---|-----------------------------------|
| 1 - Eyepieces | 43 - Base with wheels |
| 2 - Binocular body | 44 - Plastic cover |
| 3 - Milled screw | 45 - Washer |
| 4 - Milled screw | 46 - Screw |
| 5 - Fibre optic cable (head extreme) | 47 - Allen key |
| 6 - 90° blocking milled screw | 49 - Head axle |
| 7 - Arm | 50 - Swivel blocking knob |
| 8 - Strength and blocking regulation knob | 51 - Head fixing screw |
| 9 - Manoeuvring handle | 52 - 45° inclined binocular body |
| 10 - Arm tension regulation knob | 53 - Fibre optic connector |
| 11 - Micrometric knob | 54 - Ventilation Grids |
| 12 - Magnification change knob | 55 - Lamp holder box |
| 23 - Illumination system arm | 56 - Lever |
| 24 - Cold light source | 57 - Ceramic lamp holder |
| 25 - Front blocking knob | 62 - Beam splitter |
| 26 - Rear blocking knob | 63 - Screw |
| 28 - Tube retention screws | 64 - CCD camera |
| 29 - Allen key | 65 - Connector |
| 30 - Power cord receptacle | 66 - Screws |
| 31 - Fuses holder | 67 - Coupling ring |
| 32 - Equipotential | 68 - White balance knob |
| 33 - Fibre optic cable (illumination extreme) | 69 - Automatic white balance knob |
| 34 - Lighting regulator Knob | 70 - Connector of the camera |
| 35 - "Power" LED | 71 - Diaphragm adjustment knob |
| 36 - "Stand by" LED | 72 - Swivel limiting screw |
| 37 - Opening knob | 73 - Identification label |
| 38 - Main power switch | 74 - Focus knob |
| 41 - Light source fixing knob | |
| 42 - Tube | |

1. - APPLICABILITY

The OP-C5 OPTOMIC colposcope has been designed for diagnostic observations, usual operations in doctors' office, as well as small surgical applications.

The OP-C5 OPTOMIC colposcope is an optic equipment of great precision, especially designed for the use in surgical and diagnostic gynaecology.

The system of adjustment of the tightness and the blocking of the arm makes this colposcope the ideal equipment for laser surgery, being available a laser micromanipulator accessory.

The equipment has a high quality optical part, which offers features like the magnification changer of six positions (Galileo system), inclined binocular with dioptric adjustment of both eyes, micrometric focus by rack and pinion, as well as adjustment of the head movement by one manoeuvring handle.

The mechanical part consists of several precision systems in order to make the positioning movements of the colposcope. Thanks to the arm of elevation through tensioned parallelogram, the colposcope is very comfortable and practical to use. Furthermore, you can adjust the tightness of the different movements by means of the blocking knobs.

The illumination is made through a generator of cold halogen light. The light is carried through a fibre optic cable to the objective of the head making a coaxial illumination in the observation axis, which contributes to an excellent illumination of the area to be examined.

In addition to the above-mentioned features, it is possible to add the following accessories:

- CCD colour video camera
- Digital photographic camera
- Co-observation tube
- Laser micromanipulator adaptor
- Illuminating for speculum

2. - INSTALLATION

The installation of the OP-C5 OPTOMIC colposcope very simple and does not require specialized technician.

2.1 FLOOR STAND

- 2.1.1. Place the box on the floor, remove the seals and protectors. **Fig. 5**
- 2.1.2. Two people lift the wheeled base of the unit out of the box [43] and place it on the floor (attention – the base weighs 17,750 kg). **Fig. 6**
- 2.1.3. Introduce the conical end of the support tube [42] into the opening of the base. **Fig. 7**
- 2.1.4. Tilt the entire base and tube unit in order to install the screw [46] with the washer [45] **Fig. 10**. Tighten it firmly using the Allen key [47]. **Fig. 8**
- 2.1.5. Place the unit vertically, so it is supported on all of its wheels, and introduce the plastic cover into the tube [44] in order to hide the metal base. **Fig. 9**

2.2 ASSEMBLY OF THE COLPOSCOPE BODY



WARNING: DO NOT CUT THE PLASTIC SEAL UNTIL THE ARMS HAVE BEEN PLACED ON THE STAND AND THE HEAD IN ITS PLACE.
FIG. 02

- 2.2.1. Remove the packaging, and place the arms of the colposcope on the floor stand by introducing the axis of the body into the tube [42]. Then adjust the screws [28] with the Allen key [29]. **Fig. 11**
- 2.2.2. Introduce the fibre optic cable [33] into its housing in the cold light source. **Fig. 12**
- 2.2.3. Place the axle of the head [49] so the red spot of the axle (A) coincides with the red spot of the extreme of the arm (B). **Fig. 13**
- 2.2.4. Tighten it with knob [50]. **Fig. 13**
- 2.2.5. Place the head of the OP-C5 upon this axle by introducing it by the yoke so the red spot of the yoke (C) coincides with the red spot of the extreme of the arm (B). **Fig. 14**
- 2.2.6. Fix the head firmly to the axle through the two screws [51]. **Fig. 15**
- 2.2.7. To install the manoeuvring handle [9], screw it into its housing. Tighten gently until it keeps back the inclination of the head. **Fig. 16**
- 2.2.8. Place the 45° inclined binocular body [52] and adjust it with the milled screw [3] **Fig. 17**. Place the binocular [2] upon this and tighten with the corresponding milled screw [4]. **Fig. 18**
- 2.2.9. Introduce the extreme of the fibre optic cable [5] into its housing in the head [53] until it "clicks". **Fig. 19**
- 2.2.10. Position the arm completely extended and in a line, that is, with the head unit at one end, followed by the illumination system arm at the other end. Adjust the screw [72] thus limiting the turning of the arm over the illumination system arm, preventing the optical fibre from twisting. **Fig. 20**
- 2.2.11. Connect the power cord to the equipment [30] **Fig. 4**, and then to the mains into a grounded outlet. The OP-C5 OPTOMIC colposcope is now ready to be used.

3. - FUNCTIONS AND MOVEMENTS

The OP-C5 OPTOMIC colposcope has been designed in order to provide all the movements and articulations necessary for correct observation:

3.1 LEFT-RIGHT POSITIONING

The 180° swivel of the illumination system arm [23] Fig. 3 allows the colposcope to be positioned on either side of the patient.

3.2 POSITION AT HEIGHT

In order to achieve the desired height, raise or lower the head unit of the colposcope articulating arm [7]. The position will be stable thanks to its balance system. The up and down movement of the colposcope arm can be adjusted by using two knobs [8] and [10]. Fig. 21 and Fig. 22

Knob [8] allows tightening and totally fixing the up and downing movement of the arm, while knob [10] adjusts the tension of the parallelogram, that is, the strength of the arm when going up or down. This adjustment is very useful if you wish to add or remove an accessory, because then you will be adding weight to the arm or taking it away.

3.3 INCLINATION MOVEMENT OF THE HEAD

The head can be inclined according to the vertical axis. This regulation is made with the manoeuvring handle [9] Fig. 16. When you turn it counter-clockwise, the inclination movement is liberated, and you can position the head. In order to fix this position, turn the knob clockwise.

3.4 SWIVEL MOVEMENT OF THE HEAD

The head can turn 90° with respect to the arm, according to the position of the colposcope (if it is placed left or right to the bed). In order to fix or liberate this swivel movement, use knob [50] Fig. 13, which is placed in the arm. Below this knob, there is a captive screw, which regulates the tightness of the swivel of the head. From factory the unit is supplied with a certain tightness, which can be modified by loosening or tightening the mentioned captive screw.

Opposite the knob [50], you will find a small milled screw [6] Fig. 14 to block the swivel of the head at 90° with respect to the arm. If you would like to turn the head 180° with respect to the arm, you should loosen this screw, place the head, and then tighten the screw again.

3.5 INTER-PUPIL DISTANCE ADJUSTMENT

Use both hands to turn around the binocular body [2], approaching or moving away the eyepieces until their distance coincides with your interpupilar distance. Fig. 23

3.6 DIOPTRIC CORRECTION ADJUSTMENT

By turning around the eyepieces [1] Fig. 23 the dioptric correction can be adjusted to the need of your eyes, both for near-sightedness and far-sightedness or set at 0 for normal eyesight (Ametropia).

3.7 CHANGE OF MAGNIFICATION

The magnifications of the OP-C5 OPTOMIC colposcope can be changed either with the left or the right hand, by turning the knob [12] until it "clicks", which means that the position has been reached. Fig. 24

The marks on the colposcope body shows the magnification factor: 0,4 – 0,66 – 1 – 1,5 – 2,5, indicating the corresponding magnification according to the magnification table (page 20).

3.8 FINE FOCUS

The OP-C5 OPTOMIC colposcope is prepared to make a direct focus by means of the arm movement. However, if you need a fine focus, this can be obtained by using the micrometric knob [11]. Fig. 25

3.9 TIGHTNESS REGULATION OF HORIZONTAL MOVEMENTS

The horizontal swivel of the colposcope arm, as well as the swivel of the illuminating system arm, are made of high resistant conical bearings, which eliminate free movements and allow a smooth movement, which sometimes require a little tightness. This is obtained by carefully adjusting the knobs [25] and [26]. If you want to block these movements totally, tighten the mentioned knobs very firmly. Fig. 26

In order to lessen the firmness or remove the blocking, previously introduced, the knobs should be loosened, turning them counter-clockwise to their maximum.

3.10 COLD LIGHT SOURCE









The illumination system of the OP-C5 is removable, making it possible to remove the cold light source for other specialties, as for example Endoscopy.

To remove the cold light source, disconnect the fibre optic cable and loosen the fixing knob [41] Fig. 3.

To reinstall it, place the light source under the arm support [23] and adjust again the knob [41]. Connect the fibre optic cable again.

4. - PRIOR REVISION

Before starting, check the following:

- 4.1  The lamps should be firmly installed in their corresponding housing, with the pins correctly introduced into the ceramic lamp holder. Please attach according to the lamp holder box's label.
- 4.2  The lighting regulator knob [34] Fig. 3 should be in the OFF position, with the white mark of the knob coinciding with the smallest circle.
- 4.3  Check that the mains voltage used is the one given in the identifying label [73] and in the fuse holder. Fig. 4
- 4.4  Verify that the “**GROUNDING**” of the electrical system is in proper condition and is correctly connected to the equipment.
- 4.5  Check that the ventilation grids [54] Fig. 3 are well clear and that there is no obstruction within at least 10cm.
- 4.6  Verify that in the location where the colposcope is to be installed there is no source of water or liquid nearby which could come into contact with the equipment.
- 4.7  Check that there are no gases or emanations of flammable substances in the area.
- 4.8  Verify that the fuse holder is installed with a fuse and that it is the correct type [31] Fig. 28

5. - START-UP

- 5.1 Connect the cord to the device [30] Fig.28 and then to the mains to a grounded outlet.
- 5.2 Turn on the current [38] Fig. 28 (the "stand by" LED [36] Fig. 27 will light up). Tuning the knob [34] clockwise Fig. 27 will switch on the equipment (the "power" LED [35] Fig. 27 will light up). This knob regulates the light intensity, which can be increased to its maximum.



The position of maximum illumination reduces the life span of the lamp.



In any lighting position the fan will be functioning. If, for any malfunctioning, the fan stops working, switch off the equipment as the high temperature generated could burn out the lamp. Contact the technical service immediately.



While the equipment is not in use, it is recommended to keep it turned off.

6. - ADJUSTMENT PRIOR TO USE

- 6.1. Loosen the knurled screw [4] and remove the binocular [2] from the head Fig. 18. Take it and observe an object (non luminous itself) from a distance greater than 30 m.
- 6.2. Observe the object with one eye, the right one for example, and with the eyepiece's dioptre correction ring focus the image until you can see it with complete clarity.
- 6.3. Then, without moving the binocular, do the same with the other eye until the image is perfectly focused.
- 6.4. While performing this operation, the binocular should not be moved, therefore it is advisable to rest it on a support.
- 6.5. Take the binocular in both hands and observe the same distant object now focused, opening or closing the body of the binocular until there is a single and centred image.
- 6.6. Replace the binocular on the head unit.

After this process, the interpupilar distance has been corrected, and the binocular has been focused, eliminating any possible visual anomalies. Write down the position of both eyepieces and the measurement of the interpupilar distance, because if the colposcope is used by others these measures may be altered.

- 6.7 Connect the equipment to the power supply, switch on the colposcope light source and observe what you wish to examine. Use first the highest magnification, seeking the best image with the focusing system, and then change to the magnification required. The equipment will always be focused as long as the focusing distance is the same.

Some people experience difficulties seeing a single image when using a stereoscopic binocular equipment. With practice and a few exercises these problems will disappear almost entirely.

- a) It is very important to have the interpupilar distance perfectly adjusted. Focus both eyes and practise as much as possible these exercises.
- b) Relax and observe through the eyepieces, as if the object was at a great distance. You are observing through a system of parallel beams. The eyes must be completely relaxed and should not converge the way they do when observing an object from a short distance.
- c) If this cannot be achieved, repeat point (b) exceeding the focus level and then moving the colposcope back until the object comes into focus.
- d) Another way is to observe, above the binocular eyepieces, a remote object in the room. Maintaining the level of convergence, *as if you were still looking at the same object*, lower your head to interpose the colposcope, which should be previously focused on an object.

Use with a Patient: The use with a patient is very easy and similar to the previous observation. Simply keep in mind that when observing deep cavities, the head of the colposcope should be lowered until the observation axis is in line with the cavity or with the axis of the speculum.

7. - CHANGING A LAMP

This unit has two lamps. Having a replacement lamp will allow the examination to continue without loss of time in the case that one burns out. The following is a description, firstly, of a quick lamp change and secondly, of the substitution of a burned out lamp.

CHANGE OF A LAMP DURING AN EXAMINATION:

- 7.1 Turn the lighting regulator knob [34] Fig. 3 to the “OFF” position.
- 7.2 Turn the opening knob [37] counter-clockwise and extract the lamp holder box [55]. Fig. 29, 30 and 31
- 7.3 Rotate 180° the lamp holder box and introduce it again into the cold light source making it coincide with the guides. Fig. 32
- 7.4 Screw the opening knob, turning it clockwise, in order to attach the lamp holder box [55] Fig.37. Now the light source is in perfect working condition to continue with the examination.

Take the precaution to replace the burned out lamp once the examination is over.

CHANGE OF A BURNED OUT LAMP:



VERY IMPORTANT: BEFORE CHANGING THE LAMP DISCONNECT THE EQUIPMENT FROM THE ELECTRICAL SUPPLY AND VERIFY THAT THE LIGHT SOURCE AND THE LAMP ARE COMPLETELY COOLED

- 7.5 To proceed with the changing of the burned out lamp, begin by performing steps 7.1 and 7.2.
- 7.6 Then, use the lever [56] to lift the burned out lamp from the ceramic lamp holder [57] until it can be removed by hand. Fig. 33
- 7.7 In the same position, introduce the new lamp. Press with your fingers to put it into its final position. Keep in mind that the two flaps of the glass parabola should coincide with the corresponding housing of the metal lamp fitting (see diagram on the lamp holder box). Fig. 34, 35 and 36
If this was not performed correctly, the lamp may be displaced or its pins may not have a proper connection, which will affect the quality of the light or the life span of the lamp.
- 7.9 When the lamp has been replaced, proceed with step 7.4.

8. - CHANGING A FUSE

- 8.1  Switch off the unit [38] Fig. 28 and disconnect the power cord from the mains.
- 8.2 Disconnect the power cord from the light source [30] Fig. 28.
- 8.3 With the help of a small screwdriver lift the fuse holder [31] Fig. 28 and change the fuse taking care not to remove the fuse holder sheathing (beige-coloured), as this connects the different voltages of each country. In the case that the mentioned sheathing is removed, insert it again, verifying that the voltage on the identification label is the same as that where the equipment will be connected.
- 8.4 Then introduce the fuse holder in its position, pressing it until it “clicks”.
- 8.5 Connect the power cord to the light source and then to the mains.

9. - MAINTENANCE



VERY IMPORTANT: WHEN CARRYING OUT ANY CLEANING OR MAINTENANCE ACTIVITIES, DISCONNECT THE EQUIPMENT FROM THE MAINS

To clean and disinfect the external surface of the equipment use a clean cloth, barely dampened with a disinfectant solution (follow the dissolution instructions of the manufacturer). Clear up with a cloth dampened with water. Take care that no fluid gets inside the equipment.

DO NOT USE DETERGENTS, SOLVENTS OF OTHER AGGRESSIVE AGENTS



As this is electrical equipment which produces internal heat, the condition of the components should be checked periodically (at least once every 6 months) to ensure the correct functioning of the equipment.



To carry out any type of revision or maintenance contact the manufacturer.



All REVISIONS, REPAIRS, MAINTENANCE AND MODIFICATIONS should be registered, with the date and signature of the authorized company or person carrying out the work, in the **Maintenance Chart** of this manual.

ANNUAL MAINTENANCE AND INSPECTION

Manufacturer's recommendations:

OPTOMIC ESPAÑA S.A. recommends that an expert technician carries out a regular inspection of the functioning and safety of the equipment. Said inspection should be carried out annually. Regular inspections can contribute to the anticipation and prevention of eventual malfunctions and problems and increase the safety and life of the equipment.

Safety Test:

Make a visual test. Pay special attention to the following points:

- The fuse corresponds to the value indicated by the manufacturer.
- The indications and labels of the device are readable.
- The mechanical conditions of the unit permit a safe functioning of the equipment.
- There is no dirt which may affect the equipment negatively.
- Measure the leakage current according to EN 60601-1 and EN 60601-1-1.

The admissible values of permanent leakage current and auxiliary current to the patient are established in the below table for alternating current and continuous current and for the waves composed with frequencies lower than 1 kHz.

For frequencies over 1 kHz, the admissible values according to the table must be multiplied by the numerical value of the frequency in kHz. Nevertheless, the results of the multiplication should not exceed 10 mA.

TABLE

Admissible values for permanent LEAKAGE CURRENT and AUXILIARY CURRENT TO THE PATIENT, in milliamp

CURRENT	B TYPE	
	Normal condition	Single Fault Condition
Earth leakage current	0,5	1 ¹⁾
Enclosure leakage current	0,1	0,5
Leakage current to the patient	0,1	0,5
Leakage current to the patient (Supply voltage in the signal output part)	-	5
Leakage current to the patient (Supply voltage in the applicable part)	-	-
Auxiliary current to the patient	D.C.	0,01
	A.C.	0,1
		0,05
		0,5

1) The only single fault condition for earth leakage current is the interruption of one of the leading in wires, one each time.

- Measure the protection wire resistance according to EN 60601. The protection wire resistance should be measured with the main supply connected. The maximum value is 0.2 Ω.
- Measure the insulation resistance with 500-700V DC. The minimum value is 50 MΩ. It is not admitted to measure the tension resistance with high voltage.









10.- WARNINGS

THE INFORMATION GIVEN BELOW IS VERY IMPORTANT FOR SECURITY REASONS AND SHOULD BE TAKEN INTO CONSIDERATION DURING THE USE OF THIS EQUIPMENT



OPTOMIC ESPAÑA S.A., MANUFACTURER OF THIS EQUIPMENT, TAKES NO RESPONSIBILITY FOR PERSONAL OR MATERIAL DAMAGES OR INJURY SUSTAINED BY THIRD PARTIES RESULTING FROM THE WRONGFUL OR INADEQUATE USE OF THIS EQUIPMENT, DISREGARD FOR THE INSTRUCTIONS PROVIDED IN THE PRESENT MANUAL, REPAIRS CARRIED OUT BY UNQUALIFIED OR UNAUTHORISED PERSONNEL, DEFICIENT MAINTENANCE OR CARE FOR THE EQUIPMENT

- 10.1**  At the focal point of the halogen lamp with parabolic dichroic reflector, a very high temperature is achieved. For this reason - and in spite of the heat dispersers - the extreme of the fibre optic cable, which is in contact with the focus point, becomes hot. Allow the fibre optic cable to cool down completely before disconnecting it from the cold light source.
- 10.2**  The halogen light source of the OP-C5 OPTOMIC colposcope is of 150w, and emits an intense beam of light. Never look directly into the light outlet. As a safety measure, it is advisable to connect the fibre optic cable before turning the illumination on.
- 10.3**  As the colposcope is an electric unit, which emits a very intense light, it is important that only qualified personnel use the equipment. Never leave the unit unattended when children are near.
- 10.4**  Before replacing the lamps, the colposcope must be disconnected from the mains and cooled down completely.
- 10.5**  The equipment should never be used where there is a risk of explosion.
- 10.6**  This device has electronic components, which may be harmful to the environment if they are not managed correctly. When the effective life of the colposcope is over, the national and local waste management norms must be respected, or the colposcope may be returned to OPTOMIC ESPAÑA S.A., for the proper knob and disposal of these components.



OPTOMIC ESPAÑA, S.A. TAKES NO RESPONSIBILITY FOR PHYSICAL AND/OR MATERIAL DAMAGES OR INJURIES TO THIRD PARTIES RESULTING FROM THE INCORRECT INSTALLATION OF THE OP-C5 OPTOMIC COLPOSCOPE



ACCORDING TO LEGAL NORMS THE MANUFACTURER ONLY ACCEPTS LIABILITY FOR THE EFFECTS ON SAFETY, RELIABILITY AND PERFORMANCE OF THE EQUIPMENT IF THE MAINTENANCE PROCEDURES, REPAIRS AND MODIFICATIONS ARE CARRIED OUT BY THE MANUFACTURER OR BY A PERSON AUTHORIZED BY THE MANUFACTURER. OTHERWISE, THE MANUFACTURER WILL NOT ASSUME ANY RESPONSIBILITY, AND THE GUARANTEE PERIOD WILL EXPIRE AUTOMATICALLY.

THE MANUFACTURER WILL NOT ACCEPT ANY RESPONSIBILITY FOR THE INADEQUATE OR IMPROPER USE OF THE EQUIPMENT OR IF IT IS USED FOR PURPOSES OTHER THAN THOSE FOR WHICH IT WAS DESIGNED.

COMPONENTS RELATED WITH SAFETY MUST BE REPLACED BY ORIGINAL PARTS ONLY.

AFTER ANY MODIFICATION OR REPAIR A SAFETY TEST WILL BE CARRIED OUT. THE EQUIPMENT MUST MEET ALL TECHNICAL SAFETY SPECIFICATIONS ACCORDING TO APPLICABLE NORMS.

ALL MODIFICATIONS, REPAIRS AND TESTING SHOULD BE NOTED ON THE MAINTENANCE CHART.

11. - TROUBLESHOOTING CHART

In case of a problem or malfunction, consult the chart below to determine the cause and possible solution. If the solution is not found, contact the authorized technical service.

PROBLEM	POSSIBLE CAUSE	ACTION
The light source does not function when the knob [34] is turned to any position.	Power cord not connected. Defective power cord. Mains voltage is not identical to voltage given on unit nameplate. Mains electrical outlet is defective. Defective fuse.	Plug in the power cord. Replace cord. Check and verify. Check and verify. Replace fuse.
The lamp does not light up but the "power" LED [35] is on.	Defective lamp. Ceramic lamp holder is not connected.	Replace the lamp. Connect the lamp holder.
The light intensity is not correct for the position indicated.	The lamp is defective. Filament deterioration in the lamp bulb. The lamp is out of place or not properly installed. Loss of power.	Replace the lamp. Replace the lamp. Connect the lamp. Check the mains.
Excessive temperature in the light source.	Fan is not working. Cooling air outlets are not free. High temperature in the room. Unit directly under sunlight. Unit installed by a heater.	Notify authorized Repair Service. Let air outlets free. Ventilate the room. Place unit out from the sunlight. Place it far from the heater.

RETURN OF THE EQUIPMENT

Should it be necessary to send back the equipment, only the original packing should be used. Optomic España S.A. is not to be held responsible for the damages or defects produced during the transport due to a deficient packing. When returning the equipment, please enclose the following information:

- Name of the owner
- Complete address of the owner
- Serial number
- Description of the defect(s)

12. - TECHNICAL SPECIFICATIONS

12.1 ELECTRICAL

Input voltage 100V-230V / 50 Hz -60 Hz
 Power consumption..... 180 VA
 Halogen dichroic lamp..... "PHILIPS" 6423 XHP FO ERF A1/232 GZ6.35- 15V 150W
 Fuses 2 x T 2, 00 A / T 2, 50 A / T 3, 15 A
 Electrical shock protection UNE EN 60601/ IEC 601 Class I
 Classification..... B
 Medical equipment group.....60601-2
 Interference suppression..... Value limit B

12.2 MECHANICAL/OPTIC

Maximum distance of the head 1.295 mm
 Minimum distance of the head 1.010 mm
 Haul of the head (up/down)..... 250 mm
 Distance between head and centre of the floor stand..... 920 mm
 Head inclination 37°
 Rotation angle of the head (left/right)..... 90°
 Dimensions of folded equipment..... 1.020mm x 700mm x 150mm
 Weight..... 78 kg
 Eyepiece Wide Field
 Binocular Inclined
 Objective f=300mm (f=250mm optional)
 Magnifications changer 5 Positions Galileo system
 Illumination..... Coaxial through the objective
 Light conduction Fibre optic cable
 Fibre optic connector in cold light source, Storz type. In head, recess with "click"
 Magnifications..... According to the below table

12.3 MAGNIFICATION TABLE

BINOCULAR f=170mm	OBJECTIVE f=250mm					OBJECTIVE f=300mm				
Magnification Changer	2,5x	1,5x	1x	0,66x	0,4x	2,5x	1,5x	1x	0,66x	0,4x
Magnifications	22x	14x	9x	6x	4x	18x	11x	7x	5x	3x
Field of view	11	19	28	45	70	14	25	35	50	85

13. - CONNECTION OF THE VIDEO SYSTEM

EQUIPMENT FOR VIDEO-COLPOSCOPY OP-TV6 (OPTIONAL SYSTEM)

- 13.1 Loosen the milled screw [4] and remove the binocular [2] from the colposcope. **Fig.18**
- 13.2 Place the beam splitter [62] with the optic elbow on the right **Fig. 38**.
- 13.3 Tighten the screw [4] again.
- 13.4 Place the binocular [2] on the beam splitter [62] and fasten the screw [63]. **Fig. 38 and 40**
- 13.5 If the CCD camera [64] **Fig. 38** is not attached on the beam splitter, screw it to the coupling ring [67]. **Fig. 40**
- 13.6 Connect the video signal cable to the video output [65] **Fig. 39** of the camera [64], and then to the monitor or video. Turn on the video equipment.
- 13.7 Connect the power cord 12v to the connector of the camera and then to the mains.
- 13.8 Focus any object and verify that the image is upright and focalized, with respect to the image of the colposcope.

If not, loosen the three screws [66] **Fig. 40**, and correct the image by turning the CCD camera. Afterwards, tighten the three screws.

- 13.9 If the image is not focalized, proceed as follows:

With the eyepieces adjusted to your eyes (see section 6), observe an object through the binocular using the largest magnification (2,5x) and, without moving the colposcope, turn the focusing knob [74] **Fig. 40** of the beam splitter, until you are able to see very clearly.

Finally, verify that the image of the monitor is focused with the image of the binocular.

14. - MAINTENANCE CHART

All maintenance work, repairs or modifications should be recorded on the following maintenance chart with the date and signature of the company and/or person who carried them out.

WORK EXECUTED Equipment Nº	REPAIRED BY	DATE	SIGNATURE

ALL REPAIRS OR MODIFICATIONS WERE CARRIED OUT BY AN EXPERT TECHNICIAN IN FULL ACCORDANCE WITH THE SAFETY NORMS ACCORDING TO UNE IN 60601/IEC 601.

15. - ILLUSTRATIONS

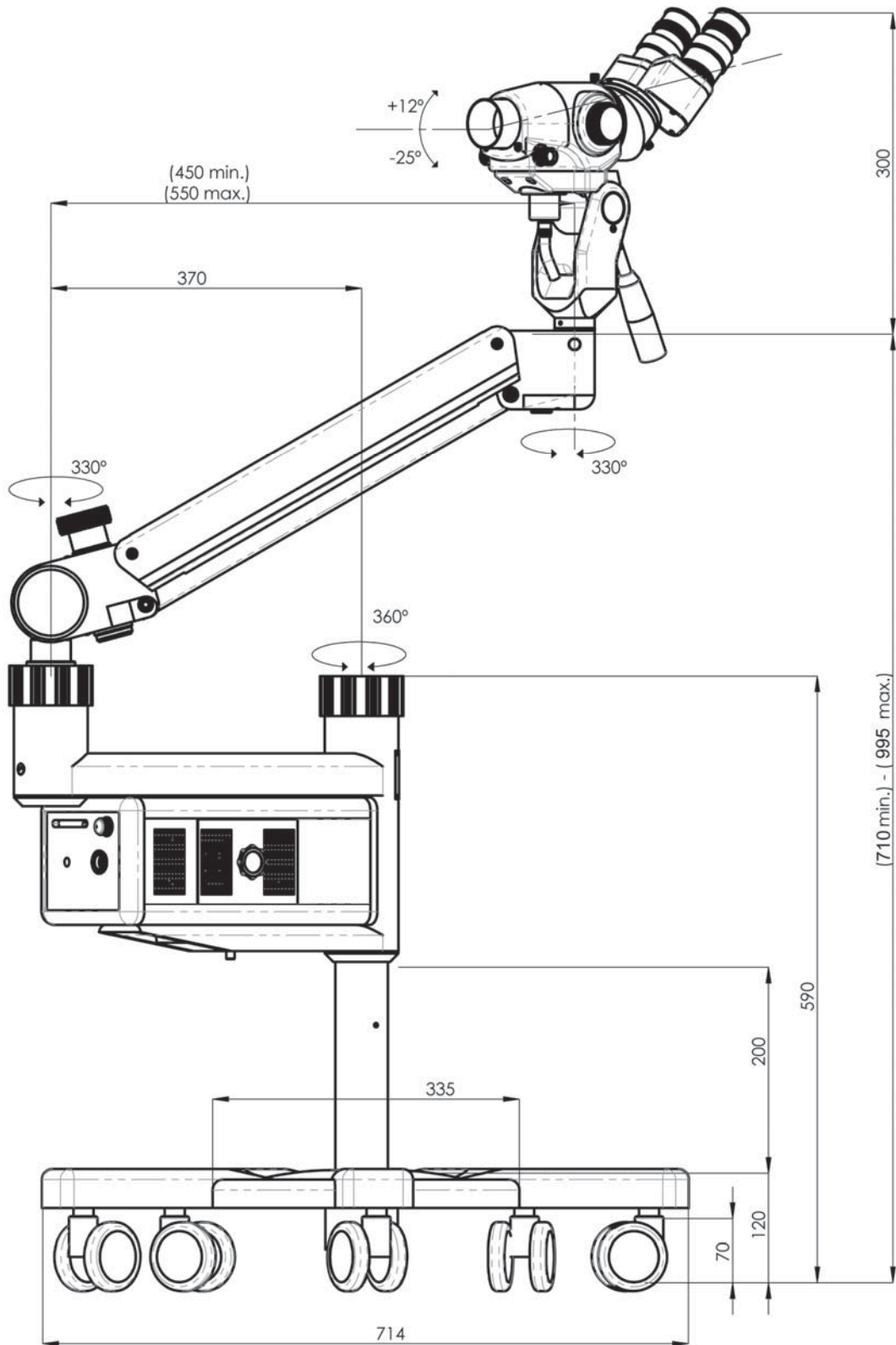

Fig. 1

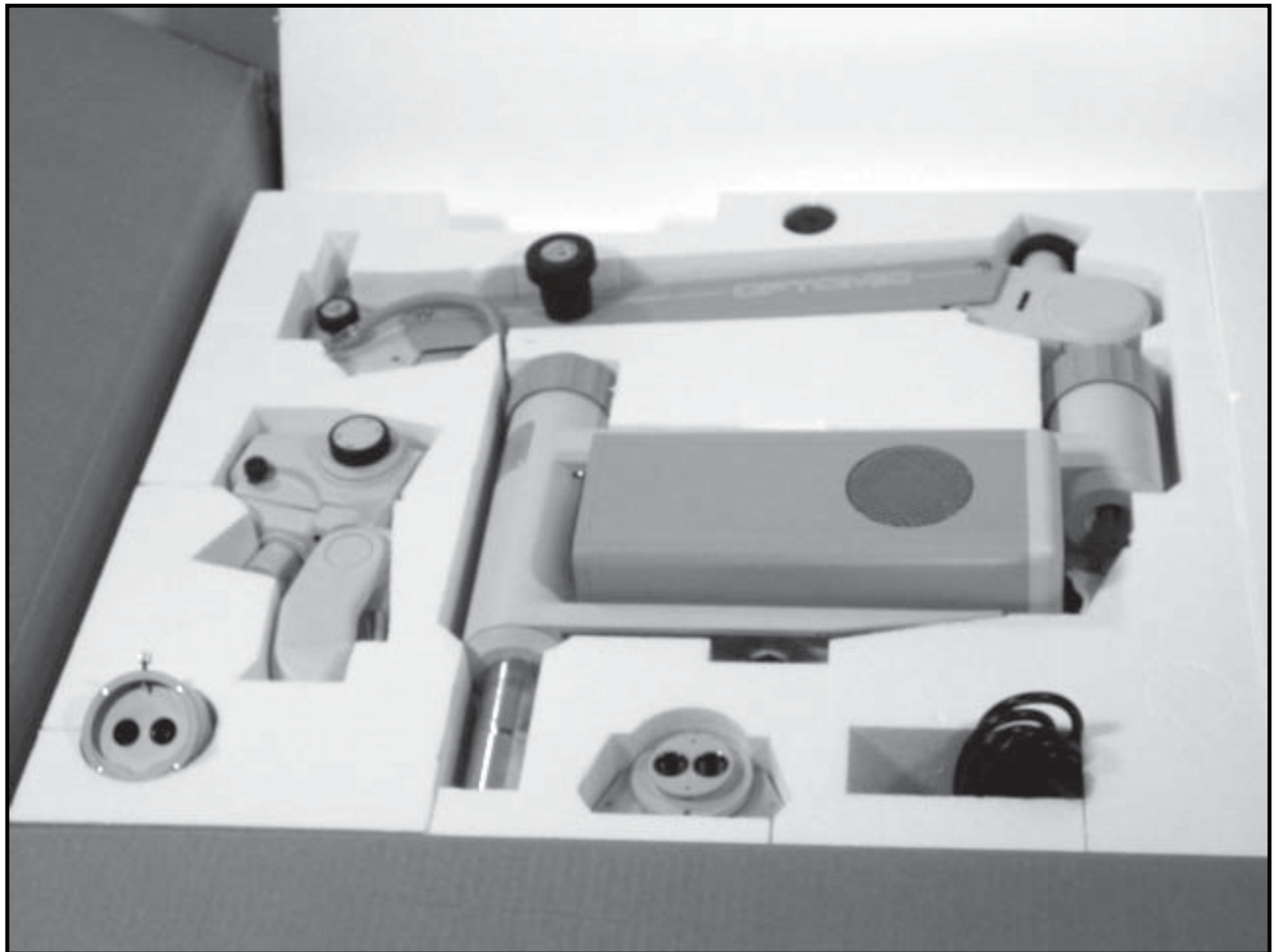

Fig. 2



IMPORTANT:
DO NOT CUT THE PLASTIC
SEAL UNTIL THE ARMS HAVE
BEEN PLACED UPON THE
STAND AND THE HEAD IN ITS
PLACE.



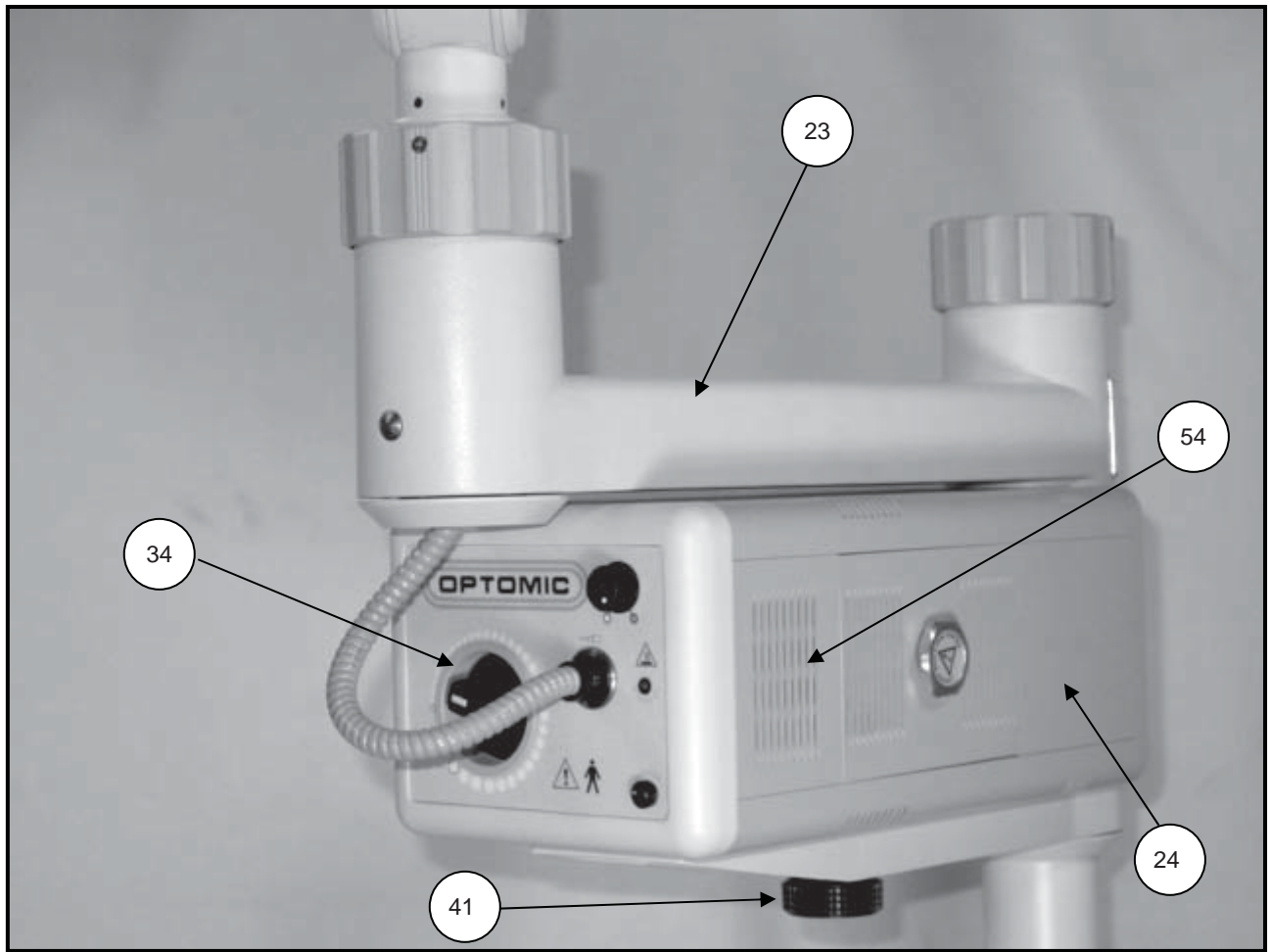

Fig. 3

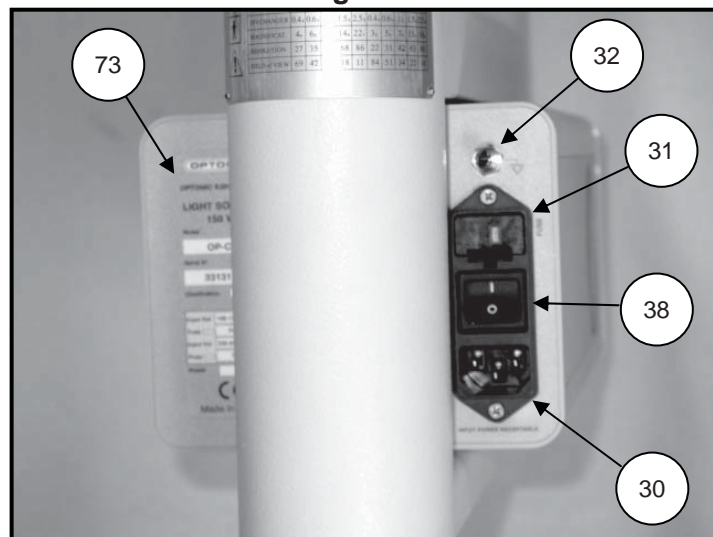

Fig. 4

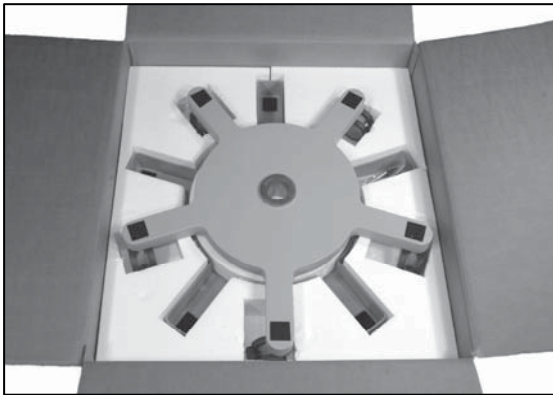

Fig. 5

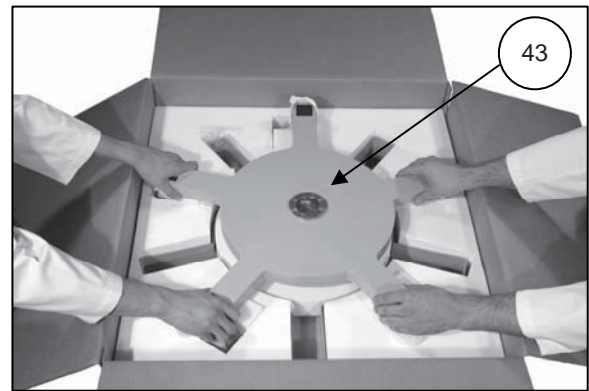

Fig. 6

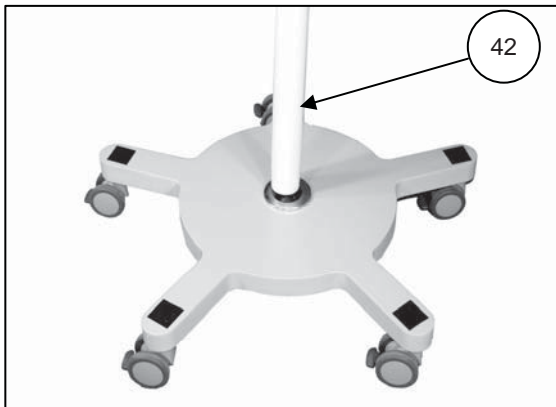

Fig. 7

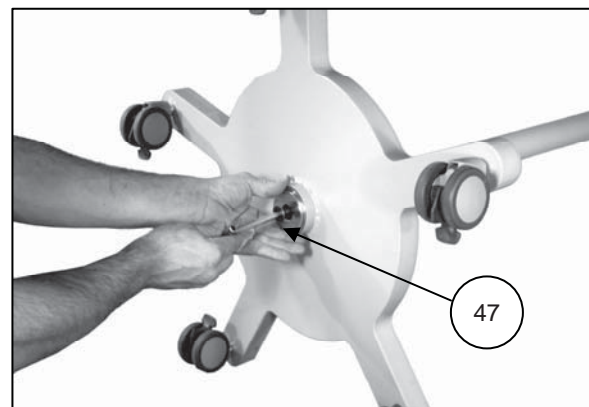

Fig. 8

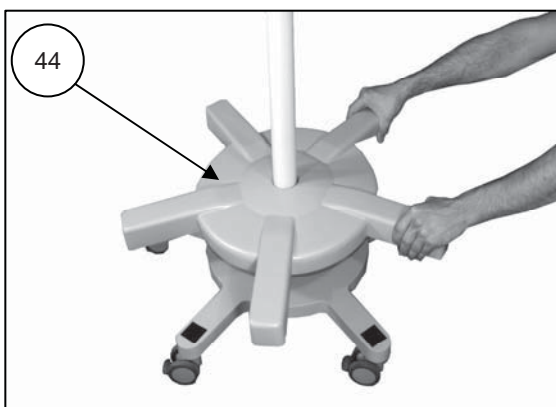

Fig. 9

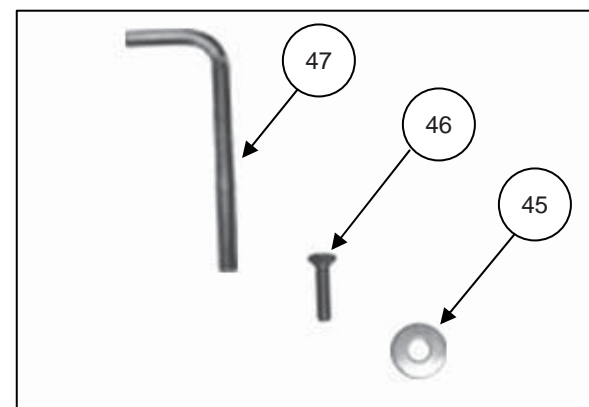

Fig. 10

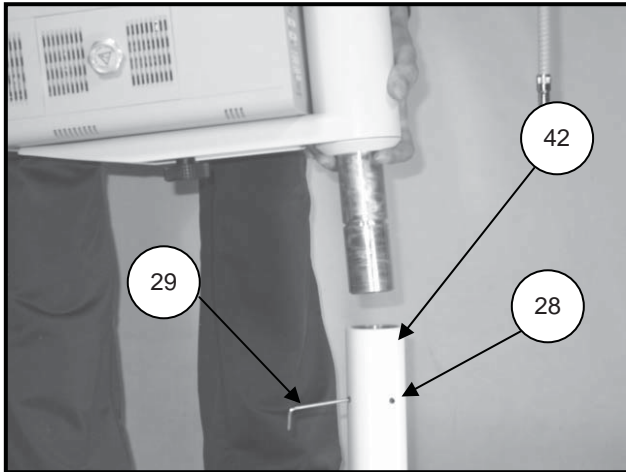

Fig. 11

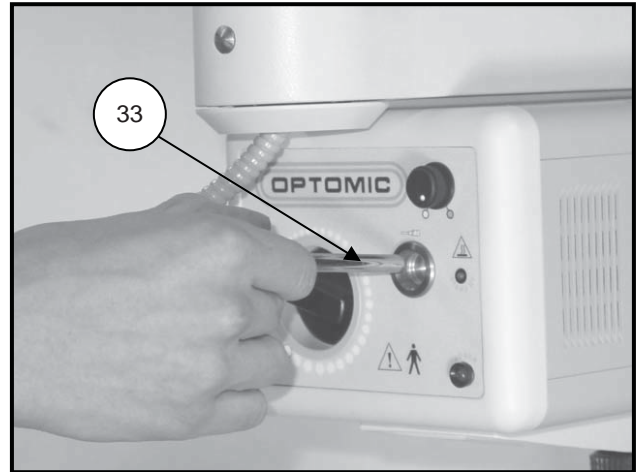

Fig. 12

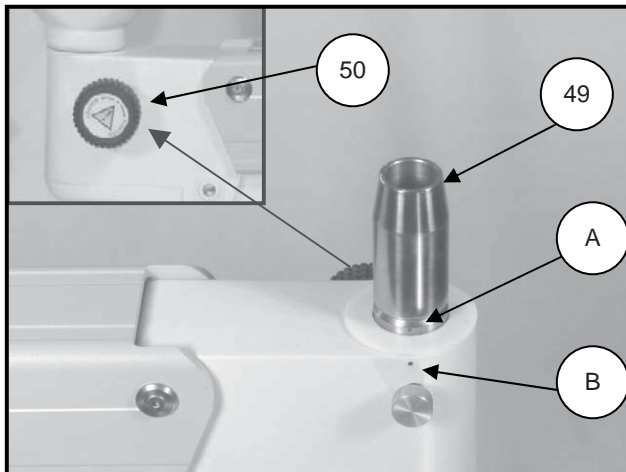

Fig. 13

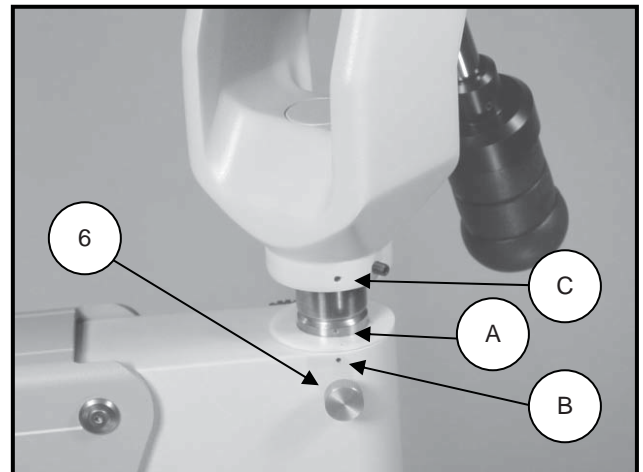

Fig. 14

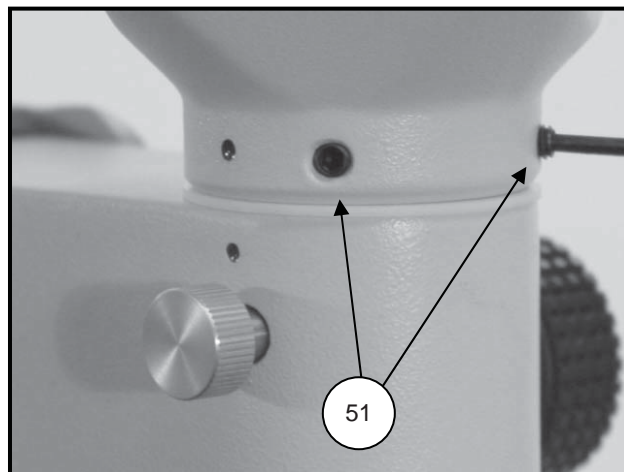

Fig. 15

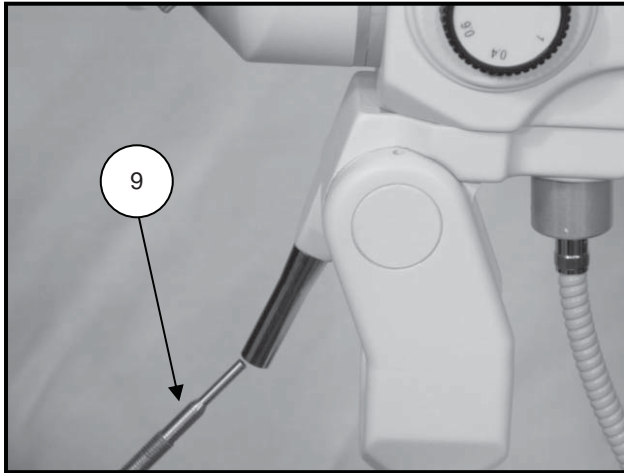

Fig. 16

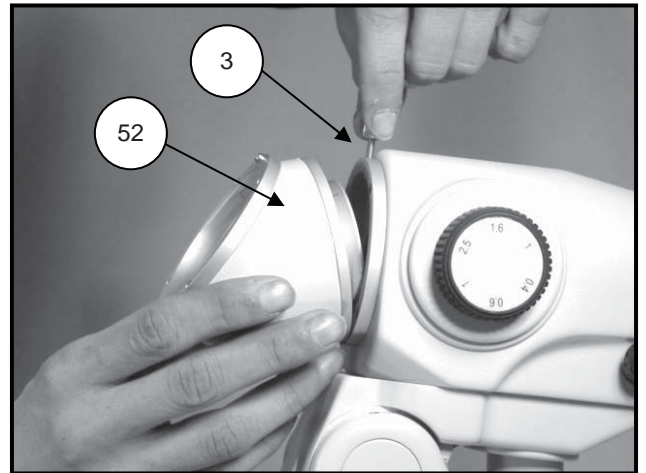

Fig. 17

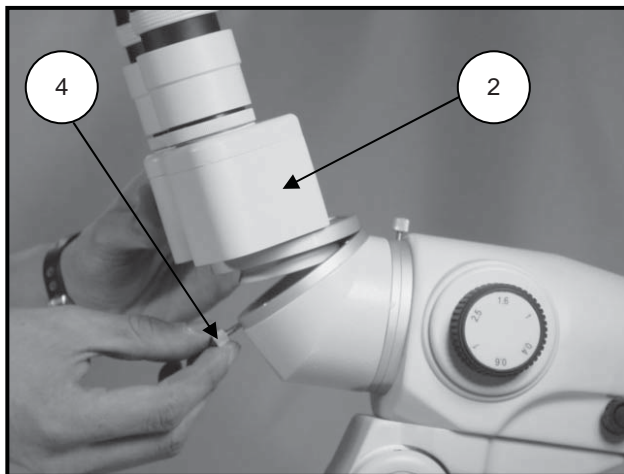

Fig. 18

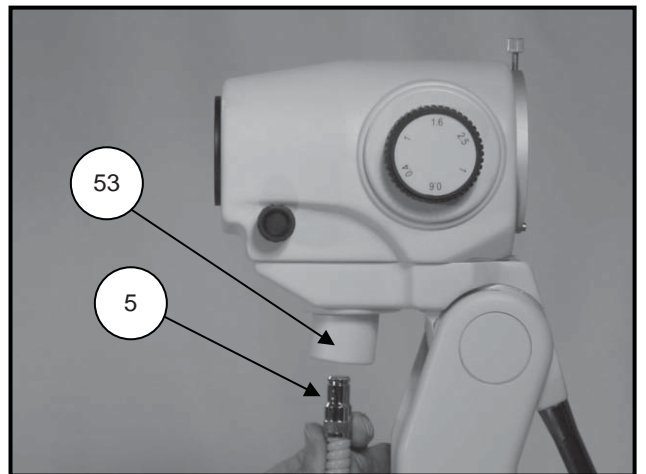

Fig. 19

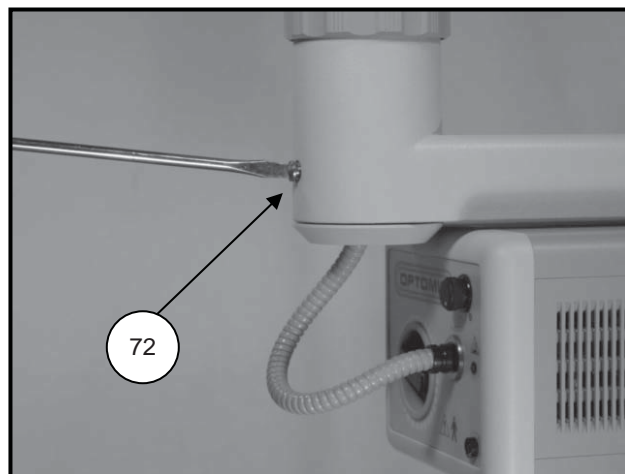

Fig. 20

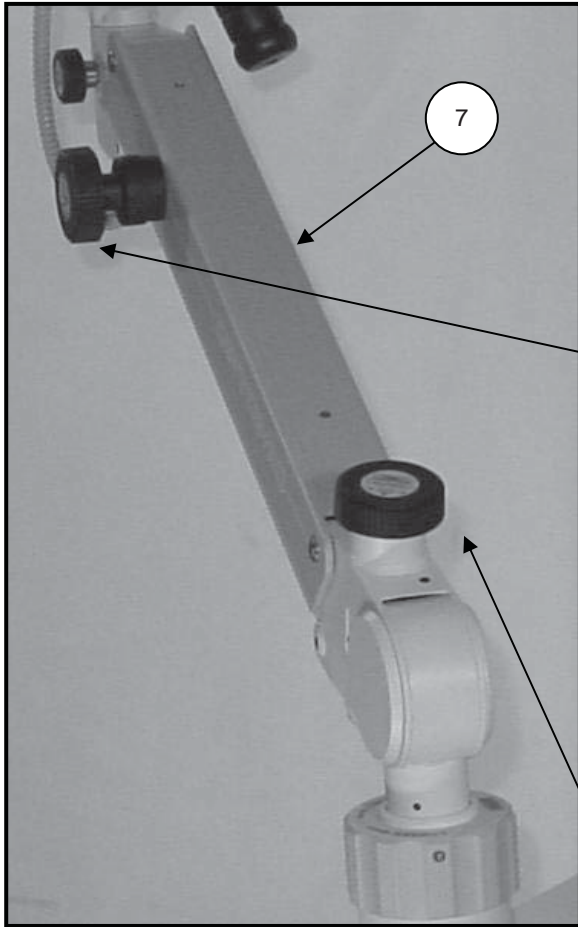

Fig. 21-22

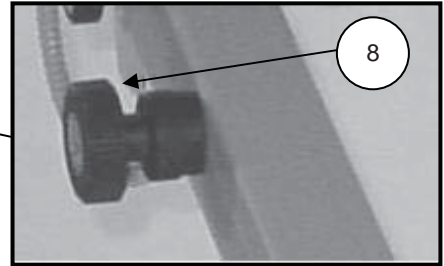

Fig. 21

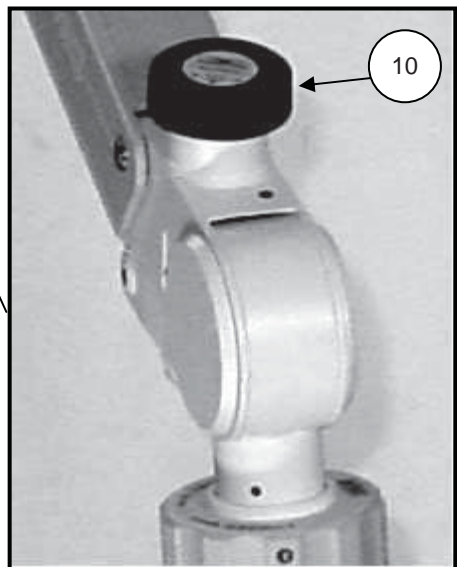

Fig. 22

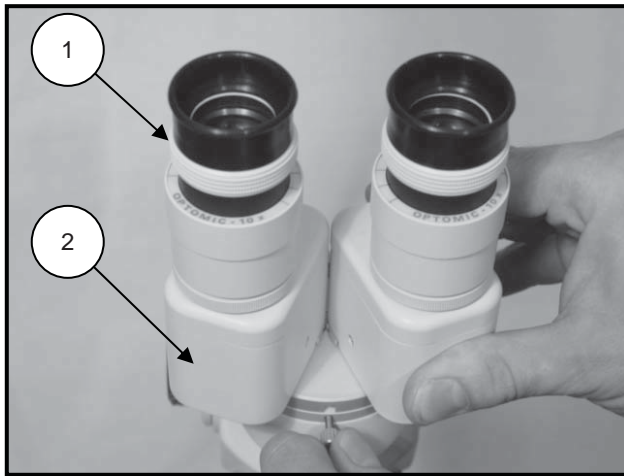

Fig. 23

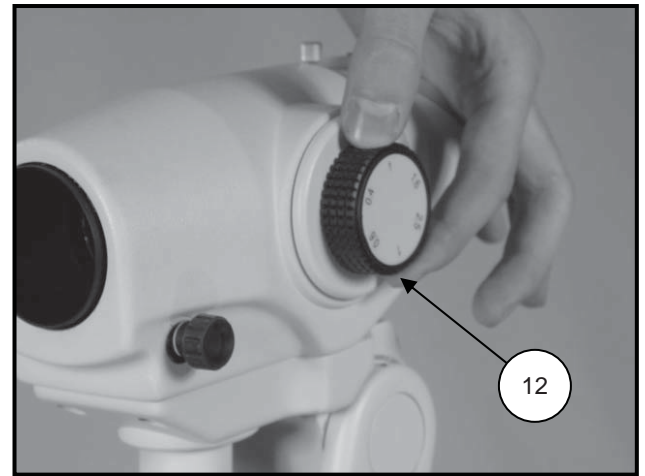

Fig. 24

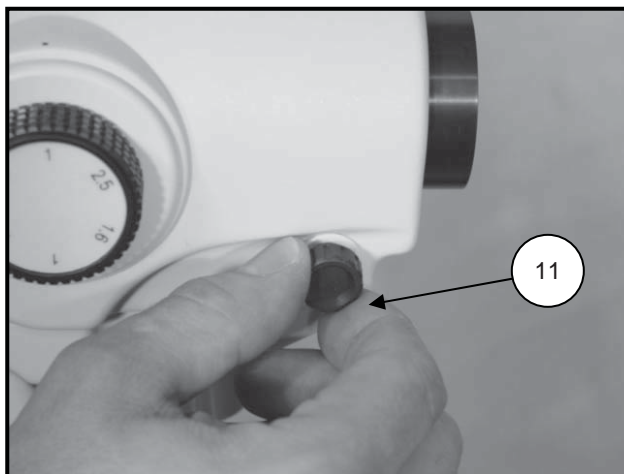

Fig. 25

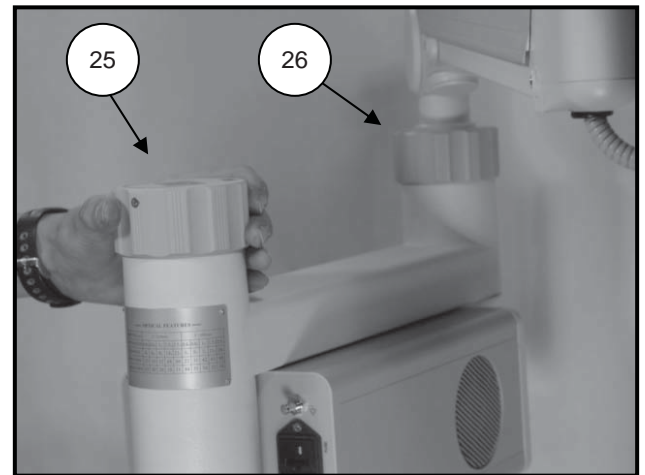

Fig. 26

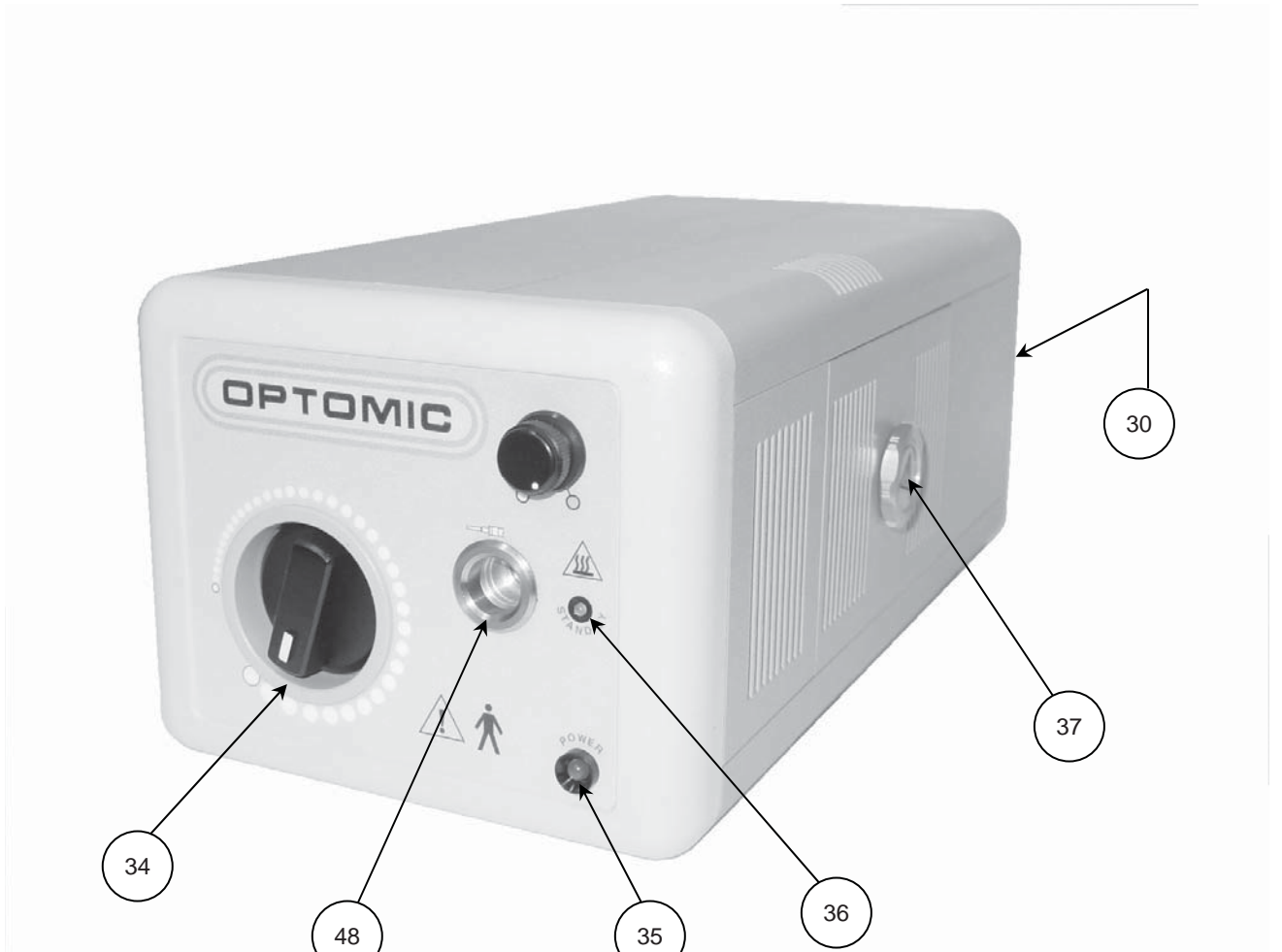

Fig. 27

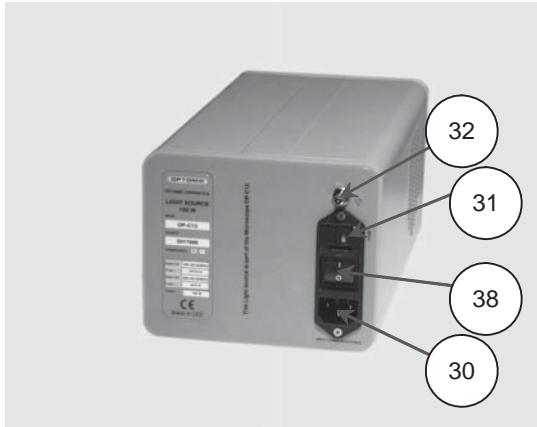

Fig. 28



Fig. 29



Fig. 30

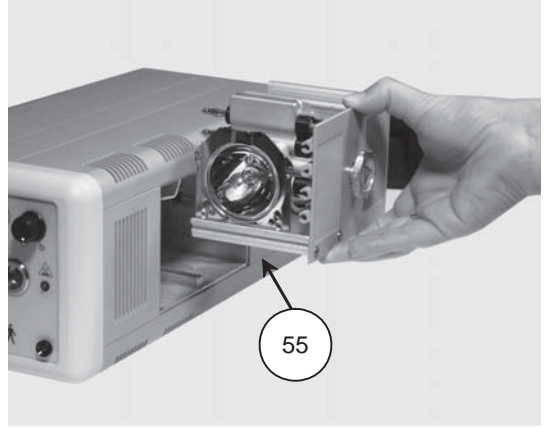

Fig. 31



Fig. 32

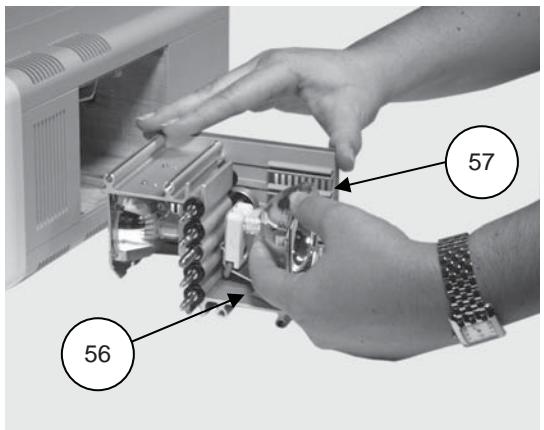

Fig. 33

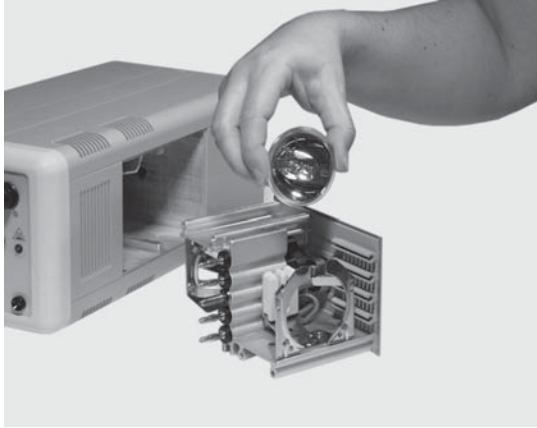

Fig. 34

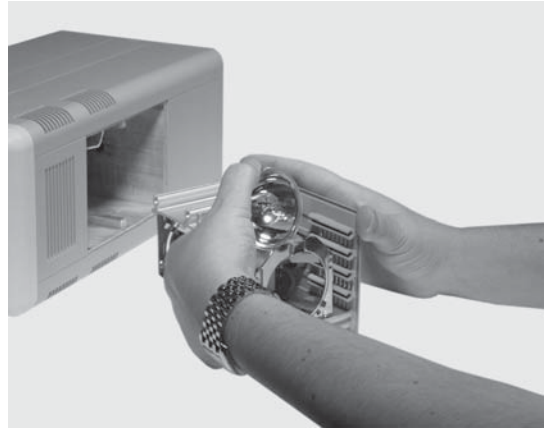

Fig. 35

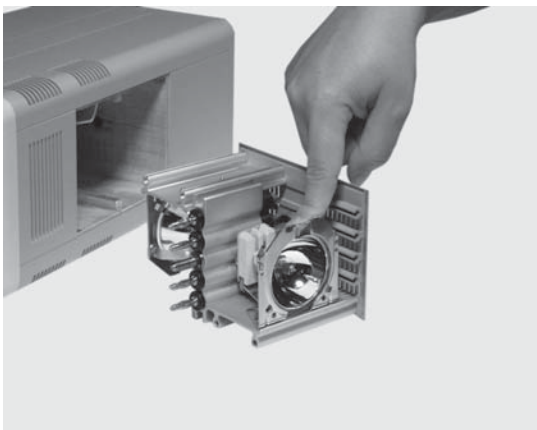

Fig. 36

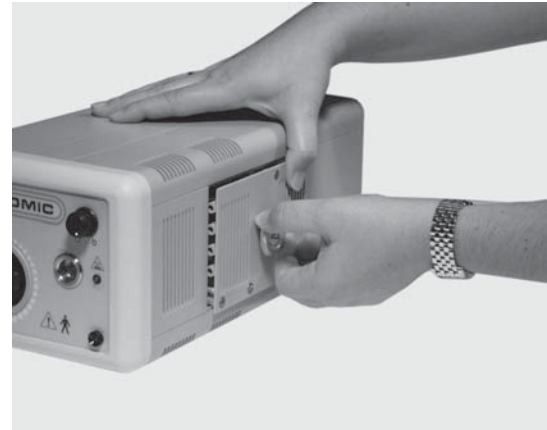

Fig. 37

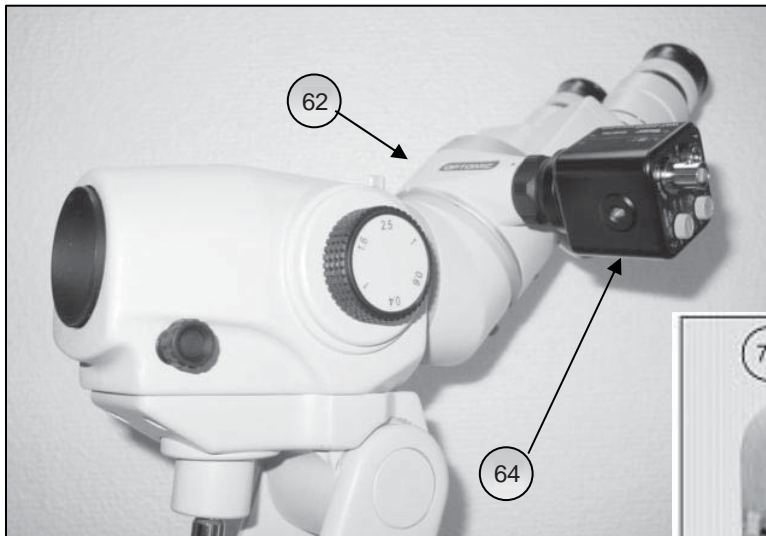

Fig. 38

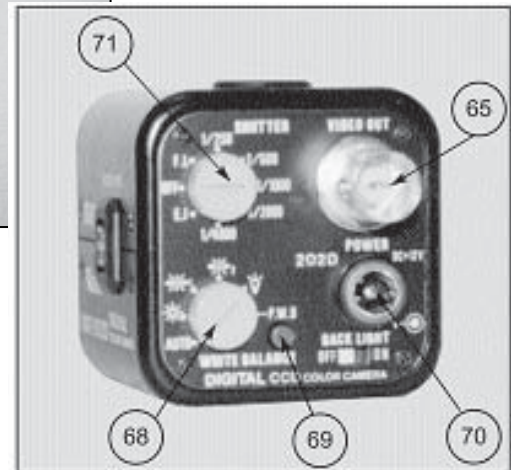

Fig. 39

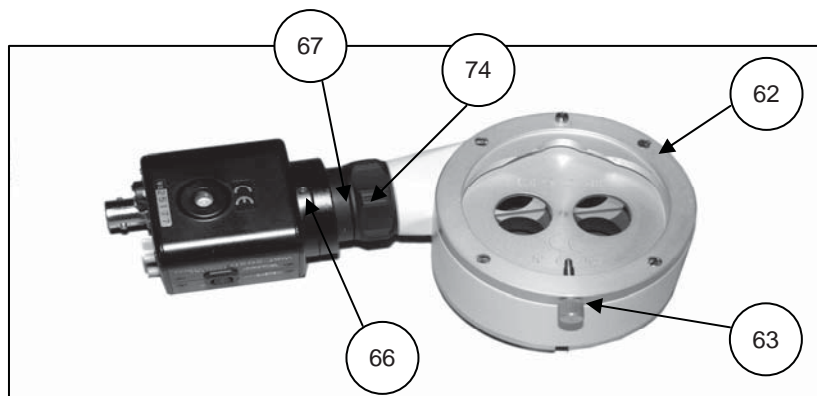

Fig. 40

16.- NOTES

Lined area for taking notes, consisting of multiple horizontal lines for writing.



producing quality

OPTOMIC ESPAÑA S.A.

C/ Madroño, 4 • 28770 Colmenar Viejo, Madrid. (Spain)

Tel: +34 902 22 11 77 • Fax: +34 902 22 11 78

mail@optomic.com • www.optomic.com



COLPOSCOPE OP-C5

THE BEST VISION IN COLPOSCOPY



- 5 different magnifications
- Smooth movement
- Complete braking system

OPTOMIC®
producing quality

The OP-C5 belongs to the top range of colposcopes manufactured by OPTOMIC. It meets the most demanding requirements, allowing the gynaecologist to carry out diagnosis and perform surgeries in the most reliable and accurate way.

COLPOSCOPE **OP-C5**



WIDE FIELD STEREOSCOPIC VISION



EXCEPTIONAL ILLUMINATION



OPTIONAL VIDEO SYSTEM

- Inclined stereoscopic binocular head, which can also be used as straight binocular tube.
- Adjustment of tightness of head and arm with possibility of complete braking.
- The arm is an autocompensated parallelogram which can be placed in any position.
- Very soft and smooth operation of all functions.
- Cold light sources of Halogen, Xenon or LED light; all with swing-in green filter.
- The light source can be removed for its use in other applications such as for example endoscopy, illumination for speculum or head lamp.
- High intensity fiber optic illumination.
- Wide field eyepieces with dioptric adjustment and protective rubber shells.
- 5 steps Galilei magnifications changer and micrometric focusing system.
- Working distance of 300mm with standard objective (f=250mm optional).
- Range of magnifications: 2.5x up to 27x, depending on the chosen combination of objective, binocular and eyepieces.
- Different floor and wall mounting options available.
- Adapter for CO2 laser micromanipulator available.
- Optional monitor supports and trays for laptop or CCD camera.
- Optional systems for video-colposcopy or digital photography.

OPTOMIC ESPAÑA S.A.

Madroño, 4. E-28770 Colmenar Viejo, Madrid, Spain
Tel: +34 902 22 11 77 / +34 91 803 57 14 • Fax: +34 902 22 11 78
export@optomic.com • www.optomic.com



Specifications are subject to change without notice

