



KNOCHENCHIRURGIE – BONE SURGERY

By

Fizza Surgical International



Amputations- und Resektionssägen
Amputating and resection saws
Scies à amputation et résection
Sierra para amputación y resección
Seghe per amputazione



CHARRIERE

350 mm – 13³/₄"

BS 14-10-01



12 mm

BS 14-10-02

15 mm

BS 14-10-03

Ersatzsägeblätter
Spare saw blades



**HELFERICH-
BIER**

390 mm – 15¹/₂"

BS 14-15-01



3 mm

BS 14-15-02

5 mm

BS 14-15-03

7 mm

BS 14-15-04

Ersatzsägeblätter
Spare saw blades

Amputations- und Resektionssägen
Amputating and resection saws
Scies à amputation et résection
Sierra para amputación y resección
Seghe per amputazione



1:2

SATTERLEE

310 mm – 12¹/₄"

BS 14-20-01



1:2

LANGENBECK

230 mm – 9"

BS 14-25-01



CHARRIERE

270 mm – 10³/₄"

BS 14-30-01

300 mm – 12"

BS 14-30-02

340 mm – 13¹/₂"

BS 14-30-03

Raspeln, Feilen
Rasps, files
Râpes, limes
Escofinas, limas
Raspe, lime

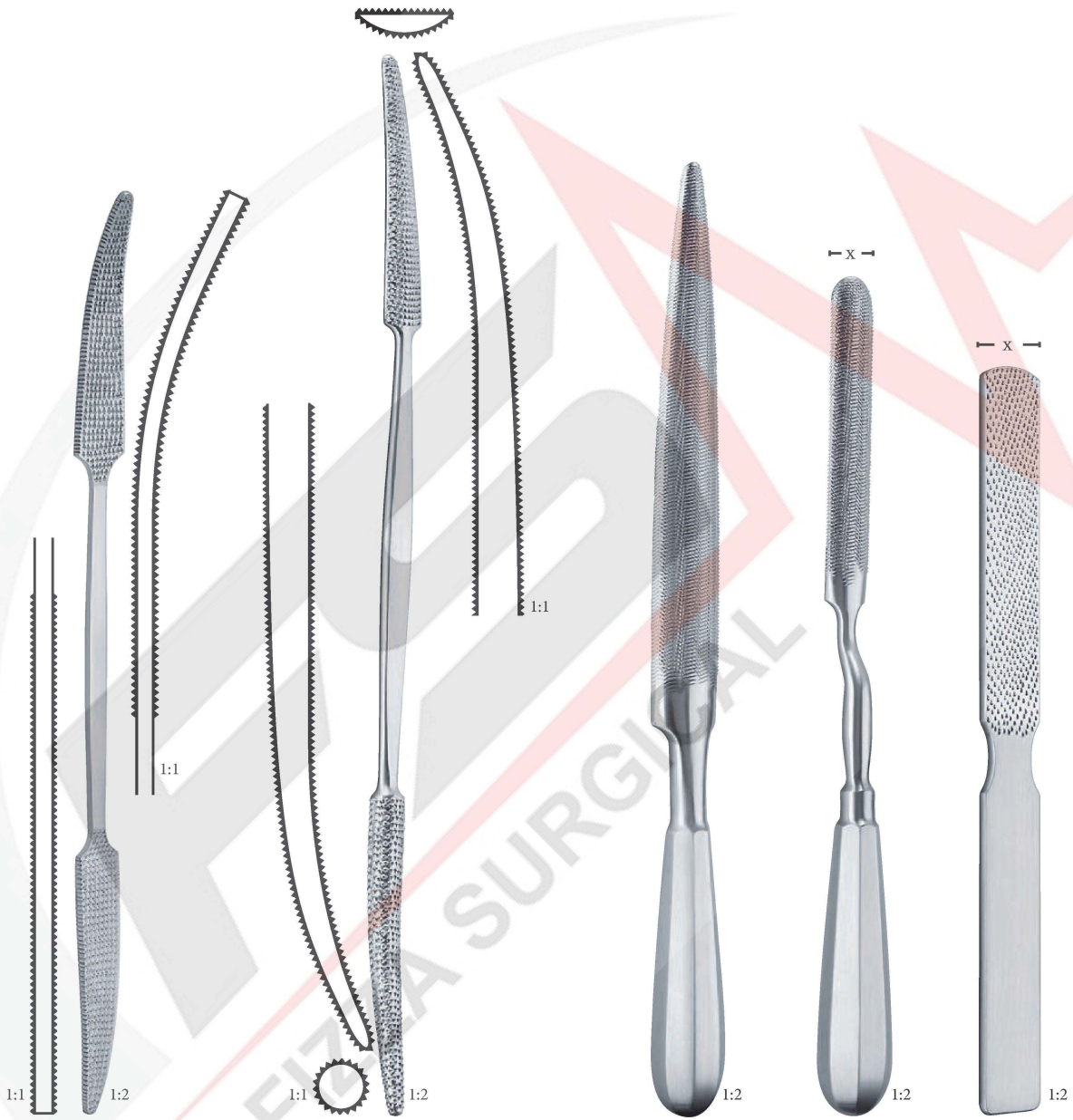

PUTTI

270 mm – 10 ³ / ₄ "	BS 14-31-01	BS 14-32-01
300 mm – 12"	BS 14-31-02	BS 14-32-02

280 mm – 11"	BS 14-35-01
--------------	-------------

halbrund
semicircular

245 mm – 9 ³ / ₄ "	x = 13 mm	BS 14-36-01
--	-----------	-------------

halbrund
semicircular

220 mm – 8 ³ / ₄ "	x = 20 mm	BS 14-37-01
--	-----------	-------------

flach
flat

Knochenmeißel
Ciseaux-burins, gouges
Cinceles, gubias
Scalpelli, sgorbi



LEXER

	220 mm – 8 ³ / ₄ "	300 mm – 12 "	220 mm – 8 ³ / ₄ "	300 mm – 12 "
5 mm	BS 14-240-01	BS 14-241-01	BS 14-242-01	
7 mm	BS 14-240-02	BS 14-241-02	BS 14-242-02	
10 mm	BS 14-240-03	BS 14-241-03	BS 14-242-03	
15 mm	BS 14-240-04	BS 14-241-04	BS 14-242-04	
20 mm	BS 14-240-05	BS 14-241-05	BS 14-242-05	
25 mm	BS 14-240-06	BS 14-241-06	BS 14-242-06	
30 mm	BS 14-240-07	BS 14-241-07	BS 14-242-07	

Ferrozell handle

MINI=LEXER

	180 mm – 7 "	180 mm – 7 "
4 mm	BS 14-245-01	BS 14-246-01
6 mm	BS 14-245-02	BS 14-246-02
8 mm	BS 14-245-03	BS 14-246-03
10 mm	BS 14-245-04	BS 14-246-04
12 mm	BS 14-245-05	BS 14-246-05

Ferrozell handle

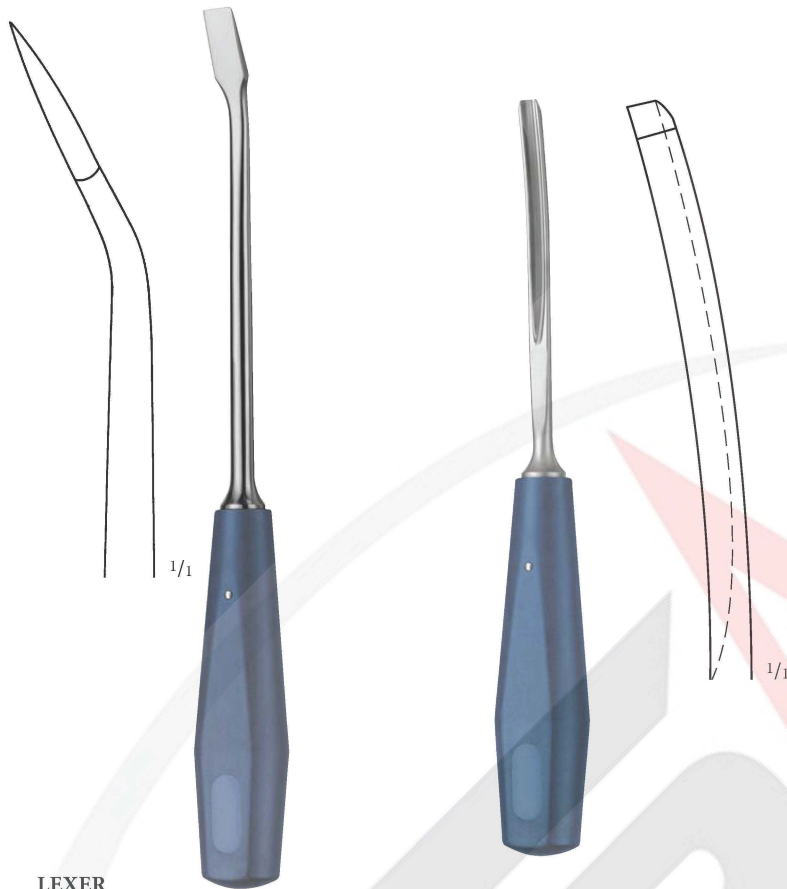

LEXER

	275 mm – 10 ³ / ₄ "
10 mm	BS 14-247-01
15 mm	BS 14-247-02

	250 mm – 10 "
5 mm	BS 14-248-01
10 mm	BS 14-248-02
15 mm	BS 14-248-03

Spongiosa-Hohlmeißel, gebogen

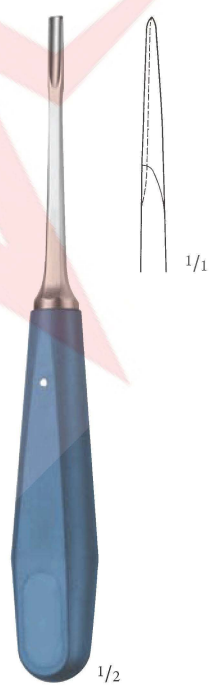
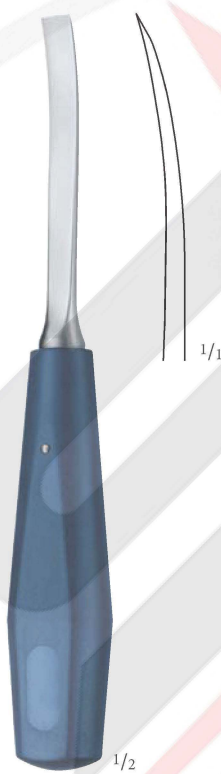

	200 mm – 8"
10 mm	BG 14-100-01
15 mm	BG 14-100-02
20 mm	BG 14-100-03

Flachmeißel
Chisels

	200 mm – 8"
10 mm	BG 14-105-01
15 mm	BG 14-105-02
20 mm	BG 14-105-03

Flachmeißel, gebogen
Chisels, curved

LEXER-MINI

	180 mm – 7"
4 mm	BG 14-110-01
6 mm	BG 14-110-02
8 mm	BG 14-110-03
10 mm	BG 14-110-04
12 mm	

Osteotome
Osteotomes

LEXER-MINI

	180 mm – 7"
4 mm	BG 14-115-01
6 mm	BG 14-115-02
8 mm	BG 14-115-03
10 mm	BG 14-115-04
12 mm	BG 14-115-05

Hohlmeißel
Gouges



LEXER

	220 mm – 8 ³ / ₄ "
5 mm	BG 14-220-01
7 mm	BG 14-220-02
10 mm	BG 14-220-03
15 mm	BG 14-220-04
20 mm	BG 14-220-05
25 mm	BG 14-220-06
30 mm	BG 14-220-07

Osteotome
Osteotomes

LEXER

	220 mm – 8 ³ / ₄ "
5 mm	BG 14-225-01
7 mm	BG 14-225-02
10 mm	BG 14-225-03
15 mm	BG 14-225-04
20 mm	BG 14-225-05
25 mm	BG 14-225-06
30 mm	BG 14-225-07

Hohlmeißel
Gouges

	220 mm – 8 ³ / ₄ "
9 mm	BG 14-230-01

Hohlmeißel zum
Freilegen abgebrochener
Schrauben Gouge for
excavating broken screws

ZIELKE

	230 mm – 9"
5.5 mm	BG 14-230-01
9.0 mm	BG 14-230-02

**Knochenmeißel
Ciseaux-burins, gouges
Cinceles, gubias
Scalpelli, sgorbi**



STILLE



	205 mm – 8"	200 mm – 8"	205 mm – 8"	205 mm – 8"
10 mm	BS 14-250-01		BS 14-251-01	BS 14-251-06
15 mm	BS 14-250-02	BS 14-250-06	BS 14-251-02	BS 14-251-07
20 mm	BS 14-250-03		BS 14-251-03	
25 mm	BS 14-250-04		BS 14-251-04	
12 mm	BS 14-250-05		BS 14-251-05	

1:2

Thin



**SMITH -
PETERSEN**



	200 mm – 8"	200 mm – 8"	200 mm – 8"	200 mm – 8"
6 mm	BS 14-255-01	BS 14-256-01	BS 14-257-01	BS 14-258-01
9 mm	BS 14-255-02	BS 14-256-02	BS 14-257-02	BS 14-258-02
13 mm	BS 14-255-03	BS 14-256-03	BS 14-257-03	BS 14-258-03
16 mm	BS 14-255-04	BS 14-256-04	BS 14-257-04	BS 14-258-04
19 mm	BS 14-255-05	BS 14-256-05	BS 14-257-05	BS 14-258-05
25 mm	BS 14-255-06	BS 14-256-06	BS 14-257-06	BS 14-258-06
32 mm	BS 14-255-07	BS 14-256-07	BS 14-257-07	BS 14-258-07

1:2

Hohlmeißelzangen
Pinces gouges
Pinzas gubias
Pinze sgorbie



OLIVECRONA
205 mm - 8"
BS 14-785-01

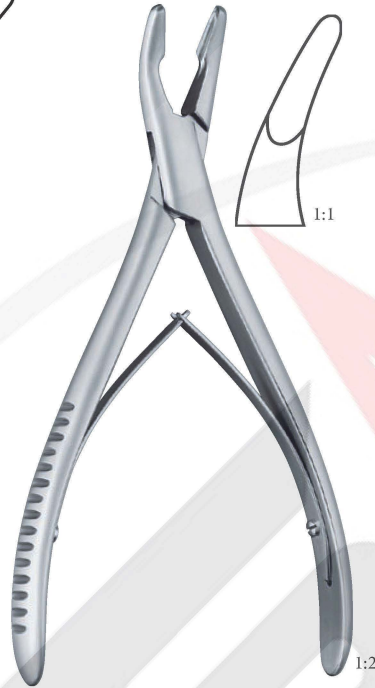

HARTMANN
175 mm - 7"
BS 14-790-01



MEAD
165 mm - 6 1/2"
BS 14-795-01



Cleveland
170 mm - 6 3/4"
BS 14-800-01

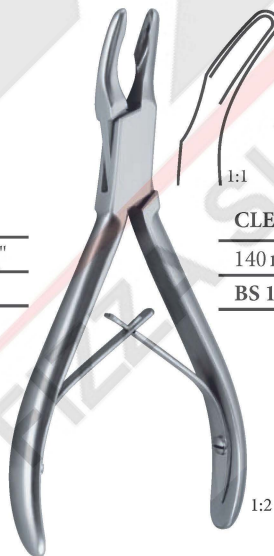

CLEVELAND
140 mm - 5 1/2"
BS 14-805-01



BOHLER
150 mm - 6" BS 14-810-01

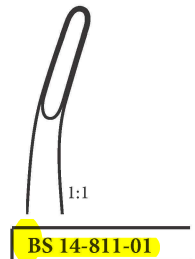

BS 14-811-01

Hohlmeißelzangen
Pinces gouges
Pinzas gubias
Pinze sgorbie

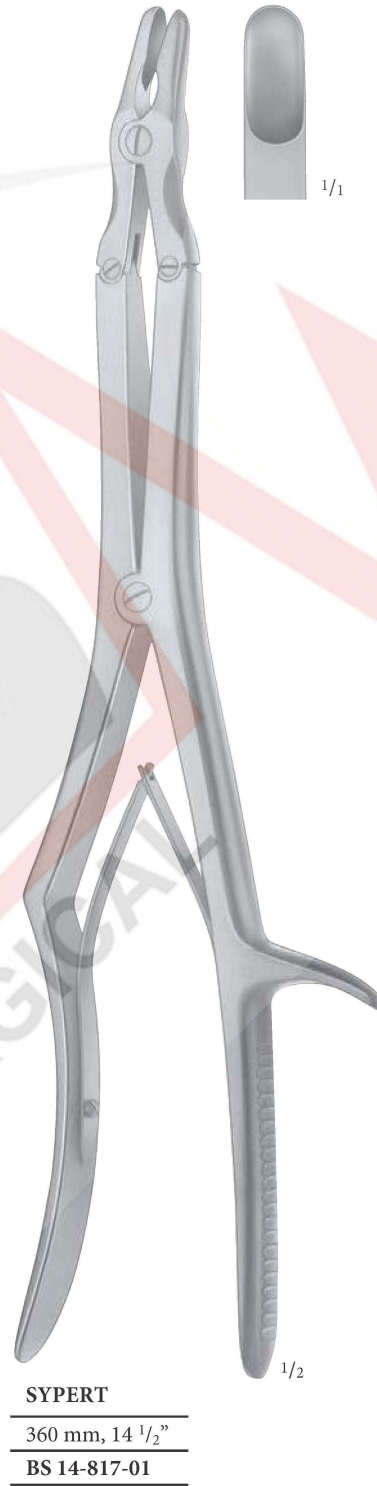
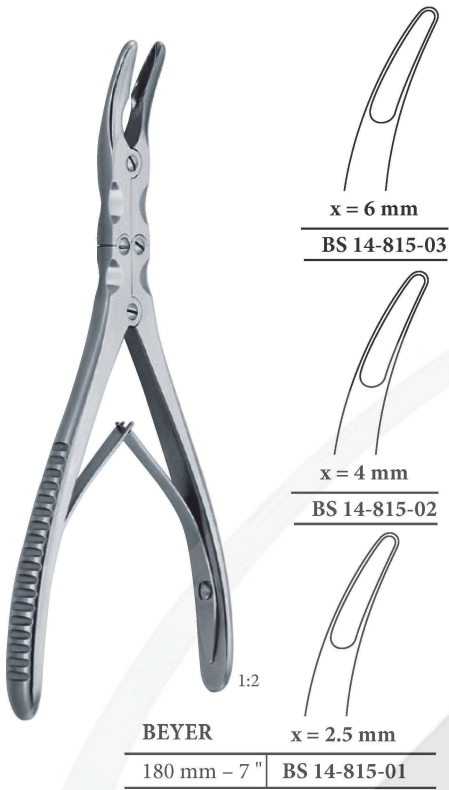



RUSKIN
180 mm - 7" | **BS 14-820-01**

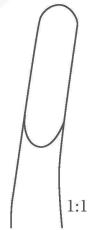
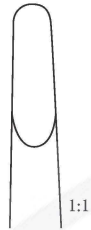

BS 14-821-01

1:2



MAYFIELD
175 mm - 7" | **BS 14-825-01**



1:2



ZAUFAL-JANSEN
180 mm - 7" | **BS 14-830-01**



1:2



MARQUARDT
200 mm - 8" | **BS 14-835-01**



1:2

Hohlmeißelzangen
 Pinces gouges
 Pinzas gubias
 Pinze sgorbie



**STILLÉ-
 RUSKIN**

230 mm - 9" **BS 14-840-01**



BS 14-841-01

1:2



STILLÉ



4 mm

230 mm - 9" **BS 14-845-01**



6 mm

BS 14-845-02



8 mm

BS 14-845-03

1:2



LEKSELL

240 mm - 9 1/2" **BS 14-850-01**

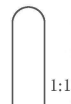

6 mm

BS 14-850-02



8 mm

BS 14-850-03

1:2



STILLÉ-LUER

220 mm - 8 3/4" **BS 14-855-01**

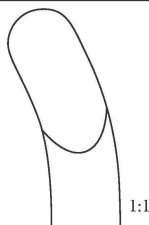
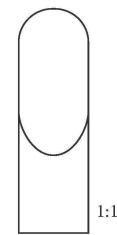

BS 14-856-01

1:2

Hohlmeißelzangen
Pinces gouges
Pinzas gubias
Pinze sgorbie



ROTTGEN-RUSKIN
230 mm - 9"
BS 14-860-01

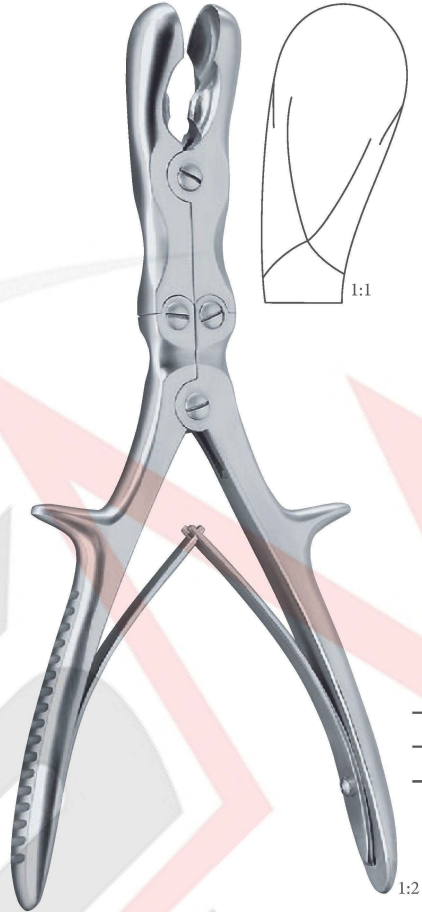

SEMB
240 mm - 9 1/2"
BS 14-865-01



ECHLIN
230 mm - 9" | BS 14-870-01

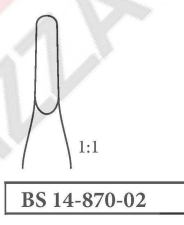

FRYKHOLM
240 mm - 9 1/2"
BS 14-875-01

Hohlmeißelzangen
 Pinces gouges
 Pinzas gubias
 Pinze sgorbie

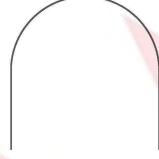

SAUERBRUCH		
	1:1	1:1
	Fig. 1	Fig. 2
300 mm – 12"	BS 14-880-01	BS 14-881-01

1:2

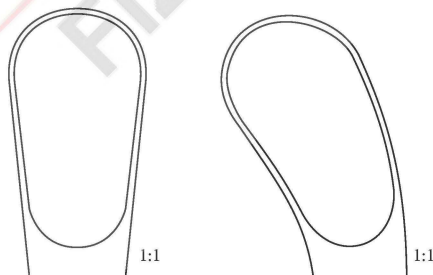

LUER- STILLE	1:1	1:1
270 mm – 10 ³ / ₄ "	BS 14-885-01	BS 14-886-01



1:2

**Knochensplitterzangen
Pincas coupantes à os Pinzas
cortantes para huesos Cesoié
per ossa**



**COTTLE-
KAZANJIAN**

190 mm - 7 1/2"
BS 14-890-01



LISTON

140 mm - 5 1/2"	BS 14-895-01	BS 14-896-01
170 mm - 6 3/4"	BS 14-895-02	BS 14-896-02
190 mm - 7 1/2"	BS 14-895-03	BS 14-896-03
220 mm - 8 3/4"	BS 14-895-04	BS 14-896-04

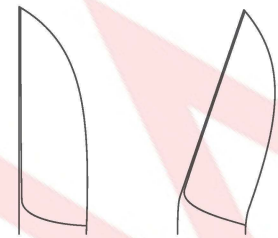

RIBS SHEAR

230mm - 9"

BS 14-897-01



GLUCK

190mm - 7 1/2"

BS 14-897-02



BETHUNE

190mm - 7 1/2"

BS 14-898-01



specially hardened cutting edges

HARVEY

235 mm, 9 1/4"

BC 14-100-01

for soft wire up to diam. 3.0 mm
for hard wire up to 2.2 mm
diam.



specially hardened cutting edges

235 mm, 9 1/4"

BC 14-105-01

for soft wire up to diam. 3.0 mm
for hard wire up to 2.2 mm
diam.

FIZZA SURGICAL

Knochensplitterzangen
Pinces coupantes à os
Pinzas cortantes para huesos
Cesoie per ossa



BOHLER

150 mm - 6 "



BS 14-900-01

BS 14-901-02

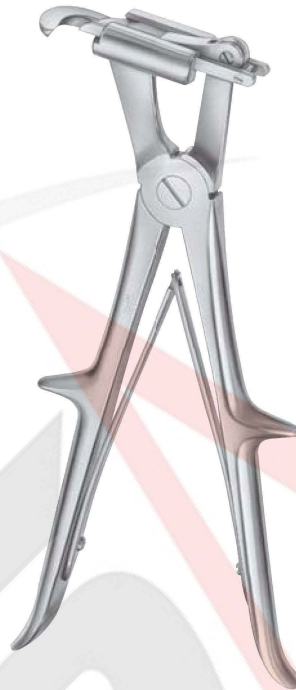

SAUERBRUCH

240 mm, 9 1/2"

BS 14-901-01

270 mm, 10 3/4"

BS 14-901-02



BRUNNER

340 mm, 13 1/2"

BS 14-902-01

Universal modell

Universal pattern

Knochensplitterzangen
Pinces coupantes à os
Pinzas cortantes para huesos
Cesoie per ossa



GIERTZ-STILLE

250 mm, 10"

BS 14-903-01

1/3



LISTON-STILLE

265 mm, 10 1/2"

BS 14-904-01

Knochensplitterzange
 Bone cutting forceps

1/3

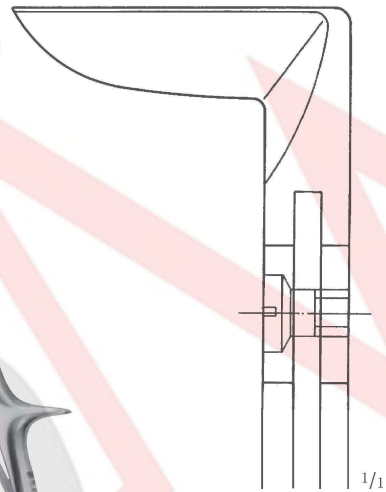

1/1



RUSKIN- LISTON

185 mm – 7 1/4"

BS 14-905-01

BS 14-906-01

1:2

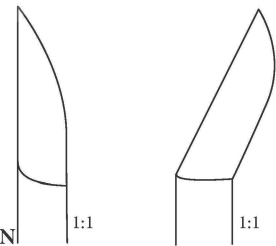

1:1

1:1

Knochensplitterzangen
Pinces coupantes à os **Pinzas**
cortantes para huesos **Cesoie**
per ossa



SEMB
 240 mm – 9 1/2"
 BS 14-910-01



LISTON-KEY HORSLEY
 255 mm, 10"
 BS 14-915-01



STILLE-LISTON

270 mm – 10 3/4"

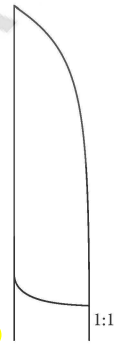

BS 14-920-01



BS 14-921-01

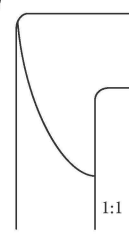

BS 14-922-01

Knochenhaltezaugen
Daviers porte-os
Pinzas para huesos
Tenaglie per ossa



FARABEU

230 mm - 9"	BS 14-970-01
260 mm - 10 ¹ / ₄ "	BS 14-970-02



FARABEU - LAMBOTTE

260 mm - 10 ¹ / ₄ "
BS 14-975-01

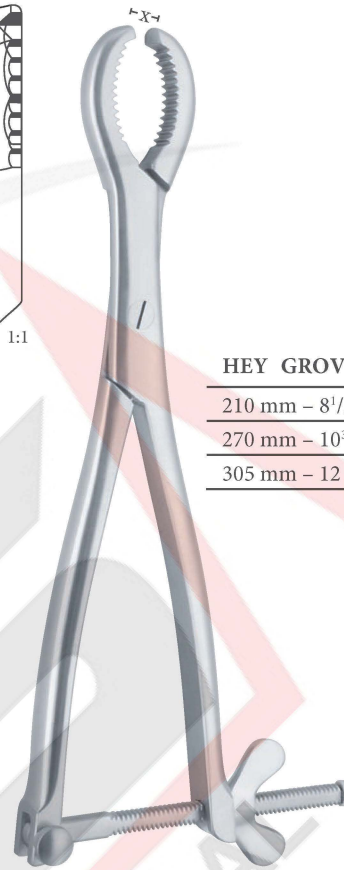

HEY GROVES

210 mm - 8 ¹ / ₄ "	x = 6.5 mm	BS 14-980-01
270 mm - 10 ³ / ₄ "	x = 7.5 mm	BS 14-980-02
305 mm - 12"	x = 8.5 mm	BS 14-980-03



BIRCHER - GANSKE

200 mm - 8"	BS 14-985-01	BS 14-986-01
-------------	--------------	--------------





MARTIN

190 mm - 7 ¹ / ₂ "
BS 14-990-01

Knochenhalte­zangen
Daviers porte-os
Pinzas para huesos
Tenaglie per ossa

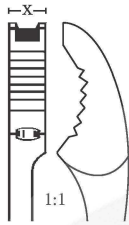
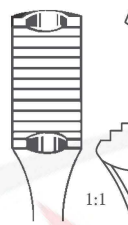

VERBRUGGE				
	175 mm - 7"	250 mm - 10"	260 mm - 10 ¹ / ₄ "	270 mm - 10 ³ / ₄ "
	x = 5.0 mm	x = 9.5 mm	x = 10.5 mm	x = 12.0 mm
	BS 14-991-01	BS 14-991-02	BS 14-991-03	BS 14-991-04



KERN

170 mm - 6 ³ / ₄ "	BS 14-992-01	BS 14-993-01
210 mm - 8 ¹ / ₄ "	BS 14-992-02	BS 14-993-02

Knochenhaltezaugen
Daviers porte-os
Pinzas para huesos
Tenaglie per ossa

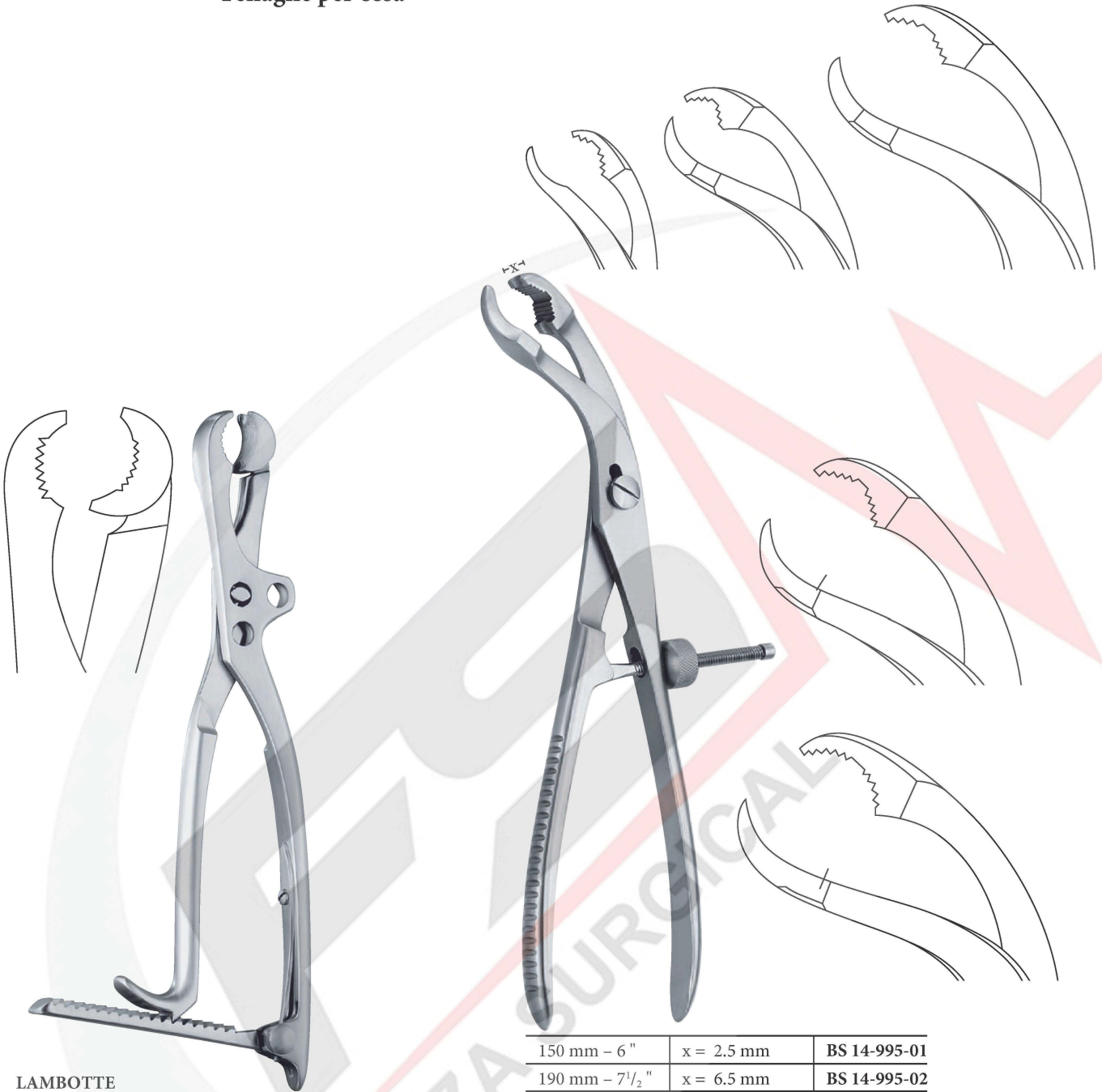

LAMBOTTE		
220 mm - 8 ³ / ₄ "	BS 14-993-01	BS 14-994-01
270 mm - 10 ³ / ₄ "	BS 14-993-02	BS 14-994-02
300 mm - 12 "	BS 14-993-03	BS 14-994-03

One Jaw Mobile

Angled

150 mm - 6 "	x = 2.5 mm	BS 14-995-01
190 mm - 7 ¹ / ₂ "	x = 6.5 mm	BS 14-995-02
240 mm - 9 ¹ / ₂ "	x = 9.5 mm	BS 14-995-03
260 mm - 10 ¹ / ₄ "	x = 10mm	BS 14-995-04
280 mm - 11 "	x = 11mm	BS 14-995-05

Self-Centering

Knochenhaltezaugen
Daviers porte-os
Pinzas para huesos
Tenaglie per ossa



LANE

330 mm – 13 "	BS 14-996-01	BS 14-997-01
450 mm – 17 ³ / ₄ "	BS 14-996-02	BS 14-997-02

Knochenhaltezangen
Daviers porte-os
Pinzas para huesos
Tenaglie per ossa

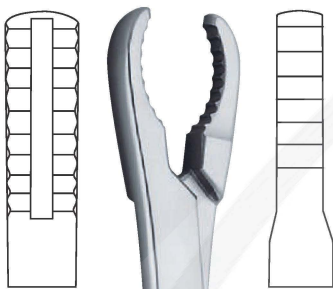

ULRICH

180mm - 7"	BS 14-998-01	BS 14-999-01
210mm - 8 1/4"	BS 14-998-02	BS 14-999-02
220 mm - 8 2/3"	BS 14-998-03	BS 14-999-03
230mm - 9"	BS 14-998-04	BS 14-999-04
250 mm - 9 3/4"	BS 14-998-05	BS 14-999-05
280 mm - 11 "	BS 14-998-06	BS 14-999-06

Angular

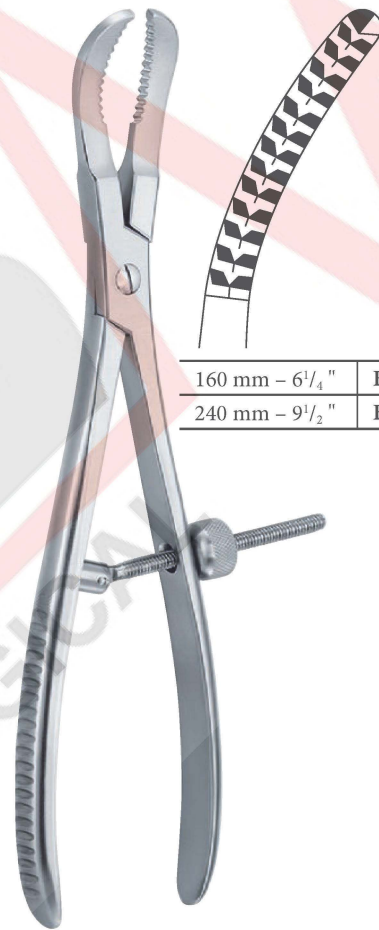

160 mm - 6 1/4"	BS 14-1000-01
240 mm - 9 1/2"	BS 14-1000-02

**Knochenhaltezangen – Repositionszangen
Daviers porte-os – Pinces de reposition Pinzas
para huesos – Pinzas para reposición Tenaglie
per ossa – Pinze per riposizione**

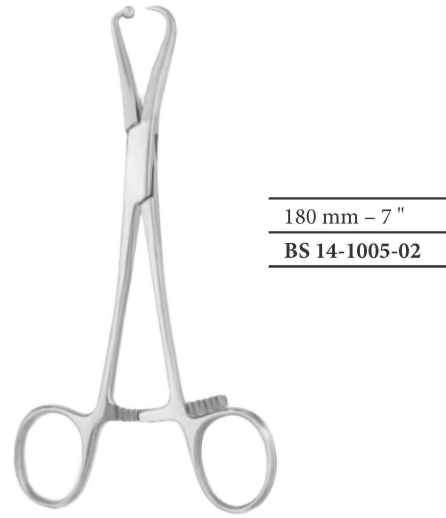
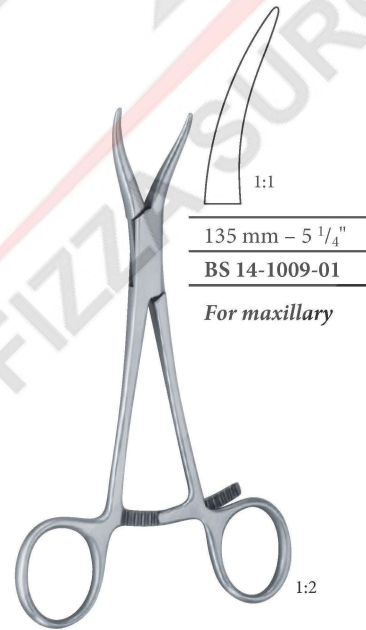
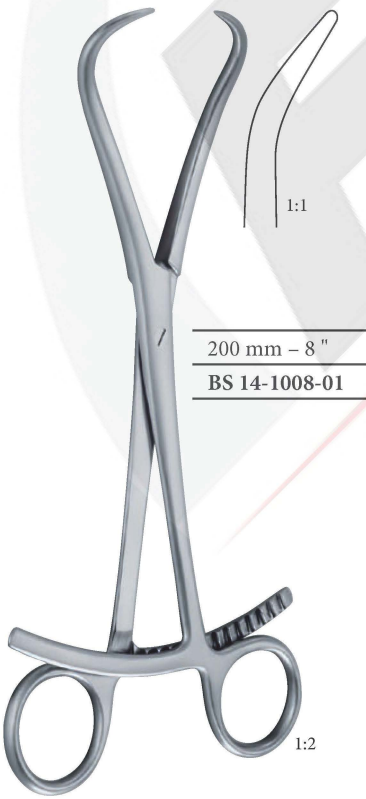
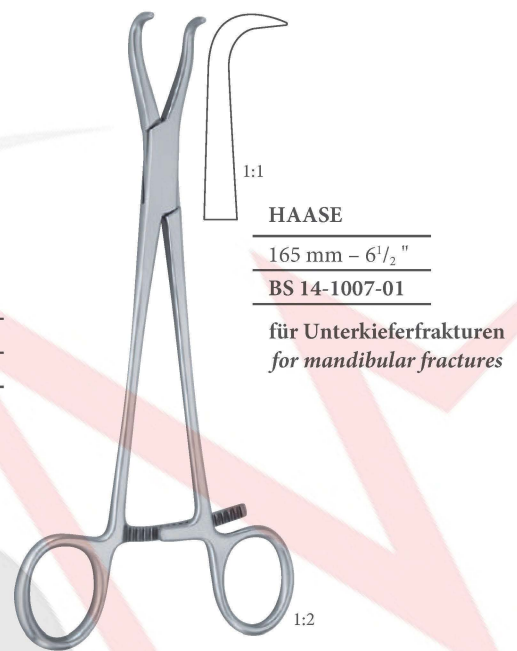
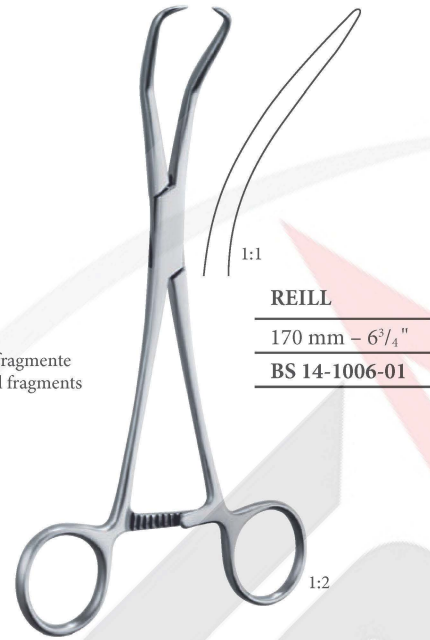
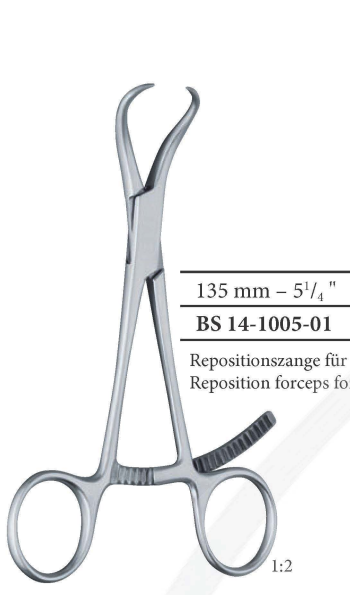

Draht-Instrumentarium
Instruments pour cerclage
Instrumental para cerclaje
Strumenti per filo di cerchiaggio

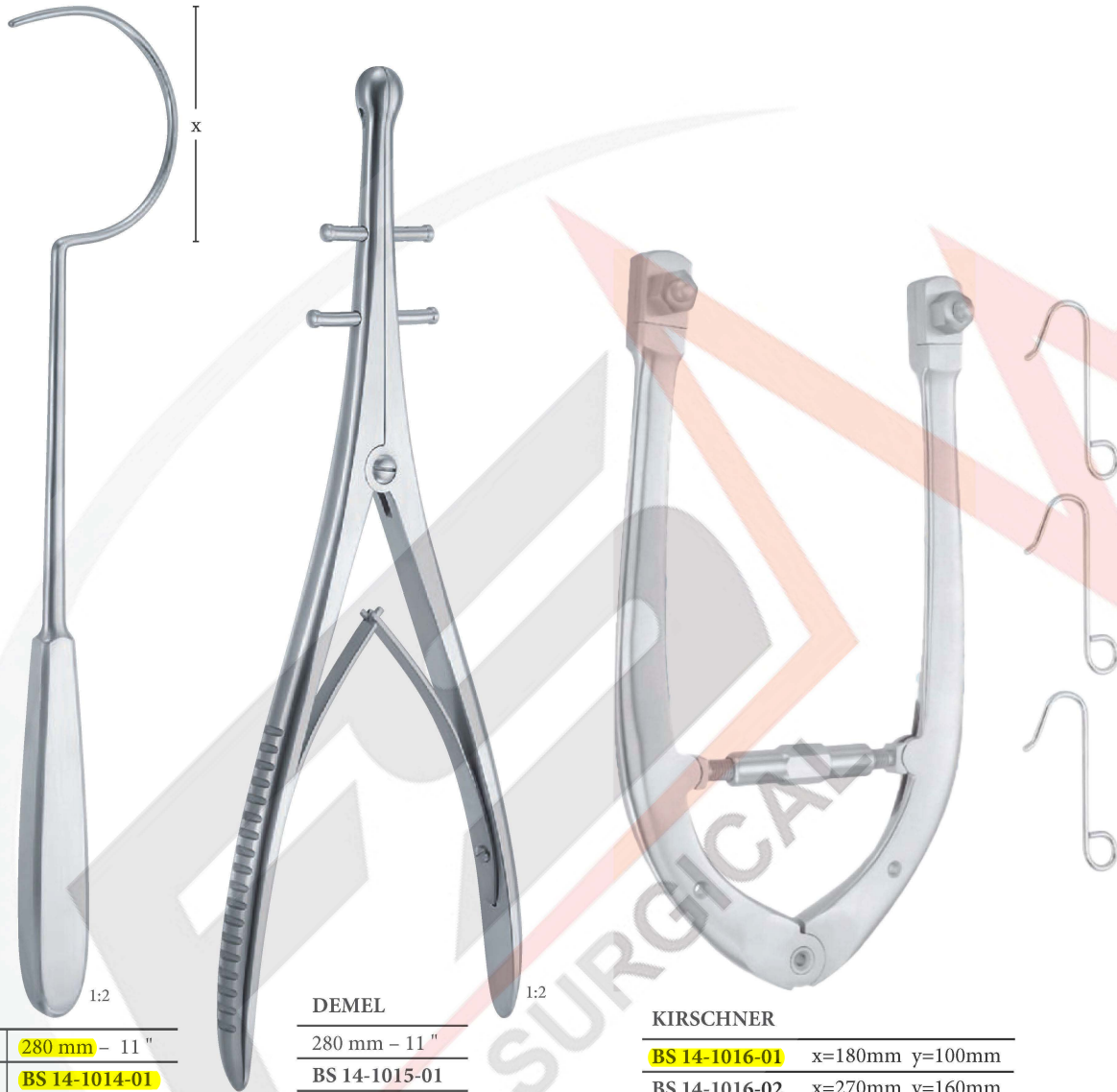

DEMEL

	280 mm – 11"
x = 32 mm	BS 14-1014-01
x = 45 mm	BS 14-1014-02
x = 62 mm	BS 14-1014-03

DEMEL

280 mm – 11"
BS 14-1015-01

KIRSCHNER

BS 14-1016-01	x=180mm y=100mm
BS 14-1016-02	x=270mm y=160mm

with 3 traction hooks
 mit 3 Zughaken
 con 3 crochets d'attelage
 con 3 ganci di trazione

**Drahtschneidezangen Pincers
coupantes
Alicates para cortar alambre
Pinze taglia filo**



220 mm - 8 ³ / ₄ "	BS 14-1017-01
--	---------------

For hard wires up to 2.2mmØ, for soft wires up to 3mmØ

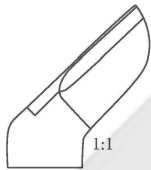

220 mm - 8 ³ / ₄ "	BS 14-1020-01
--	---------------

For hard wires up to 2.2mm Ø, for soft wires up to 2.8mmØ



230 mm - 9 "	BS 14-1025-01
--------------	---------------

For hard wires up to 2.2mmØ, for soft wires up to 3mmØ

Drahtschneidezangen
Pinces coupantes
Alicates para cortar alambre
Pinze taglia filo



180 mm – 7"	BS 14-1030-01
-------------	---------------

for soft wires up to 2mmØ



180 mm – 7"	BS 14-1035-01
-------------	---------------

*For Hard wires up to 1.7mm Ø,
for soft wires up to 2mm Ø*



150 mm – 6"	BS 14-1040-01
-------------	---------------

*For Hard wires up to 1mm Ø,
for soft wires up to 1.5mm Ø*



185 cm – 7 ¹ / ₄ "	BS 14-1050-01
--	---------------

Wire cutting forceps for hard wires up to 1.6mmØ



145 mm – 5 ³ / ₄ "	BS 14-1045-01
--	---------------

For hard wires up to 1mm Ø

Drahtschneidezangen
Pinces coupantes
Alicates para cortar alambre
Pinze taglia filo



1:3

570 mm – 22¹/₂" | **BS 14-1055-01**

For Kirschner wires and Steinmann pins up to 6mm



570 mm – 22" | BS 14-1056-01

For Kirschner wires and Steinmann pins up to 6mm , Deattachedable Handles



1:2

240 mm – 10¹/₄" | BS 14-1060-01

For hard wires up to 3mm Ø