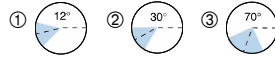
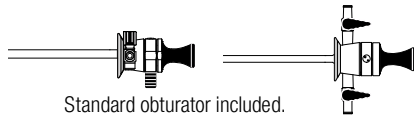

**Telescopes**

- ① **WA2T412A** Telescope "OES ELITE", 4 mm, 12°, HD, autoclavable
- ② **WA2T430A** Telescope "OES ELITE", 4 mm, 30°, HD, autoclavable
- ③ **WA2T470A** Telescope "OES ELITE", 4 mm, 70°, HD, autoclavable

Delivery includes:
protective tube WA2P400A.

Sheaths

Standard obturator included.

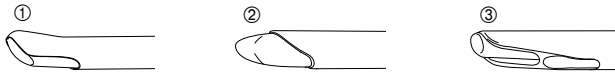

- ① **A20912A** Cystoscope sheath, 19.8 Fr.
- A20913A** Cystoscope sheath, 21 Fr.
- A20914A** Cystoscope sheath, 22.5 Fr.
- A20934A** Cystoscope sheath, 22.5 Fr. (slip-off protection)
- A20915A** Cystoscope sheath, 25 Fr.
All cystoscopes with beak
- ② **A20933A** Cystoscope sheath, 21 Fr., straight, short window
 - Application in female urethras
 - For bridges A20976A–78A
- ③ **A20916A** Cystoscope sheath, 19.8 Fr., with ramp, straight, 7 Fr. channel
 - For bridge A20976A

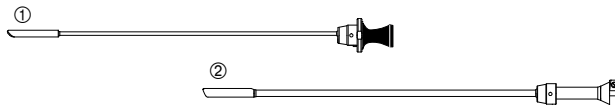
Obturers

- ① **A20904A** Obturator, 19.8 Fr., for A20912A
- A20910A** Obturator, 19.8 Fr., for A20916A
- A20905A** Obturator, 21 Fr., for A20913A
- A20902A** Obturator, 21 Fr., for A20933A
- A20906A** Obturator, 22.5 Fr., for A20914A/-34A
- A20907A** Obturator, 25 Fr., for A20915A
- ② **A20922A** Obturator, optical, 19.8 Fr.
- A20923A** Obturator, optical, 21 Fr.
- A20924A** Obturator, optical, 22.5 Fr.
- A20925A** Obturator, optical, 25 Fr.

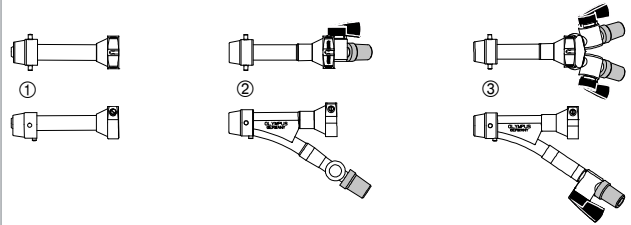
Bridges

- ① **A20978A** Bridge, for 4 mm telescope, cystoscope
- ② **A20976A** Bridge, one-way
- ③ **A20977A** Bridge, two-way

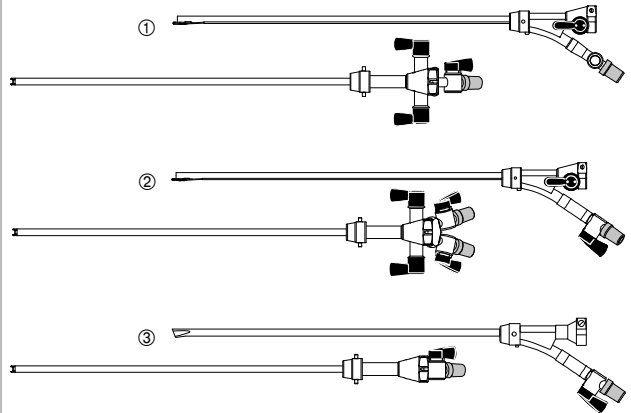
Working Inserts

- ① **A20971A** Working insert, Albarran, one-way
- ② **A20972A** Working insert, Albarran, two-way
- ③ **A20975A** Working insert, with ramp, one-way

For compatibility with cystoscope sheaths, see page 37.

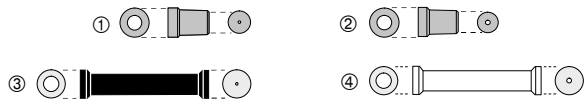
Reusable/ Non-Sterile Sealing Caps

- ① **00131** Sealing caps, 0.7 mm, 10 pcs.
- ② **A0223** Sealing caps, 1.6 mm, 10 pcs.
- ③ **A0286** Sealing caps, 0.4 mm, kink protected, black
- ④ **A0287** Sealing caps, 1.0 mm, kink protected, transparent

For Endo-Therapy instruments, see page 21, 22, 23, 24 and 35.

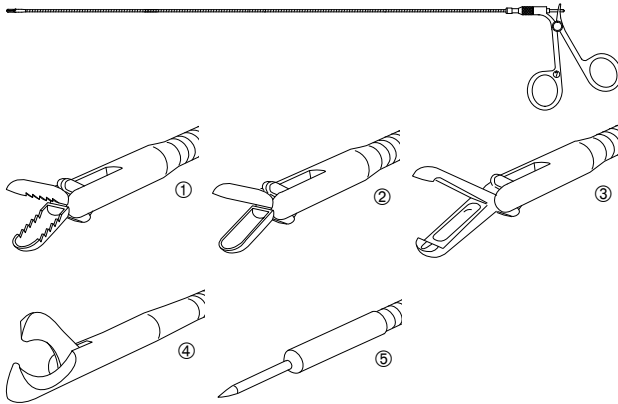
**Flexible Surgical Instruments**

- | | | |
|---|--------------|---|
| ① | 00121 | Grasping forceps, 7 Fr. x 330 mm, flexible |
| | 00122 | Grasping forceps, 9 Fr. x 330 mm, flexible |
| ② | 00123 | Biopsy forceps, 7 Fr., flexible |
| | 00124 | Biopsy forceps, 9 Fr., flexible
▪ Both biopsy forceps: 330 mm working length |
| ③ | 00125 | Grasping forceps, 9 Fr. x 330 mm, flexible
▪ Distension of the ureter
▪ Grasping of concrements |
| ④ | 00129 | Scissors, 9 Fr. x 330 mm, flexible |
| ⑤ | 00126 | Cannula, 7 Fr., flexible
▪ Working length 330mm
▪ Needle length 7mm |

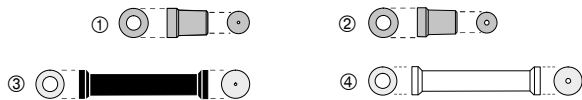
Reusable/ Non-Sterile Sealing Caps

- | | | |
|---|--------------|---|
| ① | 00131 | Sealing caps, 0.7 mm, 10 pcs. |
| ② | A0223 | Sealing caps, 1.6 mm, 10 pcs. |
| ③ | A0286 | Sealing caps, 0.4 mm, kink protected, black |
| ④ | A0287 | Sealing caps, 1.0 mm, kink protected, transparent |

Flexible HF Electrodes

- | | | |
|---|--------------|--|
| ① | 00107 | HF electrode, button, 4 Fr., flexible |
| | 00108 | HF electrode, button, 5 Fr., flexible |
| | 00109 | HF electrode, button, 6 Fr., flexible |
| | 00110 | HF electrode, button, 7 Fr., flexible |
| | 00111 | HF electrode, button, 8 Fr., flexible |
| | A0275 | HF electrode, button, 9 Fr., flexible |
| | 00112 | HF electrode, button, 10 Fr., flexible
▪ Each button: working length 330 mm |
| ② | 00114 | HF electrode, needle, 5 Fr., flexible
▪ Working length 400 mm |
| | 00115 | HF electrode, needle, 7 Fr., flexible
▪ Working length 400 mm |

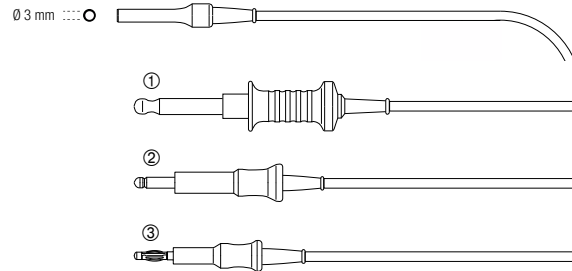
Monopolar HF Cables

- | | | |
|---|----------------|--|
| ① | A0335.1 | HF-cable, monopolar, 3.5 m, UES-30, Erbe Intl. and Valleylab (new) HF-unit to 3 mm pin surgical instrument
Compatible HF units:
▪ Olympus ESG-400
▪ Olympus UES-30/-40
▪ Erbe International
▪ New generation Valleylab
▪ Bovie, Bowa |
| ② | A0130.2 | HF-cable, monopolar, 3.5 m, UES-10/20 and Valleylab (old) HF-unit to 3 mm pin surgical instrument
Compatible HF units:
▪ Olympus UES-10/-20
▪ Old generation Valleylab |
| ③ | 00120.1 | HF cable, monopolar, 3.5 m, Martin and Berchtold HF-unit to 3 mm pin surgical instrument
Compatible HF units:
▪ Olympus ESG-400
▪ Erbe International
▪ Martin
▪ Berchtold |

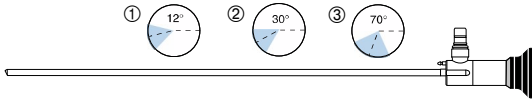
**Telescopes**

- ① **WA2T412A** Telescope "OES ELITE", 4 mm, HD, autoclavable, 12°
- ② **WA2T430A** Telescope "OES ELITE", 4 mm, HD, autoclavable, 30°
- ③ **WA2T470A** Telescope "OES ELITE", 4 mm, HD, autoclavable, 70°

Delivery includes:
protective tube WA2P400A.

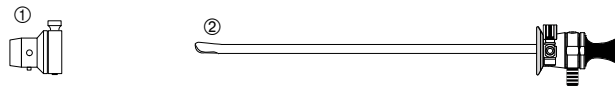
Sheaths

- ① **A3408** Adapter,
optical forceps in resectoscope sheath
Adapts optical forceps to all OES resection sheaths.
- ② **A20913A** Cystoscope sheath, 21 Fr. (with beak)
- A20933A** Cystoscope sheath, 21 Fr., slip off protection, straight,
short window
- A20914A** Cystoscope sheath, 22.5 Fr. (with beak)
- A20934A** Cystoscope sheath, 22.5 Fr., slip off protection
(with beak)
- A20915A** Cystoscope sheath, 25 Fr. (with beak)

For a system chart of compatible cystoscope sheaths, see page 41.

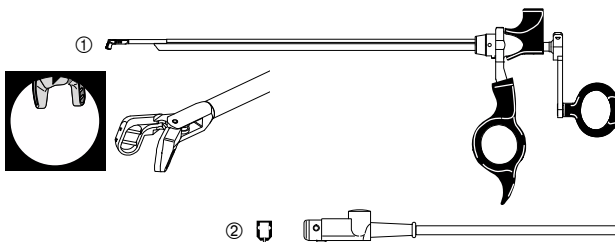
Monopolar Optical Forceps

- ① **A20716A** Biopsy forceps, optical, unipolar, for 12° telescope
- ② **A00012A** HF cable, monopolar, 4 m,
for UES-30/-40, Erbe Int., Valleylab (new)
- A00010A** HF cable, monopolar, 4 m,
for UES-10/-20, Valleylab (old)
- A00011A** HF cable, monopolar, 4 m,
for Erbe T series, Martin, Berchtold

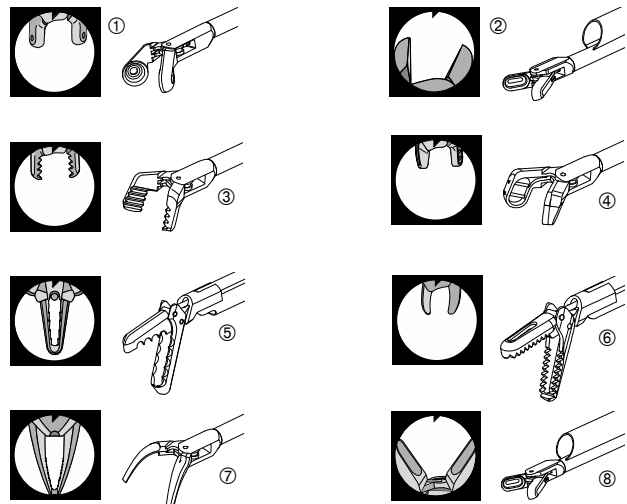
Optical Forceps

- ① **A20712A** Biopsy forceps,
spoon type, optical,
for 12° telescope
- ② **A20713A** Biopsy forceps,
spoon type, optical,
for 30° telescope
- ③ **A20714A** Grasping forceps,
double action, optical,
for 12° telescope
- ④ **A20715A** Biopsy forceps,
severing, optical, double action,
for 12° telescope
- ⑤ **A20710A** Grasping forceps,
optical, for lithotripsy,
for 12° and 30° telescope
 - Only for sheath A20915A
- ⑥ **A20717A** Scissors,
double action, optical,
for 12° telescope
- ⑦ **A20718A** Grasping forceps,
optical,
for 12° and 30° telescope
- ⑧ **A20719A** Biopsy forceps,
optical, spoon type,
for 70° telescope

Accessories

Bladder Irrigation, Bougies, Urethrotome, Stopcocks and Tubings

Bladder Syringes

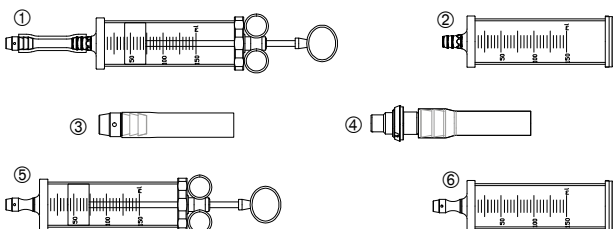

- | | | |
|---|-----------------|--|
| ① | A0555 | Syringe, 150 ml, with flexible clamping cone |
| ② | A0558 | Spare cylinder, for A0555 |
| ③ | O3664 | Tube, with cone, for O3657 spare for A0555 |
| ④ | WA33026A | Adapter, OES Pro outer sheath to Ellik and syringe |
| ⑤ | A0556 | Syringe, 150 ml, with clamping cone |
| ⑥ | A0559 | Spare cylinder, for A0556 |

System Chart Bladder Syringes

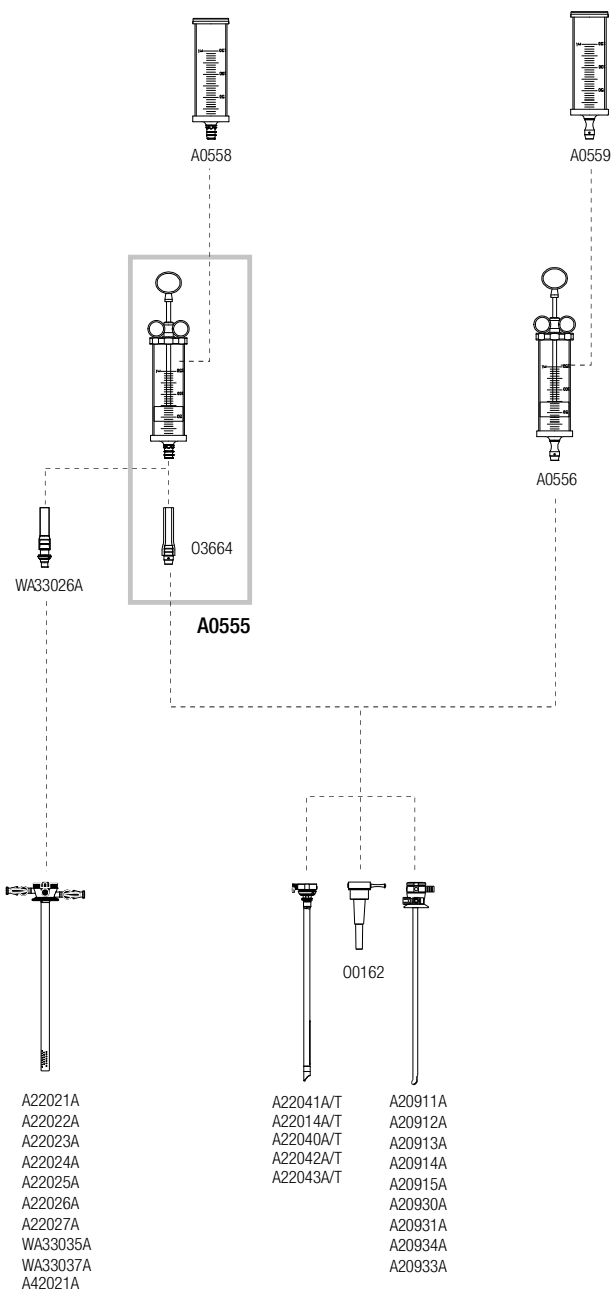

Urology



EC Certificate
Directive 93/42/EEC Annex II, excluding Section 4
Full Quality Assurance System
Medical Devices

Registration No.: HD 60123878 0001

Report No.: 12018179 022

Manufacturer: OLYMPUS MEDICAL SYSTEMS CORP.
2951 Ishikawa-cho,
Hachioji-shi, Tokyo 192-8507
Japan

Products: Design and Development, Manufacture of Medical Endoscopy
Systems, Diagnostic, Operation and Treatment Products

(see attachments for products and additional sites included)

Replaces Approval, Registration No.: HD 60078827 0001

Expiry Date: 2022-11-02

The Notified Body hereby declares that the requirements of Annex II, excluding section 4 of the directive 93/42/EEC have been met for the listed products. The above named manufacturer has established and applies a quality assurance system, which is subject to periodic surveillance, defined by Annex II, section 5 of the aforementioned directive. For placing on the market of class III devices covered by this certificate an EC design-examination certificate according to Annex II, section 4 is required.

Effective Date: 2017-11-03

Date: 2017-10-12



Notified Body

M.Sc. M. Aihara

TÜV Rheinland LGA Products GmbH - Tillystraße 2 - 90431 Nürnberg

TÜV Rheinland LGA Products GmbH is a Notified Body according to Directive 93/42/EEC concerning medical devices with the identification number 0197.

TÜV Rheinland
LGA Products GmbH
Tillystraße 2, 90431 Nürnberg

**Attachment to
Certificate**

Registration No.: HD 60123878 0001

Report No.: 12018179 022

Manufacturer: OLYMPUS MEDICAL SYSTEMS CORP.
2951 Ishikawa-cho,
Hachioji-shi, Tokyo 192-8507
Japan

Products included:

Medical Endoscopy Systems:

- Endoscopes
- Endotherapy Devices
- Imaging Processors
- Pumps for Endoscopy
- Light Sources
- Position Detecting Units
- Electrothermal Cautery Units
- Integrated Endosurgery Systems
- Endoscopic Regulation/Control Units

Electrosurgical Equipment

Probes and Transducers for Ultrasonic Lithotriptors

Laparoscopic Insufflators

Ultrasound Surgical Equipment

Disinfecting Units

Capsule Endoscopes and Systems

Ultrasound Diagnostic Imaging Systems



Notified Body

M. Aihara
M.Sc. M. Aihara

Date: 2017-10-12

Traducere din limba engleza



APROBARE
Directiva CE 93/42/CEE Anexa II, excluzând Secțiunea 4
Sistem complet de asigurare a calității
Echipeamente medicale

Nr. Înregistrare: HD 60123878 0001
Nr. Raport: 12018179 022

Producător: Olympus Medical Systems Corp.
2951 Ishikawa-cho
HACHIOJI-SHI, TOKIO 192-8507
JAPONIA

Produse: Proiectare și dezvoltare, producție de sisteme de endoscopie medicală, produse de diagnostic, operație și tratament.
(a se vedea atasamentele pentru produse și locații suplimentare incluse)
Înlocuiește Aprobarea cu nr. de înregistrare: HD 60078827 0001

Data expirării: 02.11.2022

Organismul Notificat declară prin prezenta că au fost îndeplinite cerințele Anexei II, excluzând secțiunea 4 a directivei 93/42/CEE pentru produsele specificate. Producătorul mai sus menționat a stabilit și aplică un sistem de asigurare a calității, care este supus unei supravegheri periodice, definită în Anexa II, secțiunea 5 a directivei menționate anterior. Pentru comercializarea echipamentelor din clasa III acoperite de acest certificat, este necesar un certificat CE de examinare proiectare în conformitate cu Anexa II, secțiunea 4.

Data intrării în vigoare: 03-11-2017

Data: 12.10.2017

Organism notificat
Ștampilă:
TUV Rheinland LGA Products GmbH
Zertifizierungsstelle
M.Sc. M. Aihara
(semnătură indescifrabilă)

TÜV Rheinland LGA Products GmbH – Tillystraße 2 – 90431 Nürnberg
TÜV Rheinland LGA Products GmbH este un Organism Notificat în conformitate cu Directiva
93/42/CEE cu privire la echipamentele medicale, cu numărul de identificare 0197

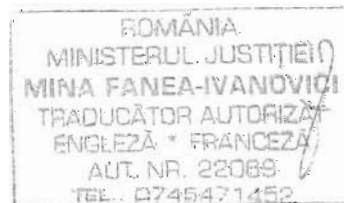

TÜV Rheinland
LGA Products GmbH
Tillystraße 2, 90431 Nürnberg

Atasament la
Certificat

Nr. de înregistrare: HD 60123878 0001
Nr. raport: 12018179 022

Producător: Olympus Medical Systems Corp.
2951 Ishikawa-cho
HACHIOJI-SHI, TOKIO 192-8507
JAPONIA

Produse incluse:

- Sisteme medicale de endoscopie:
 - Endoscoape
 - Echipamente endoterapie
 - Procesoare de imagine
 - Pompe pentru endoscopie
 - Surse de lumină
 - Unități de detectare poziție
 - Unități de cauterizare electrotermică
 - Sisteme endochirurgicale integrate
 - Unitati de control/reglare endoscopice
- Echipamente electrochirurgicale
- Sonde și traductoare pentru litotriptoare cu ultrasunete
- Insuflatoare laparoscopice
- Echipamente chirurgicale cu ultrasunete
- Unitati de sterilizare
- Sisteme și endoscoape capsulă
- Sisteme de imagistica pentru diagnostic cu ultrasunete

Data: 12.10.2012

Organism notificat
Ștampilă:
TUV Rheinland LGA Products GmbH
Zertifizierungsstelle
M.Sc. M. Aihara
(semnătură indescifrabilă)

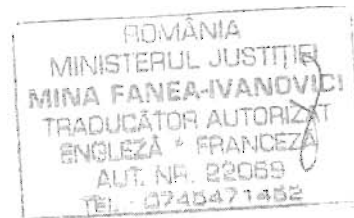



EC Certificate
Directive 93/42/EEC Annex V
Production Quality Assurance
Medical Devices

Registration No.: DD 60123877 0001

Report No.: 12018179 022

Manufacturer: OLYMPUS MEDICAL SYSTEMS CORP.
2951 Ishikawa-cho,
Hachioji-shi, Tokyo 192-8507
Japan

Products: Sterile Endotherapy Devices used in conjunction with Endoscopes, Sterile Non Active Instruments used in conjunction with Endoscopes and Sterile Non Active Instruments used in conjunction with Medical Ultrasound Diagnostic Imaging Systems
Replaces Approval, Registration No.: DD 60116725 0001

Expiry Date: 2022-11-02

The Notified Body hereby declares that the requirements of Annex V of the directive 93/42/EEC have been met for the listed products. The above named manufacturer has established and applies a quality assurance system, which is subject to periodic surveillance, defined by Annex V, section 4 of the aforementioned directive. For placing on the market of class IIb and class III devices covered by this certificate an EC type-examination certificate according to Annex III is required.

Effective Date: 2017-11-03

Date: 2017-10-12



Notified Body

M.Sc. M. Aihara

TÜV Rheinland LGA Products GmbH - Tillystraße 2 - 90431 Nürnberg

TÜV Rheinland LGA Products GmbH is a Notified Body according to Directive 93/42/EEC concerning medical devices with the identification number 0197.

Traducere din limba engleza



CERTIFICAT CE
Directiva CE 93/42/CEE Anexa V
Asigurarea calității producției
Echipamente medicale

Nr. Înregistrare: DD 60123877 0001
Nr. Raport: 12018179 022

Producător: Olympus Medical Systems Corp.
2951 Ishikawa-cho
HACHIOJI-SHI, TOKIO 192-8507
JAPONIA

Produse: Echipamentelor sterile pentru endoterapie, utilizate împreună cu endoscoape, instrumente sterile non-active utilizate împreună cu endoscoape și instrumente sterile non-active utilizate împreună cu sisteme medicale de imagistică diagnostic cu ultrasunete.
Înlocuiește Aprobarea. nr. înregistrare: DD 60116725 0001

Data expirării: 02.11.2022

Organismul Notificat declară prin prezenta că au fost îndeplinite cerințele Anexei V a directivei 93/42/CEE pentru produsele specificate. Producătorul mai sus menționat a stabilit și aplică un sistem de asigurare a calității, care este supus unei supravegheri periodice, definită în Anexa V, secțiunea 4 a directivei menționate anterior. Pentru comercializarea echipamentelor din clasa IIb și clasa III acoperite de acest certificat, este necesar un certificat CE de examinare tip în conformitate cu Anexa III.

Data intrării în vigoare: 03-11-2017

Data: 12.10.2017

Organism notificat
Ștampilă:
TUV Rheinland LGA Products GmbH
Zertifizierungsstelle
M.Sc. M. Aihara
(semnătură indescifrabilă)

TÜV Rheinland LGA Products GmbH – Tillystraße 2 – 90431 Nürnberg
TÜV Rheinland LGA Products GmbH este un Organism Notificat în conformitate cu Directiva 93/42/CEE cu privire la echipamentele medicale, cu numărul de identificare 0197



Certificate

The Certification Body of
TÜV Rheinland LGA Products GmbH

hereby certifies that the organization

Olympus Europa SE & Co. KG
Amsinckstr. 63
20097 Hamburg
Deutschland

has established and applies a quality management system for medical devices
for the following scope:

**Marketing, sales and servicing of optical, opto-digital,
electronic and mechanical systems as well as associated
accessories and consumables in the field of
endoscopy and microscopy**

Proof has been furnished that the requirements specified in

EN ISO 13485:2016

are fulfilled. The quality management system is subject to yearly surveillance.

Effective Date: 2020-06-21
Certificate Registration No.: SX 60148788 0001
An audit was performed. Report No.: 60319405 001
This Certificate is valid until: 2023-06-20

Certification Body



Date 2020-04-29

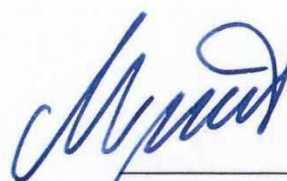

Dipl.-Ing. I. Munkler

TÜV Rheinland LGA Products GmbH - Tillystraße 2 - 90431 Nürnberg
Tel.: +49 221 806-1371 Fax: +49 221 806-3935 e-mail: cert-validity@de.tuv.com <http://www.tuv.com/safety>

TÜV Rheinland
LGA Products GmbH
Tillystraße 2, 90431 Nürnberg

**Attachment to
Certificate**

Registration No.: SX 60148788 0001
Report No.: 60319405 001

Organization: Olympus Europa SE & Co. KG
Amsinckstr. 63
20097 Hamburg
Deutschland

Scope: Subsidiary:

Olympus Europa SE & Co. KG
Albert-Schweitzer-Ring 24-26
22045 Hamburg
Germany

Scope:
Servicing of optical, opto-digital, electronic and
mechanical systems as well as associated accessories
in the field of endoscopy

Certification Body



Date: 2020-04-29



Dipl.-Ing. I. Munkler

TÜV Rheinland
LGA Products GmbH
Tillystraße 2, 90431 Nürnberg

**Attachment to
Certificate**

Registration No.: SX 60148788 0001
Report No.: 60319405 001

Organization: Olympus Europa SE & Co. KG
Amsinckstr. 63
20097 Hamburg
Deutschland

Scope: Subsidiary:

Olympus Deutschland GmbH
Albert-Schweitzer-Ring 35
22045 Hamburg
Germany

Scope:

Servicing of optical, opto-digital, electronic and
mechanical systems as well as associated accessories
in the field of endoscopy

Certification Body



Date: 2020-04-29



TÜVRheinland LGA Products GmbH
TÜVRheinland®
Zertifizierungsstelle

Dipl.-Ing. I. Munkler

TÜV Rheinland
LGA Products GmbH
Tillystraße 2, 90431 Nürnberg

**Attachment to
Certificate**

Registration No.: SX 60148788 0001
Report No.: 60319405 001

Organization: Olympus Europa SE & Co. KG
Amsinckstr. 63
20097 Hamburg
Deutschland

Scope: Subsidiary:

Olympus Deutschland GmbH
Amsinckstr. 63
20097 Hamburg
Germany

Scope:
Marketing, sales and servicing of optical, opto-digital,
electronic and mechanical systems as well as associated
accessories and consumables in the field of endoscopy
and microscopy

Certification Body



Date: 2020-04-29



TÜV Rheinland LGA Products GmbH
TÜVRheinland[®]
Zertifizierungsstelle

Dipl.-Ing. I. Munkler

TÜV Rheinland
LGA Products GmbH
Tillystraße 2, 90431 Nürnberg

**Attachment to
Certificate**

Registration No.: SX 60148788 0001
Report No.: 60319405 001

Organization: Olympus Europa SE & Co. KG
Amsinckstr. 63
20097 Hamburg
Deutschland

Scope: Subsidiary:

Olympus France S.A.S.
65 Rue de Monthléry
94533 Rungis
France

Scope:
Servicing of optical, opto-digital, electronic and
mechanical systems as well as associated accessories in
the field of endoscopy

Certification Body



Date: 2020-04-29



TÜVRheinland LGA Products GmbH
TÜVRheinland[®]
Zertifizierungsstelle

Dipl.-Ing. I. Munkler

TÜV Rheinland
LGA Products GmbH
Tillystraße 2, 90431 Nürnberg

**Attachment to
Certificate**

Registration No.: SX 60148788 0001
Report No.: 60319405 001

Organization: Olympus Europa SE & Co. KG
Amsinckstr. 63
20097 Hamburg
Deutschland

Scope: Subsidiary:

OLYMPUS IBERIA S.A.U.
PL. Europa 29-31
08908 L'Hospitalet de Llobregat
Barcelona
Spain

Scope:
Marketing, sales and servicing of optical, opto-digital,
electronic and mechanical systems as well as associated
accessories and consumables in the field of endoscopy
microscopy

Certification Body



Date: 2020-04-29



Dipl.-Ing. I. Munkler
Page 13 of 83

TÜV Rheinland
LGA Products GmbH
Tillystraße 2, 90431 Nürnberg

**Attachment to
Certificate**

Registration No.: SX 60148788 0001
Report No.: 60319405 001

Organization: Olympus Europa SE & Co. KG
Amsinckstr. 63
20097 Hamburg
Deutschland

Scope:

Subsidiary:

Olympus France S.A.S.
19 rue d'Arcueil
94150 Rungis
France

Scope:

Marketing, sales and servicing of optical, opto-digital,
electronic and mechanical systems as well as associated
accessories and consumables in the field of endoscopy
and microscopy

Certification Body



Date: 2020-04-29



Dipl.-Ing. I. Munkler

TÜV Rheinland
LGA Products GmbH
Tillystraße 2, 90431 Nürnberg

**Attachment to
Certificate**

Registration No.: SX 60148788 0001
Report No.: 60319405 001

Organization: Olympus Europa SE & Co. KG
Amsinckstr. 63
20097 Hamburg
Deutschland

Scope: Subsidiary:

Olympus Czech Group, s.r.o.
Evropská ul. 176/16
160 41 Praha 6
Czech Republic

Scope:
Marketing, sales and servicing of optical, opto-digital,
electronic and mechanical systems as well as associated
accessories and consumables in the field of endoscopy
and microscopy

Certification Body



Date: 2020-04-29



Dipl.-Ing. I. Munkler

TÜV Rheinland
LGA Products GmbH
Tillystraße 2, 90431 Nürnberg

**Attachment to
Certificate**

Registration No.: SX 60148788 0001
Report No.: 60319405 001

Organization: Olympus Europa SE & Co. KG
Amsinckstr. 63
20097 Hamburg
Deutschland

Scope:

Subsidiary:

Olympus Czech Group, s. r.o.
clen koncernu
Telickova 457/29
751 24 Prerov-Predmosti
Czech Republic

Scope:

Servicing of optical, opto-digital, electronic and
mechanical systems as well as associated accessories
in the field of endoscopy

Certification Body



Date: 2020-04-29



Dipl.-Ing. I. Munkler

TÜV Rheinland
LGA Products GmbH
Tillystraße 2, 90431 Nürnberg

**Attachment to
Certificate**

Registration No.: SX 60148788 0001
Report No.: 60319405 001

Organization: Olympus Europa SE & Co. KG
Amsinckstr. 63
20097 Hamburg
Deutschland

Scope:

Subsidiary:

Olympus Service Facility Portugal
Tecnologies Opticas e Digitais, Lda.
Rua de Alcorredores 43 A
3020-923 Torre de Vilela (Coimbra)
Portugal

Scope:

In-house servicing of optical, opto-digital, electronic and mechanical systems as well as associated accessories in the field of endoscopy

Certification Body



Date: 2020-04-29



Dipl.-Ing. I. Munkler

TÜV Rheinland
LGA Products GmbH
Tillystraße 2, 90431 Nürnberg

**Attachment to
Certificate**

Registration No.: SX 60148788 0001
Report No.: 60319405 001

Organization: Olympus Europa SE & Co. KG
Amsinckstr. 63
20097 Hamburg
Deutschland

Scope: Subsidiary:

Olympus Austria GmbH
Shuttleworthstr. 25
1210 Vienna
Austria

Scope:
Marketing, sales and servicing of optical, opto-digital,
electronic and mechanical systems as well as associated
accessories and consumables in the field of endoscopy
and microscopy

Certification Body



Date: 2020-04-29



TÜVRheinland LGA Products GmbH
TÜVRheinland
Zertifizierungsstelle

Dipl.-Ing. I. Munkler

TÜV Rheinland
LGA Products GmbH
Tillystraße 2, 90431 Nürnberg

**Attachment to
Certificate**

Registration No.: SX 60148788 0001
Report No.: 60319405 001

Organization: Olympus Europa SE & Co. KG
Amsinckstr. 63
20097 Hamburg
Deutschland

Scope:

Subsidiary:

Olympus Nederland B.V.
Simon Smitweg 18
2353 GA Leiderdorp
Netherlands



Scope:

Marketing, sales and servicing of optical, opto-digital,
electronic and mechanical systems as well as associated
accessories and consumables in the field of endoscopy
and microscopy

Certification Body



Date: 2020-04-29



Dipl.-Ing. I. Munkler

TÜV Rheinland
LGA Products GmbH
Tillystraße 2, 90431 Nürnberg

**Attachment to
Certificate**

Registration No.: SX 60148788 0001
Report No.: 60319405 001

Organization: Olympus Europa SE & Co. KG
Amsinckstr. 63
20097 Hamburg
Deutschland

Scope:

Subsidiary:

Olympus Schweiz AG
Chriesbaumstr. 6
8604 Volketswil
Switzerland

Scope:

Servicing of optical, opto-digital, electronic and
mechanical systems as well as associated accessories
in the field of endoscopy

Certification Body



Date: 2020-04-29



Dipl.-Ing. I. Munkler

TÜV Rheinland
LGA Products GmbH
Tillystraße 2, 90431 Nürnberg

**Attachment to
Certificate**

Registration No.: SX 60148788 0001
Report No.: 60319405 001

Organization: Olympus Europa SE & Co. KG
Amsinckstr. 63
20097 Hamburg
Deutschland

Scope:

Subsidiary:

Olympus Schweiz AG
Richtiring 30
8304 Wallisellen
Switzerland

Scope:

Marketing, sales and servicing of optical, opto-digital, electronic and mechanical systems as well as associated accessories and consumables in the field of endoscopy and microscopy

Certification Body



Date: 2020-04-29



Dipl.-Ing. I. Munkler



Certificat

Organismul de certificare al TÜV Rheinland LGA Products GmbH

certifică prin prezenta faptul că organizația

OLYMPUS EUROPA SE & Co. KG
Amsinckstr. 63
20097 Hamburg
Germania

a implementat și aplică un sistem de management al calității pentru dispozitive medicale pentru următoarele domenii:

Marketing, distribuție și service pentru sisteme optice, opto-digitale, electronice și mecanice, precum și pentru accesoriile corespunzătoare și consumabilele din domeniul endoscopiei și microscopiei

S-a furnizat dovada faptului că au fost îndeplinite cerințele specificate în

EN ISO 13485:2016

Sistemul de management al calității este supus unei supravegheri anuale.

Data intrării în vigoare: 21.06.2020

Nr. înregistrare certificat: SX 60148788 0001

A fost efectuat auditul, raport nr. 60319405 001

Acest certificat este valabil până la 20.06.2023.



Data, 29.04.2020

Organism de certificare
(Semnătură indescifrabilă și ștampilă TÜV
Rheinland LGA Products GmbH)
Dipl. Ing. I. Munkler

TÜV Rheinland LGA Products GmbH – Tillystraße 2 – 90431 Nürnberg
Tel: +49 221 806-1371 Fax: +49 221 806-3935 email: cert-validity@de.tuv.com <http://www.tuv.com/safety>





TÜVRheinland®

Doc. 1/13 Rev. 0

**TÜV Rheinland
LGA Products GmbH
Tillystraße 2, 90431 Nürnberg**

Ataşament la Certificat

Nr. de înregistrare: SX 60148788 0001

Nr. raport: 60319405 001

Organizație:

**Olympus Europa SE & Co. KG
Amsinckstr. 63
20097 Hamburg
Germania**

Domeniu de aplicabilitate: Filială

Olympus Europa SE & Co. KG
Albert-Schweitzer-Ring 24-26
22045 Hamburg
Germania

Domeniul de aplicabilitate:

**Service pentru sisteme optice, opto-digitale, electronice și mecanice,
precum și pentru accesoriile corespunzătoare și consumabilele din
domeniul endoscopiei**



Data, 29.04.2020

Organism de certificare
(Semnătură indescifrabilă și ștampilă TÜV
Rheinland LGA Products GmbH)
Dipl.-Ing. I. Munkler





TÜVRheinland®

Doc. 2/13 Rev. 0

**TÜV Rheinland
LGA Products GmbH
Tillystraße 2, 90431 Nürnberg**

Atașament la Certificat

Nr. de înregistrare:

SX 60148788 0001

Nr. raport:

60319405 001

Organizație:

**Olympus Europa SE & Co. KG
Amsinckstr. 63
20097 Hamburg
Germania**

Domeniu de aplicabilitate:

Filială

Olympus Deutschland GmbH
Albert-Schweitzer-Ring 35
22045 Hamburg
Germania

Domeniul de aplicabilitate:

**Service pentru sisteme optice, opto-digitale, electronice și mecanice,
precum și pentru accesoriile corespunzătoare și consumabilele din
domeniul endoscopiei**



Data, 29.04.2020

Organism de certificare
(Semnătură indescifrabilă și ștampilă TÜV
Rheinland LGA Products GmbH)
Dipl.-Ing. I. Munkler





TÜVRheinland®

Doc. 3/13 Rev. 0

**TÜV Rheinland
LGA Products GmbH
Tillystraße 2, 90431 Nürnberg**

Atașament la Certificat

Nr. de înregistrare:

SX 60148788 0001

Nr. raport:

60319405 001

Organizație:

**Olympus Europa SE & Co. KG
Amsinckstr. 63
20097 Hamburg
Germania**

Domeniu de aplicabilitate:

Filială

Olympus Deutschland GmbH
Amsinckstr. 63
20097 Hamburg
Germania

Domeniul de aplicabilitate:

Marketing, distribuție și service pentru sisteme optice, opto-digitale, electronice și mecanice, precum și pentru accesoriile corespunzătoare și consumabilele din domeniul endoscopiei și microscopiei



Data, 29.04.2020

Organism de certificare
(Semnătură indescifrabilă și ștampilă TÜV
Rheinland LGA Products GmbH)
Dipl.-Ing. I. Munkler





TÜVRheinland®

Doc. 4/13 Rev. 0

**TÜV Rheinland
LGA Products GmbH
Tillystraße 2, 90431 Nürnberg**

Atașament la Certificat

Nr. de înregistrare: SX 60148788 0001

Nr. raport: 60319405 001

Organizație:

**Olympus Europa SE & Co. KG
Amsinckstr. 63
20097 Hamburg
Germania**

Domeniu de aplicabilitate: Filială

Olympus France S.A.S.
65 Rue de Monthléry
94533 Rungis
Franța

Domeniul de aplicabilitate:

**Service pentru sisteme optice, opto-digitale, electronice și mecanice,
precum și pentru accesoriile corespunzătoare și consumabilele din
domeniul endoscopiei**



Data, 29.04.2020

Organism de certificare
(Semnătură indescifrabilă și ștampilă TÜV
Rheinland LGA Products GmbH)
Dipl.-Ing. I. Munkler



**TÜV Rheinland
LGA Products GmbH
Tillystraße 2, 90431 Nürnberg**

Atașament la Certificat

Nr. de înregistrare: SX 60148788 0001

Nr. raport: 60319405 001

Organizație:

**Olympus Europa SE & Co. KG
Amsinckstr. 63
20097 Hamburg
Germania**

Domeniu de aplicabilitate: Filială

Olympus Iberia S.A.U.
PL. Europa, 29-31
08908 L'Hospitalet de Llobregat
Barcelona
Spania

Domeniul de aplicabilitate:

**Marketing, distribuție și service pentru sisteme optice, opto-digitale,
electronice și mecanice, precum și pentru accesoriile corespunzătoare și
consumabilele din domeniul endoscopiei și microscopiei**



Data, 29.04.2020

Organism de certificare
(Semnătură indescifrabilă și ștampilă TÜV
Rheinland LGA Products GmbH)
Dipl.-Ing. I. Munkler



TÜV Rheinland
LGA Products GmbH
Tillystraße 2, 90431 Nürnberg

Atașament la Certificat

Nr. de înregistrare: SX 60148788 0001

Nr. raport: 60319405 001

Organizație:

Olympus Europa SE & Co. KG
Amsinckstr. 63
20097 Hamburg
Germania

Domeniu de aplicabilitate: Filială

Olympus France S.A.S.
19 rue d'Arcueil
94150 Rungis
Franța

Domeniul de aplicabilitate:

Marketing, distribuție și service pentru sisteme optice, opto-digitale, electronice și mecanice, precum și pentru accesoriile corespunzătoare și consumabilele din domeniul endoscopiei și microscopiei



Data, 29.04.2020

Organism de certificare
(Semnătură indescifrabilă și ștampilă TÜV
Rheinland LGA Products GmbH)
Dipl.-Ing. I. Munkler





TÜVRheinland®

Doc. 7/13 Rev. 0

**TÜV Rheinland
LGA Products GmbH
Tillystraße 2, 90431 Nürnberg**

Atașament la Certificat

Nr. de înregistrare:

SX 60148788 0001

Nr. raport:

60319405 001

Organizație:

**Olympus Europa SE & Co. KG
Amsinckstr. 63
20097 Hamburg
Germania**

Domeniu de aplicabilitate:

Filială

Olympus Czech Group, s.r.o.
Evropská ul. 176/16
160 41, Praga 6
Republica Cehă

Domeniul de aplicabilitate:

**Marketing, distribuție și service pentru sisteme optice, opto-digitale,
electronice și mecanice, precum și pentru accesoriile corespunzătoare și
consumabilele din domeniul endoscopiei și microscopiei**



Data, 29.04.2020

Organism de certificare
(Semnătură indescifrabilă și ștampilă TÜV
Rheinland LGA Products GmbH)
Dipl.-Ing. I. Munkler





TÜVRheinland®

Doc. 8/13 Rev. 0

**TÜV Rheinland
LGA Products GmbH
Tillystraße 2, 90431 Nürnberg**

Atașament la Certificat

Nr. de înregistrare: SX 60148788 0001

Nr. raport: 60319405 001

Organizație:

**Olympus Europa SE & Co. KG
Amsinckstr. 63
20097 Hamburg
Germania**

Domeniu de aplicabilitate: Filială

Olympus Czech Group, s.r.o.
clen concernu
Telickova 457/29
751 24 Prerov-Predmosti
Republica Cehă

Domeniul de aplicabilitate:

**Service pentru sisteme optice, opto-digitale, electronice și mecanice,
precum și pentru accesoriile corespunzătoare și consumabilele din
domeniul endoscopiei**



Data, 29.04.2020

Organism de certificare
(Semnătură indescifrabilă și ștampilă TÜV
Rheinland LGA Products GmbH)
Dipl.-Ing. I. Munkler





TÜVRheinland®

Doc. 9/13 Rev. 0

**TÜV Rheinland
LGA Products GmbH
Tillystraße 2, 90431 Nürnberg**

Atașament la Certificat

Nr. de înregistrare: SX 60148788 0001

Nr. raport: 60319405 001

Organizație:

**Olympus Europa SE & Co. KG
Amsinckstr. 63
20097 Hamburg
Germania**

Domeniu de aplicabilitate: Filială

Olympus Service Facility Portugal
Tecnologias Optica e Digitais, Lda.
Rua de Alcorredores, 43 A
3020-923 Torre de Vilela (Coimbra)
Portugalia

Domeniul de aplicabilitate:

Service intern pentru sisteme optice, opto-digitale, electronice și mecanice precum și accesorii corespunzătoare din domeniul endoscopiei.



Data, 29.04.2020

Organism de certificare
(Semnătură indescifrabilă și ștampilă TÜV
Rheinland LGA Products GmbH)
Dipl.-Ing. I. Munkler



TÜV Rheinland
LGA Products GmbH
Tillystraße 2, 90431 Nürnberg

Atașament la Certificat
Nr. de înregistrare: SX 60148788 0001
Nr. raport: 60319405 001

Organizație:
Olympus Europa SE & Co. KG
Amsinckstr. 63
20097 Hamburg
Germania

Domeniu de aplicabilitate: Filială

Olympus Austria GmbH
Shuttleworthstr. 25
1210 Viena
Austria

Domeniul de aplicabilitate:
Marketing, distribuție și service pentru sisteme optice, opto-digitale, electronice și mecanice, precum și pentru accesoriile corespunzătoare și consumabilele din domeniul endoscopiei și microscopiei



Data, 29.04.2020

Organism de certificare
(Semnătură indescifrabilă și ștampilă TÜV
Rheinland LGA Products GmbH)
Dipl.-Ing. I. Munkler





TÜVRheinland®

Doc. 11/13 Rev. 0

**TÜV Rheinland
LGA Products GmbH
Tillystraße 2, 90431 Nürnberg**

Atașament la Certificat

Nr. de înregistrare: SX 60148788 0001

Nr. raport: 60319405 001

Organizație:

**Olympus Europa SE & Co. KG
Amsinckstr. 63
20097 Hamburg
Germania**

Domeniu de aplicabilitate: Filială

Olympus Nederland B.V.
Simon Smitweg 18
2353 GA Leiderdorp
Țările de Jos

Domeniul de aplicabilitate:

**Marketing, distribuție și service pentru sisteme optice, opto-digitale,
electronice și mecanice, precum și pentru accesoriile corespunzătoare și
consumabilele din domeniul endoscopiei și microscopiei**



Data, 29.04.2020

Organism de certificare
(Semnătură indescifrabilă și ștampilă TÜV
Rheinland LGA Products GmbH)
Dipl.-Ing. I. Munkler



**TÜV Rheinland
LGA Products GmbH
Tillystraße 2, 90431 Nürnberg**

Atașament la Certificat

Nr. de înregistrare: SX 60148788 0001

Nr. raport: 60319405 001

Organizație:

**Olympus Europa SE & Co. KG
Amsinckstr. 63
20097 Hamburg
Germania**

Domeniu de aplicabilitate: Filială

Olympus Schweiz AG
Chriesbaumstr. 6
8604 Volketswil
Elveția

Domeniul de aplicabilitate:

**Service pentru sisteme optice, opto-digitale, electronice și mecanice,
precum și pentru accesoriile corespunzătoare și consumabilele din
domeniul endoscopiei**



Data, 29.04.2020

Organism de certificare
(Semnătură indescifrabilă și ștampilă TÜV
Rheinland LGA Products GmbH)
Dipl.-Ing. I. Munkler



**TÜV Rheinland
LGA Products GmbH
Tillystraße 2, 90431 Nürnberg**

Atașament la Certificat

Nr. de înregistrare: SX 60148788 0001

Nr. raport: 60319405 001

Organizație:

**Olympus Europa SE & Co. KG
Amsinckstr. 63
20097 Hamburg
Germania**

Domeniu de aplicabilitate: Filială

Olympus Schweiz AG
Richtiring 30
8304 Wallisellen
Elveția

Domeniul de aplicabilitate:

**Marketing, distribuție și service pentru sisteme optice, opto-digitale,
electronice și mecanice, precum și pentru accesoriile corespunzătoare și
consumabilele din domeniul endoscopiei și microscopiei**



Data, 29.04.2020

Organism de certificare
(Semnătură indescifrabilă și ștampilă TÜV
Rheinland LGA Products GmbH)
Dipl.-Ing. I. Munkler

