

# KANGHUI

## TRAUMA CATALOG 2018



**KANGHUI**  
A Medtronic Company

CHANGZHOU KANGHUI MEDICAL INNOVATION CO., LTD  
Add: No.11 North Changjiang Road, Xinbei District, Changzhou, Jiangsu 213022, P.R.China  
Tel: +86-519-85195555 Web: www.kanghui-med.com ©Kanghui

Please refer to the Instructions for contraindications and precautions.  
All product information is accordance with CE registration.  
Please contact your sales representative for detailed product list.  
Last Updated Jan 22, 2018.

**Medtronic**

## TABLE OF CONTENT

VariLoc Locking Compression Plate System	
▪ Shoulder	1
▪ Elbow	3
▪ Hand & Wrist	4
▪ Hip/Pelvis	8
▪ Knee	9
▪ Foot & Ankle	11
▪ Bone Shaft	13
MonoLoc Locking Plates System	
▪ Hand and Foot (1.5/2.0, 2.4/2.7 Systems)	55
▪ Limbs (2.7, 3.5, 5.0 Systems)	72
▪ Targeting Locking Plates System	99
▪ TopFix Osteotomy Plates System	102
Synplate Conventional Plates System	
▪ Synplate Modular Hand System	105
▪ Synplate Small Fragment System	113
▪ Synplate Large Fragment System	121
DH/DC System	128
Standard Screws & Washers	136
Cannulated Screws	
▪ KCS Cannulated Screw System	142
▪ 2.4/3.0mm Headless Compression Screws System	155
NeoGen Nails	
▪ NeoGen Femoral Nails	159
▪ NeoGen Tibia Nails	161
▪ NeoGen Retrograde Nail	161
▪ NeoGen Gamma Nails	162
NeoGen AR Nails	174
External Fixators	185
Wires & Pins	200
CMF	201

Materials:

'PT' stands for 'Pure Titanium'

'TA' stands for 'Titanium Alloy'

'SS' stands for 'Stainless Steel'

# VariLoc Locking Compression Plate System

- Shoulder
- Elbow
- Hand & Wrist
- Hip/Pelvis
- Knee
- Foot & Ankle
- Bone Shaft



# VariLoc Locking Compression Plate System

## Shoulder

### Clavicular S Reconstruction Locking Plate 3.5



Thickness (mm)	2.8
Width (mm)	10
Hole Space (mm)	12
Screws	3.5 cortex screw 3.5 locking screw 3.5 VA screw
Material	PT

Code	Model No.	Size	Direction	Length (mm)
24256106	SDXZ27	6H	R	61.8
24256107	SDXZ27	7H	R	77.1
24256108	SDXZ27	8H	R	91.3
24256109	SDXZ27	9H	R	92
24256110	SDXZ27	10H	R	103.9
24256112	SDXZ27	12H	R	127.7
24256206	SDXZ28	6H	L	61.8
24256207	SDXZ28	7H	L	77.1
24256208	SDXZ28	8H	L	91.3
24256209	SDXZ28	9H	L	92
24256210	SDXZ28	10H	L	103.9
24256212	SDXZ28	12H	L	127.7

### Anterolateral Clavicular Locking Compression Plate Plate, 2.7/3.5



Thickness (mm)	3.3
Width (mm)	10.5
Head Screws	2.7 locking screw 2.7 VA locking screw
Shaft Screws	3.5 cortex screw 3.5 locking screw
Material	PT

Code	Model No.	Size	Direction	Length (mm)
24258110	SDXG07	7+3H	R	68
24258111	SDXG07	7+4H	R	80
24258112	SDXG07	7+5H	R	92
24258113	SDXG07	7+6H	R	104
24258114	SDXG07	7+7H	R	116
24258115	SDXG07	7+8H	R	128
24258210	SDXG08	7+3H	L	68
24258211	SDXG08	7+4H	L	80
24258212	SDXG08	7+5H	L	92
24258213	SDXG08	7+6H	L	104
24258214	SDXG08	7+7H	L	116
24258215	SDXG08	7+8H	L	128

### Reconstruction Clavicular Locking Compression Plate 3.5



Thickness (mm)	3.2
Width (mm)	11
Screws	3.5 cortex screw 3.5 locking screw
Material	PT

Code	Model No.	Size	Direction	Length (mm)
24257106	SDXG22	6H	R	103.2
24257107	SDXG22	7H	R	113
24257108	SDXG22	8H	R	122.5
24257206	SDXG23	6H	L	103.2
24257207	SDXG23	7H	L	113
24257208	SDXG23	8H	L	122.5

### Anterolateral Clavicular Locking Compression Plate Plate, 2.7/3.5



Thickness (mm)	3
Width (mm)	11
Head Screws	2.7 VA locking screw 2.7 locking screw
Shaft Screws	3.5 locking screw 3.5 cortex screw
Material	PT

Code	Model No.	Size	Direction	Length (mm)
24282102	SDXG26	3+2H	R	44
24282103	SDXG26	3+3H	R	54
24282104	SDXG26	3+4H	R	64
24282105	SDXG26	3+5H	R	74
24282106	SDXG26	3+6H	R	84
24282107	SDXG26	3+7H	R	94
24282202	SDXG25	3+2H	L	44
24282203	SDXG25	3+3H	L	54
24282204	SDXG25	3+4H	L	64
24282205	SDXG25	3+5H	L	74
24282206	SDXG25	3+6H	L	84
24282207	SDXG25	3+7H	L	94



# VariLoc Locking Compression Plate System

## Shoulder

Clavicle Hook Locking Compression Plate II, 15mm



Thickness (mm)	3
Width (mm)	11
Head Screws	2.7 VA locking screw 2.7 locking screw
Shaft Screws	3.5 locking screw 3.5 cortex screw
Material	PT

Code	Model No.	Size	Direction	Length (mm)
24281102	SDXG26	3+2H	R	45
24281103	SDXG26	3+3H	R	55
24281104	SDXG26	3+4H	R	65
24281105	SDXG26	3+5H	R	75
24281106	SDXG26	3+6H	R	85
24281107	SDXG26	3+7H	R	95
24281202	SDXG25	3+2H	L	45
24281203	SDXG25	3+3H	L	55
24281204	SDXG25	3+4H	L	65
24281205	SDXG25	3+5H	L	75
24281206	SDXG25	3+6H	L	85
24281207	SDXG25	3+7H	L	95

Clavicle Hook Locking Compression Plate II, 18mm



Thickness (mm)	3
Width (mm)	11
Head Screws	2.7 VA locking screw 2.7 locking screw
Shaft Screws	3.5 locking screw 3.5 cortex screw
Material	PT

Code	Model No.	Size	Direction	Length (mm)
24283102	SDXG26	3+2H	R	46
24283103	SDXG26	3+3H	R	56
24283104	SDXG26	3+4H	R	66
24283105	SDXG26	3+5H	R	76
24283106	SDXG26	3+6H	R	86
24283107	SDXG26	3+7H	R	96
24283202	SDXG25	3+2H	L	46
24283203	SDXG25	3+3H	L	56
24283204	SDXG25	3+4H	L	66
24283205	SDXG25	3+5H	L	76
24283206	SDXG25	3+6H	L	86
24283207	SDXG25	3+7H	L	96

Proximal Humeral Locking Compression Plate, 3.5



Thickness (mm)	3.2
Width (mm)	12.0
Head Screws	3.5 VA locking screw 3.5 locking screw
Shaft Screws	3.5 locking screw 3.5 cortex screw
Material	PT

Code	Model No.	Size	Length (mm)
24285003	SDXG36	9+3H	96
24285004	SDXG36	9+4H	114
24285005	SDXG36	9+5H	132
24285006	SDXG36	9+6H	150
24285008	SDXG36	9+8H	186
24285010	SDXG36	9+10H	222
24285012	SDXG36	9+12H	258

# VariLoc Locking Compression Plate System

## Elbow

Olecranon Locking Compression Plates 2.7/3.5



Thickness (mm)	2.8
Width (mm)	10.0
Head Screws	2.7 VA locking screw 2.7 locking screw
Shaft Screws	3.5 locking screw 3.5 cortex screw
Material	PT

Code	Model No.	Size	Direction	Length (mm)
24224104	SDXG42	8+4H	R	112
24224106	SDXG42	8+6H	R	138
24224108	SDXG42	8+8H	R	164
24224110	SDXG42	8+10H	R	190
24224112	SDXG42	8+12H	R	216
24224204	SDXG41	8+4H	L	112
24224206	SDXG41	8+6H	L	138
24224208	SDXG41	8+8H	L	164
24224210	SDXG41	8+10H	L	190
24224212	SDXG41	8+12H	L	216

Distal Medial Humerus Locking Compression Plates 2.7/3.5



Thickness (mm)	3.0
Width (mm)	11.2
Head Screws	2.7 VA locking screw 2.7 locking screw
Shaft Screws	3.5 locking screw 3.5 cortex screw
Material	PT

Code	Model No.	Size	Direction	Length (mm)
24223103	SDXG10	3+3H	R	59
24223105	SDXG10	3+5H	R	84
24223107	SDXG10	3+7H	R	109
24223109	SDXG10	3+9H	R	134
24223114	SDXG10	3+14H	R	201
24223203	SDXG09	3+3H	L	59
24223205	SDXG09	3+5H	L	84
24223207	SDXG09	3+7H	L	109
24223209	SDXG09	3+9H	L	134
24223214	SDXG09	3+14H	L	201

Distal Dorsal Humerus Locking Compression Plates 2.7/3.5



Thickness (mm)	2.8
Width (mm)	11.2
Head Screws	2.7 VA locking screw 2.7 locking screw
Shaft Screws	3.5 locking screw 3.5 cortex screw
Material	PT

Code	Model No.	Size	Direction	Length (mm)
24291103	SDXG29	6+3H	R	65
24291105	SDXG29	6+5H	R	91
24291107	SDXG29	6+7H	R	117
24291109	SDXG29	6+9H	R	143
24291114	SDXG29	6+14H	R	208
24291203	SDXG30	6+3H	L	65
24291205	SDXG30	6+5H	L	91
24291207	SDXG30	6+7H	L	117
24291209	SDXG30	6+9H	L	143
24291214	SDXG30	6+14H	L	208

# VariLoc Locking Compression Plate System

## Hand & Wrist

Distal Radius Two-Column Volar Plate I, 2.4/2.7



Thickness (mm)	1.7
Width (mm)	19.5
Head Screws	2.4 locking screw 2.7 locking screw 2.4 VA locking screw 2.7 VA locking screw
Shaft Screws	2.4 cortex screw 2.7 cortex screw 2.7 locking screw
Material	PT

Code	Model No.	Size	Direction	Length (mm)
24278102	SDDG16	7+2H	R	54
24278103	SDDG16	7+3H	R	63
24278104	SDDG16	7+4H	R	72
24278105	SDDG16	7+5H	R	81
24278202	SDDG15	7+2H	L	54
24278203	SDDG15	7+3H	L	63
24278204	SDDG15	7+4H	L	72
24278205	SDDG15	7+5H	L	81

Distal Radius Two-Column Volar Plate III, 2.4/2.7



Thickness (mm)	2.3
Width (mm)	25.5
Head Screws	2.4 locking screw 2.7 locking screw 2.4 VA locking screw 2.7 VA locking screw
Shaft Screws	2.4 cortex screw 2.7 cortex screw 2.7 locking screw
Material	PT

Code	Model No.	Size	Direction	Length (mm)
24280102	SDDG16	7+2H	R	54
24280103	SDDG16	7+3H	R	63
24280104	SDDG16	7+4H	R	72
24280105	SDDG16	7+5H	R	81
24280202	SDDG15	7+2H	L	54
24280203	SDDG15	7+3H	L	63
24280204	SDDG15	7+4H	L	72
24280205	SDDG15	7+5H	L	81

Distal Radius Two-Column Volar Plate II, 2.4/2.7



Thickness (mm)	2
Width (mm)	22
Head Screws	2.4 locking screw 2.7 locking screw 2.4 VA locking screw 2.7 VA locking screw
Shaft Screws	2.4 cortex screw 2.7 cortex screw 2.7 locking screw
Material	PT

Code	Model No.	Size	Direction	Length (mm)
24279102	SDDG16	7+2H	R	54
24279103	SDDG16	7+3H	R	63
24279104	SDDG16	7+4H	R	72
24279105	SDDG16	7+5H	R	81
24279202	SDDG15	7+2H	L	54
24279203	SDDG15	7+3H	L	63
24279204	SDDG15	7+4H	L	72
24279205	SDDG15	7+5H	L	81

# VariLoc Locking Compression Plate System

## Hand & Wrist

Distal Radius Volar Column Locking Compression Plate II, 2.4/2.7



Thickness (mm)	1.8
Width (mm)	8.5
Hole Space (mm)	9
Head Screws	2.4 locking screw 2.7 locking screw 2.4 VA locking screw 2.7 VA locking screw
Shaft Screws	2.4 cortex screw 2.7 cortex screw 2.7 locking screw
Material	PT

Code	Model No.	Size	Direction	Length (mm)
24259103	SDXG59	8+3H	R	46.5
24259104	SDXG59	8+4H	R	55.5
24259105	SDXG59	8+5H	R	64.5
24259106	SDXG59	8+6H	R	73.5
24259107	SDXG59	8+7H	R	82.5
24259108	SDXG59	8+8H	R	91.5
24259109	SDXG59	8+9H	R	100.5
24259110	SDXG59	8+10H	R	109.5
24259111	SDXG59	8+11H	R	118.5
24259112	SDXG59	8+12H	R	127.5
24259203	SDXG59	8+3H	L	46.5
24259204	SDXG59	8+4H	L	55.5
24259205	SDXG59	8+5H	L	64.5
24259206	SDXG59	8+6H	L	73.5
24259207	SDXG59	8+7H	L	82.5
24259208	SDXG59	8+8H	L	91.5
24259209	SDXG59	8+9H	L	100.5
24259210	SDXG59	8+10H	L	109.5
24259211	SDXG59	8+11H	L	118.5
24259212	SDXG59	8+12H	L	127.5

Distal Radius Volar Locking Compression Plate, oblique T, 2.4/2.7



Thickness (mm)	2
Width (mm)	7.5
Hole Space (mm)	8
Head Screws	2.4 locking screw 2.7 locking screw 2.4 VA locking screw 2.7 VA locking screw
Shaft Screws	2.4 cortex screw 2.7 cortex screw 2.7 locking screw
Material	PT

Code	Model No.	Size	Direction	Length (mm)
24284103	SDXG54	5+3H	R	45
24284104	SDXG54	5+4H	R	53
24284105	SDXG54	5+5H	R	61
24284106	SDXG54	5+6H	R	69
24284107	SDXG54	5+7H	R	77
24284108	SDXG54	5+8H	R	85
24284109	SDXG54	5+9H	R	93
24284110	SDXG54	5+10H	R	101
24284111	SDXG54	5+11H	R	109
24284112	SDXG54	5+12H	R	117
24284203	SDXG53	5+3H	L	45
24284204	SDXG53	5+4H	L	53
24284205	SDXG53	5+5H	L	61
24284206	SDXG53	5+6H	L	69
24284207	SDXG53	5+7H	L	77
24284208	SDXG53	5+8H	L	85
24284209	SDXG53	5+9H	L	93
24284210	SDXG53	5+10H	L	101
24284211	SDXG53	5+11H	L	109
24284212	SDXG53	5+12H	L	117

# VariLoc Locking Compression Plate System

## Hand & Wrist

Distal Dorsal Radius Locking Compression Plate, oblique L, 2.4/2.7



Specification	
Thickness (mm)	1.8
Width (mm)	6.5
Hole Space (mm)	10
Head Screws	2.4 locking screw
	2.7 locking screw
	2.4 VA locking screw
	2.7 VA locking screw
Shaft Screws	2.4 cortex screw
	2.7 cortex screw
	2.7 locking screw
Material	PT

Code	Model No.	Size	Direction	Length (mm)
24275103	SDXG52	3+3H	R	43
24275104	SDXG52	3+4H	R	52
24275203	SDXG51	3+3H	L	43
24275204	SDXG51	3+4H	L	52

Distal Dorsal Radius Locking Compression Plate II, 2.4/2.7



Specification	
Thickness (mm)	1.5
Width (mm)	6.5
Hole Space (mm)	9
Head Screws	2.4 locking screw
	2.7 locking screw
	2.4 VA locking screw
	2.7 VA locking screw
Shaft Screws	2.4 cortex screw
	2.7 cortex screw
	2.7 locking screw
Material	PT

Code	Model No.	Size	Direction	Length (mm)
24277105	SDXG34	2+3H	R	40
24277106	SDXG34	2+4H	R	49
24277205	SDXG35	2+3H	L	40
24277206	SDXG35	2+4H	L	49

Distal Dorsal Radius T-Locking Compression Plate, 2.4/2.7



Specification	
Thickness (mm)	1.8
Width (mm)	6.5
Hole Space (mm)	12
Head Screws	2.4 locking screw
	2.7 locking screw
	2.4 VA locking screw
	2.7 VA locking screw
Shaft Screws	2.4 cortex screw
	2.7 cortex screw
	2.7 locking screw
Material	PT

Code	Model No.	Size	Length (mm)
24276003	SDXG43	3+3H	42
24276004	SDXG43	3+4H	54
24276005	SDXG43	3+5H	66
24276006	SDXG43	3+6H	78
24276007	SDXG43	3+7H	90
24276008	SDXG43	3+8H	102

Distal Lateral Radius Locking Compression Plate, 2.4/2.7



Specification	
Thickness (mm)	2
Width (mm)	7
Hole Space (mm)	9
Head Screws	2.4 locking screw
	2.7 locking screw
	2.4 VA locking screw
	2.7 VA locking screw
Shaft Screws	2.4 cortex screw
	2.7 cortex screw
	2.7 locking screw
Material	PT

Code	Model No.	Size	Length (mm)
24286005	SDXG33	5H	48
24286006	SDXG33	6H	57

# VariLoc Locking Compression Plate System

## Hand & Wrist

Distal Lateral Ulna Locking Compression Plate, 2.4/2.7



Specification	
Thickness (mm)	2.3
Width (mm)	6.5
Hole Space (mm)	9
Head Screws	2.4 locking screw
	2.7 locking screw
	2.4 VA locking screw
	2.7 VA locking screw
Shaft Screws	2.4 cortex screw
	2.7 cortex screw
	2.7 locking screw
Material	PT

Code	Model No.	Size	Length (mm)
24289006	SDXG33	6H	57
24289007	SDXG33	7H	66

# VariLoc Locking Compression Plate System

## Hip/Pelvis

Proximal Lateral Femoral Plate 7.0



Thickness (mm)	6
Width (mm)	12
Hole Space (mm)	16
Head Screws	7.0 cannulated locking screw
Shaft Screws	5.0 locking screw
Material	PT

Code	Model No.	Size	Direction	Length (mm)
24252101	SDDZ11	3+1H	R	59
24252102	SDDZ11	3+2H	R	75
24252103	SDDZ11	3+3H	R	91
24252201	SDDZ10	3+1H	L	59
24252202	SDDZ10	3+2H	L	75
24252203	SDDZ10	3+3H	L	91

Proximal Lateral Femoral Locking Compression Plate 5.0



Thickness (mm)	5.0
Width (mm)	18.0
Head Screws	5.0 VA locking screw 5.0 locking screw
Shaft Screws	5.5 cannulated locking screws 5.0 locking screw 4.5 cortex screw
Material	PT

Code	Model No.	Size	Direction	Length (mm)
24212108	SDDG46	5+3H	R	125
24212109	SDDG46	5+4H	R	145
24212111	SDDG46	5+6H	R	185
24212113	SDDG46	5+8H	R	225
24212115	SDDG46	5+10H	R	265
24212117	SDDG46	5+12H	R	305
24212208	SDDG47	5+3H	L	125
24212209	SDDG47	5+4H	L	145
24212211	SDDG47	5+6H	L	185
24212213	SDDG47	5+8H	L	225
24212215	SDDG47	5+10H	L	265
24212217	SDDG47	5+12H	L	305

# VariLoc Locking Compression Plate System

## Knee

Distal Lateral Femoral Locking Compression Plate 5.0



Thickness (mm)	5.8
Width (mm)	16
Hole Space (mm)	20
Head Screws	5.0 locking screw 5.0 VA locking screw 5.5 cannulated locking screw
Shaft Screws	4.5 cortex screw 5.0 locking screw
Material	PT

Code	Model No.	Size	Direction	Length (mm)
24260105	SDDG53	7+5H	R	156
24260107	SDDG53	7+7H	R	196
24260109	SDDG53	7+9H	R	236
24260111	SDDG53	7+11H	R	276
24260113	SDDG53	7+13H	R	316
24260205	SDDG52	7+5H	L	156
24260207	SDDG52	7+7H	L	196
24260209	SDDG52	7+9H	L	236
24260211	SDDG52	7+11H	L	276
24260213	SDDG52	7+13H	L	316

Proximal Lateral Tibia L Locking Compression Plate 3.5



Thickness (mm)	4
Width (mm)	14
Hole Space (mm)	20
Head Screws	3.5 locking screw 3.5 VA locking screw
Shaft Screws	4.0 cannulated locking screw 3.5 cortex screw 3.5 locking screw
Material	PT

Code	Model No.	Size	Direction	Length (mm)
24269109	SDDG48	4+9H	R	120
24269110	SDDG48	4+10H	R	140
24269111	SDDG48	4+11H	R	160
24269112	SDDG48	4+12H	R	180
24269113	SDDG48	4+13H	R	200
24269114	SDDG48	4+14H	R	220
24269115	SDDG48	4+15H	R	240
24269209	SDDG49	4+9H	L	120
24269210	SDDG49	4+10H	L	140
24269211	SDDG49	4+11H	L	160
24269212	SDDG49	4+12H	L	180
24269213	SDDG49	4+13H	L	200
24269214	SDDG49	4+14H	L	220
24269215	SDDG49	4+15H	L	240



# VariLoc Locking Compression Plate System

## Knee

Proximal Lateral Tibia Locking Compression Plates, 5.0



Thickness (mm)	4.4
Width (mm)	16.0
Head Screws	5.0 VA locking screw 5.0 locking screw
Shaft Screws	5.5 cannulated locking screws 5.0 locking screw 4.5 cortex screw
Material	PT

Code	Model No.	Size	Direction	Length (mm)
24214108	SDDG48	5+3H	R	100
24214109	SDDG48	5+4H	R	120
24214110	SDDG48	5+5H	R	140
24214112	SDDG48	5+7H	R	180
24214114	SDDG48	5+9H	R	220
24214116	SDDG48	5+11H	R	260
24214118	SDDG48	5+13H	R	300
24214208	SDDG49	5+3H	L	100
24214209	SDDG49	5+4H	L	120
24214210	SDDG49	5+5H	L	140
24214212	SDDG49	5+7H	L	180
24214214	SDDG49	5+9H	L	220
24214216	SDDG49	5+11H	L	260
24214218	SDDG49	5+13H	L	300

Proximal Medial Posterior Tibial Locking Compression Plates, 3.5



Thickness (mm)	3.2
Width (mm)	14.2
Head Screws	3.5 VA locking screw 3.5 locking screw 4.0 cannulated locking screws
Shaft Screws	3.5 locking screw 3.5 cortex screw
Material	PT

Code	Model No.	Size	Length (mm)
24219003	SDXG33	3+3H	68
24219004	SDXG33	3+4H	84
24219006	SDXG33	3+6H	116
24219008	SDXG33	3+8H	148
24219010	SDXG33	3+10H	180

# VariLoc Locking Compression Plate System

## Foot & Ankle

Lateral Distal Fibular Locking Compression Plate 2.7/3.5



Thickness (mm)	2.3
Width (mm)	10.5
Hole Space (mm)	13
Head Screws	2.7 locking screw 2.7 VA locking screw
Shaft Screws	3.5 cortex screw 3.5 locking screw
Material	PT

Code	Model No.	Size	Direction	Length (mm)
24261108	SDDG19	5+3H	R	86
24261109	SDDG19	5+4H	R	99
24261110	SDDG19	5+5H	R	112
24261111	SDDG19	5+6H	R	125
24261112	SDDG19	5+7H	R	138
24261114	SDDG19	5+9H	R	164
24261116	SDDG19	5+11H	R	190
24261118	SDDG19	5+13H	R	216
24261120	SDDG19	5+15H	R	242
24261208	SDDG20	5+3H	L	86
24261209	SDDG20	5+4H	L	99
24261210	SDDG20	5+5H	L	112
24261211	SDDG20	5+6H	L	125
24261212	SDDG20	5+7H	L	138
24261214	SDDG20	5+9H	L	164
24261216	SDDG20	5+11H	L	190
24261218	SDDG20	5+13H	L	216
24261220	SDDG20	5+15H	L	242

Anterolateral Distal Tibia L Locking Compression Plates, 3.5



Thickness (mm)	4.0
Width (mm)	14.0
Head Screws	3.5 VA locking screw 3.5 locking screw 4.0 cannulated locking screws
Shaft Screws	3.5 locking screw 3.5 cortex screw
Material	PT

Code	Model No.	Size	Direction	Length (mm)
24215109	SDDG50	4+5H	R	117
24215111	SDDG50	4+7H	R	149
24215113	SDDG50	4+9H	R	181
24215115	SDDG50	4+11H	R	213
24215117	SDDG50	4+13H	R	245
24215119	SDDG50	4+15H	R	277
24215209	SDDG51	4+5H	L	117
24215211	SDDG51	4+7H	L	149
24215213	SDDG51	4+9H	L	181
24215215	SDDG51	4+11H	L	213
24215217	SDDG51	4+13H	L	245
24215219	SDDG51	4+15H	L	277

# VariLoc Locking Compression Plate System

## Foot & Ankle

Distal Tibia Locking Compression Plates II, 2.7/3.5



Thickness (mm)	3.6
Width (mm)	13.7
Head Screws	2.7 VA locking screw 2.7 locking screw
Shaft Screws	3.5 locking screw 3.5 cortex screw
Material	PT

Code	Model No.	Size	Direction	Length (mm)
24217104	SDDG59	8+4H	R	116
24217106	SDDG59	8+6H	R	142
24217108	SDDG59	8+8H	R	168
24217110	SDDG59	8+10H	R	194
24217112	SDDG59	8+12H	R	220
24217204	SDDG59	8+4H	L	116
24217206	SDDG59	8+6H	L	142
24217208	SDDG59	8+8H	L	168
24217210	SDDG59	8+10H	L	194
24217212	SDDG59	8+12H	L	220

Distal Medial Tibia Locking Compression Plates (with tip), 2.7/3.5



Thickness (mm)	3.6
Width (mm)	11.7
Head Screws	2.7 VA locking screw 2.7 locking screw
Shaft Screws	3.5 locking screw 3.5 cortex screw
Material	PT

Code	Model No.	Size	Direction	Length (mm)
24220104	SDDG45	9+4H	R	116
24220106	SDDG45	9+6H	R	142
24220108	SDDG45	9+8H	R	168
24220110	SDDG45	9+10H	R	194
24220112	SDDG45	9+12H	R	220
24220114	SDDG45	9+14H	R	246
24220204	SDDG44	9+4H	L	116
24220206	SDDG44	9+6H	L	142
24220208	SDDG44	9+8H	L	168
24220210	SDDG44	9+10H	L	194
24220212	SDDG44	9+12H	L	220
24220214	SDDG44	9+14H	L	246

Calcaneus Locking Plate II 3.5



Thickness (mm)	1.5
Width (mm)	36
Screws	3.5 locking screw
Material	PT

Code	Model No.	Size	Length (mm)
24263013	SDXZ66	13H	60
24263014	SDXZ66	14H	64
24263015	SDXZ66	15H	70
24263016	SDXZ66	16H	78

Calcaneus Locking Plate III 3.5



Thickness (mm)	1.5
Width (mm)	36
Screws	3.5 locking screw
Material	PT

Code	Model No.	Size	Length (mm)
24264060	SDXZ67	12H	60
24264068	SDXZ67	12H	68

# VariLoc Locking Compression Plate System

## Bone Shaft

Straight Locking Compression Plate 3.5, thickness 2.0



Thickness (mm)	2
Width (mm)	9.5
Hole Space (mm)	13
Screws	3.5 cortex screw 3.5 locking screw
Material	PT

Code	Model No.	Size	Length (mm)
24267004	SDXG11	4H	60
24267005	SDXG11	5H	73
24267006	SDXG11	6H	86
24267007	SDXG11	7H	99
24267008	SDXG11	8H	112
24267010	SDXG11	10H	138
24267012	SDXG11	12H	164

Straight Locking Compression Plate 3.5, thickness 3.8



Thickness (mm)	3.8
Width (mm)	12
Hole Space (mm)	13
Screws	3.5 cortex screw 3.5 locking screw
Material	PT

Code	Model No.	Size	Length (mm)
24268004	SDXG37	4H	51
24268005	SDXG37	5H	64
24268006	SDXG37	6H	77
24268007	SDXG37	7H	90
24268008	SDXG37	8H	103
24268009	SDXG37	9H	116
24268010	SDXG37	10H	129
24268011	SDXG37	11H	142
24268012	SDXG37	12H	155
24268014	SDXG37	14H	181
24268016	SDXG37	16H	207

Straight Locking Compression Plate 3.5, thickness 3.2



Thickness (mm)	3.2
Width (mm)	10.5
Hole Space (mm)	13
Screws	3.5 cortex screw 3.5 locking screw
Material	PT

Code	Model No.	Size	Length (mm)
24266004	SDXG11	4H	60
24266005	SDXG11	5H	73
24266006	SDXG11	6H	86
24266007	SDXG11	7H	99
24266008	SDXG11	8H	112
24266009	SDXG11	9H	125
24266010	SDXG11	10H	138
24266011	SDXG11	11H	151
24266012	SDXG11	12H	164
24266014	SDXG11	14H	190
24266016	SDXG11	16H	216

Straight Locking Compression Plate 3.5, thickness 4.0



Thickness (mm)	4
Width (mm)	14
Hole Space (mm)	13
Screws	3.5 cortex screw 3.5 locking screw
Material	PT

Code	Model No.	Size	Length (mm)
24274004	SDXG37	4H	51
24274005	SDXG37	5H	64
24274006	SDXG37	6H	77
24274007	SDXG37	7H	90
24274008	SDXG37	8H	103
24274009	SDXG37	9H	116
24274010	SDXG37	10H	129
24274011	SDXG37	11H	142
24274012	SDXG37	12H	155
24274014	SDXG37	14H	181
24274016	SDXG37	16H	207

## VariLoc Locking Compression Plate System

### Bone Shaft

Straight Locking Compression Plate  
4.5/5.0



Thickness (mm)	5.8
Width (mm)	15.5
Hole Space (mm)	18
Screws	4.5 cortex screw 5.0 locking screw
Material	PT

Code	Model No.	Size	Length (mm)
24265006	SDDG39	6H	107
24265007	SDDG39	7H	125
24265008	SDDG39	8H	143
24265009	SDDG39	9H	161
24265010	SDDG39	10H	179
24265011	SDDG39	11H	197
24265012	SDDG39	12H	215
24265013	SDDG39	13H	233
24265014	SDDG39	14H	251
24265015	SDDG39	15H	269
24265016	SDDG39	16H	287
24265017	SDDG39	17H	305
24265018	SDDG39	18H	323

## VariLoc Locking Compression Plate System

### Screws

Cortex Screw, Fully Threaded,  
Self-tapping, 2.4



Thread dia.	Φ2.4 mm
Shaft dia.	Φ1.8 mm
Drill bit	Φ1.8 mm
Material	TA

Code	Model No.	Size
30374006	HAQ06	Φ2.4×6
30374008	HAQ06	Φ2.4×8
30374010	HAQ06	Φ2.4×10
30374012	HAQ06	Φ2.4×12
30374014	HAQ06	Φ2.4×14
30374016	HAQ06	Φ2.4×16
30374018	HAQ06	Φ2.4×18
30374020	HAQ06	Φ2.4×20
30374022	HAQ06	Φ2.4×22
30374024	HAQ06	Φ2.4×24
30374026	HAQ06	Φ2.4×26
30374028	HAQ06	Φ2.4×28
30374030	HAQ06	Φ2.4×30
30374032	HAQ06	Φ2.4×32
30374034	HAQ06	Φ2.4×34
30374036	HAQ06	Φ2.4×36
30374038	HAQ06	Φ2.4×38
30374040	HAQ06	Φ2.4×40

Cortex Screw, Fully Threaded,  
Self-tapping, 2.7



Thread dia.	Φ2.7 mm
Shaft dia.	Φ1.9 mm
Drill bit	Φ2.0 mm
Material	TA

Code	Model No.	Size
30375006	HAQ06	Φ2.7×6
30375008	HAQ06	Φ2.7×8
30375010	HAQ06	Φ2.7×10
30375012	HAQ06	Φ2.7×12
30375014	HAQ06	Φ2.7×14
30375016	HAQ06	Φ2.7×16
30375018	HAQ06	Φ2.7×18
30375020	HAQ06	Φ2.7×20
30375022	HAQ06	Φ2.7×22
30375024	HAQ06	Φ2.7×24
30375026	HAQ06	Φ2.7×26
30375028	HAQ06	Φ2.7×28
30375030	HAQ06	Φ2.7×30
30375032	HAQ06	Φ2.7×32
30375034	HAQ06	Φ2.7×34
30375036	HAQ06	Φ2.7×36
30375038	HAQ06	Φ2.7×38
30375040	HAQ06	Φ2.7×40

## VariLoc Locking Compression Plate System

### Screws

Cortex Screw, Fully Threaded,  
Self-tapping, 3.5



Thread dia.	Φ3.5 mm
Shaft dia.	Φ2.7 mm
Drill bit	Φ2.5 mm
Material	TA

Code	Model No.	Size
30387010	HAQ06	Φ3.5x10
30387012	HAQ06	Φ3.5x12
30387014	HAQ06	Φ3.5x14
30387016	HAQ06	Φ3.5x16
30387018	HAQ06	Φ3.5x18
30387020	HAQ06	Φ3.5x20
30387022	HAQ06	Φ3.5x22
30387024	HAQ06	Φ3.5x24
30387026	HAQ06	Φ3.5x26
30387028	HAQ06	Φ3.5x28
30387030	HAQ06	Φ3.5x30
30387032	HAQ06	Φ3.5x32
30387034	HAQ06	Φ3.5x34
30387036	HAQ06	Φ3.5x36
30387038	HAQ06	Φ3.5x38
30387040	HAQ06	Φ3.5x40
30387045	HAQ06	Φ3.5x45
30387050	HAQ06	Φ3.5x50
30387055	HAQ06	Φ3.5x55
30387060	HAQ06	Φ3.5x60

Cortex Screw, Fully Threaded,  
Self-tapping, 4.5



Thread dia.	Φ4.5 mm
Shaft dia.	Φ3.0 mm
Drill bit	Φ3.2 mm
Material	TA

Code	Model No.	Size
30386012	HAQ06	Φ4.5x12
30386014	HAQ06	Φ4.5x14
30386016	HAQ06	Φ4.5x16
30386018	HAQ06	Φ4.5x18
30386020	HAQ06	Φ4.5x20
30386022	HAQ06	Φ4.5x22
30386024	HAQ06	Φ4.5x24
30386026	HAQ06	Φ4.5x26
30386028	HAQ06	Φ4.5x28
30386030	HAQ06	Φ4.5x30
30386032	HAQ06	Φ4.5x32
30386034	HAQ06	Φ4.5x34
30386036	HAQ06	Φ4.5x36
30386038	HAQ06	Φ4.5x38
30386040	HAQ06	Φ4.5x40
30386042	HAQ06	Φ4.5x42
30386044	HAQ06	Φ4.5x44
30386046	HAQ06	Φ4.5x46
30386048	HAQ06	Φ4.5x48
30386050	HAQ06	Φ4.5x50
30386052	HAQ06	Φ4.5x52
30386054	HAQ06	Φ4.5x54
30386056	HAQ06	Φ4.5x56
30386058	HAQ06	Φ4.5x58
30386060	HAQ06	Φ4.5x60
30386062	HAQ06	Φ4.5x62
30386064	HAQ06	Φ4.5x64
30386065	HAQ06	Φ4.5x65
30386070	HAQ06	Φ4.5x70
30386075	HAQ06	Φ4.5x75
30386080	HAQ06	Φ4.5x80

## VariLoc Locking Compression Plate System

### Screws

Locking Screw, Self-tapping, 2.4



Thread dia.	Φ2.4 mm
Shaft dia.	Φ1.9 mm
Drill bit	Φ1.8 mm
Material	TA

Code	Model No.	Size
34270006	SDL03	Φ2.4x6
34270007	SDL03	Φ2.4x7
34270008	SDL03	Φ2.4x8
34270009	SDL03	Φ2.4x9
34270010	SDL03	Φ2.4x10
34270011	SDL03	Φ2.4x11
34270012	SDL03	Φ2.4x12
34270013	SDL03	Φ2.4x13
34270014	SDL03	Φ2.4x14
34270016	SDL03	Φ2.4x16
34270018	SDL03	Φ2.4x18
34270020	SDL03	Φ2.4x20
34270022	SDL03	Φ2.4x22
34270024	SDL03	Φ2.4x24
34270026	SDL03	Φ2.4x26
34270028	SDL03	Φ2.4x28
34270030	SDL03	Φ2.4x30
34270032	SDL03	Φ2.4x32
34270034	SDL03	Φ2.4x34
34270036	SDL03	Φ2.4x36
34270038	SDL03	Φ2.4x38
34270040	SDL03	Φ2.4x40
34270042	SDL03	Φ2.4x42
34270044	SDL03	Φ2.4x44
34270046	SDL03	Φ2.4x46
34270048	SDL03	Φ2.4x48
34270050	SDL03	Φ2.4x50
34270052	SDL03	Φ2.4x52
34270054	SDL03	Φ2.4x54
34270056	SDL03	Φ2.4x56
34270058	SDL03	Φ2.4x58
34270060	SDL03	Φ2.4x60

Locking Screw, Self-tapping, 2.7



Thread dia.	Φ2.7 mm
Shaft dia.	Φ2.1 mm
Drill bit	Φ2.0 mm
Material	TA

Code	Model No.	Size
34253006	SDL03	Φ2.7x6
34253007	SDL03	Φ2.7x7
34253008	SDL03	Φ2.7x8
34253009	SDL03	Φ2.7x9
34253010	SDL03	Φ2.7x10
34253011	SDL03	Φ2.7x11
34253012	SDL03	Φ2.7x12
34253013	SDL03	Φ2.7x13
34253014	SDL03	Φ2.7x14
34253016	SDL03	Φ2.7x16
34253018	SDL03	Φ2.7x18
34253020	SDL03	Φ2.7x20
34253022	SDL03	Φ2.7x22
34253024	SDL03	Φ2.7x24
34253026	SDL03	Φ2.7x26
34253028	SDL03	Φ2.7x28
34253030	SDL03	Φ2.7x30
34253032	SDL03	Φ2.7x32
34253034	SDL03	Φ2.7x34
34253036	SDL03	Φ2.7x36
34253038	SDL03	Φ2.7x38
34253040	SDL03	Φ2.7x40



# VariLoc Locking Compression Plate System

## Screws

### Locking Screw, Self-tapping, 3.5



Thread dia.	Φ3.5 mm
Shaft dia.	Φ2.7 mm
Drill bit	Φ2.7 mm
Material	TA

Code	Model No.	Size
34254010	SDLD03	Φ3.5×10
34254012	SDLD03	Φ3.5×12
34254014	SDLD03	Φ3.5×14
34254015	SDLD03	Φ3.5×15
34254016	SDLD03	Φ3.5×16
34254018	SDLD03	Φ3.5×18
34254020	SDLD03	Φ3.5×20
34254022	SDLD03	Φ3.5×22
34254024	SDLD03	Φ3.5×24
34254025	SDLD03	Φ3.5×25
34254026	SDLD03	Φ3.5×26
34254028	SDLD03	Φ3.5×28
34254030	SDLD03	Φ3.5×30
34254032	SDLD03	Φ3.5×32
34254034	SDLD03	Φ3.5×34
34254035	SDLD03	Φ3.5×35
34254036	SDLD03	Φ3.5×36
34254038	SDLD03	Φ3.5×38
34254040	SDLD03	Φ3.5×40
34254045	SDLD03	Φ3.5×45
34254050	SDLD03	Φ3.5×50
34254055	SDLD03	Φ3.5×55
34254060	SDLD03	Φ3.5×60
34254065	SDLD03	Φ3.5×65
34254070	SDLD03	Φ3.5×70
34254075	SDLD03	Φ3.5×75
34254080	SDLD03	Φ3.5×80

### Locking Screw, Self-tapping, 5.0



Thread dia.	Φ5.0 mm
Shaft dia.	Φ4.2 mm
Drill bit	Φ4.2 mm
Material	TA

Code	Model No.	Size
34255014	SDLD03	Φ5.0×14
34255015	SDLD03	Φ5.0×15
34255016	SDLD03	Φ5.0×16
34255018	SDLD03	Φ5.0×18
34255020	SDLD03	Φ5.0×20
34255022	SDLD03	Φ5.0×22
34255024	SDLD03	Φ5.0×24
34255025	SDLD03	Φ5.0×25
34255026	SDLD03	Φ5.0×26
34255028	SDLD03	Φ5.0×28
34255030	SDLD03	Φ5.0×30
34255032	SDLD03	Φ5.0×32
34255034	SDLD03	Φ5.0×34
34255035	SDLD03	Φ5.0×35
34255036	SDLD03	Φ5.0×36
34255038	SDLD03	Φ5.0×38
34255040	SDLD03	Φ5.0×40
34255042	SDLD03	Φ5.0×42
34255044	SDLD03	Φ5.0×44
34255045	SDLD03	Φ5.0×45
34255046	SDLD03	Φ5.0×46
34255048	SDLD03	Φ5.0×48
34255050	SDLD03	Φ5.0×50
34255055	SDLD03	Φ5.0×55
34255060	SDLD03	Φ5.0×60
34255065	SDLD03	Φ5.0×65
34255070	SDLD03	Φ5.0×70
34255075	SDLD03	Φ5.0×75
34255080	SDLD03	Φ5.0×80
34255085	SDLD03	Φ5.0×85
34255090	SDLD03	Φ5.0×90

# VariLoc Locking Compression Plate System

## Screws

### Variable Angle Locking Screws, Self-tapping, 2.4



Thread dia.	Φ2.4 mm
Shaft dia.	Φ1.9 mm
Drill bit	Φ1.8 mm
Material	TA

Code	Model No.	Size
31480006	DJY-IV	Φ2.4×6
31480008	DJY-IV	Φ2.4×8
31480010	DJY-IV	Φ2.4×10
31480012	DJY-IV	Φ2.4×12
31480014	DJY-IV	Φ2.4×14
31480016	DJY-IV	Φ2.4×16
31480018	DJY-IV	Φ2.4×18
31480020	DJY-IV	Φ2.4×20
31480022	DJY-IV	Φ2.4×22
31480024	DJY-IV	Φ2.4×24
31480026	DJY-IV	Φ2.4×26
31480028	DJY-IV	Φ2.4×28
31480030	DJY-IV	Φ2.4×30
31480032	DJY-IV	Φ2.4×32
31480034	DJY-IV	Φ2.4×34
31480036	DJY-IV	Φ2.4×36
31480038	DJY-IV	Φ2.4×38
31480040	DJY-IV	Φ2.4×40

### Variable Angle Locking Screws, Self-tapping, 2.7



Thread dia.	Φ2.7 mm
Shaft dia.	Φ2.1 mm
Drill bit	Φ2.0 mm
Material	TA

Code	Model No.	Size
31477106	DJY-IV	Φ2.7×6
31477108	DJY-IV	Φ2.7×8
31477110	DJY-IV	Φ2.7×10
31477112	DJY-IV	Φ2.7×12
31477114	DJY-IV	Φ2.7×14
31477116	DJY-IV	Φ2.7×16
31477118	DJY-IV	Φ2.7×18
31477120	DJY-IV	Φ2.7×20
31477122	DJY-IV	Φ2.7×22
31477124	DJY-IV	Φ2.7×24
31477126	DJY-IV	Φ2.7×26
31477128	DJY-IV	Φ2.7×28
31477130	DJY-IV	Φ2.7×30
31477132	DJY-IV	Φ2.7×32
31477134	DJY-IV	Φ2.7×34
31477136	DJY-IV	Φ2.7×36
31477138	DJY-IV	Φ2.7×38
31477140	DJY-IV	Φ2.7×40

## VariLoc Locking Compression Plate System

### Screws

Variable Angle Locking Screws,  
Self-tapping, 3.5



Thread dia.	Φ3.5 mm
Shaft dia.	Φ2.7 mm
Drill bit	Φ2.7 mm
Material	TA

Code	Model No.	Size
31478110	DJY-IV	Φ3.5×10
31478112	DJY-IV	Φ3.5×12
31478114	DJY-IV	Φ3.5×14
31478116	DJY-IV	Φ3.5×16
31478118	DJY-IV	Φ3.5×18
31478120	DJY-IV	Φ3.5×20
31478122	DJY-IV	Φ3.5×22
31478124	DJY-IV	Φ3.5×24
31478126	DJY-IV	Φ3.5×26
31478128	DJY-IV	Φ3.5×28
31478130	DJY-IV	Φ3.5×30
31478132	DJY-IV	Φ3.5×32
31478134	DJY-IV	Φ3.5×34
31478136	DJY-IV	Φ3.5×36
31478138	DJY-IV	Φ3.5×38
31478140	DJY-IV	Φ3.5×40
31478146	DJY-IV	Φ3.5×46
31478150	DJY-IV	Φ3.5×50
31478156	DJY-IV	Φ3.5×56
31478160	DJY-IV	Φ3.5×60
31478166	DJY-IV	Φ3.5×66
31478170	DJY-IV	Φ3.5×70
31478176	DJY-IV	Φ3.5×76
31478180	DJY-IV	Φ3.5×80

Variable Angle Locking Screws,  
Self-tapping, 5.0



Thread dia.	Φ5.0 mm
Shaft dia.	Φ4.2 mm
Drill bit	Φ4.2 mm
Material	TA

Code	Model No.	Size
31479112	DJY-IV	Φ5.0×12
31479115	DJY-IV	Φ5.0×15
31479118	DJY-IV	Φ5.0×18
31479120	DJY-IV	Φ5.0×20
31479122	DJY-IV	Φ5.0×22
31479125	DJY-IV	Φ5.0×25
31479128	DJY-IV	Φ5.0×28
31479130	DJY-IV	Φ5.0×30
31479132	DJY-IV	Φ5.0×32
31479135	DJY-IV	Φ5.0×35
31479138	DJY-IV	Φ5.0×38
31479140	DJY-IV	Φ5.0×40
31479142	DJY-IV	Φ5.0×42
31479145	DJY-IV	Φ5.0×45
31479148	DJY-IV	Φ5.0×48
31479150	DJY-IV	Φ5.0×50
31479155	DJY-IV	Φ5.0×55
31479160	DJY-IV	Φ5.0×60
31479165	DJY-IV	Φ5.0×65
31479170	DJY-IV	Φ5.0×70
31479175	DJY-IV	Φ5.0×75
31479180	DJY-IV	Φ5.0×80
31479185	DJY-IV	Φ5.0×85
31479190	DJY-IV	Φ5.0×90
31479195	DJY-IV	Φ5.0×95
31479196	DJY-IV	Φ5.0×100

## VariLoc Locking Compression Plate System

### Screws

Cannulated Locking Screw,  
Partial Threaded, 4.0



Thread dia.	Φ4.0 mm
Shaft dia.	Φ3.0 mm
Inner hole	Φ1.1 mm
Drill bit size	Cannulated Drill Bit, Φ3.0/3.5mm
K wire size	Φ1.0 mm
Thread length (mm)	16/32mm
Material	TA

Code	Model No.	Thread Size	Size
31475232	DJY-V	16mm	Φ4.0×32
31475240	DJY-V	16mm	Φ4.0×40
31475248	DJY-V	16mm	Φ4.0×48
31475255	DJY-V	16mm	Φ4.0×55
31475258	DJY-V	32mm	Φ4.0×58
31475262	DJY-V	16mm	Φ4.0×62
31475265	DJY-V	32mm	Φ4.0×65
31475270	DJY-V	16mm	Φ4.0×70
31475272	DJY-V	32mm	Φ4.0×72
31475278	DJY-V	16mm	Φ4.0×78
31475280	DJY-V	32mm	Φ4.0×80
31475285	DJY-V	16mm	Φ4.0×85
31475288	DJY-V	32mm	Φ4.0×88

Cannulated Locking Screw,  
Partial Threaded, 5.5



Thread dia.	Φ5.5 mm
Shaft dia.	Φ4.5 mm
Inner hole	Φ1.7 mm
Drill bit size	Cannulated Drill Bit, Φ4.5/5.0mm
K wire size	Φ1.6 mm
Thread length (mm)	16/22/32mm
Material	TA

Code	Model No.	Thread Size	Size
31476250	DJY-V	16mm	Φ5.5×50
31476255	DJY-V	22mm	Φ5.5×55
31476262	DJY-V	22mm	Φ5.5×62
31476265	DJY-V	16mm	Φ5.5×65
31476270	DJY-V	22mm	Φ5.5×70
31476272	DJY-V	16mm	Φ5.5×72
31476278	DJY-V	32mm	Φ5.5×78
31476280	DJY-V	16mm	Φ5.5×80
31476285	DJY-V	32mm	Φ5.5×85
31476292	DJY-V	32mm	Φ5.5×92
31476293	DJY-V	32mm	Φ5.5×100

## VariLoc Locking Compression Plate System

### Screws

#### Cannulated Locking Screw, 32mm thread



Thread dia.	Φ7.0 mm
Shaft dia.	Φ4.5 mm
Inner hole	Φ2.6 mm
Drill bit size	Cannulated Drill Bit, Φ 4.5/6.5mm
K wire size	Φ2.5 mm
Thread length (mm)	32mm
Material	TA

Code	Model No.	Size
31474070	DJY-V	Φ7.0×70
31474075	DJY-V	Φ7.0×75
31474078	DJY-V	Φ7.0×78
31474082	DJY-V	Φ7.0×82
31474085	DJY-V	Φ7.0×85
31474090	DJY-V	Φ7.0×90
31474095	DJY-V	Φ7.0×95
31474100	DJY-V	Φ7.0×100
31474105	DJY-V	Φ7.0×105
31474110	DJY-V	Φ7.0×110
31474115	DJY-V	Φ7.0×115
31474120	DJY-V	Φ7.0×120
31474125	DJY-V	Φ7.0×125
31474130	DJY-V	Φ7.0×130
31474135	DJY-V	Φ7.0×135
31474140	DJY-V	Φ7.0×140

#### Cannulated Locking Screw, 16mm thread



Thread dia.	Φ7.0 mm
Shaft dia.	Φ4.5 mm
Inner hole	Φ2.6 mm
Drill bit size	Cannulated Drill Bit, Φ 4.5/6.5mm
K wire size	Φ2.5 mm
Thread length (mm)	16mm
Material	TA

Code	Model No.	Size
31474068	DJY-V	Φ7.0×68
31474072	DJY-V	Φ7.0×72
31474080	DJY-V	Φ7.0×80
31474088	DJY-V	Φ7.0×88
31474092	DJY-V	Φ7.0×92
31474098	DJY-V	Φ7.0×98
31474102	DJY-V	Φ7.0×102
31474108	DJY-V	Φ7.0×108
31474112	DJY-V	Φ7.0×112
31474118	DJY-V	Φ7.0×118
31474122	DJY-V	Φ7.0×122
31474128	DJY-V	Φ7.0×128
31474132	DJY-V	Φ7.0×132
31474138	DJY-V	Φ7.0×138
31474142	DJY-V	Φ7.0×142

## VariLoc Locking Compression Plate System

### Instruments

#### VariLoc 2.4/2.7mm Plate System Instruments Set













Code	Product Description	Qty.
295000	VariLoc 2.4/2.7mm Plate System	1
295070	VariLoc 2.4/2.7mm Plate System-empty	1
295050	VariLoc 2.4/2.7mm Screw Case	1
295130	Drill Guide 2.0	2
286130	Drill Bit, Φ 2.0mm	2
292110	Drill Bit, Φ 2.0mm	2
295140	Drill Guide 1.8	2
286230	Drill Bit, Φ 1.8mm	2
295110	Drill Bit, Φ 1.8mm	2
288150	Torque-limiting Screwdriver,T8	1
288160	Locking Screw Holding Sleeve	1
288170	Cortex Screw Holding Sleeve	1
286200	Depth Gauge,60mm	1
288130	Torx Screwdriver, with Quick Coupling,T8	1
286260	Drill Bit, Φ 2.7mm	2
286270	Drill Bit, Φ2.4mm	2
286240	Double Drill Guide 2.7/2.0	1
286250	Double Drill Guide 2.4/1.8	1
292140	Drill Guide,for 2.7 VA Screw	1
295112	Drill Guide,for 2.4 VA Screw	1
10735150	K-Wire, ø1.8x150mm	3
19472515	K-Wire with thread, ø1.8x150mm	3
288140	Screwdriver for Screw Removal, T8	1
01214	Bending Iron	2
01123	Reduction Forceps with Points	1
01124	Reduction Forceps with Points, toothed	1
01232	Periosteal Elevator, width 3mm	1
01215	Retractor, width 6mm	1
291290	T-handle with Quick Coupling	1



# VariLoc Locking Compression Plate System

## Instruments





### VariLoc 2.4/2.7mm Plate System Instruments

 <b>295050</b> VariLoc 2.4/2.7mm Screw Case	 <b>295130</b> Drill Guide 2.0	 <b>286130</b> Drill Bit, Φ 2.0mm
 <b>292110</b> Drill Bit, Φ 2.0mm	 <b>295140</b> Drill Guide 1.8	 <b>286230</b> Drill Bit, Φ 1.8mm
 <b>295110</b> Drill Bit, Φ 1.8mm	 <b>288150</b> Torque-limiting Screwdriver, T8	 <b>288160</b> Locking Screw Holding Sleeve
 <b>288170</b> Cortex Screw Holding Sleeve	 <b>286200</b> Depth Gauge, 60mm	 <b>288130</b> Torx Screwdriver, with Quick Coupling, T8

# VariLoc Locking Compression Plate System

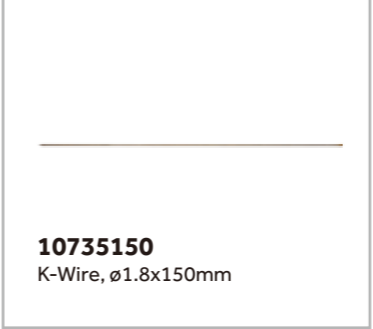
## Instruments

### VariLoc 2.4/2.7mm Plate System Instruments

 <b>286260</b> Drill Bit, Φ 2.7mm	 <b>286270</b> Drill Bit, Φ 2.4mm	 <b>286240</b> Double Drill Guide 2.7/2.0
 <b>286250</b> Double Drill Guide 2.4/1.8	 <b>292140</b> Drill Guide, for 2.7 VA Screw	 <b>295112</b> Drill Guide, for 2.4 VA Screw
 <b>10735150</b> K-Wire, ø1.8x150mm	 <b>19472515</b> K-Wire with thread, ø1.8x150mm	 <b>288140</b> Screwdriver for Screw Removal, T8
 <b>01214</b> Bending Iron	 <b>01123</b> Reduction Forceps with Points	 <b>01124</b> Reduction Forceps with Points, toothed



## VariLoc Locking Compression Plate System

### Instruments

#### VariLoc 2.4/2.7mm Plate System Instruments



## VariLoc Locking Compression Plate System

### Instruments

#### VariLoc 2.7/3.5mm Plate System Instruments Set

Code	Product Description	Qty.
292000	VariLoc 2.7/3.5mm Plate System	1
292010	VariLoc 2.7/3.5mm Plate System-empty	1
292050	VariLoc 2.7/3.5mm Screw Case	1
286130	Drill Bit, $\Phi$ 2.0mm	2
292110	Drill Bit, $\Phi$ 2.0mm	2
286260	Drill Bit, $\Phi$ 2.7mm	2
295130	Drill Sleeve for Drill Bit $\Phi$ 2.0mm	2
286240	Double Drill Guide 2.0/2.7	1
286280	Tap, $\phi$ 2.7mm	1
288150	Torque-limiting Screwdriver,T8	1
288130	Torx Screwdriver, with Quick Coupling, T8	1
288140	Screwdriver for Screw Removal, T8	1
288160	Locking Screw Holding Sleeve	1
288170	Cortex Screw Holding Sleeve	1
286200	Depth Gauge	1
292580	Drill Bit with Stop, $\Phi$ 2.7mm	2
292220	Drill Bit with Stop, $\Phi$ 2.7mm	2
292240	Drill Sleeve for Drill Bit $\Phi$ 2.7mm	3
010010	Drill Bit, $\Phi$ 2.5mm	1
292230	Drill Bit, $\Phi$ 2.5mm	1
010030	Drill Bit, $\Phi$ 3.5mm	1
201120	Double Drill Guide 2.5/3.5	1
020010	Tap, $\phi$ 3.5mm	1
292280	Torque-limiting Screwdriver, T15	1
292290	Torx Screwdriver, with Quick Coupling,T15	1
292300	Screwdriver for Screw Removal, T15	1
292310	Locking Screw Holding Sleeve, $\Phi$ 3.5mm	1
292320	Cortex Screw Holding Sleeve, $\Phi$ 3.5mm	1
020020	Tap, $\phi$ 4.0mm	1

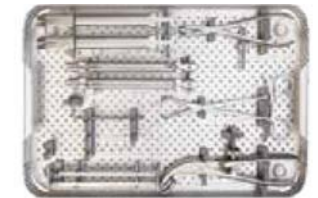

# VariLoc Locking Compression Plate System

## Instruments

### VariLoc 2.7/3.5mm Plate System Instruments Set

Code	Product Description	Qty.
292450	Hex Screwdriver	1
201200	Depth Gauge	1
10736220	K-Wire with thread, $\Phi$ 1.2mm	3
10703210	K-Wire, $\Phi$ 1.2mm	3
221180	Allen Key	1
291290	T-handle with Quick Coupling	1
201170	Bone Holding Forceps, self-centering	2
201180	Reduction Forceps, serrated jaws	1
201190	Reduction Forceps with Points	1
01214	Bending Iron, for 2.7mm LCP	2
201160	Bending Iron, for 3.5mm LCP	2
206270	Bending Iron, for Recon LCP	2
10702200	K-Wire, $\Phi$ 1.0mm	3
291200	K-Wire with thread, $\Phi$ 1.0mm	3
292360	Guide Sleeve for K-Wire, $\Phi$ 1.0mm	1
292370	Depth Gauge for K-Wire, $\Phi$ 1.0mm	1
292390	Drill Guide $\phi$ 3.5	2
292610	Cannulated Drill Bit, $\Phi$ 3.0/3.5mm	2
292680	Cannulated Drill Bit, $\Phi$ 3.0/3.5mm	2
292410	Cannulated Torx Screwdriver, with Quick Coupling, T15	1
292140	Drill Guide,for 2.7 VA Screw	1
292250	Drill Guide,for 3.5 VA Screw	1



### VariLoc 2.7/3.5mm Plate System Instruments



# VariLoc Locking Compression Plate System

## Instruments

### VariLoc 2.7/3.5mm Plate System Instruments

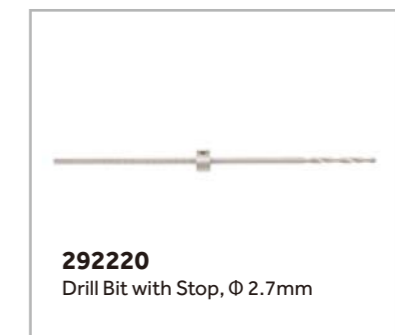
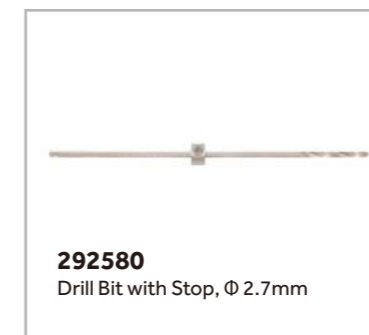

# VariLoc Locking Compression Plate System

## Instruments









### VariLoc 2.7/3.5mm Plate System Instruments

 <b>292240</b> Drill Sleeve for Drill Bit $\Phi$ 2.7mm	 <b>010010</b> Drill Bit, $\Phi$ 2.5mm	 <b>292230</b> Drill Bit, $\Phi$ 2.5mm
 <b>010030</b> Drill Bit, $\Phi$ 3.5mm	 <b>201120</b> Double Drill Guide 2.5/3.5	 <b>020010</b> Tap, $\phi$ 3.5mm
 <b>292280</b> Torque-limiting Screwdriver, T15	 <b>292290</b> Torx Screwdriver, with Quick Coupling, T15	 <b>292300</b> Screwdriver for Screw Removal, T15
 <b>292310</b> Locking Screw Holding Sleeve, $\Phi$ 3.5mm	 <b>292320</b> Cortex Screw Holding Sleeve, $\Phi$ 3.5mm	 <b>020020</b> Tap, $\phi$ 4.0mm

# VariLoc Locking Compression Plate System

## Instruments











### VariLoc 2.7/3.5mm Plate System Instruments

 <b>292450</b> Hex Screwdriver	 <b>201200</b> Depth Gauge	 <b>10736220</b> K-Wire with thread, $\Phi$ 1.2mm
 <b>10703210</b> K-Wire, $\Phi$ 1.2mm	 <b>221180</b> Allen Key	 <b>291290</b> T-handle with Quick Coupling
 <b>201170</b> Bone Holding Forceps, self-centering	 <b>201180</b> Reduction Forceps, serrated jaws	 <b>201190</b> Reduction Forceps with Points
 <b>01214</b> Bending Iron, for 2.7mm LCP	 <b>201160</b> Bending Iron, for 3.5mm LCP	 <b>206270</b> Bending Iron, for Recon LCP

# VariLoc Locking Compression Plate System

## Instruments

### VariLoc 2.7/3.5mm Plate System Instruments

 <p><b>291200</b> K-Wire with thread, <math>\Phi</math> 1.0mm</p>	 <p><b>292360</b> Guide Sleeve for K-Wire, <math>\Phi</math> 1.0mm</p>	 <p><b>292370</b> Depth Gauge for K-Wire, <math>\Phi</math> 1.0mm</p>
 <p><b>292390</b> Drill Guide <math>\phi</math>3.5</p>	 <p><b>292610</b> Cannulated Drill Bit, <math>\Phi</math>3.0/3.5mm</p>	 <p><b>292680</b> Cannulated Drill Bit, <math>\Phi</math>3.0/3.5mm</p>
 <p><b>292410</b> Cannulated Torx Screwdriver, with Quick Coupling, T15</p>	 <p><b>292140</b> Drill Guide, for 2.7 VA Screw</p>	 <p><b>292250</b> Drill Guide, for 3.5 VA Screw</p>
 <p><b>10702200</b> K-Wire, 1.0mm</p>		

# VariLoc Locking Compression Plate System

## Instruments

### VariLoc 5.0mm Plate System Instruments Set

Code	Product Description	Qty.
291000	VariLoc 5.0mm Plate System	
291010	VariLoc 5.0mm Plate System-empty	1
291050	VariLoc 5.0mm Screw Case	1
291290	T-handle with Quick Coupling	1
221180	Allen Key	1
010020	Drill Bit, $\Phi$ 3.2mm	1
291100	Drill Bit, $\Phi$ 3.2mm	1
010040	Drill Bit, $\Phi$ 4.5mm	1
020030	Tap, $\Phi$ 4.5mm	1
206120	Double Drill Guide 4.5/3.2	1
291600	Drill Bit with Stop, $\Phi$ 4.2mm	2
291130	Drill Bit with Stop, $\Phi$ 4.2mm	2
291140	Drill Guide 4.2	3
291150	Torque-limiting Screwdriver, T25	1
291160	Torx Screwdriver, with Quick Coupling, T25	1
291170	Screwdriver for Screw Removal, T25	1
291270	Locking Screw Holding Sleeve, $\Phi$ 5.0mm	1
291180	Cortex Screw Holding Sleeve, $\Phi$ 4.5mm	1
020040	Tap, $\Phi$ 6.5mm	1
206110	Double Drill Guide 6.5/3.2	1
291320	Hex Screwdriver	1
206170	Depth Gauge	1
10737230	K-Wire with thread, $\Phi$ 2.0mm	3
10705230	K-Wire, $\Phi$ 2.0mm	3
206290	Bone Holding Forceps, self-centering	2
206150	Reduction Forceps, serrated jaws, large	1
206160	Reduction Forceps with Points, large	1
206320	Bending Irons(left)	1
206340	Bending Irons(right)	1
291190	K-Wire with thread, $\Phi$ 1.6mm	3
19472425	K-Wire, $\Phi$ 1.6mm	3
291210	Guide Sleeve for K-Wire, $\Phi$ 1.6mm	1
291220	Depth Gauge for K-Wire, $\Phi$ 1.6mm	1
291240	Drill Guide 5.0	2
291250	Cannulated Tap, $\Phi$ 5.5mm	1
291620	Cannulated Torx Screwdriver, with Quick Coupling, T25	1
291630	Cannulated Drill Bit, $\Phi$ 4.5/5.0mm	2
291570	Cannulated Drill Bit, $\Phi$ 4.5/5.0mm	2
291720	Drill Guide, for 5.0 VA Screw	1

















# VariLoc Locking Compression Plate System

## Instruments













### VariLoc 5.0mm Plate System Instruments

 <b>291050</b> VariLoc 5.0mm Screw Case	 <b>291290</b> T-handle with Quick Coupling	 <b>221180</b> Allen Key
 <b>010020</b> Drill Bit, Ø 3.2mm	 <b>291100</b> Drill Bit, Ø 3.2mm	 <b>010040</b> Drill Bit, Ø 4.5mm
 <b>020030</b> Tap, Ø 4.5mm	 <b>206120</b> Double Drill Guide 4.5/3.2	 <b>291600</b> Drill Bit with Stop, Ø 4.2mm
 <b>291130</b> Drill Bit with Stop, Ø 4.2mm	 <b>291140</b> Drill Guide 4.2	 <b>291150</b> Torque-limiting Screwdriver, T25

# VariLoc Locking Compression Plate System

## Instruments

### VariLoc 5.0mm Plate System Instruments

 <b>291160</b> Torx Screwdriver, with Quick Coupling, T25	 <b>291170</b> Screwdriver for Screw Removal, T25	 <b>291270</b> Locking Screw Holding Sleeve, Ø 5.0mm
 <b>291180</b> Cortex Screw Holding Sleeve, Ø 4.5mm	 <b>020040</b> Tap, Ø 6.5mm	 <b>206110</b> Double Drill Guide 6.5/3.2
 <b>291320</b> Hex Screwdriver	 <b>206170</b> Depth Gauge	 <b>10737230</b> K-Wire with thread, Ø 2.0mm
 <b>10705230</b> K-Wire, Ø 2.0mm	 <b>206290</b> Bone Holding Forceps, self-centering	 <b>206150</b> Reduction Forceps, serrated jaws, large

## VariLoc Locking Compression Plate System

### Instruments

#### VariLoc 5.0mm Plate System Instruments

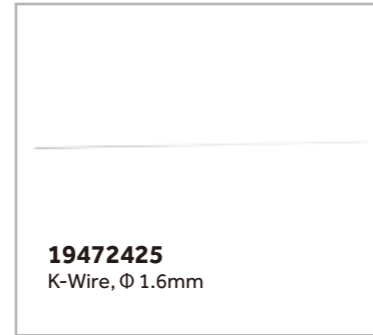
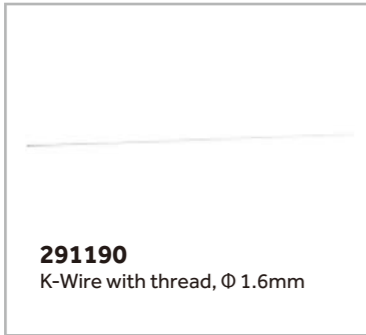

## VariLoc Locking Compression Plate System

### Instruments

#### VariLoc 5.0mm Plate System Instruments



# VariLoc Locking Compression Plate System

## Instruments

### VariLoc 5.0/7.0mm Proximal Femoral Plate System Instruments Set

Code	Product Description	Qty.
293000	VariLoc 5.0/7.0mm Proximal Femoral Plate System	1
293010	VariLoc 5.0/7.0mm Proximal Femoral Plate System-empty case	1
293050	5.0/7.0mm Screw Case	1
10737230	K-Wire with thread, $\Phi$ 2.0mm	3
10705230	K-Wire, $\Phi$ 2.0mm	3
291740	K-Wire, $\Phi$ 2.5mm	3
291750	K-Wire with thread, $\Phi$ 2.5mm	3
291410	Guide Sleeve for K-Wire, $\Phi$ 2.5mm	1
291400	Depth Gauge for K-Wire, $\Phi$ 2.5mm	1
291430	Drill Sleeve, $\Phi$ 6.5mm	3
291260	Cannulated Drill Bit, $\Phi$ 4.5/6.5mm	2
291440	Cannulated Drill Bit, $\Phi$ 4.5/6.5mm	2
291450	Cannulated Tap, $\Phi$ 7.0mm	1
291670	Drill Sleeve for Cannulated Drill Bit	2
291470	Torque-limiting Screwdriver, $\Phi$ 7.0mm	1
291480	Torx Screwdriver, $\Phi$ 7.0mm with Quick Coupling	1
291490	Screwdriver for Screw Removal	1
291500	Screw Holding Sleeve, $\Phi$ 7.0mm	1
291540	T-handle with Quick Coupling	1
291600	Drill Bit with Stop, $\Phi$ 4.2mm	2
291130	Drill Bit with Stop, $\Phi$ 4.2mm	2
291140	Drill Guide 4.2	2
291150	Torque-limiting Screwdriver, T25	1
291160	Torx Screwdriver, with Quick Coupling, T25	1
291170	Screwdriver for Screw Removal, T25	1
291270	Locking Screw Holding Sleeve, $\Phi$ 5.0mm	1
221180	Allen Key	1
291290	T-handle with Quick Coupling	1

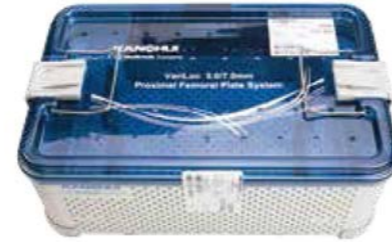

# VariLoc Locking Compression Plate System

## Instruments

### VariLoc 5.0/7.0mm Proximal Femoral Plate System Instruments



**293050**  
5.0/7.0mm Screw Case

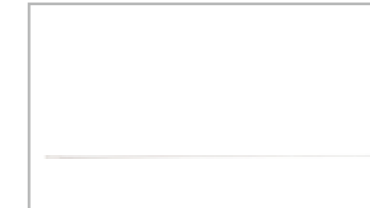

**10737230**  
K-Wire with thread,  $\Phi$  2.0mm

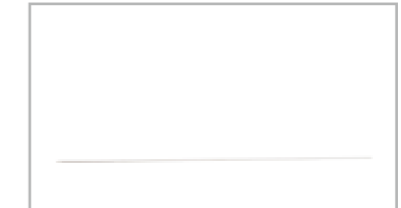

**10705230**  
K-Wire,  $\Phi$  2.0mm



**291740**  
K-Wire,  $\Phi$  2.5mm



**291750**  
K-Wire with thread,  $\Phi$  2.5mm



**291410**  
Guide Sleeve for K-Wire,  $\Phi$  2.5mm



**291400**  
Depth Gauge for K-Wire,  $\Phi$  2.5mm



**291430**  
Drill Sleeve,  $\Phi$  6.5mm



**291260**  
Cannulated Drill Bit,  $\Phi$  4.5/6.5mm



**291440**  
Cannulated Drill Bit,  $\Phi$  4.5/6.5mm



**291450**  
Cannulated Tap,  $\Phi$  7.0mm



**291670**  
Drill Sleeve for Cannulated Drill Bit

## VariLoc Locking Compression Plate System

### Instruments

#### VariLoc 5.0/7.0mm Proximal Femoral Plate System Instruments



## VariLoc Locking Compression Plate System

### Instruments

#### VariLoc 5.0/7.0mm Proximal Femoral Plate System Instruments



# VariLoc Locking Compression Plate System

## Instruments

### VariLoc Locking Compression Plates Removal Kit Instruments Set

Code	Product Description	Qty.
294000	VariLoc LCP Removal Kit	1
294010	VariLoc LCP Removal Kit-empty case	1
288120	Easyout for Screw ø2.7	1
292330	Easyout for Screw ø3.5	1
291360	Easyout for Screw ø5.0	1
291530	Easyout for Screw ø7.0	1
221190	Drill Bit for Screw Head Removal, ø2.5	1
226190	Drill Bit for Screw Head Removal, ø3.5	1
292670	Trephine, ø3.5	1
291350	Trephine, ø5.0	1
291290	T-handle with Quick Couping	1
288140	Screwdriver for Screw Removal, T8	1
292300	Screwdriver for Screw Removal, T15	1
291170	Screwdriver for Screw Removal, T25	1
291490	Screwdriver for Screw Removal, ø7.0	1
292450	Hex Screwdriver SW2.5	1
291320	Hex Screwdriver SW3.5	1

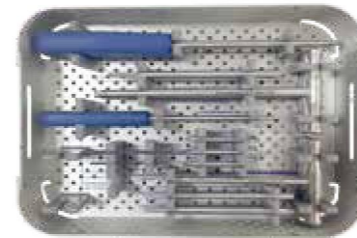
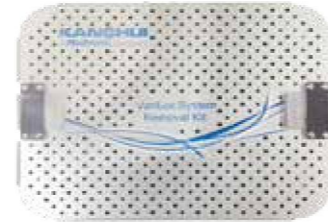

### VariLoc Locking Compression Plates Removal Kit Instruments



# VariLoc Locking Compression Plate System

## Instruments

### VariLoc Locking Compression Plates Removal Kit Instruments

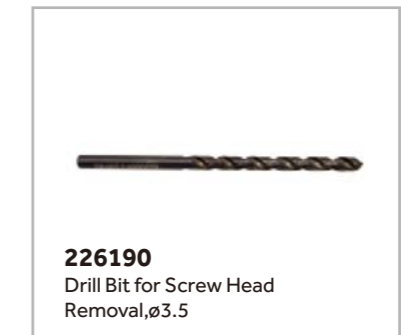
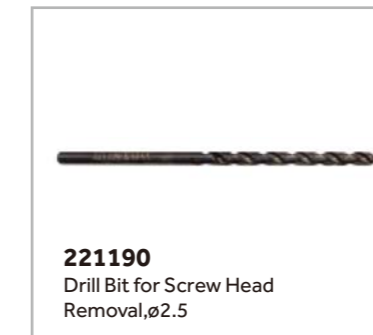



# VariLoc Locking Compression Plate System

## Instruments

### 295050 VariLoc 2.4/2.7mm Screw Case



Code	Description	Size	Qty.
34270010	Locking Screw, self-tapping	Φ2.4×10	12
34270012	Locking Screw, self-tapping	Φ2.4×12	12
34270014	Locking Screw, self-tapping	Φ2.4×14	12
34270016	Locking Screw, self-tapping	Φ2.4×16	12
34270018	Locking Screw, self-tapping	Φ2.4×18	12
34270020	Locking Screw, self-tapping	Φ2.4×20	12
34270022	Locking Screw, self-tapping	Φ2.4×22	12
34270024	Locking Screw, self-tapping	Φ2.4×24	12
34270026	Locking Screw, self-tapping	Φ2.4×26	12
34270028	Locking Screw, self-tapping	Φ2.4×28	12
34270030	Locking Screw, self-tapping	Φ2.4×30	12
30374010	Cortex Screw, fully threaded, self-tapping	Φ2.4×10	6
30374012	Cortex Screw, fully threaded, self-tapping	Φ2.4×12	6
30374014	Cortex Screw, fully threaded, self-tapping	Φ2.4×14	6
30374016	Cortex Screw, fully threaded, self-tapping	Φ2.4×16	6
30374018	Cortex Screw, fully threaded, self-tapping	Φ2.4×18	6
30374020	Cortex Screw, fully threaded, self-tapping	Φ2.4×20	6
30374022	Cortex Screw, fully threaded, self-tapping	Φ2.4×22	6
30374024	Cortex Screw, fully threaded, self-tapping	Φ2.4×24	6
30374026	Cortex Screw, fully threaded, self-tapping	Φ2.4×26	6
30374028	Cortex Screw, fully threaded, self-tapping	Φ2.4×28	6
30374030	Cortex Screw, fully threaded, self-tapping	Φ2.4×30	6
31480010	Variable Angle Locking Screws, self-tapping	Φ2.4×10	4
31480012	Variable Angle Locking Screws, self-tapping	Φ2.4×12	4
31480014	Variable Angle Locking Screws, self-tapping	Φ2.4×14	4
31480016	Variable Angle Locking Screws, self-tapping	Φ2.4×16	4
31480018	Variable Angle Locking Screws, self-tapping	Φ2.4×18	4
31480020	Variable Angle Locking Screws, self-tapping	Φ2.4×20	4
31480022	Variable Angle Locking Screws, self-tapping	Φ2.4×22	4
31480024	Variable Angle Locking Screws, self-tapping	Φ2.4×24	4
31480026	Variable Angle Locking Screws, self-tapping	Φ2.4×26	4
31480028	Variable Angle Locking Screws, self-tapping	Φ2.4×28	4
31480030	Variable Angle Locking Screws, self-tapping	Φ2.4×30	4
34253010	Locking Screw, self-tapping	Φ2.7×10	12
34253012	Locking Screw, self-tapping	Φ2.7×12	12
34253014	Locking Screw, self-tapping	Φ2.7×14	12
34253016	Locking Screw, self-tapping	Φ2.7×16	12
34253018	Locking Screw, self-tapping	Φ2.7×18	12
34253020	Locking Screw, self-tapping	Φ2.7×20	12
34253022	Locking Screw, self-tapping	Φ2.7×22	12
34253024	Locking Screw, self-tapping	Φ2.7×24	12

# VariLoc Locking Compression Plate System

## Instruments

### 295050 VariLoc 2.4/2.7mm Screw Case

Code	Description	Size	Qty.
34253026	LockingScrew, self-tapping	Φ2.7×26	12
34253028	LockingScrew, self-tapping	Φ2.7×28	12
34253030	LockingScrew, self-tapping	Φ2.7×30	12
34253032	LockingScrew, self-tapping	Φ2.7×32	12
34253034	LockingScrew, self-tapping	Φ2.7×34	12
34253036	LockingScrew, self-tapping	Φ2.7×36	12
34253038	LockingScrew, self-tapping	Φ2.7×38	12
34253040	LockingScrew, self-tapping	Φ2.7×40	12
30375010	CortexScrew, fully threaded, self-tapping	Φ2.7×10	6
30375012	CortexScrew, fully threaded, self-tapping	Φ2.7×12	6
30375014	CortexScrew, fully threaded, self-tapping	Φ2.7×14	6
30375016	CortexScrew, fully threaded, self-tapping	Φ2.7×16	6
30375018	CortexScrew, fully threaded, self-tapping	Φ2.7×18	6
30375020	CortexScrew, fully threaded, self-tapping	Φ2.7×20	6
30375022	CortexScrew, fully threaded, self-tapping	Φ2.7×22	6
30375024	CortexScrew, fully threaded, self-tapping	Φ2.7×24	6
30375026	CortexScrew, fully threaded, self-tapping	Φ2.7×26	6
30375028	CortexScrew, fully threaded, self-tapping	Φ2.7×28	6
30375030	CortexScrew, fully threaded, self-tapping	Φ2.7×30	6
30375032	CortexScrew, fully threaded, self-tapping	Φ2.7×32	6
30375034	CortexScrew, fully threaded, self-tapping	Φ2.7×34	6
30375036	CortexScrew, fully threaded, self-tapping	Φ2.7×36	6
30375038	CortexScrew, fully threaded, self-tapping	Φ2.7×38	6
30375040	CortexScrew, fully threaded, self-tapping	Φ2.7×40	6
31477110	VariableAngleLockingScrews, self-tapping	Φ2.7×10	4
31477112	VariableAngleLockingScrews, self-tapping	Φ2.7×12	4
31477114	VariableAngleLockingScrews, self-tapping	Φ2.7×14	4
31477116	VariableAngleLockingScrews, self-tapping	Φ2.7×16	4
31477118	VariableAngleLockingScrews, self-tapping	Φ2.7×18	4
31477120	VariableAngleLockingScrews, self-tapping	Φ2.7×20	4
31477122	VariableAngleLockingScrews, self-tapping	Φ2.7×22	4
31477124	VariableAngleLockingScrews, self-tapping	Φ2.7×24	4
31477126	VariableAngleLockingScrews, self-tapping	Φ2.7×26	4
31477128	VariableAngleLockingScrews, self-tapping	Φ2.7×28	4
31477130	VariableAngleLockingScrews, self-tapping	Φ2.7×30	4
31477132	VariableAngleLockingScrews, self-tapping	Φ2.7×32	4
31477134	VariableAngleLockingScrews, self-tapping	Φ2.7×34	4
31477136	VariableAngleLockingScrews, self-tapping	Φ2.7×36	4
31477138	VariableAngleLockingScrews, self-tapping	Φ2.7×38	4
31477140	VariableAngleLockingScrews, self-tapping	Φ2.7×40	4

## VariLoc Locking Compression Plate System

### Instruments

#### 292050 VariLoc 2.7/3.5mm Screw Case

Code	Description	Size	Qty.
34253010	Locking Screw, self-tapping	Φ2.7×10	6
34253012	Locking Screw, self-tapping	Φ2.7×12	6
34253014	Locking Screw, self-tapping	Φ2.7×14	6
34253016	Locking Screw, self-tapping	Φ2.7×16	6
34253018	Locking Screw, self-tapping	Φ2.7×18	6
34253020	Locking Screw, self-tapping	Φ2.7×20	6
34253022	Locking Screw, self-tapping	Φ2.7×22	6
34253024	Locking Screw, self-tapping	Φ2.7×24	6
34253026	Locking Screw, self-tapping	Φ2.7×26	6
34253028	Locking Screw, self-tapping	Φ2.7×28	6
34253030	Locking Screw, self-tapping	Φ2.7×30	6
34253032	Locking Screw, self-tapping	Φ2.7×32	6
34253034	Locking Screw, self-tapping	Φ2.7×34	6
34253036	Locking Screw, self-tapping	Φ2.7×36	6
34253038	Locking Screw, self-tapping	Φ2.7×38	6
34253040	Locking Screw, self-tapping	Φ2.7×40	6
30375010	Cortex Screw, fully threaded, self-tapping	Φ2.7×10	3
30375012	Cortex Screw, fully threaded, self-tapping	Φ2.7×12	3
30375014	Cortex Screw, fully threaded, self-tapping	Φ2.7×14	3
30375016	Cortex Screw, fully threaded, self-tapping	Φ2.7×16	3
30375018	Cortex Screw, fully threaded, self-tapping	Φ2.7×18	3
30375020	Cortex Screw, fully threaded, self-tapping	Φ2.7×20	3
30375022	Cortex Screw, fully threaded, self-tapping	Φ2.7×22	3
30375024	Cortex Screw, fully threaded, self-tapping	Φ2.7×24	3
30375026	Cortex Screw, fully threaded, self-tapping	Φ2.7×26	3
30375028	Cortex Screw, fully threaded, self-tapping	Φ2.7×28	3
30375030	Cortex Screw, fully threaded, self-tapping	Φ2.7×30	3
30375032	Cortex Screw, fully threaded, self-tapping	Φ2.7×32	3
30375034	Cortex Screw, fully threaded, self-tapping	Φ2.7×34	3
30375036	Cortex Screw, fully threaded, self-tapping	Φ2.7×36	3
30375038	Cortex Screw, fully threaded, self-tapping	Φ2.7×38	3
30375040	Cortex Screw, fully threaded, self-tapping	Φ2.7×40	3
34254010	Locking Screw, self-tapping	Φ3.5×10	6
34254012	Locking Screw, self-tapping	Φ3.5×12	6
34254014	Locking Screw, self-tapping	Φ3.5×14	6
34254016	Locking Screw, self-tapping	Φ3.5×16	6
34254018	Locking Screw, self-tapping	Φ3.5×18	6
34254020	Locking Screw, self-tapping	Φ3.5×20	6
34254022	Locking Screw, self-tapping	Φ3.5×22	6
34254024	Locking Screw, self-tapping	Φ3.5×24	6
34254026	Locking Screw, self-tapping	Φ3.5×26	6



## VariLoc Locking Compression Plate System

### Instruments

#### 292050 VariLoc 2.7/3.5mm Screw Case

Code	Description	Size	Qty.
34254028	LockingScrew, self-tapping	Φ3.5×28	6
34254030	LockingScrew, self-tapping	Φ3.5×30	6
34254032	LockingScrew, self-tapping	Φ3.5×32	6
34254034	LockingScrew, self-tapping	Φ3.5×34	6
34254036	LockingScrew, self-tapping	Φ3.5×36	6
34254038	LockingScrew, self-tapping	Φ3.5×38	6
34254040	LockingScrew, self-tapping	Φ3.5×40	6
34254045	LockingScrew, self-tapping	Φ3.5×45	6
34254050	LockingScrew, self-tapping	Φ3.5×50	6
34254055	LockingScrew, self-tapping	Φ3.5×55	6
34254060	LockingScrew, self-tapping	Φ3.5×60	6
34254065	LockingScrew, self-tapping	Φ3.5×65	6
34254070	LockingScrew, self-tapping	Φ3.5×70	6
30387010	CortexScrew, fully threaded, self-tapping	Φ3.5×10	3
30387012	CortexScrew, fully threaded, self-tapping	Φ3.5×12	3
30387014	CortexScrew, fully threaded, self-tapping	Φ3.5×14	3
30387016	CortexScrew, fully threaded, self-tapping	Φ3.5×16	3
30387018	CortexScrew, fully threaded, self-tapping	Φ3.5×18	3
30387020	CortexScrew, fully threaded, self-tapping	Φ3.5×20	3
30387022	CortexScrew, fully threaded, self-tapping	Φ3.5×22	3
30387024	CortexScrew, fully threaded, self-tapping	Φ3.5×24	3
30387026	CortexScrew, fully threaded, self-tapping	Φ3.5×26	3
30387028	CortexScrew, fully threaded, self-tapping	Φ3.5×28	3
30387030	CortexScrew, fully threaded, self-tapping	Φ3.5×30	3
30387032	CortexScrew, fully threaded, self-tapping	Φ3.5×32	3
30387034	CortexScrew, fully threaded, self-tapping	Φ3.5×34	3
30387036	CortexScrew, fully threaded, self-tapping	Φ3.5×36	3
30387038	CortexScrew, fully threaded, self-tapping	Φ3.5×38	3
30387040	CortexScrew, fully threaded, self-tapping	Φ3.5×40	3
30387045	CortexScrew, fully threaded, self-tapping	Φ3.5×45	3
30387050	CortexScrew, fully threaded, self-tapping	Φ3.5×50	3
30387055	CortexScrew, fully threaded, self-tapping	Φ3.5×55	3
30387060	CortexScrew, fully threaded, self-tapping	Φ3.5×60	3
30403110	CancellousScrews, fully threaded	4.0×10mm	2
30403112	CancellousScrews, fully threaded	4.0×12mm	2
30403114	CancellousScrews, fully threaded	4.0×14mm	2
30403116	CancellousScrews, fully threaded	4.0×16mm	2
30403118	CancellousScrews, fully threaded	4.0×18mm	2
30403120	CancellousScrews, fully threaded	4.0×20mm	2
30403122	CancellousScrews, fully threaded	4.0×22mm	2
30403124	CancellousScrews, fully threaded	4.0×24mm	2

## VariLoc Locking Compression Plate System

### Instruments

#### 292050 VariLoc 2.7/3.5mm Screw Case

Code	Description	Size	Qty.
30403126	Cancellous Screws, fully threaded	4.0×26mm	2
30403128	Cancellous Screws, fully threaded	4.0×28mm	2
30403130	Cancellous Screws, fully threaded	4.0×30mm	2
30403132	Cancellous Screws, fully threaded	4.0×32mm	2
30403134	Cancellous Screws, fully threaded	4.0×34mm	2
30403135	Cancellous Screws, fully threaded	4.0×36mm	2
30403136	Cancellous Screws, fully threaded	4.0×38mm	2
30403138	Cancellous Screws, fully threaded	4.0×40mm	2
30403140	Cancellous Screws, fully threaded	4.0×42mm	2
30403142	Cancellous Screws, fully threaded	4.0×44mm	2
30403144	Cancellous Screws, fully threaded	4.0×45mm	2
30403145	Cancellous Screws, fully threaded	4.0×46mm	2
30403146	Cancellous Screws, fully threaded	4.0×48mm	2
30403148	Cancellous Screws, fully threaded	4.0×50mm	2
30403150	Cancellous Screws, fully threaded	4.0×52mm	2
30403152	Cancellous Screws, fully threaded	4.0×55mm	2
30403155	Cancellous Screws, fully threaded	4.0×56mm	2
30403160	Cancellous Screws, fully threaded	4.0×60mm	2
30403165	Cancellous Screws, fully threaded	4.0×65mm	2
30403170	Cancellous Screws, fully threaded	4.0×70mm	2
30403210	Cancellous Screws, partially threaded	4.0×10mm	2
30403212	Cancellous Screws, partially threaded	4.0×12mm	2
30403214	Cancellous Screws, partially threaded	4.0×14mm	2
30403216	Cancellous Screws, partially threaded	4.0×16mm	2
30403218	Cancellous Screws, partially threaded	4.0×18mm	2
30403220	Cancellous Screws, partially threaded	4.0×20mm	2
30403222	Cancellous Screws, partially threaded	4.0×22mm	2
30403224	Cancellous Screws, partially threaded	4.0×24mm	2
30403226	Cancellous Screws, partially threaded	4.0×26mm	2
30403228	Cancellous Screws, partially threaded	4.0×28mm	2
30403230	Cancellous Screws, partially threaded	4.0×30mm	2
30403232	Cancellous Screws, partially threaded	4.0×32mm	2
30403234	Cancellous Screws, partially threaded	4.0×34mm	2
30403236	Cancellous Screws, partially threaded	4.0×36mm	2
30403238	Cancellous Screws, partially threaded	4.0×38mm	2
30403240	Cancellous Screws, partially threaded	4.0×40mm	2
30403242	Cancellous Screws, partially threaded	4.0×42mm	2
30403244	Cancellous Screws, partially threaded	4.0×44mm	2
30403246	Cancellous Screws, partially threaded	4.0×46mm	2
30403248	Cancellous Screws, partially threaded	4.0×48mm	2
30403250	Cancellous Screws, partially threaded	4.0×50mm	2

## VariLoc Locking Compression Plate System

### Instruments

#### 292050 VariLoc 2.7/3.5mm Screw Case

Code	Description	Size	Qty.
30403252	Cancellous Screws, partially threaded	4.0×52mm	2
30403254	Cancellous Screws, partially threaded	4.0×54mm	2
30403256	Cancellous Screws, partially threaded	4.0×56mm	2
30403260	Cancellous Screws, partially threaded	4.0×60mm	2
30403265	Cancellous Screws, partially threaded	4.0×65mm	2
30403270	Cancellous Screws, partially threaded	4.0×70mm	2
31477110	Variable Angle Locking Screws, self-tapping	Φ2.7×10	2
31477112	Variable Angle Locking Screws, self-tapping	Φ2.7×12	2
31477114	Variable Angle Locking Screws, self-tapping	Φ2.7×14	2
31477116	Variable Angle Locking Screws, self-tapping	Φ2.7×16	2
31477118	Variable Angle Locking Screws, self-tapping	Φ2.7×18	2
31477120	Variable Angle Locking Screws, self-tapping	Φ2.7×20	2
31477122	Variable Angle Locking Screws, self-tapping	Φ2.7×22	2
31477124	Variable Angle Locking Screws, self-tapping	Φ2.7×24	2
31477126	Variable Angle Locking Screws, self-tapping	Φ2.7×26	2
31477128	Variable Angle Locking Screws, self-tapping	Φ2.7×28	2
31477130	Variable Angle Locking Screws, self-tapping	Φ2.7×30	2
31477132	Variable Angle Locking Screws, self-tapping	Φ2.7×32	2
31477134	Variable Angle Locking Screws, self-tapping	Φ2.7×34	2
31477136	Variable Angle Locking Screws, self-tapping	Φ2.7×36	2
31477138	Variable Angle Locking Screws, self-tapping	Φ2.7×38	2
31477140	Variable Angle Locking Screws, self-tapping	Φ2.7×40	2
31478110	Variable Angle Locking Screws, self-tapping	Φ3.5×10	2
31478112	Variable Angle Locking Screws, self-tapping	Φ3.5×12	2
31478114	Variable Angle Locking Screws, self-tapping	Φ3.5×14	2
31478116	Variable Angle Locking Screws, self-tapping	Φ3.5×16	2
31478118	Variable Angle Locking Screws, self-tapping	Φ3.5×18	2
31478120	Variable Angle Locking Screws, self-tapping	Φ3.5×20	2
31478122	Variable Angle Locking Screws, self-tapping	Φ3.5×22	2
31478124	Variable Angle Locking Screws, self-tapping	Φ3.5×24	2
31478126	Variable Angle Locking Screws, self-tapping	Φ3.5×26	2
31478128	Variable Angle Locking Screws, self-tapping	Φ3.5×28	2
31478130	Variable Angle Locking Screws, self-tapping	Φ3.5×30	2
31478132	Variable Angle Locking Screws, self-tapping	Φ3.5×32	2
31478134	Variable Angle Locking Screws, self-tapping	Φ3.5×34	2
31478136	Variable Angle Locking Screws, self-tapping	Φ3.5×36	2
31478138	Variable Angle Locking Screws, self-tapping	Φ3.5×38	2
31478140	Variable Angle Locking Screws, self-tapping	Φ3.5×40	2
31478146	Variable Angle Locking Screws, self-tapping	Φ3.5×46	2
31478150	Variable Angle Locking Screws, self-tapping	Φ3.5×50	2
31478156	Variable Angle Locking Screws, self-tapping	Φ3.5×56	2

## VariLoc Locking Compression Plate System

### Instruments

#### 292050 VariLoc 2.7/3.5mm Screw Case

Code	Description	Size	Qty.
31478160	Variable Angle Locking Screws, self-tapping	Φ3.5×60	2
31478166	Variable Angle Locking Screws, self-tapping	Φ3.5×66	2
31478170	Variable Angle Locking Screws, self-tapping	Φ3.5×70	2
31478176	Variable Angle Locking Screws, self-tapping	Φ3.5×76	2
31478180	Variable Angle Locking Screws, self-tapping	Φ3.5×80	2
31475232	Cannulated Locking Screw, partial threaded	Φ4.0×32	2
31475240	Cannulated Locking Screw, partial threaded	Φ4.0×40	2
31475248	Cannulated Locking Screw, partial threaded	Φ4.0×48	2
31475255	Cannulated Locking Screw, partial threaded	Φ4.0×55	2
31475258	Cannulated Locking Screw, partial threaded	Φ4.0×58	2
31475262	Cannulated Locking Screw, partial threaded	Φ4.0×62	2
31475265	Cannulated Locking Screw, partial threaded	Φ4.0×65	2
31475270	Cannulated Locking Screw, partial threaded	Φ4.0×70	2
31475272	Cannulated Locking Screw, partial threaded	Φ4.0×72	2
31475278	Cannulated Locking Screw, partial threaded	Φ4.0×78	2
31475280	Cannulated Locking Screw, partial threaded	Φ4.0×80	2
31475285	Cannulated Locking Screw, partial threaded	Φ4.0×85	2
31475288	Cannulated Locking Screw, partial threaded	Φ4.0×88	2

## VariLoc Locking Compression Plate System

### Instruments

#### 291050 VariLoc 5.0mm Screw Case

Code	Description	Size	Qty.
30386012	Cortex Screw, fully threaded, self-tapping	Φ4.5×12	3
30386014	Cortex Screw, fully threaded, self-tapping	Φ4.5×14	3
30386016	Cortex Screw, fully threaded, self-tapping	Φ4.5×16	3
30386018	Cortex Screw, fully threaded, self-tapping	Φ4.5×18	3
30386020	Cortex Screw, fully threaded, self-tapping	Φ4.5×20	3
30386022	Cortex Screw, fully threaded, self-tapping	Φ4.5×22	3
30386024	Cortex Screw, fully threaded, self-tapping	Φ4.5×24	3
30386026	Cortex Screw, fully threaded, self-tapping	Φ4.5×26	3
30386028	Cortex Screw, fully threaded, self-tapping	Φ4.5×28	3
30386030	Cortex Screw, fully threaded, self-tapping	Φ4.5×30	3
30386032	Cortex Screw, fully threaded, self-tapping	Φ4.5×32	3
30386034	Cortex Screw, fully threaded, self-tapping	Φ4.5×34	3
30386036	Cortex Screw, fully threaded, self-tapping	Φ4.5×36	3
30386038	Cortex Screw, fully threaded, self-tapping	Φ4.5×38	3
30386040	Cortex Screw, fully threaded, self-tapping	Φ4.5×40	3
30386042	Cortex Screw, fully threaded, self-tapping	Φ4.5×42	3
30386044	Cortex Screw, fully threaded, self-tapping	Φ4.5×44	3
30386046	Cortex Screw, fully threaded, self-tapping	Φ4.5×46	3
30386048	Cortex Screw, fully threaded, self-tapping	Φ4.5×48	3
30386050	Cortex Screw, fully threaded, self-tapping	Φ4.5×50	3
30386052	Cortex Screw, fully threaded, self-tapping	Φ4.5×52	3
30386054	Cortex Screw, fully threaded, self-tapping	Φ4.5×54	3
30386056	Cortex Screw, fully threaded, self-tapping	Φ4.5×56	3
30386058	Cortex Screw, fully threaded, self-tapping	Φ4.5×58	3
30386060	Cortex Screw, fully threaded, self-tapping	Φ4.5×60	3
30386062	Cortex Screw, fully threaded, self-tapping	Φ4.5×62	3
30386065	Cortex Screw, fully threaded, self-tapping	Φ4.5×65	3
30386070	Cortex Screw, fully threaded, self-tapping	Φ4.5×70	3
30386075	Cortex Screw, fully threaded, self-tapping	Φ4.5×75	3
30386080	Cortex Screw, fully threaded, self-tapping	Φ4.5×80	3
34255014	Locking Screw, self-tapping	Φ5.0×14	6
34255016	Locking Screw, self-tapping	Φ5.0×16	6
34255018	Locking Screw, self-tapping	Φ5.0×18	6
34255020	Locking Screw, self-tapping	Φ5.0×20	6
34255022	Locking Screw, self-tapping	Φ5.0×22	6
34255024	Locking Screw, self-tapping	Φ5.0×24	6
34255026	Locking Screw, self-tapping	Φ5.0×26	6
34255028	Locking Screw, self-tapping	Φ5.0×28	6
34255030	Locking Screw, self-tapping	Φ5.0×30	6
34255032	Locking Screw, self-tapping	Φ5.0×32	6
34255034	Locking Screw, self-tapping	Φ5.0×34	6





## VariLoc Locking Compression Plate System

### Instruments

#### 291050 VariLoc 5.0mm Screw Case

Code	Description	Size	Qty.
34255036	Locking Screw, self-tapping	Φ5.0×36	6
34255038	Locking Screw, self-tapping	Φ5.0×38	6
34255040	Locking Screw, self-tapping	Φ5.0×40	6
34255042	Locking Screw, self-tapping	Φ5.0×42	6
34255044	Locking Screw, self-tapping	Φ5.0×44	6
34255046	Locking Screw, self-tapping	Φ5.0×46	6
34255048	Locking Screw, self-tapping	Φ5.0×48	6
34255050	Locking Screw, self-tapping	Φ5.0×50	6
34255055	Locking Screw, self-tapping	Φ5.0×55	6
34255060	Locking Screw, self-tapping	Φ5.0×60	6
34255065	Locking Screw, self-tapping	Φ5.0×65	6
34255070	Locking Screw, self-tapping	Φ5.0×70	6
34255075	Locking Screw, self-tapping	Φ5.0×75	6
34255080	Locking Screw, self-tapping	Φ5.0×80	6
34255085	Locking Screw, self-tapping	Φ5.0×85	6
34255090	Locking Screw, self-tapping	Φ5.0×90	6
30405120	Cancellous Screws, fully threaded	6.5×20mm	2
30405125	Cancellous Screws, fully threaded	6.5×25mm	2
30405130	Cancellous Screws, fully threaded	6.5×30mm	2
30405135	Cancellous Screws, fully threaded	6.5×35mm	2
30405140	Cancellous Screws, fully threaded	6.5×40mm	2
30405145	Cancellous Screws, fully threaded	6.5×45mm	2
30405150	Cancellous Screws, fully threaded	6.5×50mm	2
30405155	Cancellous Screws, fully threaded	6.5×55mm	2
30405160	Cancellous Screws, fully threaded	6.5×60mm	2
30405165	Cancellous Screws, fully threaded	6.5×65mm	2
30405170	Cancellous Screws, fully threaded	6.5×70mm	2
30405175	Cancellous Screws, fully threaded	6.5×75mm	2
30405180	Cancellous Screws, fully threaded	6.5×80mm	2
30405185	Cancellous Screws, fully threaded	6.5×85mm	2
30405190	Cancellous Screws, fully threaded	6.5×90mm	2
30405240	Cancellous Screws, partially threaded, 16mm Thread	6.5×40mm	2
30405245	Cancellous Screws, partially threaded, 16mm Thread	6.5×45mm	2
30405250	Cancellous Screws, partially threaded, 16mm Thread	6.5×50mm	2
30405255	Cancellous Screws, partially threaded, 16mm Thread	6.5×55mm	2
30405260	Cancellous Screws, partially threaded, 16mm Thread	6.5×60mm	2
30405265	Cancellous Screws, partially threaded, 16mm Thread	6.5×65mm	2
30405270	Cancellous Screws, partially threaded, 16mm Thread	6.5×70mm	2
30405275	Cancellous Screws, partially threaded, 16mm Thread	6.5×75mm	2
30405280	Cancellous Screws, partially threaded, 16mm Thread	6.5×80mm	2
30405285	Cancellous Screws, partially threaded, 16mm Thread	6.5×85mm	2

## VariLoc Locking Compression Plate System

### Instruments

#### 291050 VariLoc 5.0mm Screw Case

Code	Description	Size	Qty.
30405290	Cancellous Screws, partially threaded, 16mm Thread	6.5×90mm	2
31479112	Variable Angle Locking Screws, self-tapping	Φ5.0×12	2
31479115	Variable Angle Locking Screws, self-tapping	Φ5.0×15	2
31479118	Variable Angle Locking Screws, self-tapping	Φ5.0×18	2
31479120	Variable Angle Locking Screws, self-tapping	Φ5.0×20	2
31479122	Variable Angle Locking Screws, self-tapping	Φ5.0×22	2
31479125	Variable Angle Locking Screws, self-tapping	Φ5.0×25	2
31479128	Variable Angle Locking Screws, self-tapping	Φ5.0×28	2
31479130	Variable Angle Locking Screws, self-tapping	Φ5.0×30	2
31479132	Variable Angle Locking Screws, self-tapping	Φ5.0×32	2
31479135	Variable Angle Locking Screws, self-tapping	Φ5.0×35	2
31479138	Variable Angle Locking Screws, self-tapping	Φ5.0×38	2
31479140	Variable Angle Locking Screws, self-tapping	Φ5.0×40	2
31479142	Variable Angle Locking Screws, self-tapping	Φ5.0×42	2
31479145	Variable Angle Locking Screws, self-tapping	Φ5.0×45	2
31479148	Variable Angle Locking Screws, self-tapping	Φ5.0×48	2
31479150	Variable Angle Locking Screws, self-tapping	Φ5.0×50	2
31479155	Variable Angle Locking Screws, self-tapping	Φ5.0×55	2
31479160	Variable Angle Locking Screws, self-tapping	Φ5.0×60	2
31479165	Variable Angle Locking Screws, self-tapping	Φ5.0×65	2
31479170	Variable Angle Locking Screws, self-tapping	Φ5.0×70	2
31479175	Variable Angle Locking Screws, self-tapping	Φ5.0×75	2
31479180	Variable Angle Locking Screws, self-tapping	Φ5.0×80	2
31479185	Variable Angle Locking Screws, self-tapping	Φ5.0×85	2
31479190	Variable Angle Locking Screws, self-tapping	Φ5.0×90	2
31479195	Variable Angle Locking Screws, self-tapping	Φ5.0×95	2
31479196	Variable Angle Locking Screws, self-tapping	Φ5.0×100	2
31476250	Cannulated Locking Screw, partial threaded	Φ5.5×50	2
31476255	Cannulated Locking Screw, partial threaded	Φ5.5×55	2
31476262	Cannulated Locking Screw, partial threaded	Φ5.5×62	2
31476265	Cannulated Locking Screw, partial threaded	Φ5.5×65	2
31476270	Cannulated Locking Screw, partial threaded	Φ5.5×70	2
31476272	Cannulated Locking Screw, partial threaded	Φ5.5×72	2
31476278	Cannulated Locking Screw, partial threaded	Φ5.5×78	2
31476280	Cannulated Locking Screw, partial threaded	Φ5.5×80	2
31476285	Cannulated Locking Screw, partial threaded	Φ5.5×85	2
31476292	Cannulated Locking Screw, partial threaded	Φ5.5×92	2



## VariLoc Locking Compression Plate System

### Instruments

#### 293050 5.0/7.0mm Screw Case

Code	Description	Size	Qty.
34255030	Locking Screw, self-tapping	Φ5.0×30	2
34255032	Locking Screw, self-tapping	Φ5.0×32	2
34255034	Locking Screw, self-tapping	Φ5.0×34	2
34255035	Locking Screw, self-tapping	Φ5.0×35	2
34255036	Locking Screw, self-tapping	Φ5.0×36	2
34255038	Locking Screw, self-tapping	Φ5.0×38	2
34255040	Locking Screw, self-tapping	Φ5.0×40	2
34255042	Locking Screw, self-tapping	Φ5.0×42	2
34255044	Locking Screw, self-tapping	Φ5.0×44	2
34255045	Locking Screw, self-tapping	Φ5.0×45	2
34255046	Locking Screw, self-tapping	Φ5.0×46	2
34255048	Locking Screw, self-tapping	Φ5.0×48	2
34255050	Locking Screw, self-tapping	Φ5.0×50	2
31474070	Cannulated Locking Screw, partial threaded	Φ7.0×70	3
31474075	Cannulated Locking Screw, partial threaded	Φ7.0×75	3
31474078	Cannulated Locking Screw, partial threaded	Φ7.0×78	3
31474082	Cannulated Locking Screw, partial threaded	Φ7.0×82	3
31474085	Cannulated Locking Screw, partial threaded	Φ7.0×85	3
31474090	Cannulated Locking Screw, partial threaded	Φ7.0×90	3
31474095	Cannulated Locking Screw, partial threaded	Φ7.0×95	3
31474100	Cannulated Locking Screw, partial threaded	Φ7.0×100	3
31474105	Cannulated Locking Screw, partial threaded	Φ7.0×105	3
31474110	Cannulated Locking Screw, partial threaded	Φ7.0×110	3
31474115	Cannulated Locking Screw, partial threaded	Φ7.0×115	3
31474120	Cannulated Locking Screw, partial threaded	Φ7.0×120	3



# MonoLoc Locking Plates System

- Hand and Foot (1.5/2.0, 2.4/2.7 Systems)
- Limbs (2.7, 3.5, 5.0 Systems)
- Targeting Locking Plates System
- TopFix Osteotomy Plates System

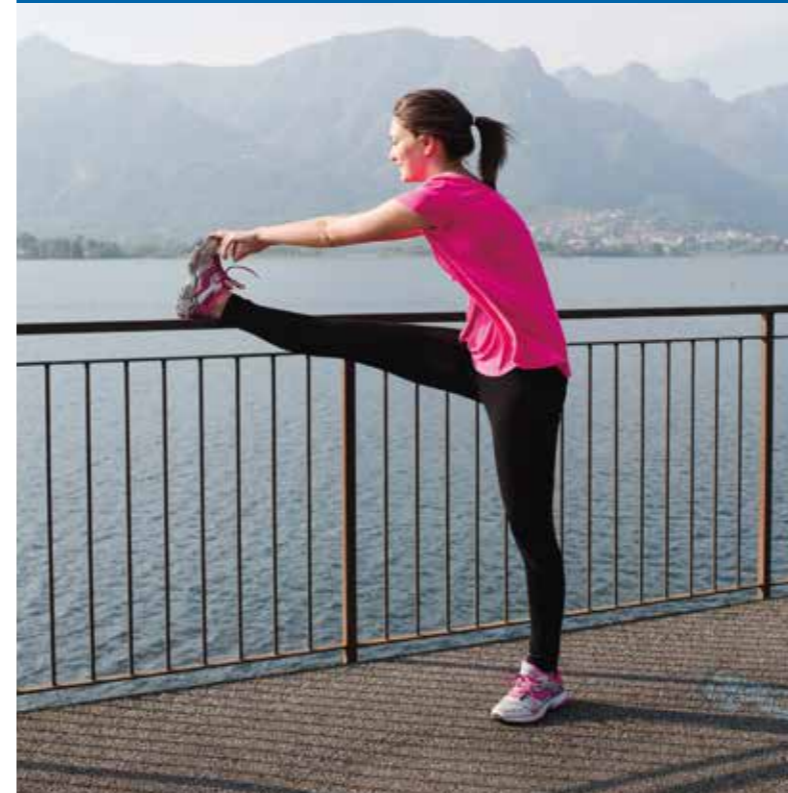

# MonoLoc Locking Plates System

## Hand and Foot

Locking Plate 1.5, straight



Thickness (mm)	1
Width (mm)	4.3
Material	PT

Code	Model No.	Size	Length (mm)
29476504	SDXZ40	4H	23
29476506	SDXZ40	6H	36

Locking Y-Plate 1.5



Thickness (mm)	1
Width (mm)	4.3
Material	PT

Code	Model No.	Size	Length (mm)
29478308	SDXZ06	3+8H	46.35

Locking Reconstruction Plate 1.5



Thickness (mm)	1
Width (mm)	4.3
Material	PT

Code	Model No.	Size	Length (mm)
29476006	SDXZ75	6H	29.3
29476012	SDXZ75	12H	59.3

Locking Condylar Plate 1.5



Thickness (mm)	1
Width (mm)	4.3
Material	PT

Code	Model No.	Size	Length (mm)
29475906	SDXZ45	2+6H	36.3

Locking T-Plate 1.5



Thickness (mm)	1
Width (mm)	4.3
Material	PT

Code	Model No.	Size	Length (mm)
29476608	SDXZ73	3+8H	44.65
29476408	SDXZ74	4+8H	44.65

Locking Strut Plate 1.5



Thickness (mm)	1
Width (mm)	12
Material	PT

Code	Model No.	Length (mm)
24241000	SDXZ68	23

## MonoLoc Locking Plates System

### Hand and Foot

Locking Plate 2.0, straight



Thickness (mm)	1.3
Width (mm)	5
Material	PT

Code	Model No.	Size	Length (mm)
29475404	SDXZ40	4H	31
29475405	SDXZ40	5H	38
29475406	SDXZ40	6H	45
29475407	SDXZ40	7H	52
29475408	SDXZ40	8H	59

Locking T-Plate 2.0



Thickness (mm)	1.3
Width (mm)	5
Material	PT

Code	Model No.	Size	Length (mm)
29476107	SDXZ73	3+7H	52.5

Locking condylar Plate 2.0



Thickness (mm)	1.5
Width (mm)	5
Material	PT

Code	Model No.	Size	Length (mm)
29475307	SDXZ45	2+7H	54

Locking Y-adaption Plate 2.0



Thickness (mm)	1.3
Width (mm)	5
Material	PT

Code	Model No.	Size	Length (mm)
29476307	SDXZ06	3+7H	54.7

Locking T-adaption Plate 2.0



Thickness (mm)	1.3
Width (mm)	5
Material	PT

Code	Model No.	Size	Length (mm)
29476207	SDXZ72	2+7H	52.5

Rotation Correction Locking Plate 2.0



Thickness (mm)	1.3
Material	PT

Code	Model No.	Length (mm)
24242000	SDXG78	40

## MonoLoc Locking Plates System

### Hand and Foot

Mini Condylar Locking Plate 2.0



Thickness (mm)	1.5
Width (mm)	5
Material	PT

Code	Model No.	Direction	Length (mm)
24243200	SDXG46	Left	41
24243100	SDXG47	Right	41

Mini H Locking Plate 2.0



Thickness (mm)	1.3
Width (mm)	10
Material	PT

Code	Model No.	Length (mm)
24244000	SDXZ70	13

# MonoLoc Locking Plates System

## Hand and Foot

### 1.5mm Locking Screw Stardrive, self-tapping



Core (mm)	1.1
Material	TA

Code	Model No.	Size
39475806	SDLD01	6mm
39475807	SDLD01	7mm
39475808	SDLD01	8mm
39475809	SDLD01	9mm
39475810	SDLD01	10mm
39475811	SDLD01	11mm
39475812	SDLD01	12mm
39475813	SDLD01	13mm
39475814	SDLD01	14mm
39475816	SDLD01	16mm
39475818	SDLD01	18mm
39475820	SDLD01	20mm
39475822	SDLD01	22mm
39475824	SDLD01	24mm

### 1.5mm Cortex Screw Stardrive, self-tapping



Core (mm)	1.1
Material	TA

Code	Model No.	Size
39475706	SSQ01	6mm
39475707	SSQ01	7mm
39475708	SSQ01	8mm
39475709	SSQ01	9mm
39475710	SSQ01	10mm
39475711	SSQ01	11mm
39475712	SSQ01	12mm
39475713	SSQ01	13mm
39475714	SSQ01	14mm
39475716	SSQ01	16mm
39475718	SSQ01	18mm
39475720	SSQ01	20mm
39475722	SSQ01	22mm
39475724	SSQ01	24mm

### 2.0mm Locking Screw Stardrive, self-tapping



Core (mm)	1.4
Material	TA

Code	Model No.	Size
39475606	SDLD01	6mm
39475607	SDLD01	7mm
39475608	SDLD01	8mm
39475609	SDLD01	9mm
39475610	SDLD01	10mm
39475611	SDLD01	11mm
39475612	SDLD01	12mm
39475613	SDLD01	13mm
39475614	SDLD01	14mm
39475616	SDLD01	16mm
39475618	SDLD01	18mm
39475620	SDLD01	20mm
39475622	SDLD01	22mm
39475624	SDLD01	24mm
39475626	SDLD01	26mm
39475628	SDLD01	28mm
39475630	SDLD01	30mm

### 2.0mm Cortex Screw Stardrive, self-tapping



Core (mm)	1.4
Material	TA

Code	Model No.	Size
39475506	SSQ01	6mm
39475507	SSQ01	7mm
39475508	SSQ01	8mm
39475509	SSQ01	9mm
39475510	SSQ01	10mm
39475511	SSQ01	11mm
39475512	SSQ01	12mm
39475513	SSQ01	13mm
39475514	SSQ01	14mm
39475516	SSQ01	16mm
39475518	SSQ01	18mm
39475520	SSQ01	20mm
39475522	SSQ01	22mm
39475524	SSQ01	24mm
39475526	SSQ01	26mm
39475528	SSQ01	28mm
39475530	SSQ01	30mm
39475532	SSQ01	32mm
39475534	SSQ01	34mm
39475538	SSQ01	38mm

# MonoLoc Locking Plates System

## Hand and Foot

### MonoLoc 1.5/2.0mm Locking Plate System Instrument Set

Code	Product Description	Qty.
98370	Monoloc 1.5/2.0mm Locking Plate Instrument Set	
898345	Monoloc 1.5/2.0mm Locking Plate Instruments Set (empty)-PPSU	1
216100	Handle, with Mini Quick Coupling	2
217490	Bending-Cutting Pliers	1
217500	Universal Pliers, pointed, for Plates 1.0 to 2.0 (left)	1
217510	Universal Pliers, pointed, for Plates 1.0 to 2.0 (right)	1
01123	Reduction Forceps with Points	1
01215	Retractor, width 6mm	1
01216	Retractor, width 8mm	1
01217	Retractor, width 15mm	1
01218	Sharp Hook	1
01219	Periosteal Elevator, width 5mm	1
01232	Periosteal Elevator, width 3mm	1
217530	Holding Forceps for Cortex Screws 1.0 to 2.0mm	1
216180	Plate Holding Instruments, for Plates 1.5	1
216190	Plate Holding Instruments, for Plates 2.0	1
98567	Holding Forceps for Finger plates, ratchet lock	1
98086	Depth Gauge for Screws 1.5 mm, measuring range up to 24mm	1
98087	Depth Gauge for Screw 2.0mm, measuring range up to 40mm	1
161210	Cutter	1

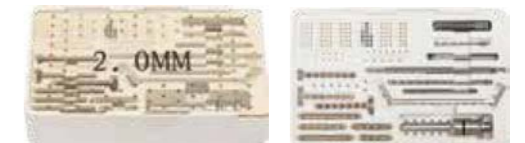
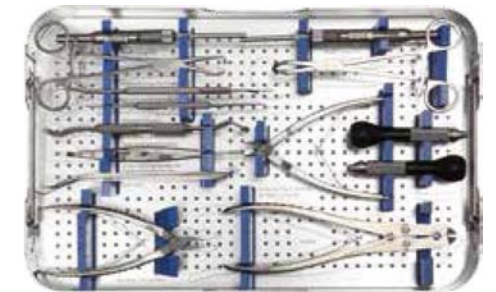
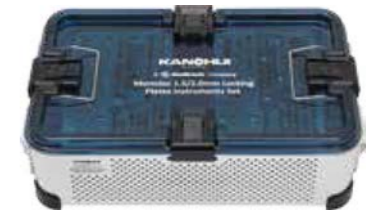

### 1.5mm implants tray (with instruments only)

Code	Product Description	Qty.
98372	1.5mm implants tray	1
98091	Drill Bit 1.1mm, with Quick Coupling	2
98085	Drill Bit 1.5mm, with Quick Coupling	2
98080	Countersink for Screws 1.3 and 1.5 mm	1
98083	Double Drill Guide 1.5/1.1	1
98094	Drill Sleeve 1.5, for Drill Bits 1.1 mm	2
98100	Screwdriver Shaft Stardrive 1.5, T4, self-holding, with Quick Coupling	2
98098	Holding Sleeve 1.5	1
98092	Bending Pin for 1.5 Plate, with thread	2



## MonoLoc Locking Plates System

### Hand and Foot

#### 2.0mm implants tray (with instruments only)

Code	Product Description	Qty.
98373	2.0mm implants tray	1
98085	Drill Bit 1.5mm, with Quick Coupling	2
98082	Drill Bit 2.0 mm, with Quick Coupling	2
98093	Countersink 1.5 to 2.4, with Quick Coupling	1
98095	Double Drill Guide 2.0/1.5 for Drill Bits 2.0 and 1.5 mm	1
98096	Drill Sleeve 2.0, with Scale, for Drill Bits 1.5 mm	2
98099	Screwdriver Shaft Stardrive 2.0, with Quick Coupling	2
98097	Holding Sleeve 2.0	1
98081	Bending Pin for LCP Plates 2.0	2

#### MonoLoc 1.5/2.0mm Locking Plate System Instrument



## MonoLoc Locking Plates System

### Hand and Foot

#### MonoLoc 1.5/2.0mm Locking Plate System Instrument Set

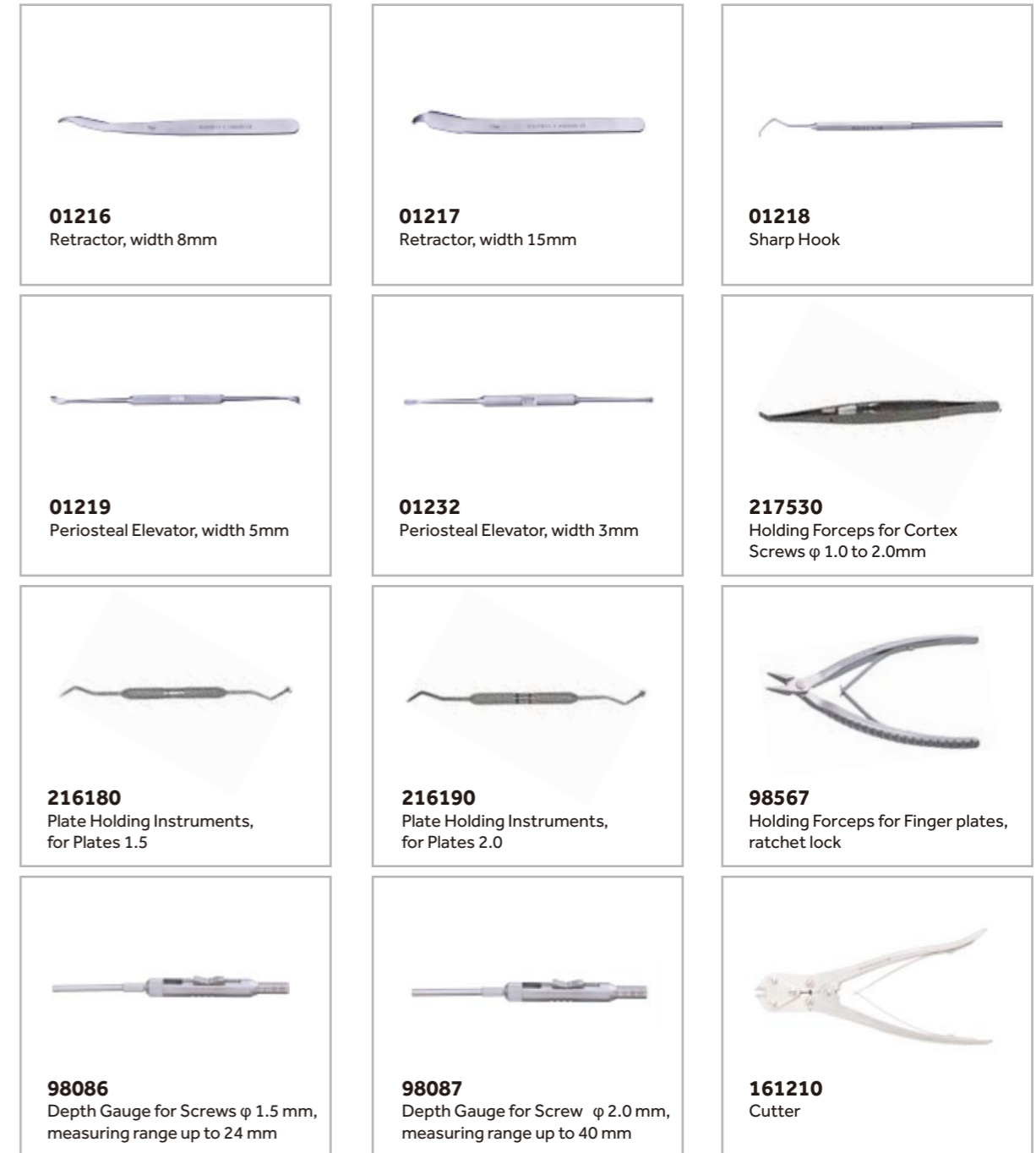







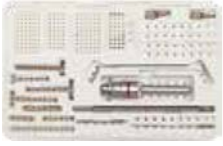

## MonoLoc Locking Plates System

### Hand and Foot

#### 1.5mm implants tray (with instruments only)

 <p><b>98372</b> 1.5mm implants tray</p>	 <p><b>98091</b> Drill Bit φ 1.1mm, with Quick Coupling</p>	 <p><b>98085</b> Drill Bit φ 1.5mm, with Quick Coupling</p>
 <p><b>98080</b> Countersink for Screws φ 1.3 and 1.5 mm</p>	 <p><b>98083</b> Double Drill Guide 1.5/1.1</p>	 <p><b>98094</b> Drill Sleeve 1.5, for Drill Bits φ 1.1 mm</p>
 <p><b>98100</b> Screwdriver Shaft Stardrive 1.5, T4, self-holding, with Quick Coupling</p>	 <p><b>98098</b> Holding Sleeve 1.5</p>	 <p><b>98092</b> Bending Pin for 1.5 Plate, with thread</p>

## MonoLoc Locking Plates System

### Hand and Foot

#### 2.0mm implants tray (with instruments only)

 <p><b>98373</b> 2.0mm implants tray</p>	 <p><b>98085</b> Drill Bit φ 1.5mm, with Quick Coupling</p>	 <p><b>98082</b> Drill Bit φ 2.0 mm, with Quick Coupling</p>
 <p><b>98093</b> Countersink 1.5 to 2.4, with Quick Coupling</p>	 <p><b>98095</b> Double Drill Guide 2.0/1.5 for Drill Bits 2.0 and 1.5 mm</p>	 <p><b>98096</b> Drill Sleeve 2.0, with Scale, for Drill Bits φ 1.5 mm</p>
 <p><b>98099</b> Screwdriver Shaft Stardrive 2.0, with Quick Coupling</p>	 <p><b>98097</b> Holding Sleeve 2.0</p>	 <p><b>98081</b> Bending Pin for LCP Plates 2.0</p>

# MonoLoc Locking Plates System

## Hand and Foot

### Locking Plate 2.4, Straight



Thickness (mm)	1.8
Width (mm)	6.5
Material	PT

Code	Model No.	Size	Length (mm)
24201004	SDXZ40	4H	35
24201005	SDXZ40	5H	43
24201006	SDXZ40	6H	51
24201007	SDXZ40	7H	59
24201008	SDXZ40	8H	67
24201010	SDXZ40	10H	83

### Locking Condylar Plate 2.4



Thickness (mm)	1.6
Width (mm)	6.5
Material	PT

Code	Model No.	Size	Length (mm)
24202000	SDXZ45	2+7H	59

### Locking Y-Plate 2.4



Thickness (mm)	1.6
Width (mm)	6.5
Material	PT

Code	Model No.	Size	Length (mm)
24203000	SDXZ06	3+7H	61

### Locking Plate 2.7, Straight



Thickness (mm)	2
Width (mm)	7
Material	PT

Code	Model No.	Size	Length (mm)
24206004	SDXZ40	4H	41
24206005	SDXZ40	5H	50
24206006	SDXZ40	6H	60
24206007	SDXZ40	7H	69
24206008	SDXZ40	8H	79
24206009	SDXZ40	9H	88
24206010	SDXZ40	10H	98

### Locking Condylar Plate 2.7



Thickness (mm)	1.8
Width (mm)	7
Material	PT

Code	Model No.	Size	Length (mm)
24207000	SDXZ45	2+7H	68

### Locking T-Plate 2.4



Thickness (mm)	1.6
Width (mm)	6.5
Material	PT

Code	Model No.	Size	Length (mm)
24204000	SDXZ72	2+7H	59
24205000	SDXZ73	3+7H	58

# MonoLoc Locking Plates System

## Hand and Foot

### Locking L-Plate 2.7



Thickness (mm)	1.8
Width (mm)	7
Material	PT

Code	Model No.	Size	Direction	Length (mm)
24209200	SDXZ76	2+3H	Left	33.5
24209100	SDXZ77	2+3H	Right	33.5

### Locking L-Plate 2.7, Oblique



Thickness (mm)	1.8
Width (mm)	7
Material	PT

Code	Model No.	Size	Direction	Length (mm)
24210200	SDXZ57	2+3H	Left	35.7
24210100	SDXZ58	2+3H	Right	35.7

### Locking T-Plate 2.7



Thickness (mm)	1.8
Width (mm)	7
Material	PT

Code	Model No.	Size	Length (mm)
24208000	SDXZ72	2+3H	33.5

### 2-Hole Locking Plate



Thickness (mm)	1.6
Width (mm)	6.5
Material	PT

Code	Model No.	Size	Length (mm)
24235000	SDXZ75	2H	18

### X Locking Plate



Thickness (mm)	1.8
Width (mm)	20
Material	PT

Code	Model No.	Size	Length (mm)
24211001	SDXZ70	Large	36
24211002	SDXZ70	Medium	30
24211003	SDXZ70	Small	24

# MonoLoc Locking Plates System

## Hand and Foot

### 2.7mm Locking Screw, Self tapping



Core (mm)	2.1
Material	TA

Code	Model No.	Size
32580006	SDLD01	6mm
32580008	SDLD01	8mm
32580010	SDLD01	10mm
32580012	SDLD01	12mm
32580014	SDLD01	14mm
32580016	SDLD01	16mm
32580018	SDLD01	18mm
32580020	SDLD01	20mm
32580022	SDLD01	22mm
32580024	SDLD01	24mm
32580026	SDLD01	26mm
32580028	SDLD01	28mm
32580030	SDLD01	30mm
32580032	SDLD01	32mm
32580034	SDLD01	34mm
32580036	SDLD01	36mm
32580038	SDLD01	38mm
32580040	SDLD01	40mm
32580042	SDLD01	42mm
32580044	SDLD01	44mm
32580046	SDLD01	46mm
32580048	SDLD01	48mm
32580050	SDLD01	50mm
32580052	SDLD01	52mm
32580054	SDLD01	54mm
32580056	SDLD01	56mm
32580058	SDLD01	58mm
32580060	SDLD01	60mm

### 2.7mm Cortex Screw, Self tapping



Core (mm)	1.9
Material	TA

Code	Model No.	Size
30375006	HAQ06	6mm
30375008	HAQ06	8mm
30375010	HAQ06	10mm
30375012	HAQ06	12mm
30375014	HAQ06	14mm
30375016	HAQ06	16mm
30375018	HAQ06	18mm
30375020	HAQ06	20mm
30375022	HAQ06	22mm
30375024	HAQ06	24mm
30375026	HAQ06	26mm
30375028	HAQ06	28mm
30375030	HAQ06	30mm
30375032	HAQ06	32mm
30375034	HAQ06	34mm
30375036	HAQ06	36mm
30375038	HAQ06	38mm
30375040	HAQ06	40mm
30375042	HAQ06	42mm
30375044	HAQ06	44mm
30375046	HAQ06	46mm
30375048	HAQ06	48mm
30375050	HAQ06	50mm
30375052	HAQ06	52mm
30375054	HAQ06	54mm
30375056	HAQ06	56mm
30375058	HAQ06	58mm
30375060	HAQ06	60mm

# MonoLoc Locking Plates System

## Hand and Foot

### 2.4mm Locking Screw, Self tapping



Core (mm)	1.9
Material	TA

Code	Model No.	Size
34217006	SDLD01	6mm
34217008	SDLD01	8mm
34217010	SDLD01	10mm
34217012	SDLD01	12mm
34217014	SDLD01	14mm
34217016	SDLD01	16mm
34217018	SDLD01	18mm
34217020	SDLD01	20mm
34217022	SDLD01	22mm
34217024	SDLD01	24mm
34217026	SDLD01	26mm
34217028	SDLD01	28mm
34217030	SDLD01	30mm

### 2.4mm Cortex Screw, Self tapping



Core (mm)	1.9
Material	TA

Code	Model No.	Size
30374006	HAQ06	6mm
30374008	HAQ06	8mm
30374010	HAQ06	10mm
30374012	HAQ06	12mm
30374014	HAQ06	14mm
30374016	HAQ06	16mm
30374018	HAQ06	18mm
30374020	HAQ06	20mm
30374022	HAQ06	22mm
30374024	HAQ06	24mm
30374026	HAQ06	26mm
30374028	HAQ06	28mm
30374030	HAQ06	30mm
30374032	HAQ06	32mm
30374034	HAQ06	34mm
30374036	HAQ06	36mm
30374038	HAQ06	38mm
30374040	HAQ06	40mm

### 1.8mm Buttress Pin



Shaft (mm)	1.8
Material	TA

Code	Model No.	Size
32581010	SDLD04	10mm
32581012	SDLD04	12mm
32581014	SDLD04	14mm
32581016	SDLD04	16mm
32581018	SDLD04	18mm
32581020	SDLD04	20mm
32581022	SDLD04	22mm
32581024	SDLD04	24mm
32581026	SDLD04	26mm
32581028	SDLD04	28mm
32581030	SDLD04	30mm

# MonoLoc Locking Plates System

## Hand and Foot

### MonoLoc Locking Plates 2.4/2.7mm System Instruments Set

Code	Product Description	Qty.
288000	MonoLoc 2.4/2.7mm Locking Plates System Instruments Set	1
288010	MonoLoc 2.4/2.7mm Locking Plates System Instruments Set (empty)	1
030100	T-Handle with Quick Coupling	2
288100	Bending-Cutting Pliers	2
01123	Reduction Forceps with Points	1
01124	Reduction Forceps with Points, toothed	1
01215	Retractor, width 6mm	1
01216	Retractor, width 8mm	1
01217	Retractor, width 15mm	1
01218	Sharp Hook	1
01219	Periosteal Elevator, width 5mm	1
01232	Periosteal Elevator, width 3mm	1
216160	Plate Holder	1
288110	Bending Pin 2.4/2.7	4
286200	Depth Gauge, 60mm	1
288120	Easyout	1
288160	Locking Screw Holding Sleeve	1
288170	Cortex Screw Holding Sleeve	1
288130	Torx Screwdriver, with Quick Coupling, T8	2
286300	Countersink	1
288140	Screwdriver for Screw Removal, T8	1
288150	Torque-limiting Screwdriver, T8	1
10735150	K-wire, 1.8x150mm	3
288020	2.4 mm Implants Tray (with Special Instruments)	1
288070	2.4 mm Implants Tray (Empty)	1
286220	Drill Guide 1.8	2
286230	Drill Bit, 1.8mm	2
286270	Drill Bit, 2.4mm	2
286250	Double Drill Guide, 2.4/1.8	1
286290	Tap, 2.4mm	2
288030	2.7 mm Implants Tray (with Special Instruments)	1
288080	2.7 mm Implants Tray (Empty)	1
286120	Drill Guide 2.0	2
286130	Drill Bit, 2.0mm	2
286260	Drill Bit, 2.7mm	2
286240	Double Drill Guide, 2.7/2.0	1
286280	Tap, 2.7mm	2



# MonoLoc Locking Plates System

## Hand and Foot

### MonoLoc Locking Plates 2.4/2.7mm System Instrument



## MonoLoc Locking Plates System

### Hand and Foot

#### MonoLoc Locking Plates 2.4/2.7mm System Instrument

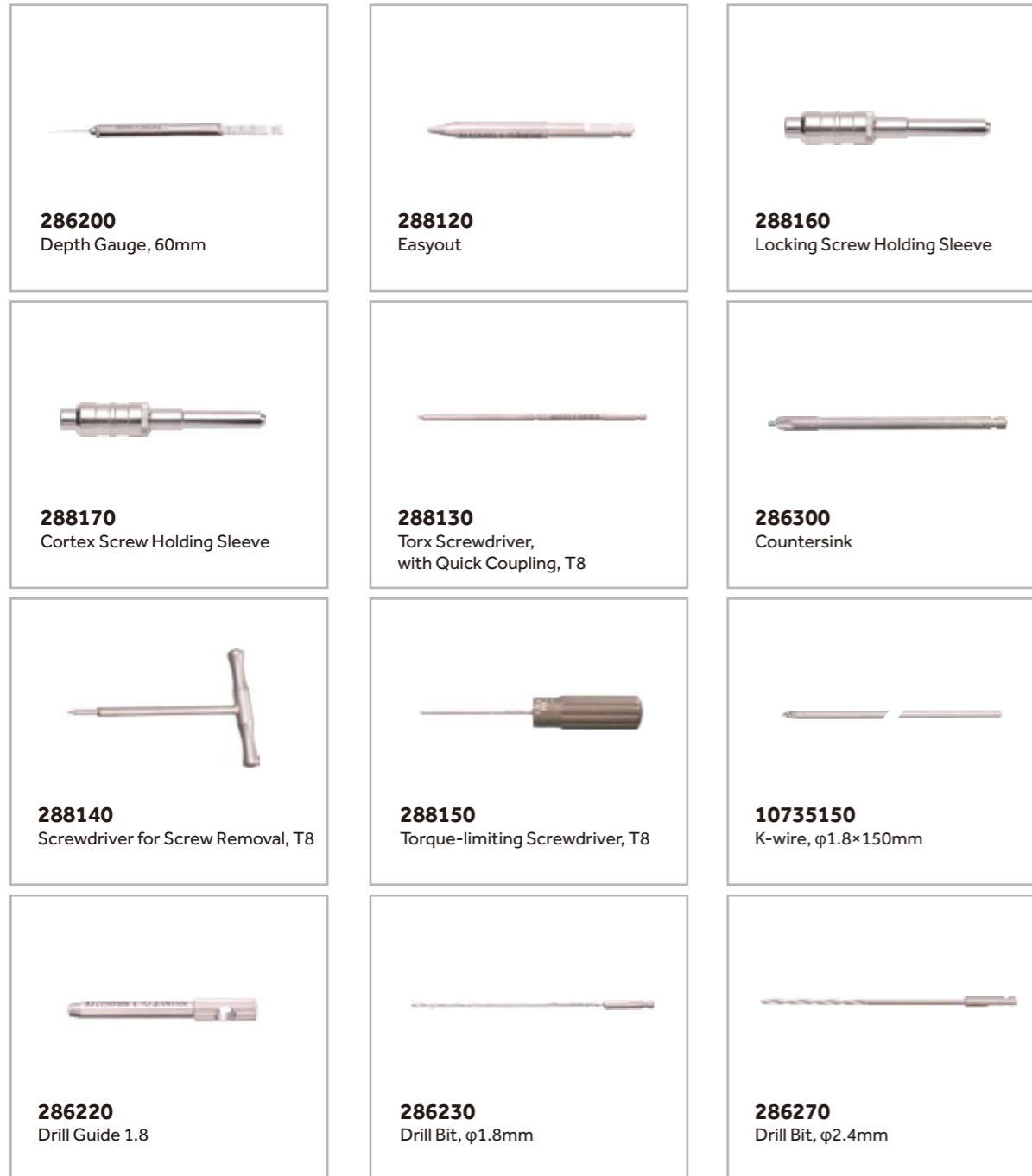

## MonoLoc Locking Plates System

### Hand and Foot

#### MonoLoc Locking Plates 2.4/2.7mm System Instrument

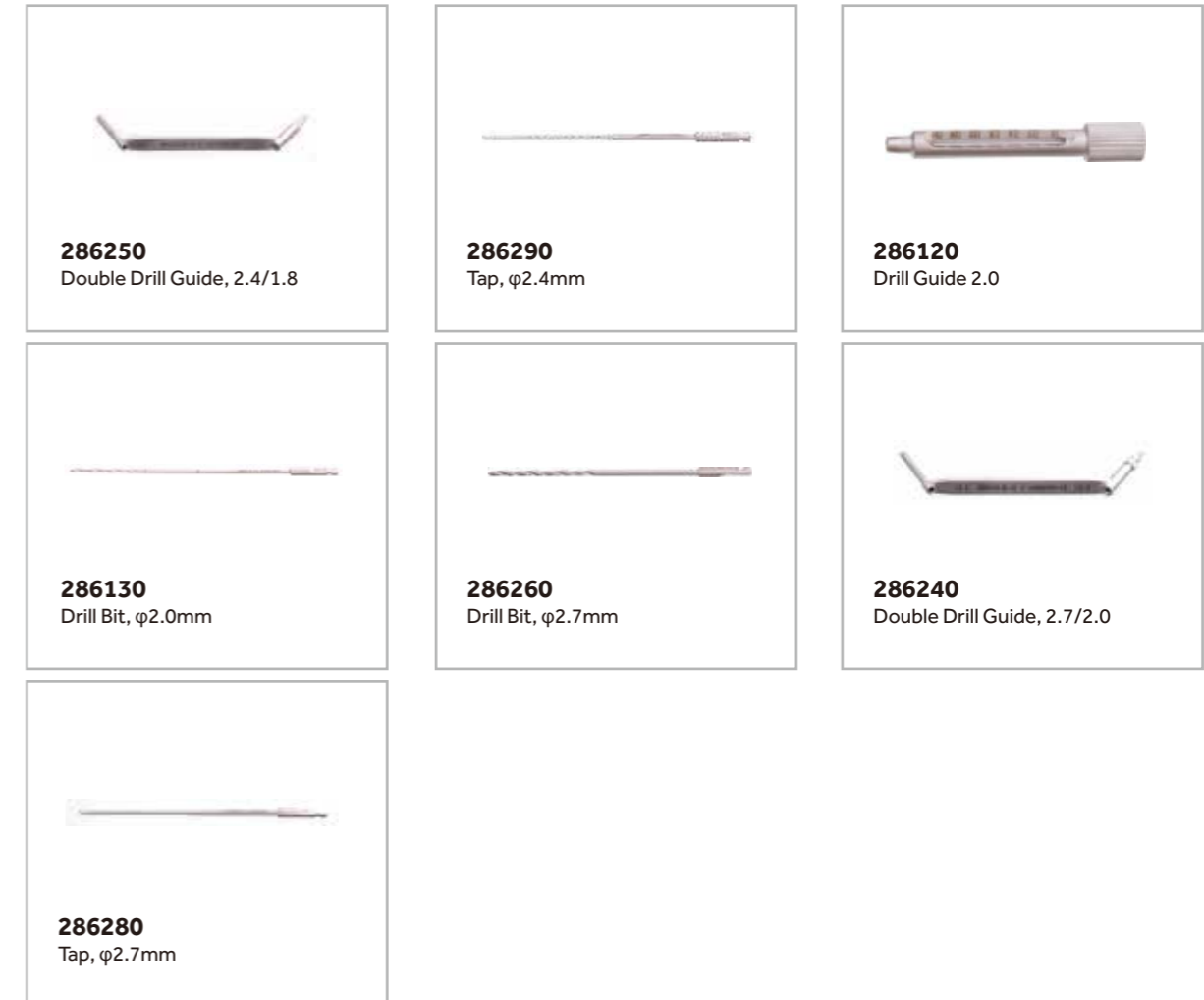



# MonoLoc Locking Plates System

## Limbs

### Distal Radius

Distal Radius Volar Locking Compression Plate



Thickness (mm)	2.5
Material	PT

Code	Model No.	Direction	Size	Length (mm)	Width (mm)
29568400	SDXG87	Left	4H	60.1	Head 24.4
29568401	SDXG87	Left	7H	90	Head 24.4
29568402	SDXG87	Left	3H	51.9	Head 24.4
29568300	SDXG88	Right	4H	60.1	Head 24.4
29568301	SDXG88	Right	7H	90	Head 24.4
29568302	SDXG88	Right	3H	51.9	Head 24.4

Distal Dorsal Radius Locking Compression T-Plates 2.7



Thickness (mm)	1.6
Width (mm)	6.5
Material	PT

Code	Model No.	Size	Length (mm)
22557003	SDXG43	3H	42
22557004	SDXG43	4H	54
22557005	SDXG43	5H	66
22557006	SDXG43	6H	78
22557007	SDXG43	7H	90
22557008	SDXG43	8H	102

Distal Lateral Radius Locking Compression Plates 2.7



Thickness (mm)	1.7
Width (mm)	6.5
Material	PT

Code	Model No.	Size	Length (mm)
22555005	SDXG33	5H	48
22555006	SDXG33	6H	57

Distal Dorsal Radius Locking Compression Oblique L-Plates 2.7



Thickness (mm)	1.6
Width (mm)	6.5
Material	PT

Code	Model No.	Size	Direction	Length (mm)
22556203	SDXG51	3+3H	Left	43
22556204	SDXG51	3+4H	Left	52
22556103	SDXG52	3+3H	Right	43
22556104	SDXG52	3+4H	Right	52

# MonoLoc Locking Plates System

## Limbs

### Distal Radius

Distal Dorsal Radius Locking Compression L-Plates II 2.7



Thickness (mm)	1.7
Width (mm)	6.5
Material	PT

Code	Model No.	Size	Direction	Length (mm)
22558203	SDXG35	3H	Left	40
22558204	SDXG35	4H	Left	49
22558103	SDXG34	3H	Right	40
22558104	SDXG34	4H	Right	49

Distal Radius Volar Column Plates I 2.7



Thickness (mm)	2
Width (mm)	9
Material	PT

Code	Model No.	Size	Direction	Length (mm)
22559203	SDXG59	9+3H	Left	46.5
22559204	SDXG59	9+4H	Left	55.5
22559205	SDXG59	9+5H	Left	64.5
22559103	SDXG59	9+3H	Right	46.5
22559104	SDXG59	9+4H	Right	55.5
22559105	SDXG59	9+5H	Right	64.5

Distal Radius Volar Column Plates II 2.7



Thickness (mm)	2
Width (mm)	8.5
Material	PT

Code	Model No.	Size	Direction	Length (mm)
22560203	SDXG59	8+3H	Left	46.5
22560204	SDXG59	8+4H	Left	55.5
22560205	SDXG59	8+5H	Left	64.5
22560206	SDXG59	8+6H	Left	73.5
22560208	SDXG59	8+8H	Left	91.5
22560210	SDXG59	8+10H	Left	109.5
22560212	SDXG59	8+12H	Left	127.5
22560103	SDXG59	8+3H	Right	46.5
22560104	SDXG59	8+4H	Right	55.5
22560105	SDXG59	8+5H	Right	64.5
22560106	SDXG59	8+6H	Right	73.5
22560108	SDXG59	8+8H	Right	91.5
22560110	SDXG59	8+10H	Right	109.5
22560112	SDXG59	8+12H	Right	127.5

Distal Radius Locking Compression Plate, Volar, 2.7



Thickness (mm)	1.8
Width (mm)	7.5
Material	PT

Code	Model No.	Size	Direction	Length (mm)
22572203	SDXG53	5+3H	Left	45
22572204	SDXG53	5+4H	Left	53
22572205	SDXG53	5+5H	Left	61
22572206	SDXG53	5+6H	Left	69
22572208	SDXG53	5+8H	Left	85
22572210	SDXG53	5+10H	Left	101
22572212	SDXG53	5+12H	Left	117
22572103	SDXG54	5+3H	Right	45
22572104	SDXG54	5+4H	Right	53
22572105	SDXG54	5+5H	Right	61
22572106	SDXG54	5+6H	Right	69
22572108	SDXG54	5+8H	Right	85
22572110	SDXG54	5+10H	Right	101
22572112	SDXG54	5+12H	Right	117

# MonoLoc Locking Plates System

## Limbs

### Distal Radius

#### 2.0mm Smooth Screw



Shaft (mm)	2
Material	TA

Code	Model No.	Size
39568210	SDLD04	2.0x10mm
39568212	SDLD04	2.0x12mm
39568214	SDLD04	2.0x14mm
39568216	SDLD04	2.0x16mm
39568218	SDLD04	2.0x18mm
39568220	SDLD04	2.0x20mm
39568222	SDLD04	2.0x22mm
39568224	SDLD04	2.0x24mm
39568226	SDLD04	2.0x26mm
39568228	SDLD04	2.0x28mm
39568230	SDLD04	2.0x30mm

#### 2.7 mm Cortex Screw, self-tapping



Core (mm)	1.9
Material	TA

Code	Model No.	Size
30375010	HAQ06	10mm
30375012	HAQ06	12mm
30375014	HAQ06	14mm
30375016	HAQ06	16mm
30375018	HAQ06	18mm
30375020	HAQ06	20mm
30375022	HAQ06	22mm
30375024	HAQ06	24mm
30375026	HAQ06	26mm
30375028	HAQ06	28mm
30375030	HAQ06	30mm
30375032	HAQ06	32mm
30375034	HAQ06	34mm
30375036	HAQ06	36mm
30375038	HAQ06	38mm
30375040	HAQ06	40mm
30375042	HAQ06	42mm
30375044	HAQ06	44mm
30375046	HAQ06	46mm
30375048	HAQ06	48mm
30375050	HAQ06	50mm

#### 2.7mm Locking Head Screw, self-tapping



Core (mm)	2.1
Material	TA

Code	Model No.	Size
32580006	SDLD01	6mm
32580008	SDLD01	8mm
32580010	SDLD01	10mm
32580012	SDLD01	12mm
32580014	SDLD01	14mm
32580016	SDLD01	16mm
32580018	SDLD01	18mm
32580020	SDLD01	20mm
32580022	SDLD01	22mm
32580024	SDLD01	24mm
32580026	SDLD01	26mm
32580028	SDLD01	28mm
32580030	SDLD01	30mm
32580032	SDLD01	32mm
32580034	SDLD01	34mm
32580036	SDLD01	36mm
32580038	SDLD01	38mm
32580040	SDLD01	40mm
32580042	SDLD01	42mm
32580044	SDLD01	44mm
32580046	SDLD01	46mm
32580048	SDLD01	48mm
32580050	SDLD01	50mm

# MonoLoc Locking Plates System

## Limbs

### Straight Locking Plates

#### Locking Compression Plates 3.5



Thickness (mm)	3.6
Width (mm)	11
Material	PT

Code	Model No.	Size	Length (mm)
22501004	SDXG37	4H	51
22501005	SDXG37	5H	64
22501006	SDXG37	6H	77
22501007	SDXG37	7H	90
22501008	SDXG37	8H	103
22501009	SDXG37	9H	116
22501010	SDXG37	10H	129
22501011	SDXG37	11H	142
22501012	SDXG37	12H	155

#### Straight Locking Compression Plate 3.5, thickness 3.0



Thickness (mm)	3
Width (mm)	9.5
Material	PT

Code	Model No.	Size	Length (mm)
22597004	SDXG11	4H	60
22597005	SDXG11	5H	73
22597006	SDXG11	6H	86
22597007	SDXG11	7H	99
22597008	SDXG11	8H	112
22597009	SDXG11	9H	125
22597010	SDXG11	10H	138
22597011	SDXG11	11H	151
22597012	SDXG11	12H	164

#### Straight Locking Compression Plate 3.5, thickness 1.8



Thickness (mm)	1.8
Width (mm)	9.5
Material	PT

Code	Model No.	Size	Length (mm)
22596004	SDXZ11	4H	60
22596005	SDXZ11	5H	73
22596006	SDXZ11	6H	86
22596007	SDXZ11	7H	99
22596008	SDXZ11	8H	112
22596010	SDXZ11	10H	138
22596012	SDXZ11	12H	164

#### Metaphyseal Locking Compression Plates 3.5



Thickness (mm)	3.6
Width (mm)	10.5
Material	PT

Code	Model No.	Size	Length (mm)
29593101	SDDZ40	4H	60
29593102	SDDG40	5H	73
22506006	SDDG40	6H	86
22506007	SDDG40	7H	99
22506008	SDDG40	8H	112
22506009	SDDG40	9H	125
22506010	SDDG40	10H	138
22506011	SDDG40	11H	151
22506012	SDDG40	12H	164
22506014	SDDG40	14H	190
22506016	SDDG40	16H	216
22506018	SDDG40	18H	242

# MonoLoc Locking Plates System

## Limbs

### Straight Locking Plates

Metaphyseal Locking Compression Plates 3.5/4.5



Specification	
Thickness (mm)	4.2
Width (mm)	13
Material	PT

Code	Model No.	Size	Length (mm)
22520003	SDDG41	5+3H	118
22520004	SDDG41	5+4H	136
22520005	SDDG41	5+5H	154
22520006	SDDG41	5+6H	172
22520007	SDDG41	5+7H	190
22520008	SDDG41	5+8H	208
22520009	SDDG41	5+9H	226
22520011	SDDG41	5+11H	262
22520013	SDDG41	5+13H	298
22520015	SDDG41	5+15H	334

Reconstruction Locking Plates 3.5



Specification	
Thickness (mm)	3
Width (mm)	10
Material	PT

Code	Model No.	Size	Length (mm)
22551005	SDDZ36	5H	64
22551006	SDDZ36	6H	77
22551007	SDDZ36	7H	90
22551008	SDDZ36	8H	103
22551009	SDDZ36	9H	116
22551010	SDDZ36	10H	129
22551011	SDDZ36	11H	142
22551012	SDDZ36	12H	155
22551013	SDDZ36	13H	168
22551014	SDDZ36	14H	181
22551015	SDDZ36	15H	194
22551016	SDDZ36	16H	207
22551018	SDDZ36	18H	233

Locking compression Plates 4.5/5.0, narrow



Specification	
Thickness (mm)	4.8
Width (mm)	13.5
Material	PT

Code	Model No.	Size	Length (mm)
22521004	SDDZ38	4H	89
22521005	SDDG38	5H	107
22521006	SDDG38	6H	125
22521007	SDDG38	7H	143
22521008	SDDG38	8H	161
22521009	SDDG38	9H	179
22521010	SDDG38	10H	197
22521011	SDDG38	11H	215
22521012	SDDG38	12H	233
22521013	SDDG38	13H	251
22521014	SDDG38	14H	269
22521016	SDDG38	16H	287

Locking compression Plates 4.5/5.0, broad



Specification	
Thickness (mm)	6
Width (mm)	17.5
Material	PT

Code	Model No.	Size	Length (mm)
22587006	SDDG39	6H	107
22587007	SDDG39	7H	125
22587008	SDDG39	8H	143
22587009	SDDG39	9H	161
22587010	SDDG39	10H	179
22587011	SDDG39	11H	197
22587012	SDDG39	12H	215
22587013	SDDG39	13H	233
22587014	SDDG39	14H	251
22587015	SDDG39	15H	269
22587016	SDDG39	16H	287
22587017	SDDG39	17H	305
22587018	SDDG39	18H	323

# MonoLoc Locking Plates System

## Limbs

### Straight Locking Plates

Reconstruction Locking Plates 5.0



Specification	
Thickness (mm)	3.3
Width (mm)	12
Material	PT

Code	Model No.	Size	Length (mm)
22552003	SDDZ36	3H	48
22552004	SDDZ36	4H	64
22552005	SDDZ36	5H	80
22552006	SDDZ36	6H	96
22552007	SDDZ36	7H	112
22552008	SDDZ36	8H	128
22552009	SDDZ36	9H	144
22552010	SDDZ36	10H	160
22552011	SDDZ36	11H	176
22552012	SDDZ36	12H	192
22552013	SDDZ36	13H	208
22552014	SDDZ36	14H	224
22552015	SDDZ36	15H	240
22552016	SDDZ36	16H	256

### Shoulder

Clavicular Locking S-Plates 3.5



Specification	
Thickness (mm)	2.5
Width (mm)	10
Material	PT

Code	Model No.	Size	Direction	Length (mm)
22554206	SDXZ28	6H	Left	61.8
22554207	SDXZ28	7H	Left	77.1
22554208	SDXZ28	8H	Left	91.3
22554209	SDXZ28	9H	Left	92
22554210	SDXZ28	10H	Left	103.9
22554212	SDXZ28	12H	Left	127.7
22554106	SDXZ27	6H	Right	61.8
22554107	SDXZ27	7H	Right	77.1
22554108	SDXZ27	8H	Right	91.3
22554109	SDXZ27	9H	Right	92
22554110	SDXZ27	10H	Right	103.9
22554112	SDXZ27	12H	Right	127.7

Anterolateral Clavicular Locking Compression Plate, 2.7/3.5



Specification	
Thickness (mm)	3.1
Width (mm)	10.5
Material	PT

Code	Model No.	Size	Direction	Length (mm)
22578210	SDXZ08	10H	Left	68
22578211	SDXZ08	11H	Left	80
22578212	SDXG08	12H	Left	92
22578213	SDXG08	13H	Left	104
22578214	SDXG08	14H	Left	116
22578215	SDXG08	15H	Left	128
22578110	SDXZ07	10H	Right	68
22578111	SDXZ07	11H	Right	80
22578112	SDXG07	12H	Right	92
22578113	SDXG07	13H	Right	104
22578114	SDXG07	14H	Right	116
22578115	SDXG07	15H	Right	128

# MonoLoc Locking Plates System

## Limbs

### Shoulder

Clavicular Locking Compression Plates 3.5



Specification	
Thickness (mm)	3.2
Width (mm)	10
Material	PT

Code	Model No.	Size	Direction	Length (mm)
22510202	SDXG25	3+2H	Left	45
22510203	SDXG25	3+3H	Left	55
22510205	SDXG25	3+5H	Left	75
22510207	SDXG25	3+7H	Left	95
22510102	SDXG26	3+2H	Right	45
22510103	SDXG26	3+3H	Right	55
22510105	SDXG26	3+5H	Right	75
22510107	SDXG26	3+7H	Right	95

Clavicular Locking Compression Plates II 3.5, 12mm



Specification	
Thickness (mm)	3.6
Width (mm)	11
Material	PT

Code	Model No.	Size	Direction	Length (mm)
24239202	SDXG25	3+2H	Left	44
24239203	SDXG25	3+3H	Left	54
24239204	SDXG25	3+4H	Left	64
24239205	SDXG25	3+5H	Left	74
24239206	SDXG25	3+6H	Left	84
24239207	SDXG25	3+7H	Left	94
24239102	SDXG26	3+2H	Right	44
24239103	SDXG26	3+3H	Right	54
24239104	SDXG26	3+4H	Right	64
24239105	SDXG26	3+5H	Right	74
24239106	SDXG26	3+6H	Right	84
24239107	SDXG26	3+7H	Right	94

Clavicular Locking Compression Plates II 3.5, 15mm



Specification	
Thickness (mm)	3.6
Width (mm)	11
Material	PT

Code	Model No.	Size	Direction	Length (mm)
22586202	SDXG25	3+2H	Left	45
22586203	SDXG25	3+3H	Left	55
22586204	SDXG25	3+4H	Left	65
22586205	SDXG25	3+5H	Left	75
22586206	SDXG25	3+6H	Left	85
22586207	SDXG25	3+7H	Left	95
22586102	SDXG26	3+2H	Right	45
22586103	SDXG26	3+3H	Right	55
22586104	SDXG26	3+4H	Right	65
22586105	SDXG26	3+5H	Right	75
22586106	SDXG26	3+6H	Right	85
22586107	SDXG26	3+7H	Right	95

Clavicular Locking Compression Plates II 3.5, 18mm



Specification	
Thickness (mm)	3.6
Width (mm)	11
Material	PT

Code	Model No.	Size	Direction	Length (mm)
24240202	SDXG25	3+2H	Left	46
24240203	SDXG25	3+3H	Left	56
24240204	SDXG25	3+4H	Left	66
24240205	SDXG25	3+5H	Left	76
24240206	SDXG25	3+6H	Left	86
24240207	SDXG25	3+7H	Left	96
24240102	SDXG26	3+2H	Right	46
24240103	SDXG26	3+3H	Right	56
24240104	SDXG26	3+4H	Right	66
24240105	SDXG26	3+5H	Right	76
24240106	SDXG26	3+6H	Right	86
24240107	SDXG26	3+7H	Right	96

# MonoLoc Locking Plates System

## Limbs

### Shoulder

Proximal Humeral Locking Compression Plates 3.5, short



Specification	
Thickness (mm)	3.6
Width (mm)	12
Material	PT

Code	Model No.	Size	Length (mm)
22508003	SDXG36	3H	84
22508005	SDXG36	5H	108

Proximal Humeral Locking Compression Plates 3.5, long



Specification	
Thickness (mm)	3.6
Width (mm)	12
Material	PT

Code	Model No.	Size	Length (mm)
22509005	SDXG36	5H	132
22509006	SDXG36	6H	150
22509008	SDXG36	8H	186
22509010	SDXG36	10H	222
22509012	SDXG36	12H	258

Clavicular Reconstruction Locking Compression Plate 3.5



Specification	
Thickness (mm)	3
Width (mm)	10.5
Material	PT

Code	Model No.	Size	Direction	Length (mm)
22563206	SDXG23	6H	Left	103.2
22563207	SDXG23	7H	Left	113
22563208	SDXG23	8H	Left	122.5
22563106	SDXG22	6H	Right	103.2
22563107	SDXG22	7H	Right	113
22563108	SDXG22	8H	Right	122.5



# MonoLoc Locking Plates System

## Limbs

### Elbow

Distal Dorsal Humeral Locking Compression Plates, 2.7/3.5



Thickness (mm)	2.5
Width (mm)	11.2
Material	PT

Code	Model No.	Size	Direction	Length (mm)
22594203	SDXG30	6+3H	Left	65
22594205	SDXG30	6+5H	Left	91
22594207	SDXG30	6+7H	Left	117
22594209	SDXG30	6+9H	Left	143
22594103	SDXG29	6+3H	Right	65
22594105	SDXG29	6+5H	Right	91
22594107	SDXG29	6+7H	Right	117
22594109	SDXG29	6+9H	Right	143

Distal Medial Humeral Locking Compression Plates 2.7/3.5



Thickness (mm)	2.5
Width (mm)	11.2
Material	PT

Code	Model No.	Size	Direction	Length (mm)
22579206	SDXZ09	3+3 H	Left	59
22579208	SDXG09	3+5 H	Left	84
22579210	SDXG09	3+7 H	Left	110
22579212	SDXG09	3+9 H	Left	136
22579106	SDXZ10	3+3 H	Right	59
22579108	SDXG10	3+5 H	Right	84
22579110	SDXG10	3+7 H	Right	110
22579112	SDXG10	3+9 H	Right	136

Olecranal Locking Compression Plates 3.5



Thickness (mm)	3.2
Width (mm)	10
Material	PT

Code	Model No.	Size	Direction	Length (mm)
22573204	SDXG41	4H	Left	112
22573206	SDXG41	6H	Left	138
22573208	SDXG41	8H	Left	164
22573210	SDXG41	10H	Left	190
22573212	SDXG41	12H	Left	216
22573104	SDXG42	4H	Right	112
22573106	SDXG42	6H	Right	138
22573108	SDXG42	8H	Right	164
22573110	SDXG42	10H	Right	190
22573112	SDXG42	12H	Right	216

Distal Medial Humeral Locking Compression Plates, 3.5



Thickness (mm)	3.2
Width (mm)	11
Material	PT

Code	Model No.	Size	Length (mm)
22513003	SDXG32	4+3H	80
22513005	SDXG32	4+5H	106
22513007	SDXG32	4+7H	132
22513009	SDXG32	4+9H	158
22513011	SDXG32	4+11H	184

# MonoLoc Locking Plates System

## Limbs

### Foot & Ankle

Distal Tibia Locking Compression Plates 3.5



Thickness (mm)	4.2
Width (mm)	11.7
Material	PT

Code	Model No.	Size	Direction	Length (mm)
22528204	SDDG44	4H	Left	116
22528206	SDDG44	6H	Left	142
22528208	SDDG44	8H	Left	168
22528210	SDDG44	10H	Left	194
22528212	SDDG44	12H	Left	220
22528214	SDDG44	14H	Left	246
22528104	SDDG45	4H	Right	116
22528106	SDDG45	6H	Right	142
22528108	SDDG45	8H	Right	168
22528110	SDDG45	10H	Right	194
22528112	SDDG45	12H	Right	220
22528114	SDDG45	14H	Right	246

Anterolateral Distal Tibia L Locking Compression Plate 3.5



Thickness (mm)	4.2
Width (mm)	14
Material	PT

Code	Model No.	Size	Direction	Length (mm)
22574209	SDDG51	9H	Left	117
22574211	SDDG51	11H	Left	149
22574213	SDDG51	13H	Left	181
22574215	SDDG51	15H	Left	213
22574217	SDDG51	17H	Left	245
22574219	SDDG51	19H	Left	277
22574109	SDDG50	9H	Right	117
22574111	SDDG50	11H	Right	149
22574113	SDDG50	13H	Right	181
22574115	SDDG50	15H	Right	213
22574117	SDDG50	17H	Right	245
22574119	SDDG50	19H	Right	277

Distal Tibia Locking Compression Plates 3.5 II



Thickness (mm)	4.2
Width (mm)	13.7
Material	PT

Code	Model No.	Size	Direction	Length (mm)
22561204	SDDG59	8+4H	Left	116
22561206	SDDG59	8+6H	Left	142
22561208	SDDG59	8+8H	Left	168
22561210	SDDG59	8+10H	Left	194
22561104	SDDG59	8+4H	Right	116
22561106	SDDG59	8+6H	Right	142
22561108	SDDG59	8+8H	Right	168
22561110	SDDG59	8+10H	Right	194

Calcaneus Locking Plate II 3.5



Thickness (mm)	1.7
Width (mm)	36
Material	PT

Code	Model No.	Size	Length (mm)
22598013	SDXZ66	13H	60
22598014	SDXZ66	14H	64
22598015	SDXZ66	15H	70
22598016	SDXZ66	16H	78



# MonoLoc Locking Plates System

## Limbs

### Foot & Ankle

Locking Lateral Distal Fibula Plates, 2.7/3.5



Thickness (mm)	2.5
Width (mm)	10.5
Material	PT

Code	Model No.	Size	Direction	Length (mm)
22550203	SDDG20	5+3H	Left	86
22550204	SDDG20	5+4H	Left	99
22550205	SDDG20	5+5H	Left	112
22550206	SDDG20	5+6H	Left	125
22550207	SDDG20	5+7H	Left	138
22550209	SDDG20	5+9H	Left	164
22550211	SDDG20	5+11H	Left	190
22550213	SDDG20	5+13H	Left	216
22550215	SDDG20	5+15H	Left	242
22550103	SDDG19	5+3H	Right	86
22550104	SDDG19	5+4H	Right	99
22550105	SDDG19	5+5H	Right	112
22550106	SDDG19	5+6H	Right	125
22550107	SDDG19	5+7H	Right	138
22550109	SDDG19	5+9H	Right	164
22550111	SDDG19	5+11H	Right	190
22550113	SDDG19	5+13H	Right	216
22550115	SDDG19	5+15H	Right	242

Calcaneus Locking Plate III 3.5



Thickness (mm)	1.7
Width (mm)	37.3
Material	PT

Code	Model No.	Size	Length (mm)
22599060	SDXZ67	12H	60
22599068	SDXZ67	12H	68

Calcaneal Locking Plates 3.5



Thickness (mm)	2
Material	PT

Code	Model No.	Direction	Length (mm)
22553215	SDXZ71	Left	68
22553115	SDXZ71	Right	68

# MonoLoc Locking Plates System

## Limbs

### Hip

Proximal Lateral Femoral Locking Compression Plates 4.5/5.0



Thickness (mm)	5.2
Width (mm)	18
Material	PT

Code	Model No.	Size	Direction	Length (mm)
22531205	SDDG47	5+5H	Left	165
22531207	SDDG47	5+7H	Left	205
22531209	SDDG47	5+9H	Left	245
22531211	SDDG47	5+11H	Left	285
22531213	SDDG47	5+13H	Left	325
22531105	SDDG46	5+5H	Right	165
22531107	SDDG46	5+7H	Right	205
22531109	SDDG46	5+9H	Right	245
22531111	SDDG46	5+11H	Right	285
22531113	SDDG46	5+13H	Right	325

Proximal Lateral Femoral Locking Compression Plate 4.5/5.0



Thickness (mm)	5.2
Width (mm)	18
Material	PT

Code	Model No.	Size	Direction	Length (mm)
22575204	SDDG47	5+4H	Left	145
22575206	SDDG47	5+6H	Left	185
22575208	SDDG47	5+8H	Left	225
22575210	SDDG47	5+10H	Left	265
22575212	SDDG47	5+12H	Left	305
22575104	SDDG46	5+4H	Right	145
22575106	SDDG46	5+6H	Right	185
22575108	SDDG46	5+8H	Right	225
22575110	SDDG46	5+10H	Right	265
22575112	SDDG46	5+12H	Right	305

Pelvic Locking Reconstruction Plate 3.5



Thickness (mm)	3
Width (mm)	10
Material	PT

Code	Model No.	Size	Length (mm)
22595008	SDDZ37	8H	94
22595010	SDDZ37	10H	118
22595012	SDDZ37	12H	142
22595014	SDDZ37	14H	166
22595016	SDDZ37	16H	190

# MonoLoc Locking Plates System

## Limbs

### Knee

Locking Medial Proximal Tibial plate 4.5/5.0



Specification	
Thickness (mm)	3.8
Width (mm)	14
Material	PT

Code	Model No.	Size	Direction	Length (mm)
22589204	SDDZ21	3+4H	Left	84
22589205	SDDG21	3+5H	Left	100
22589206	SDDG21	3+6H	Left	116
22589207	SDDG21	3+7H	Left	132
22589208	SDDG21	3+8H	Left	148
22589209	SDDG21	3+9H	Left	164
22589210	SDDG21	3+10H	Left	180
22589211	SDDG21	3+11H	Left	196
22589212	SDDG21	3+12H	Left	212
22589213	SDDG21	3+13H	Left	228
22589104	SDDZ22	3+4H	Right	84
22589105	SDDG22	3+5H	Right	100
22589106	SDDG22	3+6H	Right	116
22589107	SDDG22	3+7H	Right	132
22589108	SDDG22	3+8H	Right	148
22589109	SDDG22	3+9H	Right	164
22589110	SDDG22	3+10H	Right	180
22589111	SDDG22	3+11H	Right	196
22589112	SDDG22	3+12H	Right	212
22589113	SDDG22	3+13H	Right	228

Locking Proximal Tibial Plate 4.5/5.0



Specification	
Thickness (mm)	3.8
Width (mm)	14
Material	PT

Code	Model No.	Size	Direction	Length (mm)
22591204	SDDG14	3+4H	Left	83.2
22591205	SDDG14	3+5H	Left	99.2
22591206	SDDG14	3+6H	Left	115.2
22591207	SDDG14	3+7H	Left	131.2
22591208	SDDG14	3+8H	Left	147.2
22591209	SDDG14	3+9H	Left	163.2
22591210	SDDG14	3+10H	Left	179.2
22591104	SDDG13	3+4H	Right	83.2
22591105	SDDG13	3+5H	Right	99.2
22591106	SDDG13	3+6H	Right	115.2
22591107	SDDG13	3+7H	Right	131.2
22591108	SDDG13	3+8H	Right	147.2
22591109	SDDG13	3+9H	Right	163.2
22591110	SDDG13	3+10H	Right	179.2

# MonoLoc Locking Plates System

## Limbs

### Knee

Proximal Lateral Tibia Locking Compression Plates 4.5/5.0



Specification	
Thickness (mm)	4.2
Width (mm)	16
Material	PT

Code	Model No.	Size	Direction	Length (mm)
22526205	SDDG49	5H	Left	140
22526207	SDDG49	7H	Left	180
22526209	SDDG49	9H	Left	220
22526211	SDDG49	11H	Left	260
22526213	SDDG49	13H	Left	300
22526105	SDDG48	5H	Right	140
22526107	SDDG48	7H	Right	180
22526109	SDDG48	9H	Right	220
22526111	SDDG48	11H	Right	260
22526113	SDDG48	13H	Right	300

Distal Femoral Locking Compression Plates 4.5/5.0



Specification	
Thickness (mm)	6
Width (mm)	16
Material	PT

Code	Model No.	Size	Direction	Length (mm)
22527205	SDDG52	5H	Left	156
22527207	SDDG52	7H	Left	196
22527209	SDDG52	9H	Left	236
22527211	SDDG52	11H	Left	276
22527213	SDDG52	13H	Left	316
22527105	SDDG53	5H	Right	156
22527107	SDDG53	7H	Right	196
22527109	SDDG53	9H	Right	236
22527111	SDDG53	11H	Right	276
22527113	SDDG53	13H	Right	316

# MonoLoc Locking Plates System

## Limbs

### Screws

Locking Head Screws, self-tapping



Specification		
Core (mm)		2.7
Material		TA

Code	Model No.	Size
31451010	SDLD01	3.5×10mm
31451012	SDLD01	3.5×12mm
31451014	SDLD01	3.5×14mm
31451016	SDLD01	3.5×16mm
31451018	SDLD01	3.5×18mm
31451020	SDLD01	3.5×20mm
31451022	SDLD01	3.5×22mm
31451024	SDLD01	3.5×24mm
31451026	SDLD01	3.5×26mm
31451028	SDLD01	3.5×28mm
31451030	SDLD01	3.5×30mm
31451032	SDLD01	3.5×32mm
31451034	SDLD01	3.5×34mm
31451036	SDLD01	3.5×36mm
31451038	SDLD01	3.5×38mm
31451040	SDLD01	3.5×40mm
31451042	SDLD01	3.5×42mm
31451044	SDLD01	3.5×44mm
31451045	SDLD01	3.5×45mm
31451046	SDLD01	3.5×46mm
31451048	SDLD01	3.5×48mm
31451050	SDLD01	3.5×50mm
31451055	SDLD01	3.5×55mm
31451060	SDLD01	3.5×60mm
31451065	SDLD01	3.5×65mm
31451070	SDLD01	3.5×70mm
31451075	SDLD01	3.5×75mm
31451080	SDLD01	3.5×80mm

Locking Head Screws, self-tapping, self-drilling



Specification		
Core (mm)		2.7
Material		TA

Code	Model No.	Size
39782012	SDLD02	3.5×12mm
39782014	SDLD02	3.5×14mm
39782016	SDLD02	3.5×16mm
39782018	SDLD02	3.5×18mm
39782020	SDLD02	3.5×20mm
39782022	SDLD02	3.5×22mm
39782024	SDLD02	3.5×24mm
39782026	SDLD02	3.5×26mm
39782028	SDLD02	3.5×28mm
39782030	SDLD02	3.5×30mm
39782032	SDLD02	3.5×32mm
39782034	SDLD02	3.5×34mm
39782036	SDLD02	3.5×36mm
39782038	SDLD02	3.5×38mm
39782040	SDLD02	3.5×40mm
39782045	SDLD02	3.5×45mm
39782050	SDLD02	3.5×50mm
39782055	SDLD02	3.5×55mm
39782060	SDLD02	3.5×60mm
39782065	SDLD02	3.5×65mm
39782070	SDLD02	3.5×70mm

Spacer, 2mm Length



Specification		
Material		TA

Code	Model No.	Size
31453005	SDLD04	3.5mm

# MonoLoc Locking Plates System

## Limbs

### Screws

Locking Head Screws, self-tapping, self-drilling



Specification		
Core (mm)		4.2
Material		TA

Code	Model No.	Size
32582014	SDLD02	5.0×14mm
32582016	SDLD02	5.0×16mm
32582018	SDLD02	5.0×18mm
32582020	SDLD02	5.0×20mm
32582022	SDLD02	5.0×22mm
32582024	SDLD02	5.0×24mm
32582026	SDLD02	5.0×26mm
32582028	SDLD02	5.0×28mm
32582030	SDLD02	5.0×30mm
32582032	SDLD02	5.0×32mm
32582034	SDLD02	5.0×34mm
32582036	SDLD02	5.0×36mm
32582038	SDLD02	5.0×38mm
32582040	SDLD02	5.0×40mm
32582042	SDLD02	5.0×42mm
32582044	SDLD02	5.0×44mm
32582046	SDLD02	5.0×46mm
32582048	SDLD02	5.0×48mm
32582050	SDLD02	5.0×50mm
32582055	SDLD02	5.0×55mm
32582060	SDLD02	5.0×60mm
32582065	SDLD02	5.0×65mm
32582070	SDLD02	5.0×70mm
32582075	SDLD02	5.0×75mm
32582080	SDLD02	5.0×80mm
32582085	SDLD02	5.0×85mm

Spacer, 2mm Length



Specification		
Material		TA

Code	Model No.	Size
31454007	SDLD04	5.0mm

Locking Head Screws, self-tapping



Specification		
Core (mm)		4.2
Material		TA

Code	Model No.	Size
31452014	SDLD01	5.0×14mm
31452016	SDLD01	5.0×16mm
31452018	SDLD01	5.0×18mm
31452020	SDLD01	5.0×20mm
31452022	SDLD01	5.0×22mm
31452024	SDLD01	5.0×24mm
31452026	SDLD01	5.0×26mm
31452028	SDLD01	5.0×28mm
31452030	SDLD01	5.0×30mm
31452032	SDLD01	5.0×32mm
31452034	SDLD01	5.0×34mm
31452036	SDLD01	5.0×36mm
31452038	SDLD01	5.0×38mm
31452040	SDLD01	5.0×40mm
31452042	SDLD01	5.0×42mm
31452044	SDLD01	5.0×44mm
31452046	SDLD01	5.0×46mm
31452048	SDLD01	5.0×48mm
31452050	SDLD01	5.0×50mm
31452055	SDLD01	5.0×55mm
31452060	SDLD01	5.0×60mm
31452065	SDLD01	5.0×65mm
31452070	SDLD01	5.0×70mm
31452075	SDLD01	5.0×75mm
31452080	SDLD01	5.0×80mm
31452085	SDLD01	5.0×85mm
31452090	SDLD01	5.0×90mm

# MonoLoc Locking Plates System

## Limbs

### Monoloc 2.7mm Instruments Set

Code	Product Description	Qty.
287900	MonoLoc 2.7mm Locking Plate System Instruments Set	
898200	2.7mm Implants Tray	1
898137	2.7mm Screw Case-PPSU	1
898346	MonoLoc 2.7mm Locking Plate System Instruments Set (Empty)-PPSU	1
286120	Drill Guide 2.0	2
286130	Drill Bit, 2.0mm	2
286220	Drill Guide 1.8	2
286230	Drill Bit, 1.8mm	2
286140	Torque-limiting Screwdriver, T8	1
286150	Screw Holding Sleeve	1
286200	Depth Gauge, 60mm	1
286210	StarDrive Screwdriver Shaft, T8	1
030100	T-Handle with Quick Coupling	1
286190	Easyout	1
286260	Drill Bit, 2.7mm	2
286270	Drill Bit, 2.4mm	2
286280	Tap, 2.7mm	1
286290	Tap, 2.4mm	1
286300	Countersink	1
286310	Screwdriver, self-retaining	1
01214	Bending Iron	2
01123	Reduction Forceps with Points	1
01124	Reduction Forceps with Points, toothed	1
01232	Periosteal Elevator, width 3mm	1
01215	Retractor, width 6mm	1
286240	Double Drill Guide, 2.7/2.0	1
286250	Double Drill Guide, 2.4/1.8	1
10735150	K-wire, 1.8×150mm	3

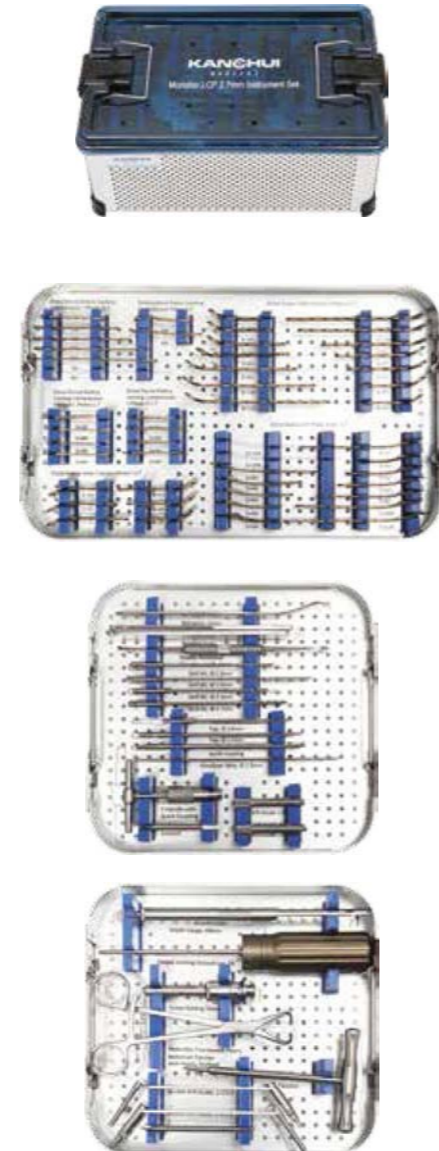

# MonoLoc Locking Plates System

## Limbs

### Monoloc 2.7mm Instruments

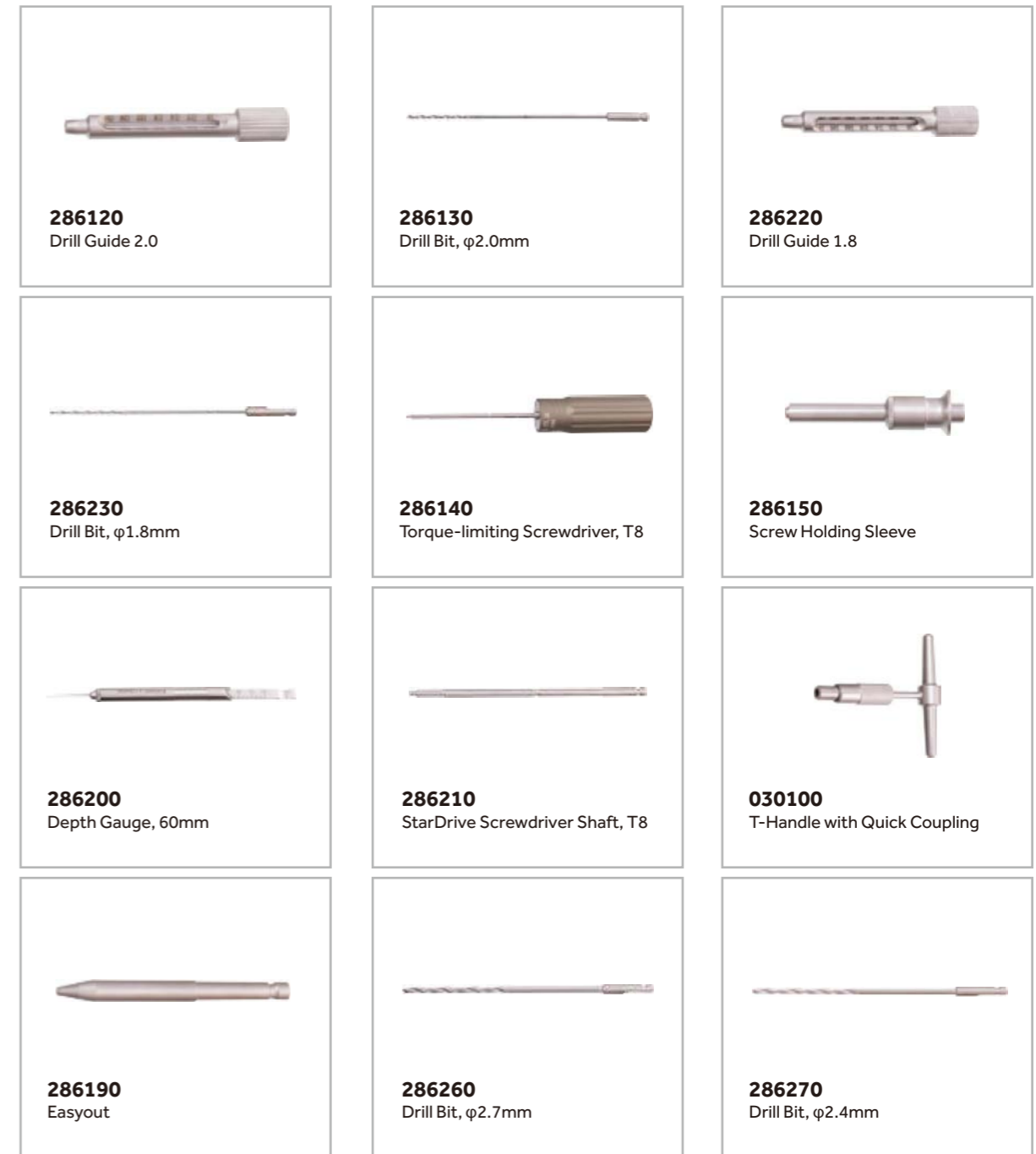















# MonoLoc Locking Plates System

## Limbs

### Monoloc 2.7mm Instruments

 <p><b>286280</b> Tap, φ2.7mm</p>	 <p><b>286290</b> Tap, φ2.4mm</p>	 <p><b>286300</b> Countersink</p>
 <p><b>286310</b> Screwdriver, self-retaining</p>	 <p><b>01214</b> Bending Iron</p>	 <p><b>01123</b> Reduction Forceps with Points</p>
 <p><b>01124</b> Reduction Forceps with Points, toothed</p>	 <p><b>01232</b> Periosteal Elevator, width 3mm</p>	 <p><b>01215</b> Retractor, width 6mm</p>
 <p><b>286240</b> Double Drill Guide, 2.7/2.0</p>	 <p><b>286250</b> Double Drill Guide, 2.4/1.8</p>	 <p><b>10735150</b> K-wire, φ1.8×150mm</p>

# MonoLoc Locking Plates System

## Limbs

### Monoloc 3.5mm Instruments Set

Code	Product Description	Qty.
222900	MonoLoc 3.5mm Locking Plate System Instruments Set	
898142	3.5mm Screw Case -PPSU	1
898347	MonoLoc 3.5mm Locking Plate System Instruments Set (Empty)-PPSU	1
221100	Drill Guide 2.6	3
221111	Drill Bit with Stop, 2.6mm	1
222110	Drill Bit with straight shank, 2.6mm	2
221120	Guide Sleeve for K-Wire, 1.2mm	1
221151	Torque-limiting Screwdriver, T15	1
221140	Screw Holding Sleeve for StarDrive Screw	1
221160	Screwdriver, self-retaining	1
221180	Allen Key	1
10736220	Kirschner Wire, 1.2mm	3
221170	Extraction Screw, 3.5mm	1
221190	Drill Bit for Screw Head Removal	1
201150	Trephine	1
010030	Drill Bit, 3.5mm	1
010010	Drill Bit, 2.5mm	1
221200	Torx Screwdriver, with Quick Coupling	1
201120	Double Drill Guide 3.5/2.5	1
201130	Double Drill Sleeve 2.5	1
201200	Depth Gauge, 80mm	1
020020	Tap, 4.0mm	1
020010	Tap, 3.5mm	1
030100	T-handle with Quick Coupling	1
201250	Screw Holding Sleeve for Hex Screw	1
201140	Hex Screwdriver	1
201170	Bone Holding Forceps, self-centering	2
201180	Reduction Forceps, serrated jaws, small	1
201190	Reduction Forceps with Points, small	1
201160	Bending Irons	2

### optional instrument

Code	Product Description	Qty.
206270	Bending Irons	2
898139	Hex Screwdriver (silicon handle)	1

### Implant Case

Code	Product Description
898368	3.5 LCP Implant Case (2 cases)
898457	3.5mm Straight Plates Implant Case
898458	4.5/5.0mm Straight Plates Implant Case
898459	Ankle Plates Implant Case
898460	Elbow Plates Implant Case
898461	Hip Plates Implant Case
898462	Knee Plates Implant Case
898463	Shoulder Plates Implant Case





# MonoLoc Locking Plates System

## Limbs













### Monoloc 3.5mm Instrument

 <b>221100</b> Drill Guide 2.6	 <b>221111</b> Drill Bit with Stop, φ2.6mm	 <b>221120</b> Guide Sleeve for K-Wire, φ1.2mm
 <b>221151</b> Torque-limiting Screwdriver, T15	 <b>221140</b> Screw Holding Sleeve for StarDrive Screw	 <b>221160</b> Screwdriver, self-retaining
 <b>221180</b> Allen Key	 <b>10736220</b> Kirschner Wire, φ1.2mm	 <b>221170</b> Extraction Screw, φ3.5mm
 <b>221190</b> Drill Bit for Screw Head Removal	 <b>201150</b> Trepine	 <b>010030</b> Drill Bit, φ3.5mm

# MonoLoc Locking Plates System

## Limbs

### Monoloc 3.5mm Instrument

 <b>010010</b> Drill Bit, φ2.5mm	 <b>221200</b> Torx Screwdriver, with Quick Coupling	 <b>201120</b> Double Drill Guide 3.5/2.5
 <b>201130</b> Double Drill Sleeve 2.5	 <b>201200</b> Depth Gauge, 80mm	 <b>020020</b> Tap, φ4.0mm
 <b>020010</b> Tap, φ3.5mm	 <b>030100</b> T-handle with Quick Coupling	 <b>201250</b> Screw Holding Sleeve for Hex Screw
 <b>201140</b> Hex Screwdriver	 <b>201170</b> Bone Holding Forceps, self-centering	 <b>201180</b> Reduction Forceps, serrated jaws, small

# MonoLoc Locking Plates System

## Limbs

### Monoloc 3.5mm Instrument



# MonoLoc Locking Plates System

## Limbs

### Monoloc 5.0mm Instruments Set

Code	Product Description	Qty.
227900	MonoLoc 5.0mm Locking Plate System Instruments Set	
898146	5.0mm Screw Case -PPSU	1
898348	MonoLoc 5.0mm Locking Plate System Instruments Set (Empty)-PPSU	1
226100	Drill Guide 4.1	3
226110	Drill Bit with Stop, 4.1mm	1
227110	Drill Bit with straight shank, 4.1mm	2
226120	Guide Sleeve for K-Wire, 2.0mm	1
226151	Torque-limiting Screwdriver, T25	1
226140	Screw Holding Sleeve for StarDrive Screw	1
226160	Screwdriver, self-retaining	1
226200	Torx Screwdriver, with Quick Coupling	1
226170	Extraction Screw, 5.0mm	1
221180	Allen Key	1
226190	Drill Bit for Screw Head Removal	1
10737230	Kirschner Wire, 2.0mm	3
206110	Double Drill Guide 6.5/3.2	1
206120	Double Drill Guide 4.5/3.2	1
206240	Trephine	1
010040	Drill Bit, 4.5mm	1
010020	Drill Bit, 3.2mm	1
206170	Depth Gauge, 90mm	1
030100	T-handle with Quick Coupling	1
020040	Tap, 6.5mm	1
020030	Tap, 4.5mm	1
206280	Hex Screwdriver	1
206300	Screw Holding Sleeve for Hex Screw	1
206150	Reduction Forceps, serrated jaws, large	1
206160	Reduction Forceps with Points, large	1
206290	Bone Holding Forceps, self-centering	2
206320	Bending Irons, left	1
206340	Bending Irons, right	1

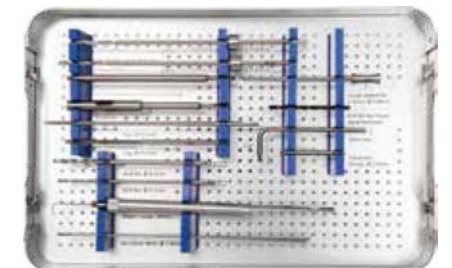
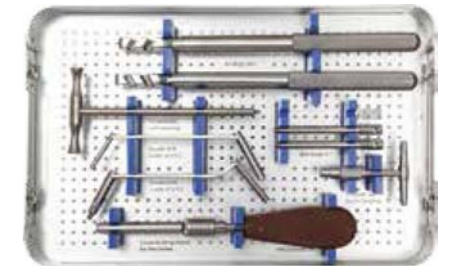

### Optional Instrument

Code	Product Description	Qty.
898144	Hex Screwdriver (silicon handle)	1
206330	Plates Bender	1

### Implant Case

Code	Product Description
898369	5.0 LCP Implant Case (2 cases)

# MonoLoc Locking Plates System

## Limbs













### Monoloc 5.0mm Instrument

 <b>226100</b> Drill Guide 4.1	 <b>226110</b> Drill Bit with Stop, φ4.1mm	 <b>226120</b> Guide Sleeve for K-Wire, φ2.0mm
 <b>226151</b> Torque-limiting Screwdriver, T25	 <b>226140</b> Screw Holding Sleeve for StarDrive Screw	 <b>226160</b> Screwdriver, self-retaining
 <b>226200</b> Torx Screwdriver, with Quick Coupling	 <b>226170</b> Extraction Screw, φ5.0mm	 <b>221180</b> Allen Key
 <b>226190</b> Drill Bit for Screw Head Removal	 <b>10737230</b> Kirschner Wire, φ2.0mm	 <b>206110</b> Double Drill Guide 6.5/3.2

# MonoLoc Locking Plates System

## Limbs

### Monoloc 5.0mm Instrument

 <b>206120</b> Double Drill Guide 4.5/3.2	 <b>206240</b> Trephine	 <b>010040</b> Drill Bit, φ4.5mm
 <b>010020</b> Drill Bit, φ3.2mm	 <b>206170</b> Depth Gauge, 90mm	 <b>030100</b> T-handle with Quick Coupling
 <b>020040</b> Tap, φ6.5mm	 <b>020030</b> Tap, φ4.5mm	 <b>206280</b> Hex Screwdriver
 <b>206300</b> Screw Holding Sleeve for Hex Screw	 <b>206150</b> Reduction Forceps, serrated jaws, large	 <b>206160</b> Reduction Forceps with Points, large

# MonoLoc Locking Plates System

## Limbs

### Monoloc 5.0mm Instrument



**206290**  
Bone Holding Forceps,  
self-centering



**206320**  
Bending Irons, left



**206340**  
Bending Irons, right



**206330**  
Plates Bender

# MonoLoc Locking Plates System

## Targeting Locking Plates System

### Targeting Proximal Humeral Locking Compression Plates 3.5, short



Thickness (mm)	3.6
Width (mm)	12
Material	PT

Code	Model No.	Size	Length (mm)
22547003	SDXG36	3H	84
22547005	SDXG36	5H	108

### Targeting Distal Femoral Locking Compression Plates 4.5/5.0



Thickness (mm)	6
Width (mm)	16
Material	PT

Code	Model No.	Size	Direction	Length (mm)
22543205	SDDG52	5H	Left	156
22543207	SDDG52	7H	Left	196
22543209	SDDG52	9H	Left	236
22543211	SDDG52	11H	Left	276
22543213	SDDG52	13H	Left	316
22543105	SDDG53	5H	Right	156
22543107	SDDG53	7H	Right	196
22543109	SDDG53	9H	Right	236
22543111	SDDG53	11H	Right	276
22543113	SDDG53	13H	Right	316

### Targeting Proximal Humeral Locking Compression Plates 3.5, long



Thickness (mm)	3.6
Width (mm)	12
Material	PT

Code	Model No.	Size	Length (mm)
22545005	SDXG36	5H	132
22545006	SDXG36	6H	150
22545008	SDXG36	8H	186
22545010	SDXG36	10H	222

### Targeting Proximal Tibia Locking Compression Plates 4.5/5.0



Thickness (mm)	4.2
Width (mm)	16
Material	PT

Code	Model No.	Size	Direction	Length (mm)
22544205	SDDG49	5H	Left	140
22544207	SDDG49	7H	Left	180
22544209	SDDG49	9H	Left	220
22544211	SDDG49	11H	Left	260
22544213	SDDG49	13H	Left	300
22544105	SDDG48	5H	Right	140
22544107	SDDG48	7H	Right	180
22544109	SDDG48	9H	Right	220
22544111	SDDG48	11H	Right	260
22544113	SDDG48	13H	Right	300

# MonoLoc Locking Plates System

## Targeting Locking Plates System

### Proximal Humeral Targeting Locking Plate Instruments Set

Code	Product Description	Qty.
898427	Proximal Humeral Targeting Locking Plate Instruments Set	
898428	Proximal Humeral Targeting Locking Plate Instrument Set (empty)	1
281100	Proximal Aiming Block	1
281110	Screw Sleeve	2
281120	Drill Bit Sleeve	2
281130	K-Wire Sleeve	2
281140	Depth Gauge	1
10734150	K-Wire, 1.6x150mm	3
281150	Screwdriver	1



Notice: The targeting set is additional to MonoLoc 3.5 instrument set.

### Distal Femoral and Proximal Tibia Targeting LCP Instruments Set

Code	Product Description	Qty.
898429	Distal Femoral and Proximal Tibia Targeting Locking Plate Instruments Set	
898430	Distal Femoral and Proximal Tibia Targeting Locking Plate Instruments Set (empty)	1
226210	Targeting Distal Femoral Locking Plate Aiming Device, left	1
226220	Targeting Distal Femoral Locking Plate Aiming Device, right	1
226230	Targeting Proximal Tibia Locking Plate Aiming Device, left	1
226240	Targeting Proximal Tibia Locking Plate Aiming Device, right	1

Notice: The targeting set is additional to MonoLoc 5.0 instrument set.

# MonoLoc Locking Plates System

## Targeting Locking Plates System

### Targeting Locking Plates System Instrument

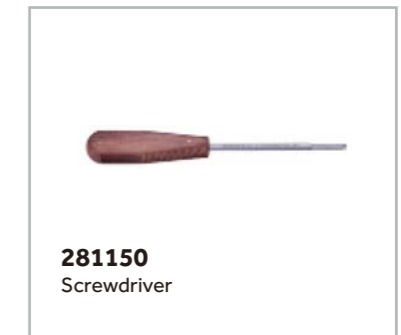



## MonoLoc Locking Plates System

### Medial High Tibia Plate



Thickness (mm)	3.2
Width (mm)	16.2
Material	PT

Code	Model No.	Size	Length (mm)
29401800	SDDG65	4H	115

### Lateral High Tibia Plate



Thickness (mm)	4.2
Width (mm)	16
Material	PT

Code	Model No.	Size	Direction	Length (mm)
29401900	SDDG67	3H	Left	102
29402000	SDDG66	3H	Right	102

### Lateral Distal Femur Plate



Thickness (mm)	6
Material	PT

Code	Model No.	Size	Direction	Length (mm)
29402100	SDDG69	4H	Left	141
29402200	SDDG68	4H	Right	141

## MonoLoc Locking Plates System

Code	Product Description	Qty.
898165	TopFix Osteotomy Instruments set	1
829010	TopFix Osteotomy Instruments set (Empty)-PPSU	1
898193	TopFix Implant tray	1
829100	TopFix Guiding Block for Medial High Tibia	1
226230	TopFix Guiding Block for Lateral High Tibia, left	1
226240	TopFix Guiding Block for Lateral High Tibia, right	1
829130	TopFix Guiding Block for Lateral Distal Femur, left	1
829140	TopFix Guiding Block for Lateral Distal Femur, right	1
829150	TopFix Osteotomy Gap Measuring Device	1
829160	Bone Spreader with 8mm blade, medium handle, soft ratchet	1
829170	TopFix Osteotomy Chisel, width 10mm	1
829180	TopFix Osteotomy Chisel, width 15mm	1
829190	TopFix Osteotomy Chisel, width 20mm	1
829200	TopFix Osteotomy Chisel, width 25mm	1

Notice: The topfox set is used in addition to MonoLoc 5.0 instrument set

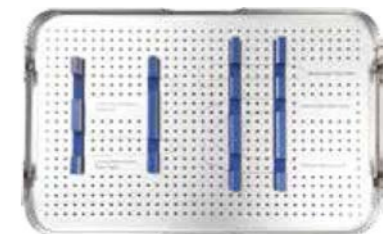
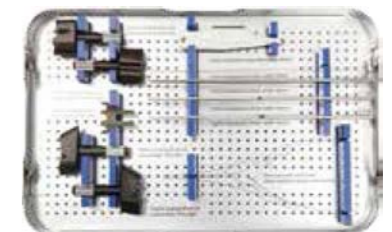
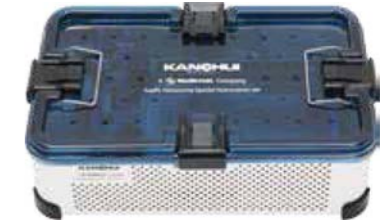

## MonoLoc Locking Plates System

### TopFix Osteotomy Instrument



# Synplate Conventional Plates System

- Synplate Modular Hand
- Synplate Small Fragment
- Synplate Large Fragment



## Synplate Conventional Plates System

### Synplate Modular Hand System

#### Cortex Screws, fully threaded



Specification	
Thickness (mm)	1.5
Material	TA

Code	Model No.	Size
30301106	RSQ01	6mm
30301107	RSQ01	7mm
30301108	RSQ01	8mm
30301109	RSQ01	9mm
30301110	RSQ01	10mm
30301112	RSQ01	12mm
30301114	RSQ01	14mm

#### Short T-Plate 1.5



Specification			
Thickness (mm)		0.85	
Width (mm)		4	
Material		PT	

Code	Model No.	Size	Length (mm)
20122004	YSQ04	4H	16

#### L-Plates 1.5



Specification				
Thickness (mm)				0.85
Width (mm)				4
Material				PT

Code	Model No.	Direction	Size	Length (mm)
20134204	YSQ07	Left	4H	16
20134104	YSQ08	Right	4H	16

#### Angled L-Plates 1.5



Specification				
Thickness (mm)				0.85
Width (mm)				4
Material				PT

Code	Model No.	Direction	Size	Length (mm)
20137204	YSQ09	Left	4H	16
20137104	YSQ10	Right	4H	16

#### Straight Plates 1.5



Specification			
Thickness (mm)			0.85
Width (mm)			4
Material			PT

Code	Model No.	Size	Length (mm)
20106003	ZSQ02	3H	16
20106004	ZSQ02	4H	21
20106005	ZSQ02	5H	26
20106006	ZSQ02	6H	31
20112020	ZSQ03	20H	99

#### Long T-Plates 1.5



Specification				
Thickness (mm)				0.85
Width (mm)				4
Material				PT

Code	Model No.	Size	Length (mm)
20124003	YSQ02	3H	49
20125004	YSQ01	4H	49

## Synplate Conventional Plates System

### Synplate Modular Hand System

#### H-Plate 1.5



Specification	
Thickness (mm)	0.85
Width (mm)	9
Material	PT

Code	Model No.	Size	Length (mm)
20120004	YSQ12	4H	8.2

#### Cortex Screws, fully threaded



Specification	
Thickness (mm)	2
Material	TA

Code	Model No.	Size
30302106	RSQ01	6mm
30302108	RSQ01	8mm
30302110	RSQ01	10mm
30302112	RSQ01	12mm
30302114	RSQ01	14mm
30302116	RSQ01	16mm
30302118	RSQ01	18mm
30302120	RSQ01	20mm

#### Straight Plates 2.0



Specification	
Thickness (mm)	1
Width (mm)	5
Material	PT

Code	Model No.	Size	Length (mm)
20101002	ZSQ02	2H	13
20101003	ZSQ02	3H	19
20101004	ZSQ02	4H	25
20101005	ZSQ02	5H	31
20101006	ZSQ02	6H	37

#### H-Plates 2.0



Specification	
Thickness (mm)	1
Width (mm)	11/5
Material	PT

Code	Model No.	Size	Length (mm)
20121004	YSQ12	4H	12
20121006	YSQ06	6H	23

#### L-Plates 2.0



Specification	
Thickness (mm)	1
Width (mm)	5
Material	PT

Code	Model No.	Direction	Size	Length (mm)
20135204	YSQ07	Left	4H	19
20135205	YSQ07	Left	5H	25
20135104	YSQ08	Right	4H	19
20135105	YSQ08	Right	5H	25

#### Angled L-Plates 2.0



Specification	
Thickness (mm)	1
Width (mm)	5
Material	PT

Code	Model No.	Size	Direction	Length (mm)
20138204	YSQ09	4H	Left	21
20138205	YSQ09	5H	Left	27
20138104	YSQ10	4H	Right	21
20138105	YSQ10	5H	Right	27

## Synplate Conventional Plates System

### Synplate Modular Hand System

#### Short T-Plate 2.0



Specification	
Thickness (mm)	1
Width (mm)	5
Material	PT

Code	Model No.	Size	Length (mm)
20123004	YSQ05	4H	19

#### Cortex screws ,fully threaded



Specification	
Thickness (mm)	2.7
Material	TA

Code	Model No.	Size
30304106	HSQ01	6mm
30304108	HSQ01	8mm
30304110	HSQ01	10mm
30304112	HSQ01	12mm
30304114	HSQ01	14mm
30304116	HSQ01	16mm
30304118	HSQ01	18mm
30304120	HSQ01	20mm
30304122	HSQ01	22mm
30304124	HSQ01	24mm

#### T-Plates 2.0



Specification	
Thickness (mm)	1
Width (mm)	5
Material	PT

Code	Model No.	Size	Length (mm)
20130005	YSQ03	5H	18
20130006	YSQ03	6H	23

#### Long T-Plate 2.0



Specification	
Thickness (mm)	1
Width (mm)	5
Material	PT

Code	Model No.	Size	Length (mm)
20126004	YSQ04	4H	23

#### Cortex screws ,partially threaded



Specification	
Thickness (mm)	2.7
Material	PT

Code	Model No.	Size
30304210	HSQ02	10mm
30304212	HSQ02	12mm
30304214	HSQ02	14mm
30304216	HSQ02	16mm
30304220	HSQ02	20mm
30304224	HSQ02	24mm

#### Straight Plates 2.7



Specification	
Thickness (mm)	2
Width (mm)	8
Material	PT

Code	Model No.	Size	Length (mm)
20102002	ZSQ02	2H	21
20102003	ZSQ02	3H	29
20102004	ZSQ02	4H	37
20102005	ZSQ02	5H	45
20102006	ZSQ02	6H	53



## Synplate Conventional Plates System

### Synplate Modular Hand System

#### Angled L-Plates 2.7



Thickness (mm)	1.2
Width (mm)	7
Material	PT

Code	Model No.	Direction	Size	Length (mm)
20139205	YSQ09	Left	5H	35.7
20139105	YSQ10	Right	5H	35.7

#### L-Plates 2.7



Thickness (mm)	1.2
Width (mm)	7
Material	PT

Code	Model No.	Direction	Size	Length (mm)
20136205	YSQ07	Left	5H	33.5
20136105	YSQ08	Right	5H	33.5

#### Mini T-Plate 2.7



Thickness (mm)	1
Width (mm)	5
Material	PT

Code	Model No.	Size	Length (mm)
20126005	YSQ05	5H	23

#### W-Plate 2.7



Thickness (mm)	1.2
Width (mm)	15
Material	PT

Code	Model No.	Size	Length (mm)
20142007	YSQ11	7H	44

## Synplate Conventional Plates System

### Synplate Modular Hand System

#### Synplate Modular Hand Instruments Set

Code	Product Description	Qty.
01900	Synplate Modular Hand Instruments Set	
898342	Synplate Modular Hand Instruments Set (Empty) -PPSU	1
01103	Handle with Quick Coupling	1
01104	Depth Gauge, 40mm	1
01214	Bending Iron	2
01215	Retractor, width 6mm	1
01216	Retractor, width 8mm	1
01217	Retractor, width 15mm	1
01218	Sharp Hook	1
01219	Periosteal Elevator, width 5mm	1
01220	Screw Forceps	1
01221	Bending Pliers for Finger Plates	1
01123	Reduction Forceps with Points	1
01124	Reduction Forceps with Points, toothed	1
01125	Plate Holder	1
01232	Periosteal Elevator, width 3mm	1
01222	Bending and Cutting Pliers	1
01026	1.5mm Modular Hand Implants Case (Empty)	1
00101	Drill Bit, 1.1mm	2
00102	Drill Bit, 1.5mm	1
01210	Screwdriver 1.5	1
01229	Universal Drill Guides 1.5	1
01205	Tap, 1.5mm	1
01027	2.0mm Modular Hand Instruments Set (Empty)	1
00102	Drill Bit, 1.5mm	2
00103	Drill Bit, 2.0mm	1
01212	Easyout, small	1
01230	Universal Drill Guide 2.0	1
01206	Tap, 2.0mm	1
01211	Screwdriver 2.0	1
01028	2.7mm Modular Hand Instruments Set (Empty)	1
00103	Drill Bit, 2.0mm	2
00105	Drill Bit, 2.7mm	1
01208	Mini Countersink	1
01209	Screwdriver 2.7	1
01207	Tap, 2.7mm	1
01213	Easyout, medium	1
01231	Universal Drill Guide 2.7	1

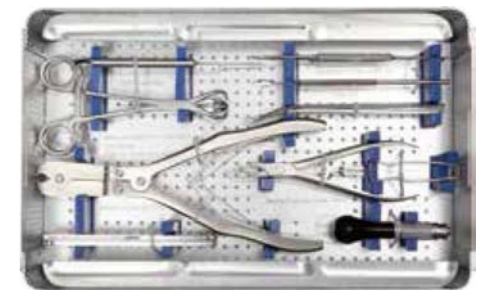



## Synplate Conventional Plates System

### Synplate Modular Hand System

#### Synplate Modular Hand Instrument

 <p><b>01103</b> Handle with Quick Coupling</p>	 <p><b>01104</b> Depth Gauge, 40mm</p>	 <p><b>01214</b> Bending Iron</p>
 <p><b>01215</b> Retractor, width 6mm</p>	 <p><b>01216</b> Retractor, width 8mm</p>	 <p><b>01217</b> Retractor, width 15mm</p>
 <p><b>01218</b> Sharp Hook</p>	 <p><b>01219</b> Periosteal Elevator, width 5mm</p>	 <p><b>01220</b> Screw Forceps</p>
 <p><b>01221</b> Bending Pliers for Finger Plates</p>	 <p><b>01123</b> Reduction Forceps with Points</p>	 <p><b>01124</b> Reduction Forceps with Points, toothed</p>

## Synplate Conventional Plates System

### Synplate Modular Hand System









#### Synplate Modular Hand Instrument

 <p><b>01125</b> Plate Holder</p>	 <p><b>01232</b> Periosteal Elevator, width 3mm</p>	 <p><b>01222</b> Bending and Cutting Pliers</p>
 <p><b>00101</b> Drill Bit, φ1.1mm</p>	 <p><b>00102</b> Drill Bit, φ1.5mm</p>	 <p><b>01210</b> Screwdriver 1.5</p>
 <p><b>01229</b> Universal Drill Guides 1.5</p>	 <p><b>01205</b> Tap, φ1.5mm</p>	 <p><b>00102</b> Drill Bit, φ1.5mm</p>
 <p><b>00103</b> Drill Bit, φ2.0mm</p>	 <p><b>01212</b> Easyout, small</p>	 <p><b>01230</b> Universal Drill Guide 2.0</p>

## Synplate Conventional Plates System

### Synplate Modular Hand System

#### Synplate Modular Hand Instrument

 <p><b>01206</b> Tap, φ2.0mm</p>	 <p><b>01211</b> Screwdriver 2.0</p>	 <p><b>00103</b> Drill Bit, φ2.0mm</p>
 <p><b>00105</b> Drill Bit, φ2.7mm</p>	 <p><b>01208</b> Mini Countersink</p>	 <p><b>01209</b> Screwdriver 2.7</p>
 <p><b>01207</b> Tap, φ2.7mm</p>	 <p><b>01213</b> Easyout, medium</p>	 <p><b>01231</b> Universal Drill Guide 2.7</p>

## Synplate Conventional Plates System

### Synplate Small Fragment System

#### Clavicular Plate 3.5, standard



Thickness (mm)	2.8
Width (mm)	16
Material	PT

Code	Model No.	Direction	Length (mm)
20158201	TBYQ15	Left	51
20157101	TBYQ14	Right	51

#### Clavicular Plate II 3.5



Thickness (mm)	3.2
Width (mm)	10
Material	PT

Code	Model No.	Size	Direction	Length (mm)
20234202	TBYQ23	2H	Left	65.3
20234203	TBYQ23	3H	Left	74.3
20234205	TBYQ23	5H	Left	93.4
20234207	TBYQ23	7H	Left	113
20234102	TBYQ22	2H	Right	65.3
20234103	TBYQ22	3H	Right	74.3
20234105	TBYQ22	5H	Right	93.4
20234107	TBYQ22	7H	Right	113

#### Clavicular Plate 3.5



Thickness (mm)	2.8
Width (mm)	10
Material	PT

Code	Model No.	Size	Direction	Length (mm)
20158202	TBYQ17	2H	Left	71
20158204	TBYQ17	4H	Left	95
20158206	TBYQ17	6H	Left	119
20157102	TBYQ16	2H	Right	71
20157104	TBYQ16	4H	Right	95
20157106	TBYQ16	6H	Right	119

#### Olecranon Plate 3.5



Thickness (mm)	2
Width (mm)	11
Material	PT

Code	Model No.	Size	Length (mm)
20217003	TBYQ03	3H	74.5
20217004	TBYQ03	4H	86.5
20217005	TBYQ03	5H	98.5
20217006	TBYQ03	6H	110.5
20217007	TBYQ03	7H	122.5
20217008	TBYQ03	8H	134.5

## Synplate Conventional Plates System

### Synplate Small Fragment System

#### Cloverleaf Plate 3.5



Specification	
Thickness (mm)	2
Width (mm)	15
Material	PT

Code	Model No.	Size	Length (mm)
20143003	YSQ19	3H	88
20143004	YSQ19	4H	104
20143005	YSQ19	5H	120
20143006	YSQ19	6H	136
20143008	YSQ19	8H	168

#### Y-Plate 3.5



Specification	
Thickness (mm)	2
Width (mm)	10
Material	PT

Code	Model No.	Size	Length (mm)
20212003	TBYQ06	3H	100
20212004	TBYQ06	4H	110.5
20212005	TBYQ06	5H	124
20212006	TBYQ06	6H	134.5
20212007	TBYQ06	7H	148

#### T-Plate 3.5, right angled



Specification	
Thickness (mm)	2
Width (mm)	9
Material	PT

Code	Model No.	Size	Length (mm)
20127003	YSQ01	3H	49
20127004	YSQ01	4H	61
20127005	YSQ01	5H	73

#### Lateral Column Plate 3.5



Specification	
Thickness (mm)	2
Width (mm)	11
Material	PT

Code	Model No.	Size	Direction	Length (mm)
20214203	TBYQ05	3H	Left	44
20214205	TBYQ05	5H	Left	76
20214103	TBYQ04	3H	Right	44
20214105	TBYQ04	5H	Right	76

#### T-Plate 3.5, oblique angled



Specification	
Thickness (mm)	2
Width (mm)	9
Material	PT

Code	Model No.	Size	Length (mm)
20129003	YSQ04	3H	52
20129004	YSQ04	4H	64
20129005	YSQ04	5H	76

#### Medial Column Plate 3.5



Specification	
Thickness (mm)	2
Width (mm)	11
Material	PT

Code	Model No.	Size	Length (mm)
20216003	TBYQ01	3H	79
20216004	TBYQ01	4H	95
20216005	TBYQ01	5H	111

## Synplate Conventional Plates System

### Synplate Small Fragment System

#### Distal Dorsal Radius Delta Plate



Specification	
Thickness (mm)	2
Width (mm)	10
Material	PT

Code	Model No.	Size	Direction	Length (mm)
20229203	TJYQ06	3H	Left	68
20229205	TJYQ06	5H	Left	90
20229207	TJYQ06	7H	Left	112
20229103	TJYQ07	3H	Right	68
20229105	TJYQ07	5H	Right	90
20229107	TJYQ07	7H	Right	112

#### Distal Dorsal Radius T-Plate



Specification	
Thickness (mm)	2
Width (mm)	10
Material	PT

Code	Model No.	Size	Direction	Length (mm)
20230203	TJYQ09	3H	Left	46
20230205	TJYQ09	5H	Left	68
20230207	TJYQ09	7H	Left	90
20230103	TJYQ08	3H	Right	46
20230105	TJYQ08	5H	Right	68
20230107	TJYQ08	7H	Right	90

#### Proximal Humeral Plate 3.5



Specification	
Thickness (mm)	3.5
Width (mm)	12
Material	PT

Code	Model No.	Size	Direction	Length (mm)
20218203	TBYQ08	3H	Left	80
20218205	TBYQ08	5H	Left	104
20218207	TBYQ08	7H	Left	128
20218209	TBYQ08	9H	Left	152
20218211	TBYQ08	11H	Left	176
20218213	TBYQ08	13H	Left	200
20218103	TBYQ07	3H	Right	80
20218105	TBYQ07	5H	Right	104
20218107	TBYQ07	7H	Right	128
20218109	TBYQ07	9H	Right	152
20218111	TBYQ07	11H	Right	176
20218113	TBYQ07	13H	Right	200

#### Reconstruction Plate 3.5



Specification	
Thickness (mm)	3
Width (mm)	10
Material	PT

Code	Model No.	Size	Length (mm)
20116004	ZSQ12	4H	48
20116005	ZSQ12	5H	60
20116006	ZSQ12	6H	72
20116007	ZSQ12	7H	84
20116008	ZSQ12	8H	96
20116009	ZSQ12	9H	108
20116010	ZSQ12	10H	120
20116011	ZSQ12	11H	132
20116012	ZSQ12	12H	144
20116014	ZSQ12	14H	168
20116016	ZSQ12	16H	192
20116018	ZSQ12	18H	216

## Synplate Conventional Plates System

### Synplate Small Fragment System

#### Limited Contact Dynamic Compression Plate 3.5



Specification	
Thickness (mm)	3
Width (mm)	11
Material	PT

Code	Model No.	Size	Length (mm)
20109004	ZSQ06	4H	51
20109005	ZSQ06	5H	64
20109006	ZSQ06	6H	77
20109007	ZSQ06	7H	90
20109008	ZSQ06	8H	103
20109009	ZSQ06	9H	116
20109010	ZSQ06	10H	129

#### One-Third Tubular Plate 3.5



Specification	
Thickness (mm)	1
Width (mm)	9.2
Material	PT

Code	Model No.	Size	Length (mm)
20108004	ZSQ02	4H	50
20108005	ZSQ02	5H	62
20108006	ZSQ02	6H	74
20108007	ZSQ02	7H	86
20108008	ZSQ02	8H	98
20108009	ZSQ02	9H	110
20108010	ZSQ02	10H	122
20108011	ZSQ02	11H	134
20108012	ZSQ02	12H	146

#### S-reconstruction Plate 3.5



Specification	
Thickness (mm)	2.5
Width (mm)	10
Material	PT

Code	Model No.	Size	Direction	Length (mm)
20232206	TBYQ19	6H	Left	61.8
20232207	TBYQ19	7H	Left	77.1
20232208	TBYQ19	8H	Left	91.3
20232209	TBYQ19	9H	Left	92
20232210	TBYQ19	10H	Left	103.9
20232212	TBYQ19	12H	Left	127.7
20232106	TBYQ18	6H	Right	61.8
20232107	TBYQ18	7H	Right	77.1
20232108	TBYQ18	8H	Right	91.3
20232109	TBYQ18	9H	Right	92
20232110	TBYQ18	10H	Right	103.9
20232112	TBYQ18	12H	Right	127.7

#### Curved Pelvic Plate 3.5



Specification	
Thickness (mm)	3
Width (mm)	10
Material	PT

Code	Model No.	Size	Length (mm)
20144108	YSQ20	8H	93
20144110	YSQ20	10H	114.3
20144112	YSQ20	12H	134.2
20144114	YSQ20	14H	152.6
20144116	YSQ20	16H	169.1

## Synplate Conventional Plates System

### Synplate Small Fragment System

#### Calcaneal Plate, long



Specification	
Thickness (mm)	1.5
Material	PT

Code	Model No.	Size	Width(mm)	Length (mm)
20205013	TGQ01	13H	38.6	78.8
20205015	TGQ01	15H	42.7	88.4

#### Calcaneal Plate, short



Specification	
Thickness (mm)	1.5
Material	PT

Code	Model No.	Size	Width (mm)	Length (mm)
20206011	TGQ01	11H	38.6	58.8
20206013	TGQ01	13H	42.7	68.4

#### Pelvic posterior column plate



Specification	
Thickness (mm)	3.1
Width (mm)	10
Material	PT

Code	Model No.	Size	Length (mm)
24236000	YSQ37	10H	103
24237000	YSQ37	10H	102
24238000	YSQ37	10H	104

#### Distal Lateral Fibular Plate 3.5



Specification	
Thickness (mm)	1.8
Width (mm)	10.5
Material	PT

Code	Model No.	Size	Length (mm)
20235005	TBYQ11	5H	73
20235006	TBYQ11	6H	86
20235007	TBYQ11	7H	99
20235008	TBYQ11	8H	112
20235009	TBYQ11	9H	125
20235010	TBYQ11	10H	138
20235011	TBYQ11	11H	151
20235012	TBYQ11	12H	164
20235013	TBYQ11	13H	177
20235014	TBYQ11	14H	190

## Synplate Conventional Plates System

### Synplate Small Fragment System

#### Synplate Small Fragment Instruments Set

Code	Product Description	Qty.
201900	Synplate Small Fragment Instruments Set	
898179	Screw Case-PPSU	1
201010	Synplate Small Fragment Instruments Set (Empty) -PPSU	1
010030	Drill Bit, 3.5mm	2
010010	Drill Bit, 2.5mm	2
201100	Drill Sleeve 2.0	1
201110	Drill Sleeve 2.5	1
201120	Double Drill Guide 3.5/2.5	1
201130	Double Drill Sleeve 2.5	1
201140	Hex Screwdriver	1
020010	Tap, 3.5mm	1
030100	T-handle with Quick Couping	1
020020	Tap, 4.0mm	1
201150	Trephine	1
201170	Bone Holding Forceps, self-centering	2
201180	Reduction Forceps, serrated jaws, small	1
201190	Reduction Forceps with Points, small	1
201200	Depth Gauge, 80mm	1
201210	Easyout	1
201220	Countersink	1
201230	Periosteal Elevator, Round	1
201240	Periosteal Elevator, Straight	1
201250	Screw Holding Sleeve for Hex Screw	1
201160	Bending Irons	2
02037	Templates	1

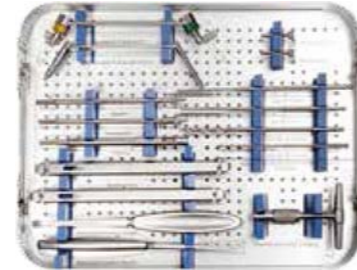
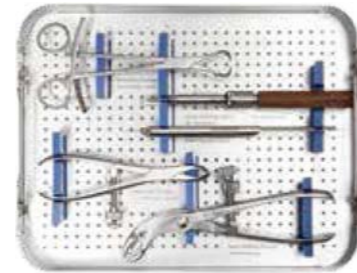

#### optional instrument

Code	Product Description	Qty.
206270	Bending Irons	2
898139	Hex Screwdriver (silicon handle)	1

## Synplate Conventional Plates System

### Synplate Small Fragment System

#### Synplate Small Fragment Instrument





## Synplate Conventional Plates System

### Synplate Small Fragment System

#### Synplate Small Fragment Instrument



**201180**  
Reduction Forceps,  
serrated jaws, small



**201190**  
Reduction Forceps with Points,  
small



**201200**  
Depth Gauge, 80mm



**201210**  
Easyout



**201220**  
Countersink



**201230**  
Periosteal Elevator, Round



**201240**  
Periosteal Elevator, Straight



**201250**  
Screw Holding Sleeve for  
Hex Screw

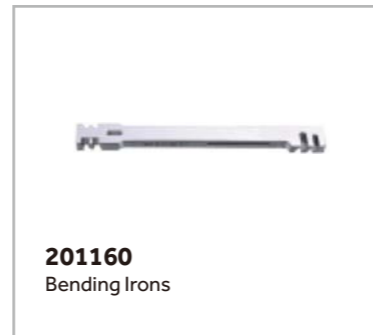

**201160**  
Bending Irons



**02037**  
Templates

## Synplate Conventional Plates System

### Synplate Large Fragment System

#### L-Buttress Plates 4.5



Thickness (mm)	2
Width (mm)	16
Material	PT

Code	Model No.	Size	Direction	Length (mm)
20222204	TJYQ05	4H	Left	83.2
20222206	TJYQ05	6H	Left	115.2
20222208	TJYQ05	8H	Left	147.2
20222104	TJYQ04	4H	Right	83.2
20222106	TJYQ04	6H	Right	115.2
20222108	TJYQ04	8H	Right	147.2

#### Proximal Lateral Femoral Plates 4.5



Thickness (mm)	5
Width (mm)	16
Material	PT

Code	Model No.	Size	Direction	Length (mm)
20220207	TGYQ09	7H	Left	124
20220209	TGYQ09	9H	Left	160
20220211	TGYQ09	11H	Left	196
20220213	TGYQ09	13H	Left	232
20220107	TGYQ09	7H	Right	124
20220109	TGYQ09	9H	Right	160
20220111	TGYQ09	11H	Right	196
20220113	TGYQ09	13H	Right	232

#### Distal Lateral Femoral Plates 4.5



Thickness (mm)	5
Width (mm)	16
Material	PT

Code	Model No.	Size	Direction	Length (mm)
20219207	TGYQ05	7H	Left	160
20219209	TGYQ05	9H	Left	192
20219211	TGYQ05	11H	Left	224
20219213	TGYQ05	13H	Left	256
20219107	TGYQ06	7H	Right	160
20219109	TGYQ06	9H	Right	192
20219111	TGYQ06	11H	Right	224
20219113	TGYQ06	13H	Right	256

#### Distal Lateral Tibial Plates 4.5 II



Thickness (mm)	3
Width (mm)	16
Material	PT

Code	Model No.	Size	Direction	Length (mm)
20233202	TJYQ17	5+2H	Left	101
20233204	TJYQ17	5+4H	Left	140
20233206	TJYQ17	5+6H	Left	176
20233208	TJYQ17	5+8H	Left	212
20233102	TJYQ16	5+2H	Right	101
20233104	TJYQ16	5+4H	Right	140
20233106	TJYQ16	5+6H	Right	176
20233108	TJYQ16	5+8H	Right	212

## Synplate Conventional Plates System

### Synplate Large Fragment System

#### Distal Medial Tibial Plates 4.5



Specification	
Thickness (mm)	3
Width (mm)	16
Material	PT

Code	Model No.	Size	Direction	Length (mm)
20207205	TJYQ17	5H	Left	86
20207207	TJYQ17	7H	Left	122
20207209	TJYQ17	9H	Left	158
20207211	TJYQ17	11H	Left	194
20207213	TJYQ17	13H	Left	230
20207105	TJYQ16	5H	Right	86
20207107	TJYQ16	7H	Right	122
20207109	TJYQ16	9H	Right	158
20207111	TJYQ16	11H	Right	194
20207113	TJYQ16	13H	Right	230

#### Lateral Tibial Head Buttress Plates 4.5



Specification	
Thickness (mm)	4
Width (mm)	14
Material	PT

Code	Model No.	Size	Direction	Length (mm)
20203205	TJYQ02	5H	Left	120
20203207	TJYQ02	7H	Left	152
20203209	TJYQ02	9H	Left	184
20203211	TJYQ02	11H	Left	216
20203213	TJYQ02	13H	Left	248
20203105	TJYQ01	5H	Right	120
20203107	TJYQ01	7H	Right	152
20203109	TJYQ01	9H	Right	184
20203111	TJYQ01	11H	Right	216
20203113	TJYQ01	13H	Right	248

#### Distal Medial Tibial Plates 4.5 II



Specification	
Thickness (mm)	3
Width (mm)	13
Material	PT

Code	Model No.	Size	Direction	Length (mm)
20228205	TJYQ12	5H	Left	110
20228207	TJYQ12	7H	Left	134
20228209	TJYQ12	9H	Left	158
20228105	TJYQ13	5H	Right	110
20228107	TJYQ13	7H	Right	134
20228109	TJYQ13	9H	Right	158

#### T-Buttress Plates 4.5, single-curved



Specification	
Thickness (mm)	2
Width (mm)	16.2
Material	PT

Code	Model No.	Size	Length (mm)
20131004	YSQ06	4H	84
20131005	YSQ06	5H	100
20131006	YSQ06	6H	116
20131008	YSQ06	8H	148
20131010	YSQ06	10H	180
20131012	YSQ06	12H	212

## Synplate Conventional Plates System

### Synplate Large Fragment System

#### T-Buttress Plates 4.5, double-curved



Specification	
Thickness (mm)	2
Width (mm)	16.2
Material	PT

Code	Model No.	Size	Length (mm)
20132004	YSQ06	4H	86
20132005	YSQ06	5H	102
20132006	YSQ06	6H	118
20132008	YSQ06	8H	150

#### Condylar Buttress Plates 4.5, curved



Specification	
Thickness (mm)	4.5
Width (mm)	16.2
Material	PT

Code	Model No.	Size	Direction	Length (mm)
20208207	TGYQ03	7H	Left	151
20208209	TGYQ03	9H	Left	183
20208211	TGYQ03	11H	Left	215
20208213	TGYQ03	13H	Left	247
20208107	TGYQ04	7H	Right	151
20208109	TGYQ04	9H	Right	183
20208111	TGYQ04	11H	Right	215
20208113	TGYQ04	13H	Right	247

#### Condylar Buttress Plates 4.5



Specification	
Thickness (mm)	4.5
Width (mm)	16.2
Material	PT

Code	Model No.	Size	Direction	Length (mm)
20202207	TGYQ02	7H	Left	151
20202209	TGYQ02	9H	Left	183
20202211	TGYQ02	11H	Left	215
20202213	TGYQ02	13H	Left	247
20202107	TGYQ01	7H	Right	151
20202109	TGYQ01	9H	Right	183
20202111	TGYQ01	11H	Right	215
20202113	TGYQ01	13H	Right	247

#### Limited Contact Dynamic Compression Plates 4.5, narrow



Specification	
Thickness (mm)	4
Width (mm)	13.5
Material	PT

Code	Model No.	Size	Length (mm)
20110004	ZSQ06	4H	69
20110005	ZSQ06	5H	87
20110006	ZSQ06	6H	105
20110007	ZSQ06	7H	123
20110008	ZSQ06	8H	141
20110009	ZSQ06	9H	159
20110010	ZSQ06	10H	177
20110012	ZSQ06	12H	213
20110014	ZSQ06	14H	249
20110016	ZSQ06	16H	285

## Synplate Conventional Plates System

### Synplate Large Fragment System

Limited Contact Dynamic Compression Plates 4.5, broad



Thickness (mm)	5
Width (mm)	17.5
Material	PT

Code	Model No.	Size	Length (mm)
20111005	ZSQ06	5H	88
20111006	ZSQ06	6H	106
20111007	ZSQ06	7H	124
20111008	ZSQ06	8H	142
20111009	ZSQ06	9H	160
20111010	ZSQ06	10H	178
20111012	ZSQ06	12H	214
20111014	ZSQ06	14H	250
20111016	ZSQ06	16H	286

Dynamic Compression Plates 4.5, broad



Thickness (mm)	5
Width (mm)	17
Material	PT

Code	Model No.	Size	Length (mm)
20105005	ZSQ08	5H	94
20105006	ZSQ08	6H	110
20105007	ZSQ08	7H	126
20105008	ZSQ08	8H	142
20105009	ZSQ08	9H	158
20105010	ZSQ08	10H	174
20105012	ZSQ08	12H	206
20105014	ZSQ08	14H	238

Dynamic Compression Plates 4.5, narrow



Thickness (mm)	4
Width (mm)	13
Material	PT

Code	Model No.	Size	Length (mm)
20104004	ZSQ07	4H	78
20104005	ZSQ07	5H	94
20104006	ZSQ07	6H	110
20104007	ZSQ07	7H	126
20104008	ZSQ07	8H	142
20104009	ZSQ07	9H	158
20104010	ZSQ07	10H	174
20104012	ZSQ07	12H	206

## Synplate Conventional Plates System

### Synplate Large Fragment System

Synplate Large Fragment Instruments Set

Code	Product Description	Qty.
206900	Synplate Large Fragment System Instruments Set	
898183	Screw Case-PPSU	1
206010	Synplate Large Fragment System Instruments Set (Empty)-PPSU	1
206100	Double Drill Sleeve 3.2	1
206110	Double Drill Guide 6.5/3.2	1
206120	Double Drill Guide 4.5/3.2	1
206140	Easyout	1
010040	Drill Bit, $\Phi$ 4.5mm	2
010020	Drill Bit, $\Phi$ 3.2mm	2
206150	Reduction Forceps, serrated jaws, large	1
206160	Reduction Forceps with Points, large	1
206170	Depth Gauge, 90mm	1
206180	Periosteal Elevator, Round	1
206190	Periosteal Elevator, Straight	1
206200	Countersink	1
030100	T-handle with Quick Couping	1
206210	Drill Sleeve 3.2	1
206220	Drill Guide, pointed	1
206230	Drill Sleeve 4.5	1
206240	Trephine	1
020040	Tap, $\Phi$ 6.5mm	1
020030	Tap, $\Phi$ 4.5mm	1
206280	Hex Screwdriver	1
206290	Bone Holding Forceps, self-centering	2
206300	Screw Holding Sleeve for Hex Screw	1
206320	Bending Irons, left	1
206340	Bending Irons, right	1
03035	Templates	1

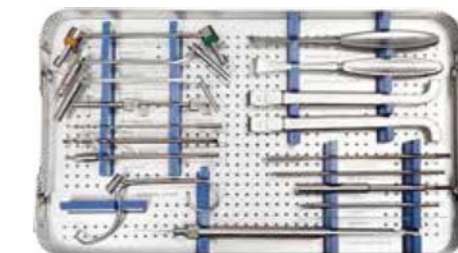
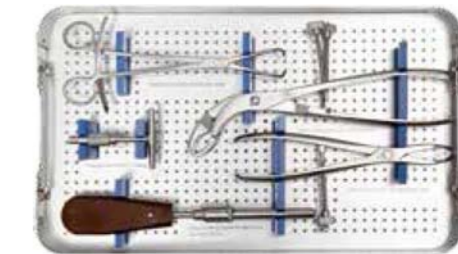

optional instrument

Code	Product Description	Qty.
898144	Hex Screwdriver (silicon handle)	1
206330	Plates Bender	1

## Synplate Conventional Plates System

### Synplate Large Fragment System

#### Synplate Large Fragment Instrument

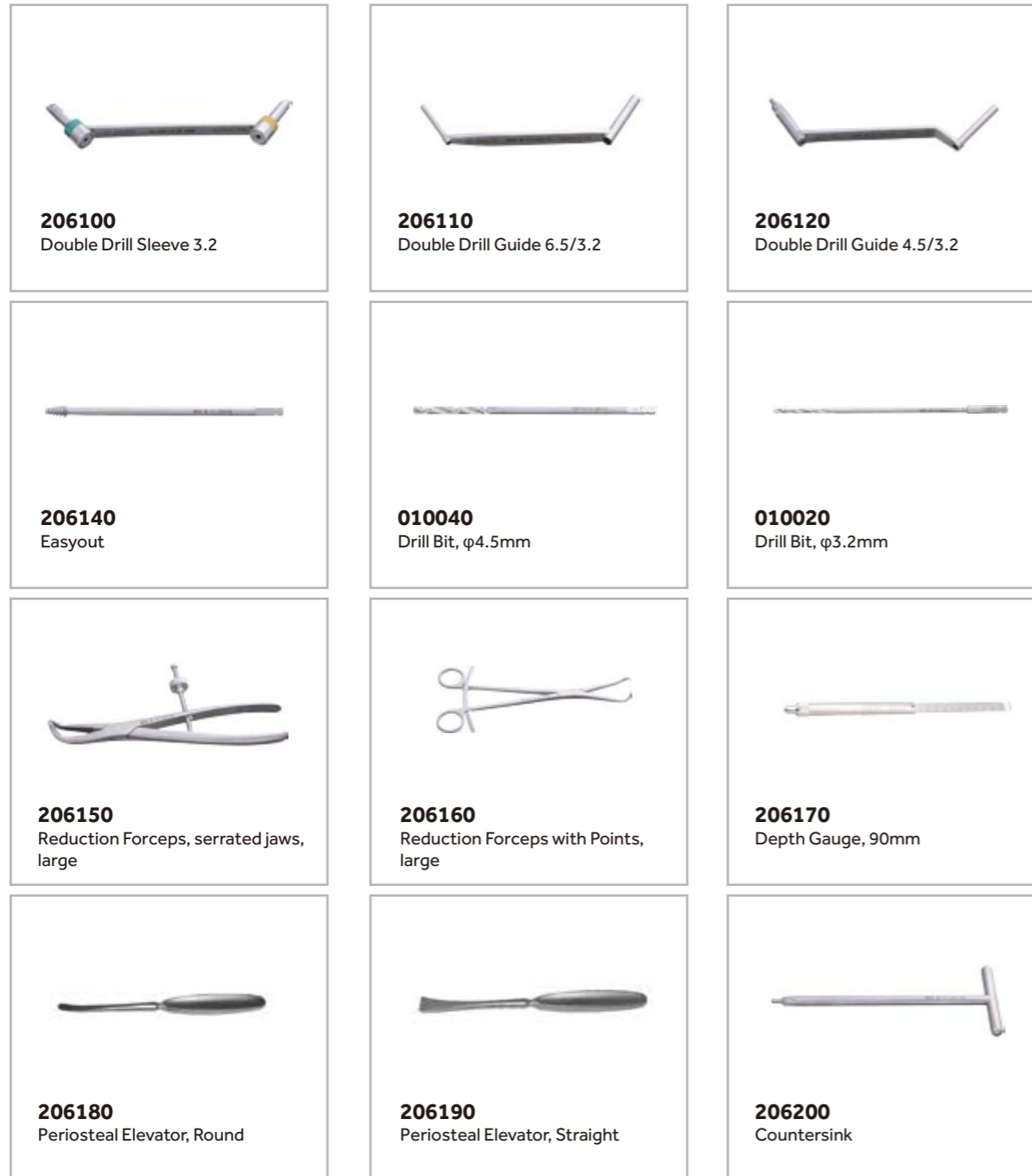

## Synplate Conventional Plates System

### Synplate Large Fragment System

#### Synplate Large Fragment Instrument

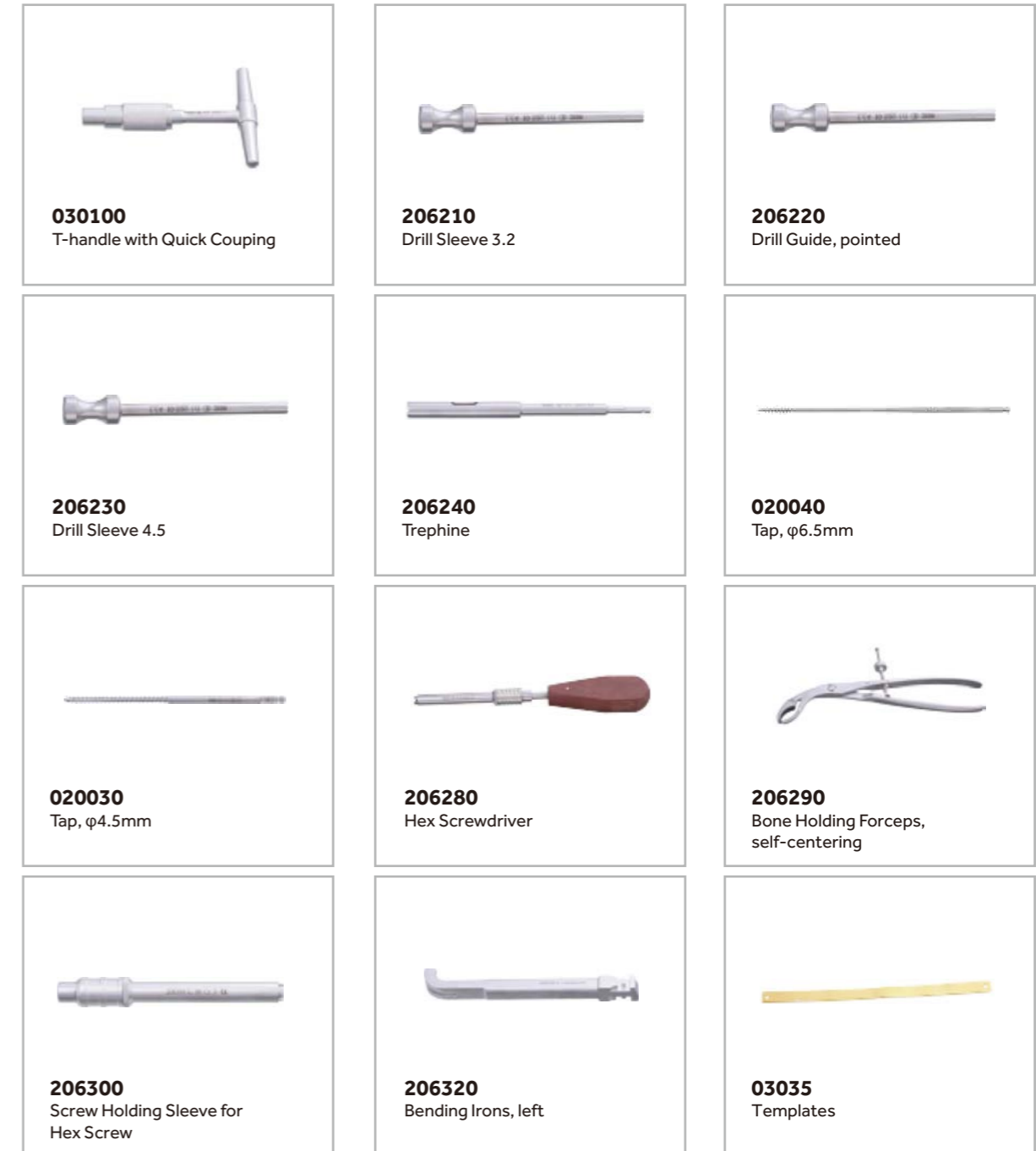

# DH/DC System

- DH/DC
- Locking DH/DC





## DH/DC System

### DH/DC System

#### DH Plates, 135°



Specification	
Thickness (mm)	6.3
Width (mm)	18.7
Material	PT

Code	Model No.	Size	Length (mm)
30170003	DHS IV	3H	65.3
30170004	DHS IV	4H	81.3
30170005	DHS IV	5H	97.3
30170006	DHS IV	6H	113.3
30170008	DHS IV	8H	145.3
30170010	DHS IV	10H	177.3
30170012	DHS IV	12H	209.3
30170014	DHS IV	14H	241.3

#### DC Plates, 95°



Specification	
Thickness (mm)	6
Width (mm)	16
Material	PT

Code	Model No.	Size	Length (mm)
30810004	DCS II	4H	73.5
30810005	DCS II	5H	89.5
30810006	DCS II	6H	105.5
30810008	DCS II	8H	137.5
30810010	DCS II	10H	169.5
30810011	DCS II	11H	185.5
30810012	DCS II	12H	201.5
30810014	DCS II	14H	233.5

#### Locking DH Plates, 135°



Specification	
Thickness (mm)	6.3
Width (mm)	18.7
Material	PT

Code	Model No.	Size	Length (mm)
39538003	SDDG26	3H	65.3
39538004	SDDG26	4H	81.3
39538006	SDDG26	6H	113.3
39538008	SDDG26	8H	145.3
39538010	SDDG26	10H	177.3
39538012	SDDG26	12H	209.3
39538014	SDDG26	14H	241.3

#### Locking DC Plates, 95°



Specification	
Thickness (mm)	6
Width (mm)	16
Material	PT

Code	Model No.	Size	Length (mm)
39537904	SDDG28	4H	73.5
39537905	SDDG28	5H	89.5
39537906	SDDG28	6H	105.5
39537908	SDDG28	8H	137.5
39537910	SDDG28	10H	169.5
39537912	SDDG28	12H	201.5
39537914	SDDG28	14H	233.5

## DH/DC System

### DH/DC System

#### DH/DC Lag Screws



Thickness (mm)	12
Material	TA

Code	Model No.	Size
33010050	DHS/DCS	50mm
33010055	DHS/DCS	55mm
33010060	DHS/DCS	60mm
33010065	DHS/DCS	65mm
33010070	DHS/DCS	70mm
33010075	DHS/DCS	75mm
33010080	DHS/DCS	80mm
33010085	DHS/DCS	85mm
33010090	DHS/DCS	90mm
33010092	DHS/DCS	95mm
33010094	DHS/DCS	100mm
33010096	DHS/DCS	105mm
33010098	DHS/DCS	110mm
33010100	DHS/DCS	115mm
33010102	DHS/DCS	120mm

#### DH/DC Compression Screw



Thickness (mm)	4
Material	TA

Code	Model No.	Size
33011036	DHS/DCS	36mm

## DH/DC System

### DH/DC System

#### DH/DC System Instruments Set

Code	Product Description	Qty.
899310	DH/DC System Instruments Set	
898355	DH/DC System Instruments Set (Empty)-PPSU	1
010020	Drill Bit, 3.2mm	2
010040	Drill Bit, 4.5mm	2
020030	Tap, 4.5mm	1
020040	Tap, 6.5mm	1
030100	T-Handle with Quick Coupling	1
030020	T-Handle with Quick Coupling (Large)	1
206170	Depth Gauge, 90mm	1
211120	Depth Gauge, 200mm	1
206280	Hex Screwdriver	1
206300	Screw Holding Sleeve for Hex Screw	1
211100	DC Angled Guide, 95°	1
211110	DH Angled Guide, 135°	1
211130	DC Triple Reamer	1
211140	DH Triple Reamer	1
211310	Centering Sleeve DH/DC System, short	1
206140	Easyout	1
211160	Tap for DH/DC Screws, length 220mm	1
211260	Double Drill Sleeve 3.2	1
211180	Coupling Shaft	1
211170	DH/DC Wrench, for Removal of DH/DC Screws	1
211340	DH/DC Impactor	1
211190	DH/DC Impactor	1
10727230	Threaded pin, 2.5×230mm	3
10737230	Kirschner Wire, 2.0mm	2
211150	DH/DC Centering Sleeve, removable	1
211330	Centering Sleeve DH/DC, long	1
206240	Trepine	1
211350	DH/DC Wrench, for DH/DC Screws in Titanium Alloy	1
20657	Drill Bit, 2.0mm, with Quick Coupling	2
206110	Double Drill Guide 6.5/3.2	1
206120	Double Drill Guide 4.5/3.2	1
211211	Cannulated Connecting Screw	1

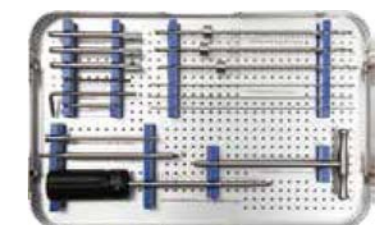
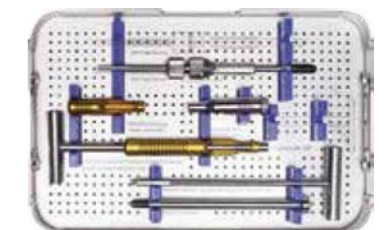
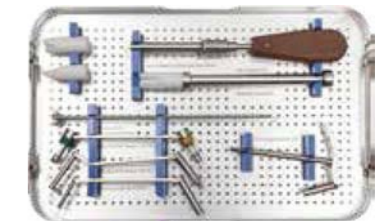
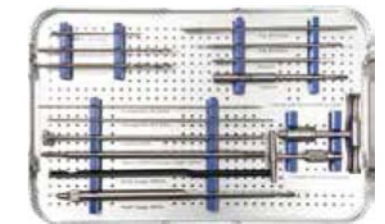

## DH/DC System

### DH/DC System

#### Optional Instrument

Code	Product Description	Qty.
226100	Drill Guide 4.1	3
226110	Drill Bit with Stop, 4.1mm	3
226120	Guide Sleeve for K-Wire, 2.0mm	1
226140	Screw Holding Sleeve for StarDrive Screw	1
226151	Torque-limiting Screwdriver, T25	1
226160	Screwdriver, self-retaining	1
226170	Extraction Screw, 5.0mm	1
221180	Allen Key	1
226190	Drill Bit for Screw Head Removal	1
226200	Torx Screwdriver, with Quick Coupling	1
10737230	Kirschner Wire, 2.0mm	3
898144	Hex Screwdriver (silicon handle)	1

Note:

The DH/DC instrument set is to work with MonoLoc 5.0 Instrument Set if optional instruments for locking screws are not ordered.

#### Implant Case













Code	Product Description
898370	DH/DC implant case

The implant case is only for DH/DC plates and lag screws. Screw case from MonoLoc 5.0 instrument set is to be used for locking screws and cortex screws.

## DH/DC System

### DH/DC System













#### DH/DC System Instrument

 <p><b>010020</b> Drill Bit, φ3.2mm</p>	 <p><b>010040</b> Drill Bit, φ4.5mm</p>	 <p><b>020030</b> Tap, φ4.5mm</p>
 <p><b>020040</b> Tap, φ6.5mm</p>	 <p><b>030100</b> T-Handle with Quick Coupling</p>	 <p><b>030020</b> T-Handle with Quick Coupling (Large)</p>
 <p><b>206170</b> Depth Gauge, 90mm</p>	 <p><b>211120</b> Depth Gauge, 200mm</p>	 <p><b>206280</b> Hex Screwdriver</p>
 <p><b>206300</b> Screw Holding Sleeve for Hex Screw</p>	 <p><b>211100</b> DC Angled Guide, 95°</p>	 <p><b>211110</b> DH Angled Guide, 135°</p>

## DH/DC System

### DH/DC System













#### DH/DC System Instrument

 <b>211130</b> DC Triple Reamer	 <b>211140</b> DH Triple Reamer	 <b>211310</b> Centering Sleeve DH/DC System, short
 <b>206140</b> Easyout	 <b>211160</b> Tap for DH/DC Screws, length 220mm	 <b>211260</b> Double Drill Sleeve 3.2
 <b>211180</b> Coupling Shaft	 <b>211170</b> DH/DC Wrench, for Removal of DH/DC Screws	 <b>211340</b> DH/DC Impactor
 <b>211190</b> DH/DC Impactor	 <b>10727230</b> Threaded pin, 2.5x230mm	 <b>10737230</b> Kirschner Wire, φ2.0mm

## DH/DC System

### DH/DC System

#### DH/DC System Instrument

 <b>211150</b> DH/DC Centering Sleeve, removable	 <b>211330</b> Centering Sleeve DH/DC, long	 <b>206240</b> Trepine
 <b>211350</b> DH/DC Wrench, for DH/DC Screws in Titanium Alloy	 <b>20657</b> Drill Bit, φ2.0mm, with Quick Coupling	 <b>206110</b> Double Drill Guide 6.5/3.2
 <b>206120</b> Double Drill Guide 4.5/3.2	 <b>211211</b> Cannulated Connecting Screw	 <b>226100</b> Drill Guide 4.1
 <b>226110</b> Drill Bit with Stop, φ4.1mm	 <b>226120</b> Guide Sleeve for K-Wire, φ2.0mm	 <b>226140</b> Screw Holding Sleeve for StarDrive Screw

## DH/DC System

### DH/DC System

#### DH/DC System Instrument

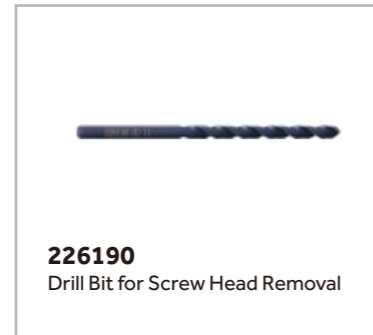
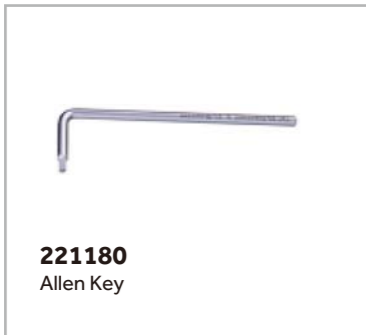

# Screws & Washers System

- Screws
- Washers

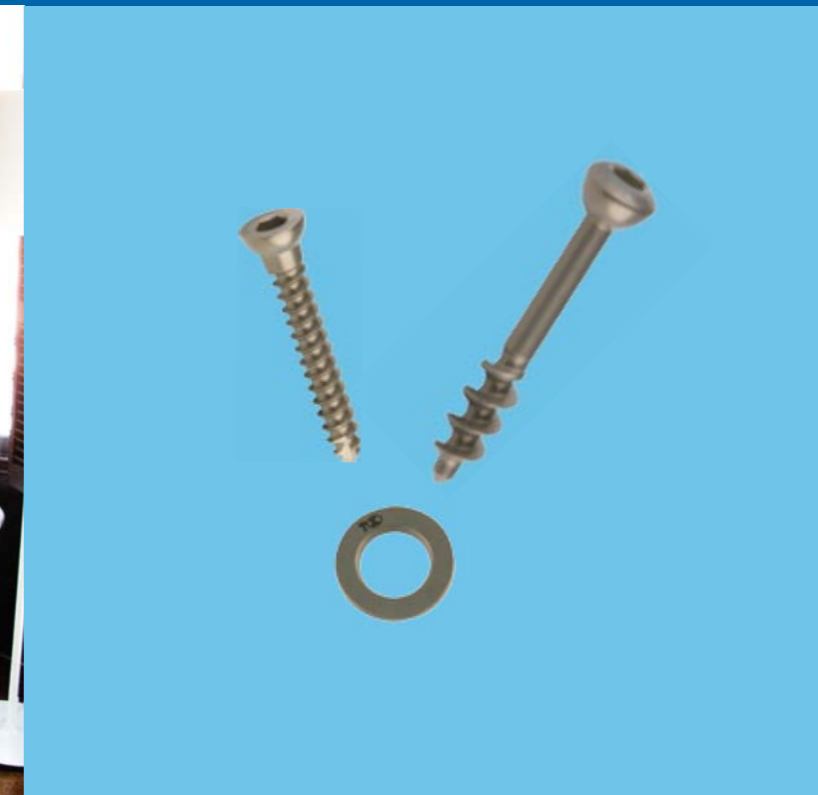
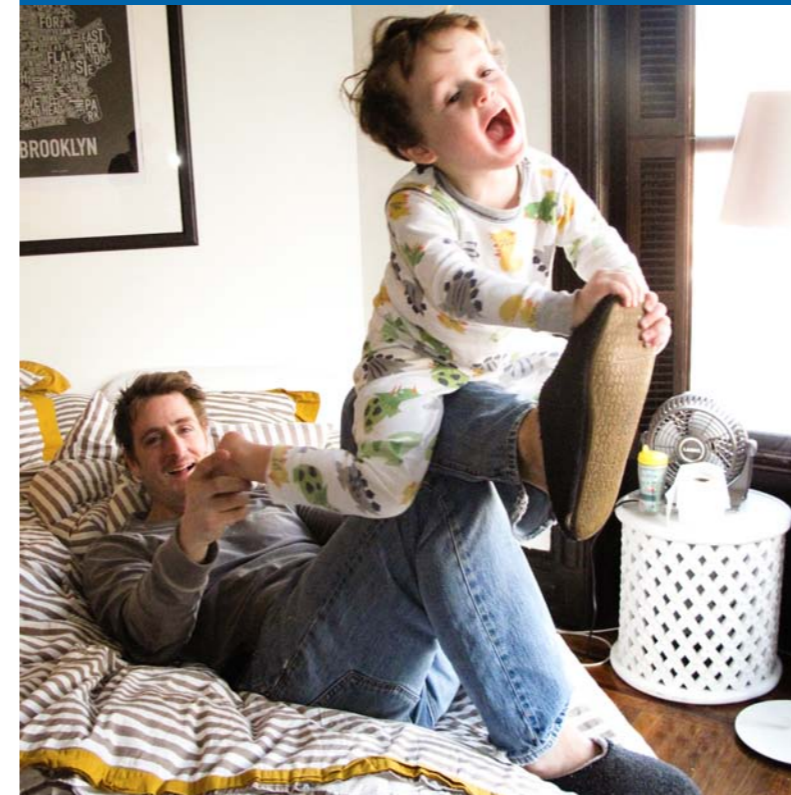



## Standard Screws & Washers

### Standard Screws & Washers

#### Cortex Screws, fully threaded



Specification	
Core (mm)	2.4
Material	TA

Code	Model No.	Size
30306110	HAQ03	3.5×10mm
30306112	HAQ03	3.5×12mm
30306114	HAQ03	3.5×14mm
30306116	HAQ03	3.5×16mm
30306118	HAQ03	3.5×18mm
30306120	HAQ03	3.5×20mm
30306122	HAQ03	3.5×22mm
30306124	HAQ03	3.5×24mm
30306126	HAQ03	3.5×26mm
30306128	HAQ03	3.5×28mm
30306130	HAQ03	3.5×30mm
30306132	HAQ03	3.5×32mm
30306134	HAQ03	3.5×34mm
30306136	HAQ03	3.5×36mm
30306138	HAQ03	3.5×38mm
30306140	HAQ03	3.5×40mm
30306142	HAQ03	3.5×42mm
30306144	HAQ03	3.5×44mm
30306145	HAQ03	3.5×45mm
30306146	HAQ03	3.5×46mm
30306148	HAQ03	3.5×48mm
30306150	HAQ03	3.5×50mm
30306165	HAQ03	3.5×65mm
30306170	HAQ03	3.5×70mm
30306175	HAQ03	3.5×75mm
30306180	HAQ03	3.5×80mm
30306185*	HAQ03	3.5×85mm
30306190*	HAQ03	3.5×90mm
30306191*	HAQ03	3.5×95mm
30306192*	HAQ03	3.5×100mm
30306193*	HAQ03	3.5×105mm
30306194*	HAQ03	3.5×110mm
30306195*	HAQ03	3.5×115mm
30306196*	HAQ03	3.5×120mm
30306197*	HAQ03	3.5×125mm
30306198*	HAQ03	3.5×130mm

\*make to order

#### Cortex screws, Fully threaded, self tapping



Specification	
Core (mm)	2.4
Material	TA

Code	Model No.	Size
39513510	HAQ03	3.5×10mm
39513512	HAQ03	3.5×12mm
39513514	HAQ03	3.5×14mm
39513516	HAQ03	3.5×16mm
39513518	HAQ03	3.5×18mm
39513520	HAQ03	3.5×20mm
39513522	HAQ03	3.5×22mm
39513524	HAQ03	3.5×24mm
39513526	HAQ03	3.5×26mm
39513528	HAQ03	3.5×28mm
39513530	HAQ03	3.5×30mm
39513532	HAQ03	3.5×32mm
39513534	HAQ03	3.5×34mm
39513536	HAQ03	3.5×36mm
39513538	HAQ03	3.5×38mm
39513540	HAQ03	3.5×40mm
39513542	HAQ03	3.5×42mm
39513544	HAQ03	3.5×44mm
39513545	HAQ03	3.5×45mm
39513546	HAQ03	3.5×46mm
39513548	HAQ03	3.5×48mm
39513550	HAQ03	3.5×50mm
39513555	HAQ03	3.5×55mm
39513560	HAQ03	3.5×60mm
39513565	HAQ03	3.5×65mm
39513570	HAQ03	3.5×70mm
39513575	HAQ03	3.5×75mm
39513580	HAQ03	3.5×80mm
39513585	HAQ03	3.5×85mm
39513590	HAQ03	3.5×90mm
39513591	HAQ03	3.5×95mm
39513592	HAQ03	3.5×100mm
39513593	HAQ03	3.5×105mm
39513594	HAQ03	3.5×110mm
39513595	HAQ03	3.5×115mm
39513596	HAQ03	3.5×120mm
39513597	HAQ03	3.5×125mm
39513598	HAQ03	3.5×130mm

## Standard Screws & Washers

### Standard Screws & Washers

#### Cortex screws, Fully threaded, self tapping



Specification	
Core (mm)	3
Material	TA

Code	Model No.	Size
39527914	HAQ03	4.5×14mm
39527916	HAQ03	4.5×16mm
39527918	HAQ03	4.5×18mm
39527920	HAQ03	4.5×20mm
39527922	HAQ03	4.5×22mm
39527924	HAQ03	4.5×24mm
39527926	HAQ03	4.5×26mm
39527928	HAQ03	4.5×28mm
39527930	HAQ03	4.5×30mm
39527932	HAQ03	4.5×32mm
39527934	HAQ03	4.5×34mm
39527936	HAQ03	4.5×36mm
39527938	HAQ03	4.5×38mm
39527940	HAQ03	4.5×40mm
39527942	HAQ03	4.5×42mm
39527944	HAQ03	4.5×44mm
39527946	HAQ03	4.5×46mm
39527948	HAQ03	4.5×48mm
39527950	HAQ03	4.5×50mm
39527952	HAQ03	4.5×52mm
39527954	HAQ03	4.5×54mm
39527956	HAQ03	4.5×56mm
39527958	HAQ03	4.5×58mm
39527960	HAQ03	4.5×60mm
39527965	HAQ03	4.5×65mm
39527970	HAQ03	4.5×70mm
39527975	HAQ03	4.5×75mm

#### Cortex Screws, partially threaded



Specification	
Core (mm)	2.4
Shaft (mm)	2.4
Material	TA

Code	Model No.	Size
30306212	HAQ03	3.5×12mm
30306214	HAQ03	3.5×14mm
30306216	HAQ03	3.5×16mm
30306218	HAQ03	3.5×18mm
30306220	HAQ03	3.5×20mm
30306222	HAQ03	3.5×22mm
30306224	HAQ03	3.5×24mm
30306226	HAQ03	3.5×26mm
30306228	HAQ03	3.5×28mm
30306230	HAQ03	3.5×30mm
30306232	HAQ03	3.5×32mm
30306234	HAQ03	3.5×34mm
30306236	HAQ03	3.5×36mm
30306238	HAQ03	3.5×38mm
30306240	HAQ03	3.5×40mm

## Standard Screws & Washers

### Standard Screws & Washers

#### Cortex Screws, fully threaded



Specification	
Core (mm)	3
Material	TA

Code	Model No.	Size
30308116	HAQ03	4.5×16mm
30308118	HAQ03	4.5×18mm
30308120	HAQ03	4.5×20mm
30308122	HAQ03	4.5×22mm
30308124	HAQ03	4.5×24mm
30308126	HAQ03	4.5×26mm
30308128	HAQ03	4.5×28mm
30308130	HAQ03	4.5×30mm
30308132	HAQ03	4.5×32mm
30308134	HAQ03	4.5×34mm
30308136	HAQ03	4.5×36mm
30308138	HAQ03	4.5×38mm
30308140	HAQ03	4.5×40mm
30308142	HAQ03	4.5×42mm
30308144	HAQ03	4.5×44mm
30308146	HAQ03	4.5×46mm
30308148	HAQ03	4.5×48mm
30308150	HAQ03	4.5×50mm
30308152	HAQ03	4.5×52mm
30308154	HAQ03	4.5×54mm
30308156	HAQ03	4.5×56mm
30308158	HAQ03	4.5×58mm
30308160	HAQ03	4.5×60mm

#### Cortex Screws, partially threaded



Specification	
Core (mm)	3
Shaft (mm)	3
Material	TA

Code	Model No.	Size
30308220	HAQ03	4.5×20mm
30308222	HAQ03	4.5×22mm
30308224	HAQ03	4.5×24mm
30308226	HAQ03	4.5×26mm
30308228	HAQ03	4.5×28mm
30308230	HAQ03	4.5×30mm
30308232	HAQ03	4.5×32mm
30308234	HAQ03	4.5×34mm
30308236	HAQ03	4.5×36mm
30308238	HAQ03	4.5×38mm
30308240	HAQ03	4.5×40mm
30308242	HAQ03	4.5×42mm
30308244	HAQ03	4.5×44mm
30308246	HAQ03	4.5×46mm
30308248	HAQ03	4.5×48mm
30308250	HAQ03	4.5×50mm
30308252	HAQ03	4.5×52mm
30308254	HAQ03	4.5×54mm
30308256	HAQ03	4.5×56mm
30308258	HAQ03	4.5×58mm
30308260	HAQ03	4.5×60mm

## Standard Screws & Washers

### Standard Screws & Washers

#### Cancellous Screws, fully threaded



Specification	
Core (mm)	2.2
Material	TA

Code	Model No.	Size
30403110	HBQ03	4.0×10mm
30403112	HBQ03	4.0×12mm
30403114	HBQ03	4.0×14mm
30403116	HBQ03	4.0×16mm
30403118	HBQ03	4.0×18mm
30403120	HBQ03	4.0×20mm
30403122	HBQ03	4.0×22mm
30403124	HBQ03	4.0×24mm
30403126	HBQ03	4.0×26mm
30403128	HBQ03	4.0×28mm
30403130	HBQ03	4.0×30mm
30403132	HBQ03	4.0×32mm
30403134	HBQ03	4.0×34mm
30403136	HBQ03	4.0×36mm
30403138	HBQ03	4.0×38mm
30403140	HBQ03	4.0×40mm
30403142	HBQ03	4.0×42mm
30403144	HBQ03	4.0×44mm
30403146	HBQ03	4.0×46mm
30403148	HBQ03	4.0×48mm
30403150	HBQ03	4.0×50mm
30403152	HBQ03	4.0×52mm
30403155	HBQ03	4.0×55mm
30403156	HBQ03	4.0×56mm
30403160	HBQ03	4.0×60mm
30403165	HBQ03	4.0×65mm
30403170	HBQ03	4.0×70mm

#### Cancellous Screws, partially threaded



Specification	
Core (mm)	1.9
Shaft (mm)	2.4
Material	TA

Code	Model No.	Size
30403210	HBQ03	4.0×10mm
30403212	HBQ03	4.0×12mm
30403214	HBQ03	4.0×14mm
30403216	HBQ03	4.0×16mm
30403218	HBQ03	4.0×18mm
30403220	HBQ03	4.0×20mm
30403222	HBQ03	4.0×22mm
30403224	HBQ03	4.0×24mm
30403226	HBQ03	4.0×26mm
30403228	HBQ03	4.0×28mm
30403230	HBQ03	4.0×30mm
30403232	HBQ03	4.0×32mm
30403234	HBQ03	4.0×34mm
30403236	HBQ03	4.0×36mm
30403238	HBQ03	4.0×38mm
30403240	HBQ03	4.0×40mm
30403242	HBQ03	4.0×42mm
30403244	HBQ03	4.0×44mm
30403246	HBQ03	4.0×46mm
30403248	HBQ03	4.0×48mm
30403250	HBQ03	4.0×50mm
30403252	HBQ03	4.0×52mm
30403254	HBQ03	4.0×54mm
30403255	HBQ03	4.0×55mm
30403256	HBQ03	4.0×56mm
30403260	HBQ03	4.0×60mm
30403265	HBQ03	4.0×65mm

## Standard Screws & Washers

### Standard Screws & Washers

#### Cancellous Screws, fully threaded



Specification	
Core (mm)	3
Material	TA

Code	Model No.	Size
30405125	HBQ03	6.5×25mm
30405130	HBQ03	6.5×30mm
30405135	HBQ03	6.5×35mm
30405140	HBQ03	6.5×40mm
30405145	HBQ03	6.5×45mm
30405150	HBQ03	6.5×50mm
30405155	HBQ03	6.5×55mm
30405160	HBQ03	6.5×60mm
30405165	HBQ03	6.5×65mm
30405170	HBQ03	6.5×70mm
30405175	HBQ03	6.5×75mm
30405180	HBQ03	6.5×80mm
30405185	HBQ03	6.5×85mm
30405190	HBQ03	6.5×90mm
30405191	HBQ03	6.5×95mm
30405192	HBQ03	6.5×100mm
30405193	HBQ03	6.5×105mm
30405194	HBQ03	6.5×110mm
30405195	HBQ03	6.5×115mm
30405196	HBQ03	6.5×120mm

#### Cancellous Screws, partially threaded, 16mm Thread



Specification	
Core (mm)	3
Shaft (mm)	4.5
Material	TA

Code	Model No.	Size
30406235	HBQ03	6.5×35mm
30406240	HBQ03	6.5×40mm
30406245	HBQ03	6.5×45mm
30406250	HBQ03	6.5×50mm
30406255	HBQ03	6.5×55mm
30406260	HBQ03	6.5×60mm
30406265	HBQ03	6.5×65mm
30406270	HBQ03	6.5×70mm
30406275	HBQ03	6.5×75mm
30406280	HBQ03	6.5×80mm
30406285	HBQ03	6.5×85mm
30406290	HBQ03	6.5×90mm
30406291	HBQ03	6.5×95mm
30406292	HBQ03	6.5×100mm
30406293	HBQ03	6.5×105mm
30406294	HBQ03	6.5×110mm
30406295	HBQ03	6.5×115mm
30406296	HBQ03	6.5×120mm

## Standard Screws & Washers

### Standard Screws & Washers

Cancellous Screws, partially threaded,  
32mm Thread



Core (mm)	3
Shaft (mm)	4.5
Material	TA

Code	Model No.	Size
30407240	HBQ03	6.5×40mm
30407245	HBQ03	6.5×45mm
30407250	HBQ03	6.5×50mm
30407255	HBQ03	6.5×55mm
30407260	HBQ03	6.5×60mm
30407265	HBQ03	6.5×65mm
30407270	HBQ03	6.5×70mm
30407275	HBQ03	6.5×75mm
30407280	HBQ03	6.5×80mm
30407285	HBQ03	6.5×85mm
30407290	HBQ03	6.5×90mm
30407291	HBQ03	6.5×95mm
30407292	HBQ03	6.5×100mm
30407293	HBQ03	6.5×105mm
30407294	HBQ03	6.5×110mm

Washers



Material	TA
----------	----

Code	Model
31409000 Washer for 4.0 Cancellous Screws	DJY-II
31410000 Washer for 6.5 Cancellous Screws	DJY-II
39781000 Washer for 6.5 Cancellous Screws, notched	DJY-II -02
31406000 Washer for 4.5 Cannulated Screws	DJY-II
31407000 Washer for 4.5 Cannulated Screws, notched	DJY-II
31402000 Washer for 7.3 Cannulated Screws	DJY-II
31403000 Washer for 7.3 Cannulated Screws, notched	DJY-II

# Cannulated Screws System

- KCS 4.0/4.5/7.0/7.3



## Cannulated Screws

### KCS Cannulated Screws System

#### Cannulated Screws



Specification	
Core (mm)	2.8
Shaft (mm)	2.8
Cannula (mm)	1.3
Material	TA

Code	Model No.	Size
31421025	DJY-II	4.0×25mm
31421030	DJY-II	4.0×30mm
31421035	DJY-II	4.0×35mm
31421040	DJY-II	4.0×40mm
31421045	DJY-II	4.0×45mm
31421050	DJY-II	4.0×50mm
31421055	DJY-II	4.0×55mm
31421060	DJY-II	4.0×60mm
31421065	DJY-II	4.0×65mm
31421070	DJY-II	4.0×70mm

#### Cannulated Screws



Specification	
Core (mm)	3.2
Shaft (mm)	3.1
Cannula (mm)	1.7
Material	TA

Code	Model No.	Size
31405020	DJY-II	4.5×20mm
31405025	DJY-II	4.5×25mm
31405030	DJY-II	4.5×30mm
31405035	DJY-II	4.5×35mm
31405040	DJY-II	4.5×40mm
31405045	DJY-II	4.5×45mm
31405050	DJY-II	4.5×50mm
31405055	DJY-II	4.5×55mm
31405060	DJY-II	4.5×60mm
31405065	DJY-II	4.5×65mm
31405070	DJY-II	4.5×70mm
31405075	DJY-II	4.5×75mm

#### Cannulated Screws



Specification	
Core (mm)	4.5
Shaft (mm)	4.5
Cannula (mm)	2.1
Material	TA

Code	Model No.	Size
31411040*	DJY-II	7.0×40mm
31411045*	DJY-II	7.0×45mm
31411050*	DJY-II	7.0×50mm
31411055*	DJY-II	7.0×55mm
31411060*	DJY-II	7.0×60mm
31411065*	DJY-II	7.0×65mm
31411070*	DJY-II	7.0×70mm
31411075*	DJY-II	7.0×75mm
31411080*	DJY-II	7.0×80mm
31411085*	DJY-II	7.0×85mm
31411090*	DJY-II	7.0×90mm
31411091*	DJY-II	7.0×95mm
31411092*	DJY-II	7.0×100mm
31411093*	DJY-II	7.0×105mm

\*make to order

#### Cannulated Screws, 16mm thread



Specification	
Core (mm)	5
Shaft (mm)	5
Cannula (mm)	2.6
Material	TA

Code	Model No.	Size
31401040	DJY-II	7.3×40mm
31401045	DJY-II	7.3×45mm
31401050	DJY-II	7.3×50mm
31401055	DJY-II	7.3×55mm
31401060	DJY-II	7.3×60mm
31401065	DJY-II	7.3×65mm
31401070	DJY-II	7.3×70mm
31401075	DJY-II	7.3×75mm
31401080	DJY-II	7.3×80mm
31401085	DJY-II	7.3×85mm
31401090	DJY-II	7.3×90mm
31401091	DJY-II	7.3×95mm
31401092	DJY-II	7.3×100mm
31401093	DJY-II	7.3×105mm
31401094	DJY-II	7.3×110mm
31401095	DJY-II	7.3×115mm
31401096	DJY-II	7.3×120mm



## Cannulated Screws

### KCS Cannulated Screws System

Cannulated Screws, 3.2mm thread



Core (mm)	5
Shaft (mm)	5
Cannula (mm)	2.6
Material	TA

Code	Model No.	Size
31404050	DJY-II	7.3×50mm
31404055	DJY-II	7.3×55mm
31404060	DJY-II	7.3×60mm
31404065	DJY-II	7.3×65mm
31404070	DJY-II	7.3×70mm
31404075	DJY-II	7.3×75mm
31404080	DJY-II	7.3×80mm
31404085	DJY-II	7.3×85mm
31404090	DJY-II	7.3×90mm
31404091	DJY-II	7.3×95mm
31404092	DJY-II	7.3×100mm
31404093	DJY-II	7.3×105mm
31404094	DJY-II	7.3×110mm
31404095	DJY-II	7.3×115mm
31404096	DJY-II	7.3×120mm

## Cannulated Screws

### KCS Cannulated Screws System

#### 4.0mm KCS Cannulated Screws Instruments Set

Code	Product Description	Qty.
899900	4.0mm KCS Cannulated Screws Instruments Set	
898350	4.0mm KCS Cannulated Screws Instruments Set (Empty)-PPSU	1
246100	Cleaning Stylet, 1.2mm	1
246110	Guide Wire, 1.2mm	3
246120	Threaded Pin, 1.2mm	3
246130	Direct Measuring Device for Guide Wire 1.2mm	1
246140	Drill Guide for Guide Wire 1.2mm	1
246150	Drill Sleeve 3.0	1
246160	Allen Key, for Protector	1
246170	Protector	1
246180	Cannulated Drill Bit, 3.0mm	1
246190	Tap, 4.0mm	1
246200	Cannulated Screwdriver	1
246210	Hex Screwdriver	1
246220	Cannulated Countersink	1
246230	Easyout	1
246240	Screw Forceps, self-retaining	1



#### optional instrument

Code	Product Description	Qty.
898203	Cannulated Screwdriver (silicon handle)	1
898204	Hex Screwdriver (silicon handle)	1

#### 4.0mm KCS Cannulated Screws Instrument

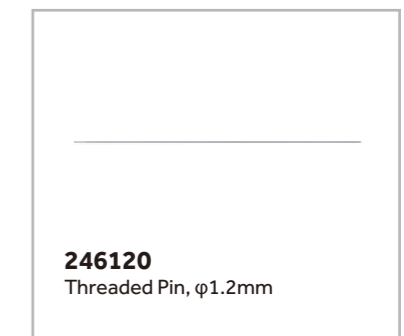
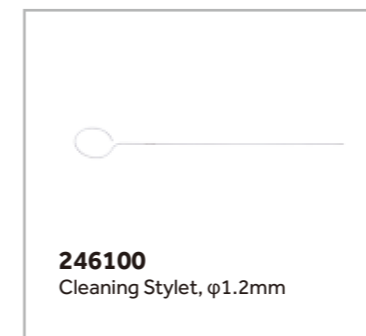

## Cannulated Screws

### KCS Cannulated Screws System

#### 4.0mm KCS Cannulated Screws Instrument

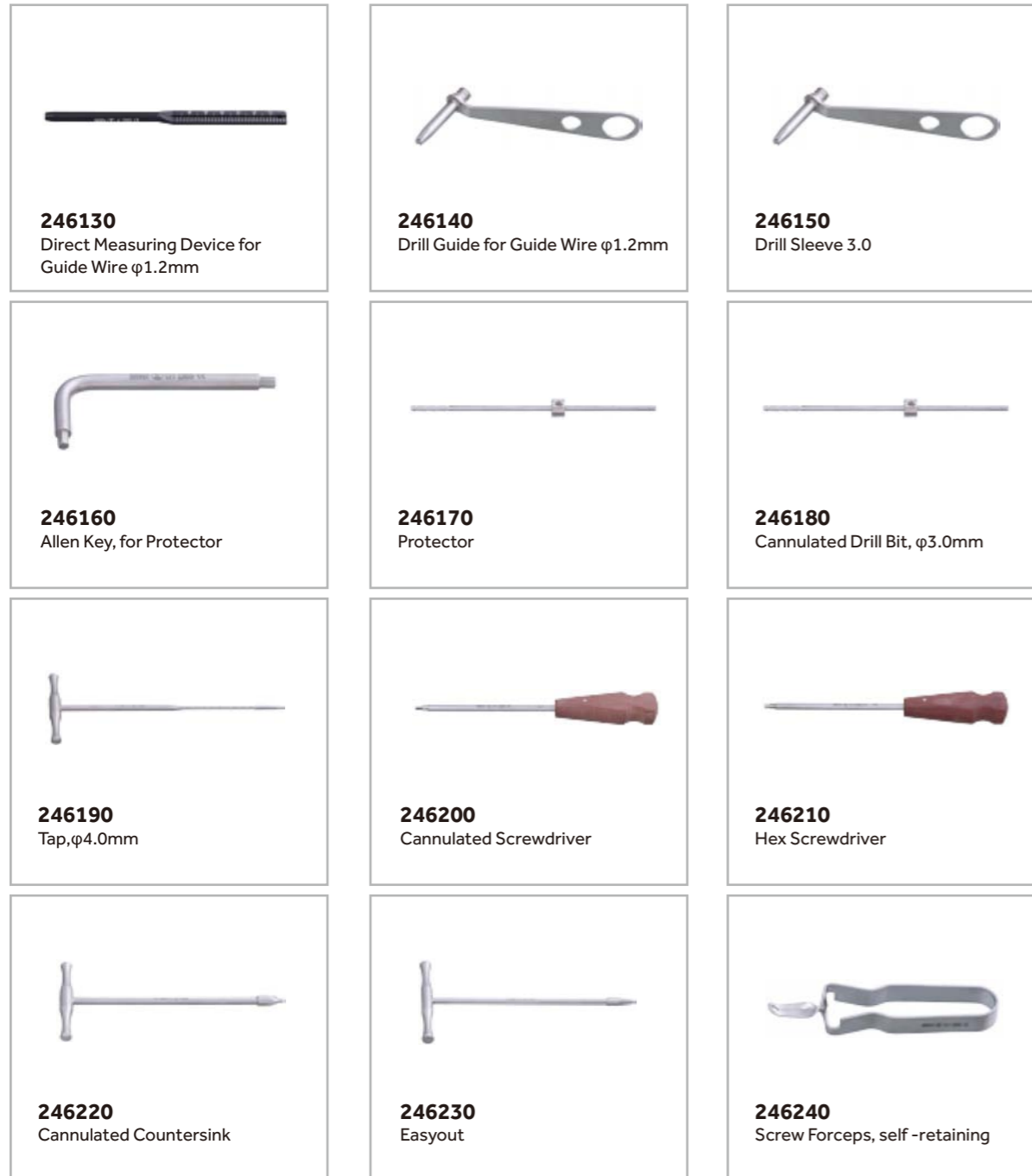

## Cannulated Screws

### KCS Cannulated Screws System

#### 4.5mm KCS Cannulated Screws Instruments Set

Code	Product Description	Qty.
236900	4.5mm KCS Cannulated Screws Instruments Set	
898351	4.5mm KCS Cannulated Screws Instruments Set (Empty)-PPSU	1
236100	Cleaning Stylet	1
236111	Guide Wire, 1.6mm	3
236121	Threaded Pin, 1.6mm	3
246130	Direct Measuring Device	1
236140	Drill Guide 1.6	1
236150	Protection Sleeve	1
236160	Protector, 3.2mm	1
236170	Allen Key, for Protector	1
236180	Cannulated Drill Bit, 3.2mm	1
236190	Tap, 4.5mm	1
236200	Cannulated Countersink	1
236210	Easyout	1
236220	Cannulated Screwdriver SW3.5	1
236230	Screw Holding Sleeve	1
236240	Hex Screwdriver SW3.5	1
236250	Screw Forceps, self-retaining	1
206120	Double Drill Guide 4.5/3.2	1



#### optional instrument

Code	Product Description	Qty.
898148	Cannulated Screwdriver SW3.5 (silicon handle)	1
898149	Hex Screwdriver SW3.5 (silicon handle)	1

#### 4.5mm KCS Cannulated Screws Instrument

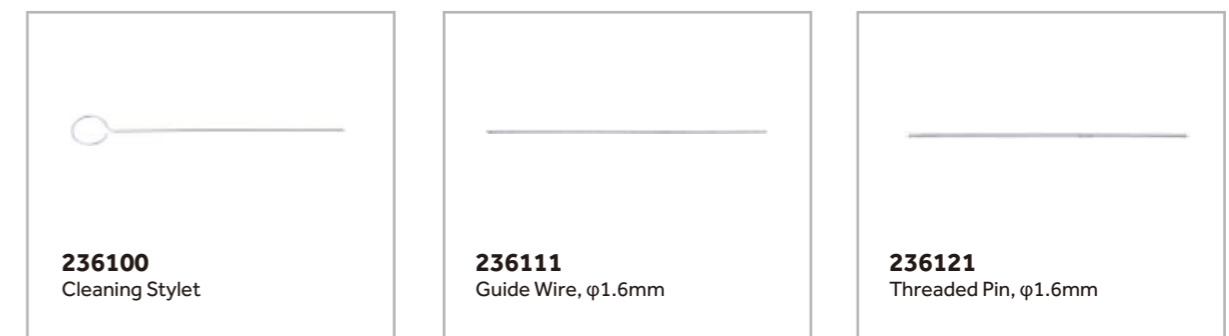

## Cannulated Screws

### KCS Cannulated Screws System

#### 4.5mm KCS Cannulated Screws Instrument

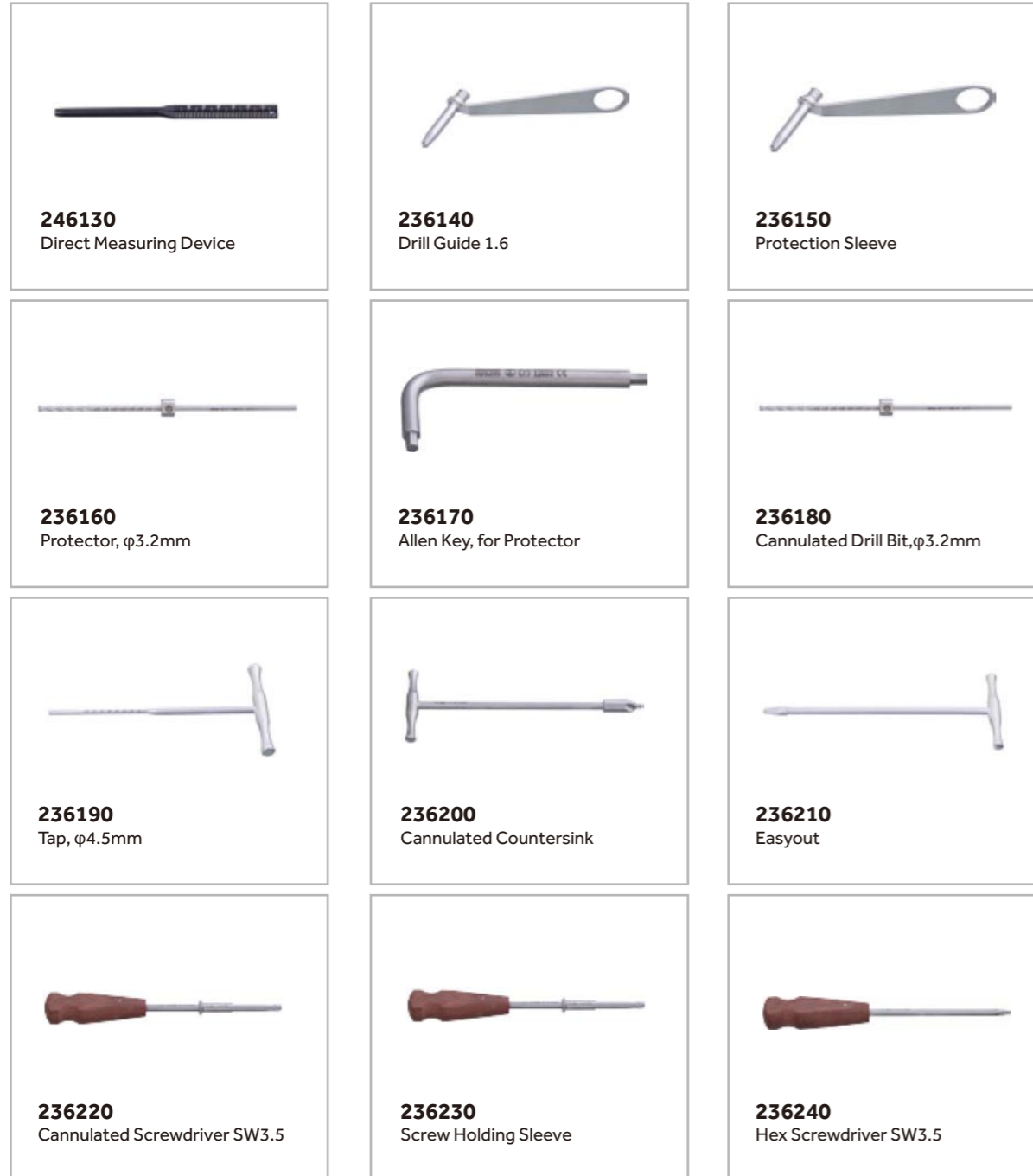

## Cannulated Screws

### KCS Cannulated Screws System

#### 4.5mm KCS Cannulated Screws Instrument



## Cannulated Screws

### KCS Cannulated Screws System

#### 7.0mm KCS Cannulated Screws Instrument Set\*

Code	Product Description	Qty.
899920	7.0mm KCS Cannulated Screws Instruments Set	
898352	7.0mm KCS Cannulated Screws Instruments Set (Empty)-PPSU	1
899921	Cannulated Countersink	1
899922	Cannulated Drill Bit, 4.5mm	1
899923	Protection Sleeve	1
899924	Drill Sleeve 4.5/2.0	1
899925	Drill sleeve 10.0/4.5	1
899926	Drill Sleeve 10.0/2.0	1
899927	Parallel Guide for Guide Wires 2.0mm, adjustable	1
899928	Tap, 7.0mm	1
899929	Allen Key, for Protector	1
899930	Cleaning Stylet	1
899931	Protector	1
899932	Drill Guide for Multiple Insertion of Guide Wires 2.0mm	1
899933	Cannulated Screwdriver SW3.5	1
899934	Guide Wire, 2.0mm	3
899935	Threaded Pin, 2.0mm	3
899936	Screw Holding Sleeve	1
899937	Hex Screwdriver, SW3.5	1
899938	Direct Measuring Device for Guide Wire 2.0mm	1
898158	Drill Guide for Multiple Insertion of Guide Wires 2.0mm (silicon handle)	1

\*make to order

#### optional instrument

Code	Product Description	Qty.
898159	Cannulated Screwdriver SW3.5 (silicon handle)	1
898160	Hex Screwdriver, SW3.5 (silicon handle)	1



## Cannulated Screws

### KCS Cannulated Screws System

#### 7.0mm KCS Cannulated Screws Instrument

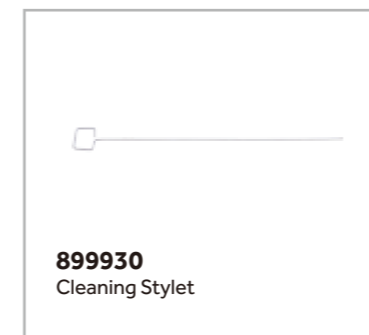
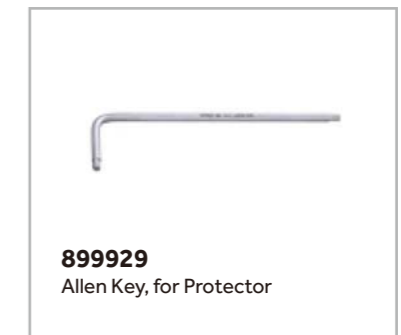
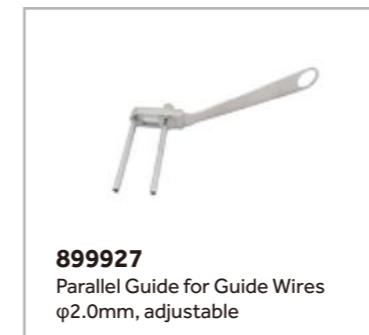

## Cannulated Screws

### KCS Cannulated Screws System

#### 7.0mm KCS Cannulated Screws Instrument

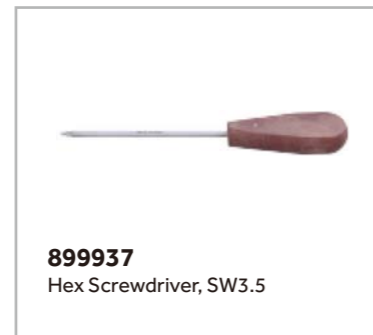
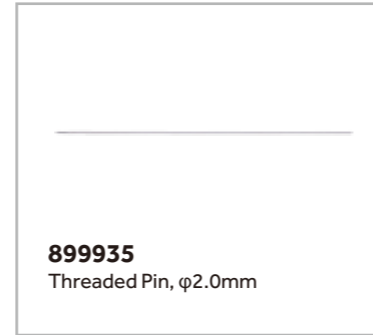
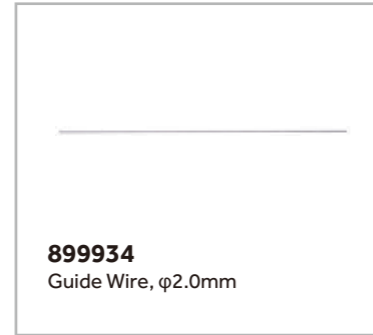

## Cannulated Screws

### KCS Cannulated Screws System

#### 7.3mm KCS Cannulated Screws Instruments Set

Code	Product Description	Qty.
241900	7.3mm KCS Cannulated Screws Instruments Set	
898353	7.3mm KCS Cannulated Screws Instruments Set (Empty)-PPSU	1
241100	Cleaning Stylet	1
241110	Trocar	1
241120	Drill Guide 2.5	1
241130	Protection Sleeve	1
241140	Protection Sleeve 10.0	1
241150	Parallel Guide for Guide Wires 2.5mm, adjustable	1
241160	Cannulated Drill Bit, 5.0mm	1
241170	Protector	1
241180	Allen Key, for Protector	1
241190	Tap, 7.3mm	1
241200	Cannulated Countersink	1
241210	Easyout	1
241220	Drill Guide for Multiple Insertion of Guide Wires 2.5mm	1
241230	Cannulated Screwdriver SW4.0	1
241240	Hex Screwdriver SW4.0	1
241250	Guide Wire, 2.5mm	3
241260	Threaded Pin, 2.5mm	3
241270	Direct Measuring Device for Guide Wire 2.5mm	1
241280	Screw Holding Sleeve	1
241290	Pin Wrench	1



#### Optional Instrument

Code	Product Description	Qty.
898151	Drill Guide for Multiple Insertion of Guide Wires 2.5mm(silicon handle)	1
898152	Cannulated Screwdriver SW4.0 (silicon handle)	1
898153	Hex Screwdriver SW4.0 (silicon handle)	1



## Cannulated Screws

### KCS Cannulated Screws System

#### 7.3mm KCS Cannulated Screws Instrument

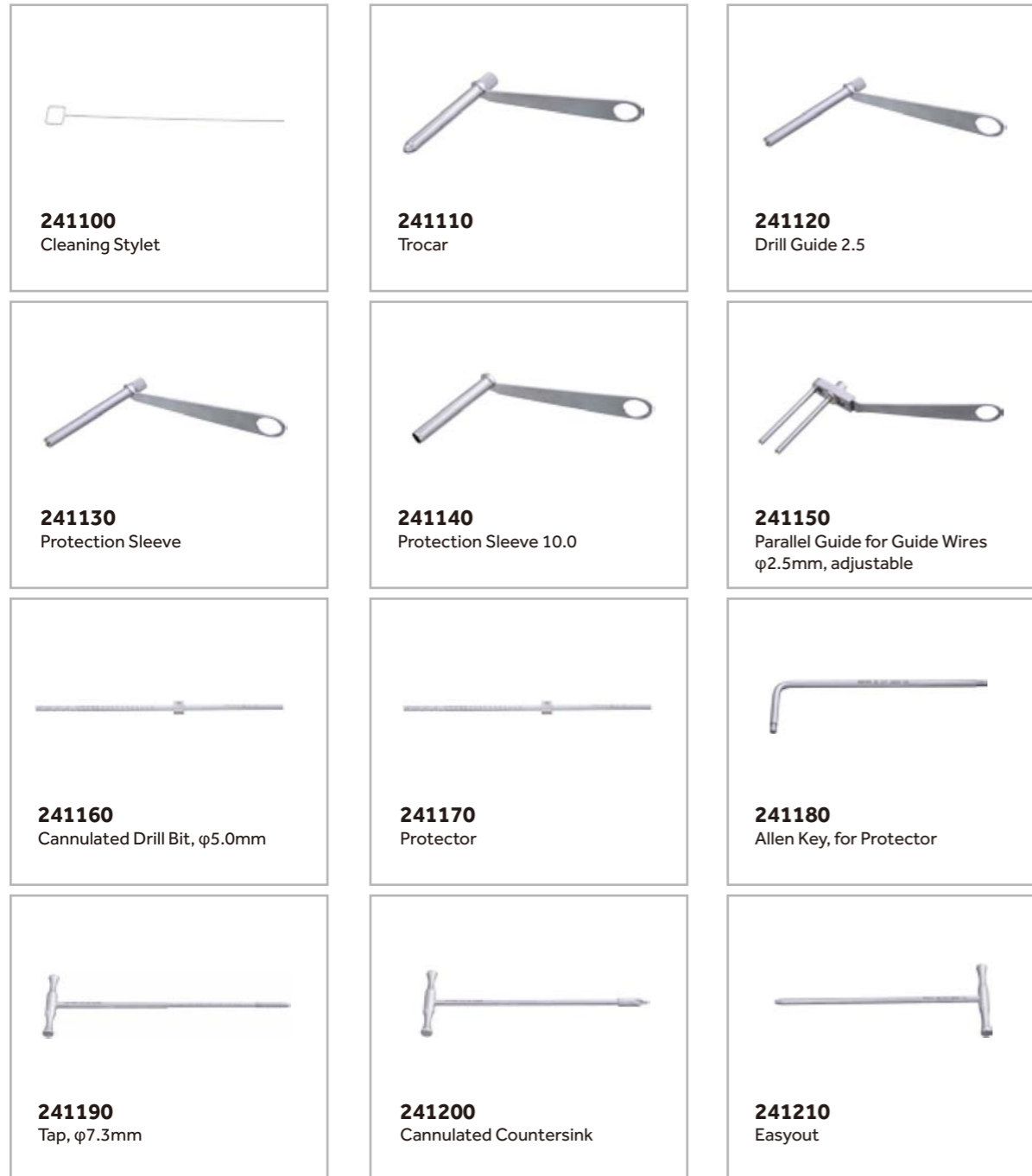

## Cannulated Screws

### KCS Cannulated Screws System

#### 7.3mm KCS Cannulated Screws Instrument

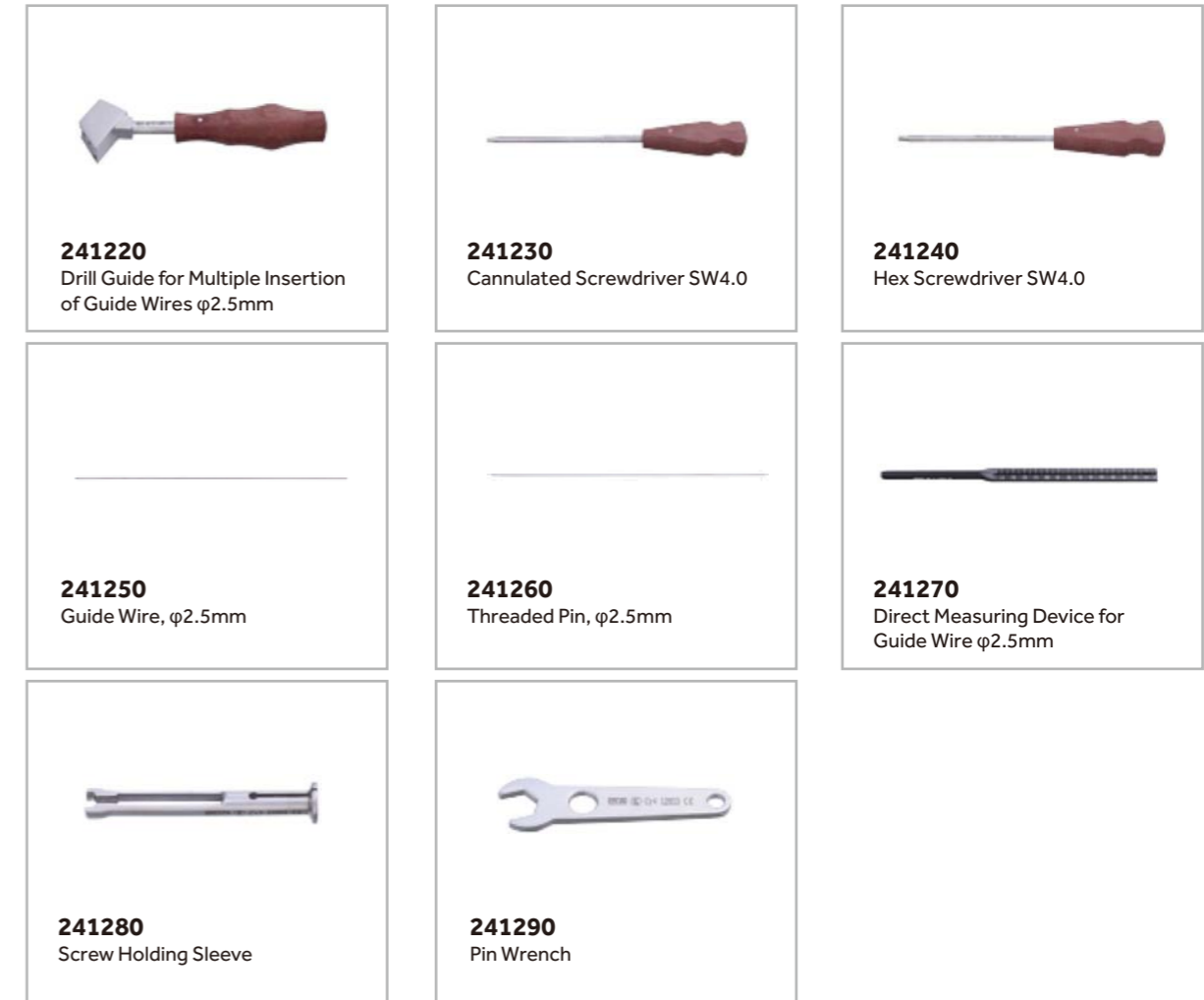

## Cannulated Screws

### 2.4/3.0mm Headless Compression Screws System

2.4mm Headless Compression Screws, short thread



Core (mm)	1.9
Shaft (mm)	2
Cannula (mm)	1.2
Material	TA

Code	Model No.	Size
31462010	DJY-III	10mm
31462012	DJY-III	12mm
31462014	DJY-III	14mm
31462016	DJY-III	16mm
31462018	DJY-III	18mm
31462020	DJY-III	20mm
31462022	DJY-III	22mm
31462024	DJY-III	24mm
31462026	DJY-III	26mm
31462028	DJY-III	28mm
31462030	DJY-III	30mm
31462032	DJY-III	32mm
31462034	DJY-III	34mm
31462036	DJY-III	36mm
31462038	DJY-III	38mm
31462040	DJY-III	40mm

3.0mm Headless Compression Screws, short thread



Core (mm)	1.9
Shaft (mm)	2
Cannula (mm)	1.2
Material	TA

Code	Model No.	Size
31464010	DJY-III	10mm
31464012	DJY-III	12mm
31464014	DJY-III	14mm
31464016	DJY-III	16mm
31464018	DJY-III	18mm
31464020	DJY-III	20mm
31464022	DJY-III	22mm
31464024	DJY-III	24mm
31464026	DJY-III	26mm
31464028	DJY-III	28mm
31464030	DJY-III	30mm
31464032	DJY-III	32mm
31464034	DJY-III	34mm
31464036	DJY-III	36mm
31464038	DJY-III	38mm
31464040	DJY-III	40mm

2.4mm Headless Compression Screws, long thread



Core (mm)	1.9
Shaft (mm)	2
Cannula (mm)	1.2
Material	TA

Code	Model No.	Size
31463018	DJY-III	18mm
31463020	DJY-III	20mm
31463022	DJY-III	22mm
31463024	DJY-III	24mm
31463026	DJY-III	26mm
31463028	DJY-III	28mm
31463030	DJY-III	30mm
31463032	DJY-III	32mm
31463034	DJY-III	34mm
31463036	DJY-III	36mm
31463038	DJY-III	38mm
31463040	DJY-III	40mm

3.0mm Headless Compression Screws, long thread



Core (mm)	1.9
Shaft (mm)	2
Cannula (mm)	1.2
Material	TA

Code	Model No.	Size
31465016	DJY-III	16mm
31465018	DJY-III	18mm
31465020	DJY-III	20mm
31465022	DJY-III	22mm
31465024	DJY-III	24mm
31465026	DJY-III	26mm
31465028	DJY-III	28mm
31465030	DJY-III	30mm
31465032	DJY-III	32mm
31465034	DJY-III	34mm
31465036	DJY-III	36mm
31465038	DJY-III	38mm
31465040	DJY-III	40mm

## Cannulated Screws

### 2.4/3.0mm Headless Compression Screws System

#### 2.4/3.0 Headless Compression Screw Instruments Set

Code	Product Description	Qty.
237000	2.4/3.0 Headless Compression Screws Instruments Set	
898354	2.4/3.0 Headless Compression Screws Instruments Set (Empty)-PPSU	1
237040	2.4mm HCS Implants Tray	1
237050	3.0mm HCS Implants Tray	1
237100	Compression Sleeve for Headless Compression Screw 3.0mm	1
237180	Depth Gauge	1
237150	Cannulated Trapezium Drill, Quick Coupling, 4.8 mm	1
237110	Cannulated StarDrive Screwdriver Shaft, T8, Quick Coupling	1
237160	Trapezium Drill Sleeve 4.8	1
237130	Compression Sleeve Handle	1
237120	Compression Sleeve for Headless Compression Screw 2.4mm	1
10749150	Threaded Guide Wire, 1.1mm	2
10750150	Guide Wire, 1.1mm	2
237140	Cannulated Drill Bit, Quick Coupling, 2.0mm	1
237200	Handle, with Quick Coupling	1
237170	Double Drill Sleeve 2.0/1.1	1
286210	StarDrive Screwdriver Shaft, T8	1
237190	Cleaning Stylet, 1.1mm	1
01220	Screw Forceps	1
01232	Periosteal Elevator, width 3mm	1
01218	Sharp Hooker	1





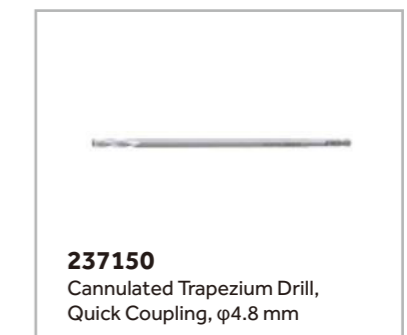
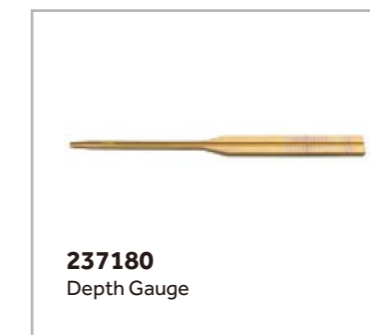









#### 2.4/3.0 Headless Compression Screw Instrument



## Cannulated Screws

### 2.4/3.0mm Headless Compression Screws System



#### 2.4/3.0 Headless Compression Screw Instrument

 <b>237110</b> Cannulated StarDrive Screwdriver Shaft, T8, Quick Coupling	 <b>237160</b> Trapezium Drill Sleeve 4.8	 <b>237130</b> Compression Sleeve Handle
 <b>237120</b> Compression Sleeve for Headless Compression Screw φ2.4mm	 <b>10749150</b> Threaded Guide Wire, φ1.1mm	 <b>10750150</b> Guide Wire, φ1.1mm
 <b>237140</b> Cannulated Drill Bit, Quick Coupling, φ2.0mm	 <b>237200</b> Handle, with Quick Coupling	 <b>237170</b> Double Drill Sleeve 2.0 / 1.1
 <b>286210</b> StarDrive Screwdriver Shaft, T8	 <b>237190</b> Cleaning Stylet, φ1.1mm	 <b>01220</b> Screw Forceps

## Cannulated Screws

### 2.4/3.0mm Headless Compression Screws System

#### 2.4/3.0 Headless Compression Screw Instrument

 <b>01232</b> Periosteal Elevator, width 3mm	 <b>01218</b> Sharp Hooker
---	---

# NeoGen Nails System

- NeoGen Femoral Nail
- NeoGen Tibia Nail
- NeoGen Retrograde Nail
- NeoGen Gamma Nail



# NeoGen Nails System

## NeoGen Nails System

### NeoGen Femoral Nails



Specification	
Prox (mm)	13
Material	TA

Code	Model No.	Direction	Size
33101232	JGD II	Left	9.5X320mm
33101234	JGD II	Left	9.5X340mm
33101236	JGD II	Left	9.5X360mm
33101238	JGD II	Left	9.5X380mm
33101240	JGD II	Left	9.5X400mm
33101242	JGD II	Left	9.5X420mm
33101244	JGD II	Left	9.5X440mm
33102232	JGD II	Left	10X320mm
33102234	JGD II	Left	10X340mm
33102236	JGD II	Left	10X360mm
33102238	JGD II	Left	10X380mm
33102240	JGD II	Left	10X400mm
33102242	JGD II	Left	10X420mm
33102244	JGD II	Left	10X440mm
33101132	JGD II	Right	9.5X320mm
33101134	JGD II	Right	9.5X340mm
33101136	JGD II	Right	9.5X360mm
33101138	JGD II	Right	9.5X380mm
33101140	JGD II	Right	9.5X400mm
33101142	JGD II	Right	9.5X420mm
33101144	JGD II	Right	9.5X440mm
33102132	JGD II	Right	10X320mm
33102134	JGD II	Right	10X340mm
33102136	JGD II	Right	10X360mm
33102138	JGD II	Right	10X380mm
33102140	JGD II	Right	10X400mm
33102142	JGD II	Right	10X420mm
33102144	JGD II	Right	10X440mm

Code	Model No.	Direction	Size
33103232	JGD II	Left	11X320mm
33103234	JGD II	Left	11X340mm
33103236	JGD II	Left	11X360mm
33103238	JGD II	Left	11X380mm
33103240	JGD II	Left	11X400mm
33103242	JGD II	Left	11X420mm
33103244	JGD II	Left	11X440mm
33104232	JGD II	Left	12X320mm
33104234	JGD II	Left	12X340mm
33104236	JGD II	Left	12X360mm
33104238	JGD II	Left	12X380mm
33104240	JGD II	Left	12X400mm
33104242	JGD II	Left	12X420mm
33104244	JGD II	Left	12X440mm
33103132	JGD II	Right	11X320mm
33103134	JGD II	Right	11X340mm
33103136	JGD II	Right	11X360mm
33103138	JGD II	Right	11X380mm
33103140	JGD II	Right	11X400mm
33103142	JGD II	Right	11X420mm
33103144	JGD II	Right	11X440mm
33104132	JGD II	Right	12X320mm
33104134	JGD II	Right	12X340mm
33104136	JGD II	Right	12X360mm
33104138	JGD II	Right	12X380mm
33104140	JGD II	Right	12X400mm
33104142	JGD II	Right	12X420mm
33104144	JGD II	Right	12X440mm



## NeoGen Nails System

### NeoGen Nails System

#### NeoGen Locking Screws



Specification	
Core (mm)	4
Material	TA

Specification	
Core (mm)	4.3
Material	TA

Code	Model No.	Size
33111025	JSD VII	4.5X26mm
33111030	JSD VII	4.5X30mm
33111035	JSD VII	4.5X35mm
33111040	JSD VII	4.5X40mm
33111045	JSD VII	4.5X45mm
33111050	JSD VII	4.5X50mm
33111055	JSD VII	4.5X55mm
33111060	JSD VII	4.5X60mm
33111065	JSD VII	4.5X65mm
33111070	JSD VII	4.5X70mm
33111075	JSD VII	4.5X75mm
33111080	JSD VII	4.5X80mm
33111085	JSD VII	4.5X85mm
33111090	JSD VII	4.5X90mm

Code	Model No.	Size
33112025	JSD VII	5X26mm
33112030	JSD VII	5X30mm
33112035	JSD VII	5X35mm
33112040	JSD VII	5X40mm
33112045	JSD VII	5X45mm
33112050	JSD VII	5X50mm
33112055	JSD VII	5X55mm
33112060	JSD VII	5X60mm
33112065	JSD VII	5X65mm
33112070	JSD VII	5X70mm
33112075	JSD VII	5X75mm
33112080	JSD VII	5X80mm
33112085	JSD VII	5X85mm
33112090	JSD VII	5X90mm
33112091	JSD VII	5X95mm
33112092	JSD VII	5X100mm

#### NeoGen Reconstruction Locking Screws



Specification	
Core (mm)	4.8
Shaft (mm)	6.3
Material	TA

Code	Model No.	Size
33113065	JSD VIII	6.3X65mm
33113070	JSD VIII	6.3X70mm
33113075	JSD VIII	6.3X75mm
33113080	JSD VIII	6.3X80mm
33113085	JSD VIII	6.3X85mm
33113090	JSD VIII	6.3X90mm
33113091	JSD VIII	6.3X95mm
33113092	JSD VIII	6.3X100mm
33113093	JSD VIII	6.3X105mm
33113094	JSD VIII	6.3X110mm
33113095	JSD VIII	6.3X115mm
33113096	JSD VIII	6.3X120mm
33113097	JSD VIII	6.3X125mm

#### NeoGen Nails Caps (Femoral)



Specification	
Material	TA

Code	Model No.	Size
33110000	JGM V	
33110005	JGM V	φ13,+5
33110010	JGM V	φ13,+10
33110015	JGM V	φ13,+15

## NeoGen Nails System

### NeoGen Nails System

#### NeoGen Tibia Nails



Code	Model No.	Size
33140026	JJD V	8.3X260mm
33140028	JJD V	8.3X280mm
33140030	JJD V	8.3X300mm
33140032	JJD V	8.3X320mm
33140034	JJD V	8.3X340mm
33140036	JJD V	8.3X360mm
33140038	JJD V	8.3X380mm
33140040	JJD V	8.3X400mm
33140042	JJD V	8.3X420mm
33141026	JJD V	9X260mm
33141028	JJD V	9X280mm
33141030	JJD V	9X300mm
33141032	JJD V	9X320mm
33141034	JJD V	9X340mm
33141036	JJD V	9X360mm
33141038	JJD V	9X380mm
33141040	JJD V	9X400mm
33141042	JJD V	9X420mm

Specification	
Prox (mm)	11.5
Material	TA

Code	Model No.	Size
33142026	JJD V	10X260mm
33142028	JJD V	10X280mm
33142030	JJD V	10X300mm
33142032	JJD V	10X320mm
33142034	JJD V	10X340mm
33142036	JJD V	10X360mm
33142038	JJD V	10X380mm
33142040	JJD V	10X400mm
33142042	JJD V	10X420mm
33143026	JJD V	11.5X260mm
33143028	JJD V	11.5X280mm
33143030	JJD V	11.5X300mm
33143032	JJD V	11.5X320mm
33143034	JJD V	11.5X340mm
33143036	JJD V	11.5X360mm
33143038	JJD V	11.5X380mm
33143040	JJD V	11.5X400mm
33143042	JJD V	11.5X420mm

#### NeoGen Retrograde Nails



Code	Model No.	Size
33166260	JGD VII	10X260mm
33166280	JGD VII	10X280mm
33166300	JGD VII	10X300mm
33166320	JGD VII	10X320mm
33166340	JGD VII	10X340mm
33166360	JGD VII	10X360mm
33166380	JGD VII	10X380mm
33166400	JGD VII	10X400mm
33166420	JGD VII	10X420mm

Specification	
Prox (mm)	11.5
Material	TA

Code	Model No.	Size
33167260	JGD VII	11.5X260mm
33167280	JGD VII	11.5X280mm
33167300	JGD VII	11.5X300mm
33167320	JGD VII	11.5X320mm
33167340	JGD VII	11.5X340mm
33167360	JGD VII	11.5X360mm
33167380	JGD VII	11.5X380mm
33167400	JGD VII	11.5X400mm
33167420	JGD VII	11.5X420mm

## NeoGen Nails System

### NeoGen Nails System

#### NeoGen Nails Caps (Tibia&Retrograde)



Material	TA
----------	----

Code	Model No.	Size
33110000	JGM V	
33144005	JGM V	11.5,+5
33144010	JGM V	11.5,+10
33144015	JGM V	11.5,+15

#### NeoGen GAMMA Nails Lag Screws



Cannula (mm)	3.5
Core (mm)	6.6
Shaft (mm)	10.5
Material	TA

Code	Model No.	Size
33123075	JSD IX	10.5X75mm
33123080	JSD IX	10.5X80mm
33123085	JSD IX	10.5X85mm
33123090	JSD IX	10.5X90mm
33123091	JSD IX	10.5X95mm
33123092	JSD IX	10.5X100mm
33123093	JSD IX	10.5X105mm
33123094	JSD IX	10.5X110mm
33123095	JSD IX	10.5X115mm
33123096	JSD IX	10.5X120mm

#### NeoGen GAMMA Nails



Prox (mm)	15.5
Cannula (mm)	5
Material	TA

Code	Model No.	Size
33120018	JGD III	11X180mm
33120024	JGD III	11X240mm

#### NeoGen Nails Caps (GAMMA)



Material	TA
----------	----

Code	Model No.	Size
33121000	JGM V	10.3
33122005	JGM V	15.5, +5
33122010	JGM V	15.5, +10
39570815	JGM V	15.5, +15

## NeoGen Nails System

### NeoGen Nails System

#### NeoGen Nail Instruments Set

Code	Product Description	Qty.
899460	Neogen Nail Instruments Set	
898357	Neogen Nail Basic Instruments Set (Empty)-PPSU	1
898358	NeoGen Nail Special Instruments Set (Empty)-PPSU	1
898196	NeoGen Nail Special Instruments Set Empty Tray	1
899461	Awl	1
899464	Tissue Protector	1
899467	L-Hex Wrench, SW3 for Stopper 7mm	1
899469	Reducer	1
899470	Ball Tip Guide Wire	1
251170	Guide Wire Holder	1
050013	Hex Reamer Shaft-Dual Direction	1
899472	Hex Reamer Shaft-Mono Direction	1
050085	Reamer, 8.5mm	1
050090	Reamer, 9mm	1
050095	Reamer, 9.5mm	1
050100	Reamer, 10mm	1
050105	Reamer, 10.5mm	1
050110	Reamer, 11mm	1
050115	Reamer, 11.5mm	1
050120	Reamer, 12mm	1
050125	Reamer, 12.5mm	1
050130	Reamer, 13mm	1
050135	Reamer, 13.5mm	1
899468	T-Handle with Quick Coupling	1
899497	Guide Bolt Wrench Shaft	1
899498	Extractor	1
899499	Insertion Handle	1
899500	Guide Bolt	2
899502	Impactor	1
899489	Guide Wire Sleeve 2.5	1
899490	Guide Wire, 2.5mm	3
899491	Guide Wire with Threaded Tip, 2.5mm	3
899492	Direct Measuring Device for Guide Wires	1
899484	Screw Depth Gauge	1
899485	Tap, 4.5mm	1
899486	Tap, 5.0mm	1
899496	Tap, 6.4mm	1
899493	Drill Sleeve 6.4	2
899494	Drill Bit, 6.4mm	1
899495	Stopper, 6.4mm	1
899487	Screwdriver for Locking Screw	1
899488	Screwdriver for Locking Screw, Long	1



Neogen Nail Basic Instruments Set

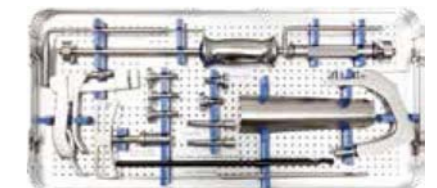
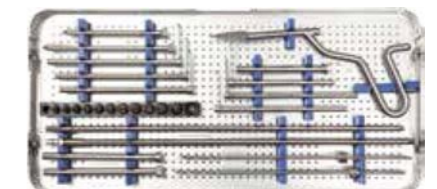
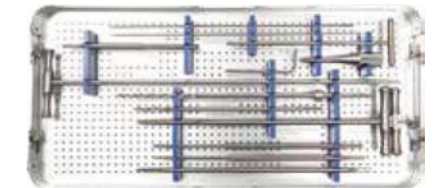

## NeoGen Nails System

### NeoGen Nails System

Code	Product Description	Qty.
899503	Proximal Bolt	2
899504	Distal Bolt	3
899505	Bolt Wrench, SW5.0	1
899506	Trochar Sleeve (Position Rod)	1
899507	Trochar (Position Rod)	1
899508	Drill Sleeve 5.2 (Position Rod)	1
899509	Drill Bit, 5.2mm (Position Rod)	1
899510	Position Rod Drill (Position Rod)	1
899511	Trocar Sleeve for Locking Screw	2
899512	Trocar for Locking Screw	1
899513	Drill Sleeve 4.0	1
899514	Drill Sleeve 4.3	1
899515	Drill Bit, 4.0mm	2
899516	Stopper, 4.0mm	1
899517	Drill Bit, 4.3mm	2
899518	Stopper, 4.3mm	1
899519	Replacement Rod	1
899462	Entry Inner Trochar (Femur)	1
899463	Entry Drill Sleeve (Femur)	1
899465	Entry Reamer (Femur)	1
899466	Stopper, 7mm	2
899520	Proximal Aiming Bar (Femur)	1
899521	Distal Aiming Bar (Femur)	1
899522	Targeter (Femur)	1
899523	Position Rod	1
899524	E Block 10/9 (Femur)	1
899525	E Block 12/11 (Femur)	1
898127	Entry Inner Trochar (Knee)	1
898128	Entry Drill Sleeve (Knee)	1
898122	Entry Reamer (Knee)	1
899526	Proximal Aiming Bar (Knee), Left	1
899527	Proximal Aiming Bar (Knee), Right	1
899531	Proximal Aiming Device (Knee)	1
899528	Distal Aiming Bar (Knee)	1
899529	Targeter (Knee)	1
899530	Position Rod (Knee)	1
899532	E Block 9/8(Knee)	1
899533	E Block 11.5/10 (Knee)	1



Neogen Nail Special Instruments Set

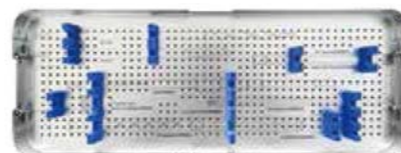
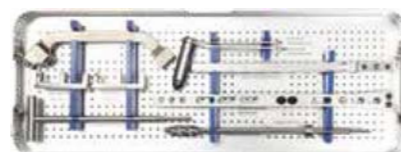
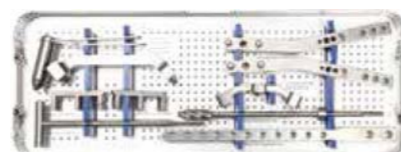
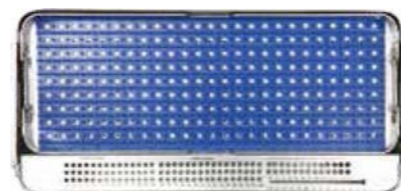

## NeoGen Nails System

### NeoGen Nails System

#### Optional

Code	Product Description
899535	Aiming Bar(GAMMA)
266141	Drill Bit(GAMMA)
899536	Outer Drill Sleeve(GAMMA)
899537	Drill Sleeve(GAMMA)
899538	Guide Bolt(GAMMA)
266110	Reamer(GAMMA)
266150	Screwdriver(GAMMA)
266160	Coupling Screw(GAMMA)
266170	Tap(GAMMA)
899534	T-handle with quick coupling(GAMMA)
898195	NeoGen Nail Special Instruments Set Gamma Tray
898381	Awl
898382	Radiographic Ruler
251620	Joint Screwdriver for End Cap

#### Implant Case

Code	Product Description
898371	NeoGen Femoral Nails implant case
898372	NeoGen Tibia Nails implant case
98702	NeoGen Femoral nail Implant case (Paragon)
98701	NeoGen Tibia nail Implant case (Paragon)

## NeoGen Nails System

### NeoGen Nails System













#### NeoGen Nail Instrument

 <b>899461</b> Awl	 <b>899464</b> Tissue Protector	 <b>899467</b> L-Hex Wrench, SW3 for Stopper $\phi$ 7mm
 <b>899469</b> Reducer	 <b>899470</b> Ball Tip Guide Wire	 <b>251170</b> Guide Wire Holder
 <b>050013</b> Hex Reamer Shaft-Dual Direction	 <b>899472</b> Hex Reamer Shaft-Mono Direction	 <b>050085</b> Reamer, $\phi$ 8.5mm
 <b>050090</b> Reamer, $\phi$ 9mm	 <b>050095</b> Reamer, $\phi$ 9.5mm	 <b>050100</b> Reamer, $\phi$ 10mm

## NeoGen Nails System

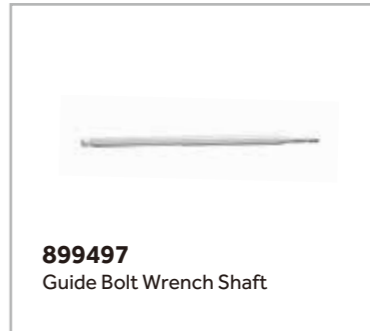
### NeoGen Nails System

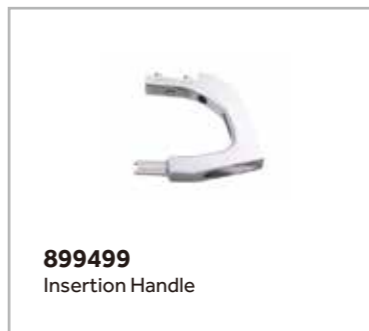









#### NeoGen Nail Instrument

 <b>050105</b> Reamer, $\phi$ 10.5mm	 <b>050110</b> Reamer, $\phi$ 11mm	 <b>050115</b> Reamer, $\phi$ 11.5mm
 <b>050120</b> Reamer, $\phi$ 12mm	 <b>050125</b> Reamer, $\phi$ 12.5mm	 <b>050130</b> Reamer, $\phi$ 13mm
 <b>050135</b> Reamer, $\phi$ 13.5mm	 <b>899468</b> T-Handle with Quick Coupling	 <b>899497</b> Guide Bolt Wrench Shaft
 <b>899498</b> Extractor	 <b>899499</b> Insertion Handle	 <b>899500</b> Guide Bolt

## NeoGen Nails System

### NeoGen Nails System













#### NeoGen Nail Instrument

 <b>899502</b> Impactor	 <b>899489</b> Guide Wire Sleeve 2.5	 <b>899490</b> Guide Wire, φ2.5mm
 <b>899491</b> Guide Wire with Threaded Tip, φ2.5mm	 <b>899492</b> Direct Measuring Device for Guide Wires	 <b>899484</b> Screw Depth Gauge
 <b>899485</b> Tap, φ4.5mm	 <b>899486</b> Tap, φ5.0mm	 <b>899496</b> Tap, φ6.4mm
 <b>899493</b> Drill Sleeve 6.4	 <b>899494</b> Drill Bit, φ6.4mm	 <b>899495</b> Stopper, φ6.4mm

## NeoGen Nails System

### NeoGen Nails System

#### NeoGen Nail Instrument

 <b>899487</b> Screwdriver for Locking Screw	 <b>899488</b> Screwdriver for Locking Screw, Long	 <b>899503</b> Proximal Bolt
 <b>899504</b> Distal Bolt	 <b>899505</b> Bolt Wrench, SW5.0	 <b>899506</b> Trochar Sleeve (Position Rod)
 <b>899507</b> Trochar (Position Rod)	 <b>899508</b> Drill Sleeve 5.2 (Position Rod)	 <b>899509</b> Drill Bit, φ5.2mm (Position Rod)
 <b>899510</b> Position Rod Drill (Position Rod)	 <b>899511</b> Trocar Sleeve for Locking Screw	 <b>899512</b> Trocar for Locking Screw



## NeoGen Nails System

### NeoGen Nails System

#### NeoGen Nail Instrument

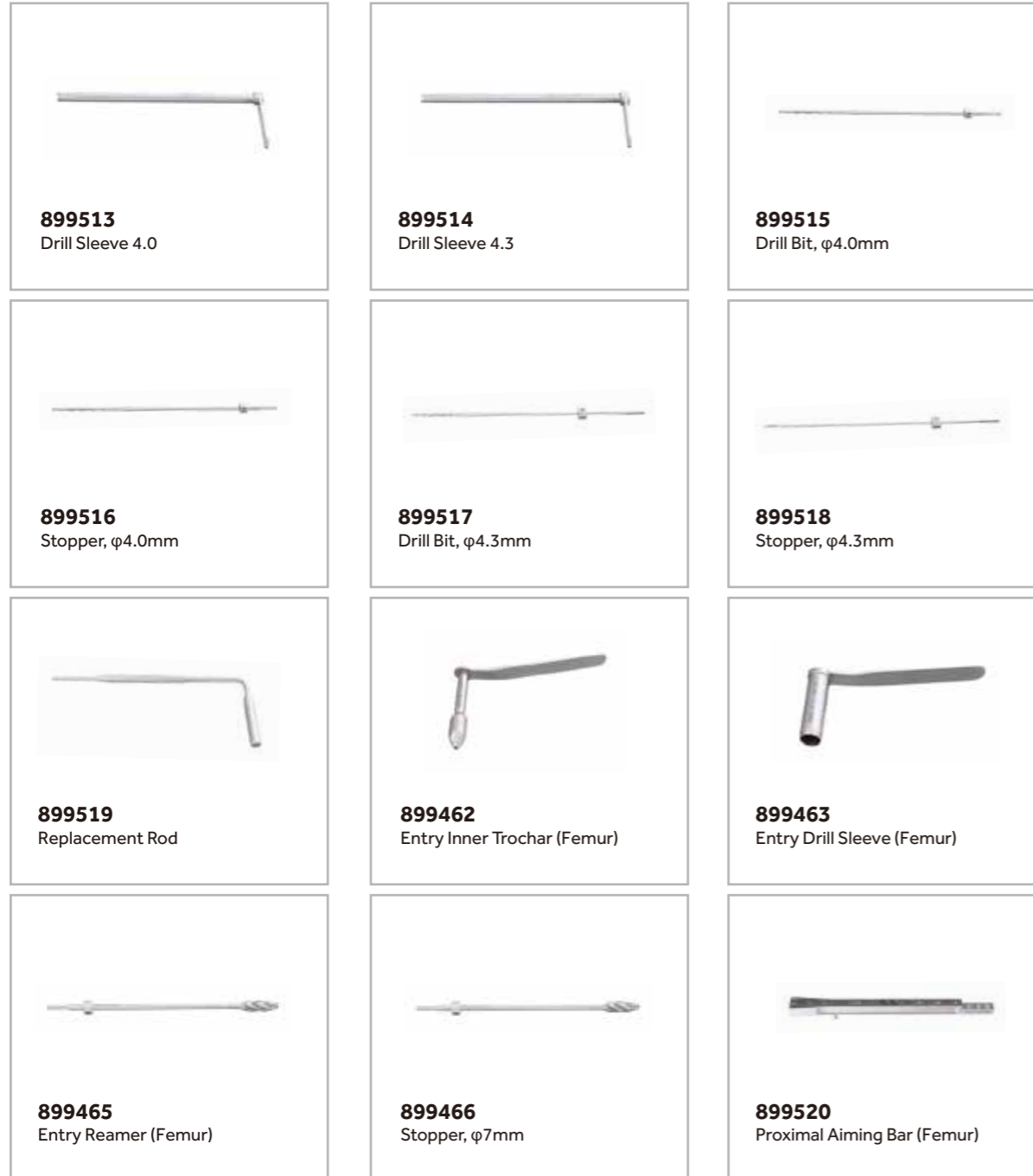

## NeoGen Nails System

### NeoGen Nails System

#### NeoGen Nail Instrument



## NeoGen Nails System

### NeoGen Nails System

#### NeoGen Nail Instrument



## NeoGen Nails System

### NeoGen Nails System

#### NeoGen Nail Instrument



# NeoGen AR Nails System



# NeoGen AR Nails System

## NeoGen AR Nails System

### NeoGen AR Nail



Code	Model No.	Size
32805017	JGD VI	9.3x170
32805020	JGD VI	9.3x200
32805024	JGD VI	9.3x240
32803017	JGD VI	10x170
32803020	JGD VI	10x200
32803024	JGD VI	10x240



Code	Model No.	Direction	Size
32820232	JGD VI	Left	9.5x320mm
32820234	JGD VI	Left	9.5x340mm
32820236	JGD VI	Left	9.5x360mm
32820238	JGD VI	Left	9.5x380mm
32820240	JGD VI	Left	9.5x400mm
32820242	JGD VI	Left	9.5x420mm
32820244	JGD VI	Left	9.5x440mm
32821232	JGD VI	Left	10x320mm
32821234	JGD VI	Left	10x340mm
32821236	JGD VI	Left	10x360mm
32821238	JGD VI	Left	10x380mm
32821240	JGD VI	Left	10x400mm
32821242	JGD VI	Left	10x420mm
32821244	JGD VI	Left	10x440mm
32820132	JGD VI	Right	9.5x320mm
32820134	JGD VI	Right	9.5x340mm
32820136	JGD VI	Right	9.5x360mm
32820138	JGD VI	Right	9.5x380mm
32820140	JGD VI	Right	9.5x400mm
32820142	JGD VI	Right	9.5x420mm
32820144	JGD VI	Right	9.5x440mm
32821132	JGD VI	Right	10x320mm
32821134	JGD VI	Right	10x340mm
32821136	JGD VI	Right	10x360mm
32821138	JGD VI	Right	10x380mm
32821140	JGD VI	Right	10x400mm
32821142	JGD VI	Right	10x420mm
32821144	JGD VI	Right	10x440mm

Prox (mm)	16.5
Material	TA

Code	Model No.	Size
32804017	JGD VI	11x170
32804020	JGD VI	11x200
32804024	JGD VI	11x240
39591117	JGD VI	12x170
39591120	JGD VI	12x200
39591124	JGD VI	12x240

Prox (mm)	16.5
Material	TA

Code	Model No.	Direction	Size
32822232	JGD VI	Left	11x320mm
32822234	JGD VI	Left	11x340mm
32822236	JGD VI	Left	11x360mm
32822238	JGD VI	Left	11x380mm
32822240	JGD VI	Left	11x400mm
32822242	JGD VI	Left	11x420mm
32822244	JGD VI	Left	11x440mm
32823232	JGD VI	Left	12x320mm
32823234	JGD VI	Left	12x340mm
32823236	JGD VI	Left	12x360mm
32823238	JGD VI	Left	12x380mm
32823240	JGD VI	Left	12x400mm
32823242	JGD VI	Left	12x420mm
32823244	JGD VI	Left	12x440mm
32822132	JGD VI	Right	11x320mm
32822134	JGD VI	Right	11x340mm
32822136	JGD VI	Right	11x360mm
32822138	JGD VI	Right	11x380mm
32822140	JGD VI	Right	11x400mm
32822142	JGD VI	Right	11x420mm
32822144	JGD VI	Right	11x440mm
32823132	JGD VI	Right	12x320mm
32823134	JGD VI	Right	12x340mm
32823136	JGD VI	Right	12x360mm
32823138	JGD VI	Right	12x380mm
32823140	JGD VI	Right	12x400mm
32823142	JGD VI	Right	12x420mm
32823144	JGD VI	Right	12x440mm

# NeoGen AR Nails System

## NeoGen AR Nails System

### NeoGen AR Blade



Cannula (mm)	3.5
Shaft (mm)	10.3
Material	TA

Code	Model No.	Size
32801070	JSD X	10.3x70mm
32801075	JSD X	10.3x75mm
32801080	JSD X	10.3x80mm
32801085	JSD X	10.3x85mm
32801090	JSD X	10.3x90mm
32801091	JSD X	10.3x95mm
32801092	JSD X	10.3x100mm
32801093	JSD X	10.3x105mm
32801094	JSD X	10.3x110mm
32801095	JSD X	10.3x115mm
32801096	JSD X	10.3x120mm

### NeoGen Locking Screws



Core (mm)	4.3
Material	TA

Code	Model No.	Size
33112025	JSD VII	5.0x26mm
33112030	JSD VII	5.0x30mm
33112035	JSD VII	5.0x35mm
33112040	JSD VII	5.0x40mm
33112045	JSD VII	5.0x45mm
33112050	JSD VII	5.0x50mm
33112055	JSD VII	5.0x55mm
33112060	JSD VII	5.0x60mm
33112065	JSD VII	5.0x65mm
33112070	JSD VII	5.0x70mm
33112075	JSD VII	5.0x75mm
33112080	JSD VII	5.0x80mm
33112085	JSD VII	5.0x85mm
33112090	JSD VII	5.0x90mm
33112091	JSD VII	5.0x95mm
33112092	JSD VII	5.0x100mm
33112093	JSD VII	5.0x105mm
33112094	JSD VII	5.0x110mm

### End Caps



Material	TA
----------	----

Code	Model No.	Size
32806000	JGM V	0mm
32806005	JGM V	5mm
32806010	JGM V	10mm
32806015	JGM V	15mm



Core (mm)	4
Material	TA

Code	Model No.	Size
33111025	JSD VII	4.5X26mm
33111030	JSD VII	4.5X30mm
33111035	JSD VII	4.5X35mm
33111040	JSD VII	4.5X40mm
33111045	JSD VII	4.5X45mm
33111050	JSD VII	4.5X50mm
33111055	JSD VII	4.5X55mm
33111060	JSD VII	4.5X60mm
33111065	JSD VII	4.5X65mm
33111070	JSD VII	4.5X70mm
33111075	JSD VII	4.5X75mm
33111080	JSD VII	4.5X80mm
33111085	JSD VII	4.5X85mm
33111090	JSD VII	4.5X90mm

## NeoGen AR Nails System

### NeoGen AR Nails System

#### NeoGen AR Nail Instruments Set

Code	Product Description	Qty.
269900	NeoGen AR Nail Instruments Set	1
898367	NeoGen AR Nail Instruments Set (Empty)-PPSU	1
269920	NeoGen AR Nail Instruments Set Case	1
269930	NeoGen AR Nail Instruments Set Tray 1	1
269940	NeoGen AR Nail Instruments Set Tray 2	1
269950	NeoGen AR Nail Instruments Set Tray 3	1
269960	NeoGen AR Nail Instruments Set Tray 4	1
267120	Insertion Connecting Rod	1
267130	Insertion Connector	1
267140	Bolt for Aiming Arm 130°	1
267150	Protection Sleeve for AR Blade	1
267160	Trocar Sleeve 3.2	1
267170	Trocar, $\phi$ 3.2mm	1
267180	Direct Measuring Device for Guide Wire $\phi$ 3.2mm	1
267190	Outer Sleeve for Distal Locking Screw	2
267200	Drill Sleeve 4.0	2
267210	Trocar, $\phi$ 4.0mm	1
267220	Depth Gauge for Distal Locking Screw	1
267230	Screwdriver for Distal Locking Screw	1
267240	Screwdriver, Hexagonal with Spherical Head	1
267250	Guide Wire with Hook for Cap	1
267260	Screwdriver for Cap, cannulated	1
267270	Extended Rod, Cannulated	1
267290	Cleaning Stylet	1
267300	Extraction Screw for Nail	1
267310	Slotted Hammer	1
267320	Extraction Screw for AR Blade	1
267330	Screwdriver, Hexagonal	1
267340	Drill Bit, $\phi$ 4.0mm	2
267350	Screwdriver for AR Blade	1
267360	Reamer for AR Blade	1
267370	Cannulated Drill Bit for AR Blade	1
267390	Tip Threaded Guide Wire, $\phi$ 3.2 mm	2
267400	Stopper, $\phi$ 10mm	1
267410	Combination Wrench	1
267450	Hammer	1
267460	Buttress Nut	1
267470	Tissue Protector	1
267480	Key for AR Blade	1
267510	Slotted Hammer Guide for AR Blade	1
267520	Radiographic Ruler	1
267530	Cannulated Awl	1

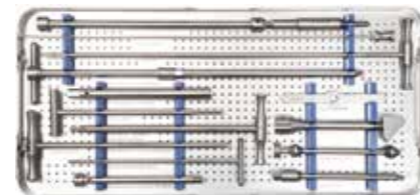

## NeoGen AR Nails System

### NeoGen AR Nails System

Code	Product Description	Qty.
267560	Guide Wire, $\phi$ 3.2 mm	2
269100	Proximal Aiming Bar for Long Nail	1
269110	Distal Aiming Bar for Long Nail	1
269120	Targeter	1
269140	Position Rod Drill, $\phi$ 5.2mm	1
269150	Drill Bit, $\phi$ 5.2mm	1
269160	Trochar Sleeve 8.1	1
269170	Drill Sleeve 5.2	1
269180	Trochar 8.1	1
269190	Ball Tip Guide Wire 2.5	1
269200	Reducer	1
269210	Wrench, SW5 for Bolt	1
269240	Guide Wire Holder	1
269250	Distal Bolt	1
269260	Bolt for Targeter	1
269270	Proximal Bolt	1
269280	Reamer Shaft	2
269290	Reamer, $\phi$ 9mm	1
269300	Reamer, $\phi$ 10mm	1
269310	Reamer, $\phi$ 11mm	1
269320	Reamer, $\phi$ 12mm	1
269330	Reamer, $\phi$ 13mm	1
269340	E Block	1
269350	Position Rod	1
269360	Drill Bit, $\phi$ 4.3mm	2
269370	Drill Sleeve 4.3	2
269380	Wrench for Stopper	1
269390	Stopper, $\phi$ 4.3mm	1
269400	Insertion Handle	1
269410	Aiming Arm 130° for Static Locking	1
269420	Connecting Screw	1
269430	T- Handle with Quick Coupling	1
269440	Aiming Arm 130° for Dynamic Locking	1
269450	Entry Reamer, $\phi$ 17.0mm	1
269460	Protection Sleeve	1
269470	Guide Sleeve 17	1
269480	Replacement Rod	1

#### optional instrument

Code	Product Description
267570	Insertion Handle (Carbon Fiber)
267580	Aiming Arm for Static Locking (Carbon Fiber)
267590	Aiming Arm for Dynamic Locking (Carbon Fiber)
267630	Joint Screwdriver for End Cap
898330	Slotted Hammer (silicon handle)
898331	Screwdriver, Hexagonal (silicon handle)
898332	Hammer (silicon handle)
898438	NeoGen AR Nail Instruments Set (Empty)-PPSU



## NeoGen AR Nails System

### NeoGen AR Nails System

#### Implant Case

Code	Product Description
898377	NeoGen AR Implants case (2 cases)
898379	NeoGen AR Implants case 1 (6 trays)
898380	NeoGen AR Implants case 2 (4 trays)

#### NeoGen AR Nail Instrument

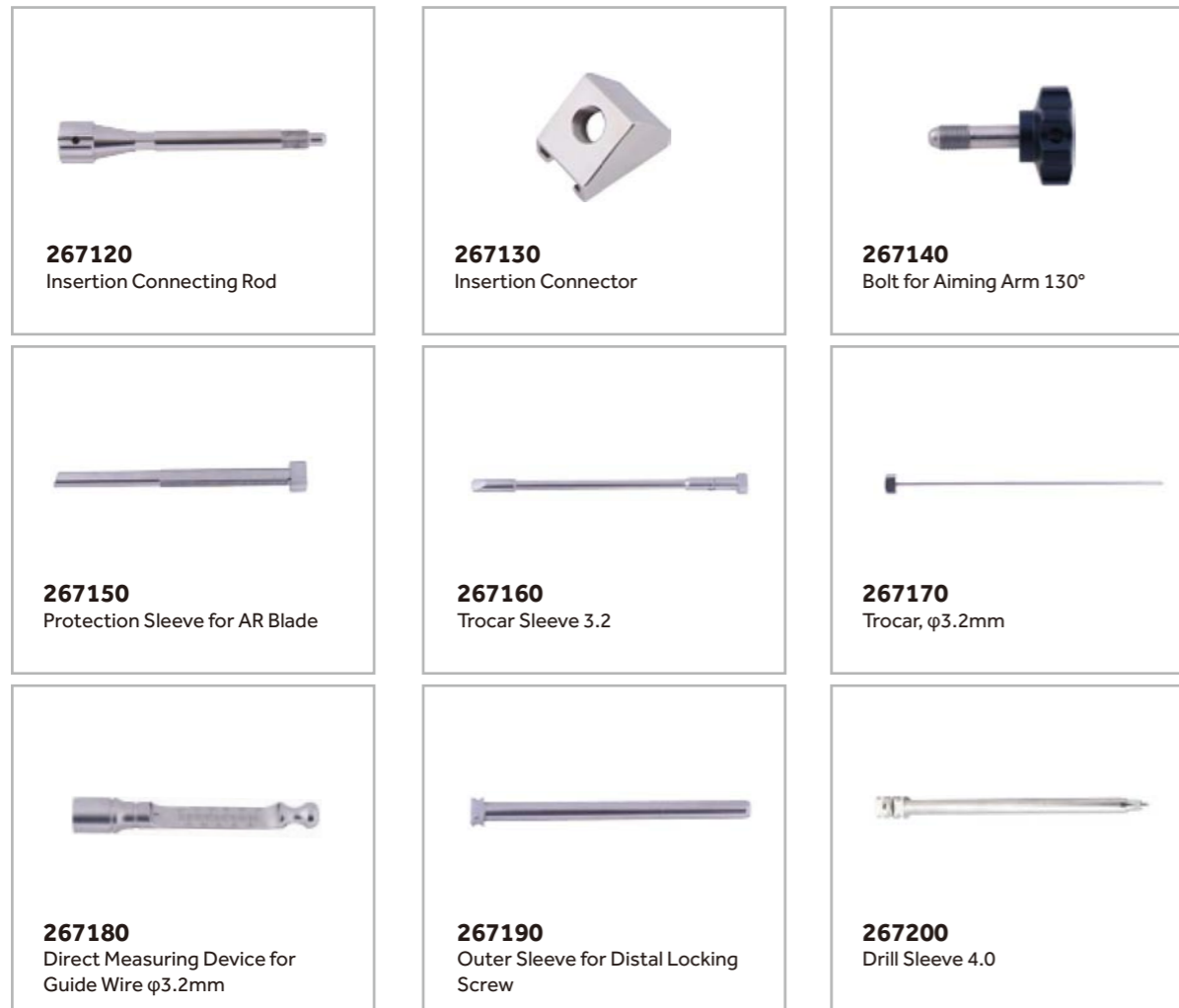

## NeoGen AR Nails System

### NeoGen AR Nails System



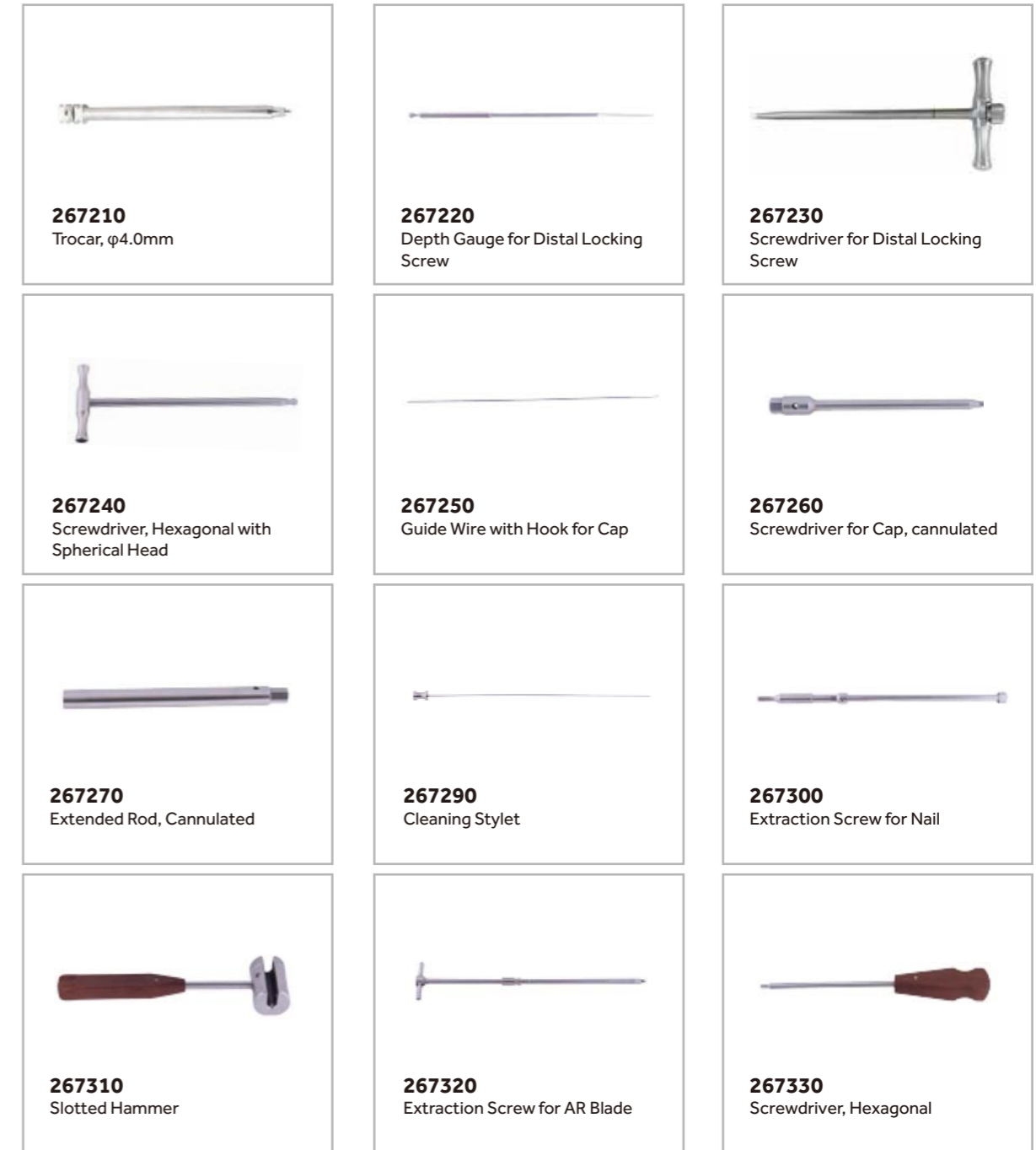





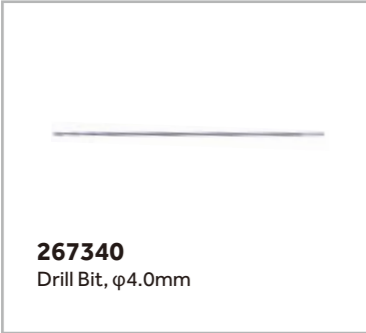

#### NeoGen AR Nail Instrument

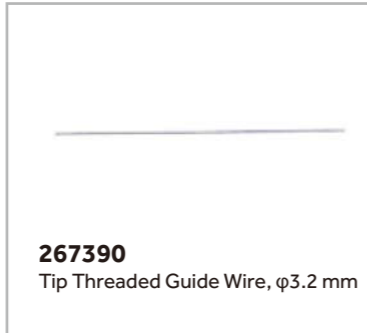

## NeoGen AR Nails System

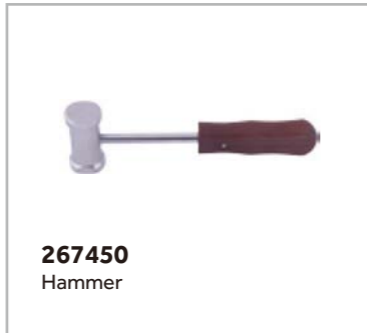
### NeoGen AR Nails System

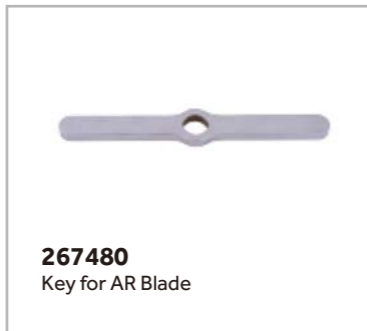







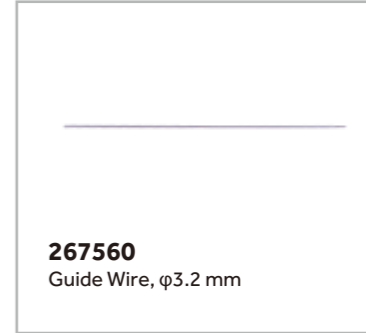
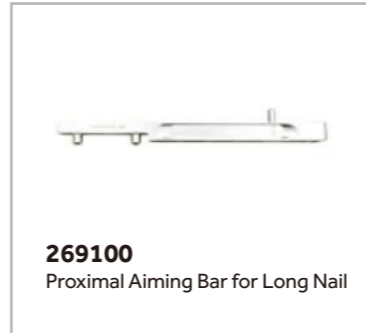

#### NeoGen AR Nail Instrument

 <b>267340</b> Drill Bit, φ4.0mm	 <b>267350</b> Screwdriver for AR Blade	 <b>267360</b> Reamer for AR Blade
 <b>267370</b> Cannulated Drill Bit for AR Blade	 <b>267390</b> Tip Threaded Guide Wire, φ3.2 mm	 <b>267400</b> Stopper, φ10mm
 <b>267410</b> Combination Wrench	 <b>267450</b> Hammer	 <b>267460</b> Buttress Nut
 <b>267470</b> Tissue Protector	 <b>267480</b> Key for AR Blade	 <b>267510</b> Slotted Hammer Guide for AR Blade

## NeoGen AR Nails System

### NeoGen AR Nails System

#### NeoGen AR Nail Instrument

 <b>267520</b> Radiographic Ruler	 <b>267530</b> Cannulated Awl	 <b>267560</b> Guide Wire, φ3.2 mm
 <b>269100</b> Proximal Aiming Bar for Long Nail	 <b>269110</b> Distal Aiming Bar for Long Nail	 <b>269120</b> Targeter
 <b>269140</b> Position Rod Drill, φ5.2mm	 <b>269150</b> Drill Bit, φ5.2mm	 <b>269160</b> Trochar Sleeve 8.1
 <b>269170</b> Drill Sleeve 5.2	 <b>269180</b> Trochar 8.1	 <b>269190</b> Ball Tip Guide Wire 2.5

## NeoGen AR Nails System

### NeoGen AR Nails System

#### NeoGen AR Nail Instrument

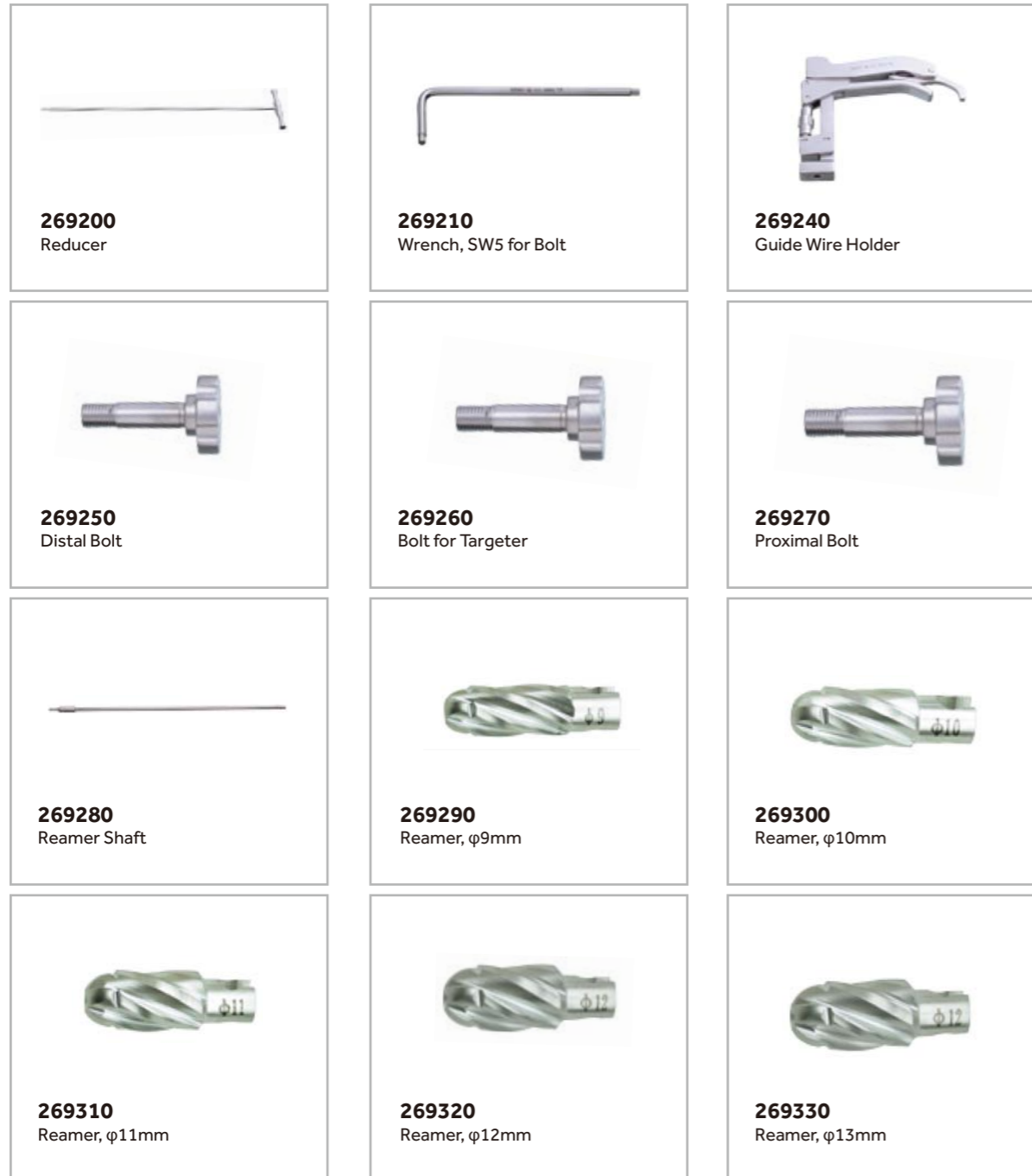

## NeoGen AR Nails System

### NeoGen AR Nails System

#### NeoGen AR Nail Instrument

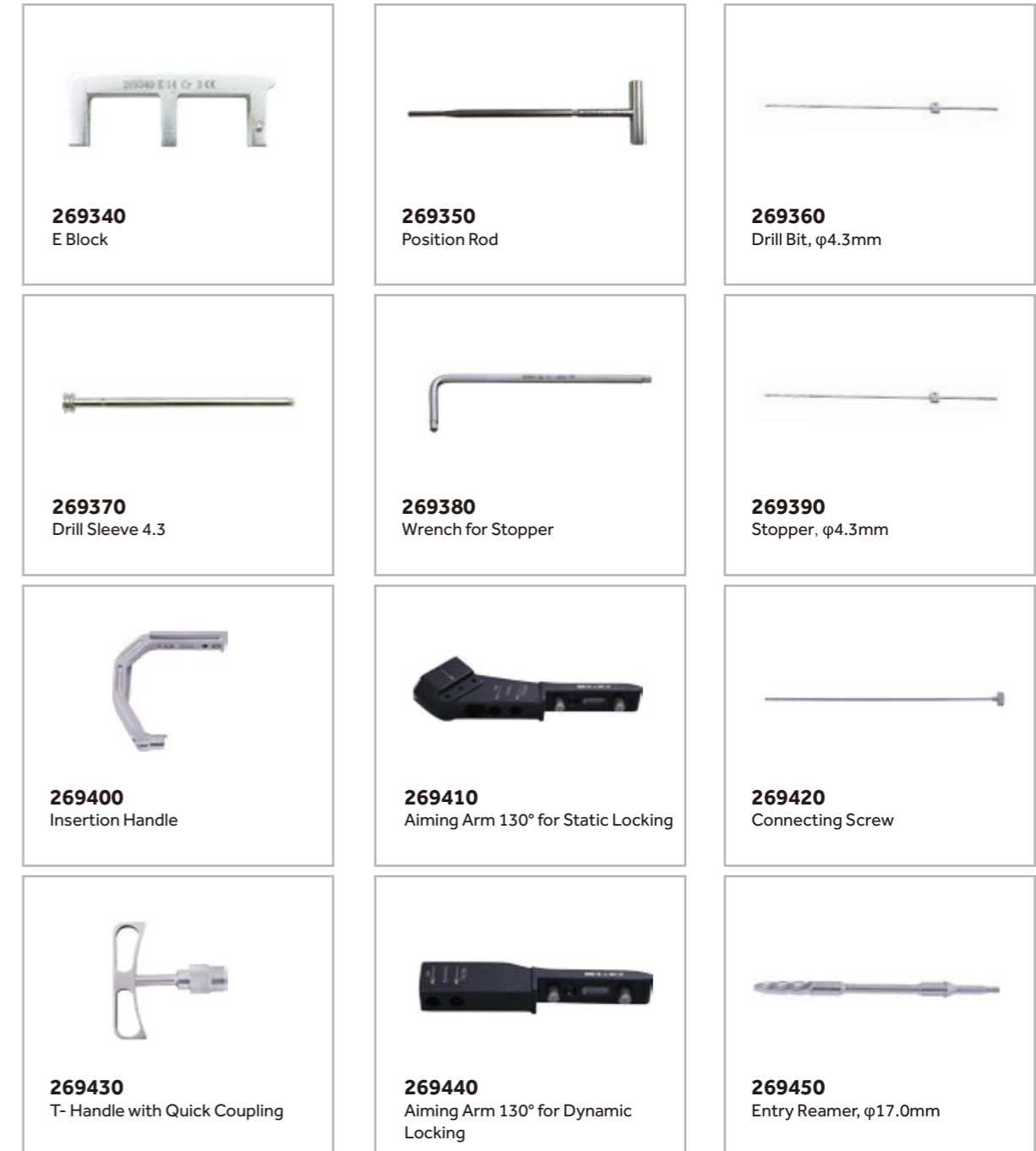

## NeoGen AR Nails System

### NeoGen AR Nails System

#### NeoGen AR Nail Instrument



# External Fixators System

- Modular External Fixator
- OPTIMUS External Fixator

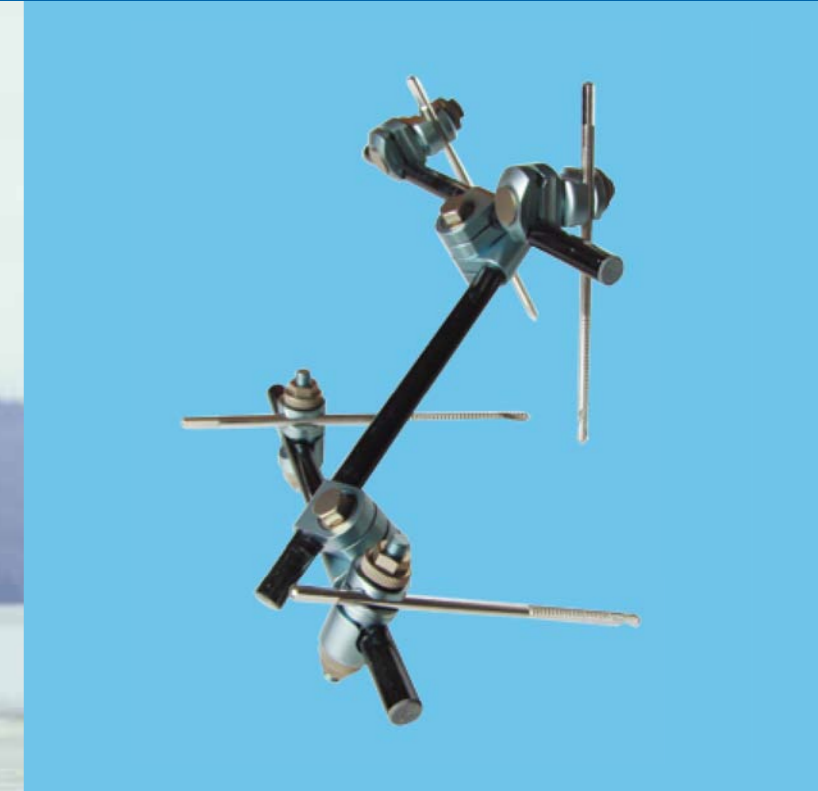

## External Fixator System

### Modular External Fixator System

#### Schanz Screws, self-drilling



Specification		
Material	SS	
Code	Model No.	Size
10742125	GZLW01SJB	φ5×125
10742150	GZLW01SJB	φ5×150
10742175	GZLW01SJB	φ5×175
10742200	GZLW01SJB	φ5×200

#### Combination Clamp, Clip-on, self-holding (large)



Specification		
Material	TA	
Code	Model No.	Size
521110	WGD-ZHX-II-05	φ11

#### Rod-to-Rod Clamp (large)



Specification		
Material	TA	
Code	Model No.	Size
521130	WGD-ZHX-II-06	φ11

#### Protective Caps



Specification		
Material	Silicon	
Code	Model No.	Size
521230	WGD-ZHX-II-08	φ11×27mm
521240	WGD-ZHX-II-08	φ5×27mm

#### Schanz Screws



Specification		
Material	SS	
Code	Model No.	Size
10744125	GZLW08SJB	φ5×125
10744150	GZLW08SJB	φ5×150
10744175	GZLW08SJB	φ5×175
10744200	GZLW08SJB	φ5×200

#### Clamp, Clip-on, self-holding (large)



Specification		
Material	TA	
Code	Model No.	Size
521120	WGD-ZHX-II-03	φ11

#### Connecting Rods



Specification		
Material	Carbon Fiber	
Code	Model No.	Size
521140	WGD-ZHX-II-01	φ11×100mm
521150	WGD-ZHX-II-01	φ11×125mm
521160	WGD-ZHX-II-01	φ11×150mm
521170	WGD-ZHX-II-01	φ11×200mm
521180	WGD-ZHX-II-01	φ11×250mm
521190	WGD-ZHX-II-01	φ11×300mm
521200	WGD-ZHX-II-01	φ11×350mm
521210	WGD-ZHX-II-01	φ11×400mm



## External Fixator System

### Modular External Fixator System

#### Schanz Screws, self-drilling



Specification		
Material	SS	
Code	Model No.	Size
10741100	GZLW01SJB	φ4×100
10741125	GZLW01SJB	φ4×125
10741150	GZLW01SJB	φ4×150

#### Combination Clamp, Clip-on, self-holding (medium)



Specification		
Material	TA	
Code	Model No.	Size
521330	WGD-ZHX-II-05	φ8

#### Rod-to-Rod Clamp (medium)



Specification		
Material	TA	
Code	Model No.	Size
521310	WGD-ZHX-II-06	φ8

#### Protective Caps



Specification		
Material	Silicon	
Code	Model No.	Size
521430	WGD-ZHX-II-08	φ8×27mm
521440	WGD-ZHX-II-08	φ4×27mm

#### Schanz Screws



Specification		
Material	SS	
Code	Model No.	Size
10743125	GZLW08SJB	φ4×125
10743150	GZLW08SJB	φ4×150

#### Clamp, Clip-on, self-holding (medium)



Specification		
Material	TA	
Code	Model No.	Size
521320	WGD-ZHX-II-03	φ8

#### Connecting Rods



Specification		
Material	Carbon Fiber	
Code	Model No.	Size
521340	WGD-ZHX-II-01	φ8×120mm
521350	WGD-ZHX-II-01	φ8×160mm
521360	WGD-ZHX-II-01	φ8×200mm
521370	WGD-ZHX-II-01	φ8×220mm
521380	WGD-ZHX-II-01	φ8×240mm
521390	WGD-ZHX-II-01	φ8×280mm
521400	WGD-ZHX-II-01	φ8×320mm
521410	WGD-ZHX-II-01	φ8×360mm
521420	WGD-ZHX-II-01	φ8×400mm

## External Fixator System

### Modular External Fixator System

#### Schanz Screw, self-drilling



Specification		
Material	SS	
Code	Model No.	Size
10740065	GZLW01SJB	φ3×65
10740080	GZLW01SJB	φ3×80
10739080	GZLW01SJB	φ2.5×80

#### Combination Clamp, Clip-on, self-holding (small)



Specification		
Material	TA	
Code	Model No.	Size
521530	WGD-ZHX-II-05	φ4

#### Clamp, Clip-on, self-holding (small)



Specification		
Material	TA	
Code	Model No.	Size
521510	WGD-ZHX-II-03	φ4

#### Protective Caps



Specification		
Material	Silicon	
Code	Model No.	Size
521620	WGD-ZHX-II-08	φ2.5×27mm
521440	WGD-ZHX-II-08	φ4×27mm

#### K-wire



Specification		
Material	SS	
Code	Model No.	Size
10735150	GZZh01YA	φ1.8×150
10705150	GZZh01YA	φ2.0×150
10727150	GZLW02YA	φ2.5×150

#### Rod-to-Rod Clamp (small)



Specification		
Material	TA	
Code	Model No.	Size
521520	WGD-ZHX-II-06	φ4

#### Connecting Rods



Specification		
Material	Carbon Fiber	
Code	Model No.	Size
521540	WGD-ZHX-II-01	φ4×60mm
521550	WGD-ZHX-II-01	φ4×80mm
521560	WGD-ZHX-II-01	φ4×100mm
521570	WGD-ZHX-II-01	φ4×120mm
521580	WGD-ZHX-II-01	φ4×140mm
521590	WGD-ZHX-II-01	φ4×160mm
521600	WGD-ZHX-II-01	φ4×180mm
521610	WGD-ZHX-II-01	φ4×200mm

## External Fixator System

### Modular External Fixator System

#### Clamp Holder



Material		
SS		
Code	Model No.	Size
521710	WGD-ZHX-II-03	1.25
521720	WGD-ZHX-II-03	1.6

#### Angular Connecting Rods



Material	
SS	
Code	Model No.
521740	WGD-ZHX-II

#### K-wire, threaded

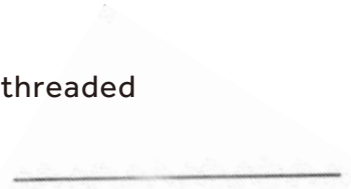

Material		
SS		
Code	Model No.	Size
10736100	GZLW02YA	1.2×100
10726100	GZLW02YA	1.6×100

#### Connecting Clamp



Material		
SS		
Code	Model No.	Size
521730	WGD-ZHX-II-05	3

#### Connecting Rods



Material		
Carbon Fiber		
Code	Model No.	Size
521750	WGD-ZHX-II-01	3×25
521760	WGD-ZHX-II-01	3×45
521770	WGD-ZHX-II-01	3×60
521780	WGD-ZHX-II-01	3×75

## External Fixator System

### Modular External Fixator System

#### External Fixator (Large) Instruments Set

Code	Product Description	Qty.
522900	External Fixator (Large) Instruments Set	
898364	External Fixator (Large) Instruments Set (Empty)-PPSU	1
522100	Combination Wrench, SW11	1
522110	Ratchet Wrench, SW11	1
522120	T-Wrench, SW11	1
522140	T-Clip	1
522150	Trocar 3.5, short	1
522160	Drill Sleeve 5.0/3.5, short	1
522170	Drill Sleeve 6.0/5.0, threaded, short	1
522190	Trocar 3.5, long	1
522200	Drill Sleeve 5.0/3.5, long	1
522210	Drill Sleeve 6.0/5.0, threaded, long	1
522220	Drill Bit, 3.5mm	1
98211	Handle for Drill Sleeve	1

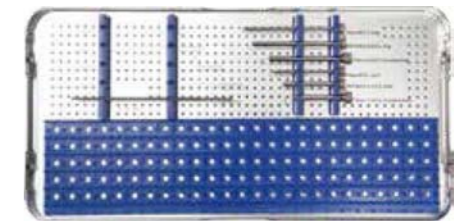
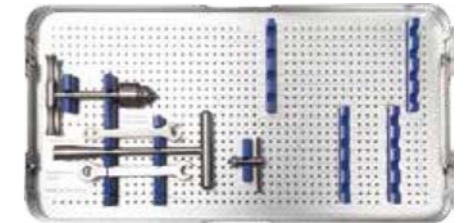

#### External Fixator (Large) Instrument



## External Fixator System

### Modular External Fixator System

#### External Fixator (Large) Instrument



## External Fixator System

### Modular External Fixator System

#### External Fixator (Medium) Instruments Set

Code	Product Description	Qty.
523900	External Fixator (Medium) Instruments Set	
898365	External Fixator (Medium) Instruments Set (Empty)-PPSU	1
523100	Combination Wrench, SW8	1
523110	T-Wrench, SW8	1
522140	T-Clip	1
523120	Trocar, 2.5mm	1
523130	Drill Sleeve 4.0/2.5	1
523140	Drill Sleeve 4.0, with Thread	1
523150	Drill Bit, 2.0mm	1
522220	Drill Bit, 3.5mm	1
98211	Handle for Drill Sleeve	1

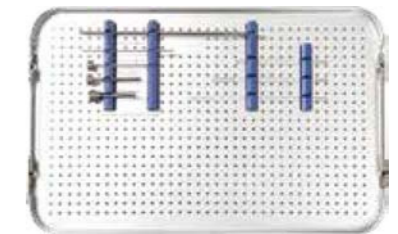
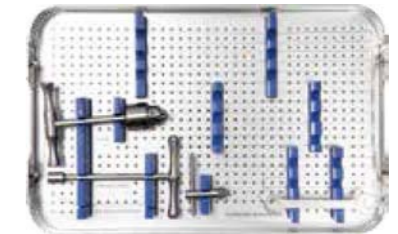

#### External Fixator (Medium) Instrument



## External Fixator System

### Modular External Fixator System

#### External Fixator (Medium) Instrument



## External Fixator System

### Modular External Fixator System

#### External Fixator (Small+Mini) Instruments Set

Code	Product Description	Qty.
524900	External Fixator (Small+Mini) Instruments Set	
898366	External Fixator (Small+Mini) Instruments Set (Empty)-PPSU	1
524100	Drill Sleeve 4.0/2.6	1
524110	Trocar, 2.6mm	1
522140	T-Clip	1
524120	T-Wrench, SW7	1
524130	Combination Wrench, SW7	1
523150	Drill Bit, 2.0mm	1
524140	Drill Bit, 1.8mm	1
525100	Holder	1
525120	Combination Wrench, SW5.5	1
525130	Hex Wrench, SW5.5	1
525140	Double Drill Guide 1.6/1.2	1
98125	External Fixator (Small) Instruments Set (Empty)	1
98126	External Fixator (Mini) Instruments Set (Empty)	1
898190	Hex Wrench, SW5.5 (silicon handle)	1

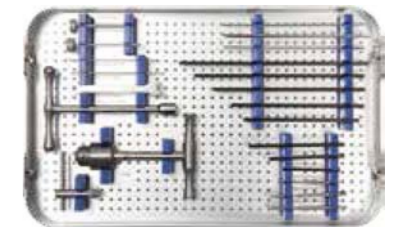
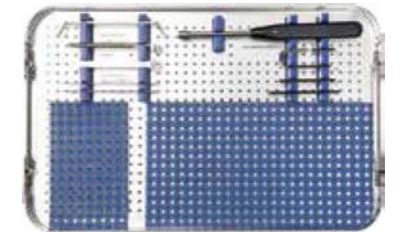

Implant Case

There is space in the instrument case for implants.









#### External Fixator (Small+Mini) Instruments Set



## External Fixator System

### Modular External Fixator System

#### External Fixator (Small+Mini) Instruments Set

 <b>524120</b> T-Wrench, SW7	 <b>524130</b> Combination Wrench, SW7	 <b>523150</b> Drill Bit, φ2.0mm
 <b>524140</b> Drill Bit, φ1.8mm	 <b>525100</b> Holder	 <b>525120</b> Combination Wrench, SW5.5
 <b>525130</b> Hex Wrench, SW5.5	 <b>525140</b> Double Drill Guide 1.6/1.2	

## External Fixator System

### OPTIMUS External Fixator System

#### Ring Fixator for Trauma

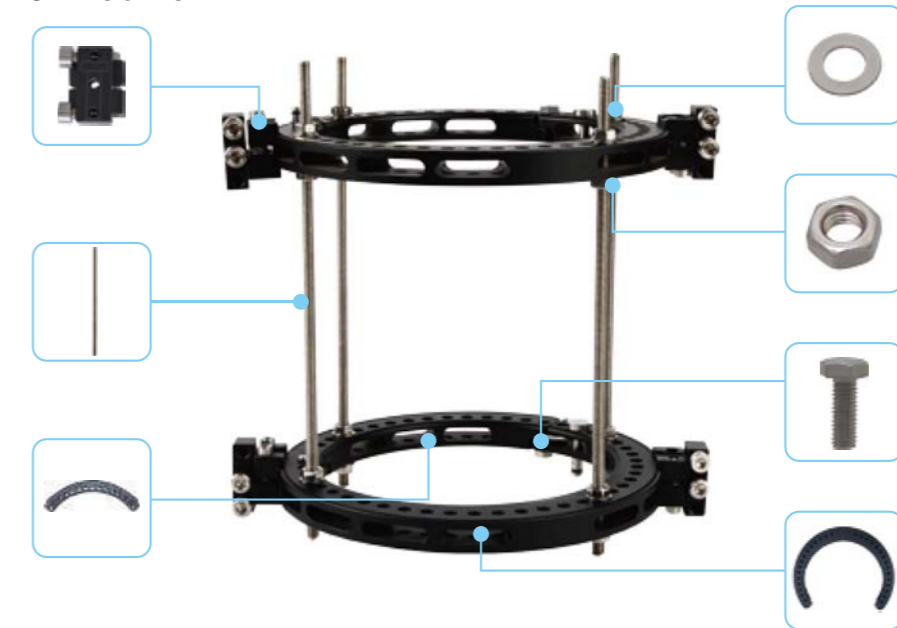

#### I- 1/4 Ring

Material	Magal		
Code	Model No.	Size	
541110	WGD-HX-I-04	120	
541120	WGD-HX-I-04	150	
541130	WGD-HX-I-04	175	
541140	WGD-HX-I-04	190	
541150	WGD-HX-I-04	220	

#### II- 3/4 Ring

Material	Magal		
Code	Model No.	Material	Size
541160	WGD-HX-I-02	Magal	120
541170	WGD-HX-I-02	Magal	150
541180	WGD-HX-I-02	Magal	175
541190	WGD-HX-I-02	Magal	190
541200	WGD-HX-I-02	Magal	220

#### III- Threaded Bar

Material	SS		
Code	Model No.	Size	
541210	WGD-HX-I-05	6x200	

#### IV- Three-hole Wire Clamp

Material	Magal		
Code	Model No.	Size	
541220	WGD-HX-I-13	40	

#### V- Ring Locking Screw

Material	SS		
Code	Model No.	Size	
541240	WGD-HX-I-11	6	

#### VI- Nut

Material	SS		
Code	Model No.	Size	
541250	WGD-HX-I-09	5	

#### VII- Wash

Material	SS		
Code	Model No.	Size	
541260	WGD-HX-I-10		

#### Kirschner Wires

Material	SS		
Code	Model No.	Size	
10754350	GZB01YA	2×350	



## External Fixator System

### OPTIMUS External Fixator System

#### Full Ring Fixator

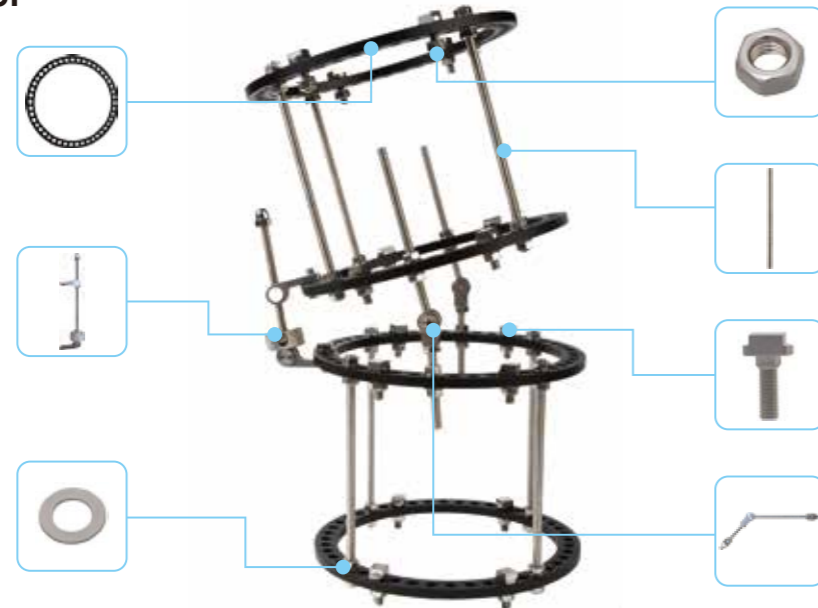

#### I- Full Ring

Material	Magal	
Code	Model No.	Size
542110	WGD-HX-I-01	100
542120	WGD-HX-I-01	120
542130	WGD-HX-I-01	140
542140	WGD-HX-I-01	160
542150	WGD-HX-I-01	180
542160	WGD-HX-I-01	200
542170	WGD-HX-I-01	220
542180	WGD-HX-I-01	240

#### II- Threaded Bar

Material	SS	
Code	Model No.	Size
542190	WGD-HX-I-05	6x110

#### III- Nut

Material	Magal		
Code	Model No.	Material	Size
541250	WGD-HX-I-09	SS	5

#### IV- Wash

Material	SS	
Code	Model No.	Size
541260	WGD-HX-I-10	7

#### V- Hinge Assembly

Material	SS	
Code	Model No.	Size
542200	WGD-HX-I-12	10

#### VI- Angular Distractor

Material	SS	
Code	Model No.	Size
542210	WGD-HX-I-14	10

#### VII- Universal wire Fixation bolt

Material	SS	
Code	Model No.	Size
541220	WGD-HX-I-08	10

#### Kirschner Wires

Material	SS	
Code	Model No.	Size
10754350	GZB01YA	2x350

## External Fixator System

### OPTIMUS External Fixator System

#### Micro movement Fixator



Material	Magal		
Code	Specification	Model No.	Size
544110	Long	WGD-ZX-I	18x390
544120	Standard	WGD-ZX-I	18x310
544130	Short	WGD-ZX-I	18x270
544140	Pediatric	WGD-ZX-I	12x220

#### Micro movement Fixator with T-clamp



Material	Magal		
Code	Specification	Model No.	Size
545110	Long	WGD-ZX-II	18x350
545120	Standard	WGD-ZX-II	18x270
545130	Short	WGD-ZX-II	18x230

#### Micro Movement Fixator with GT-clamp



Material	Magal		
Code	Specification	Model No.	Size
546110	Long	WGD-ZX-II	18x355
546120	Medium	WGD-ZX-II	18x275
546130	Short	WGD-ZX-II	18x235

#### Pre-drilled Cortical Screws



Material	SS	
Code	Model No.	Size
10752100	GZLW04BA	6x100
10752110	GZLW04BA	6x110
10752120	GZLW04BA	6x120
10752130	GZLW04BA	6x130
10752150	GZLW04BA	6x150
10752170	GZLW04BA	6x170
10752180	GZLW04BA	6x180
10752200	GZLW04BA	6x200
10756080	GZLW05BA	4.5x80
10756100	GZLW05BA	4.5x100
10756120	GZLW05BA	4.5x120

#### Self-Drilling Cortical Screws



Material	SS	
Code	Model No.	Size
10755150	GZLW05BA	6x150
10755160	GZLW05BA	6x160
10755210	GZLW05BA	6x210
10755220	GZLW05BA	6x220
10755230	GZLW05BA	6x230
10755250	GZLW05BA	6x250

#### Pre-drilled Cortical Screws



Material	SS	
Code	Model No.	Size
10751070	GZLW04BA	4x70
10751080	GZLW04BA	4x70

#### Wrist Fixator



Material	Magal	
Code	Model No.	Size
547110	WGD-ZX-IV	12x220

#### Self-drilling Cortical Screws



Material	SS	
Code	Model No.	Size
10753100	GZLW02YB	2x100

## External Fixator System

### OPTIMUS External Fixator System

#### OPTIMUS External Fixator Instruments Set

Code	Product Description	Qty.
549000	OPTIMUS External Fixator Instrument Set	1
549010	OPTIMUS External Fixator Instrument Case	1
549110	Allen Wrench 6mm	2
549120	Allen Wrench 5mm	2
549130	Allen Wrench 3mm	2
549140	T-Wrench 6	2
549150	T-Wrench 4	2
549170	Screw Guide 60mm	4
549200	Drill Guide 4.8	1
549210	Drill Guide 3.2	1
549220	Tapered Trocar, 195	1
549240	Tapered Trocar for Wrist	1
549250	Drill Bit 4.8mm	2
549260	Drill Bit 3.2mm	2
549270	Drill Bit 2.0mm	2
549280	Drill Guide for 2.0 Drill Bit	2
549290	Drill Guide for Wrist	1
549300	Wire Tensioner	1
549310		2

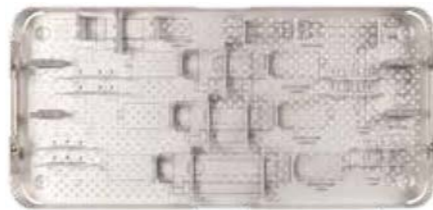
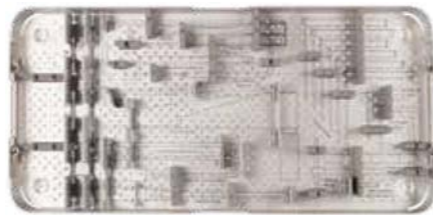

Implant Case  
There is space in the instrument case for implants.

#### Optional Instrument

Code	Product Description	Qty.
549160	Screw Guide 80mm	4
549180	Screw Guide 100mm	4
549190	Screw Guide 240mm	4
549230	Tapered Trocar, 240	1

## External Fixator System

### OPTIMUS External Fixator System

#### OPTIMUS External Fixator Instrument

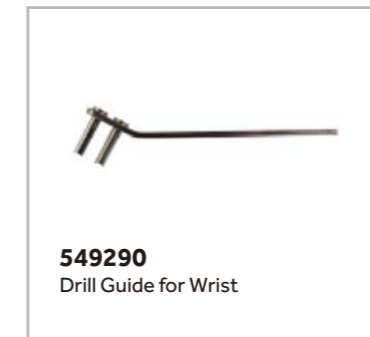
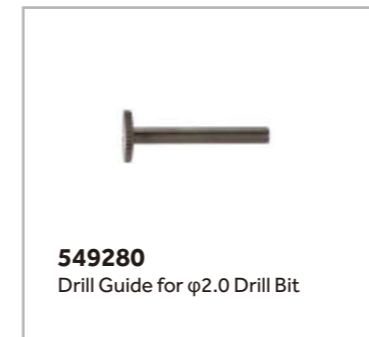
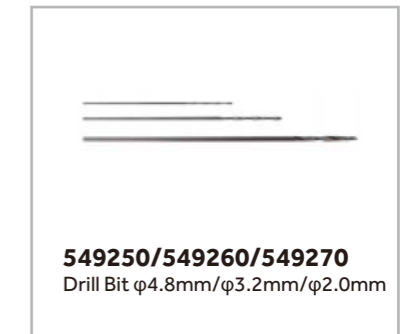
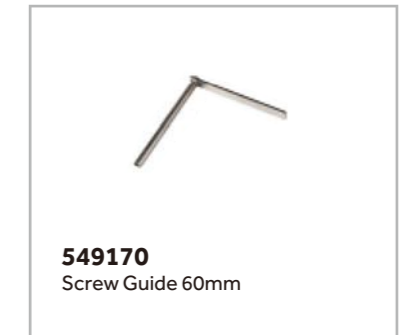

# Wires & Pins

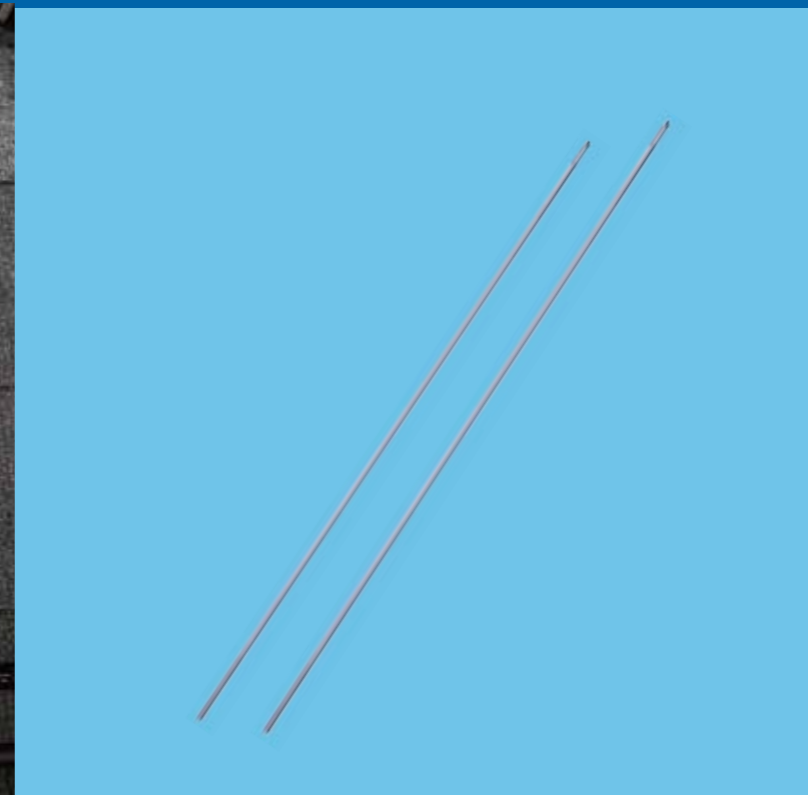
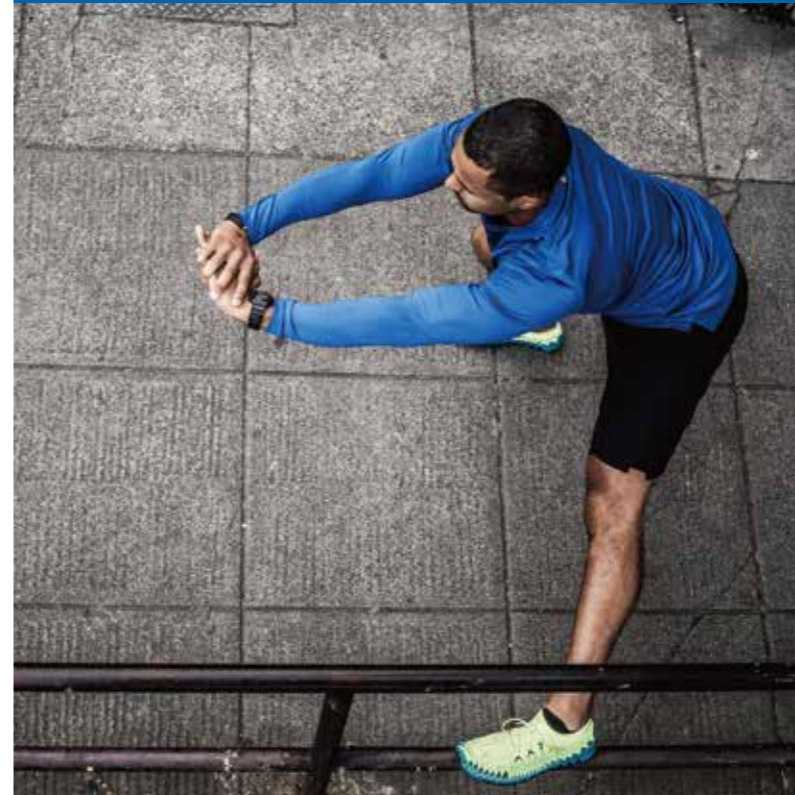

## Wires & Pins

### Wires & Pins

#### Trocar K wires



Code	Model No.	Size
10701070	GZZh01YA	0.8×70
10701110	GZZh01YA	0.8×110
10701120	GZZh01YA	0.8×120
10701300	GZZh01YA	0.8×300
10702120	GZZh01YA	1.0×120
10702150	GZZh01YA	1.0×150
10702250	GZZh01YA	1.0×250
10702300	GZZh01YA	1.0×300
10703120	GZZh01YA	1.2×120
10703150	GZZh01YA	1.2×150
10703200	GZZh01YA	1.2×200
10703250	GZZh01YA	1.2×250
10704100	GZZh01YA	1.5×100
10704120	GZZh01YA	1.5×120
10704150	GZZh01YA	1.5×150
10704200	GZZh01YA	1.5×200
10704220	GZZh01YA	1.5×220

Specification		
Material	SS	

Code	Model No.	Size
10704250	GZZh01YA	1.5×250
10704300	GZZh01YA	1.5×300
10705150	GZZh01YA	2.0×150
10705180	GZZh01YA	2.0×180
10705200	GZZh01YA	2.0×200
10705250	GZZh01YA	2.0×250
10705300	GZZh01YA	2.0×300
10706150	GZZh01YA	2.5×150
10706200	GZZh01YA	2.5×200
10706250	GZZh01YA	2.5×250
10706280	GZZh01YA	2.5×280
10706300	GZZh01YA	2.5×300
10707250	GZZh01YA	3.0×250
10707300	GZZh01YA	3.0×300
10708300	GZZh01YA	3.5×300
10709250	GZZh01YA	4.0×250
10709300	GZZh01YA	4.0×300
10710300	GZZh01YA	4.5×300

#### Threaded pin



Specification		
Material	SS	

Code	Model No.	Size
10726180	GZLW02YA	1.6×180
10727230	GZLW02YA	2.5×230
10727280	GZLW02YA	2.5×280
10727300	GZLW02YA	2.5×300

# Cranial Maxillofacial Plates System

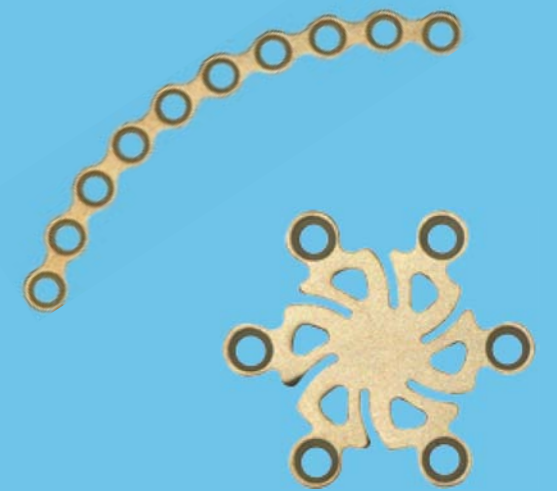
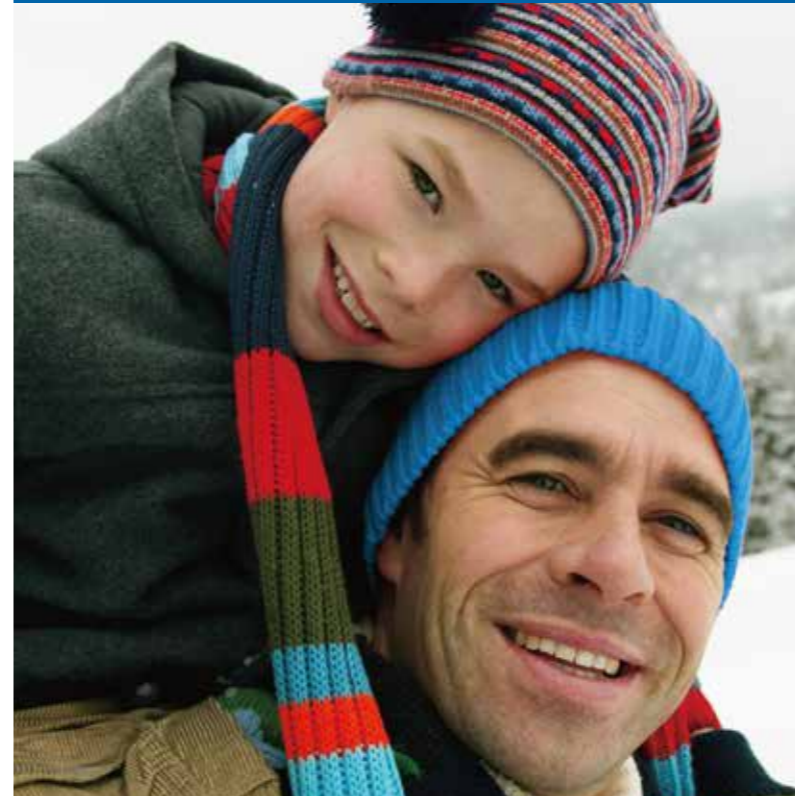



# Cranial Maxillofacial Plates System

## Cranial Maxillofacial Plates System

Straight Plates, 0.6mm thickness



Specification	
Thickness (mm)	0.6
Width (mm)	3.6
Material	PT

Code	Model No.	Size	Length (mm)
23201004	ZEZ03	4H	15.6
23201006	ZEZ03	6H	23.6
23201018	ZEZ03	18H	68

Straight Plates, 0.6mm thickness, with stem



Specification	
Thickness (mm)	0.6
Width (mm)	3.6
Material	PT

Code	Model No.	Size	Length (mm)
23202002	ZEZ04	2H	14.6
23202004	ZEZ02	4H	22.6
23202006	ZEZ01	6H	30.6

L-Plate, 0.6mm thickness, with stem



Specification	
Thickness (mm)	0.6
Width (mm)	3.6
Material	PT

Code	Model No.	Size	Direction	Length (mm)
23204205	YEZ25	5H	Left	17.3
23204105	YEZ24	5H	Right	17.3

Double Y-Plate, 0.6mm thickness, with stem



Specification	
Thickness (mm)	0.6
Width (mm)	10.1
Material	PT

Code	Model No.	Size	Length (mm)
23206006	YEZ34	6H	15.1

## Cranial Maxillofacial Plates System

### Cranial Maxillofacial Plates System

#### 1.5mm Mesh Plates, 0.6mm thickness

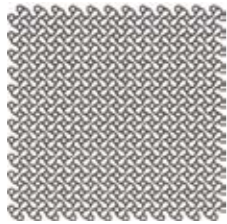

Specification	
Thickness (mm)	0.6
Material	PT

Code	Model No.	Size	Length (mm)
23208040	YEZ57	45×55mm	54
23208070	YEZ57	70×80mm	79
23208100	YEZ57	105×105mm	105

#### 1.5mm Screws, self drilling



Specification	
Material	TA

Code	Model No.	Size
30364004	CEQ01	4mm
30364005	CEQ01	5mm
30364006	CEQ01	6mm
30364008	CEQ01	8mm

#### 1.7mm Revision Screws, self tapping



Specification	
Material	TA

Code	Model No.	Size
30371004	CEQ01	4mm
30371005	CEQ01	5mm
30371006	CEQ01	6mm
30371008	CEQ01	8mm

#### 1.5mm Mesh Plates, 0.4mm thickness

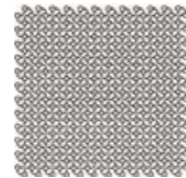

Specification				
Thickness (mm)				0.4
Material				PT

Code	Model No.	Size	Width (mm)	Length (mm)
23209040	YEZ57	45×55mm	46	54
23209100	YEZ57	105×105mm	105	105

#### 1.5mm Screws, self tapping



Specification	
Material	TA

Code	Model No.	Size
30365004	CEQ01	4mm
30365005	CEQ01	5mm
30365006	CEQ01	6mm
30365008	CEQ01	8mm

## Cranial Maxillofacial Plates System

### Cranial Maxillofacial Plates System

#### Straight Plates, 1.0mm thickness



Specification	
Thickness (mm)	1
Width (mm)	4.5
Material	PT

Code	Model No.	Size	Length (mm)
23211004	ZEZ03	4H	22.5
23211006	ZEZ03	6H	34.5
23211018	ZEZ03	18H	106.5

#### L-Plates, 1.0mm thickness, with stem



Specification	
Thickness (mm)	1
Width (mm)	4.5
Material	PT

Code	Model No.	Size	Direction	Length (mm)
23213205	YEZ25	5H	Left	27
23213105	YEZ24	5H	Right	27

#### Straight Plates, 1.0mm thickness, with stem



Specification	
Thickness (mm)	1
Material	PT

Code	Model No.	Size	Length (mm)
23212002	ZEZ04	2H	15.5
23212004	ZEZ02	4H	27.5
23212006	ZEZ01	6H	39.5

#### Double Y-Plates, 1.0mm thickness, with stem



Specification	
Thickness (mm)	1
Width (mm)	11.5
Material	PT

Code	Model No.	Size	Length (mm)
23215006	YEZ34	6H	28.5

# Cranial Maxillofacial Plates System

## Cranial Maxillofacial Plates System

### 2.0mm Mesh Plates, 1.0mm thickness

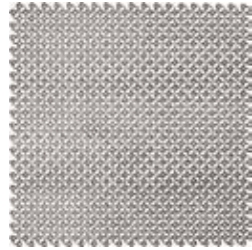

Specification	
Thickness (mm)	1
Material	PT

Code	Model No.	Size	Length (mm)
23217060	YEZ57	60×80mm	79
23217100	YEZ57	100×100mm	100
23217120	YEZ57	120×120mm	121
23217150	YEZ57	150×150mm	153
23217200	YEZ57	205×205mm	206

### 2.0mm Screws, self tapping



Specification	
Material	TA

Code	Model No.	Size
30367006	CEQ01	6mm
30367008	CEQ01	8mm
30367010	CEQ01	10mm
30367012	CEQ01	12mm

### Straight Mandible Reconstruction Plates, 2.5mm thickness



Specification	
Thickness (mm)	2.5
Width (mm)	8
Material	PT

Code	Model No.	Size	Length (mm)
23223008	ZEZ08	8H	64
23223012	ZEZ08	12H	96
23223024	ZEZ08	24H	192

### 2.0mm Screws, self drilling



Specification		
Material		TA

Code	Model No.	Size
30366006	CEQ01	6mm
30366008	CEQ01	8mm
30366010	CEQ01	10mm
30366012	CEQ01	12mm

### 2.4mm Revision Screws, self tapping



Specification	
Material	TA

Code	Model No.	Size
30372006	CEQ01	6mm
30372008	CEQ01	8mm
30372010	CEQ01	10mm
30372012	CEQ01	12mm

# Cranial Maxillofacial Plates System

## Cranial Maxillofacial Plates System

### Mandible Reconstruction L-Plates, 2.5mm thickness



Specification	
Thickness (mm)	2.5
Width (mm)	8
Material	PT

Code	Model No.	Size	Size	Length (mm)
23224210	YEZ23	5+10H	Left	107.4
23224214	YEZ23	6+14H	Left	143.4
23224218	YEZ23	6+18H	Left	175.4
23224110	YEZ22	5+10H	Right	107.4
23224114	YEZ22	6+14H	Right	143.4
23224118	YEZ22	6+18H	Right	175.4

### 2.4mm Mandible Screws, self drilling



Specification	
Material	TA

Code	Model No.	Size
30370006	CEQ01	6mm
30370008	CEQ01	8mm
30370010	CEQ01	10mm
30370012	CEQ01	12mm
30370014	CEQ01	14mm
30370016	CEQ01	16mm

### 2.4mm Mandible Screws, self tapping



Specification		
Material		TA

Code	Model No.	Size
30369006	CEQ01	6mm
30369008	CEQ01	8mm
30369010	CEQ01	10mm
30369012	CEQ01	12mm
30369014	CEQ01	14mm
30369016	CEQ01	16mm

### 2.7mm Mandible Revision Screws



Specification	
Material	TA

Code	Model No.	Size
30373006	CEQ01	6mm
30373008	CEQ01	8mm
30373010	CEQ01	10mm
30373012	CEQ01	12mm
30373014	CEQ01	14mm
30373016	CEQ01	16mm

## Cranial Maxillofacial Plates System

### Cranial Maxillofacial Plates System

#### Cranial Maxillofacial Plates Instruments Set

Code	Product Description	Qty.
217900	Cranial Maxillofacial Plates System Instruments Set	
898341	Cranial Maxillofacial Plates System Instruments Set (Empty) -PPSU	1
216100	Handle, with Mini Quick Coupling	2
217490	Bending-Cutting Pliers	1
217500	Universal Pliers, pointed, for Plates 1.0 to 2.0 (left)	1
217510	Universal Pliers, pointed, for Plates 1.0 to 2.0 (right)	1
217100	Double Drill Sleeve 1.8/1.5	1
217110	Double Drill Sleeve 1.5/1.1	1
217530	Holding Forceps for Cortex Screws 1.0 to 2.0mm	1
216160	Holding Forceps for Plates 1.0 to 2.0	1
216170	Depth Guage	1
216180	Plate Holding Instruments, for Plates 1.5	1
216190	Plate Holding Instruments, for Plates 2.0	1
217201	Implants Case, 1.5mm (Empty)	1
216310	Drill Bit 1.1mm with Stop, Drilling Depth 4mm	1
216320	Drill Bit 1.1mm with Stop, Drilling Depth 6mm	1
216330	Drill Bit 1.1mm with Stop, Drilling Depth 8mm	1
216360	Screwdriver Shaft, length 80mm	2
216370	Drill Bit 1.1mm with Stop, Drilling Depth 80mm	1
217301	Implants Case, 2.0mm (Empty)	1
217310	Drill Bit 1.5mm with Stop, Drilling Depth 6mm	1
217320	Drill Bit 1.5mm with Stop, Drilling Depth 8mm	1
217330	Drill Bit 1.5mm with Stop, Drilling Depth 12mm	1
217340	Drill Bit 1.5mm with Stop, Drilling Depth 85mm	1
216360	Screwdriver Shafts, length 80mm	2
217401	Implants Case, 2.4mm (Empty)	1
217410	Drill Bit 1.8mm with Stop, Drilling Depth 12mm	1
217420	Drill Bit 1.8mm with Stop, Drilling Depth 100mm	1
217430	Screwdriver Shaft, 2.4mm, length 80mm	2
217440	Tap, 2.4mm	1
217520	Mesh Plate Cutter	1
216210	3D Mesh Plate Shaper	1
217120	Bending Irons for Reconstruction Plates	2

## Cranial Maxillofacial Plates System

### Cranial Maxillofacial Plates System

#### Cranial Maxillofacial Plates Instrument

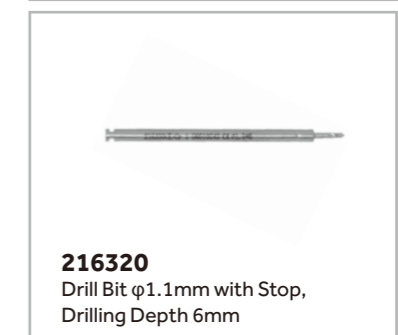
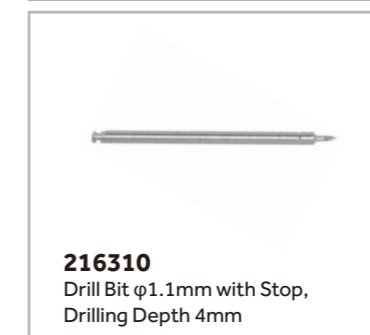
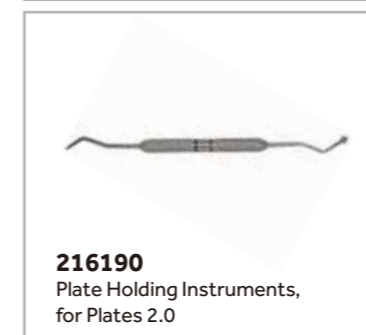
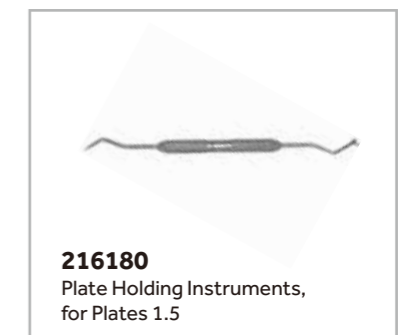
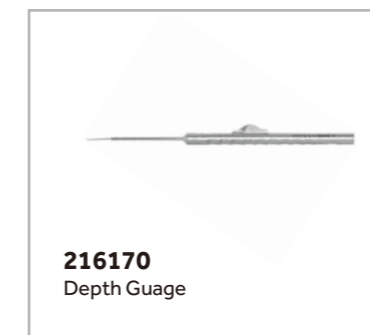
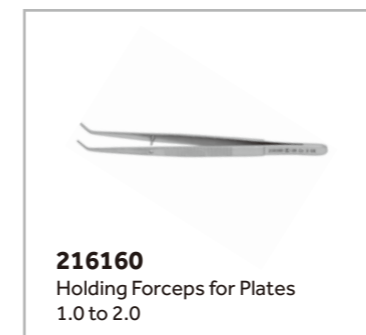
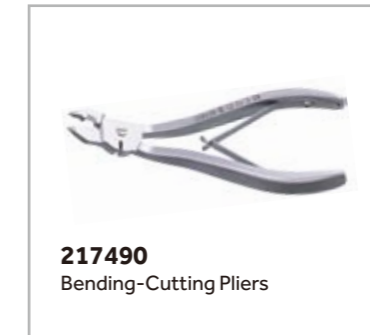

## Cranial Maxillofacial Plates System

### Cranial Maxillofacial Plates System

#### Cranial Maxillofacial Plates Instrument

 <p><b>216330</b> Drill Bit <math>\phi</math>1.1mm with Stop, Drilling Depth 8mm</p>	 <p><b>216360</b> Screwdriver Shaft, length 80mm</p>	 <p><b>216370</b> Drill Bit <math>\phi</math>1.1mm with Stop, Drilling Depth 80mm</p>
 <p><b>217310</b> Drill Bit <math>\phi</math>1.5mm with Stop, Drilling Depth 6mm</p>	 <p><b>217320</b> Drill Bit <math>\phi</math>1.5mm with Stop, Drilling Depth 8mm</p>	 <p><b>217330</b> Drill Bit <math>\phi</math>1.5mm with Stop, Drilling Depth 12mm</p>
 <p><b>217340</b> Drill Bit <math>\phi</math>1.5mm with Stop, Drilling Depth 85mm</p>	 <p><b>216360</b> Screwdriver Shafts, length 80mm</p>	 <p><b>217410</b> Drill Bit <math>\phi</math>1.8mm with Stop, Drilling Depth 12mm</p>
 <p><b>217420</b> Drill Bit <math>\phi</math>1.8mm with Stop, Drilling Depth 100mm</p>	 <p><b>217430</b> Screwdriver Shaft, <math>\phi</math>2.4mm, length 80mm</p>	 <p><b>217440</b> Tap, <math>\phi</math>2.4mm</p>

## Cranial Maxillofacial Plates System

### Cranial Maxillofacial Plates System

#### Cranial Maxillofacial Plates Instrument

 <p><b>217520</b> Mesh Plate Cutter</p>	 <p><b>216210</b> 3D Mesh Plate Shaper</p>	 <p><b>217120</b> Bending Irons for Reconstruction Plates</p>
--	---	--