

Report Number: MIC-ASR236147

Audit Date : 06 Mar., 2023

This report is issued by Focus Technology Co., Ltd. (Made-in-China.com) and the supervising inspectorate (TÜV Rheinland) to confirm that:

Company Name : Hejian Bihaijiayu Glass Products Co., Ltd.
河间市碧海佳玉玻璃制品有限公司

Showroom : <https://hbbhjy.en.made-in-china.com>

Address : Shicun Development Zone, Hejian City, Cangzhou City, Hebei Province, China

Product : Glass Water Pipe, Glass Smoking Pipe, Smoking Set, Glass Teapot, Glass Cup, Glass Cruet Set, Glasswares, Double Wall Glass Cup, Glass Beer Mugs, Glass Bong, Glass Jar

has been on site audited for the Following Scope of Activity

1. General Information
2. Foreign Trade Capacity
3. Product Research & Development Capacity
4. Production Capacity & Quality Control
5. Working Environment
6. Energy Saving and Emission Reduction
7. Photos



General Comments:

Hejian Bihaijiayu Glass Products Co., Ltd. established in 2014 and located in Shicun Development Zone, Hejian City, Cangzhou City, Hebei Province, China. The company engaged in the production and sales Glass Water Pipe, Glass Smoking Pipe, Smoking Set, Glass Teapot, Glass Cup, Glass Cruet Set, Glasswares, Double Wall Glass Cup, Glass Beer Mugs, Glass Bong, Glass Jar, the company has successful foreign trading experience in North America, South America, Europe, East Asia(Japan/ South Korea), Australia, Africa and Southeast Asia/ Mideast markets.

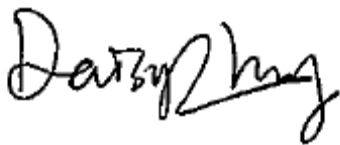

Sign for and on behalf of
TÜV Rheinland

This report only presents the documents, files and information which collected from audited enterprise of TÜV Rheinland Group, not including the subjective analysis of the enterprise status, legal advice, any suggestions related to legal issues, any compliance of local/international requirements and product testing compliance. This report reflects our findings for the particular company in concern on the date of our service only and does not discharge or release the factory/sellers/suppliers from their commercial, legal or contractual obligations with buyers in respect of products provided by the factory/sellers/suppliers. Any reader other than the party for which this report has been specifically issued is hereby informed that the General Conditions of Service of TÜV Rheinland contain liability limitation provisions.

Attention: To check the authenticity of testing/inspection report & certificate, please click: <https://www.verified.chn.tuv.com/en/>

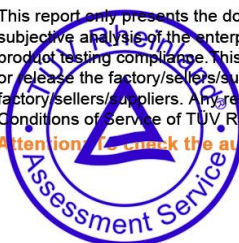

SUPPLIER ASSESSMENT REPORT

Audited Company	Hejian Bihaijiayu Glass Products Co., Ltd.
Audited Site:	Shicun Development Zone, Hejian City, Cangzhou City, Hebei Province, China

Consigner of Assessment	Made-in-China.com		
Audit Type	<input type="checkbox"/> Initial Audit <input checked="" type="checkbox"/> Re-audit		
Audit Date	06 Mar., 2023	Verify Report	https://www.verified.chn.tuv.com/en/
Auditor	Vance Wang	Reviewed by	Lara Lu

CONTENTS

- Part A: General Information**
 - Section 1: Company Overview
 - Section 2: Human Resources
- Part B: Foreign Trade Capacity**
 - Section 1: Export Overall Situation
 - Section 2: Export Business Capacity
 - Section 3: Supplier Management
 - Section 4: After-sales Service Capacity
- Part C: Product Research & Development Capacity**
 - Section 1: Product Research & Development Capacity
- Part D: Management System and Product Certification**
 - Section 1: Management System(s) and Product Certification
- Part E: Production Capacity & Quality Control**
 - Section 1: Production Capacity Section
 - Section 2: Production Process Control
- Part F: Financial Position**
 - Section 1: Financial Data
 - Section 2: Key Performance Indications
 - Section 3: Banking
 - Section 4: Product Insurance
- Part G: Working Environment**
 - Section 1: Working Environment
- Part H: Energy Saving and Emission Reduction**
 - Section 1: Environmental Management
 - Section 2: Water, Gas and Noise Control
- Part I: Industry Information**
 - Section 1: Industry Information
- Part J: Photos**
 - Section 1: Photos of Documents
 - Section 2: Photos of Company

This report only presents the documents, files and information which collected from audited enterprise of TÜV Rheinland Group, not including the subjective analysis of the enterprise status, legal advice, any suggestions related to legal issues, any compliance of local/international requirements and product testing compliance. This report reflects our findings for the particular company in concern on the date of our service only and does not discharge or release the factory/sellers/suppliers from their commercial, legal or contractual obligations with buyers in respect of products provided by the factory/sellers/suppliers. Any reader other than the party for which this report has been specifically issued is hereby informed that the General Conditions of Service of TÜV Rheinland contain liability limitation provisions.

Attention: To check the authenticity of testing/inspection report & certificate, please click: <https://www.verified.chn.tuv.com/en/>

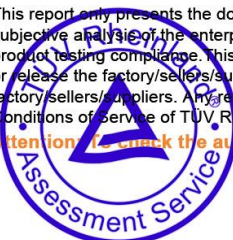

Part A: General Information

Section 1: Company Overview

1.1 Legal Validity			
Does the company have a valid business license?	<input checked="" type="checkbox"/> Yes <input type="checkbox"/> No <input type="checkbox"/> Others	Registration Number	911309843083985028
Year of established	22 Aug., 2014	Valid Date	21 Aug., 2034
Registered address	East side of the road 1.5 km north of the Hejian exit of Baocang Expressway, Dahe Road, Hejian City, Cangzhou City, Hebei Province, China		
Actual address	Shicun Development Zone, Hejian City, Cangzhou City, Hebei Province, China		
Does the company in abnormal operation status list of industrial and commercial bureau?	No		
Registered capital	RMB 500,000		
Name of legal representative	Mr. Qinghua Bai		
Business scope	Production and sales of glass handicrafts, glass household products, glass hookah, glass hookah gun, glass tea set, glass cup, glass coffee set, glass candlestick pendant and the import and export business of the enterprise; Supporting silica gel products, stainless steel products, plastic products sales. (Projects subject to approval according to law can only be operated after being approved by relevant departments)		
1.2 Basic Information			
Contact person	Mr. Qinghua Bai		
Phone number	0086-317-3675000	Fax number	0086-317-3674555
URL/Web address	https://hbbhjy.en.made-in-china.com		
Company type	<input type="checkbox"/> Manufacturer <input type="checkbox"/> Trading Company <input checked="" type="checkbox"/> Combined <input type="checkbox"/> Group Corporation		
Type of ownership	<input checked="" type="checkbox"/> Limited Company <input type="checkbox"/> Public Company <input type="checkbox"/> Foreign joint venture <input type="checkbox"/> State-Owned <input type="checkbox"/> Private Owner <input type="checkbox"/> Wholly foreign-owned enterprises		
Associated company	N/A		
Products manufactured / sold scope	Glass Water Pipe, Glass Smoking Pipe, Smoking Set, Glass Teapot, Glass Cup, Glass Cruet Set, Glasswares, Double Wall Glass Cup, Glass Beer Mugs, Glass Bong, Glass Jar		
1.3 Company Building Information			
According to:			
<input type="checkbox"/> Land certificate <input type="checkbox"/> Real estate certificate <input checked="" type="checkbox"/> Lease agreement <input type="checkbox"/> Observation Estimated on site			
The company area 2,500 square meters			
The land occupies 4,000 square meters.			
The offices occupy 500 square meters.			
The workshops occupy 2,000 square meters.			

This report only presents the documents, files and information which collected from audited enterprise of TÜV Rheinland Group, not including the subjective analysis of the enterprise status, legal advice, any suggestions related to legal issues, any compliance of local/international requirements and product testing compliance. This report reflects our findings for the particular company in concern on the date of our service only and does not discharge or release the factory/sellers/suppliers from their commercial, legal or contractual obligations with buyers in respect of products provided by the factory/sellers/suppliers. Any reader other than the party for which this report has been specifically issued is hereby informed that the General Conditions of Service of TÜV Rheinland contain liability limitation provisions.

Attention: To check the authenticity of testing/inspection report & certificate, please click: <https://www.verified.chn.tuv.com/en/>

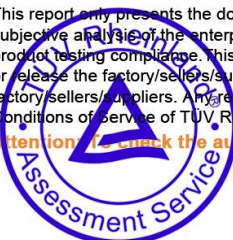

Section 2: Human Resources

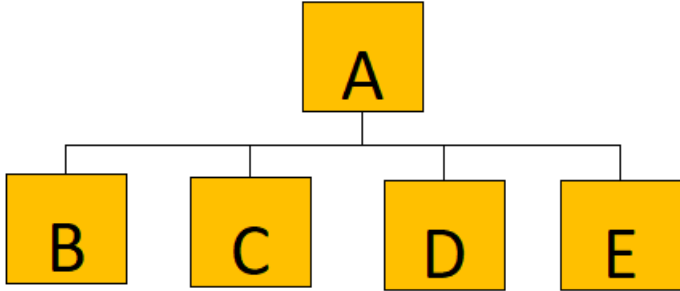
2.1 Company Chart			
 <pre> graph TD A[A] --- B[B] A --- C[C] A --- D[D] A --- E[E] </pre>			
2.2 Explanation of Code and Employee Details			
Code	Department	Number of employees	
A	General Manager	1	
B	Financial Department	2	
C	Sales Department	5	
D	Quality Department	5	
E	Production Department	25	
Number in total:			38
2.3 Key Staff			
Title	Full name	Education	Working experience for this trade / total experience
Sales Manager	Ms. Visha Wei	University	10/10 Years

Remark: Above information of key staff was based on interview with company representative.

This report only presents the documents, files and information which collected from audited enterprise of TÜV Rheinland Group, not including the subjective analysis of the enterprise status, legal advice, any suggestions related to legal issues, any compliance of local/international requirements and product testing compliance. This report reflects our findings for the particular company in concern on the date of our service only and does not discharge or release the factory/sellers/suppliers from their commercial, legal or contractual obligations with buyers in respect of products provided by the factory/sellers/suppliers. Any reader other than the party for which this report has been specifically issued is hereby informed that the General Conditions of Service of TÜV Rheinland contain liability limitation provisions.

Attention: To check the authenticity of testing/inspection report & certificate, please click: <https://www.verified.chn.tuv.com/en/>

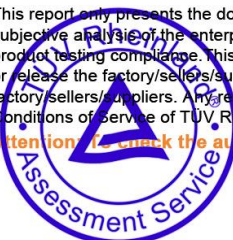

Part B: Foreign Trade Capacity

Section 1: Export Overall Situation

1.1 Export Overall Situation	
Does the company have a valid Import and Export license?	<input type="checkbox"/> Yes <input checked="" type="checkbox"/> No
The import and export enterprise code.	N/A
The number of foreign trading staff with relevant trading experience.	<input type="checkbox"/> within 1 year staff <input type="checkbox"/> 1-5 years staff <input checked="" type="checkbox"/> 6-10 years 4 staffs <input type="checkbox"/> over 10 years staff Total 4 staffs
The language freely used by foreign trade staff	<input checked="" type="checkbox"/> English <input type="checkbox"/> others:
Annual revenue of previous year	Confidential
Annual export revenue of previous year	Confidential
Estimated export revenue for this year.	Confidential
Overseas agent / branch	<input type="checkbox"/> Yes <input checked="" type="checkbox"/> No
Nearest port	Tianjin Port
Acceptable quotation terms	<input checked="" type="checkbox"/> FOB <input type="checkbox"/> CIF <input checked="" type="checkbox"/> CFR Other: DDP
Acceptable payment terms	<input checked="" type="checkbox"/> LC <input checked="" type="checkbox"/> T/T <input type="checkbox"/> D/P <input type="checkbox"/> PayPal <input type="checkbox"/> Western Union <input type="checkbox"/> Small-amount payment
Average lead time (Peak Season)	<input type="checkbox"/> within 15 workday <input checked="" type="checkbox"/> one month <input type="checkbox"/> 2-3 months <input type="checkbox"/> 4-6 months <input type="checkbox"/> 6-12 months <input type="checkbox"/> more time
Average lead time (Off Season)	<input checked="" type="checkbox"/> within 15 workday <input type="checkbox"/> one month <input type="checkbox"/> 2-3 months <input type="checkbox"/> 4-6 months <input type="checkbox"/> 6-12 months <input type="checkbox"/> more time

Section 2: Export Business Capacity

2.1 Market Distribution (please list top three areas)		
Market	Main Product	Main client
<input checked="" type="checkbox"/> North America	Glass Water Pipe, Glass Smoking Pipe, Smoking Set, Glass Teapot, Glass Cup, Glass Cruet Set, Glasswares, Double Wall Glass Cup, Glass Beer Mugs, Glass Bong, Glass Jar	Confidential
<input checked="" type="checkbox"/> South America	Glass Water Pipe, Glass Smoking Pipe, Smoking Set, Glass Teapot, Glass Cup, Glass Cruet Set, Glasswares, Double Wall Glass Cup, Glass Beer Mugs, Glass Bong, Glass Jar	Confidential
<input checked="" type="checkbox"/> Europe	Glass Water Pipe, Glass Smoking Pipe, Smoking Set, Glass Teapot, Glass Cup, Glass Cruet Set, Glasswares, Double Wall Glass Cup, Glass Beer Mugs, Glass Bong, Glass Jar	Confidential
<input checked="" type="checkbox"/> Southeast Asia/ Mideast	Glass Water Pipe, Glass Smoking Pipe, Smoking Set, Glass Teapot, Glass Cup, Glass Cruet Set, Glasswares, Double Wall Glass Cup, Glass Beer Mugs, Glass Bong, Glass Jar	Confidential
<input checked="" type="checkbox"/> Africa	Glass Water Pipe, Glass Smoking Pipe, Smoking Set, Glass Teapot, Glass Cup, Glass Cruet Set, Glasswares, Double Wall Glass Cup, Glass Beer Mugs, Glass Bong, Glass Jar	Confidential

This report only presents the documents, files and information which collected from audited enterprise of TÜV Rheinland Group, not including the subjective analysis of the enterprise status, legal advice, any suggestions related to legal issues, any compliance of local/international requirements and product testing compliance. This report reflects our findings for the particular company in concern on the date of our service only and does not discharge or release the factory/sellers/suppliers from their commercial, legal or contractual obligations with buyers in respect of products provided by the factory/sellers/suppliers. Any reader other than the party for which this report has been specifically issued is hereby informed that the General Conditions of Service of TÜV Rheinland contain liability limitation provisions.

Attention: To check the authenticity of testing/inspection report & certificate, please click: <https://www.verified.chn.tuv.com/en/>

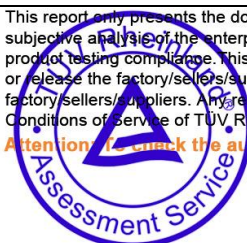

<input checked="" type="checkbox"/> East Asia (Japan/ South Korea)	Glass Water Pipe, Glass Smoking Pipe, Smoking Set, Glass Teapot, Glass Cup, Glass Cruet Set, Glasswares, Double Wall Glass Cup, Glass Beer Mugs, Glass Bong, Glass Jar	Confidential
<input checked="" type="checkbox"/> Australia	Glass Water Pipe, Glass Smoking Pipe, Smoking Set, Glass Teapot, Glass Cup, Glass Cruet Set, Glasswares, Double Wall Glass Cup, Glass Beer Mugs, Glass Bong, Glass Jar	Confidential
<input checked="" type="checkbox"/> Domestic	Glass Water Pipe, Glass Smoking Pipe, Smoking Set, Glass Teapot, Glass Cup, Glass Cruet Set, Glasswares, Double Wall Glass Cup, Glass Beer Mugs, Glass Bong, Glass Jar	Confidential

This report only presents the documents, files and information which collected from audited enterprise of TÜV Rheinland Group, not including the subjective analysis of the enterprise status, legal advice, any suggestions related to legal issues, any compliance of local/international requirements and product testing compliance. This report reflects our findings for the particular company in concern on the date of our service only and does not discharge or release the factory/sellers/suppliers from their commercial, legal or contractual obligations with buyers in respect of products provided by the factory/sellers/suppliers. Any reader other than the party for which this report has been specifically issued is hereby informed that the General Conditions of Service of TÜV Rheinland contain liability limitation provisions.

Attention: To check the authenticity of testing/inspection report & certificate, please click: <https://www.verified.chn.tuv.com/en/>



Section 3: Supplier Management

3.1 Supplier Management		
Item	Content	Observations /Comments
1	Does the company establish and implement an effective suppliers' assessment procedure?	<input type="checkbox"/> Have the written procedures and followed records <input checked="" type="checkbox"/> Have the written procedures but no records <input type="checkbox"/> Have relevant records without written procedure <input type="checkbox"/> No written procedures or followed records <input type="checkbox"/> Other
2	Does the company have an updated list of approved suppliers?	<input type="checkbox"/> The approved suppliers list was updated in _____ <input type="checkbox"/> Have the written suppliers without approved signature or date. <input checked="" type="checkbox"/> Provided some suppliers names <input type="checkbox"/> No approved suppliers list <input type="checkbox"/> Other

Section 4: After-sales Service Capacity

4.1 After-sales Service Capacity		
Item	Content	Observations /Comments
1	Is there a procedure to conduct random product inspection after final packaging in place?	<input type="checkbox"/> Have clear standards and written inspection records <input type="checkbox"/> No written standards but had inspection reports <input type="checkbox"/> Have the procedures but no inspection records <input type="checkbox"/> It's not necessary to carry out the inspection <input checked="" type="checkbox"/> Other All inspection would be carried out before final packaging
2	Is there a clear procedure for handling customer complaints?	<input type="checkbox"/> Has the clear procedure and followed records <input checked="" type="checkbox"/> Has the procedure but no written records. <input type="checkbox"/> No written procedures or records. <input type="checkbox"/> Other
3	Can the finished/packaged product be traced by lot identification to the appropriate raw materials test reports?	<input type="checkbox"/> Have the procedures to trace the raw materials. <input checked="" type="checkbox"/> Can trace main materials <input type="checkbox"/> Can trace production date. <input type="checkbox"/> Can't trace products <input type="checkbox"/> Other
4	Are corrective & preventive actions mechanism established and implemented effectively (including the suppliers/ sub-contractors control, incoming inspection, process control, final inspection and customer complaint)?	<input type="checkbox"/> Has the clear procedure and followed records <input checked="" type="checkbox"/> Has the procedure but no written records. <input type="checkbox"/> No written procedures or records. <input type="checkbox"/> Other

This report only presents the documents, files and information which collected from audited enterprise of TÜV Rheinland Group, not including the subjective analysis of the enterprise status, legal advice, any suggestions related to legal issues, any compliance of local/international requirements and product testing compliance. This report reflects our findings for the particular company in concern on the date of our service only and does not discharge or release the factory/sellers/suppliers from their commercial, legal or contractual obligations with buyers in respect of products provided by the factory/sellers/suppliers. Any reader other than the party for which this report has been specifically issued is hereby informed that the General Conditions of Service of TÜV Rheinland contain liability limitation provisions.

Attention: To check the authenticity of testing/inspection report & certificate, please click: <https://www.verified.chn.tuv.com/en/>

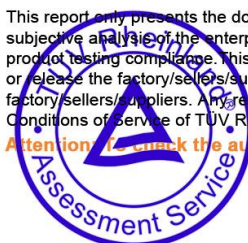

Part C: Product Research & Development Capacity

1.1 Product Research & Development Capacity	
The amount of R&D and relevant working experience.	<input type="checkbox"/> within 1year staff <input type="checkbox"/> 1-5 years staff <input checked="" type="checkbox"/> 6-10 years 1 staff <input checked="" type="checkbox"/> over 10 years 2 staffs Total 3 engineers
What is the main job responsibility for R&D engineers?	Research and development of new products
Is there any relevant design input, output, review, verification and validation documentation available for auditor to review?	No. There is no any relevant design input , output , review verification and validation documentation available for auditor to review.
Is there any special software or instrument used by the R&D staffs during the design process of new products? If yes, please list the main software or instrument.	Yes. AUTO CAD, Photoshop
Does the company have an effective design change control procedure in place?	No. The company without an effective design change control procedure in place.
Please list the patent certificates and qualification license.	N/A

This report only presents the documents, files and information which collected from audited enterprise of TÜV Rheinland Group, not including the subjective analysis of the enterprise status, legal advice, any suggestions related to legal issues, any compliance of local/international requirements and product testing compliance. This report reflects our findings for the particular company in concern on the date of our service only and does not discharge or release the factory/sellers/suppliers from their commercial, legal or contractual obligations with buyers in respect of products provided by the factory/sellers/suppliers. Any reader other than the party for which this report has been specifically issued is hereby informed that the General Conditions of Service of TÜV Rheinland contain liability limitation provisions.

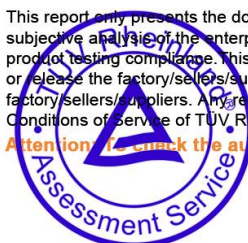

Attention: To check the authenticity of testing/inspection report & certificate, please click: <https://www.verified.chn.tuv.com/en/>

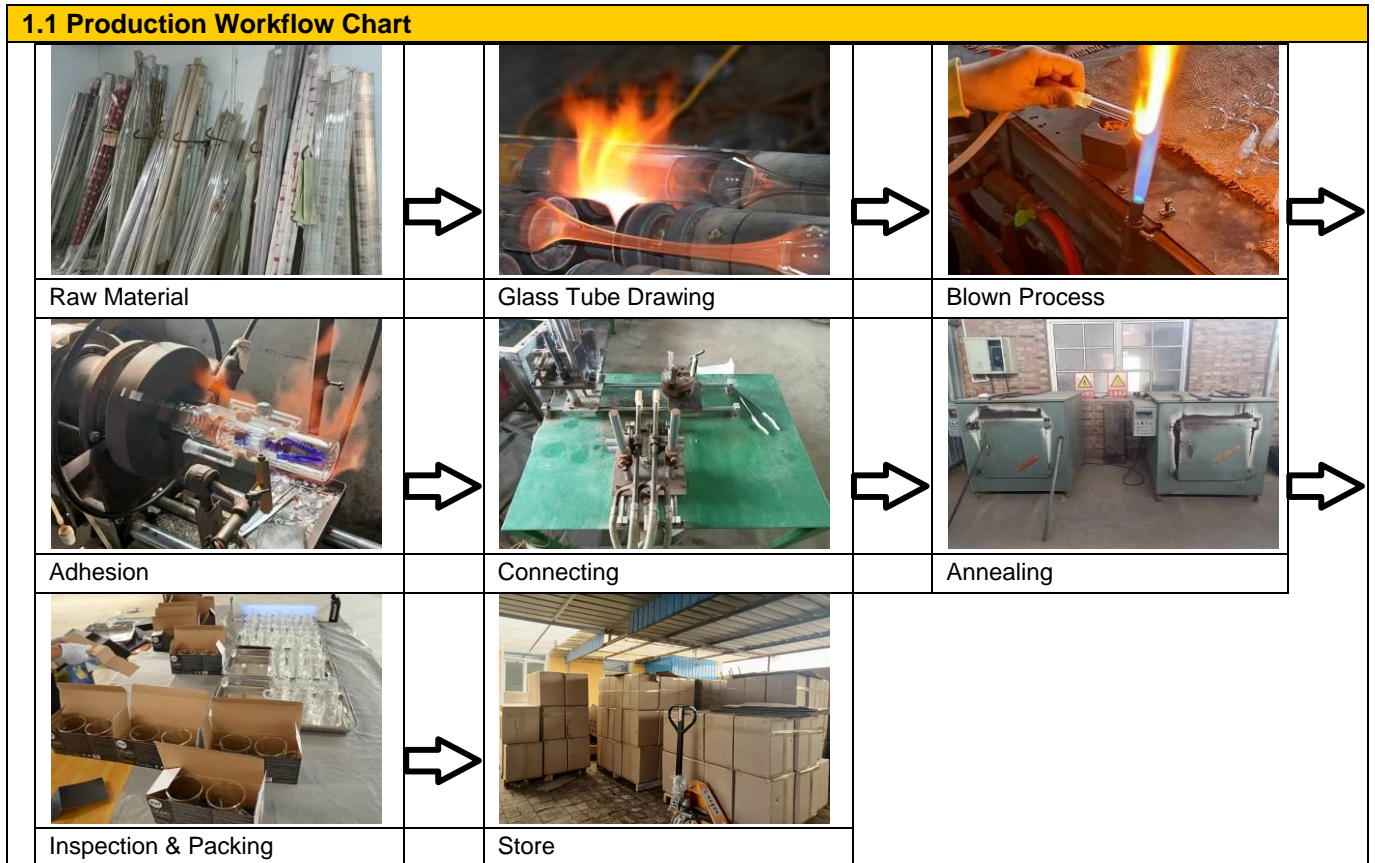

Part E: Production Capacity & Quality Control

Section 1: Production Capacity



1.2 Products Situation (Top three Product Categories)					
Product	Price range	Min. order quantity	Top monthly output	Average monthly output	Total in 2022
 Glass Water Pipe	RMB 40-150 Per Pcs	50 Pcs	Confidential	Confidential	Confidential
 Glass Cup	RMB 2-25 Per Pcs	2,000 Pcs	Confidential	Confidential	Confidential



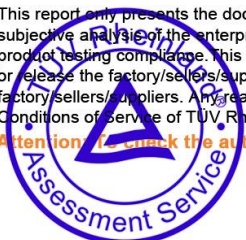

This report only presents the documents, files and information which collected from audited enterprise of TÜV Rheinland Group, not including the subjective analysis of the enterprise status, legal advice, any suggestions related to legal issues, any compliance of local/international requirements and product testing compliance. This report reflects our findings for the particular company in concern on the date of our service only and does not discharge or release the factory/sellers/suppliers from their commercial, legal or contractual obligations with buyers in respect of products provided by the factory/sellers/suppliers. Any reader other than the party for which this report has been specifically issued is hereby informed that the General Conditions of Service of TÜV Rheinland contain liability limitation provisions.

Attention: To check the authenticity of testing/inspection report & certificate, please click: <https://www.verified.chn.tuv.com/en/>

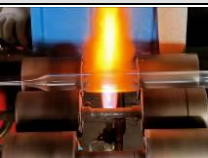

 Tea Pot	RMB 10-50 Per Pcs	1000 Pcs	Confidential	Confidential	Confidential
--	----------------------	----------	--------------	--------------	--------------

1.3 Main Facilities

Picture	Facility name	Brand or Country/Region of origin	Target Value/machine*day	Quantity
	Glass Tube Drawing Machine	Confidential	Confidential	2
	Glass Tube Processing Lather	Confidential	Confidential	7
	Connecting Machine	Confidential	Confidential	3
	Annealing Furnace	Confidential	Confidential	2
	Liquid Oxygen Tank	Confidential	Confidential	2

This report only presents the documents, files and information which collected from audited enterprise of TÜV Rheinland Group, not including the subjective analysis of the enterprise status, legal advice, any suggestions related to legal issues, any compliance of local/international requirements and product testing compliance. This report reflects our findings for the particular company in concern on the date of our service only and does not discharge or release the factory/sellers/suppliers from their commercial, legal or contractual obligations with buyers in respect of products provided by the factory/sellers/suppliers. Any reader other than the party for which this report has been specifically issued is hereby informed that the General Conditions of Service of TÜV Rheinland contain liability limitation provisions.

Attention: To check the authenticity of testing/inspection report & certificate, please click: <https://www.verified.chn.tuv.com/en/>

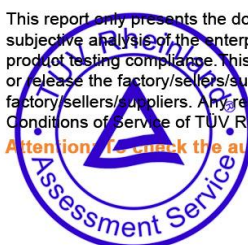

Section 2: Production Process Control

2.1 Production Process Control		
Item	Content	Observations /Comments
1	Product R&D capacity	<input type="checkbox"/> Own brand <input checked="" type="checkbox"/> ODM <input checked="" type="checkbox"/> OEM
2	Are the environmental conditions, such as tidiness and cleanliness being controlled and suitable for the operation performed?	<input type="checkbox"/> Very tidy <input checked="" type="checkbox"/> Normal <input type="checkbox"/> Need to improve <input type="checkbox"/> Very poor
3	Are the necessary items /documents provided at appropriate location and under control?	<input type="checkbox"/> Work Instructions /procedures <input type="checkbox"/> Workmanship standard /acceptance <input checked="" type="checkbox"/> Golden sample /Approval sample <input checked="" type="checkbox"/> Product picture <input type="checkbox"/> Verbal by workshop director
4	Are written instructions available for incoming material inspections /testing? Is the relevant record maintained?	<input type="checkbox"/> Has instructions and uniformly followed <input checked="" type="checkbox"/> Has instruction but no written records <input type="checkbox"/> Materials checked by storage staff
5	Are written inspections /testing instructions available for finished products? Is the relevant record maintained?	<input type="checkbox"/> Have instructions and uniformly followed <input checked="" type="checkbox"/> Have instruction but no written records <input type="checkbox"/> Finished product checked by packing staff
6	What type of inspection is used for finished products?	<input checked="" type="checkbox"/> Random inspection <input type="checkbox"/> Visual inspection <input checked="" type="checkbox"/> Function inspection <input checked="" type="checkbox"/> 100% inspection <input checked="" type="checkbox"/> Visual inspection <input type="checkbox"/> Function inspection
7	Are non-conforming units clearly marked/ segregated to prevent accidental dispatch?	<input type="checkbox"/> Marked and segregated <input checked="" type="checkbox"/> Segregated but not marked clearly <input type="checkbox"/> Not found on site
8	How are the non-conforming units handled?	<input type="checkbox"/> Repaired and re-inspection <input checked="" type="checkbox"/> Picked out <input type="checkbox"/> Used under control <input type="checkbox"/> Others

This report only presents the documents, files and information which collected from audited enterprise of TÜV Rheinland Group, not including the subjective analysis of the enterprise status, legal advice, any suggestions related to legal issues, any compliance of local/international requirements and product testing compliance. This report reflects our findings for the particular company in concern on the date of our service only and does not discharge or release the factory/sellers/suppliers from their commercial, legal or contractual obligations with buyers in respect of products provided by the factory/sellers/suppliers. Any reader other than the party for which this report has been specifically issued is hereby informed that the General Conditions of Service of TÜV Rheinland contain liability limitation provisions.

Attention: To check the authenticity of testing/inspection report & certificate, please click: <https://www.verified.chn.tuv.com/en/>

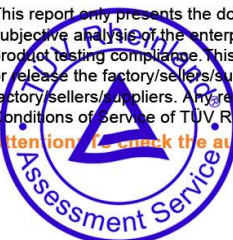

Part G: Working Environment

Section 1: Working Environment

1.1 Welfare Benefits		
Item	Content	Observations /Comments
1	Does the company have effective procedures to verify the age of staff at the time of recruitment?	<input checked="" type="checkbox"/> Has written procedure and keeps adequate age documents of workers <input type="checkbox"/> Has written procedure but doesn't follow records <input type="checkbox"/> Hasn't written procedure or follows records
2	Do all workers sign employment contracts with the factory?	<input checked="" type="checkbox"/> All workers sign employment contracts <input type="checkbox"/> Some workers sign employment contracts <input type="checkbox"/> Only management staff sign employment contracts <input type="checkbox"/> No staff sign employment contracts
3	Is statutory contribution required for all employees' social insurance (e.g. health insurance, unemployment insurance, accident insurance etc.) paid for by the enterprise?	<input checked="" type="checkbox"/> All workers have social insurance. <input type="checkbox"/> Some workers have social insurance <input type="checkbox"/> Only management staffs have social insurance <input type="checkbox"/> No staff have social insurance
4	Does the company have a clear and effective policy on working hours, rest and vacations? If does, please list it.	<input checked="" type="checkbox"/> All staffs work kept to the policy <input type="checkbox"/> Most of the time it keeps to the policy except midseason. <input type="checkbox"/> Usually needs overtime. <input type="checkbox"/> No relevant records for working hours Describe the working hours: 8 hours/day, 6 working days/week
5	Does the company pay extra remunerations for all overtime work?	<input checked="" type="checkbox"/> For all overtime work. <input type="checkbox"/> For official holidays <input type="checkbox"/> For official holidays except weekend. <input type="checkbox"/> No extra remunerations for overtime.
6	Does the company have dormitories for staff? If yes, please describe the condition.	<input type="checkbox"/> Provide dormitories for all staff <input checked="" type="checkbox"/> Provide dormitories for workers <input type="checkbox"/> Provide dormitories for management staff <input type="checkbox"/> No dormitories were provided. Describe the condition: Clean
1.2 Labor Protection		
Item	Content	Observations /Comments
1	Are there uniforms for all staff in company?	<input type="checkbox"/> Yes <input checked="" type="checkbox"/> No <input type="checkbox"/> Other
2	Is the emergency medical supplies enough and easily used in workshop?	<input type="checkbox"/> Yes <input checked="" type="checkbox"/> No <input type="checkbox"/> Other
3	Does the company arrange health and safety training for new workers?	<input type="checkbox"/> Yes <input checked="" type="checkbox"/> No <input type="checkbox"/> Other
4	Do the workers have the appropriate protective equipment during operation in workshop? Such as gloves, masks.	<input checked="" type="checkbox"/> Yes <input type="checkbox"/> No <input type="checkbox"/> Other
5	Is there training needed and carried out for fire protection?	<input checked="" type="checkbox"/> Yes <input type="checkbox"/> No <input type="checkbox"/> Other

This report only presents the documents, files and information which collected from audited enterprise of TÜV Rheinland Group, not including the subjective analysis of the enterprise status, legal advice, any suggestions related to legal issues, any compliance of local/international requirements and product testing compliance. This report reflects our findings for the particular company in concern on the date of our service only and does not discharge or release the factory/sellers/suppliers from their commercial, legal or contractual obligations with buyers in respect of products provided by the factory/sellers/suppliers. Any reader other than the party for which this report has been specifically issued is hereby informed that the General Conditions of Service of TÜV Rheinland contain liability limitation provisions.

Attention: To check the authenticity of testing/inspection report & certificate, please click: <https://www.verified.chn.tuv.com/en/>



Part H: Energy Saving and Emission Reduction

Section 1: Environmental Management

1.1 Environmental Management		
Item	Content	Observations /Comments
1	Environmental Management System	<input type="checkbox"/> ISO 14001 Certificate <input type="checkbox"/> Cleaner production management <input checked="" type="checkbox"/> NIL
2	Environmental Impact Assessment	<input type="checkbox"/> The Report of Environmental impact assessment is approved by EPA . <input checked="" type="checkbox"/> NIL
3	Check and Acceptance of Completed Constructive Projects	<input type="checkbox"/> The Report Completed Constructive Projects Inspection and Acceptance is approved. <input checked="" type="checkbox"/> NIL
4	"Three Simultaneity" for Environmental protection	<input type="checkbox"/> The Report of "Three Simultaneity" for Environmental protection Inspection and Acceptance is available. <input checked="" type="checkbox"/> NIL

Section 2: Water, Gas and Noise Control

2.1 Water, Gas and Noise Control		
Item	Content	Observations /Comments
1	Water-intaking	<input type="checkbox"/> Water-intaking license <input type="checkbox"/> No water-intaking license <input checked="" type="checkbox"/> No water taken from natural water body
2	Waste water	<input type="checkbox"/> Water-draining license or contract <input type="checkbox"/> Having carried out waste water treatment before draining <input type="checkbox"/> Having carried out waste water monitoring and the result of which being within the standard limit <input checked="" type="checkbox"/> No detail activities were found
3	Emission to air	<input type="checkbox"/> Air pollutant emission license <input type="checkbox"/> Having carried out air pollutant emission monitoring and the result of which being within the standard limit <input checked="" type="checkbox"/> No detail activities were found to reduce emission to air
4	Classification and Recycling for solid waste	<input checked="" type="checkbox"/> Having applied trash classification recycling <input type="checkbox"/> Having special warehouse for hazardous waste <input type="checkbox"/> No detail activities were found
5	Noise	<input type="checkbox"/> The company carried out noise monitoring and the result of which being within the standard limit one time per year <input checked="" type="checkbox"/> No detail activities were found

This report only presents the documents, files and information which collected from audited enterprise of TÜV Rheinland Group, not including the subjective analysis of the enterprise status, legal advice, any suggestions related to legal issues, any compliance of local/international requirements and product testing compliance. This report reflects our findings for the particular company in concern on the date of our service only and does not discharge or release the factory/sellers/suppliers from their commercial, legal or contractual obligations with buyers in respect of products provided by the factory/sellers/suppliers. Any reader other than the party for which this report has been specifically issued is hereby informed that the General Conditions of Service of TÜV Rheinland contain liability limitation provisions.

Attention: To check the authenticity of testing/inspection report & certificate, please click: <https://www.verified.chn.tuv.com/en/>

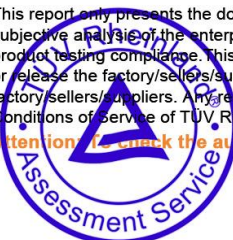

Part J: Photos

Section 1: Photos of Documents

1.1 Photos of Documents

Description: Business License



This report only presents the documents, files and information which collected from audited enterprise of TÜV Rheinland Group, not including the subjective analysis of the enterprise status, legal advice, any suggestions related to legal issues, any compliance of local/international requirements and product testing compliance. This report reflects our findings for the particular company in concern on the date of our service only and does not discharge or release the factory/sellers/suppliers from their commercial, legal or contractual obligations with buyers in respect of products provided by the factory/sellers/suppliers. Any reader other than the party for which this report has been specifically issued is hereby informed that the General Conditions of Service of TÜV Rheinland contain liability limitation provisions.

Attention: To check the authenticity of testing/inspection report & certificate, please click: <https://www.verified.chn.tuv.com/en/>



Section 2: Photos of Company

2.1 Photos of Company and Product Sample

Description: Company Gate



Description: Office Building



Description: Office



Description: Show Room



Description: Workshop



Description: Store



This report only presents the documents, files and information which collected from audited enterprise of TÜV Rheinland Group, not including the subjective analysis of the enterprise status, legal advice, any suggestions related to legal issues, any compliance of local/international requirements and product testing compliance. This report reflects our findings for the particular company in concern on the date of our service only and does not discharge or release the factory/sellers/suppliers from their commercial, legal or contractual obligations with buyers in respect of products provided by the factory/sellers/suppliers. Any reader other than the party for which this report has been specifically issued is hereby informed that the General Conditions of Service of TÜV Rheinland contain liability limitation provisions.

Attention: To check the authenticity of testing/inspection report & certificate, please click: <https://www.verified.chn.tuv.com/en/>

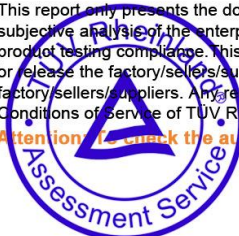



This report only presents the documents, files and information which collected from audited enterprise of TÜV Rheinland Group, not including the subjective analysis of the enterprise status, legal advice, any suggestions related to legal issues, any compliance of local/international requirements and product testing compliance. This report reflects our findings for the particular company in concern on the date of our service only and does not discharge or release the factory/sellers/suppliers from their commercial, legal or contractual obligations with buyers in respect of products provided by the factory/sellers/suppliers. Any reader other than the party for which this report has been specifically issued is hereby informed that the General Conditions of Service of TÜV Rheinland contain liability limitation provisions.

Attention: To check the authenticity of testing/inspection report & certificate, please click: <https://www.verified.chn.tuv.com/en/>

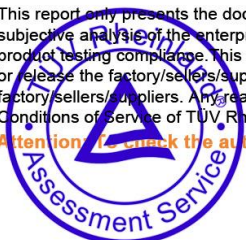



-- End of the Report --

This report only presents the documents, files and information which collected from audited enterprise of TÜV Rheinland Group, not including the subjective analysis of the enterprise status, legal advice, any suggestions related to legal issues, any compliance of local/international requirements and product testing compliance. This report reflects our findings for the particular company in concern on the date of our service only and does not discharge or release the factory/sellers/suppliers from their commercial, legal or contractual obligations with buyers in respect of products provided by the factory/sellers/suppliers. Any reader other than the party for which this report has been specifically issued is hereby informed that the General Conditions of Service of TÜV Rheinland contain liability limitation provisions.

Attention: To check the authenticity of testing/inspection report & certificate, please click: <https://www.verified.chn.tuv.com/en/>

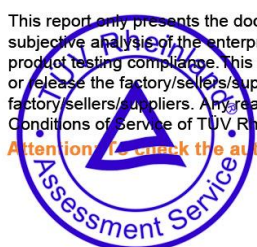

Report Number: MIC-ASR186127

Audit Date : 26 May, 2018

This report is issued by Focus Technology Co., Ltd. (Made-in-China.com) and the supervising inspectorate (Bureau Veritas) to confirm that:

Company Name : Hejian BH Glass Products Co., Ltd.
河间市碧海佳玉玻璃制品有限公司

Showroom : <http://hbbhij.en.made-in-china.com>

Address : East of Road, North 1.5KM, Bao Cang High-Speed Hejian Export, Dahe Road, Hejian City, Cangzhou City, Hebei Province, China

Product : Glass Water Pipe, Smoking Pipe, Tea Pot, Glass Cup, Double Wall Glass, Cups & Mugs, Glassware

has been on site audited for the Following Scope of Activity

1. General Information
2. Foreign Trade Capacity
3. Product Research & Development Capacity
4. Production Capacity & Quality Control
5. Working Environment
6. Energy Saving and Emission Reduction
7. Photos



General Comments:

Hejian BH Glass Products Co., Ltd. is a manufacturer with 45 employees; it was established in 2014, located in East of Road, North 1.5KM, Bao Cang High-Speed Hejian Export, Dahe Road, Hejian City, Cangzhou City. The workshops occupy an area of 2,000 square meters. The main products are Glass Water Pipe, Smoking Pipe, Tea Pot, Glass Cup, Double Wall Glass, Cups & Mugs, Glassware.



Sign for and on behalf of
Bureau Veritas

SUPPLIER ASSESSMENT REPORT

Audited Company	Hejian BH Glass Products Co., Ltd. 河间市碧海佳玉玻璃制品有限公司
Audited Site:	East of Road, North 1.5KM, Bao Cang High-Speed Hejian Export, Dahe Road, Hejian City, Cangzhou City, Hebei Province, China

Consigner of Assessment	Made-in-China.com			
Audit Type	<input type="checkbox"/> Initial Audit <input checked="" type="checkbox"/> Re-audit			
Audit Date	26 May, 2018	Verify Report		www.bvcerchina.cn
Auditor	Clyde Cheng	Reviewed by		Jeff Yu

CONTENTS

- Part A: General Information**
 - Section 1: Company Overview
 - Section 2: Human Resources
- Part B: Foreign Trade Capacity**
 - Section 1: Export Overall Situation
 - Section 2: Export Business Capacity
 - Section 3: Supplier Management
 - Section 4: After-sales Service Capacity
- Part C: Product Research & Development Capacity**
 - Section 1: Product Research & Development Capacity
- Part D: Management System and Product Certification**
 - Section 1: Management System(s) and Product Certification
- Part E: Production Capacity & Quality Control**
 - Section 1: Production Capacity Section
 - Section 2: Production Process Control
- Part F: Financial Position**
 - Section 1: Financial Data
 - Section 2: Key Performance Indications
 - Section 3: Banking
 - Section 4: Product Insurance
- Part G: Working Environment**
 - Section 1: Working Environment
- Part H: Energy Saving and Emission Reduction**
 - Section 1: Environmental Management
 - Section 2: Water, Gas and Noise Control
- Part I: Industry Information**
 - Section 1: Industry Information
- Part J: Photos**
 - Section 1: Photos of Documents
 - Section 2: Photos of Company

This document is the property of Bureau Veritas. Attention is drawn to the limitation of liability, indemnification and jurisdiction issues defined therein. Any holder of this document who uses the information contained hereon is solely limited to visual examination of the safety and readily accessible portions of consignment and this document does not exonerate parties to a transaction from exercising all their rights and obligations under the transaction document. Any unauthorized use, reproduction, or falsification of the content or appearance of this document is unlawful and offenders may be prosecuted to the fullest extent of the law.

Attention: To check the authenticity of testing/inspection report & certificate, please click: <http://www.bvcerchina.cn/>



Part A: General Information

Section 1: Company Overview

1.1 Legal Validity			
Does the company have a valid business license?	<input checked="" type="checkbox"/> Yes <input type="checkbox"/> No <input type="checkbox"/> Others	Registration Number	911309843083985028
Year of established	22 Aug., 2014	Valid Date	21 Aug., 2034
Registered address	East of Road, North 1.5KM, Bao Cang High-Speed Hejian Export, Dahe Road, Hejian City, Cangzhou City, Hebei Province, China		
Actual address	East of Road, North 1.5KM, Bao Cang High-Speed Hejian Export, Dahe Road, Hejian City, Cangzhou City, Hebei Province, China		
Does the company in abnormal operation status list of industrial and commercial bureau?	No		
Registered capital	RMB 500000		
Name of legal representative	Mr. Qinghua Bai		
Business scope	Glass arts and crafts, glass home appliances, glass water and tobacco pot, glass and water gun, glass tea set, glass, glass coffee tool, glass candlestick pendant production and sales and import and export business of this enterprise; supporting silicon rubber products, stainless steel products, plastic products sales. (after approved by the relevant departments to carry out business activities)		
1.2 Basic Information			
Contact person	Mr. Qinghua Bai		
Phone number	0086-317-3675000	Fax number	0086-317-3674555
URL/Web address	http://hbbhjy.en.made-in-china.com		
Company type	<input type="checkbox"/> Manufacturer <input type="checkbox"/> Trading Company <input checked="" type="checkbox"/> Combined <input type="checkbox"/> Group Corporation		
Type of ownership	<input checked="" type="checkbox"/> Limited Company <input type="checkbox"/> Public Company <input type="checkbox"/> Foreign joint venture <input type="checkbox"/> State-Owned <input type="checkbox"/> Private Owner <input type="checkbox"/> Wholly foreign-owned enterprises		
Associated company	No associated company		
Products manufactured / sold scope	Glass Water Pipe, Smoking Pipe, Tea Pot, Glass Cup, Double Wall Glass, Cups & Mugs, Glassware		
1.3 Company Building Information			
According to:			
<input type="checkbox"/> Land certificate <input type="checkbox"/> Real estate certificate <input checked="" type="checkbox"/> Lease agreement <input type="checkbox"/> Observation Estimated on site			
The company area 2500 square meters The land occupies 4000 square meters. The offices occupy 500 square meters. The workshops occupy 2000 square meters.			

This document is the property of Bureau Veritas. Attention is drawn to the limitation of liability, indemnification and jurisdiction issues defined therein. Any holder of this document who uses the information contained hereon is solely limited to visual examination of the safety and readily accessible portions of consignment and this document does not exonerate parties to a transaction from exercising all their rights and obligations under the transaction document. Any unauthorized reproduction, modification or falsification of the content or appearance of this document is unlawful and offenders may be prosecuted to the fullest extent of the law.

Attention: To check the authenticity of testing/inspection report & certificate, please click: <http://www.bvcerchina.cn/>



Section 2: Human Resources

2.1 Company Chart

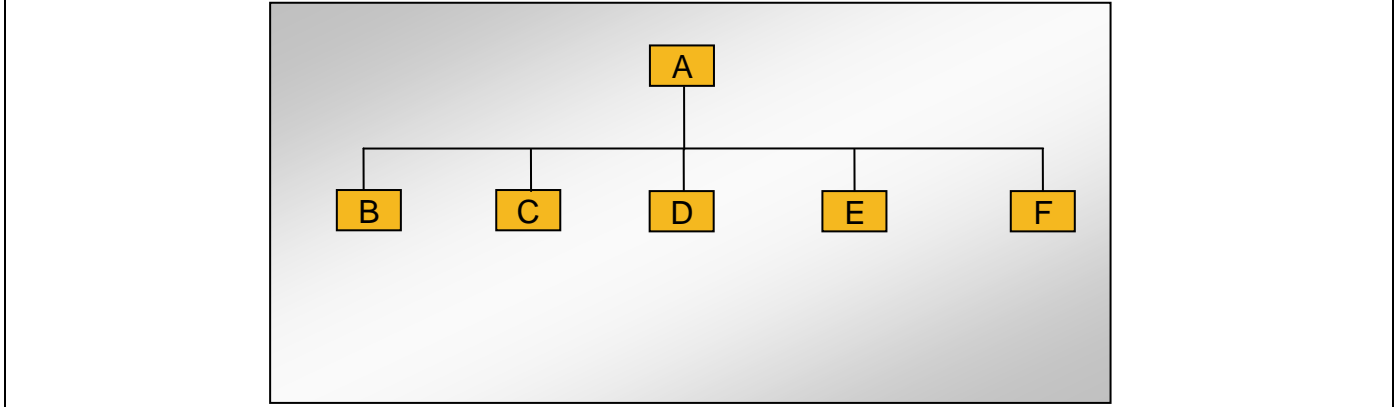

2.2 Explanation of Code and Employee Details

Code	Department	Number of employees
A	General Manager	1
B	Finance Department	1
C	Business Department	4
D	Administration Department	6
E	Production Department	30
F	Technical Department	3
Number in total:		45

2.3 Key Staff

Title	Full name	Education	Working experience for this trade / total experience
General Manager	Mr. Qinghua Bai	Junior College	31/31 Years

Remark: Above information of key staff was based on interview with company representative.

Part B: Foreign Trade Capacity

Section 1: Export Overall Situation

1.1 Export Overall Situation	
Does the company have a valid Import and Export license?	<input type="checkbox"/> Yes <input checked="" type="checkbox"/> No
The import and export enterprise code.	N/A
The number of foreign trading staff with relevant trading experience.	<input type="checkbox"/> within 1 year staff <input checked="" type="checkbox"/> 1-5 years 1 staff <input checked="" type="checkbox"/> 6-10 years 1 staff <input type="checkbox"/> over 10 years staff Total 2 staffs
The language freely used by foreign trade staff	<input checked="" type="checkbox"/> English <input type="checkbox"/> others:
Annual revenue of previous year	Confidential
Annual export revenue of previous year	Confidential
Estimated export revenue for this year.	Confidential
Overseas agent / branch	<input type="checkbox"/> Yes <input checked="" type="checkbox"/> No
Nearest port	Tianjin Port
Acceptable quotation terms	<input checked="" type="checkbox"/> FOB <input checked="" type="checkbox"/> CIF <input checked="" type="checkbox"/> CFR Other:EXW
Acceptable payment terms	<input type="checkbox"/> LC <input checked="" type="checkbox"/> T/T <input type="checkbox"/> D/P <input checked="" type="checkbox"/> PayPal <input checked="" type="checkbox"/> Western Union <input type="checkbox"/> Small-amount payment
Average lead time (Peak Season)	<input checked="" type="checkbox"/> within 15 workday <input type="checkbox"/> one month <input type="checkbox"/> 2-3 months <input type="checkbox"/> 4-6 months <input type="checkbox"/> 6-12 months <input type="checkbox"/> more time
Average lead time (Off Season)	<input checked="" type="checkbox"/> within 15 workday <input type="checkbox"/> one month <input type="checkbox"/> 2-3 months <input type="checkbox"/> 4-6 months <input type="checkbox"/> 6-12 months <input type="checkbox"/> more time

Section 2: Export Business Capacity

2.1 Market Distribution (please list top three areas)		
Market	Main Product	Main client
<input checked="" type="checkbox"/> North America	Glass Water Pipe, Smoking Pipe, Tea Pot, Glass Cup, Double Wall Glass, Cups & Mugs, Glassware	Confidential
<input checked="" type="checkbox"/> South America	Glass Water Pipe, Smoking Pipe, Tea Pot, Glass Cup, Double Wall Glass, Cups & Mugs, Glassware	Confidential
<input checked="" type="checkbox"/> Europe	Glass Water Pipe, Smoking Pipe, Tea Pot, Glass Cup, Double Wall Glass, Cups & Mugs, Glassware	Confidential
<input type="checkbox"/> Southeast Asia/ Mideast		
<input type="checkbox"/> Africa		
<input type="checkbox"/> East Asia (Japan/ South Korea)		
<input type="checkbox"/> Australia		
<input checked="" type="checkbox"/> Domestic	Glass Water Pipe, Smoking Pipe, Tea Pot, Glass Cup, Double Wall Glass, Cups & Mugs, Glassware	Confidential
<input type="checkbox"/> Others		

This document is the property of Bureau Veritas. Attention is drawn to the limitation of liability, indemnification and jurisdiction issues defined therein. Any holder of this document who uses the information contained hereon is solely limited to visual examination of the safety and readily accessible portions of consignment and is not to be held responsible for any findings at the time of its intervention only and within the limits of Client's instructions, if any. The company's sole responsibility is to provide an accurate and reliable report and this document does not exonerate parties to a transaction from exercising all their rights and obligations under the transaction document. Any unauthorized use, reproduction, alteration, or falsification of the content or appearance of this document is unlawful and offenders may be prosecuted to the fullest extent of the law.

Attention: To check the authenticity of testing/inspection report & certificate, please click: <http://www.bvcerchina.cn/>



Section 3: Supplier Management

3.1 Supplier Management		
Item	Content	Observations /Comments
1	Does the company establish and implement an effective suppliers' assessment procedure?	<input type="checkbox"/> Have the written procedures and followed records <input checked="" type="checkbox"/> Have the written procedures but no records <input type="checkbox"/> Have relevant records without written procedure <input type="checkbox"/> No written procedures or followed records <input type="checkbox"/> Other
2	Does the company have an updated list of approved suppliers?	<input type="checkbox"/> The approved suppliers list was updated in _____ <input type="checkbox"/> Have the written suppliers without approved signature or date. <input checked="" type="checkbox"/> Provided some suppliers names <input type="checkbox"/> No approved suppliers list <input type="checkbox"/> Other

Section 4: After-sales Service Capacity

4.1 After-sales Service Capacity		
Item	Content	Observations /Comments
1	Is there a procedure to conduct random product inspection after final packaging in place?	<input type="checkbox"/> Have clear standards and written inspection records <input type="checkbox"/> No written standards but had inspection reports <input checked="" type="checkbox"/> Have the procedures but no inspection records <input type="checkbox"/> It's not necessary to carry out the inspection <input type="checkbox"/> Other
2	Is there a clear procedure for handling customer complaints?	<input type="checkbox"/> Has the clear procedure and followed records <input checked="" type="checkbox"/> Has the procedure but no written records. <input type="checkbox"/> No written procedures or records. <input type="checkbox"/> Other
3	Can the finished/packaged product be traced by lot identification to the appropriate raw materials test reports?	<input type="checkbox"/> Have the procedures to trace the raw materials. <input checked="" type="checkbox"/> Can trace main materials <input type="checkbox"/> Can trace production date. <input type="checkbox"/> Can't trace products <input type="checkbox"/> Other
4	Are corrective & preventive actions mechanism established and implemented effectively (including the suppliers/ sub-contractors control, incoming inspection, process control, final inspection and customer complaint)?	<input type="checkbox"/> Has the clear procedure and followed records <input checked="" type="checkbox"/> Has the procedure but no written records. <input type="checkbox"/> No written procedures or records. <input type="checkbox"/> Other



Part C: Product Research & Development Capacity

1.1 Product Research & Development Capacity	
The amount of R&D and relevant working experience.	<input type="checkbox"/> within 1year staff <input type="checkbox"/> 1-5 years staff <input type="checkbox"/> 6-10 years staff <input checked="" type="checkbox"/> over 10 years 3 staffs Total 3 engineers
What is the main job responsibility for R&D engineers?	New products design, products improvement.
Is there any relevant design input, output, review, verification and validation documentation available for auditor to review?	NO, There is no any relevant design input, output, review, verification and validation documentation available for auditor to review
Is there any special software or instrument used by the R&D staffs during the design process of new products? If yes, please list the main software or instrument.	YES, CAD was used by the R&D staffs during the design process of new products.
Does the company have an effective design change control procedure in place?	NO, The company without an effective design change control procedure in place
Please list the patent certificates and qualification license.	patent certificates: N/A; qualification certificates: N/A









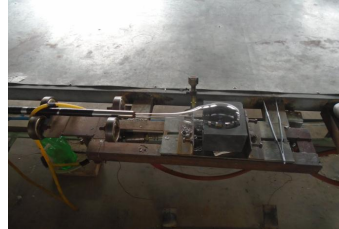

This document is the property of Bureau Veritas. Attention is drawn to the limitation of liability, indemnification and jurisdiction issues defined therein. Any holder of this document who uses the information contained hereon is solely limited to visual examination of the safety and readily accessible portions of consignment and is not authorized to make any findings at the time of its intervention only and within the limits of Client's instructions, if any. The company's sole responsibility is to provide information and this document does not exonerate parties to a transaction from exercising all their rights and obligations under the transaction document. Any use, reproduction, distribution, modification, or falsification of the content or appearance of this document is unlawful and offenders may be prosecuted to the fullest extent of the law.

For more information, please contact Bureau Veritas. To check the authenticity of testing/inspection report & certificate, please click: <http://www.bvcerchina.cn/>



Part E: Production Capacity & Quality Control

Section 1: Production Capacity

1.1 Production Workflow Chart					
	→		→		→
Raw Materials		Glass Tube Drawing		Blown Process	
	→		→		→
Cutting		Adhesion		Connecting	
	→				
Annealing		Inspection & Packing			
1.2 Products Situation (Top three Product Categories)					
Product	Price range	Min. order quantity	Top monthly output	Average monthly output	Total in 2017
 Glass Water Pipe	RMB 40-150 Per Pcs	50 Pcs	Confidential	Confidential	Confidential
 Glass Cup	RMB 2-25 Per Pcs	2000 Pcs	Confidential	Confidential	Confidential



BUREAU VERITAS

	RMB 10-50 Per Pcs	1000 Pcs	Confidential	Confidential	Confidential
Tea Pot					

1.3 Main Facilities

Picture	Facility name	Brand or Country/Region of origin	Target Value/machine*day	Quantity
	Adhesion Facility	China	Confidential	1
	Adhesion Facility	China	Confidential	3
	Annealing Furnace	China	Confidential	2
	Blown Process Facility	China	Confidential	7
	Connecting Facility	China	Confidential	3
	Cutting Facility	China	Confidential	4
	Glass Tube Drawing Facility	China	Confidential	6

This document is the property of Bureau Veritas. Attention is drawn to the limitation of liability, indemnification and jurisdiction issues defined therein. Any holder of this document who uses the information contained hereon is solely limited to visual examination of the safety and readily accessible portions of consignment and is not authorized to make any findings at the time of its intervention only and within the limits of Client's instructions, if any. The company's sole responsibility is to provide an objective and reliable report and this document does not exonerate parties to a transaction from exercising all their rights and obligations under the transaction document. Any use, reproduction, distribution, modification, or falsification of the content or appearance of this document is unlawful and offenders may be prosecuted to the fullest extent of the law.

Attention: To check the authenticity of testing/inspection report & certificate, please click: <http://www.bvcerchina.cn/>







BUREAU VERITAS

Bureau Veritas No: MIC-ASR186127

Made-in-China.com™

Connecting Buyers with Chinese Suppliers

	Liquid Oxygen Tank	China	Confidential	2
	Natural Gas Storage Group	China	Confidential	3

This document is the property of Bureau Veritas. Attention is drawn to the limitation of liability, indemnification and jurisdiction issues defined therein. Any holder of this document is authorized to use the information contained hereon solely for the purpose of visual examination of the safety and readily accessible portions of consignment and for the purpose of making decisions at the time of its intervention only and within the limits of Client's instructions, if any. The company's sole responsibility is to inform the Client of the results of its examination and this document does not exonerate parties to a transaction from exercising all their rights and obligations under the transaction document. Any use of this document for any other purpose, including but not limited to, reproduction, distribution, or falsification of the content or appearance of this document is unlawful and offenders may be prosecuted to the fullest extent of the law.

Attention: To check the authenticity of testing/inspection report & certificate, please click: <http://www.bvcerchina.cn/>



Section 2: Production Process Control

2.1 Production Process Control		
Item	Content	Observations /Comments
1	Product R&D capacity	<input type="checkbox"/> Own brand <input checked="" type="checkbox"/> ODM <input checked="" type="checkbox"/> OEM
2	Are the environmental conditions, such as tidiness and cleanliness being controlled and suitable for the operation performed?	<input type="checkbox"/> Very tidy <input checked="" type="checkbox"/> Normal <input type="checkbox"/> Need to improve <input type="checkbox"/> Very poor
3	Are the necessary items /documents provided at appropriate location and under control?	<input type="checkbox"/> Work Instructions /procedures <input checked="" type="checkbox"/> Workmanship standard /acceptance <input type="checkbox"/> Golden sample /Approval sample <input type="checkbox"/> Product picture <input type="checkbox"/> Verbal by workshop director
4	Are written instructions available for incoming material inspections /testing? Is the relevant record maintained?	<input type="checkbox"/> Has instructions and uniformly followed <input checked="" type="checkbox"/> Has instruction but no written records <input type="checkbox"/> Materials checked by storage staff
5	Are written inspections /testing instructions available for finished products? Is the relevant record maintained?	<input type="checkbox"/> Have instructions and uniformly followed <input checked="" type="checkbox"/> Have instruction but no written records <input type="checkbox"/> Finished product checked by packing staff
6	What type of inspection is used for finished products?	<input type="checkbox"/> Random inspection <input type="checkbox"/> Visual inspection <input type="checkbox"/> Function inspection <input checked="" type="checkbox"/> 100% inspection <input checked="" type="checkbox"/> Visual inspection <input checked="" type="checkbox"/> Function inspection
7	Are non-conforming units clearly marked/ segregated to prevent accidental dispatch?	<input checked="" type="checkbox"/> Marked and segregated <input type="checkbox"/> Segregated but not marked clearly <input type="checkbox"/> Not found on site
8	How are the non-conforming units handled?	<input type="checkbox"/> Repaired and re-inspection <input checked="" type="checkbox"/> Picked out <input type="checkbox"/> Used under control <input type="checkbox"/> Others

Part G: Working Environment

Section 1: Working Environment

1.1 Welfare Benefits		
Item	Content	Observations /Comments
1	Does the company have effective procedures to verify the age of staff at the time of recruitment?	<input checked="" type="checkbox"/> Has written procedure and keeps adequate age documents of workers <input type="checkbox"/> Has written procedure but doesn't follow records <input type="checkbox"/> Hasn't written procedure or follows records
2	Do all workers sign employment contracts with the factory?	<input type="checkbox"/> All workers sign employment contracts <input checked="" type="checkbox"/> Some workers sign employment contracts <input type="checkbox"/> Only management staff sign employment contracts <input type="checkbox"/> No staff sign employment contracts
3	Is statutory contribution required for all employees' social insurance (e.g. health insurance, unemployment insurance, accident insurance etc.) paid for by the enterprise?	<input type="checkbox"/> All workers have social insurance. <input type="checkbox"/> Some workers have social insurance <input type="checkbox"/> Only management staffs have social insurance <input checked="" type="checkbox"/> No staff have social insurance
4	Does the company have a clear and effective policy on working hours, rest and vacations? If does, please list it.	<input checked="" type="checkbox"/> All staffs work kept to the policy <input type="checkbox"/> Most of the time it keeps to the policy except midseason. <input type="checkbox"/> Usually needs overtime. <input type="checkbox"/> No relevant records for working hours Describe the working hours: 8:30 -- 12:00, 13:00 -- 17:30
5	Does the company pay extra remunerations for all overtime work?	<input checked="" type="checkbox"/> For all overtime work. <input type="checkbox"/> For official holidays <input type="checkbox"/> For official holidays except weekend. <input type="checkbox"/> No extra remunerations for overtime.
6	Does the company have dormitories for staff? If yes, please describe the condition.	<input type="checkbox"/> Provide dormitories for all staff <input checked="" type="checkbox"/> Provide dormitories for workers <input type="checkbox"/> Provide dormitories for management staff <input type="checkbox"/> No dormitories were provided. Describe the condition: Acceptable
1.2 Labor Protection		
Item	Content	Observations /Comments
1	Are there uniforms for all staff in company?	<input checked="" type="checkbox"/> Yes <input type="checkbox"/> No <input type="checkbox"/> Other
2	Is the emergency medical supplies enough and easily used in workshop?	<input checked="" type="checkbox"/> Yes <input type="checkbox"/> No <input type="checkbox"/> Other
3	Does the company arrange health and safety training for new workers?	<input checked="" type="checkbox"/> Yes <input type="checkbox"/> No <input type="checkbox"/> Other
4	Do the workers have the appropriate protective equipment during operation in workshop? Such as gloves, masks.	<input checked="" type="checkbox"/> Yes <input type="checkbox"/> No <input type="checkbox"/> Other

This document is the property of Bureau Veritas. Attention is drawn to the limitation of liability, indemnification and jurisdiction issues defined therein. Any holder of this document who uses the information contained hereon is solely limited to visual examination of the safety and readily accessible portions of consignment and is not responsible for any findings at the time of its intervention only and within the limits of Client's instructions, if any. The company's sole responsibility is to provide information and this document does not exonerate parties to a transaction from exercising all their rights and obligations under the transaction document. Any unauthorized reproduction, modification or falsification of the content or appearance of this document is unlawful and offenders may be prosecuted to the fullest extent of the law.

Attention: To check the authenticity of testing/inspection report & certificate, please click: <http://www.bvcerchina.cn/>





5	Is there training needed and carried out for fire protection?	<input checked="" type="checkbox"/> Yes <input type="checkbox"/> No <input type="checkbox"/> Other
---	---	--

This document is the property of Bureau Veritas. Attention is drawn to the limitation of liability, indemnification and jurisdiction issues defined therein. Any holder of this document shall be aware that information contained hereon is solely limited to visual examination of the safety and readily accessible portions of consignment and that the findings at the time of its intervention only and within the limits of Client's instructions, if any. The company's sole responsibility is to inform the Client of the results of its examination and this document does not exonerate parties to a transaction from exercising all their rights and obligations under the transaction document. Any use, reproduction, distribution, modification or falsification of the content or appearance of this document is unlawful and offenders may be prosecuted to the fullest extent of the law.

Attention: To check the authenticity of testing/inspection report & certificate, please click: <http://www.bvcerchina.cn/>



Part H: Energy Saving and Emission Reduction

Section 1: Environmental Management

1.1 Environmental Management		
Item	Content	Observations /Comments
1	Environmental Management System	<input type="checkbox"/> ISO 14001 Certificate <input type="checkbox"/> Cleaner production management <input checked="" type="checkbox"/> NIL
2	Environmental Impact Assessment	<input type="checkbox"/> The Report of Environmental impact assessment is approved by EPA . <input checked="" type="checkbox"/> NIL
3	Check and Acceptance of Completed Constructive Projects	<input type="checkbox"/> The Report Completed Constructive Projects Inspection and Acceptance is approved. <input checked="" type="checkbox"/> NIL
4	"Three Simultaneity" for Environmental protection	<input type="checkbox"/> The Report of "Three Simultaneity" for Environmental protection Inspection and Acceptance is available. <input checked="" type="checkbox"/> NIL

Section 2: Water, Gas and Noise Control

2.1 Water, Gas and Noise Control		
Item	Content	Observations /Comments
1	Water-intaking	<input type="checkbox"/> Water-intaking license <input type="checkbox"/> No water-intaking license <input checked="" type="checkbox"/> No water taken from natural water body
2	Waste water	<input type="checkbox"/> Water-draining license or contract <input type="checkbox"/> Having carried out waste water treatment before draining <input type="checkbox"/> Having carried out waste water monitoring and the result of which being within the standard limit <input checked="" type="checkbox"/> No detail activities were found
3	Emission to air	<input type="checkbox"/> Air pollutant emission license <input type="checkbox"/> Having carried out air pollutant emission monitoring and the result of which being within the standard limit <input checked="" type="checkbox"/> No detail activities were found to reduce emission to air
4	Classification and Recycling for solid waste	<input checked="" type="checkbox"/> Having applied trash classification recycling <input type="checkbox"/> Having special warehouse for hazardous waste <input type="checkbox"/> No detail activities were found
5	Noise	<input type="checkbox"/> The company carried out noise monitoring and the result of which being within the standard limit one time per year <input checked="" type="checkbox"/> No detail activities were found

This document is the property of Bureau Veritas. Attention is drawn to the limitation of liability, indemnification and jurisdiction issues defined therein. Any holder of this document who uses the information contained hereon is solely limited to visual examination of the safety and readily accessible portions of consignment and is not authorized to use the information for any other purpose. The findings at the time of its intervention only and within the limits of Client's instructions, if any. The company's sole responsibility is to provide an independent and objective assessment of the safety and quality of the goods. This document does not exonerate parties to a transaction from exercising all their rights and obligations under the transaction document. Any use, reproduction, distribution, modification, or falsification of the content or appearance of this document is unlawful and offenders may be prosecuted to the fullest extent of the law.

Attention: To check the authenticity of testing/inspection report & certificate, please click: <http://www.bvcerchina.cn/>



Part J: Photos

Section 1: Photos of Documents

1.1 Photos of Documents	
<p>Description: Business License & Tax Registered Certificate & Organization Code Certificate</p>  <p>The image shows a Chinese business license for Henan Zhonghai Glass Products Co., Ltd. The license includes the company name, address, registered capital, and establishment date. It features a QR code and a red official seal.</p>	<p>Description: Lease Agreement</p>  <p>The image shows a lease agreement document in Chinese. It details the location of the leased property and the terms of the lease. A red official seal is visible on the right side of the document.</p>
<p>Description: Permit for Opening Bank Account</p>  <p>The image shows a permit for opening a bank account issued by the Henan Zhonghai Glass Products Co., Ltd. It includes the company name, address, and the name of the authorized representative. A red official seal is present at the bottom.</p>	

This document is provided by Bureau Veritas. Attention is drawn to the limitation of liability, indemnification and jurisdiction issues defined therein. Any holder of this document who uses the information contained hereon is solely limited to visual examination of the safety and readily accessible portions of consignment and this document does not exonerate parties to a transaction from exercising all their rights and obligations under the transaction document. Any use of this document for any purpose other than that authorized by the law is prohibited. The falsification of the content or appearance of this document is unlawful and offenders may be prosecuted to the fullest extent of the law.



To check the authenticity of testing/inspection report & certificate, please click: <http://www.bvcerchina.cn/>

Section 2: Photos of Company

2.1 Photos of Company and Product Sample

Description: Company Gate



Description: Office



Description: Workshop



Description: Workshop



Description: Warehouse



Description: Showroom



This document is the property of Bureau Veritas. Attention is drawn to the limitation of liability, indemnification and jurisdiction issues defined therein. Any holder of this document who uses the information contained hereon is solely limited to visual examination of the safety and readily accessible portions of consignment and this document does not exonerate parties to a transaction from exercising all their rights and obligations under the transaction document. Any unauthorized use, reproduction, or falsification of the content or appearance of this document is unlawful and offenders may be prosecuted to the fullest extent of the law.

Attention: To check the authenticity of testing/inspection report & certificate, please click: <http://www.bvcerchina.cn/>







BUREAU VERITAS

Bureau Veritas No: MIC-ASR186127

Made-in-China.com™

Connecting Buyers with Chinese Suppliers



Description: Production Facility -- Natural Gas Storage Group



Description: Product Sample



Description: Product Sample



Description: Product Sample



Description: Product Sample



Description: Product Sample



This document is the property of Bureau Veritas. Attention is drawn to the limitation of liability, indemnification and jurisdiction issues defined therein. Any holder of this document who uses the information contained hereon is solely limited to visual examination of the safety and readily accessible portions of consignment and is not authorized to make any findings at the time of its intervention only and within the limits of Client's instructions, if any. The company's sole responsibility is to provide information and this document does not exonerate parties to a transaction from exercising all their rights and obligations under the transaction document. Any unauthorized use, reproduction, or falsification of the content or appearance of this document is unlawful and offenders may be prosecuted to the fullest extent of the law.

Attention: To check the authenticity of testing/inspection report & certificate, please click: <http://www.bvcerchina.cn/>



Description: Product Sample



Description: Product Sample



Description: Product Sample



Description: Product Sample



-- End of the Report --