





Access Instruments





Description	Item No.	Diam.	Length
VERESS needle, single use, box of 20 	EJ995	2.1 mm	120 mm
	EJ996	2.1 mm	150 mm
VERESS needle with 1.6 mm (14 gauge) distal tip diameter 	PG003	2.1 mm	100 mm
	PG008	2.1 mm	120 mm
	PG011	2.1 mm	150 mm
Exploratory probe with scaling 	BN320R	5 mm	40 cm
	BN321R	5 mm	50 cm
Exploratory probe with scaling 	BN322R	3.5 mm	40 cm

Monopolar Electrodes

Monopolar Instruments

Monopolar Electrodes	Description	Item No.	Diam.	Length
	Handle for monopolar laparoscopy electrodes	GK372R	5 mm	33 cm
		GK374R	5 mm	42 cm



	J Hook electrode tip	GK383R		
	L Hook electrode tip	GK384R		
	Ball electrode tip	GK385R		
	Spatula electrode tip	GK386R		

Spare Parts (Components of GK372R / GK374R)	Description	Item No.	Diam.	Length
	Handle with inner tube	GK373R	5 mm	33 cm
		GK375R	5 mm	42 cm

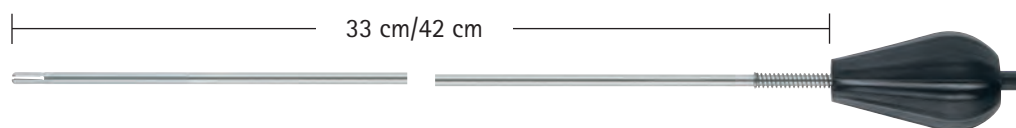



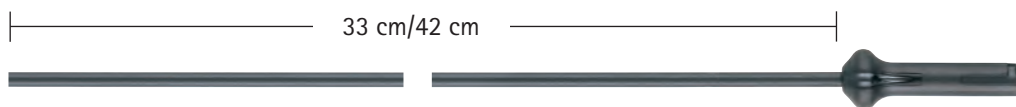

	Separate outer tube	GK370P	5 mm	33 cm
		GK376P	5 mm	42 cm







Micropin Electrode	Description	Item No.	Diam.	Length
	Low-energy micropin	GK390R	5 mm	33 cm







Spare Parts (Components of GK390R)	Description	Item No.	Diam.	Length
	Pin electrode only (pack of 5 pcs.)	GK389R		
	Handle with inner tube	GK373R	5 mm	33 cm
	Separate outer tube	GK371P	5 mm	33 cm

Pos No.	Item Code	Description / Comment	Qty.
	10 PO716R	<p>METZENBAUM ADTEC MONOPOLAR TC Dissecting Scissors, jaw inserts, monopolar, curved to left, 420 mm (16 1/2"), diam. 5 mm, medium fine pattern, serrated (fine), blunt/blunt, double action, non-sterile, reusable</p> 	1
	20 PM981R	<p>Insulated outer tube, PEEK, 5 mm diam., 420 mm, to be used with AdTec monopolar, AdTec bipolar</p> 	1
	30 PO959R	<p>AdTec monopolar Standard ring handle, PEEK insulated, with ratchet, ratchet can be deactivated, to be used with PO182R</p> 	1

Suction / Irrigation

Description	Item No.	Diameter	Length
Suction/irrigation tube with finger valve, luer-lock connection 	GF320R	5 mm	33 cm
Suction/Irrigation Tube, Luer-Lock connection 	GF321R	5 mm	33 cm
Puncture needle with finger valve, luer-lock connection, 2 mm (12 gauge) distal tip diameter 	SR550R	5 mm	33 cm
	SR553R	5 mm	45 cm
Puncture needle, luer-lock connection, 2 mm (12 gauge) distal tip diameter 	SR551R	5 mm	33 cm
Injection cannula, straight, distal tip diameter 0.8 mm 	SR554R	5 mm	37 cm

Description	Item No.	Diam.	Length
Suction irrigation tube with two-way-stopcock 	PG028R	3.5 mm	31 cm
Suction irrigation tube with two-way-stopcock 	PG027R	5 mm	33 cm
Suction irrigation tube with trumpet valve 	GF324R	5 mm	30 cm
Suction irrigation tube with trumpet valve 	GF325R	10 mm	40 cm

Klemmen – Forceps
 Präparier- und Ligaturklemmen
 Dissecting- and Ligature Forceps

BJ



BJ002R

Ligaturklemme gerade
 Ligature forceps straight
 95 mm, 3 3/4"



MICRO-ADSON

BJ008R

140 mm, 5 1/2"



BABY-OVERHOLT

BJ009R

135 mm, 5 1/4"



BJ011R	BJ012R
140 mm	180 mm
5 1/2"	7"

BABY-MIXTER

BJ011R-BJ012R

Urologie-Instrumente – Genito-Urinary Instruments

Nierenstielklemmen

Kidney Pedicle Clamps

EF



WERTHEIM-CULLEN

BJ579R

Winkel- und Druckklemme
Angle- and pressure clamp

215 mm, 8 1/2"

AIRAUMATA®



WERTHEIM

BJ581R

Winkel- und Druckklemme
Angle- and pressure clamp

250 mm, 10"



Wundhaken – Wound Retractors
Wundhaken
Retractors

BT

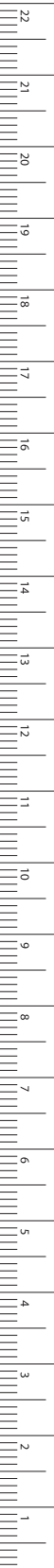

MILLIMETERS



1/2

KOCHER

BT369R-BT373R

230 mm, 9"

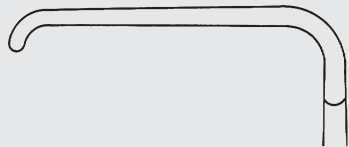

BT369R

40 x 18 mm

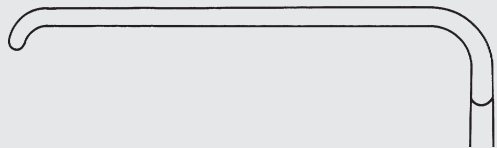

BT370R

60 x 20 mm

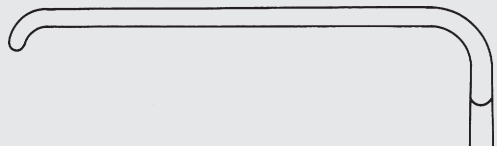

BT371R

60 x 25 mm

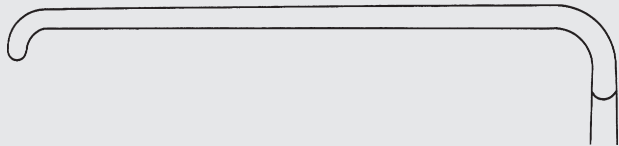

BT372R

75 x 30 mm

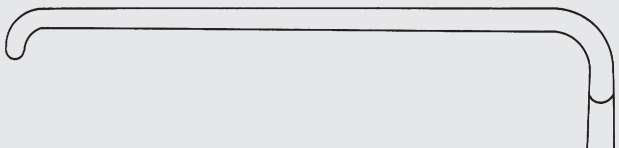

BT373R

75 x 40 mm

1/1



Abdominale Chirurgie – Abdominal Surgery

Protoskop – Analspreizer

Proctoscope – Rectal Retractor

EA

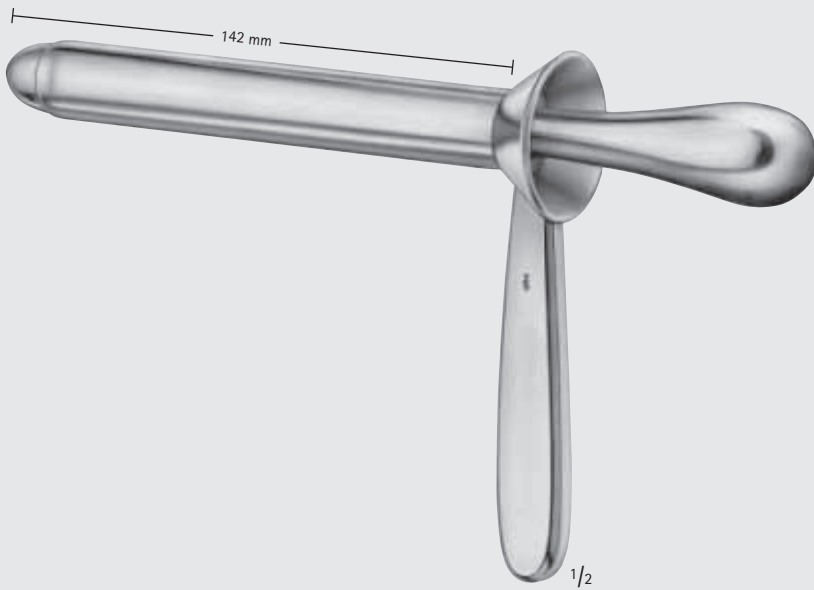

KELLY

EA887R

Proktoskop, Ø 20 mm

Proctoscope, diam. 20 mm

140 mm, 5 1/2"

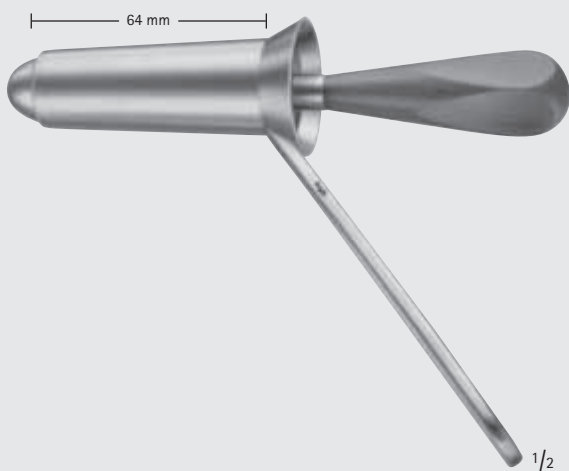

GABRIEL

EA853R

Rektum-Spekulum, Ø 25 mm

Rectal speculum, diam. 25 mm

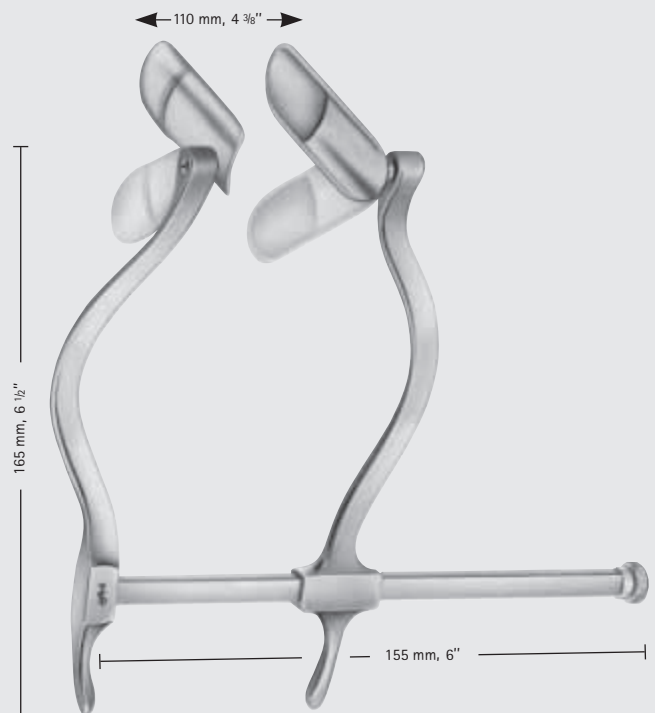

SMITH-BUIE

BV906R

Analspreizer

Blattgröße: 58 x 23 mm

Rectal retractor

Dimension of blades: 58 x 23 mm



MILLIMETERS

Wundhaken – Wound Retractors

Pelvishaken

Pelvis Retractors

Maßangaben für Blattgrößen der Wundhaken

1. Zahl = Tiefe Beispiel: 25 x 38 mm

2. Zahl = Breite

Dimensions for blade size of retractors

1st number = depth Example: 25 x 38 mm

2nd number = width

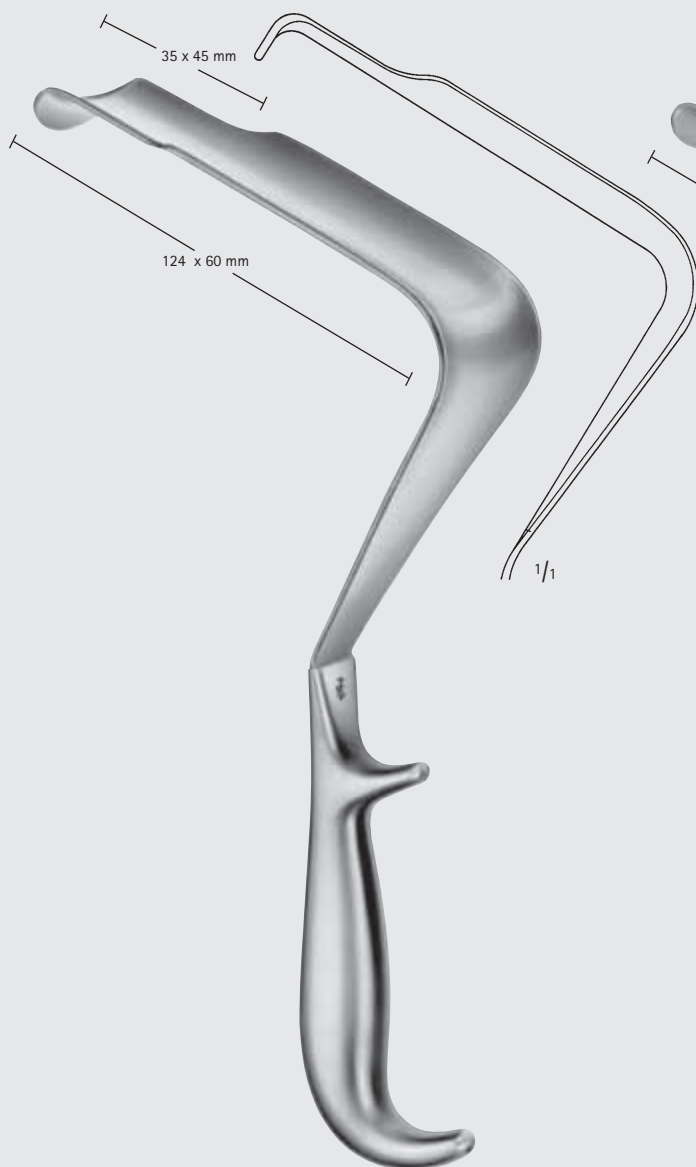
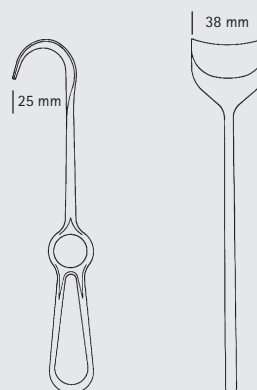

ST. MARKS

BT670R

290 mm, 11 1/2"

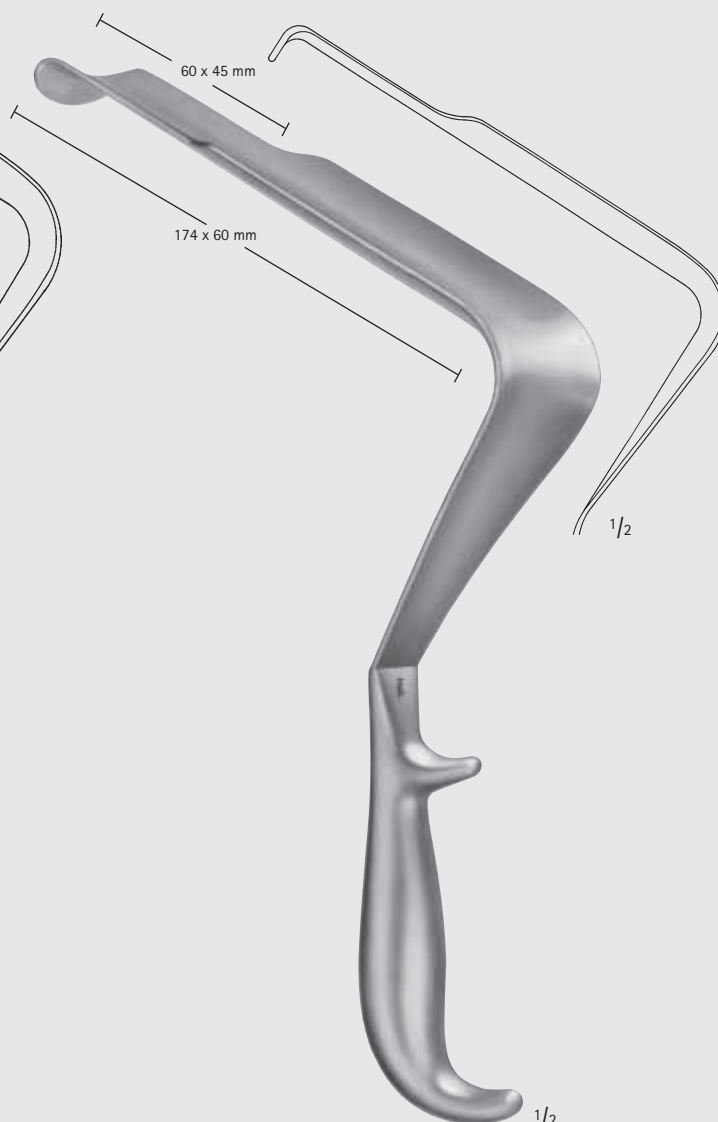

ST. MARKS

BT672R

330 mm, 13 1/8"

BT





Wundhaken – Wound Retractors

Wundhaken für Eingriffe in der Tiefe (Bauchdeckenhaken)
Retractors for Deep Surgery (Abdominal Retractors)

BT

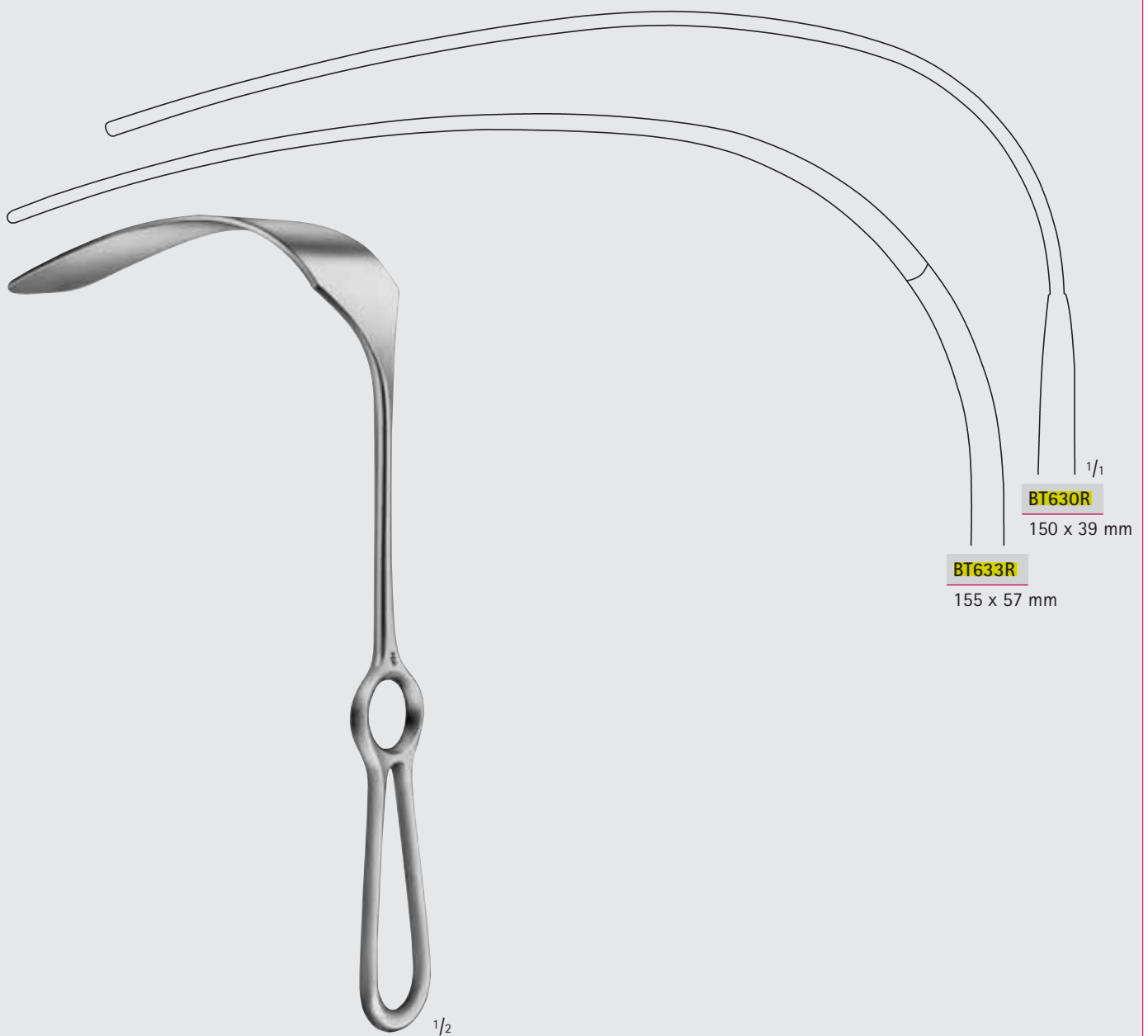

KELLY

BT630R-BT633R

260 mm, 10 1/4"

MILLIMETERS

Wundspreizer, Bauchdeckenhalter – Self-Retaining Retractors, Abdominal Retractors

 KUGELSCHNELLVERSCHLUSS
BALL SNAP CLOSURE

Bauchdeckenhalter
Abdominal Retractors

BV

320 mm, 12 1/2"



RICARD

BV542R-BV543R

komplett		
complete	BV542R	BV543R
Sperrer allein	BV527R	BV527R
Spreader only		
Seitl. Blätter (Paar)	BV556R	BV557R
Lateral blades (pair)	58 x 80 mm	72 x 84 mm
Mittelblatt	BV366R	BV367R
Center blade	54 x 70 mm	72 x 90 mm

275 mm, 10 3/4"



HOLZBACH

BV545R

komplett		
complete		
Seitl. Blätter (Paar)	BV558R	
Lateral blades (pair)	59 x 80 mm	
Mittelblatt		BV369R
Center blade		74 x 82 mm

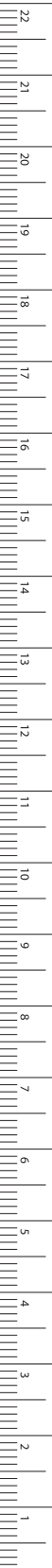

MILLIMETERS

Korn- und Tupferzangen – Sponge- and Dressing Forceps

Korn- und Tupferzangen
Sponge- and Dressing Forceps

BF



COLLIN

BF091R

240 mm, 9 1/2"



CHERON

BF092R

Griffe seitwärts abgewinkelt
Handles angled to side
240 mm, 9 1/2"



EMMET

BF098R

210 mm, 8 1/4"



MILLIMETERS

Skalpellsklingen und Griffe – Scalpel Blades and Handles

Skalpellsgriffe

Scalpel Handles

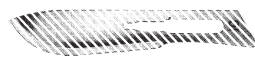

Für Klingen Fig. 10 - 15 und Fig. 40, 42

For blades fig. 10 - 15 and fig. 40, 42

BB



BB078R
225 mm, 9"



BB079R
225 mm, 9"



BB071R
210 mm, 8 1/4"



BB070R
155 mm, 6"



BB063R
145 mm, 5 3/4"



Skalpellklingen und Griffe – Scalpel Blades and Handles

Skalpellgriffe
Scalpel Handles

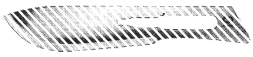

No. 4

Für Klingen Fig. 18 - 36
For blades fig. 18 - 36

BB



1/1

BB084R

No. 4
135 mm, 5 1/4"



1/1

BB085R

No. 4 L
215 mm, 8 1/2"



2/3

BB087R

No. 4 XL
250 mm, 10"



BB080R

No. 4
225 mm, 9"



1/1

BB088R

No. 8
130 mm, 5 1/8"



1/1

BB089R

145 mm, 5 3/4"



MILLIMETERS

Wundhaken – Wound Retractors

Nerv- und Gefäßhäkchen

Nerve- and Vessel Hooks

Maßangaben für Blattgrößen der Wundhaken

1. Zahl = Tiefe Beispiel: 25 x 38 mm

2. Zahl = Breite

Dimensions for blade size of retractors

1st number = depth Example: 25 x 38 mm

2nd number = width

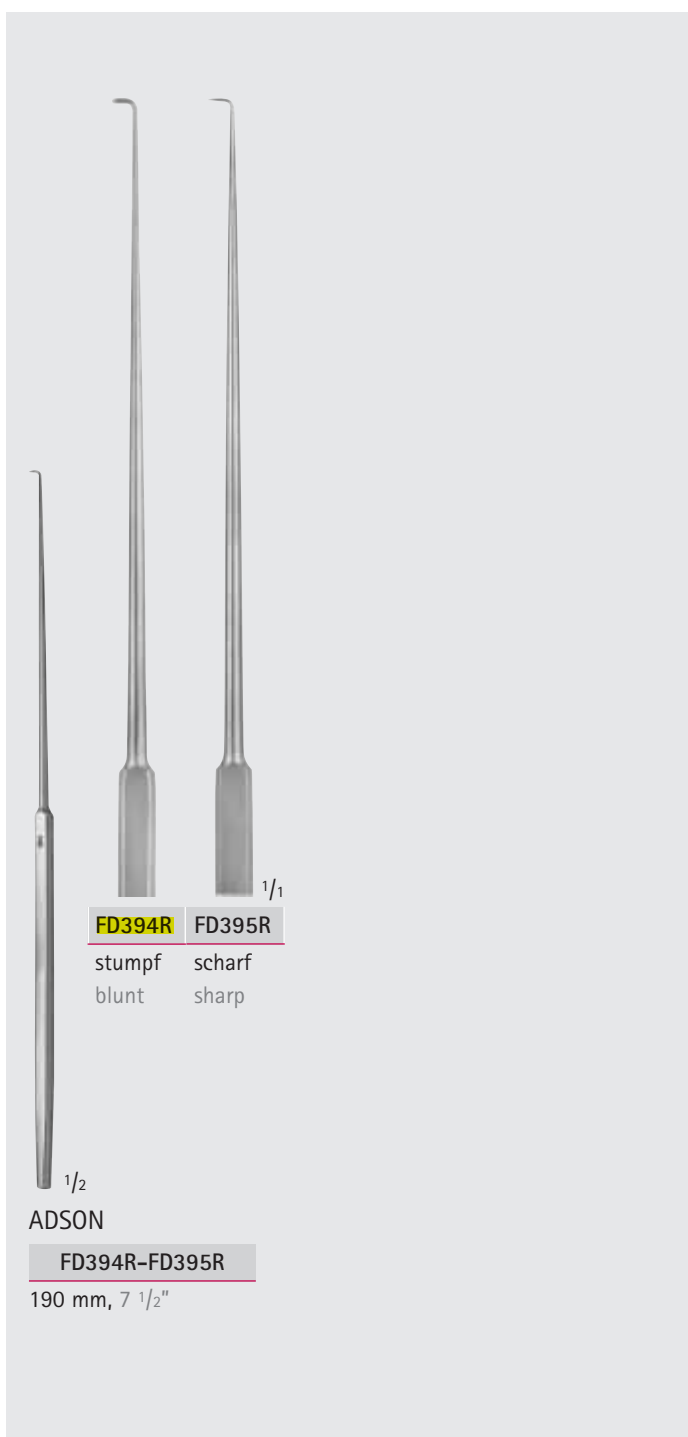
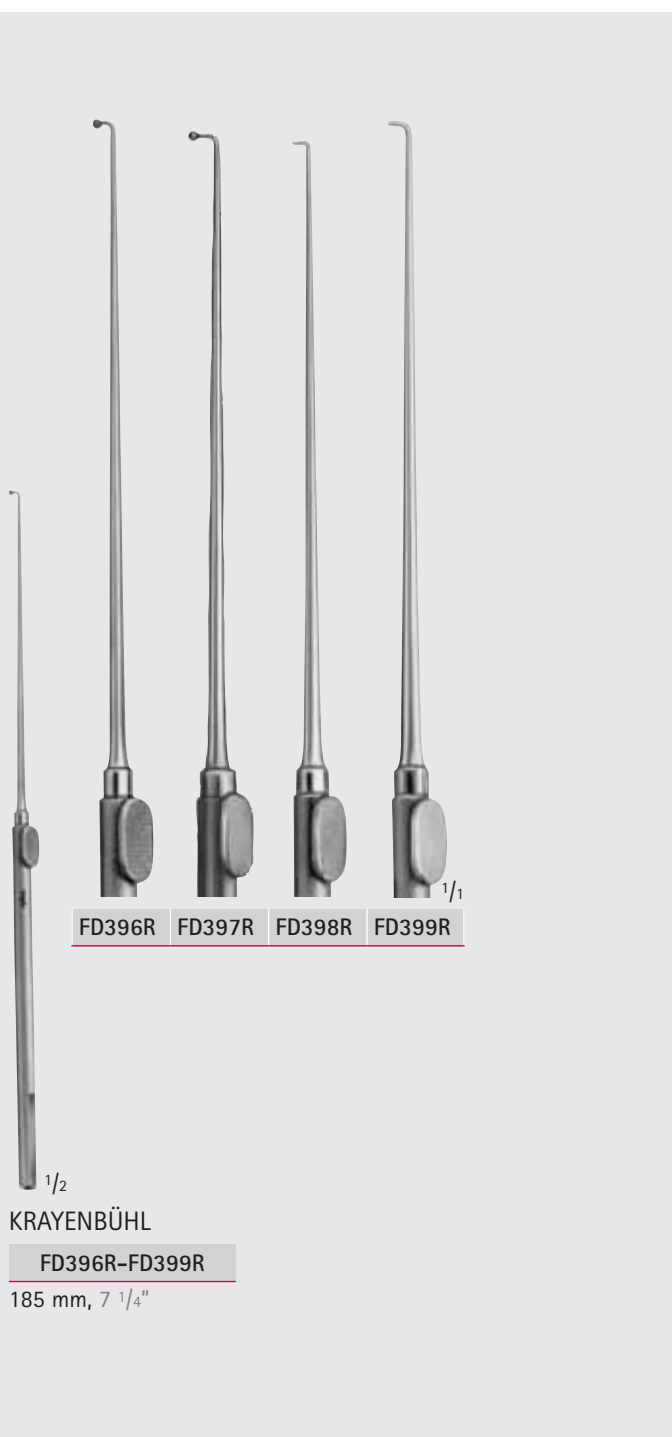
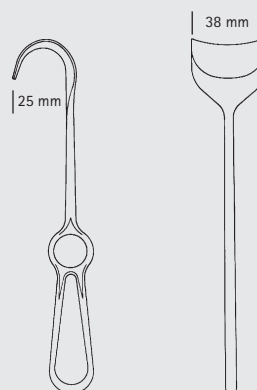

BT



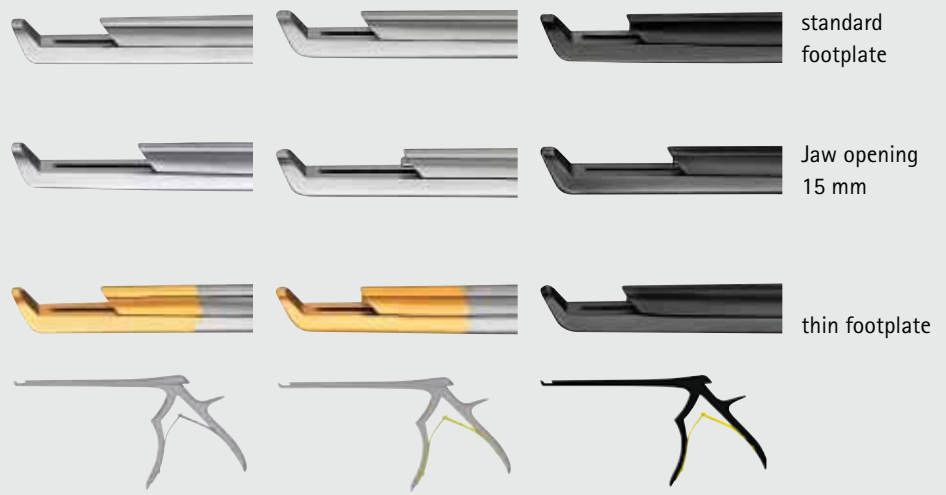

Jaw position 130°, upwards opening

Shaft length	Width (mm)	Footplate	Non detachable, without ejector	Detachable	Ejector	Noir®, detachable	Ejector	Jaw opening (mm)
200 mm, 8"	1.5	standard	FF649R	FK966R	-	FK966B	-	9
	2.0	standard	FF737R	FK913R	✓	FK913B	✓	9
	2.5	standard	FF657R	FK967R	✓	FK967B	✓	10
	3.0	standard	FF738R	FK914R	✓	FK914B	✓	10
	4.0	standard	FF727R	FK915R	✓	FK915B	✓	12
	5.0	standard	FF728R	FK916R	✓	FK916B	✓	12
	6.0	standard	FF729R	FK917R	✓	FK917B	✓	12
	1.0	thin	FF661R	FK961R	-	FK961B	-	8
	1.5	thin	FF658R	FK968R	-	FK968B	-	9
	2.0	thin	FF662R	FK962R	✓	FK962B	✓	9
	2.5	thin	FF659R	FK969R	✓	FK969B	✓	10
	3.0	thin	FF663R	FK963R	✓	FK963B	✓	10
	4.0	thin	FF664R	FK964R	✓	FK964B	✓	12
	5.0	thin	FF665R	FK965R	✓	FK965B	✓	12
	2.0	standard	FF660R	FK970R	✓	FK970B	✓	15
	3.0	standard	FF739R	FK982R	✓	FK982B	✓	15
	4.0	standard	FF745R	FK983R	✓	FK983B	✓	15
	5.0	standard	FF751R	FK984R	✓	FK984B	✓	15
	6.0	standard	FF753R	FK985R	✓	FK985B	✓	15
	230 mm, 9"	2.0	standard	FF682R	FK919R	✓	-	-
3.0		standard	FF683R	FK920R	✓	-	-	10
4.0		standard	FF684R	FK921R	✓	-	-	12
5.0		standard	FF685R	FK922R	✓	-	-	12
2.0		thin	FF746R	FK925R	✓	FK925B	✓	9
3.0		thin	FF747R	FK926R	✓	FK926B	✓	10
4.0		thin	FF748R	FK927R	✓	FK927B	✓	12
5.0		thin	FF749R	FK928R	✓	FK928B	✓	12
280 mm, 11"	2.0	thin	FF666R	FK976R	✓	FK976B	✓	9
	3.0	thin	FF667R	FK977R	✓	FK977B	✓	10
	4.0	thin	FF668R	FK978R	✓	FK978B	✓	12
	5.0	thin	FF669R	FK979R	✓	FK979B	✓	12

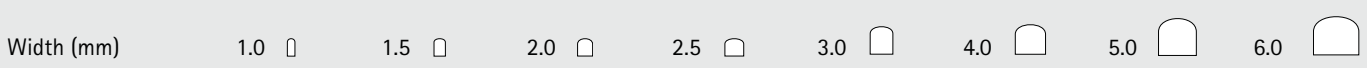

Nadelhalter – Needle Holders

DUROGRIP® Nadelhalter

DUROGRIP® Needle Holders

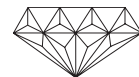

BM

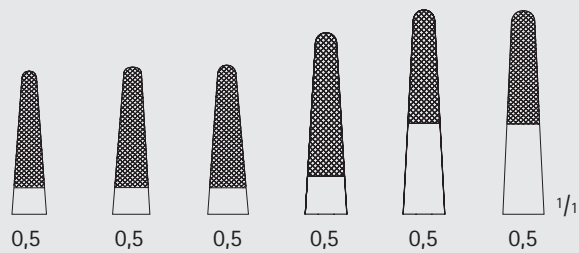

BM065R	BM066R	BM067R	BM068R	BM070R	BM069R
150 mm	185 mm	205 mm	235 mm	265 mm	300 mm
6"	7 1/4"	8"	9 1/4"	10 1/2"	12"

HEGAR-MAYO

BM065R-BM070R

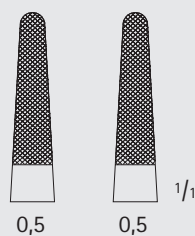

BM077R	BM078R
205 mm	245 mm
8"	9 3/4"

HEGAR

BM077R-BM078R

kräftige Modelle
heavy patterns

Angled positions for rongeurs

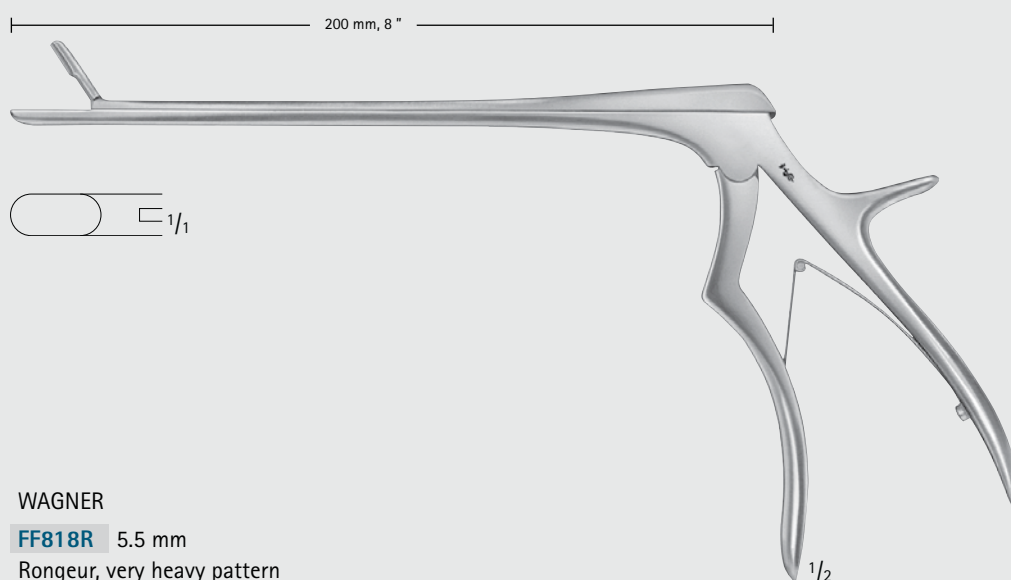
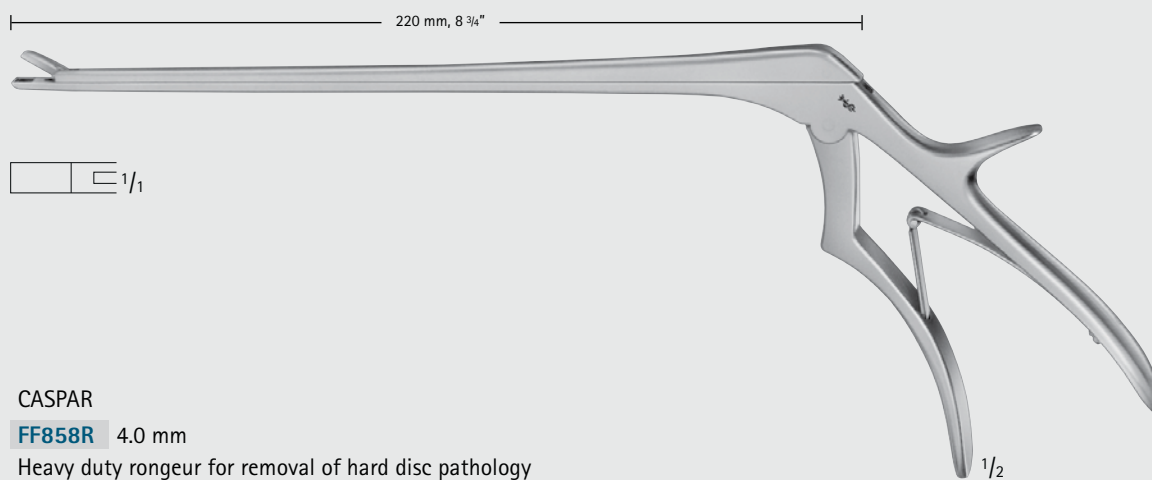
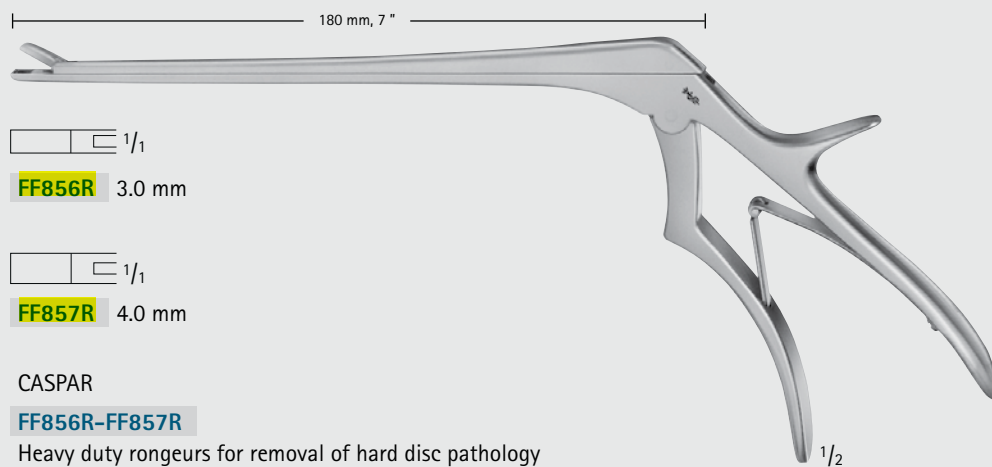
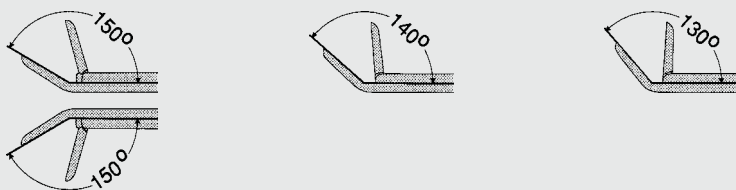

Aesculap[®] Detachable Rongeurs

Simply clean



Aesculap Neurosurgery

Aesculap® Detachable Rongeurs

Simply clean

Ever increasing demands in the reprocessing of surgical instruments require professional and efficient processes, together with intelligent product solutions, which meet modern hygiene standards. Our new detachable rongeurs fulfill these demands.

Simply clean; even without pre-cleaning.

Einfach sauber

Die stetig wachsenden Anforderungen an die Aufbereitung chirurgischer Instrumente erfordern, neben professionellen und effizienten Aufbereitungsprozessen, intelligente Produktlösungen, die den Ansprüchen der Hygiene gerecht werden. Unsere neuen zerlegbaren Rongeure tun dies.

Einfach sauber; auch ohne Vorreinigung.

NOIR® coating

No irritating light reflections

NOIR®-Beschichtung

Keine störenden Lichtreflexionen



straight / gerade

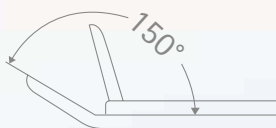

curved / aufgebogen



standard / standard



semi-serrated / halb-gezahnt

The choice is yours

86 models with working lengths from 150 mm to 280 mm, jaw widths from 1.5 mm to 5 mm, standard and semi-serrated jaws in straight and 150° upward curved. All models come with the proven NOIR® coating for the prevention of distracting light reflections.

Sie haben die Wahl

86 Modelle mit Arbeitslängen von 150 mm bis 280 mm, Maulbreiten zwischen 1,5 mm bis 5 mm, gezahnte und ungezahnte Arbeitsenden in gerade und 150° aufgebogen. Alle Modelle haben die bewährte NOIR®-Beschichtung, um störende Lichtreflexionen zu verhindern.

Intuitive handling

The golden button indicates the detachability and enables an intuitive, easy and quick assembly and disassembly. In the open cleaning position all parts remain connected. This prevents parts getting lost during reprocessing.

Intuitives Handling

Der goldene Knopf weist auf die Zerlegbarkeit hin und ermöglicht eine intuitive, einfache und schnelle Montage und Demontage. In der offenen Reinigungsposition bleiben alle Teile miteinander verbunden. Dies verhindert, dass Einzelteile während der Aufbereitung verloren gehen.



Easy identification

- Working length
- Jaw width

Einfache Identifizierung

- Arbeitslänge
- Maulbreite

Simple disassembly / Einfaches Zerlegen

- 1 Push the golden button
Drücken Sie den goldenen Knopf
- 2 Pull down the front handle
Ziehen Sie den vorderen Griff nach unten
- 3 Lift the slider
Heben Sie den Schieber an

Aesculap® Detachable Rongeurs



Working length / Arbeitslänge

Rongeurs standard / Rongeur standard

Working length Arbeitslänge	Jaw Maul	1.5 mm	2 mm	3 mm	4 mm	5 mm
150 mm		FH801B	FH802B	FH803B	FH804B	FH805B
150 mm		FH901B	FH902B	FH903B	FH904B	FH905B
180 mm		FH811B	FH812B	FH813B	FH814B	FH815B
180 mm		FH911B	FH912B	FH913B	FH914B	FH915B
200 mm		FH821B	FH822B	FH823B	FH824B	FH825B
200 mm		FH921B	FH922B	FH923B	FH924B	FH925B
230 mm		FH891B	FH892B	FH893B	FH894B	FH895B
230 mm		FH931B	FH932B	FH933B	FH934B	FH935B
280 mm		-	-	FH837B	FH838B	FH839B



Rongeurs semi-serrated / Rongeurs halb-gezahnt



Working length Arbeitslänge	Jaw Maul	1.5 mm	2 mm	3 mm	4 mm	5 mm
150 mm		FH851B	FH852B	FH853B	FH854B	FH855B
150 mm		FH951B	FH952B	FH953B	FH954B	FH955B
180 mm		FH861B	FH862B	FH863B	FH864B	FH865B
180 mm		FH961B	FH962B	FH963B	FH964B	FH965B
200 mm		FH871B	FH872B	FH873B	FH874B	FH875B
200 mm		FH971B	FH972B	FH973B	FH974B	FH975B
230 mm		FH881B	FH882B	FH883B	FH884B	FH885B
230 mm		FH981B	FH982B	FH983B	FH984B	FH985B
280 mm		-	-	FH847B	FH848B	FH849B



Nadelhalter – Needle Holders
Instrumente zur Naht
Suture Instruments

BM

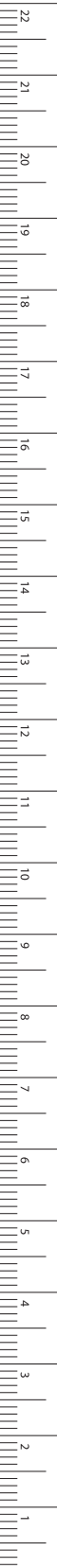

MILLIMETERS



BM950R

Fadengabel
Knot tier and Ligature adjuster
230 mm, 9"



CASPAR

FF309

Fadengabel
Knot tier and Ligature adjuster
230 mm, 9"



GK550

LANDOLT Coagulation-Suction Cannula, curved, 150 mm, working length: 150 mm (6"), diam. 5 mm, insulated, non-sterile, reusable, for suction hose 7,5 - 12 mm

Packing Units

PC - 1 PC

Quantity

1

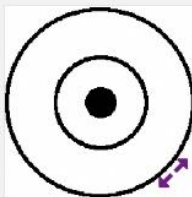

Produkttyp	Coagulation-Suction Cannula
Author	LANDOLT
Aesculap Product	
Groups	Neurosurgery, General Surgical Instruments
Product family	Neuroendoscopy
Geometry	curved
Length	150.00 mm
Working length (mm)	150.0 mm
Working length (Inch)	6"
Diameter (mm)	5.00 mm
Insulation	insulated
Connection instruments	for suction hose 7,5 - 12 mm
Minimally Invasive Surg. (MIS)	Yes
Discipline	Spine Surgery, Neurosurgery, Ear-Nose-Throat Surgery

TROUTMAN

CORNEAL SCISSORS

7 mm blades
9.5 mm from tip to pivot
overall length 100 mm
right, curved blades, blunt tips
left, curved blades, blunt tips

G-19710
G-19715



CASTROVIEJO

CORNEAL SCISSORS

lower blade 9.5 mm
upper blade 9.0 mm
overall length 105 mm
right, curved blades, blunt tips
left, curved blades, blunt tips

G-19690
G-19695



KATZIN

KERATOPLASTY SCISSORS

6 mm blades
8 mm from tip to pivot
overall length 100 mm
right, curved blades, blunt tips
left, curved blades, blunt tips

G-19720
G-19725



G-19718

SAUTTER

CORNEAL SCISSORS

light curve, fine blunt tips
10 mm blades
14 mm from tip to pivot
overall length 100 mm



G-19780

CASTROVIEJO

CORNEAL SCISSORS

strong curve, blunt tips
12 mm blades
15 mm from tip to pivot
overall length 103 mm



G-19790

CASTROVIEJO

CORNEAL SCISSORS

angled to side, blunt tips
12 mm blades
overall length 110 mm



CASTROVIEJO
NEEDLE HOLDER

short model
9 mm extra delicate jaws
0.9 x 0.55 mm tips
overall length 90 mm
straight, without lock
straight, with lock

G-17545

G-17540



CASTROVIEJO
NEEDLE HOLDER

10.5 mm delicate jaws
1.5 x 0.8 mm tips
overall length 140 mm
straight, without lock
straight, with lock

G-17560

G-17565















CASTROVIEJO
NEEDLE HOLDER

10.5 mm delicate jaws
1.5 x 0.8 mm tips
overall length 140 mm
curved, without lock
curved, with lock

G-17570





G-17575

	Item number	Description
	PG065	Hose for CO ₂ central gas supply DISS/DISS 3.0 m
	PG066	DISS Adapter for central gas supply
	PG067	NIST Adapter for central gas supply
	PG012	Single use tube set incl. CO ₂ Filter, sterile length 3 m, pack of 10
	PG014	Tube set for insufflation, length 3 m
	PG014200	ISO connector for PG014, 22 mm
	PG019	Single use CO ₂ Filter, pack of 25
	PG068	Switch valve for gas bottles
	PG082	Insufflation tube with gas warming, 3 m
	PG097	Heating tube set for insufflation length, 3 m (100 x autoclavable)
	PG096SU	Single use heating tube set for insufflation length, 3 m, pack of 10
	PG106	Smoke evacuation filter cassette, pack of 30
	PG107SU	Single use tube set for smoke evacuation, length 3 m, pack of 10

Reducing sleeves	Working length	Diameter	Guide	Sealing caps
------------------	----------------	----------	-------	--------------



PL650R	150 mm	5 mm	4 mm	PL650250	Pack of 20 pcs.
EJ601R	165 mm	10 mm	5.5 mm	EJ601250	Pack of 20 pcs.
EJ602R	165 mm	13 mm	5.5 mm	EJ602203	Pack of 1 pc.
EJ604R	165 mm	13 mm	10 mm	EJ645P	Pack of 20 pcs.
EJ614R	190 mm	20 mm	10 mm	EJ624P	Pack of 10 pcs.

Order number	Description		Diameter
EJ446255	Sealing cap, pack of 20 pcs.		5.5 mm
EJ449255			10.0 mm
EJ450255			12.5 mm
EJ643P			13.0 mm

Sealing cap set, pack of 5 pcs.

EJ640P

(green) for diam.
5 mm / 10 mm





EJ641P



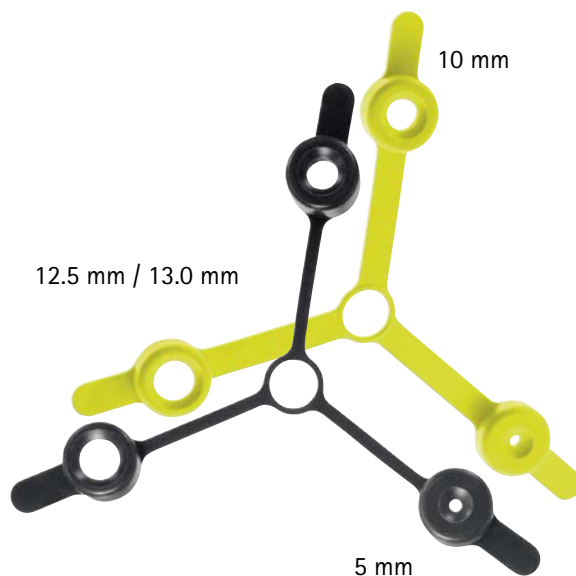



(black) for diam.
5 mm / 10 mm / 12.5 mm



EJ642P

(yellow) for diam.
5 mm / 10 mm / 13 mm











Pos No.	Item Code	Description / Comment	Qty.
	10 PO196R	BABCOCK ADTEC MONOPOLAR Organ Grasping Forceps, complete instrument, straight, working length: 370 mm (14 1/2"), diam. 10 mm, serrated, fenestrated, double action, consisting of PM977R, PO741R, PO959R, non-sterile, reusable 	1
	20 PO769R	ADTEC MONOPOLAR Grasping Forceps, jaw inserts, straight, 310 mm, diam. 5 mm, toothing De Bakey, fenestrated, double action, reusable 	1
	30 PM973R	Insulated outer tube, PEEK, 5 mm diam., 310 mm, to be used with AdTec monopolar, AdTec bipolar 	1
	40 PO959R	AdTec monopolar Standard ring handle, PEEK insulated, with ratchet, ratchet can be deactivated, to be used with PO182R 	1
	50 PO128R	ADTEC MONOPOLAR Grasping Forceps, complete instrument, straight, 310 mm, diam. 5 mm, serrated (coarse), fenestrated, double action, consisting of PM973R, PO647R, PO959R, reusable 	1

Pos No.	Item Code	Description / Comment	Qty.
	60 PO222R	ADTEC MONOPOLAR Grasping Forceps, straight, 310 mm, diam. 5 mm, serrated, fenestrated, short, double action, consisting of PM973R, PO775R, PO959R, reusable	1
			
	70 PO717R	MARYLAND ADTEC MONOPOLAR Dissecting Forceps, jaw inserts, curved, 310 mm, diam. 5 mm, serrated (fine), double action, reusable	1
			
	80 PM973R	Insulated outer tube, PEEK, 5 mm diam., 310 mm, to be used with AdTec monopolar, AdTec bipolar	1
			
	90 PO959R	AdTec monopolar Standard ring handle, PEEK insulated, with ratchet, ratchet can be deactivated, to be used with PO182R	1
			
	100 PO652R	ADTEC MONOPOLAR Biopsy Forceps, jaw inserts, 310 mm, diam. 5 mm, serrated, single action, reusable	1
			
	110 PM973R	Insulated outer tube, PEEK, 5 mm diam., 310 mm, to be used with AdTec monopolar, AdTec bipolar	1
			

Pos No.	Item Code	Description / Comment	Qty.
	120 PO959R	<p>AdTec monopolar Standard ring handle, PEEK insulated, with ratchet, ratchet can be deactivated, to be used with PO182R</p> 	1
	130 PL408R	<p>ADTEC Needle Holder, TC: yes, complete instrument, curved to left, diam. 5 mm, working length: 310 mm (12 1/4")</p> 	1



Intracorporeal	Description	Item No.	Diam.	Length
 1/1	Durogrip™ TC needle holder, straight	PL419R	3.5 mm	20 cm
		PL418R	3.5 mm	29 cm
 1/1	Durogrip TC needle holder, straight	PL407R	5 mm	31 cm
		PL404R	5 mm	37 cm
		PL416R	5 mm	42 cm
 1/1	Durogrip TC needle holder, curved left	PL408R	5 mm	31 cm
		PL405R	5 mm	37 cm
		PL417R	5 mm	42 cm
 1/1	Durogrip TC needle holder, curved right	PL413R	5 mm	31 cm
		PL415R	5 mm	37 cm
 1/1	"The Viper" Durogrip TC suture Assistant/ needle holder, 2 x 3 Teeth	PL409R	5 mm	31 cm
 1/1	Super righting needle holder	PL414R	5 mm	31 cm
 1/1	Durogrip TC needle holder, fenestrated	PL410R	5 mm	31 cm
 1/1	Durogrip TC needle holder, crimped/ fenestrated	PL411R	5 mm	31 cm

Quality Inspection Certificate
 Cert.-No.: 1- 010212

Aesculap AG certifies, that
our products and raw materials

Instrument-type	Steel-type	Hardness-HRC
Retractors	X20Cr13	40-48
Scissors	X50CrMoV15; X38CrMoV15	50-58
Chisel, Gouges, Curettes	X46Cr13; X20Cr13	50-58; 40-48
(Bone) Rongeur	X46Cr13	50-58
Dissecting Forceps	X15Cr13; X20Cr13	40-48
Forceps with shaft handle	X15Cr13; X20Cr13	40-48
Forceps with ring handle	X20Cr13	40-48

are designed, manufactured and tested according defined and documented specifications and procedures.

The following national and international standards and requirements were met:

- EN ISO 13485:2003 (AC 2009)
- Council Directive 93/42 EEC of 14. June 1993 concerning Medical Devices
- ISO 7153-1 (Surgical Instruments-Metallic materials; Part 1: Stainless steel)
- Others: The defined requirements and performed tests cover also corrosion analysis, cutting ability, elasticity and mechanical resistance were applicable.
 Technical / physical test according to the quality specification – passes test
 Chemical test according to the quality specification – passes test

AESCULAP AG

i. V.

 Georg Erhard
 Director Quality Management Organization

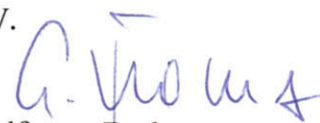
i. V.

 Wolfgang Fuchs
 Project Manager QM-Instruments

Vorsitzender des Aufsichtsrates:
 Prof. Dr. h.c. Ludwig Georg Braun

Vorstand:
 Prof. Dr. Hanns-Peter Knaebel
 (Vorsitzender)
 Dr. Harald Stallforth
 (stellv. Vorsitzender)
 Dr. Joachim Schulz

Sitz der Gesellschaft: Tuttlingen
 Reg. Gericht: Stuttgart HRB 726261
 Steuernummer: 21060/00036
 WEEE-Reg.-Nr. DE 65109852

Bankverbindungen:
Deutsche Bank AG Tuttlingen
 BLZ 653 700 75, Konto 21 22 000
 IBAN DE44 6537 0075 0212 2000 00
 SWIFT CODE: DEUT DESS 603
Baden-Württembergische Bank
 BLZ 600 501 01, Konto 487 1905
 IBAN DE31 6005 0101 0004 8719 05
 SWIFT CODE: SOLA DE ST

Hausanschrift:
 Aesculap AG
 Am Aesculap-Platz
 78532 Tuttlingen
 Deutschland

Quality Inspection CertificateCert.-No.: 1- **040710**

Aesculap AG certifies, that

our products and raw materials

are designed, manufactured and tested according defined and documented specifications and procedures.

The following national and international standards and requirements were met:

- EN ISO 13485:2016
- EN ISO 9001:2015
- Council Directive 93/42 EEC of 14. June 1993 concerning Medical Devices
- ISO 7153-1 (Surgical Instruments-Metallic materials; Part 1: Stainless steel)
- Others: ISO 7151 Surgical instruments - non-cutting, articulated instruments - general requirements and test methods (hardness: - 42-50 HRC).
ISO 7741 Instruments for surgery; Scissors and shears; General requirements and test methods (hardness: 50-58 HRC).
ASTM Designation: A 380 Standard Practice for Cleaning, Descaling and Passivation of Stainless Steel Parts, Equipment and Systems
ASTM Designation: A 967 Standard Specification for Chemical Passivation Treatments for Stainless Steel Parts
ASTM Designation F 899 Standard Specification for Wrought Stainless Steel for Surgical Instruments
DIN EN ISO 13402 Surgical and dental hand instruments - Determination of resistance against autoclaving, corrosion and thermal exposure
DIN EN 10088-1 Stainless steels - Part 1: List of stainless steels;
DIN EN 10088-2 Stainless steels - Part 2: Technical delivery conditions for sheet/plate and strip of corrosion resisting steels for general purposes
DIN EN 10088-3 Stainless steels - Part 3: Technical delivery conditions for semi-finished products, bars, rods, wire, sections and bright products of corrosion resisting steels for general purposes;
DIN 96298 Medical Instruments-Part 1-3: Terms, Measurement Methods and Testing

AESCULAP AG, 2020-06-10

i. V.

**Georg Erhard**

Director Quality Management

International Affairs - Quality Systems

i. V.

**Dr. Jennifer Grünow**

Global Regulatory Affairs

Chairman of the Supervisory Board:
Prof. Dr. Heinz-Walter GroBe**Executive Board:**
Dr. Joachim Schulz
(Chairman)
Dr. Jens von Lackum
(Deputy Chairman)
Dr. Katrin Sternberg**Corporate Office: Tuttlingen**
Register Court: Stuttgart HRB 726261
VAT reg. no. DE812160059
WEEE-Reg.-No. DE 65109852**Bank Account:**
Deutsche Bank AG Tuttlingen
BLZ 653 700 75 Konto 21 22 000 00
IBAN DE44 6537 0075 0212 2000 00
SWIFT / BIC DEUTDE33
Baden-Württembergische Bank
BLZ 600 501 01 Konto 487 1905
IBAN DE31 6005 0101 0004 8719 05
SWIFT / BIC SOLADEST**Address:**
Aesculap AG
Am Aesculap-Platz
78532 Tuttlingen
Germany