

# CERTIFICATE

No.: TM 62000796 001



## Licence holder

Company Sporttehnika LTD  
Ushinskogo 24,  
14014 Chernihov,  
Ukraine



## Manufacturing Plant

Company Sporttehnika LTD  
Ushinskogo 24,  
14014 Chernihov,  
Ukraine

## Project number

26201647 001

## Our reference

39044693

## The period of validity

from 2017-03-24 to 2020-03-23

## Scope of evaluation

EN 16630:2015

## Certification program PCWU-5

## Certified Product (Product Identification)

Permanently installed outdoor fitness equipment

Name:	Chest press	Chest press - Lat pull down	Lat pull down	Leg press
Model:	SM101	SM101-102	SM102	SM103
Dimensions: LxWxH [mm]:	1569 x 875 x 1918	1563 x 930 x 1918	1565 x 930 x 1918	1747 x 500 x 1508
Main material:	galvanized or/and powder coated steel			

Product visualization:

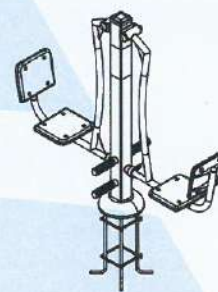
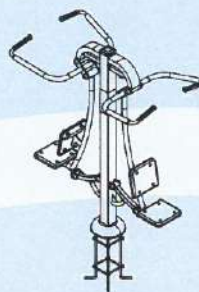
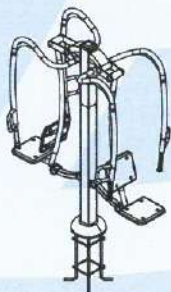

## TÜV Rheinland Polska Sp. z o.o.

ul. 17 Stycznia 56,  
02-146 Warszawa, Polska  
Tel.: (+48/22) 846 79 99  
Tel.: (+48/22) 868 37 42  
e-mail: post@pl.tuv.com



Product Certification Body

Tomasz Mańczak

Warsaw, 2017-03-24

This certificate is subjected to the Certification Regulations as well as the General Conditions of Including Transactions in TRP and refers only to the products consistent with the sample being the basis of the carried out confirmation test. This certificate alone does not entitle the holder to attach the CE marking. The validity of the certificate can be checked on [www.certpedia.com](http://www.certpedia.com)



Safety  
Regular  
Production  
Surveillance



[www.tuv.com](http://www.tuv.com)  
ID 0000051557



AC 141

TÜVRheinland®  
Precisely Right.

[www.tuv.pl](http://www.tuv.pl)

# CERTIFICATE

No.: TM 62000796 003



## Licence holder

Company Sporttehnika LTD  
Ushinskogo 24,  
14014 Chernihov,  
Ukraine

## Manufacturing Plant

Company Sporttehnika LTD  
Ushinskogo 24,  
14014 Chernihov,  
Ukraine



## Project number

26201647 001

## Our reference

39044693

## The period of validity

from 2017-03-24 to 2020-03-23

## Scope of evaluation

EN 16630:2015

## Certification program PCWU-5

## Certified Product (Product Identification)

Permanently installed outdoor fitness equipment

Name:	<b>Air Walker</b>	<b>Air Walker</b>	<b>Single Ellipse</b>	<b>Pull - up Rack</b>
Model:	SM115	SM115-T	SM116	SM117
Dimensions: LxWxH [mm]:	489 x 1012 x 1429	489 x 1000 x 1429	1396 x 566 x 1779	1125 x 1125 x 2508
Main material:	galvanized or/and powder coated steel			

Product visualization:

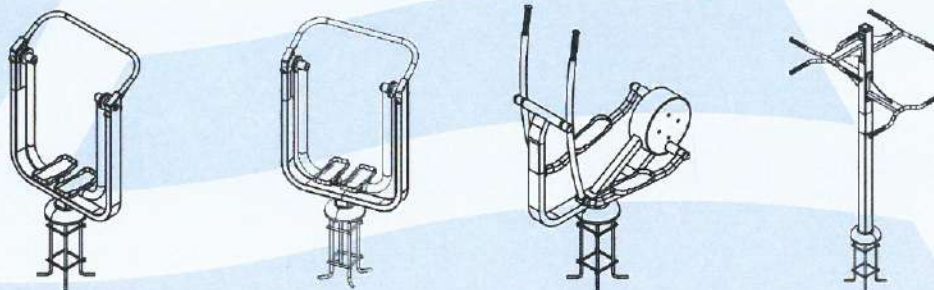

## TÜV Rheinland Polska Sp. z o.o.

ul. 17 Stycznia 56,  
02-146 Warszawa, Polska  
Tel.: (+48/22) 846 79 99  
Tel.: (+48/22) 868 37 42  
e-mail: post@pl.tuv.com



Warsaw, 2017-03-24

Product Certification Body

Tomasz Mańczak

This certificate is subjected to the Certification Regulations as well as the General Conditions of Including Transactions in TRP and refers only to the products consistent with the sample being the basis of the carried out confirmation test. This certificate alone does not entitle the holder to attach the CE marking. The validity of the certificate can be checked on [www.certipedia.com](http://www.certipedia.com)



Safety  
Regular  
Production  
Surveillance



[www.tuv.com](http://www.tuv.com)  
ID 0000051557



AC 141

TÜVRheinland®  
Precisely Right.

[www.tuv.pl](http://www.tuv.pl)

# CERTIFICATE

No.: TM 62000921 003



## Licence holder

Company Sporttehnika LTD  
Ushinskogo 24  
14014 Chernihov  
Ukraine

## Manufacturing Plant

Company Sporttehnika LTD  
Ushinskogo 24  
14014 Chernihov  
Ukraine

## Project number

2622357 001

## Our reference

84936394

## The period of validity

from 2018-09-14 to 2021-09-13

## Scope of evaluation

EN 16630:2015

## Certification program PCWU-3

## Certified Product (Product Identification)

Outdoor Fitness

Name:	Leg press	Abductor-adductor	Anatomic press	Hip extension	Stepper
Model:	SM228.1-T	SM101.1-T	SM106	SM126	SM136
Dimensions LxWxH [mm]:	1015x1123x1989	1115x1126x2056	1033x496x2051	1559x551x1108	1352x564x1458
Main material:	galvanized or/and powder coated steel, plastic				

Product  
visualization:

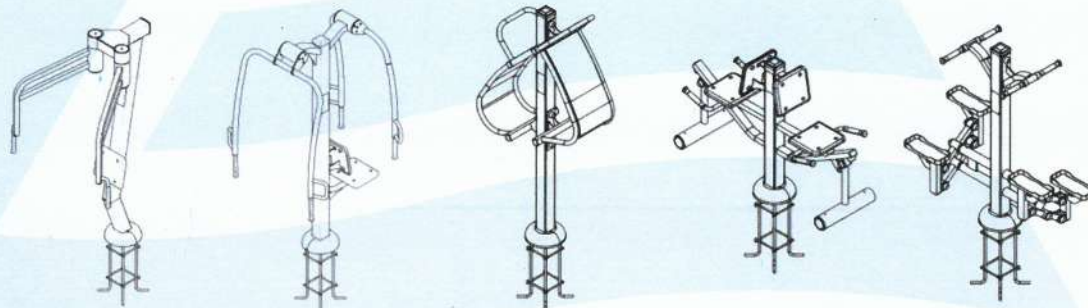

**TÜV Rheinland Polska Sp. z o.o.**  
ul. Komitetu Obrony Robotników 56  
02-146 Warszawa, Polska  
Tel.: (+48/22) 331 96 30  
Tel.: (+48/22) 331 96 31  
e-mail: post@pl.tuv.com



Warsaw, 2018-09-14

Product Certification Body

Tomasz Mańczak

This certificate is subjected to the Certification Regulations as well as the General Conditions of Including Transactions in TRP and refers only to the products consistent with the sample being the basis of the carried out confirmation test. This certificate alone does not entitle the holder to attach the CE marking. The validity of the certificate can be checked on [www.certipedia.com](http://www.certipedia.com)



Safety  
Regular  
Production  
Surveillance

[www.tuv.com](http://www.tuv.com)  
ID 0000051557



AC 141

**TÜVRheinland**<sup>®</sup>  
Precisely Right.

[www.tuv.pl](http://www.tuv.pl)

# CERTIFICATE

No.: TM 62000985 004



## Licence holder

Company Sporttehnika LTD  
Ushinskogo 24  
14014 Chernihov  
Ukraine

## Manufacturing Plant

Company Sporttehnika LTD  
Ushinskogo 24  
14014 Chernihov  
Ukraine

## Project number

26633743/2019

## Our reference

84941164

## The period of validity

from 2019-06-25 to 2022-06-24

## Scope of evaluation

EN 16630:2015

## Certification program PCWU-3

## Certified Product (Product Identification)

Permanently installed outdoor fitness equipment

Name	4 level horizontal bars	Cascade of push-ups bars	Double bar	Monkey bar	Monkey bar 1,1x2,2x2,5 m
Model	S832.4	S832.5	S832.6	S833.1	S833.2
Dimensions L x W x H [mm]	1316x1316x2705	7000x400x1027	3600x173x2705	2330x686x2705	2330x1228x2705

Visualization

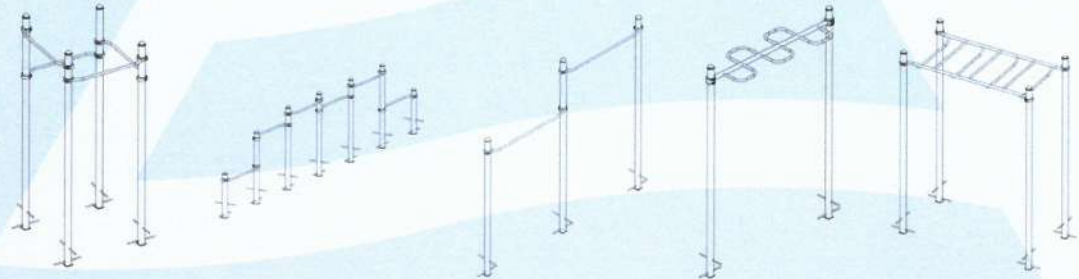

## TÜV Rheinland Polska Sp. z o.o.

ul. 17 Stycznia 56,  
02-146 Warszawa, Polska  
Tel.: (+48/22) 846 79 99  
Tel.: (+48/22) 868 37 42  
e-mail: post@pl.tuv.com



Product Certification Body

Tomasz Mańczak

This certificate is subjected to the Certification Regulations as well as the General Conditions of Including Transactions in TRP and refers only to the products consistent with the sample being the basis of the carried out confirmation test. This certificate alone does not entitle the holder to attach the CE marking. The validity of the certificate can be checked on [www.certipedia.com](http://www.certipedia.com)



Safety  
Regular  
Production  
Surveillance

[www.tuv.com](http://www.tuv.com)  
ID 0000055478



AC 141

TÜVRheinland®  
Precisely Right.

[www.tuv.pl](http://www.tuv.pl)

# CERTIFICATE

No.: TM 62000996 001



## Licence holder

Company Sporttehnika LTD  
Ushinskogo 24,  
14014 Chernihov  
Ukraine



## Manufacturing Plant

Company Sporttehnika LTD  
Ushinskogo 24,  
14014 Chernihov  
Ukraine

## Project number

26633844/2019

## Our reference

84941160

## The period of validity

from 2019-08-30 to 2022-08-29

## Scope of evaluation

EN 1176-1:2017  
EN 1176-3:2017

## Certification program PCWU-3

## Certified Product (Product Identification)

Device intended for public playground equipment

<b>Product name:</b>	Small Slide	Plastic Slide
<b>Symbol:</b>	TE101	TE110
<b>Dimensions L x W x H [mm]:</b>	2232 x 563 x 1682	4176 x 816 x 2472
<b>Max load per user [kg]:</b>	60	60
<b>Age group [year]:</b>	0 - 12	1 - 6
<b>Main material:</b>	Solid wood, painted wood, metal with powder painting, plastic, plywood	

## Visualization:

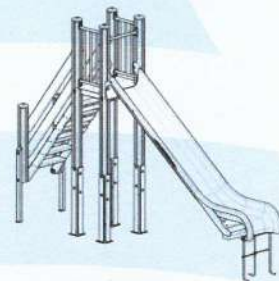

## TÜV Rheinland Polska Sp. z o.o.

ul. 17 Stycznia 56,  
02-146 Warszawa, Polska  
Tel.: (+48/22) 846 79 99  
Tel.: (+48/22) 868 37 42  
e-mail: post@pl.tuv.com



Product Certification Body

Tomasz Mańczak

Warsaw, 2019-08-30

This certificate is subjected to the Certification Regulations as well as the General Conditions of Including Transactions in TRP and refers only to the products consistent with the sample being the basis of the carried out confirmation test. This certificate alone does not entitle the holder to attach the CE marking. The validity of the certificate can be checked on [www.certipedia.com](http://www.certipedia.com)



Safety  
Regular  
Production  
Surveillance

[www.tuv.com](http://www.tuv.com)  
ID 0000046965



AC 141

TÜVRheinland®  
Precisely Right.

[www.tuv.pl](http://www.tuv.pl)

# CERTIFICATE

No.: TM 62000996 003



## Licence holder

Company Sporttehnika LTD  
Ushinskogo 24,  
14014 Chernihov  
Ukraine



## Manufacturing Plant

Company Sporttehnika LTD  
Ushinskogo 24,  
14014 Chernihov  
Ukraine

## Project number

26633844/2019

## Our reference

84941160

## The period of validity

from 2019-08-30 to 2022-08-29

## Scope of evaluation

EN 1176-1:2017  
EN 1176-5:2008

## Certification program PCWU-3

## Certified Product (Product Identification)

Device intended for public playground equipment

<b>Product name:</b>	Carousel	Small carousel	Carousel
<b>Symbol:</b>	TE211 M	TE212	TE217-R
<b>Dimensions [mm]: L x W x H</b>	1597 x 1597 x 712	897 x 897 x 697	1597 x 1597 x 791
<b>Max load per user [kg]:</b>	< 35	< 35	< 35
<b>Age group [year]:</b>	0 - 8	0 - 8	< 8
<b>Main material:</b>	Metal with powder painting, anti-slip plywood		

## Visualization:

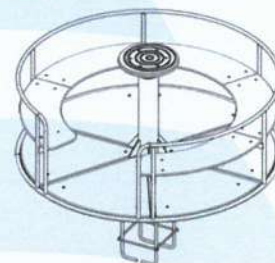
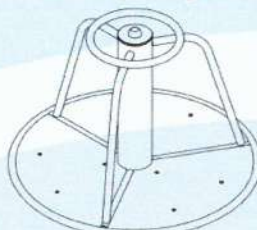
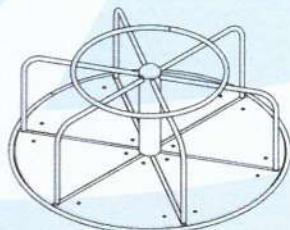

## TÜV Rheinland Polska Sp. z o.o.

ul. 17 Stycznia 56,  
02-146 Warszawa, Polska  
Tel.: (+48/22) 846 79 99  
Tel.: (+48/22) 868 37 42  
e-mail: post@pl.tuv.com



Product Certification Body

Tomasz Mańczak

Warsaw, 2019-08-30

This certificate is subjected to the Certification Regulations as well as the General Conditions of Including Transactions in TRP and refers only to the products consistent with the sample being the basis of the carried out confirmation test. This certificate alone does not entitle the holder to attach the CE marking. The validity of the certificate can be checked on [www.certipedia.com](http://www.certipedia.com)



Safety  
Regular  
Production  
Surveillance

[www.tuv.com](http://www.tuv.com)  
ID 0000046965



AC 141



TÜVRheinland®  
Precisely Right.

[www.tuv.pl](http://www.tuv.pl)

# CERTIFICATE

No.: TM 62000996 005



## Licence holder

Company Sporttehnika LTD  
Ushinskogo 24,  
14014 Chernihov  
Ukraine



## Manufacturing Plant

Company Sporttehnika LTD  
Ushinskogo 24,  
14014 Chernihov  
Ukraine

## Project number

26633844/2019

## Our reference

84941160

## The period of validity

from 2019-08-30 to 2022-08-29

## Scope of evaluation

EN 1176-1:2017

## Certification program PCWU-3

## Certified Product (Product Identification)

Device intended for public playground equipment

<b>Product name:</b>	Small sandbox 1450 x 1450	Middle sandbox
<b>Symbol:</b>	TE301	TE302
<b>Dimensions [mm]: L x W x H</b>	1450 x 1450 x 310	1950 x 1950 x 330
<b>Max load per user [kg]:</b>	60	60
<b>Age group [year]:</b>	0 - 12	0 - 12
<b>Main material:</b>	Solid wood, powder painted metal, plastic	

## Visualization:

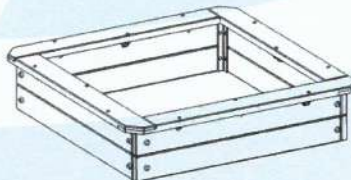

## TÜV Rheinland Polska Sp. z o.o.

ul. 17 Stycznia 56,  
02-146 Warszawa, Polska  
Tel.: (+48/22) 846 79 99  
Tel.: (+48/22) 868 37 42  
e-mail: post@pl.tuv.com



Product Certification Body

Tomasz Mańczak

Warsaw, 2019-08-30

This certificate is subjected to the Certification Regulations as well as the General Conditions of Including Transactions in TRP and refers only to the products consistent with the sample being the basis of the carried out confirmation test. This certificate alone does not entitle the holder to attach the CE marking. The validity of the certificate can be checked on [www.certipedia.com](http://www.certipedia.com)



Safety  
Regular  
Production  
Surveillance

[www.tuv.com](http://www.tuv.com)  
ID 0000046965



AC 141

TÜVRheinland®  
Precisely Right.

[www.tuv.pl](http://www.tuv.pl)

# CERTIFICATE

No.: TM 62000996 007



## Licence holder

Company Sporttehnika LTD  
Ushinskogo 24,  
14014 Chernihov  
Ukraine



## Manufacturing Plant

Company Sporttehnika LTD  
Ushinskogo 24,  
14014 Chernihov  
Ukraine

## Project number

26633844/2019

## Our reference

84941160

## The period of validity

from 2019-08-30 to 2022-08-29

## Scope of evaluation

EN 1176-1:2017  
EN 1176-3:2017

## Certification program PCWU-3

## Certified Product (Product Identification)

Device intended for public playground equipment

<b>Product name:</b>	Playground complex "Steamlet"	Playground "May"
<b>Symbol:</b>	TE701	TL103
<b>Dimensions [mm]: L x W x H</b>	3084 x 3068 x 3118	3056 x 4397 x 2495
<b>Max load per user [kg]:</b>	60	60
<b>Age group [year]:</b>	3 - 12	> 6
<b>Main material:</b>	Solid wood, metal with powder painting, plastic, plywood,	

## Visualization:

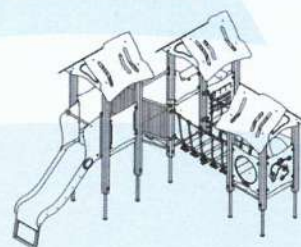
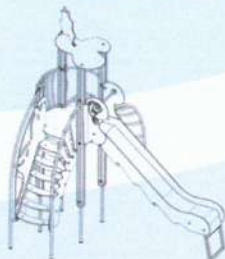

## TÜV Rheinland Polska Sp. z o.o.

ul. 17 Stycznia 56,  
02-146 Warszawa, Polska  
Tel.: (+48/22) 846 79 99  
Tel.: (+48/22) 868 37 42  
e-mail: post@pl.tuv.com



Warsaw, 2019-08-30

Product Certification Body

Tomasz Mańczak

This certificate is subjected to the Certification Regulations as well as the General Conditions of Including Transactions in TRP and refers only to the products consistent with the sample being the basis of the carried out confirmation test. This certificate alone does not entitle the holder to attach the CE marking. The validity of the certificate can be checked on [www.certipedia.com](http://www.certipedia.com)



Safety  
Regular  
Production  
Surveillance

[www.tuv.com](http://www.tuv.com)  
ID 0000046965



AC 141

TÜVRheinland®  
Precisely Right.

[www.tuv.pl](http://www.tuv.pl)



# CERTIFICATE

No.: TM 62000996 008



## Licence holder

Company Sporttehnika LTD  
Ushinskogo 24,  
14014 Chernihov  
Ukraine



## Manufacturing Plant

Company Sporttehnika LTD  
Ushinskogo 24,  
14014 Chernihov  
Ukraine

## Project number

26633844/2019

## Our reference

84941160

## The period of validity

from 2019-08-30 to 2022-08-29

## Scope of evaluation

EN 1176-1:2017  
EN 1176-2:2017

## Certification program PCWU-3

## Certified Product (Product Identification)

Device intended for public playground equipment

Product name:	Small Balancer Beam	Double swing	Double swing on chains
Symbol:	TE201	TE404	TE407
Dimensions [mm]: L x W x H	2171 x 333 x 1228	3689 x 1403 x 2173	2772 x 950 x 1827
Max load per user [kg]:	60	< 60	60
Age group [year]:	0 - 12	3 - 12	3 - 12
Main material:	Wooden beam, solid wood, metal with powder painting, chains		

## Visualization:



## TÜV Rheinland Polska Sp. z o.o.

ul. 17 Stycznia 56,  
02-146 Warszawa, Polska  
Tel.: (+48/22) 846 79 99  
Tel.: (+48/22) 868 37 42  
e-mail: post@pl.tuv.com



Product Certification Body

Tomasz Mańczak

Warsaw, 2019-08-30

This certificate is subjected to the Certification Regulations as well as the General Conditions of Including Transactions in TRP and refers only to the products consistent with the sample being the basis of the carried out confirmation test. This certificate alone does not entitle the holder to attach the CE marking. The validity of the certificate can be checked on [www.certipedia.com](http://www.certipedia.com)



Safety  
Regular  
Production  
Surveillance

[www.tuv.com](http://www.tuv.com)  
ID 0000046965



AC 141

TÜVRheinland®  
Precisely Right.

[www.tuv.pl](http://www.tuv.pl)



МІНІСТЕРСТВО ОХОРОНИ ЗДОРОВ'Я УКРАЇНИ  
ДЕРЖАВНА САНІТАРНО-ЕПІДЕМІОЛОГІЧНА СЛУЖБА

Міністерство охорони здоров'я України

(назва установи)

м. Київ, вул. Грушевського, 7

(місцезнаходження)

тел., факс: 253-94-84; 559-29-88

ЗАТВЕРДЖУЮ

Заступник головного державного  
санітарного лікаря України



Л.М. Черненко

Висновок державної санітарно-епідеміологічної експертизи

від "06" "11" 2012 р.

№ 05.03.02-07/108513

Технічні умови ТУ У 28.9-31597759 001:2012 "Обладнання дитяче ігрове"

(об'єкт експертизи)

Код ДКПП: 28.99.32-00.00

(код за ДКПП, код за УКТЗЕД, артикул)

Нормативний документ для виробництва обладнання дитячого ігрового

(сфера застосування та реалізації об'єкта експертизи)

Товариство з обмеженою відповідальністю «Компанія Спорттехніка», Україна, 14014, м. Чернігів, Новозаводський р-н, вул. Ушинського, буд. 24, код: 31597759

(розробник, адреса, місцезнаходження, телефон, факс, E-mail, WWW, код ЄДРПОУ)

Товариство з обмеженою відповідальністю «Компанія Спорттехніка», Україна, 14014, м. Чернігів, Новозаводський р-н, вул. Ушинського, буд. 24, код: 31597759

(заявник, адреса, місцезнаходження, телефон, факс, E-mail, WWW, код ЄДРПОУ)

За результатами державної санітарно-епідеміологічної експертизи об'єкт експертизи "Технічні умови ТУ У 28.9-31597759 001:2012 "Обладнання дитяче ігрове" відповідає вимогам діючого санітарного законодавства України і може бути погоджений (затверджений).

Висновок дійсний: протягом терміну дії нормативного документу-ТУ У 28.9-31597759 001:2012 "Обладнання дитяче ігрове"

При внесенні змін до нормативного документа щодо сфери застосування, умов застосування об'єкта експертизи даний висновок втрачає силу.

Комісія з державної санітарно-епідеміологічної експертизи при головному державному санітарному лікареві України Інституту екогігієни і токсикології ім. Л.І.Медведя

м. Київ, вул. Героїв Оборони, 6  
тел. 258-47-73

(найменування, місцезнаходження, телефон, факс, e-mail, www)

Протокол експертизи

№ 3/8-А-6818-12 від 31.10.2012 р.

(№ протоколу, дата його затвердження)

Голова експертної комісії

Бобильова О.О.

(прізвище, ім'я, по батькові)