



COVIDIEN

User's Guide

Valleylab™ FT10

FT Series Energy Platform

User's Guide

Valleylab™ FT10

FT Series Energy Platform

For use with software version 4.0x

Part Number: PT00093618

Preface

This guide and the equipment it describes are for use only by qualified medical professionals trained in the particular technique and surgical procedure to be performed. It is intended as a guide for using the Covidien Valleylab™ FT10 FT Series energy platform (VLFT10GEN) only. Additional technical information, such as circuit diagrams, component part lists, descriptions, calibration instructions, component-replacement instructions, and software-update instructions, is available in the Valleylab™ FT10 Energy Platform service manual.

Equipment covered in this manual

Valleylab™ FT10 FT Series Energy Platform (VLFT10GEN) with software version 4.0x

The latest versions of the FT10 user's guide and the service manual are available at: <https://quickassist.medtronic.com>.

Call these numbers to request a hardcopy of the service manual:

- USA and Canada: 1 800 255 8522 Option 2
- International: 1 303 476 7996

Limited Warranty

Covidien warrants the covered product listed below to be free from defects in material and workmanship for normal use and service for the period(s) set forth below. Covidien's obligation under this warranty is limited to the repair or replacement, at its sole option, of any product, or part thereof, which has been returned to it (or its authorized distributor) within the applicable time period shown below after delivery of the product to the original purchaser, and which examination discloses, to Covidien's satisfaction, that the product is defective. This limited warranty does not apply to any product, or part thereof, which has been repaired or altered in a way so as, in Covidien's judgment, to affect its stability or reliability, or which has been subjected to misuse, neglect, or accident.

The warranty period for this Covidien product is as follows:

Valleylab™ FT10 FT Series Energy Platform One year from date of shipping

Notwithstanding any other provision herein or in any other document or communication, Covidien's liability with respect to this limited warranty and the products sold hereunder shall be limited to the aggregate purchase price for the products sold to the customer. This limited warranty is non-transferable and runs only to the original purchaser of the covered product(s). There are no warranties which extend beyond the terms hereof. Covidien disclaims any liability hereunder or elsewhere in connection with the sale of products and for any form of indirect, tort, or consequential damages.

This limited warranty and the rights and obligations hereunder shall be construed under and governed by the laws of the State of Colorado, USA. The sole forum for resolving disputes arising under or relating in any way to this limited warranty is the District Court of the County of Boulder, State of Colorado, USA.

Covidien reserves the right to make changes in covered products built or sold by it at any time without incurring any obligation to make the same or similar changes to equipment previously built or sold by it.

THE OBLIGATION TO REPAIR OR REPLACE A DEFECTIVE OR NONPERFORMING PRODUCT IS THE SOLE REMEDY OF THE CUSTOMER UNDER THIS LIMITED WARRANTY. EXCEPT AS EXPRESSLY PROVIDED HEREIN, COVIDIEN DISCLAIMS ALL OTHER WARRANTIES, WHETHER EXPRESS OR IMPLIED, ORAL OR WRITTEN, WITH RESPECT TO PRODUCTS, INCLUDING WITHOUT LIMITATION ALL IMPLIED WARRANTIES, WARRANTIES OF MERCHANTABILITY OR FITNESS FOR A PARTICULAR PURPOSE.

Software License

Customer hereby acknowledges that Covidien LP and or its affiliates (collectively called "COVIDIEN" herein) owns the entire right, title, and interest in and to the Software, as may be installed in the Products or Equipment addressed herein or provided separately ("Software") (including all of the computer code, source and object, comprising the Software and all components and elements thereof), and all associated manuals, drawings, technical information and Documentation (collectively, the "Documentation"), including, without limitation, all patent, copyright, trademark, trade secret and other intellectual property or proprietary rights ("Intellectual Property Rights") in and to the Software and all components and elements thereof all of which shall remain the sole and exclusive property of Covidien. The amount paid by the Customer for the Products and/or Equipment incorporating the Software includes as a portion of that amount, a license fee granting Customer only the rights set forth in this Software License. This Software License will be superseded by any express Software agreement between Covidien and Customer. The use of term "Product" herein includes Products and/or Equipment as applicable.

1. Single User License Grant: COVIDIEN grants to Customer a limited, nonexclusive, non-sublicensable, nontransferable and revocable license to use the Software, exclusively at location identified by Customer on the order form as the ship-to location of the Products, solely in machine-readable object code form, and only on a single central processing unit embedded in the Products as provided by COVIDIEN under this agreement, and solely for the Customer's internal business purpose in the operation of the Products provided by COVIDIEN under this agreement. Notwithstanding anything to the contrary contained in this Agreement, the Software is licensed to be used on only one computing device or Product, and a valid license must be obtained under this Agreement for each computing device or Product with which the Software is used or in which the Software is embedded.

2. Restrictions on Use: Except to the extent expressly authorized in these Software License Terms or by law, Customer shall not and shall not cause any third part to; (i) decompile, disassemble, or reverse engineer the Software; (ii) modify or create any derivative works (including, without limitation, translations, transformations, adaptations or other recast or altered versions) of or based on the Software, or alter the Software in any way; (iii) merge the Software with any other software or product not supplied by Covidien; (iv) use, copy, sell, sublicense, lease, rent, loan, assign, convey or otherwise transfer the Software except as expressly authorized by this Agreement; (v) distribute, disclose or allow use of the Software, in any format, through any timesharing service, service bureau, network or by any other means, to or by third parties; (vi) remove or modify any copyright, confidential or proprietary markings, legends or restrictions that are in the Software originally supplied to Customer; or (vii) violate any obligations with regard to Covidien's Confidential Information (as defined below). To the extent that Customer is expressly permitted by applicable mandatory law to undertake any of the activities listed in the preceding sentence, Customer will not exercise those rights unless and until Customer has given Covidien not less than 30 days' prior written notice of Customer's intent to exercise any such rights unless an order of a government agency of competent jurisdiction will not so allow. This License will terminate immediately upon notice from Covidien if Customer fails to comply with any provision of this License or any agreement.

3. Reservation of Rights: Notwithstanding anything to the contrary contained in this Agreement, or any order form, purchase order or agreement between the parties, all rights not expressly granted by Covidien to Customer are reserved to and retained by Covidien and

Covidien expressly is not selling, assigning or otherwise transferring to Customer, and Customer is not purchasing or otherwise acquiring or obtaining, any of Covidien's Intellectual Property Rights or other rights in or to the Software or Documentation.

4. Confidentiality: Customer agrees that the Software and the Documentation, and all components and elements of the Software and Documentation, including, without limitation, the specific design and structure of individual programs, constitutes confidential information and trade secrets of Covidien (the "Confidential Information"). Customer agrees not to disclose, provide, or otherwise make available such Confidential Information, including, without limitation, any trade secrets or copyrighted material, in any form to any third party. Customer agrees that it will make the Software available only to those employees, contractors, or consultants of Customer with a specific need to know, who are obligated to comply with the restrictions contained in these Software License Terms and to maintain secrecy of the Software and all other Confidential Information and are properly trained in its use. Customer is responsible for the compliance of all users of the Software and Products with these obligations and shall cause all users of the Software and Products to comply with these obligations. Customer acknowledges that the Software embodies proprietary trade secrets of Covidien including, without limitation, technical and non-technical information regarding the Software and the development and manufacture of the same. Customer hereby agrees to maintain the confidentiality of such trade secrets using at least as great a degree of care as Customer uses to maintain the confidentiality of its own most confidential information. Customer shall communicate these obligations to those employees and agents of Customer who come into contact with the Software, and shall use its best efforts to ensure their compliance with all confidentiality obligations applicable to Customer.

5. Change Orders: Covidien shall have the right, at any time during the Term, by written request to Customer (an "Update Notice"), to require that Customer return the Products and Software to Covidien for such periods of time as are required by Covidien ("Update Periods") or to allow Covidien to access the Software at the Customer's location for the purpose of enabling Covidien to incorporate Software revisions, updates or modifications from time to time. Upon receipt of an Update Notice, Customer shall return the requested Products and Software to Covidien at Covidien's cost and expense, or work with Covidien to find a suitable time for Covidien to access the Software at the Customer's location. Customer acknowledges and agrees that during Update Periods, if the Software must be returned to Covidien, the Products and Software will be unavailable to Customer and in Covidien's possession. Covidien will use reasonable commercial efforts to perform the revisions, updates or modifications and to return the revised, updated or modified Products and Software to Customer as soon as is reasonably practicable.

6. Software License Term: The term of the Software license granted under this Software License shall be for the commercial life of the associated Product or Equipment.

7. Limited Warranty: Covidien represents and warrants to Customer that the Software will perform substantially as described in Covidien's then current Documentation for such Software and the remaining warranty, or extended warranty, if any, applicable to the Product or Equipment with which such Software was delivered. If Customer notifies Covidien of defects during the applicable warranty period, and those defects are verified by Covidien, as Customer's sole and exclusive remedy, Covidien will replace the defective Software or, at its option, terminate this Software License and refund to Customer the amount paid by Customer to Covidien for the Software (if provided separately from a Product) or for the

Product in which the defective Software is installed (if embedded within a Product). Customer's remedy for breach of this limited warranty shall be limited to the foregoing replacement or refund and shall not encompass any other damages. No dealer, distributor, agent or employee of Covidien is authorized to make any modification or addition to the warranty and remedies stated herein.

Notwithstanding these limited warranty provisions, all of Covidien's obligations with respect to such warranties shall be contingent on Customer's use of the Software in accordance with this Agreement and in accordance with Covidien's instructions as provided by Covidien in the Documentation provided by Covidien, as such instructions may be amended, supplemented, or modified by Covidien, in its sole discretion, from time to time. Covidien shall have no warranty obligations with respect to any failures of the Software that are the result of accident, abuse, misapplication, extreme power surge or extreme electromagnetic field, or any other cause outside of Covidien's control.

This limited warranty does not apply to any damages, malfunctions, or non-conformities caused to or by; (i) Customer's use of Software in violation of these Software License Terms or in a manner inconsistent with any Documentation or instructions provided by Covidien; (ii) use of non-Covidien furnished equipment, software, or facilities with its equipment or Products; (iii) Customer's failure to follow Covidien's installation, operation, repair or maintenance instructions; (iv) Customer's failure to permit Covidien timely access, remote or otherwise, to Products; (v) failure to implement all features, revisions, modifications, updates, patches, "bug fixes", or new versions of or to the Software provided by Covidien under this Agreement or otherwise; (vi) Products with their original manufacturer's serial numbers altered, defaced or deleted; (vii) Products that have been altered, serviced or modified by a party other than Covidien; or (viii) Software that has been subjected to abnormal physical or electrical stress, misuse, negligence or accident by Customer or a third party.

8. Export Laws: THESE SOFTWARE TERMS ARE EXPRESSLY MADE SUBJECT TO ANY AND ALL LAWS, REGULATIONS, ORDERS, OR OTHER RESTRICTIONS WITH RESPECT TO THE EXPORT FROM THE UNITED STATES OF AMERICA OF THE SOFTWARE. BUYER SHALL NOT EXPORT OR RE-EXPORT THE SOFTWARE (I) WITHOUT FULL COMPLIANCE WITH SUCH LAWS, REGULATIONS, ORDERS AND OTHER RESTRICTIONS, INCLUDING, WITHOUT LIMITATION, OBTAINING ALL NECESSARY APPROVAL FROM ALL REQUIRED GOVERNMENTAL AGENCIES AND (II) WITHOUT THE PRIOR WRITTEN CONSENT OF COVIDIEN.

9. U.S. Government Rights. The Software is a "commercial item" developed exclusively at private expense, consisting of "commercial computer software" and "commercial computer software Documentation" as such terms are defined or used in the applicable U.S. acquisition regulations. The Software is licensed hereunder (i) only as a commercial item and (ii) with only those rights as are granted to all other customers pursuant to the terms and conditions of this License. Customer shall not use, duplicate, or disclose the Software in any way not specifically permitted by this License. Nothing in this License requires Covidien to produce or furnish technical data for or to Customer.

10. Survival. Sections 2, 3, 4, 8, 9 and this Section 10 shall survive the termination or expiration of these Software License Terms.

Table of Contents

Preface	ii
Equipment covered in this manual	ii
Limited Warranty	iii
Software License.....	iv
Chapter 1. Overview and General Features	
The Valleylab™ FT10 Energy Platform	1-2
Introduction	1-2
Front Panel	1-3
Rear Panel	1-4
Modes & Settings	1-5
System Conventions	1-16
Touchscreen	1-16
System Buttons	1-18
Interface Conventions.....	1-19
Chapter 2. Warnings and Precautions for Patient and Operating Room Safety	
Conventions Used in this Guide	2-1
General Warnings and Precautions	2-2
Fire/Explosion Hazards	2-2
System Setup Warnings and Precautions.....	2-3
Warnings and Precautions for the Energy Platform	2-6
Warnings and Precautions for Active Instruments	2-7
Warnings for Implanted Electronic Devices (IEDs)	2-8
Post Surgery Safety Issues	2-9
Warnings and Precautions for Monopolar Procedures.....	2-9
Warnings and Precautions for Patient Return Electrodes.....	2-10
Inadvertent Radio Frequency (RF) Burns	2-11
Warnings and Precautions for Laparoscopic Procedures.....	2-13
Warnings and Precautions for Bipolar Procedures	2-14
Warnings and Precautions for LigaSure™ Technology Procedures.....	2-14
Warnings and Precautions for Bipolar Resection	2-15
Warnings and Precautions for Cardioblate™ Ablation Procedures.....	2-15
Contraindications for the Cardioblate™ Ablation System	2-15
Cardioblate™ Ablation System Operation	2-18
Cardioblate™ Ablation System Adverse Events	2-19
Shunt Cords	2-19

Conductive Fluid In the Surgical Site.....	2-19
Servicing	2-20

Chapter 3. System Setup

Setup.....	3-2
Unpacking the System	3-2
Before Starting the System	3-2
Turning On the Valleylab™ FT10 Energy Platform.....	3-3
Turning Off the Valleylab™ FT10 Energy Platform	3-3
Saved Settings.....	3-4
Selecting and Editing a Group	3-5
Renaming a Group	3-7
Deleting Groups	3-7
Favorite Settings.....	3-9
Favorite Options	3-9
Adding a Favorite.....	3-10
Editing a Favorite	3-12
Renaming a Favorite	3-13
Deleting a Favorite.....	3-13
Recent Settings	3-14
System Functions	3-15
On/Off.....	3-15
Restore Settings.....	3-15
Audio Volume	3-16
Service and Settings	3-17
Service and Settings.....	3-17
Logs	3-18
DEMO Mode	3-19
System Menu	3-20
Service Menu	3-21
Language Selection Menu.....	3-21

Chapter 4. Monopolar

Front Panel Monopolar Features	4-2
Rear Panel Monopolar Features	4-3
Monopolar Quick Setup Instructions.....	4-4
Monopolar Function Overview	4-5
Monopolar Power Output Modes	4-5
Foot Pedal.....	4-5
Monopolar Foot-Pedal Activation.....	4-6
Return Electrodes – REM™ Contact Quality Monitoring System	4-6
Patient Return Electrode Considerations	4-7

How the REM™ System Works	4-7
Patient Return Electrode Setup	4-8
Monopolar Electrodes	4-10
Monopolar Mode Settings	4-10
VALLEYLAB™ Mode Functionality	4-12
Using a VALLEYLAB-Mode Instrument	4-13
SHARED COAG Functionality	4-14
Closing Monopolar Settings Window	4-16
After Surgery	4-17
Disconnect the instruments	4-17

Chapter 5. Bipolar

Front Panel Bipolar Features	5-2
Rear Panel Bipolar Features	5-2
Bipolar Quick Setup Instructions	5-3
Bipolar Function Overview	5-3
Bipolar Power Output Modes	5-3
Bipolar Default Settings	5-4
Foot Pedal	5-4
Virtual Ammeter	5-5
Setting the Ammeter	5-5
Auto Bipolar Function	5-6
Turning Auto Bipolar ON/OFF	5-6
Auto Bipolar Activation Impedance	5-7
Setting the Auto Bipolar Activation Delay	5-7
Closing the Bipolar Settings Window	5-8
Bipolar Adapter	5-8
After Surgery	5-9
Disconnect the instruments	5-9

Chapter 6. LigaSure™ Technology

Front Panel LigaSure™ Technology Features	6-2
Rear Panel LigaSure™ Technology Features	6-2
LigaSure™ Technology Quick Setup Instructions	6-3
LigaSure™ Technology Function Overview	6-4
LigaSure™ Technology Default Settings	6-5
LigaSure™ Technology/Bipolar Receptacle	6-5
Foot Pedal	6-6
LigaSure™ Technology Instruments	6-6
Reusable-Instrument Assembly	6-6

Connecting LigaSure™ Technology Instruments to the Energy Platform	6-6
Activating the LigaSure™ Technology Instrument	6-10
Alert Situations	6-10
BiZact™ Function Overview	6-12
After Surgery	6-13
Disconnect the instruments	6-13

Chapter 7. Bipolar Resection

Front Panel Bipolar Resection Features	7-2
Rear Panel Bipolar Resection Features	7-2
Bipolar Resection Quick Setup Instructions	7-3
Bipolar Resection Function Overview	7-3
LigaSure™ Technology/Bipolar Receptacle	7-4
Bipolar Resection Default Settings	7-4
Foot Pedal	7-5
Connecting Bipolar Resection Instruments to the VLFT10GEN ...	7-6
Bipolar Resection Settings	7-6
Changing the Energy-Delivery Setting	7-6
Activating a Bipolar Resection Instrument	7-7
Incorrect Foot-Pedal Error	7-7
After Surgery	7-8
Disconnect the Instruments	7-8

Chapter 8. Cardioblate™ Surgical Ablation System

Front Panel Cardioblate™ Ablation Features	8-2
Rear Panel Cardioblate™ Ablation Features	8-2
Cardioblate™ Ablation System Quick Setup Instructions	8-3
Cardioblate™ Ablation System Function Overview	8-4
Monopolar Mode	8-4
Cardioblate™ Ablation System Default Settings	8-5
Cardioblate™ Ablation System Receptacles	8-5
Monopolar 2 Receptacle	8-5
LigaSure™ Technology/Bipolar Receptacle	8-5
Cardioblate™ Ablation System Single Foot Pedal for Monopolar and Bipolar	8-6
Cardioblate™ Ablation System Instruments and Devices	8-6
Connecting Monopolar Cardioblate™ Devices to the Energy Platform	8-6
Connecting Bipolar Cardioblate™ Devices to the Energy Platform	8-7

Cardioblate™ Ablation System Monopolar Settings	8-8
Changing the Cardioblate™ Ablation System	
Monopolar Energy-Delivery Setting	8-8
Cardioblate™ Ablation System Bipolar Settings	8-9
Switching between Cardioblate™ Ablation System	
Monopolar and Bipolar Operation	8-9
Activating a Cardioblate™ Ablation System Monopolar Pen	8-10
Activating a Cardioblate™ Ablation System Bipolar Device	8-10
Transmurality Indicator for Bipolar Lesions	8-11
Alert Situations	8-12
High Impedance Detected	8-12
Low Impedance Detected	8-13
Prolonged Activation	8-13
Return Electrode Over-Temperature	8-14
Verification Error	8-14
Cardioblate™ Ablation System Historical Graph Review	8-15
Cardioblate™ Ablation System Historical Graph Data Export	8-15
After Surgery	8-16
Disconnect the instruments/devices	8-16
Chapter 9. Troubleshooting	
General Troubleshooting Guidelines	9-2
REM Alarms	9-2
Correcting a REM-Alarm Condition	9-2
Correcting Malfunctions	9-3
System Errors	9-8
Chapter 10. Maintenance and Repair	
Responsibility of the Manufacturer	10-2
Routine Maintenance and Periodic Safety Checks	10-2
Cleaning	10-3
Product Service	10-3
Returning the Energy Platform for Service	10-4
Software Updates	10-4
Updating Energy Platform Software	10-5
Service Manual Copies and Updates	10-6
Covidien Technical Service	10-6
Training/Education	10-6
Chapter 11. Technical Specifications	
Valleylab™ FT10 Energy Platform Specifications	11-2

General	11-2
Dimensions and Weight	11-2
Environmental Parameters	11-3
Input Power	11-3
Power Cord Specifications	11-4
Backup Power	11-4
Equipotential Ground Connection	11-4
EKG Blanking and Smoke Evacuation	11-4
Internal Memory	11-5
Duty Cycle	11-5
Leakage	11-5
Radio Frequency Identification (RFID)	11-6
FCC Statement	11-6
Ethernet	11-7
USB	11-7
Monopolar 2 Communication	11-7
Symbols Used	11-7
Standards and IEC Classifications	11-11
Class I Equipment (IEC 60601-1)	11-11
Type CF Equipment/Defibrillator Proof (IEC 60601-1, IEC 60601-2-2, and ANSI/AAMI HF18)	11-11
IP21 Liquid Ingress/Spillage (IEC 60601-1 and IEC 60601-2-2)	11-11
Voltage Transients – Energy Platform Mains Transfer (IEC 60601-1, IEC 60601-2-2, and ANSI/AAMI HF18)	11-11
CISPR 11 Class A	11-12
Electromagnetic Compatibility (IEC 60601-1-2 and IEC 60601-2-2)	11-12
Return Electrode Monitor (REM)	11-12
Auto Bipolar	11-14
Audio Tones	11-15
Displayed Time Accuracy	11-17
Energy Output Characteristics	11-17
Output Waveforms	11-19
Output Power vs. Resistance Graphs	11-21
Monopolar Graphs	11-21
Bipolar Graphs	11-36
Discontinuous Power Curves	11-52

Chapter 1

Overview and General Features

This chapter provides an overview of the features and functions of the Valleylab™ FT10 FT Series energy platform.

Precaution

Read the instructions, warnings, and precautions provided with this energy platform and associated accessories before using. Specific instructions for electro-surgical instruments are not included in this manual.

The Valleylab™ FT10 Energy Platform

Introduction

The Valleylab™ FT10 FT Series Energy Platform (VLFT10GEN) provides RF energy for monopolar and bipolar surgical applications, tissue-fusion and vessel-sealing applications, and cardiac applications. It features a touchscreen divided into four quadrants for viewing settings, user input of settings, and options available for any application. The energy platform automatically detects coded handsets and configures the energy platform accordingly. Safety and diagnostic functionality include automatic fail-safe functions.

The Valleylab™ FT10 Energy Platform, applied parts (patient return electrodes and active instruments) are designed to work as a system. Covidien offers a selection of patient return electrodes and active instruments that are fully compatible with this energy platform.

- Refer to each instrument's instructions for use (IFU) for indications, warnings, and specific contraindications.
- When considering other manufacturers' patient return electrodes and/or active instruments, customers should seek detailed user instructions and warning information from the manufacturer.

The energy platform is intended for use in general surgery and such surgical specialties as urologic, vascular, thoracic, plastic, gynecologic, reconstructive, cardiac, and colorectal surgery.

Indications for Use

The Valleylab™ FT10 Energy Platform is a high frequency electrosurgical generator intended for use with monopolar and bipolar accessories for cutting and coagulating tissue. When used with compatible sealing devices, it is indicated for sealing vessels up to and including 7 mm, tissue bundles, and lymphatics. When used with compatible ablation devices it is indicated for cardiac tissue ablation.

The generator can also be used with compatible resectoscopes for endoscopically controlled removal or coagulation of tissue using 0.9% NaCl solution as the irrigation medium.

The tissue fusion function has not been shown to be effective for tubal sterilization or tubal coagulation for sterilization procedures. Do not use this function for these procedures.

Contraindications

The cardiac tissue ablation feature is contraindicated for patients that have active endocarditis at the time of surgery.

Ablation in a pool of blood is contraindicated (for example, through a purse string suture).

Front Panel

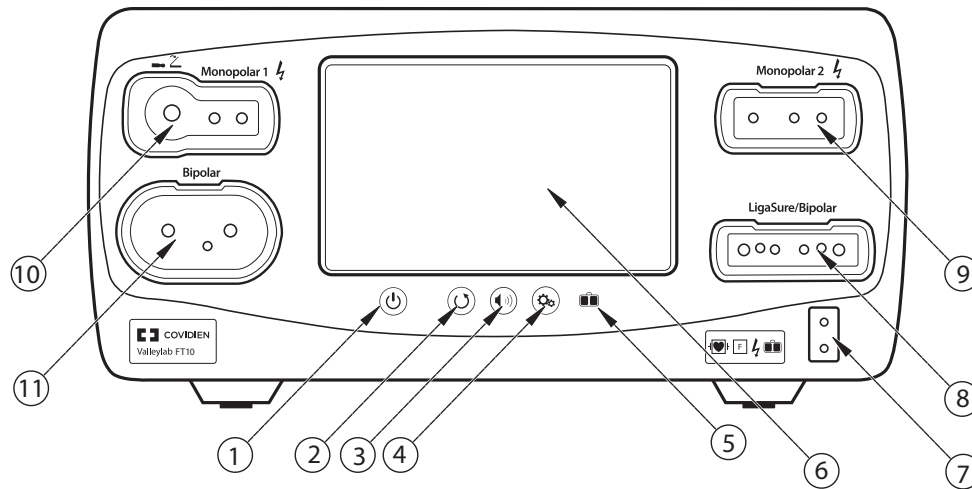

- ① On/Off button
- ② Restore Settings button
- ③ Audio Volume control button
- ④ Service/Settings button
- ⑤ REM™ (Return Electrode Monitoring) indicator
- ⑥ Interface touchscreen
- ⑦ REM patient return electrode receptacle
- ⑧ LigaSure™ technology/Bipolar receptacle
- ⑨ Monopolar 2 instrument receptacle
- ⑩ Monopolar 1 Universal Foot Pedal Port (UFP) receptacle
- ⑪ Bipolar instrument receptacle

Rear Panel

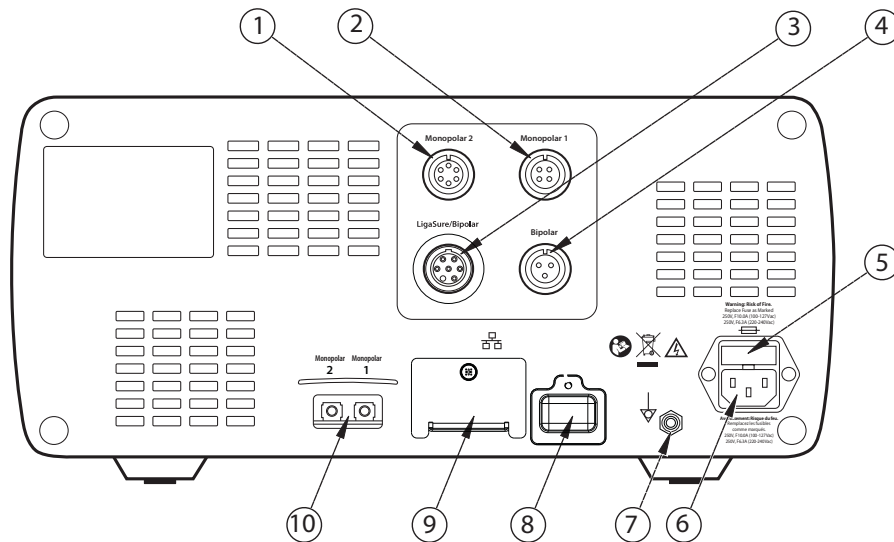

- ① Monopolar 2 foot-pedal receptacle (requires included adapter to connect standard four-pin monopolar foot pedal)
- ② Monopolar 1 foot-pedal receptacle
- ③ LigaSure™ technology/Bipolar foot-pedal receptacle (requires included adapter to connect a bipolar resection foot pedal)
- ④ Bipolar foot-pedal receptacle
- ⑤ Fuse drawer
- ⑥ Power cord receptacle
- ⑦ Equipotential ground connection
- ⑧ Service receptacle (Covered. For service only.)
- ⑨ Ethernet receptacle (Covered. For service only.)
- ⑩ Interlink cable receptacles for EKG blanking and smoke-evacuation control

Modes & Settings

The Valleylab™ FT10 energy platform provides the following modes and settings for a variety of surgical procedures:

Monopolar modes	Power-Setting Ranges	Peak Voltage
· CUT		
- PURE	Off, 1–300 W	1287 V
- BLEND	Off, 1–200 W	2178 V
· VALLEYLAB	5–60 W	2783 V
· COAG		
- SOFT	Off, 1–120 W	264 V
- FULGURATE	Off, 1–120 W	3448 V
- SHARED FULGURATE	Off, 1–120 W	3448 V
- SPRAY	Off, 1–120 W	3932 V
- SHARED SPRAY	Off, 1–120 W	3932 V
Bipolar modes		
· PRECISE	Off, 0.5–70 W	184 V
· STANDARD	Off, 1–70 W	415 V
· MACRO	Off, 1–70 W	530 V
LigaSure™ technology (tissue fusion)	No power settings	244 V
Bipolar Resection effects		
· CUT	1–6	849 V
· COAG	1–6	318 V
Cardioblate™ Ablation		
· Monopolar	Off, 1–50 W	382 V
· Bipolar	No power Settings	382 V

Electrosurgical Monopolar Modes

The system produces six modes of monopolar power output for electrosurgery.

Precaution

To provide expected functionality from a hand piece, proper insertion is required. Refer to the alignment dots below the receptacles for proper insertion orientation.

CUT Modes

- **PURE CUT** provides a clean, precise cut in any tissue with little or no hemostasis.
- **BLEND CUT** is a conventional blended waveform that provides slower cutting with simultaneous hemostasis.

VALLEYLAB™ mode

- **VALLEYLAB** mode is a unique combination of hemostasis and dissection that allows the user to slow down for more hemostasis and speed up for faster dissection.

COAG Modes

- **SOFT** desiccates tissue at a relatively slower rate with deeper thermal penetration. It is typically performed with a ball electrode and a saline drip.
- **FULGURATE** coagulates tissue by sparking from the active electrode, through air, to the patient tissue.
- **SPRAY** delivers wider fulguration; penetration is shallower and the affected tissue area is larger than with the FULGURATE mode.
- **SHARED** allows two monopolar instruments to activate simultaneously in either FULGURATE or SPRAY modes. A single power setting is provided and power is shared between the two instruments.

Note: SOFT and SHARED COAG modes are features that are not available on the clinical screen until they have been enabled. These features can be enabled through Valleylab™ Exchange by a Covidien sales representative.

Compatible Monopolar Instruments & Devices

The following Covidien catalog numbers for monopolar surgical instruments, return electrodes, foot pedals, and adapters are fully compatible with the Valleylab™ FT10 energy platform.

Monopolar UFP Instruments (connect only to Monopolar 1)

E05021 Monopolar Adapter
E050212 Monopolar Adapter

The Monopolar 1 UFP-receptacle, identified by a blue ring, accepts UFP connectors with diameters of 4 mm to 8 mm, and lengths of 15.2 mm to 41.7 mm. UFP connectors with a diameter of less than 4 mm require an adapter to connect to the Monopolar 1 UFP receptacle.

Monopolar Instruments (connect only to Monopolar 2 receptacle)

FT3000DB Force TriVerse™ Electrosurgical Device
FT3000 Force TriVerse™ Electrosurgical Device

Monopolar Instruments (connect to either Monopolar 1 or Monopolar 2)

This energy platform is designed for use with Covidien monopolar instruments. However, other monopolar instruments are compatible with the Valleylab™ FT10 energy platform if they have a connector that matches the following figure, are rated for peak voltages of at least 3932 V, and have a total length no greater than 17 ft (5.2 m).

Monopolar

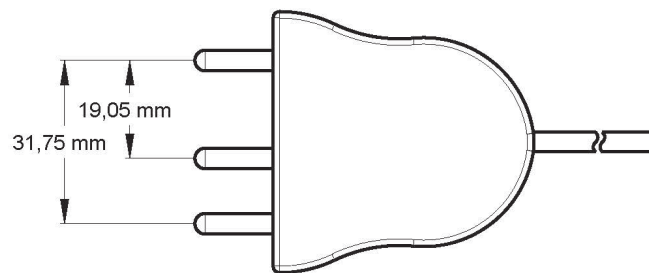

Utilizes 4 mm banana pins

Return Electrodes (Monitoring)

E0560 Valleylab™ REM Patient Return Electrode Cord
E7507 REM Polyhesive™ Adult Patient Return Electrode
E7507DB REM Polyhesive™ Adult Patient Return Electrode
E7508 REM Polyhesive™ Adult Cordless Patient Return Electrode
E7509 REM Polyhesive™ Adult Cordless Patient Return Electrode
E7509B REM Polyhesive™ Adult Cordless Patient Return Electrode
E7510-25 REM Polyhesive™ Infant Patient Return Electrode
E7510-25DB REM Polyhesive™ Infant Patient Return Electrode
E7512 REM Polyhesive™ Neonatal Patient Return Electrode

Return Electrodes (Non-Monitoring, for use in DEMO mode only. Not for clinical use.)

E7506 Non-REM Polyhesive™ Patient Return Electrode
--

REM Connector

E0507B Valleylab™ Multiple Return/S Cord Adapter
--

The Covidien return electrodes have a total length no greater than 16 ft (4.9 m).

REM Connector

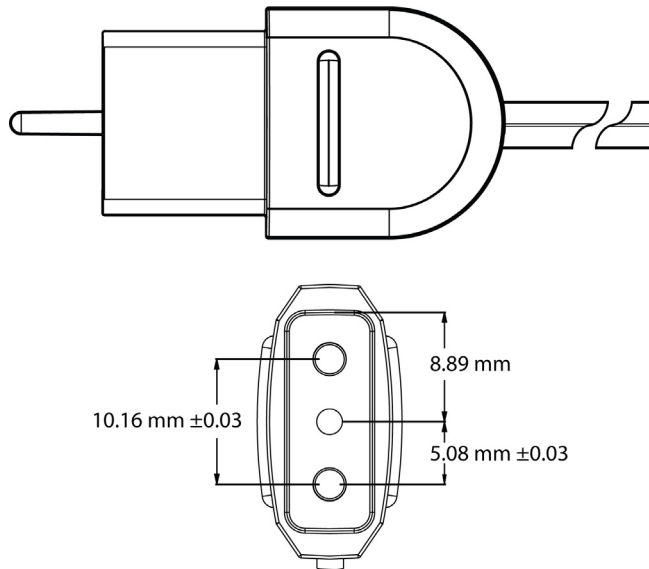

Foot Pedals

The Covidien foot pedals have a total length no greater than 16 ft (4.9 m).

FT6003 ForceTriad™ Three-pedal Footswitch (Monopolar 2 only)
E6008 Valleylab™ Monopolar Footswitch (Monopolar 1, Monopolar 2 with adapter)
E6008B Valleylab™ Monopolar Footswitch (Monopolar 1, Monopolar 2 with adapter)
1017577 6-pin to 4-pin Monopolar Footswitch Adapter (Monopolar 2 only)

Bipolar Modes

Selection of bipolar modes and power settings is dependent on surgeon preferences, tissue characteristics, accessories selection, and the intended clinical application.

PRECISE mode may be used when it is essential to maintain a high degree of precision and fine control over the amount of desiccation. Voltage is kept low to prevent sparking. Power remains constant over a specific range of tissue resistance, allowing a consistent tissue effect.

STANDARD mode may be used for most bipolar applications. Voltage is kept low to prevent sparking. Power remains constant over a specific range of tissue resistance, allowing a consistent tissue effect.

MACRO mode may be used for bipolar cutting or rapid coagulation. Voltage is higher and there is more power than in the other available bipolar modes.

Mode Setting	Power Setting Range	Optimized Instrumentation
PRECISE	0.5—70 watts (0.5 watt increments up to 10 watts)	<ul style="list-style-type: none"> • Small surface-area instruments • Micro-tip forceps (0.4—2.2 mm)
STANDARD	1—70 watts	<ul style="list-style-type: none"> • Medium surface-area instruments • Micro-tip forceps (1.0—2.2 mm) • Small paddle lap forceps • Bipolar scissors
MACRO	1—70 watts	<ul style="list-style-type: none"> • Large surface-area instruments • Large paddle lap forceps

Auto Bipolar

The Auto Bipolar feature senses tissue impedance between the two bipolar electrodes, then uses the impedance information to automatically start or stop bipolar RF energy delivery. Optionally, the user may select a timed activation delay for auto start of RF activation.

Note: When using Auto Bipolar, the tissue in the grasp of the bipolar device must have an impedance less than 2200 Ω . The activation impedance safety feature will not deliver RF power to the tissue if it is not within the specified range. This is a factory-set value that cannot be reset by the user.

Note: Auto Bipolar is a feature that is not available on the clinical screen until it is enabled. This feature can be enabled through Valleylab™ Exchange by a Covidien sales representative.

Important

If the VLFT10ADP1 bipolar adapter is used, only one bipolar instrument can set the Auto Bipolar feature to ON.

Precaution

Do not use instruments with flying leads with the Valleylab™ FT10 energy platform.

Do not use the FT0501 ForceTriad™ bipolar adapter on the Valleylab™ FT10 energy platform.

Compatible Bipolar Instruments & Devices

The Valleylab™ FT10 energy platform is designed for use with Covidien bipolar instruments. However, other bipolar instruments are compatible with the FT10 if their connectors match

the following illustration, are rated for peak voltages of at least 531 V, and have a total length no greater than 16 ft (4.9 m).

Bipolar

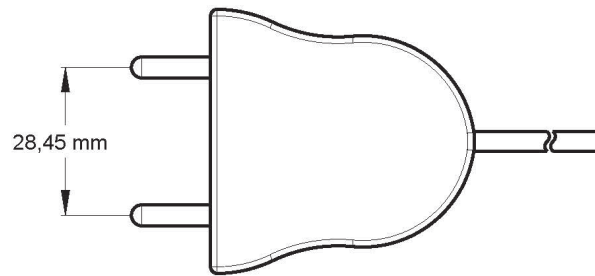

Utilizes 4 mm banana pins

Bipolar with Handswitching

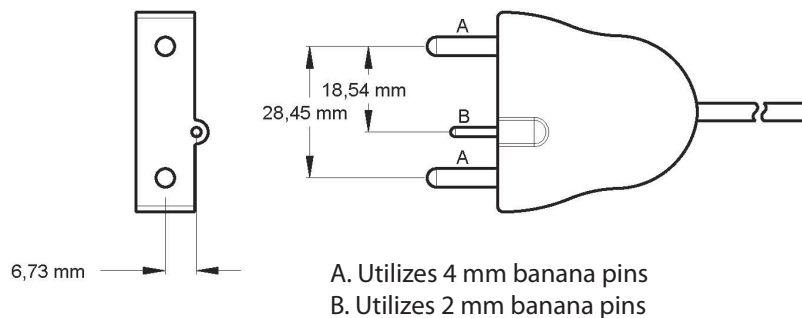

The following Covidien catalog numbers for bipolar foot pedals are fully compatible with the Valleylab™ FT10 energy platform. They have a total length no greater than 16 ft (4.9 m).

Foot Pedals

E6009 Valleylab™ Bipolar Standard Footswitch
E6009B Valleylab™ Bipolar Standard Footswitch
E6019 Valleylab™ Bipolar Dome Footswitch

Bipolar Adapter

The VLFT10ADP1 Bipolar Adapter allows bipolar instruments to connect to the LigaSure™ technology/Bipolar receptacle, thereby enabling the use of a second bipolar instrument.

LigaSure™ Technology

LigaSure™ technology tissue fusion can be used on arteries, veins, pulmonary vasculature, and lymphatics—up to and including 7 mm in diameter—and tissue bundles. When used with compatible instruments, the system provides precise energy delivery and electrode pressure to vessels for a controlled time period to achieve a complete and permanent fusion of the vessel lumen. The system is designed to produce minimal sticking, charring, and thermal spread to adjacent tissue.

Warning

The tissue fusion function has not been shown to be effective for tubal sterilization or tubal coagulation for sterilization procedures. Do not use this function for these procedures.

LigaSure™ Technology Instruments

The LigaSure™ technology instruments that complete the Valleylab™ FT10 energy platform tissue-fusion system include reusable and single-use instruments for open and laparoscopic procedures. Each reusable instrument requires a corresponding single-use electrode. The LigaSure™ technology function is only available when using compatible instruments.

Compatible LigaSure™ Technology Instruments & Devices

This energy platform is designed for use with Covidien LigaSure™ technology instruments that have a connector that matches the following figures, are rated for peak voltages of at least 244 V, and have a total length no greater than 12.5 ft (3.8 m). However, it does not recognize all LigaSure™ technology instruments. Please refer to the cover of the instructions for use to confirm if a specific LigaSure™ technology catalog number is compatible with the Valleylab™ FT10 energy platform.

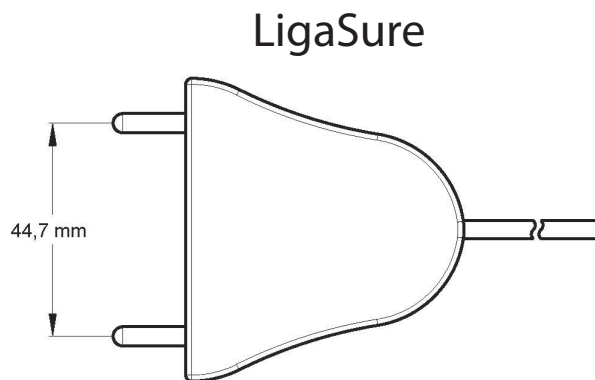

Utilizes 4 mm banana pins

LigaSure with Switching

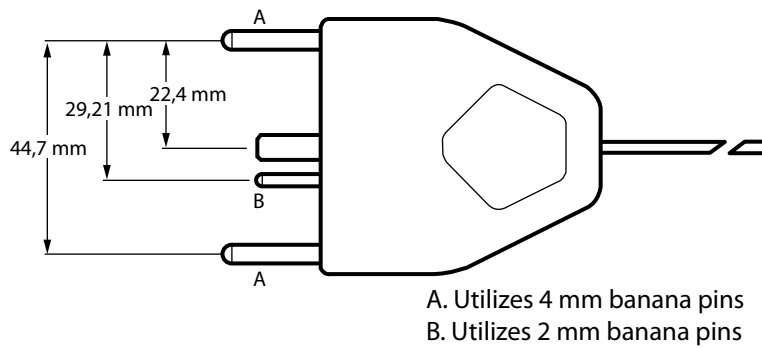
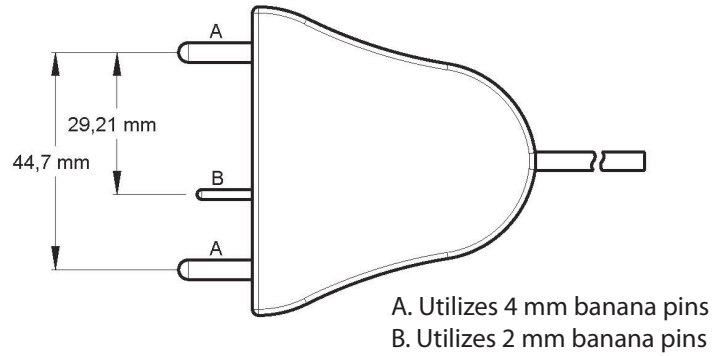

The following LigaSure™ foot pedal is fully compatible with the Valleylab™ FT10 energy platform. It has a total length no greater than 16 ft (4.9 m).

Foot Pedal

LS0300 Tissue Fusion Footswitch, Purple

Bipolar Resection

Bipolar Resection configures the LigaSure™ technology/Bipolar receptacle to use bipolar resection resectoscopes. The accessories have a total length no greater than 17 ft (5.2 m).

Accessories

FT0021S ForceTriad™ Bipolar Resection Cord
FT0022W ForceTriad™ Bipolar Resection Cord
FT6009 ForceTriad™ FT Series Bipolar Resection Footswitch (with adapter)
1060355 Valleylab™ FT10 Bipolar Resection Footswitch Adapter

Effect-Settings Reference Chart

Effect Setting	CUT Initiation Average Power (watts)	CUT Therapeutic Power (watts)	CUT Therapeutic (max RMS volts)	COAG (max RMS volts)
1	189.5	135	300	25
2	189.5	157	310	50
3	189.5	186	320	75
4	189.5	220	330	100
5	189.5	260	340	125
6	189.5	300	350	150

Cardioblate™ Ablation System

The Cardioblate™ surgical ablation system is designed to deliver radiofrequency (RF) energy to selected sites using a Cardioblate™ surgical ablation device.

Note: Cardioblate™ ablation is a feature that is not available on the clinical screen until it has been enabled. This feature can be enabled through Valleylab™ Exchange by a Covidien sales representative.

Cardioblate™ Ablation System Instruments and Devices

The Cardioblate™ instruments that allow the cardiac ablation capability include single-use instruments. Cardioblate™ ablation energy delivery is only available when using compatible instruments.

Cardioblate™ Ablation System Return Electrodes (Monitoring)

Utilize adult patient return electrodes with Cardioblate™ monopolar.

E7507 REM Polyhesive™ Adult Patient Return Electrode
E7507DB REM Polyhesive™ Adult Patient Return Electrode
E7508 REM Polyhesive™ Adult Cordless Patient Return Electrode

E7509 REM Polyhesive™ Adult Cordless Patient Return Electrode
E7509B REM Polyhesive™ Adult Cordless Patient Return Electrode

Cardioblate™ Ablation System Monopolar Pens

The energy platform is designed for use with Medtronic Cardioblate™ ablation system monopolar instruments with a connector that matches the following figure, are rated for peak voltages of at least 382 V, and have a total length no greater than 17 ft (5.2 m).

Cardioblate™ Ablation System Monopolar Pens

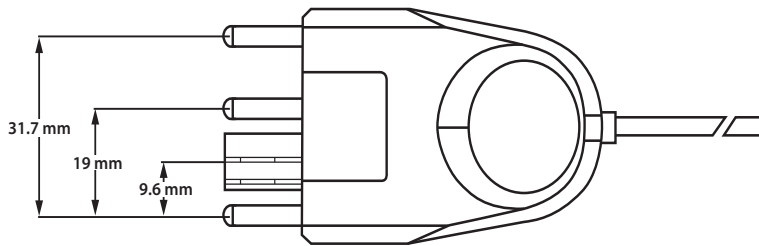

Cardioblate™ Ablation System Bipolar Instruments and Devices

The energy platform is designed for use with Medtronic Cardioblate™ ablation system bipolar instruments with a connector that matches the following figure, are rated for peak voltages of at least 382 V, and have a total length no greater than 17 ft (5.2 m).

Cardioblate™ Ablation System Bipolar Instruments and Devices

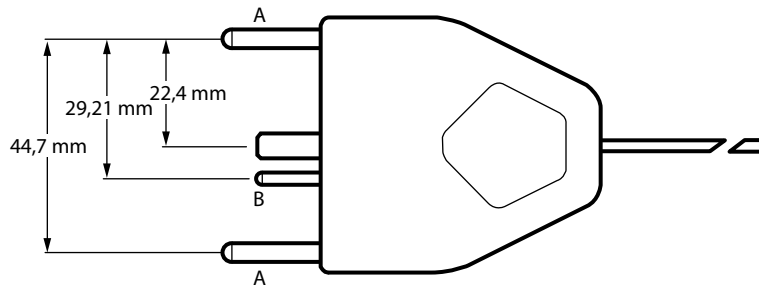

A. Utilizes 4 mm banana pins
 B. Utilizes 2 mm banana pins

Cardioblate™ Ablation System Monopolar and Bipolar Foot Pedal

LS0300 Tissue Fusion Footswitch, Purple

Connection to External Systems

The Valleylab™ FT10 energy platform can be connected to an external system. For example, connections can be made to enable smoke evacuation or EKG blanking during monopolar

activation, or provide argon-enhanced coagulation. Refer to the external system user's guide for detailed instructions regarding how to connect it to the energy platform.

There are two external system receptacles on the back of the Valleylab™ FT10 energy platform that can signal RF activation. The receptacles are labeled Monopolar 1 and Monopolar 2. The way the receptacles signal RF activation is dependent upon the country code selection of the energy platform. This is done to meet the smoke evacuation regulations of each country. Upon setting the country code, one of the following behaviors will signal RF activation:

- both external system receptacles signal any monopolar RF activation.
- both external system receptacles signal any monopolar or bipolar RF activation.
- both external system receptacles signal any RF activation.

External Systems Compatible with the Valleylab™ FT10 Energy Platform

SEA3730 RapidVac™ Smoke Evacuator Interlink Cable (cable length = 10 ft (3m))
SE3690 RapidVac™ Smoke Evacuator
Force™ Argon II-20 Argon Gas Delivery Unit II

Warning

Only medical devices compliant with IEC 60601-1 may be connected to the external system receptacles. The use of any external system connected to the Valleylab™ FT10 energy platform should be evaluated by qualified personnel.

System Conventions

Touchscreen

The Valleylab™ FT10 energy platform features a user-friendly touchscreen interface to control system functions. The touchscreen is divided into quadrants; each of the four sections is associated with an adjacent instrument receptacle.

- **Quadrant 1**—Settings entered in the touchscreen control an instrument attached to the Monopolar 1 receptacle.
- **Quadrant 2**—Settings entered in the touchscreen control an instrument attached to the Monopolar 2 receptacle.
- **Quadrant 3**—Settings entered in the touchscreen control an instrument attached to the Bipolar receptacle.
- **Quadrant 4**—The touchscreen displays instrument-specific options and activation of LigaSure™ technology and bipolar resection devices.

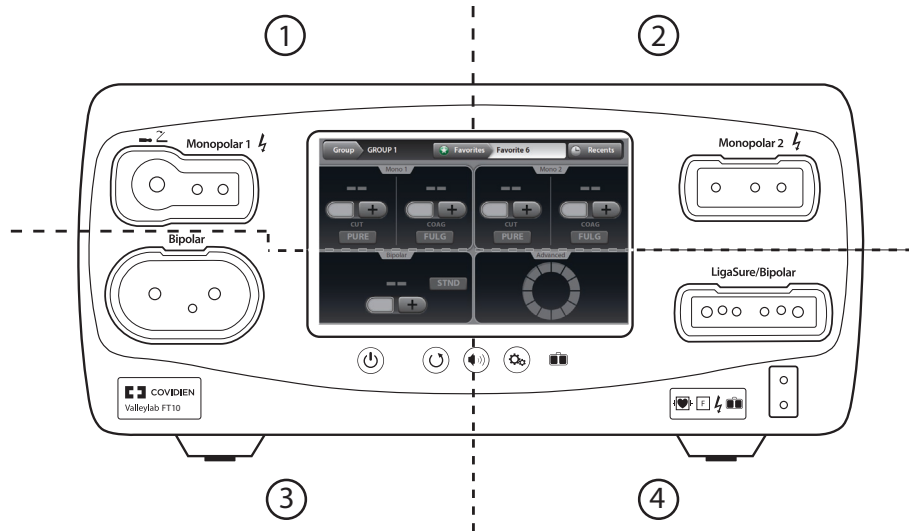

Energy Platform States

The appearance of touchscreen components indicates one of the three states of the system.

Edit

When the system is powered on and no instrument is attached, the instrument controls in the monopolar and bipolar sections can be preset. The following illustration shows monopolar controls edited prior to inserting an instrument.

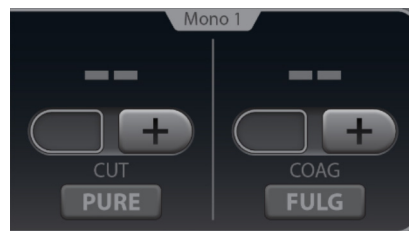

Inserted

The controls change from the edit stage's flat gray to a brightly illuminated color when an instrument is inserted into the associated receptacle. The following illustration shows the monopolar controls when a two-button pencil is inserted.

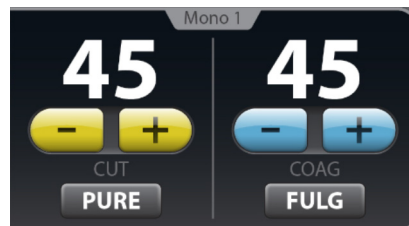

Activation

The black background illuminates brightly when the instrument is activated. The following illustration shows the two-button pencil is currently delivering energy for PURE CUT. The mode controls are locked during activation preventing any change in the mode. Power settings can be changed during activation.

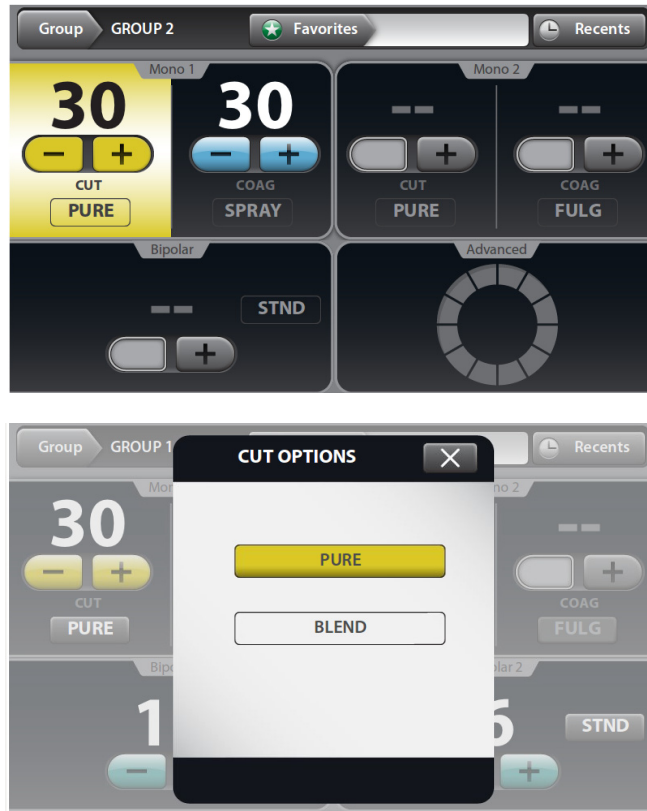

System Buttons

There are four buttons on the energy platform's front panel:



On/Off

Turns system power on and off. To turn power on, hold the button for 0.25 seconds. To turn off, hold the button for 1 second. To reset a non-responsive system, hold for 10 seconds.



Restore Settings

Restores settings from the last time the system was powered down using the On/Off button.





**Audio Volume**

Displays the volume pop-up menu to adjust sound levels.

**Service/Settings**

Displays the service/settings menu.

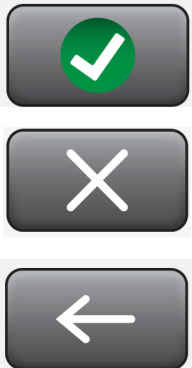
Interface Conventions

Interface Element	Name	Description
	Pop-up window/ menu	Pop-up windows and menus appear on screen when user input is needed or requested. Pop-ups close if the user touches anywhere outside of the pop-up window.
	Plus/minus buttons	Plus and minus buttons indicate additional values or selections are available for the current setting. For numeric values, press the plus or minus button to increase or decrease the displayed value. When the value is at its maximum or minimum available setting, the appropriate button becomes inactive.
	Software buttons	Options and confirmations are represented by virtual buttons on the touchscreen. Touch on-screen buttons to select preference.
	Toggle switches	Touch the virtual toggle switches to turn options or functions ON or OFF.

Chapter 2

Warnings and Precautions for Patient and Operating Room Safety

The safe and effective use of electrosurgery depends to a large degree upon factors solely under the control of the operator. There is no substitute for a properly trained and vigilant surgical team. It is important that the operating instructions supplied with this or any electrosurgical equipment be read, understood, and followed.

Electrosurgery has been used safely in millions of procedures. Before starting any surgical procedure, the surgeon should be trained in the particular technique and surgical procedure to be performed, should be familiar with the medical literature related to the procedure and potential complications, and should be familiar with the risks versus the benefits of utilizing electrosurgery in the procedure.

Conventions Used in this Guide

Warning

Indicates a hazardous situation which, if not avoided, could result in death or serious injury.

Precaution

Indicates a hazardous situation which, if not avoided, may result in minor or moderate injury.

Notice

Indicates a hazard which may result in product damage.

Important

Indicates an operating tip or maintenance suggestion.

General Warnings and Precautions

Fire/Explosion Hazards

Warning

Danger - Explosion Hazard Do not use electrosurgery in the presence of flammable anesthetics or oxidizing gases (such as nitrous oxide (N₂O) and oxygen) or in close proximity to volatile solvents (such as ether or alcohol).

Fire Hazard Do not place active instruments near or in contact with flammable materials (such as gauze or surgical drapes). Electrosurgical instruments that are activated or hot from use can cause a fire. When not in use, place electrosurgical instruments in a safety holster or safely away from patients, the surgical team, and flammable materials.

Sparking and heating associated with electrosurgery can be an ignition source. Keep gauze and sponges wet. Keep electrosurgical electrodes away from flammable materials and oxygen (O₂) enriched environments.

Use of electrosurgery in O₂ rich environments increases the risk of fire. Therefore, take measures to reduce the O₂ concentration at the surgical site.

If possible, stop supplemental oxygen at least one minute before and during use of electrosurgery.

The use of non-flammable agents is recommended for cleaning and disinfecting wherever possible. If flammable agents are used, do not activate the energy platform until flammable vapors from skin-preparation solutions and tinctures have dissipated.

There is a risk of pooling of flammable solutions under the patient or in body depressions, such as the umbilicus, and in body cavities, such as the vagina. Any fluid pooled in these areas should be removed before activating the energy platform.

Avoid the accumulation of naturally occurring flammable gases that may accumulate in body cavities such as the bowel.

Prevent the accumulation of flammable or oxidizing gases or vapors under surgical drapes or near the surgical site.

Tissue buildup (eschar) on the tip of an active electrode may create embers that pose a fire hazard, especially in oxygen-enriched environments. Keep the electrode clean and free of all debris.

Facial and other body hair is flammable. Water soluble surgical lubricating jelly may be used to cover hair close to the surgical site to decrease flammability.

Verify that all anesthesia circuit connections are leak free before and during use of electrosurgery.

Fire Hazard During Oropharyngeal Surgery

Verify endotracheal tubes are leak free and that the cuff seals properly to prevent oxygen leaks.

If an uncuffed tube is in use, pack the throat with wet sponges around the uncuffed tube, and be sure to keep sponges wet throughout the procedure.

Question the need for 100% O₂ during oropharyngeal or head and neck surgery.

If necessary, scavenge excess O₂ with separate suction.

Warning

Do not attempt to recharge the energy platform's lithium battery. This can cause the battery to explode.

System Setup Warnings and Precautions**Warning**

Electric Shock Hazard Connect the system power cord to a properly grounded power receptacle. Do not use power plug adapters.

Electric Shock Hazard When taking measurements or troubleshooting the system, take appropriate precautions, such as using isolated tools and equipment, using the "one hand rule," etc.

Electric Shock Hazard Do not touch any exposed wiring or conductive surfaces while the system is disassembled and energized. Never wear a grounding strap when working on an energized system.

Electric Shock Hazard To allow stored energy to dissipate after power is disconnected, wait at least 5 minutes before replacing parts.

Position the energy platform where it can be easily unplugged in an emergency.

Fire Hazard Do not plug into a power strip or extension cord.

Patient Safety Use the energy platform only if the power-on self-test has been completed as described in this manual, otherwise inaccurate power outputs may result.

Hazardous Electrical Output This equipment is for use only by trained, licensed physicians. Do not use electrosurgical equipment unless properly trained to use it in the specific procedure being undertaken. Use of this equipment without such training can result in serious, unintended patient injury, including bowel perforation and unintended, irreversible tissue necrosis.

Do not touch the patient while touching a connector or fuse contact at the same time. Simultaneous contact can cause electric shock or burns.

Do not wrap the instrument cords or patient-return-electrode cords around metal objects. This may induce currents (capacitive coupling) that could lead to shocks, fires, or injury to the patient or surgical team.

Electric Shock Hazard Do not connect wet instruments to the energy platform. Ensure that all instruments and adapters are correctly connected and that no metal is exposed at any connection points.

Confirm proper power settings before proceeding with surgery. If the proper power settings are not known, set the power to a low setting and cautiously increase the power until the desired effect is achieved. If increased power settings are requested, check the patient return electrode and all instrument connections before major power-setting adjustments.

Contact between the active electrode and any metal will greatly increase current flow and can result in unintended surgical effect.

Warning

While using electrosurgery, the user and patient should not be allowed to come into direct contact with grounded metal objects (e.g., surgical-table frame, instrument table, etc.). If this is not possible during certain procedures (e.g., those in which noninsulated head frames are used), use extreme caution to maximize patient safety:

- Use the lowest power setting that achieves the desired effect.
- Place the patient return electrode as close to the surgical site as possible.
- Place dry gauze between the patient and the grounded object if possible.
- Continually monitor the contact point(s).
- Do not use metal needle monitoring electrodes.

Connect only foot pedals from the compatibility list beginning on page 1-8. Use of other foot pedals may cause unexpected output to occur and may lead to patient injury.

Connect only Covidien-approved devices. Using devices from other manufacturers may cause equipment malfunction or patient injury.

Ensure the UFP connector is fully inserted in the energy platform prior to use. A partially inserted connector may result in injury to the surgical team if the exposed connector is touched during use.

Precaution

Read the instructions, warnings, and precautions provided with this energy platform and associated accessories before using. Specific instructions for electrosurgical instruments are not included in this manual.

Read the instructions, warnings, and precautions provided with electrosurgical instruments before using. Specific instructions for electrosurgical instruments are not included in this manual.

Two generators (and two patient return electrodes) may be used simultaneously on the same patient, provided the generators are the same type (both are isolated). However, the two generators are not synchronized. One return electrode frequently acquires a high positive voltage while the other acquires an opposite negative charge. When this occurs, the potential voltage difference between them may cause the current to flow from one patient return electrode to the other. Place each patient return electrode as close as possible to the site of the surgery to be performed by the generator to which it is connected. Ensure that the two patient return electrodes do not touch.

Certain devices or accessories may present an unacceptable risk at low power settings. For example, with argon beam coagulation, the risk of gas embolism increases if there is insufficient high frequency (HF) power to produce a rapid, impermeable eschar on the target tissue.

For surgical procedures where the current could flow through delicate parts of the body, the use of bipolar techniques may be desirable in order to avoid unwanted coagulation.

Examine all instruments and connections to the system before using. Improper connection may result in arcs, sparks, instrument malfunction, or unintended surgical effects.

Precaution

Do not operate the energy platform for clinical use while cables are connected to the Ethernet or USB receptacles on the back of the energy platform. This may cause a system error that would halt the procedure and require restarting the energy platform.

Do not turn the activation tone down to an inaudible level. The activation tone alerts the surgical team when the energy platform is delivering RF energy.

When using a smoke evacuator in conjunction with the Valleylab™ FT10 energy platform, set the system volume control at a level that ensures the activation tones can be heard.

A non-functioning energy platform may cause an interruption of surgery. A backup system should be available for use.

Inadvertent activation may occur while installing, removing, or bending electrodes. Ensure that the instrument cord is not connected to the Valleylab™ FT10 energy platform or that the system is off.

Leads connected to the patient should be positioned in such a way that contact with the patient or other leads is avoided because the capacitance between the electrode cable and the patient may result in some local high current densities. When not in use, place electrosurgical instruments in a safety holster or safely away from patients, the surgical team, and flammable materials.

Two energy platforms (and two patient return electrodes) may be used simultaneously on the same patient, provided the energy platforms are the same type (both are isolated or both are ground referenced). However, the two energy platforms are not synchronized. One return electrode frequently acquires a high positive voltage while the other acquires an opposite negative charge. When this occurs, the potential voltage difference between them may cause the current to flow from one patient return electrode to the other. The current causes no harm if it produces no sparks or high current densities on the patient. Place each patient return electrode as close as possible to the site of the surgery to be performed by the energy platform to which it is connected. Ensure that the two patient return electrodes do not touch.

Studies have shown that smoke generated during electrosurgical procedures can be potentially harmful to patients and the surgical team. These studies recommend adequately ventilating the smoke by using a surgical-smoke evacuator or other means.¹

1. U.S. Department of Health and Human Services. National Institute for Occupational Safety and Health (NIOSH). Control of Smoke from Laser/Electric Surgical Procedures. HAZARD CONTROLS, Publication No. 96-128, September, 1996

Notice

Connect the power cord to a properly grounded power receptacle having the correct voltage. Otherwise, product damage may result.

The Valleylab™ FT10 energy platform requires special precautions regarding EMC and needs to be installed and put into service according to the EMC information provided in the Valleylab™ FT10 energy platform service manual.

Portable and mobile RF communications equipment can affect the Valleylab™ FT10 energy platform. Refer to the EMC information provided in the Valleylab™ FT10 energy platform service manual.

Notice

The system should not be used adjacent to or stacked with equipment other than specified in the Valleylab™ FT10 energy platform user's guide and the service manual. If adjacent or stacked use is necessary, the system should be observed to verify normal operation in the configuration in which it will be used.

The system intentionally applies RF energy for diagnosis or treatment during activation. Observe other electronic medical equipment in the vicinity during the system activation for any possible adverse electromagnetic effects. Ensure adequate separation of electronic medical equipment based on observed reactions.

The use of accessories, other than specified in the Valleylab™ FT10 energy platform user's guide and the service manual, may result in increased emissions or decreased immunity of the system.

Before plugging the energy platform into a power receptacle, verify that the installed fuses are appropriate for the local input line voltage. See *Input Power* on page 11-3.

Calibration must be performed on a non-conductive surface. Do not use antistatic bench-top mats. When performed on a conductive surface, calibration values may not be accurate.

After completing calibration, the system will reboot to the clinical screen to save the values or abort the calibration.

Important

The Valleylab™ FT10 energy platform is intended for use in a hospital or medical center environment.

If required by local codes, connect the energy platform to the hospital potential equalization system with an equipotential cable.

The operator of the energy platform may be as far away from the energy platform as 2 feet (direct product interaction), 5 feet (inside the sterile field), and 13 feet (across the room working with other equipment).

Log files are maintained when the system is powered down. The time when the system was powered down or experiences a total loss of power is also logged.

When log files reach capacity, the earliest log is deleted to make room for the newest log.

The Valleylab™ FT10 energy platform contains substances of very high concern as defined in Article 57 and Annex XIV of Regulation (EC) No 1907/2006 (Registration, Evaluation, Authorization, and Restriction of Chemicals [REACH]). Specifically, it contains 1,2 dimethoxyethane, ethylene glycol dimethyl ether (EGDME) (CAS number 110-71-4; EC number EN 203-794-9) in concentrations above 0.1% by weight.

Warnings and Precautions for the Energy Platform

Warning

Connect instruments to the proper receptacle. Improper connection may result in inadvertent instrument activation or other potentially hazardous conditions. Follow the instructions provided with electrosurgical instruments for proper connection and use.

Warning

Each instrument receptacle on this energy platform is designed to accept only one instrument at a time. Follow the instructions provided with electrosurgical instruments for proper connection and use.

Failure of the energy platform could result in an unintended increase of output power or activation.

Only medical devices compliant with IEC 60601-1 may be connected to the external system receptacles. The use of any external system connected to the Valleylab™ FT10 energy platform should be evaluated by qualified personnel.

Precaution

Do not stack equipment on top of the energy platform or place the energy platform on top of electrical equipment. This is an unstable configuration and does not allow for adequate cooling.

Provide at least 4" to 6" (10 to 15 cm) of unobstructed space round the top and sides of the energy platform to ensure proper cooling.

Provide as much distance as possible between the energy platform and other electronic equipment (such as monitors). Do not cross or bundle cords from electronic devices. This energy platform may cause interference with other electronic equipment.

The use of monitoring systems that incorporate high-frequency current-limiting devices is recommended to reduce interference with the monitoring device.

The system contains electrostatic-sensitive components. When repairing the system, work at a static-control workstation. Wear a grounding strap when handling electrostatic-sensitive components, except when working on an energized system. Handle Printed Circuit Board Assemblies (PCBA) by their non-conductive edges. Use an antistatic container for transport of electrostatic-sensitive components and PCBAs.

Notice

Make no modifications to the electrosurgical energy platform. Any modifications to the system will void the warranty.

When testing RF equipment, follow these test procedures. Keep test leads to the minimum length usable; lead inductance and stray capacitance can adversely affect readings. Carefully select suitable ground points to avoid ground loop error in measurements.

The accuracy of most RF measuring equipment is approximately 1%–5% of full scale. Using uncompensated scope probes causes large errors when measuring high-voltage RF waveforms.

Warnings and Precautions for Active Instruments**Warning**

Energy applied to an electrosurgical instrument can convert liquids to steam. The thermal energy of steam may cause unintended injury in close proximity to the tip of the instrument. Care should be taken in surgical procedures occurring in confined spaces in anticipation of this possibility.

Warning

Do not activate the energy platform in an open-circuit condition. To reduce the chances of unintended burns, activate the energy platform only when the active electrode is near or touching the target tissue.

Use the lowest power setting that achieves the desired surgical effect and use a low-voltage waveform (PURE CUT, BLEND, or VALLEYLAB™ mode) to lessen the potential for the creation of capacitive currents.

If energy delivery from the energy platform cannot be stopped, remove the handpiece from the patient and disconnect the handpiece or power cord.

Do not activate the instrument when not in contact with target tissue as this may cause injuries due to capacitive coupling.

The surface of the active electrode may remain hot enough to cause burns after the RF current is deactivated.

Keep the active electrodes clear. Build-up of eschar may reduce the instrument's effectiveness. Do not activate the instrument while cleaning. Injury to operating room personnel may result.

Precaution

Read the instructions, warnings, and precautions provided with electro-surgical instruments before using. Specific instructions for electro-surgical instruments are not included in this manual.

Inspect instruments and cords—especially for laparoscopic/endoscopic instruments—for breaks, cracks, nicks, and other damage before every use. If damaged, do not use. Damaged instruments or cords may result in injury or electrical shock to the patient or surgical team.

Use only instruments that can withstand the maximum output (peak) voltage for each output mode as listed in Chapter 11, *Technical Specifications*. Using an instrument with a voltage rating that is lower than the maximum output voltage may result in injury to the patient or the operator, or damage to the instrument.

Information on voltage ratings for non-Covidien instruments should be obtained from the instrument's manufacturer.

Notice

All Covidien instruments have voltage ratings that are greater than the energy platform's maximum output voltages at the instrument's maximum recommended settings.

Inspect instrument plugs for wear before every use. Worn plugs may result in a loose or stuck connection to the energy platform.

Warnings for Implanted Electronic Devices (IEDs)

IEDs include, but are not limited to, pacemakers, neurostimulators, implantable cardioverter defibrillators (ICDs), ventricular assist devices (VAD), spinal cord stimulators, cochlear implants, infusion pumps, and bone growth stimulators.

Warning

Use the system with caution in the presence of internal or external pacemakers or other implanted devices. Interference produced by electrosurgical equipment can cause a pacemaker or other device to enter an unsafe mode or permanently damage the device. Consult the device manufacturer or responsible hospital department for further information when use is planned in patients with implanted medical devices.

Post Surgery Safety Issues

Warning

Shock Hazard Before cleaning or servicing the unit, disconnect the power plug from the power outlet in order to completely isolate the energy platform from mains power.

Notice

Do not clean the energy platform with abrasive cleaning or disinfectant compounds, solvents, or other materials that could scratch the panels or damage the energy platform.

Warnings and Precautions for Monopolar Procedures

Warning

Simultaneously activating suction/irrigation and electrosurgical current may result in increased arcing at the electrode tip, burns to unintended tissues, or shocks and burns to the surgical team.

Power output of a two- or three-button pencil (COAG selection) can change during use when another monopolar instrument is activated.

Warning

Some surgeons may elect to “buzz the hemostat” during surgical procedures. It is not recommended, and the hazards of such a practice probably cannot be eliminated. Burns to the surgeon’s hands are possible. To minimize the risk take these precautions:

- Do not buzz the hemostat with a needle electrode.
- Do not lean on the patient, the table, or the retractors while buzzing the hemostat.
- Activate CUT rather than COAG. CUT has a lower voltage than COAG.
- Firmly grasp as much of the hemostat as possible before activating the energy platform. This disperses the current over a larger area and minimizes the current concentration at the finger tips.
- Buzz the hemostat below hand level (as close as possible to the patient) to reduce the opportunity for current to follow alternate paths through the surgeon’s hands.
- Use the lowest power setting possible for the minimum time necessary to achieve hemostasis.
- Activate the energy platform after the instrument makes contact with the hemostat. Do not arc to the hemostat.
- When using a coated- or nonstick-blade electrode, place the edge of the electrode against the hemostat or other metal instrument.

DEMO mode delivers monopolar energy without the use of a patient return electrode, and is intended for demonstration purposes only. Chance of burns to the patient significantly increase when DEMO mode is used for clinical procedures.

Precaution

To provide expected functionality from a hand piece, proper insertion is required. Refer to the alignment dots below the receptacles for proper insertion orientation.

The use of modes that produce electrical arcs between the active electrode and tissue may result in neuromuscular stimulation.

Warnings and Precautions for Patient Return Electrodes

Warning

It is not possible to foresee what combination of current and duty cycle may be safely used in every situation—for example, when higher currents and/or longer duty cycles are used on procedures such as tissue lesioning, tissue ablation, tissue vaporization; and procedures where conductive fluid is introduced into the surgical site. Under these conditions a greater risk may exist that the heating under a fully applied return electrode may be high enough to injure the patient.

When using a Covidien energy platform or a patient return electrode during these types of surgical procedures, the user should seek written guidance in the form of detailed user instructions from the manufacturer of the active accessory regarding the currents and duty cycles that can be expected. In some instances, the application of additional patient return electrodes may help mitigate the increased risk.

Warning

Do not attempt to use patient return electrodes that disable the Return Electrode Monitoring (REM) system. The Valleylab™ FT10 energy platform REM™ system will function correctly only with contact quality monitoring (CQM) split-style patient return electrodes. Other patient-return-electrode products may not identify loss of safe contact between the return electrode and the patient, thereby failing to provide an auditory alarm and causing patient injury or product damage.

The safe use of monopolar electrosurgery requires proper placement of the patient return electrode. To avoid electrosurgical burns beneath the patient return electrode, follow all directions provided with the product.

Do not cut a patient return electrode to reduce its size. Patient burns due to high current density may result.

To avoid patient burns, ensure that the patient return electrode makes firm and complete contact with the skin. Always check the patient return electrode periodically, after the patient is repositioned, and during procedures involving long periods of activation.

Use of duty cycles greater than 25% (10 seconds active followed by 30 seconds inactive) will increase the risk that heat build-up under a return electrode may be high enough to injure the patient. Do not continuously activate for longer than one minute.

Apparent low-power output at the normal operating settings may indicate faulty application of the return electrode. Verify the return electrode is correctly placed and attached to the patient as described in the electrode's instructions for use. Verify the connection between the electrode and the energy platform before selecting a higher output power.

DEMO mode does not monitor the quality of pad contact with the patient. Therefore, no warning will be issued from the energy platform when pad-to-patient contact degrades.

Precaution

Covidien REM Polyhesive™ patient return electrodes are recommended for use with the FT10. Return electrodes from other manufacturers may not provide proper impedance to work correctly with the energy platform.

Important

A statement of compatibility from the CQM patient return electrode manufacturer should be obtained prior to the use of a non-Covidien CQM patient return electrode.

A patient return electrode is not necessary in bipolar or LigaSure™ technology procedures.

Inadvertent Radio Frequency (RF) Burns**Warning**

Electrodes and probes used with monitoring, stimulation, and imaging devices (or similar equipment) can provide a path for high frequency current even if the electrodes or probes are isolated at 50 –60 Hz, insulated, and/or battery operated.

Warning

Do not use needles as monitoring electrodes during electrosurgical procedures. Inadvertent electrosurgical burns may result.

To reduce the risk of an inadvertent electrosurgical burn at the monitoring electrode or probe site, place the electrode and/or probe as far away as possible from the electrosurgical site and/or patient return electrode. Protective impedances (resistors or RF inductors) installed in the monitoring leads may reduce the risk of such burns. Consult the hospital biomedical engineer for further information.

In some circumstances, the potential exists for alternate site burns at points of skin contact (e.g., between the arm and the side of the body). This occurs when electrosurgical current seeks a path to the patient return electrode that includes the skin-to-skin contact point. Current passing through small skin-to-skin contact points is concentrated and may cause a burn. This is true for ground referenced and isolated output electrosurgical energy systems.

To reduce the potential for alternate site burns, do one or more of the following:

- Avoid skin-to-skin contact points, such as fingers touching leg or knee touching knee when positioning the patient.
- Place insulation, such as dry gauze or towel, between contact points to ensure that contact does not occur.
- Position the patient return electrode to provide a direct current route between the surgical site and the return electrode which avoids skin-to-skin contact areas.
- In addition, place patient return electrodes according to the manufacturer's instructions.

Warnings and Precautions for Laparoscopic Procedures

Warning

For laparoscopic procedures, be alert to these potential hazards:

- Laparoscopic surgery may result in gas embolism due to insufflation of gas in the abdomen.
- The electrode tip or LigaSure™ technology instrument jaws may remain hot enough to cause burns after the electrosurgical current is deactivated.
- Inadvertent activation or movement of the activated instrument electrode or jaws outside of the field of vision may result in injury to the patient.
- Localized burns to the patient or physician may result from electrical currents carried through conductive objects (such as other instruments, cannulas, or scopes). Electrical current may be generated in conductive objects through direct contact with the active electrode or jaws, capacitive coupling, or by the active instrument (electrode or cable) being in close proximity to the conductive object.
- Do not use hybrid trocars that have a non-conductive locking anchor placed over a conductive sleeve. For the operative channel, use all-metal or all-plastic systems. At no time should electrical energy pass through hybrid systems. Capacitive coupling of RF current may cause unintended burns.
- When using laparoscopic instrumentation with metal cannulas, the potential exists for burns to the abdominal wall due to direct electrode contact or capacitive coupling of RF current. This is most likely to occur in instances where the energy platform is activated for extended periods at high power levels inducing high current levels in the cannula.
- Carefully insert and withdraw LigaSure™ technology instruments from cannulas to avoid possible damage to the devices and/or injury to the patient.
- Ensure that the insulation of single-use and reusable laparoscopic instrumentation is intact and uncompromised. Compromised insulation may lead to inadvertent metal-to-metal sparking and neuromuscular stimulation and/or inadvertent sparking to adjacent tissue.
- Do not activate the LigaSure™ technology function in an open-circuit condition. Activate the energy platform only when the instrument is near or in direct contact with the target tissue to reduce the possibility of unintended burns.

Covidien recommends against the use of laparoscopic surgery on pregnant patients.

Warnings and Precautions for Bipolar Procedures

Warning

Use of different Covidien cord models or cords from other manufacturers may not achieve proper electrical output for this device, thereby failing to produce the desired clinical effect. For example, Auto Bipolar activation/deactivation settings may not work properly using cords other than those specified by Covidien.

In the Auto Bipolar setting, activation may occur with contact of any material. When not in use, place electrosurgical instruments in a safety holster or safely away from patients, the surgical team, and flammable materials

Precaution

Bipolar instruments must be connected to the bipolar instrument receptacle only. Improper connection may result in inadvertent system activation.

Do not use instruments with flying leads with the Valleylab™ FT10 energy platform.

Do not use the FT0501 ForceTriad™ bipolar adapter on the Valleylab™ FT10 energy platform.

Bipolar forceps should not be set down while Auto Bipolar is active. Contact with any material may cause activation. Turn off Auto Bipolar before setting down an instrument.

Warnings and Precautions for LigaSure™ Technology Procedures

Warning

LigaSure™ technology instruments are intended for use only with compatible Covidien energy platforms. See the front cover of the instrument's instructions for a list of compatible energy platforms. Use of these instruments with other energy platforms may not result in electrical output that they were designed for, and may not result in the desired clinical effect.

The tissue fusion function has not been shown to be effective for tubal sterilization or tubal coagulation for sterilization procedures. Do not use this function for these procedures.

Tissue fusion requires the application of RF energy and pressure from the instrument. Ensure grasping pressure is maintained until the seal cycle is complete. Tissue to be sealed must be firmly grasped between the instrument jaw electrodes. Tissue in the jaw hinge or outside the instrument jaw may not be sealed even if thermal blanching occurs.

If the seal-cycle-complete tone has not sounded, an optimal seal may not have been achieved. Reactivate the RF energy until a seal-cycle-complete tone is heard.

Do not activate the energy platform until the tissue-fusion or LigaSure™ technology instrument has been applied with the proper pressure. Do not release the pressure on the tissue until the end tone has sounded. Activating the energy platform with improper grasping pressure applied may result in an improper seal and may increase thermal spread to tissue outside the surgical site.

Warning

Fluid in the body cavity should be kept to a minimum during treatment. Conductive fluids (e.g., blood or saline) in direct contact with, or in close proximity to, the instrument may carry electrical current or heat, which may cause unintended burns to the patient. Aspirate fluid from around the instrument jaws before activating the instrument.

Do not attempt to seal or cut over clips or staples as incomplete seals may be formed.

Precaution

Energy-based devices, such as electro-surgical pencils or ultrasonic scalpels, that are associated with thermal spread should not be used to transect seals.

Warnings and Precautions for Bipolar Resection

Warning

Bipolar resection mode is intended to be used only with compatible resectoscopes for endoscopically controlled removal (resection) or coagulation of tissue using 0.9% NaCl solution (saline) as the irrigation medium.

Precaution

Bipolar resection mode is supported only if a Covidien-specified bipolar resection instrument is connected to the LigaSure™ technology/Bipolar receptacle with a Covidien bipolar resection cord. In addition, Bipolar resection mode can be activated only with the Covidien bipolar resection foot-pedal connected to the LigaSure™ technology/Bipolar foot-pedal receptacle. See the cords IFU listed in *Accessories* on page 1-13 for the list of supported bipolar resection instruments and cords.

Warnings and Precautions for Cardioblate™ Ablation Procedures

Contraindications for the Cardioblate™ Ablation System

The cardiac tissue ablation feature is contraindicated for patients with active endocarditis at the time of surgery.

Ablation in a pool of blood is contraindicated (for example, through a purse string suture).

Warning

Do not attempt to operate the Valleylab™ FT10 energy platform or connect the Cardioblate™ ablation devices to the energy platform prior to completely reading and understanding the product literature for the Valleylab™ FT10 energy platform and the Cardioblate™ ablation device.

Warning

Only use Medtronic Cardioblate™ ablation devices and Medtronic-recommended accessories for Cardioblate™ ablation system procedures. The safety of use with other surgical ablation devices, catheters, or accessories has not been assessed.

Medtronic ablation devices designed for use with the Valleylab™ FT10 energy platform are intended for one-time use. The Valleylab™ FT10 energy platform has functionality to prevent the reuse of the surgical ablation devices.

Ablation Therapy Hazards Lesions – The long-term effect of lesions created by RF ablation have not been established; note the following information:

- Any long-term effects of lesions in proximity to the conduction system or coronary vasculature are unknown.
- The risks/benefits in asymptomatic patients have not been studied.

Atrioventricular (AV) node modification or septal accessory pathway ablation – Patients undergoing AV node modification or septal accessory pathway ablation are at risk for complete AV blockage:

- Closely monitor AV conduction after RF energy delivery.

Using RF energy near implanted devices – RF energy may adversely affect implanted devices, such as pacemakers and implantable cardioverter-defibrillators (ICDs). To avoid this do the following:

- Keep external sources of pacing and defibrillation available during ablation.
- Deactivate ICD detection during RF energy delivery.
- Exercise extreme caution when delivering ablation energy in close proximity to implanted leads.
- Perform complete implantable device testing before and after ablation.

Unintentional patient burns – To avoid unintentional burns to the patient during RF energy delivery, do the following:

- Minimize the distance between the dispersive electrode and the operating field.
- Minimize skin-to-skin contact between parts of the patient's body by covering these areas with dry gauze.
- Place monitoring electrodes and tissue manipulation devices as far as possible from surgical electrodes to minimize burns at the site of the monitoring electrodes or tissue manipulation devices.
- When using multiple ablation devices, remove those devices not actively in use from patient contact. In all cases, monitoring systems incorporating high frequency current-limiting devices are recommended.

Handling RF devices during therapy – The energy platform is capable of delivering significant RF energy. Do not touch the ablation electrode of the ablation device or the dispersive return electrode or both electrodes on a bipolar device while operating the energy platform.

Equipment failure – The failure of the energy platform or hand piece could result in an unintended increase of output power. See Chapter 9, *Troubleshooting* for detailed information.

Precaution

Regularly inspect and test cables and accessories. Do not use any cable or accessory that appears to be damaged. Take the following precautions:

- Inspect for insulation damage, such as brittleness, cracking, thinning, or bare spots.
- Replace damaged accessories.

To avoid the risk of electrical shock and/or burns to the patient, do not touch the patient while touching the outer housing or connections on the Valleylab™ FT10 energy platform. Do not allow the patient to come into contact with grounded metal surfaces during RF energy ablation.

Electrosurgery near flammable materials – The risk of igniting flammable gases or other materials is inherent in electrosurgery and cannot be eliminated by device design. Flammable agents used for cleaning or disinfecting, or as solvents of adhesives, should be allowed to evaporate before the application of high frequency surgery. There is a risk of pooling of flammable solutions under the patient or in the body depressions such as the umbilicus. Any fluid pooled in these areas should be mopped up before RF surgical equipment should be used. Attention should be called to the danger of ignition of endogenous gases. Take precautions to restrict flammable materials and substances from the electrosurgical site. Flammable materials may come in the following forms:

- Anesthetics or skin preparation agents
- Natural chemicals produced within body cavities
- Chemicals originating in surgical drapes or other materials

Electrostatic Discharge (ESD) is the sudden transfer or discharge of static electricity from one object to another. Human bodies can create ESD charges of up to 25,000 volts.

Connector pins identified with the ESD warning symbol should not be touched. ESD applied to one of these connectors may cause the energy platform to display an error message and interrupt RF energy delivery until the message is acknowledged and/or removed.

Precautionary procedures include the following:

- Prevent electrostatic charge build-up (e.g., air conditioning, humidification, conductive floor coverings, and non-synthetic clothing).
- Discharge one's body to the frame of the equipment or system, to earth ground, or a large metal object prior to making contact.
- Bond oneself by means of a wrist strap to the equipment or system, or to earth ground prior to making contact. Do not utilize this bonding or wrist strap protection when activating RF.

Cardioblade™ Ablation System Operation

Warning

High impedance– Monitor the device impedance measurement display during RF energy delivery. If abnormally high impedance is observed, examine the ablation electrode for coagulum. If coagulum is present or any irrigation opening is found to be blocked, remove coagulum or replace the ablation device prior to continuing the procedure.

If high impedance is preventing ablation from occurring, perform the following steps.

- 1) Check all connections.
- 2) Check the saline flow.
- 3) Check for obvious defects or misapplication of the dispersive (return) electrode (if the monopolar device is in use).

Low impedance – If low impedance is preventing ablation from occurring, perform the following steps.

- 1) Check connections for a short circuit.
- 2) Check the saline flow.
- 3) Inspect the lesion.
- 4) Reactivate the ablation device, if desired.

Necessary environment – Cardiac ablation procedures should be performed only by trained personnel in a fully equipped operating room with the following essentials:

- An emergency cardiovascular team should be available during the ablation procedure in case of a cardiovascular emergency.
- The ablation device should be used only by or under the supervision of physicians trained in cardiac surgery and experienced in surgical ablation procedures.

Fluid ingress – The energy platform may not function correctly if the electronic circuitry or the connectors are wet. Observe the following items before operating the energy platform.

- Do not allow any fluid or moisture into the energy platform or any connector or cables.
- Do not hang fluids above the energy platform.
- Do not immerse the cables into fluids.

Electromagnetic interference (EMI) – EMI produced by the energy platform during normal operation may adversely affect the performance of other equipment.

Please refer to applicable standards for additional information.

Cardioblade™ Ablation System Adverse Events

Warning

The potential adverse events related to the use of ablation systems include, but are not limited to, the following risks:

- Abrasion
- Arrhythmia
- Burn
- EKG/ECG changes
- Electrical shock
- Hemolytic anemia
- Hypotension
- Infection
- Ischemia
- Organ dysfunction
- Perforation
- Tingling
- Tissue damage

Shunt Cords

Warning

Some surgical instruments (e.g., colonoscopes) may allow substantial leakage current that could burn the surgeon. If the instrument manufacturer recommends the use of a shunt cord (s-cord) to direct the current back to the energy platform, an E0507-B adaptor must also be used. To avoid a REM alarm, a REM Polyhesive™ patient return electrode with the E0507-B adaptor must be used.

Conductive Fluid In the Surgical Site

Warning

When this energy platform is used in monopolar procedures where conductive fluid (including, but not limited to saline or lactated Ringer's) is introduced into the surgical site for distention or to conduct RF current, higher than normal currents (greater than one amp) may be produced. In this situation, use one or more adult-size return electrodes. Do not use return electrodes labeled for children, infants, babies, neonatal use, or pediatric use.

Warning

Use of duty cycles greater than 25% (10 seconds active followed by 30 seconds inactive) will increase the risk that heat build-up under a return electrode may be high enough to injure the patient. Do not continuously activate for longer than one minute.

Servicing

Warning

Electric Shock Hazard Do not remove the energy platform cover. Contact qualified personnel for service.



Do not dispose of electrical appliances as unsorted municipal waste. Use separate collection facilities.

Electrical appliances that are incorrectly disposed in dumps or landfills can leach dangerous substances causing contamination of soil and groundwater, and damaging the environment.

Contact your local government, or point of sale for information regarding the collection of waste electrical appliances

Notice

Refer to this system's service manual for maintenance recommendations, and function and output-power verification procedures.

Do not spray cleaning fluids directly on the energy platform as damage to the energy platform may occur.

The latest version of the Valleylab™ FT10 energy platform service manual is available at <https://quickassist.medtronic.com>.

Call these numbers to request a hardcopy of the service manual

- USA and Canada: 1 800 255 8522 Option 2
- International: 1 303 476 7996

Chapter 3

System Setup

This chapter describes how to set up the energy platform, turn it on, and configure system settings.

Precaution

Read the instructions, warnings, and precautions provided with this energy platform and associated accessories before using. Specific instructions for electro-surgical instruments are not included in this manual.

Setup

Unpacking the System

Carefully unpack the contents of the shipping container. The container contains the following items:

- Valleylab™ FT10 FT Series energy platform
- Power cord
- First-time setup guide
- Quick reference card
- User's guide
- DVD with user's guide translations and service manual
- Ethernet cable
- Monopolar foot-pedal adapter
- Bipolar Resection foot-pedal adapter
- Fuses for 220-240 VAC

Before Starting the System

Important

The Valleylab™ FT10 energy platform is intended for use in a hospital environment.

The operator of the energy platform may be as far away from the energy platform as 2 ft. (60 cm) [direct product interaction], 5 ft. (1.5 m) [inside the sterile field], and 13 ft. (4 m) [across the room working with other equipment].

Notice

Before plugging the energy platform into a power receptacle, verify that the installed fuses are appropriate for the local input line voltage. See *Input Power* on page 11-3.

1. Verify the system is off and the power cord is unplugged.
2. Place the energy platform outside the sterile field on a flat, stable surface such as a table, platform, boom system, or Valleylab™ universal generator cart (VLFTCRT). Refer to local codes or the procedures for the local institution.
3. If necessary, connect the equipotential ground connection to a ground source.
4. Plug the system power cord into the rear panel receptacle.
5. Plug the system power cord into a grounded power receptacle. The **On/Off** button illuminates yellow.

Precaution

Do not plug the system power cord into a power strip or extension cord.

Turning On the Valleylab™ FT10 Energy Platform

1. Turn on the system by depressing the **On/Off** button on the front panel. Observe the following during the power-on self-test (POST):
 - The Covidien logo appears on screen.
 - A status bar indicates authentication activity.
 - The system revision code appears.
 - A tone sounds upon completion of the power-on self-test (POST).
 - The REM (Return Electrode Monitoring) indicator appears below the touchscreen: red if an REM-alarm condition exists; green if no REM-alarm condition exists.
 - If an REM alarm condition exists, refer to *Correcting a REM-Alarm Condition* on page 9-2.
2. If the self-test is not successful, an alarm tone sounds. An error screen appears on the touchscreen. Note the information on the display and refer to Chapter 9, *Troubleshooting*.

Warning

Patient Safety Use the energy platform only if the power-on self-test has been completed as described in this manual, otherwise inaccurate power outputs may result.

3. **Required for initial start up**—The energy platform must be set up using the Valleylab™ Exchange Remote Software System. For instructions, refer to the *First-Time Setup Guide*.

This document is available online at
<http://www.medtronic.com/covidien/support/valleylab-exchange>.

Turning Off the Valleylab™ FT10 Energy Platform

1. Normal Power-off: Turn off the system by depressing the **On/Off** button (illuminated green) on the front panel for at least 1 second. Observe the following during the power-off:
 - The system exits the screen.
 - The screen displays the power-down sequence.
 - Once the power-down sequence is complete, the screen turns off and the **On/Off** button illuminates yellow.
 - Power-down is complete.
2. Force Quit option: If the system was powered up but non-responsive, press and hold the **On/Off** button for at least 10 seconds and observe the following:

- The screen turns off and the **On/Off** button illuminates yellow.
- Power-down is complete.

Saved Settings

Important

Group and Favorite names may be chosen and entered by the user. Do not enter patient names, individual identifiers, or sensitive information as Group or Favorite names. All information entered in the Group and Favorite Names and Settings, i.e. facility name or location, is saved to the generator and become part of the machine data that is retained and transferred to Medtronic when connecting to VLEX software.

Medtronic uses machine data including saved settings in aggregate for the purpose of research, development, and troubleshooting.

Important

Favorite settings and feature settings cannot be backed up or transferred to and restored from another energy platform. A good practice is to keep a record of these settings in case settings need to be transferred or restored.

The Valleylab™ FT10 energy platform system can save user-configurable favorite preferences (**Favorites**) and recently used preferences (**Recents**).

Favorites and Recents are saved according to a **Group** name, with the option of up to 10 different groups. Each group can store up to 6 different Favorites preferences and 6 different Recents preferences.

At the top of the clinical screen, the saved settings navigation bar consists of the following buttons:

Clinical Screen



- ① Group selection button
- ② Selected group name
- ③ Favorites selection button
- ④ Selected favorite name (only displayed when clinical settings match the selected favorite)
- ⑤ Recents selection button

Important

RF energy cannot be activated while navigating through the Saved Settings screens. Touch the Cancel button in the top right corner on any of the saved settings screens to return to the Clinical screen.

Selecting and Editing a Group

1. To select and/or edit a Group, touch the **Group** button on the clinical screen. The **Group Selection Screen** shows the names of 10 selectable groups.

Touch the **Cancel** button on the **Group Selection** screen to return to the Clinical Screen without selecting a group.

Group Selection Screen

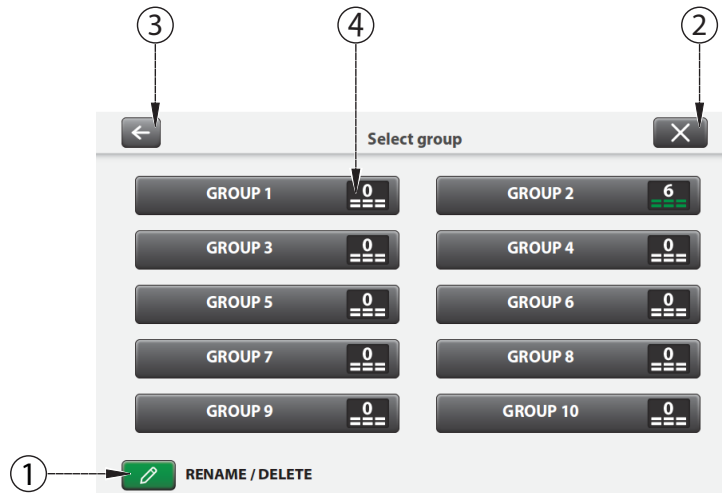

- ① Options button
 - ② Cancel button
 - ③ Back Button
 - ④ Number of Favorite preferences that have been saved within the group
2. Touch the group name to select the desired group. Upon touching the displayed group name the system returns to the Clinical Screen with the selected group displayed. Changing the group will clear the clinical settings . Favorite preferences or Recent preferences can now be loaded from the selected group as described in the following sections.

3. Touch the **Options** button to make edits to a group name or delete Favorite preferences and Recent preferences within a group. The **Group Options Pop-up screen** displays and shows two buttons: Rename Group and Delete Groups.

Group Options Pop-up Screen

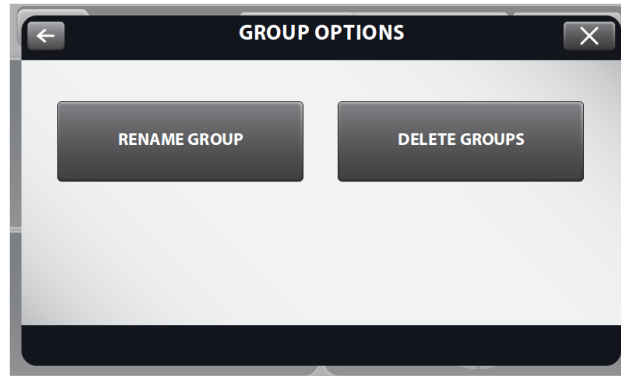

Touch the **Back** button in the Group Options Pop-up screen to return to the Group Selection Screen. Touch the **Cancel** button in the Group Options Pop-up screen to return to the Clinical Screen.

Renaming a Group

1. To rename a Group, touch the **Rename Group** button on the Group Options Pop-up screen. The Group Selection Screen is displayed.
2. Touch the **Group** to be renamed and an on-screen keyboard is displayed. Use the keyboard to type in a unique name for the group.
3. Touch the **Confirm** button to the right of the name input box to confirm the name and return to the Group Options Pop-up screen.

To return to the Group Options Pop-up screen without renaming the group, touch the **Back** button in the top left corner of the keyboard.

To return to the Clinical Screen without renaming the group, touch the **Cancel** button in the top right corner of the keyboard.

Important

Touch the keyboard language selection button in the lower left corner of the keyboard screen to switch the keyboard input language.

Deleting Groups

1. Touch the **Delete Groups** button on the Group Options Pop-up screen to delete one or more Groups.

Touch the **Cancel** button on the **Group Selection** screen to return to the Clinical Screen without selecting a group.

2. The **Delete Groups** Screen is displayed. Touch the **Groups** to be deleted. The groups will be highlighted, and a trash can will appear overlaid on the groups selected for deletion

Delete Groups Screen

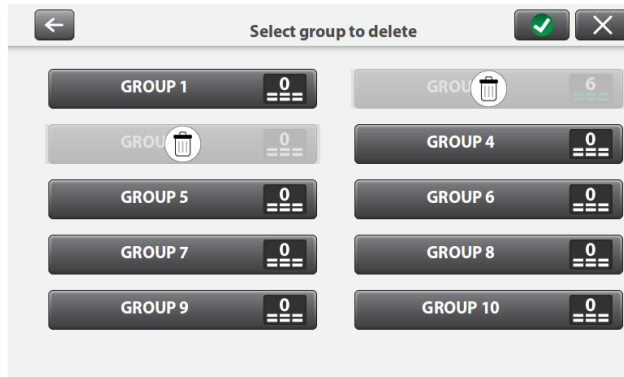

3. Touch the **Confirm** button in the top right corner of the screen to confirm the deletion and return to the Group Selection Screen.

Touch the **Back** button in the top left corner of the **Delete Groups** screen to return to the Group Options Pop-up screen without deleting any groups.

Touch the **Cancel** button in the top right corner of the **Delete Groups** screen to return to the Clinical Screen without deleting a group.

Favorite Settings

1. Touch the **Favorites** button on the clinical screen to select, add, edit, or rename Favorite preferences. The **Favorites Selection Screen** shows up to 6 selectable Favorite preferences that can be named by the user within the current group. Each Favorite preference displays the saved settings for the different energy channels.

Favorites Selection Screen

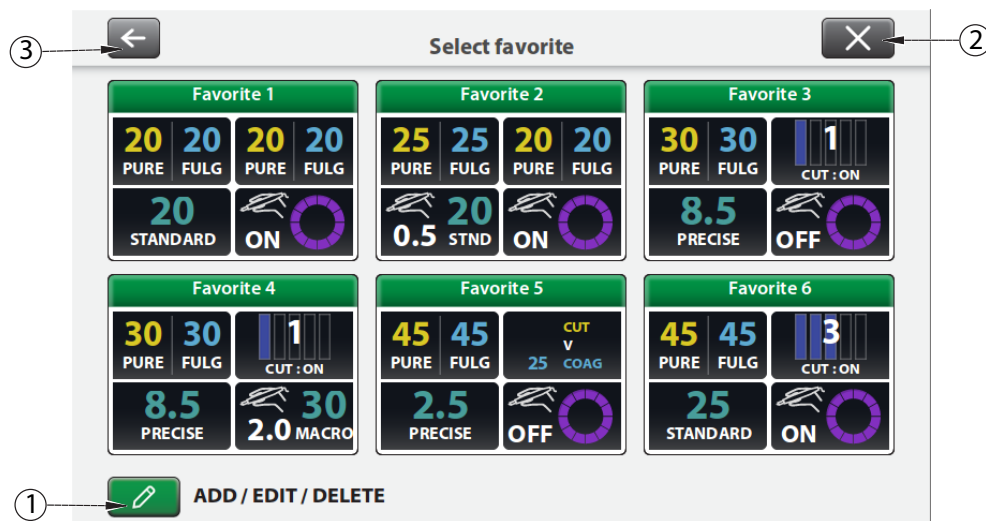

- ① Options button
 - ② Cancel button
 - ③ Back button
2. Touch the desired **Favorite** preference for clinical use. The Clinical screen will display with the Favorite preference ready for clinical use. If the Favorite preference includes enabled Auto-Bipolar, a pop-up screen displays in the Bipolar quadrant for the user to acknowledge if or when a bipolar instrument is connected.
 3. Touch the **Back** or **Cancel** button on the Favorites Selection Screen to return to the Clinical Screen without selecting a favorite.

Favorite Options

1. Touch the **Options** button on the **Favorites Selection screen** to add a new Favorite preference, to make edits to an existing Favorite preference, or to delete a Favorite preference.
2. The **Favorites Options Pop-up** screen shows four buttons: Add Favorite, Edit Favorite, Rename Favorite, and Delete Favorites.

Favorites Options Pop-up screen

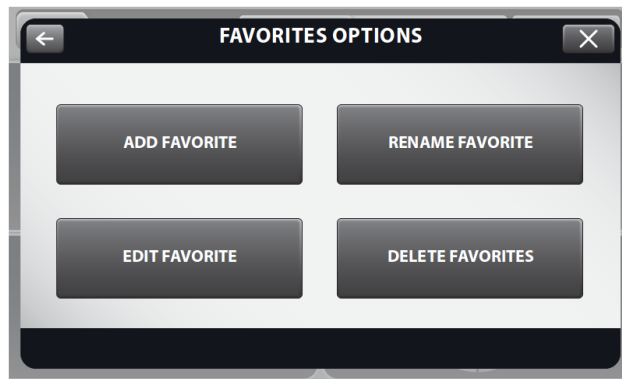

To return to the Favorites Selection Screen, touch the **Back** button in the top left corner of the Favorites Options Pop-up screen.

To return to the Clinical Screen, touch the **Cancel** button in the top right corner of the Favorites Options Pop-up screen.

Adding a Favorite

Touch the **Favorites** button on the clinical screen to select, add, edit, or rename Favorite preferences. Touch the **Options** button on the Favorites Selection screen.

1. Touch **Add Favorite** on the **Favorites Options Pop-up** screen to create a new Favorite. The Favorites Configuration Screen is displayed. The background color is different to indicate that this is not the clinical screen.

Note: There must be an empty slot available to create a new Favorite preference. If there are no available slots, one of the Favorite preferences must be deleted before adding a new Favorite preference. See *Deleting a Favorite* on page 3-13. Alternatively, a different group with an available slot may be selected, but selecting a different group will clear the clinical settings.

Favorites Configuration Screen

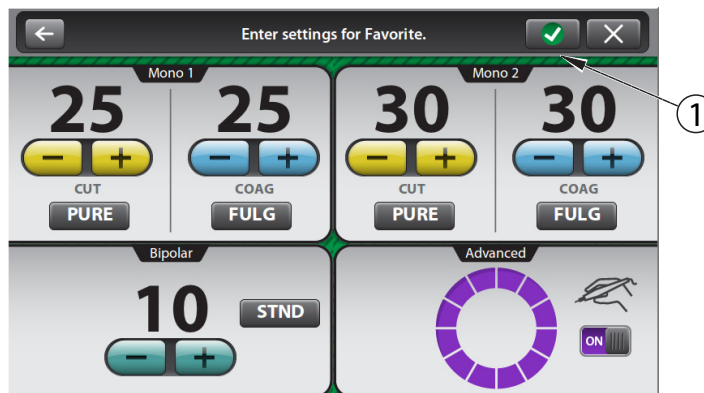

① Confirm Button

2. The existing settings from the Clinical Screen are displayed as a default. These settings can be modified as described in Chapters 4 – 7 of this Users Guide.

Important

Certain instruments that require specialized settings will need to be inserted to adjust and save settings.

3. Touch the **Confirm** button in the top right corner of the screen to confirm the settings.
4. After confirming the settings, the on-screen keyboard is displayed. If a name is desired, use the keyboard to type in a unique name for the Favorite preference, then touch the **Confirm** button next to the name input box to save the Favorite preference.
5. If no name is desired, simply touch the **Confirm** button to continue.
6. The new Favorite preference is displayed and highlighted in the Favorites Selection Screen. After a brief delay, the Clinical screen is displayed with the Favorite preference selected and ready for clinical use.

To return to the Favorites Configuration Screen without saving the name, touch the **Back** button in the top left corner of the keyboard.

To exit and return to the Clinical Screen without saving the Favorite, touch the **Cancel** button in the top right corner of the keyboard.

Important

Touch the keyboard language selection button in the lower left corner of the keyboard screen to switch the keyboard input language.

To return to the Favorites Options Pop-up screen without saving the Favorite, touch the **Back** button in the top left corner of the Favorites Configuration Screen.

To return to the Clinical Screen without saving the Favorite, touch the **Cancel** button in the top right corner of the Favorites Configuration Screen.

Editing a Favorite

Touch the **Favorites** button on the clinical screen to select, add, edit, or rename Favorite preferences. Touch the **Options** button on the Favorites Selection screen.

1. Touch the **Edit Favorite** button on the **Favorites Options Pop-up** screen to change the settings for an existing favorite. The **Edit Favorites Selection Screen** is displayed and displays up to 6 saved favorites.

Edit Favorites Selection Screen

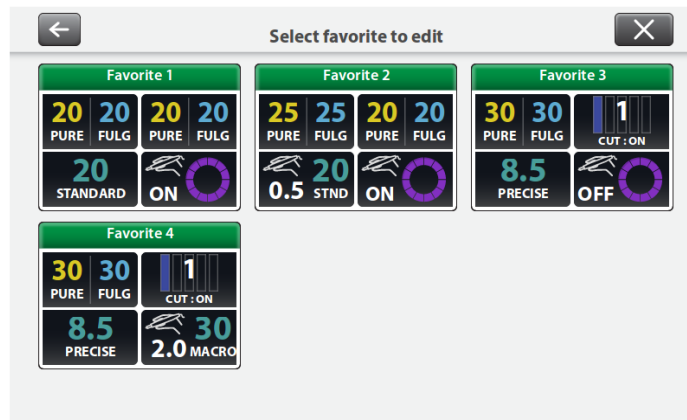

2. Touch the **Favorite** preference to edit. When the Favorite preference is selected, the Favorites Configuration Screen is displayed.
3. The Favorite preference can be modified as described in Chapters 4 – 7 of this User's Guide. Touch the **Confirm** button in the top right corner of the screen to save the changes and return to the Favorites Selection Screen.

Touch the **Back** button in the top left corner of the Favorites Configuration Screen to return to the Favorites Options Pop-up screen without saving the Favorite.

Touch the **Cancel** button in the top right corner of the Favorites Configuration Screen to return to the Clinical Screen without saving the Favorite.

Renaming a Favorite

Touch the **Favorites** button on the clinical screen to select, add, edit, or rename Favorite preferences. Touch the **Options** button on the Favorites Selection screen.

1. Touch the **Rename Favorite** button on the **Favorites Options Pop-up** screen to change the name of an existing Favorite preference. The **Rename Favorites Selection Screen** is displayed and shows up to 6 saved Favorite preferences.

Rename Favorites Selection Screen

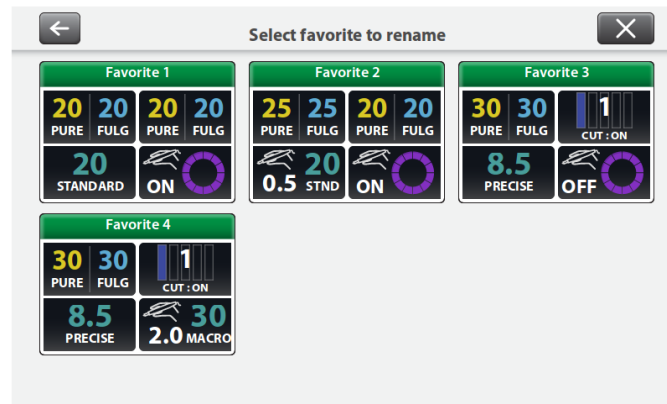

2. Touch the Favorite preference to rename. When the Favorite preference is selected, an on-screen keyboard is displayed.
3. Use the keyboard to type in a unique name for the Favorite.
4. Touch the **Confirm** button in the top right corner to save the name and return to the Favorites Selection Screen.

Touch the **Back** button in the top left corner of the keyboard to return to the Rename Favorites Selection Screen without saving the name.

Touch the **Cancel** button at the top right corner of the keyboard to return to the Clinical Screen without saving the Favorite.

Important

Touch the keyboard language selection button in the lower left corner of the keyboard screen to switch the keyboard input language.

Deleting a Favorite

Touch the **Favorites** button on the clinical screen to select, add, edit, or rename Favorite preferences. Touch the **Options** button on the Favorites Selection screen.

1. Touch the **Delete Favorites** button on the **Favorites Options Pop-up** screen to delete one or more existing Favorite preferences. The Delete Favorites Screen is displayed and shows up to 6 saved Favorite preference.

2. Touch the **Favorite** preference to be deleted. The Favorite preference will be highlighted, and a trash can will appear overlaid on the Favorite preference selected for deletion.

Delete Favorites Screen

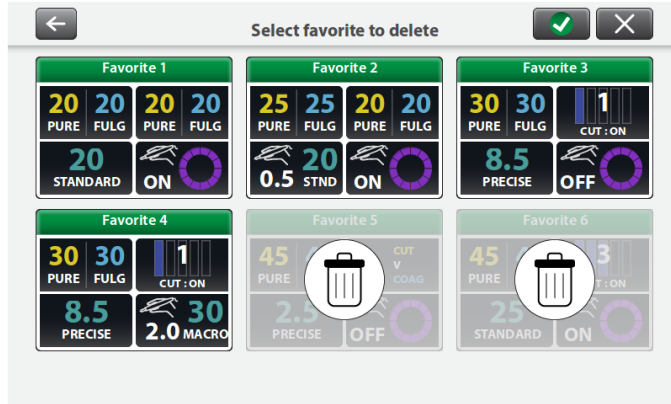

3. Touch the **Confirm** button in the top right corner to confirm the deletion and return to Favorites Selection Screen.

Touch the back button in the top left corner of the Delete Favorites Screen to return to the Favorites Options Pop-up screen without deleting a Favorite.

Touch the Cancel button in the top right corner of the Delete Favorites Screen to return to the clinical screen without deleting a Favorite preference.

Recent Settings

1. Touch the **Recents** button to select a recent setting.

Recents Selection Screen

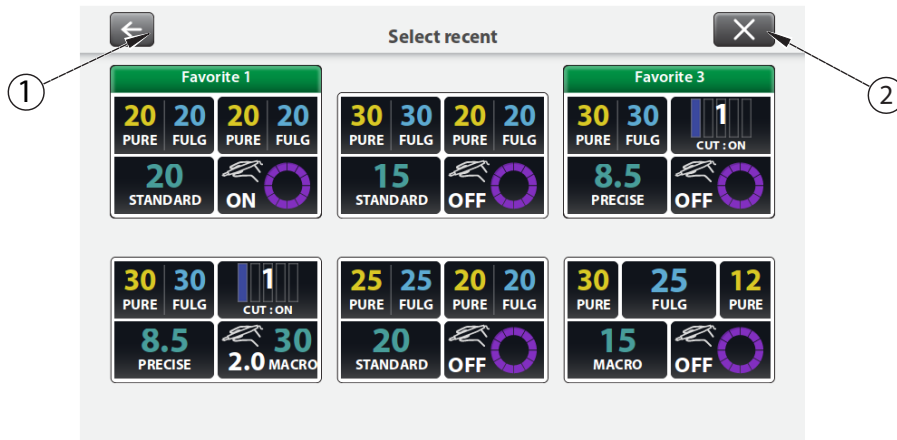

- ① Back button
- ② Cancel button

2. The **Recents Selection Screen** shows up to 6 selectable Recent preferences within the current group. Recent preferences are automatically saved by the system when an activation occurs after a settings change. If a Recent is also saved as a Favorite within the currently selected Group, this will be indicated with a named green bar above the Recent preference.
3. Touch the desired Recent preference for clinical use. The Clinical screen is displayed with the Recent preference ready for clinical use. If the Recent preference includes enabled Auto-Bipolar, a pop-up screen is displayed in the Bipolar quadrant for the user to acknowledge if or when a bipolar instrument is connected.
4. Touch the **Back** or **Cancel** button on the Recents Selection Screen to return to the Clinical Screen without changing the clinical settings.

System Functions

The Valleylab™ FT10 energy platform system functions are accessed from buttons on the front panel: **On/Off**, **Restore Settings**, **Audio Volume**, and **Service and Settings**.

On/Off



When the system is plugged into a power source, the **On/Off** button appears yellow. Turn on power to the energy platform by pressing and holding the On/Off button for 0.25 seconds. After a successful power-on self-test, the On/Off button illuminates green. A tone sounds to signal a successful system power up.

Press and hold the button for 1 second to turn power off. The button illuminates yellow when the system is powered down. If a system is non-responsive, holding the button for 10 seconds will power down the system.

Restore Settings



Select the **Restore Settings** button on the front panel to reset the system to the settings in use when the system was last powered down using the On/Off button. Accepting the prompt in the dialog box will reset all quadrants to their last setting. All modes and values are reset with the exception of Audio Volume and Auto Bipolar setting.

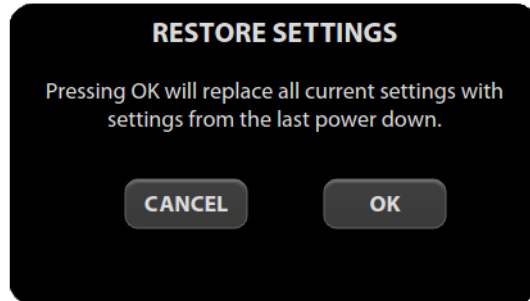

Touch **OK** and the touchscreen will display the last settings entered into each of the quadrants prior to shutting off the system.

Important

In the event that the energy platform suffers an unexpected loss of power, the Restore Settings button will not restore the settings in use at the time of power loss. The unit must be powered down normally in order for settings to be retained.

Audio Volume



The Valleylab™ FT10 energy platform has five levels of audio volume. Press the **Audio Volume** button on the front panel to view the volume-select menu.

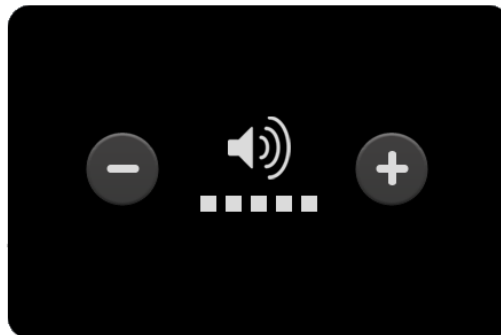

The factory setting is as shown with the volume set at its highest level. Adjust the volume using the **+** or **-** buttons. Dismiss the dialog box by touching the screen outside of the volume menu. The volume setting remains unchanged when restarting the energy platform.

Service and Settings



Press the Service and Settings button on the front panel to access the **Service and Settings** and if enabled, **Cardioblade** windows. A dialog box will appear on the touchscreen for window selection.

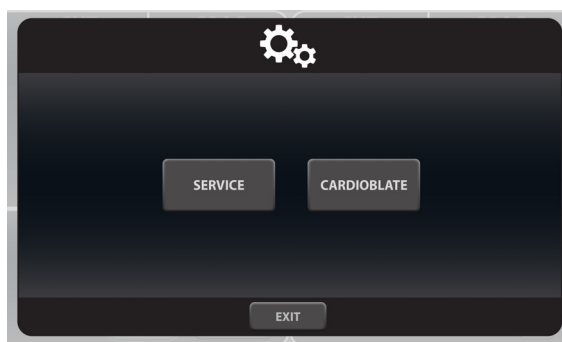

Touch the button for the desired window. See Cardioblade™ section for Cardioblade™ window.

Service and Settings Window

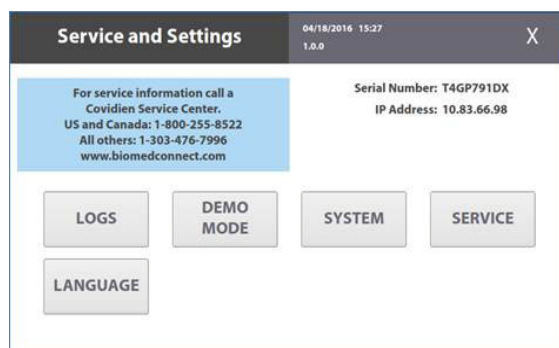

The **Service and Settings** window shows the energy platform serial number, IP address (if connected to the network), software version number, and contact information for the Covidien Service Center.

Buttons in this window allow access to the following functions:

- Viewing logs
 - Events Log
 - Error Log
 - Error Histogram
- Enabling DEMO Mode

- Selecting system settings
 - System Config
 - Diagnostics
 - Network
 - Time Zone
 - Calibration Info
- Accessing system service functions
 - Qualified service personnel can access service functions from a password-protected menu. Refer to the Valleylab™ FT10 energy platform service manual for service instructions.
- Selecting a language

Logs

The **LOGS** button displays the LOGS menu with three options.

1. Touch the **LOGS** button to view the Logs menu:
 - **EVENTS**—A detailed display of all user actions and energy platform events on the Valleylab™ FT10 energy platform
 - **ERROR**—A display of all recorded system errors with details
 - **ERROR HISTOGRAM**—A summary of how often an error has occurred
2. Touch entries to view available details:
 - **EVENTS**—Touch an event entry to view details. Touch **BACK** to return to the Event Log screen.
 - **ERROR LOG**—Touch an error to view its details in the *Error Details* dialog box. Touch the **SHOW EVENTS** button to view related events in the Events log entries. Touch **BACK** to return to the *Error Log* screen.
 - **ERROR HISTOGRAM**—Entries in the *Error Histogram* screen are not linked to other logs.

Important

Log files are maintained when the system is powered down. The time when the system was powered down or experiences a total loss of power is also logged.

When log files reach capacity, the earliest log is deleted to make room for the newest log.

Energy platform log files can be exported for viewing on a computer using Valleylab™ Exchange. These log files can be uploaded to the Valleylab™ Exchange server for further analysis by Covidien personnel.

DEMO Mode

DEMO mode is used for demonstration of the energy platform and accessories only. DEMO mode allows monopolar activation through an attached instrument without the use of a REM patient return electrode. When the monopolar surgery is performed clinically, the required return electrode provides a safe path for the current introduced to the patient's body.

Warning

DEMO mode delivers monopolar energy without the use of a patient return electrode, and is intended for demonstration purposes only. Chance of burns to the patient significantly increase when DEMO mode is used for clinical procedures.

Enable DEMO Mode

1. Touch **DEMO MODE** in the *Service and Settings* screen.
2. Touch the **Enable DEMO MODE** button to place the quadrants in DEMO mode. A reminder is posted: "NOT FOR CLINICAL USE."



3. Touch the screen anywhere outside the **EXIT DEMO MODE** button to temporarily remove the message, allowing full access to the controls.
4. Proceed with any practice or demonstration scenarios. While in DEMO mode, the REM alarm is deactivated, but RF power is still delivered.

Warning

DEMO mode does not monitor the quality of pad contact with the patient. Therefore, no warning will be issued from the energy platform when pad-to-patient contact degrades.

5. Touch **EXIT DEMO MODE** to close DEMO mode and return to the functional screen. This will enable REM.

System Menu

The System button accesses settings for

- System Config
- Diagnostics
- Network
- Time Zone
- Calibration Info

System Configuration

System Configuration displays the hardware, software, and firmware components of the Valleylab™ FT10 energy platform. This information is for reference only. No changes to the configuration can be performed from this screen.

Diagnostics

- **Instrument Bar Code Reader**—Insert a Covidien device with a scannable bar code into the LigaSure™/Bipolar receptacle. When the SCAN button is touched, the bar-code reader displays the current view from the reader's camera to verify it is working properly.
- **Self Test**—Runs the same system test as the power-on self-test when the system is turned on. Current power and mode settings in each quadrant will be lost as the system is reset to run the power-on self-test. These settings can be retrieved by pressing the **Restore Settings** button on the front panel. If the self-test is successful, a tone sounds.

Network

The **Network** button allows the technician to select a network connection to the Valleylab™ Exchange server for service operations. There are 3 ways to connect to the IT network:

- Wired Point-to-Point
- Wired Automatic
- Wired Manual

Important

The energy platform can only communicate through the Ethernet port while displaying service screens. Ethernet communications are disabled while displaying clinical screens.

Wired Point-to-Point

This selection allows the energy platform to communicate directly with another computer through an Ethernet cable that is connected from the energy platform to the computer.

Wired Automatic

This selection allows the energy platform to communicate on the IT network through an Ethernet cable that is connected from the energy platform to a router or the facility's DHCP server. The energy platform is automatically assigned an IP address by the facility's DHCP server.

Wired Manual

This selection allows the energy platform to communicate on the IT network through an Ethernet cable that is connected from the energy platform to a router or the facility's DHCP server. The technician must manually set a static IP address, network mask, and default gateway address.

Time Zone

Select a region from the drop-down menu to set the time zone used by the system clock. The time and date are originally set during the initial connection to Valleylab™ Exchange (see page 3-3).

Calibration Info

Calibration Info displays all of the energy calibration values stored in the Valleylab™ FT10 energy platform. This information is for reference only. No changes to the calibration values can be performed from this screen.

Service Menu

Items in the Covidien Service Menu are specifically for qualified service personnel and are password protected.

Language Selection Menu

The Language Selection Menu presents 25 buttons; each labeled with a language available for all software screens and options in the software interface. To change the language, select the button labeled with the desired language. The software interface changes the non-service windows to the selected language after the Language button is selected. Some service screens are not translated.

Chapter 4

Monopolar

This chapter describes the monopolar function of the Valleylab™ FT10 energy platform.

Precaution

Read the instructions, warnings, and precautions provided with this energy platform and associated accessories before using. Specific instructions for electro-surgical instruments are not included in this manual.

Front Panel Monopolar Features

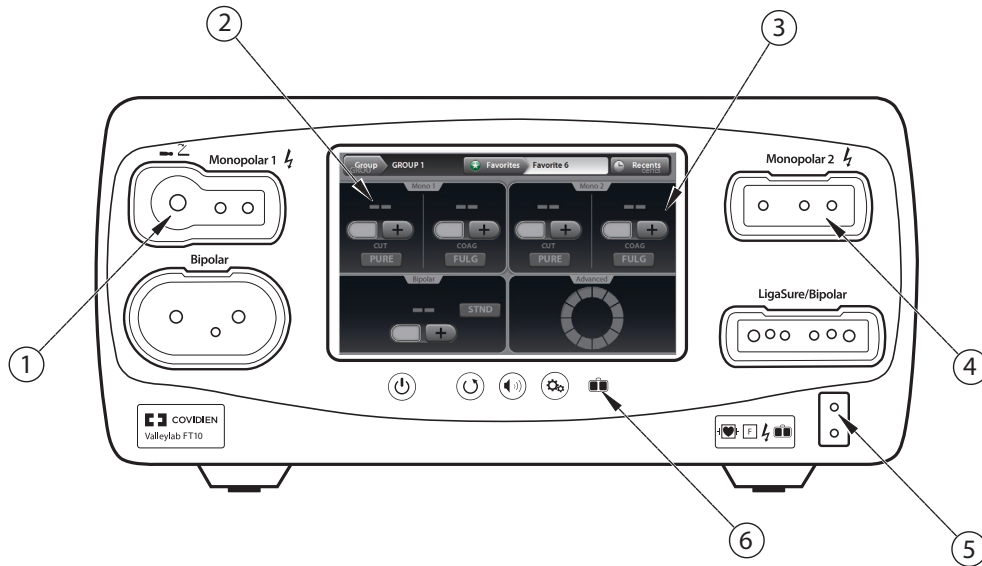

- ① Monopolar 1 Universal Foot Pedal Port (UFP) receptacle
- ② Monopolar 1 touchscreen quadrant
- ③ Monopolar 2 touchscreen quadrant
- ④ Monopolar 2 instrument receptacle
- ⑤ REM Patient return electrode receptacle
- ⑥ Return electrode monitoring (REM) indicator

Rear Panel Monopolar Features

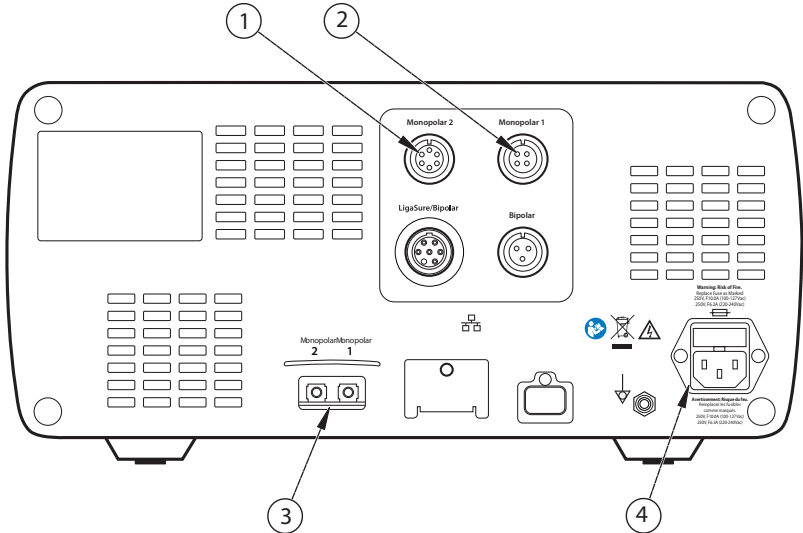

- ① Monopolar 2 foot-pedal receptacle (requires adapter to connect standard four-pin Monopolar foot pedal)
- ② Monopolar 1 foot-pedal receptacle
- ③ Interlink cable receptacle for EKG smoke-evacuation control devices
- ④ Power cord receptacle

Monopolar Quick Setup Instructions

If the user is familiar with the Valleylab™ FT10 energy platform, follow this abbreviated procedure to set up the system for monopolar surgery.

If the user is not familiar with the Valleylab™ FT10 energy platform and more detailed instructions are required, refer to the following sections in this chapter for detailed instructions on how to set up the system for monopolar surgery.

1. Plug the system power cord into the rear panel receptacle.
2. Plug the system power cord into a grounded power outlet.

Important

Do not plug the system power cord into a power strip or extension cord.

3. Turn on the energy platform and verify that the power-on self-test is successfully completed.
4. If using a foot pedal, connect it to a monopolar foot-pedal receptacle on the rear panel and position it on the floor within reach of the surgeon. The Monopolar 2 receptacle requires an adapter to connect a standard 4-pin monopolar foot pedal.

Warning

Connect only foot pedals from the compatibility list beginning on page 1-8. Use of other foot pedals may cause unexpected output to occur and may lead to patient injury.

5. Apply the patient return electrode to the patient and connect it to the patient return electrode receptacle on the energy platform's front panel.
6. Connect the instrument to the appropriate instrument receptacle on the front panel. Align the connector pins with the dots below each monopolar receptacle to ensure full functionality of the instrument. Inserting an instrument into the Monopolar 1 receptacle will require additional force.
7. Verify or change the mode and power settings in the corresponding quadrant of the touchscreen.

Monopolar Function Overview

Monopolar Power Output Modes

The monopolar energy channels can be configured to these modes: PURE CUT, BLEND, VALLEYLAB, SOFT (if enabled), FULGURATE, SPRAY, and SHARED (if enabled).

Warning

Electric Shock Hazard

- Do not connect wet instruments to the system.
- Ensure that all instruments and adapters are correctly connected and that no metal is exposed at any connection point.

Connect instruments to the proper receptacle. Improper connection may result in inadvertent instrument activation or other potentially hazardous conditions. Follow the instructions provided with electro-surgical instruments for proper connection and use.

Each instrument receptacle on this energy platform is designed to accept only one instrument at a time. Follow the instructions provided with electro-surgical instruments for proper connection and use.

Precaution

Read the instructions, warnings, and precautions provided with electro-surgical instruments before use. Specific instructions are not included in this manual.

Inspect instruments and cords—especially for laparoscopic/endoscopic instruments—for breaks, cracks, nicks, and other damage before every use. If damaged, do not use. Damaged instruments or cords may result in injury or electrical shock to the patient or surgical team.

Foot Pedal

Monopolar foot pedals connect to the rear panel and correspond to either the Monopolar 1 or Monopolar 2 receptacles on the front panel.

Standard foot-pedal devices attached to the Monopolar 1 Universal Foot Pedal Port receptacle on the front panel can be controlled with a Covidien foot pedal attached to the Monopolar 1 foot-pedal receptacle on the back panel.

Warning

Connect only foot pedals from the compatibility list beginning on page 1-8. Use of other foot pedals may cause unexpected output to occur and may lead to patient injury.

Monopolar Foot-Pedal Activation

Most devices attached to the Monopolar 1 or Monopolar 2 receptacle—whether handswitching or foot-pedal-activated accessories—can be controlled with a foot pedal.

Monopolar foot pedal activation can be set up using compatible accessories:

- Two- or three-button pencil or pedal-activated instrument
- Two- or three-pedal foot pedal
- Foot-pedal adapter 1017577 for Monopolar 2 (shown below)

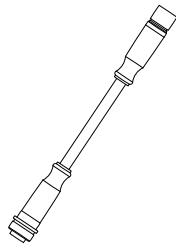

Setup:

1. Plug the two-pedal foot-pedal connector into the Monopolar 1 foot-pedal receptacle on the rear panel.
2. Plug a two-button pencil into the Monopolar 1 receptacle, or plug a pedal-activated instrument cord into the Universal Foot Pedal Port (UFP) portion of the Monopolar 1 receptacle (identified by a blue ring). A UFP adapter is required for UFP-instrument connectors that have a plug diameter less than 4 mm.
3. Attach a FT6003 three-pedal foot pedal or two-pedal foot pedal with 6-pin-to-4-pin adapter 1017577 to the Monopolar 2 foot-pedal receptacle on the back panel.
4. Plug the two-button pencil or a Force TriVerse™ instrument into the Monopolar 2 receptacle.
5. Select settings for the procedure.
6. Step on the appropriate pedal to deliver monopolar power.

Important

CUT and COAG activation is also available for Force TriVerse™ instruments controlled by a two-pedal foot pedal.

Return Electrodes – REM™ Contact Quality Monitoring System

Notice

Only contact-quality-monitoring-system patient return electrodes can be used with the Valleylab™ FT10 energy platform.

Patient Return Electrode Considerations

Warning

It is not possible to foresee what combination of current and duty cycle may be safely used in every situation—for example, when higher currents and/or longer duty cycles are used on procedures such as tissue lesioning, tissue ablation, tissue vaporization; and procedures where conductive fluid is introduced into the surgical site. Under these conditions a greater risk may exist that the heating under a fully applied return electrode may be high enough to injure the patient.

When using a Covidien energy platform or a patient return electrode during these types of surgical procedures, the user should seek written guidance in the form of detailed user instructions from the manufacturer of the active accessory regarding the currents and duty cycles that can be expected. In some instances, the application of additional patient return electrodes may help mitigate the increased risk.

During monopolar electrosurgery, a patient return electrode is always required to safely recover the current that flows through the patient's body and return it to the energy platform. A reduction in surface area contact or poor conductivity between the patient and the return electrode can cause the current to become concentrated, potentially resulting in burns at the return-electrode site.

During a surgical procedure, the amount of current delivered in a given time determines the amount of heating that occurs under the return electrode. REM Polyhesive™ patient return electrodes are designed for use during conventional electrosurgical procedures and duty cycles (on time compared to total on/off time). Users should consult Chapter 11, *Technical Specifications* for the recommended maximum duty cycle specifications.

How the REM™ System Works

The Valleylab™ FT10 energy platform uses the REM™ contact-quality monitoring system to monitor the quality of electrical contact between the patient return electrode and the patient. The REM™ system is designed to reduce the risk of burns at the return electrode site. A non-REM return electrode is not to be used with the Valleylab™ FT10 energy platform.

The REM™ system continuously measures the resistance at the return electrode site and compares it to a standard range of safe resistance (between 5 Ω and 135 Ω), thus eliminating intermittent false alarms that could result from small changes in resistance.

The REM™ system also adapts to individual patients by measuring the initial contact resistance between the patient and the patient return electrode and lowering the baseline resistance if the contact resistance drops.

A REM alarm sounds and the system stops producing output power when **either** of the following occurs:

- The measured resistance is below 5 Ω or above 135 Ω , the limits of the standard range of safe resistance.
- An increase in contact resistance is greater than 40% from the baseline measurement.

Patient Return Electrode Setup



When the power-on self-test is complete, the REM icon appears if a REM return electrode is not connected to the energy platform or incorrectly attached to a patient. The icon is removed when the return electrode is correctly attached to the system and patient.

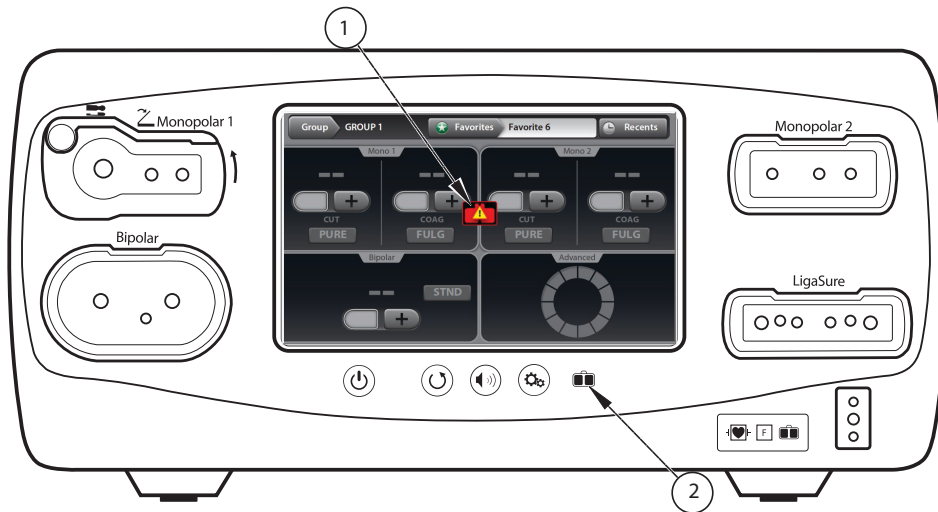

- ① REM icon
- ② REM LED indicator

A REM indicator, located below the touchscreen also displays the status of the return electrode by illuminating red when not connected or improperly applied to the patient.

The REM indicator illuminates green when the system senses that the patient return electrode is properly connected to the energy platform and patient.

Warning

The safe use of monopolar electrosurgery requires proper placement of the patient return electrode. To avoid electrosurgical burns beneath the patient return electrode, follow all directions on the product package and the instructions for use for proper return electrode placement and use.

Do not cut a patient return electrode to reduce its size. Patient burns due to high-current density may result.

1. Select a well vascularized, convex area in close proximity to the surgical site for electrode application. Avoid scar tissue, bony prominences, excessive adipose tissue, and areas where fluid may pool.
2. The patient return electrode site should be free of excessive hair. Remove hair from the selected application site in accordance with the policies and procedures of your facility.

3. Clean and dry the application site as needed. The application site must be free of oils, lotions, and other topically applied products to ensure secure contact between the patient's skin and the return electrode.
4. Remove the return electrode from its pouch.
5. Remove the liner from the electrode and apply it to the patient.
6. Turn on the energy platform and allow it to complete the self test.
7. Insert the return-electrode connector into the REM patient return electrode receptacle on the front panel. See page 4-2 for the receptacle location.

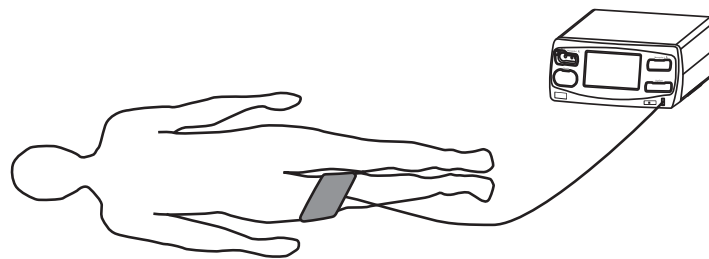

REM Alarm (Visual and Audible)

If the REM™ system senses an alarm condition during the activation of an instrument, RF power delivery stops. An error message is displayed on the touchscreen and two audible warnings sound. The indicator below the screen illuminates red.

When the alarm condition is corrected, the error message or REM symbol (whichever is on the screen) closes and the REM LED illuminates green.

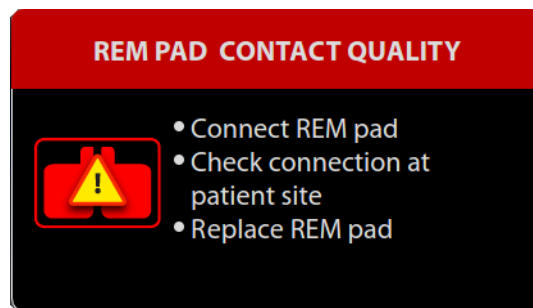

For instructions to correct REM alarms, refer to Chapter 9, *Troubleshooting* and the troubleshooting flow chart in the REM Polyhesive™ patient return electrode instructions for use.

Monopolar Electrodes

Connect a monopolar instrument to the Monopolar 1 or Monopolar 2 instrument receptacle on the front of the energy platform. See the Covidien instrument's instructions for use for recommendations on which receptacle to use.

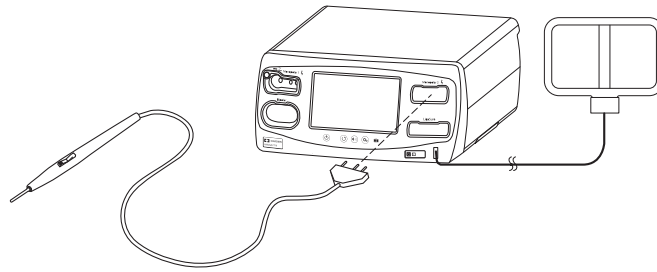

The Monopolar 1 UFP-receptacle, identified by a blue ring, accepts UFP connectors with diameters of 4 mm to 8 mm, and lengths of 15.2 mm to 41.7 mm. UFP connectors with a diameter of less than 4 mm require an adapter to connect to the Monopolar 1 UFP receptacle.

Warning

Ensure the UFP connector is fully inserted in the energy platform prior to use. A partially inserted connector may result in injury to the surgical team if the exposed connector is touched during use.

Monopolar Mode Settings

Monopolar settings can be selected for an instrument by four methods:

- **User Input** - Modes and power levels are selected before or after attaching the instrument.
- **Automatic** - Settings are selected by the system when an attached instrument is identified. Most Automatic settings override Preset settings.
- **Restore Settings** - Using the Restore Settings button to reset the system to the settings in use when the system was last powered down.
- **Saved Settings** - Use the saved settings feature to return the system to the previous settings either saved manually by the user or saved automatically by the system.

Important

RF energy cannot be activated while the settings popup is displayed. Touch the cancel button in the top right corner to return to the Clinical screen.

User Input Instrument Settings

Monopolar settings can be set on the main screen of the energy platform before or after inserting a monopolar instrument that is not recognized by the FT10, such as two-button pencils and pedal-activated instruments. If the settings are made before inserting an instrument, the settings will be in effect when the instrument is attached to the monopolar receptacle, unless the FT10 detects an instrument type in the Monopolar 2 receptacle that includes automatic settings.

1. Place the energy platform in the edit state (power on, no instrument attached).
2. Manually select a mode and power-output level for a monopolar instrument from the touchscreen.
3. Attach an instrument to the monopolar receptacle that corresponds to the edited quadrant (left for Monopolar 1 and right for Monopolar 2). Inserting an instrument into the Monopolar 1 receptacle will require additional force.
4. Further edit the monopolar settings if so desired or if Step 2 was skipped.

The pre-set settings are active for the attached instrument only if the instrument does not include automatic settings.

Automatic Settings for a Recognized Instrument

Some Covidien instruments compatible with the FT10 have an identification that is recognized by the system when attached to the Monopolar 2 receptacle. The energy platform automatically sets the default mode and power level assigned to the instrument. These settings are displayed on screen. Settings can be changed prior to activation.

Note: Inserting a monopolar instrument that is not recognized by the system will result in no change to the existing monopolar settings. If the settings have been manually changed prior to insertion or the Restore Settings button was used, those settings remain in effect.

Monopolar Default Settings

Monopolar Instrument	Default
Two-button Pencil and Pedal-Activated Instrument	PURE CUT (CUT mode) and FULGURATE (COAG mode)
	Power setting defaults to disabled (--)
Force TriVerse™	PURE CUT, VALLEYLAB, COAG
	Power setting is 1 power bar
	CUT mode is ON (enabled)

Restore to the Last Settings Used

Use the Restore button to enter the settings when the system was last powered down. The Restore button can be used prior to and after insertion of the instrument.

1. Press the **Restore** button. A dialog box appears indicating the current settings will be replaced with those from the last time the energy platform was powered down.
All quadrants are populated with previous settings for each.
2. Press **OK** to confirm the use of the last settings.
Inserting an instrument changes the corresponding quadrant's control from flat grey to a brightly illuminated color.

Saved Settings

Use the saved settings feature to return the system to the previous settings either manually saved by the user or automatically saved by the system. See *Saved Settings* on page 3-4.

VALLEYLAB™ Mode Functionality

Some Covidien instruments featuring the VALLEYLAB™ mode—a unique combination of hemostasis and dissection—are specialty devices providing output control from the sterile field. Those with a sliding power control on the instrument enable direct adjustments to power output during surgery.

These output modes, if available on the instrument, are selected at the handset with the following buttons:

- The yellow CUT button activates a cutting function.
- The clear VALLEYLAB button activates a hemostasis function while providing dissection.
- The blue COAG button activates a coagulation function.

If available on the instrument, a dual slider control adjusts power output in all available modes.

Note: Monopolar 1 does not support VALLEYLAB™ mode and Force TriVerse™.

Note: When a Force TriVerse™ instrument is inserted, the screen changes from the default two-button instrument display to the Force TriVerse™ insert state in which the controls change from flat grey to a brightly illuminated color.

When an instrument with VALLEYLAB-mode capability is attached to the Monopolar 2 receptacle, the energy platform detects the instrument type and changes the screen from the default two-button to the corresponding screen.

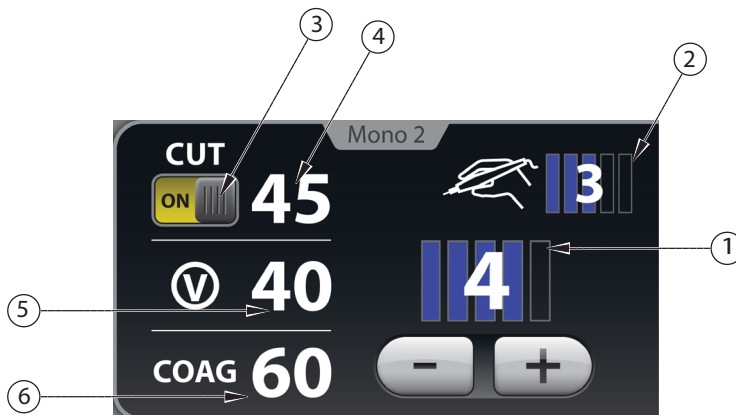
Force TriVerse™ Screen

- ① Power bar indicator
- ② Slider position indicator
- ③ CUT mode ON/OFF switch
- ④ CUT mode power indicator (watts)
- ⑤ VALLEYLAB™ mode power indicator (watts)
- ⑥ COAG mode power indicator (watts)

Power Bars—The five power bars represent the range of power available for the instrument attached to the energy platform receptacle. The system automatically identifies the instrument and selects the default power-bar setting. The power bars represent power *available* to the instrument and can be set independently from the slider bars indicated in the slider-position indicator. Power bars can only be changed at the touchscreen interface on the energy platform.

Note: Refer to the individual instrument instructions for power-bar output in watts.

ON/OFF Switch for CUT—Enable or disable the CUT button. CUT will not be available from the yellow button on the instrument when disabled on the touchscreen.

Slider Position (if available on the instrument)—The energy platform detects the position of the instrument's slider switch, and the slider position indicator displays this position. Slider position can only be changed by the instrument user in the sterile field.

Using a VALLEYLAB-Mode Instrument

1. Select the desired power level by touching the plus and minus buttons on the Power Bar indicator. A brief double tone sounds. Power output is displayed in watts. The power level cannot be changed during instrument activation.

Warning

The power-selecting slider, if available on the instrument, increases and decreases power output. Verify the slider position prior to activation.

2. Activate power output by pressing the desired button on the instrument.
 - Activate the CUT mode by pressing the yellow button on the electrosurgical instrument. The Monopolar 2 quadrant display illuminates yellow and a tone sounds for the duration of the activation.
Note: CUT mode is not available when disabled on the touchscreen with the ON/OFF switch.
 - Activate the VALLEYLAB™ mode by pressing the clear button on the electrosurgical instrument. The Monopolar 2 quadrant display illuminates white and a tone sounds for the duration of the activation. VALLEYLAB™ mode can also be activated with the middle (white) pedal of the FT6003 Three-Pedal Footswitch.
 - Activate the COAG mode by pressing the blue button on the electrosurgical instrument. The Monopolar 2 quadrant display illuminates blue and a tone sounds for the duration of the activation.
3. If the instrument has a slider, the power output can be changed while in the sterile field by adjusting the slider position on the electrosurgical instrument. A double tone will sound when slider position is changed. Slider position cannot be changed while RF energy is being delivered.

CUT Mode Disable (Force TriVerse™ only)

Power output can be disabled in the CUT mode using the ON/OFF switch.

1. Disable the CUT mode by touching the screen ON/OFF selector below CUT. The power indicator is grayed out when disabled.
2. Enable the CUT mode by touching the ON/OFF switch below CUT on the screen. The grayed out power indicator in the CUT box will be enabled. The CUT mode is also re-enabled when the energy platform is restarted.

SHARED COAG Functionality

The FT10 provides the ability to share COAG power between two simultaneously activated monopolar instruments. A single power level is set, and the energy platform controls the total power shared between the two activated instruments. The FT10 treats the two monopolar instruments like parallel circuits, so the amount of power each instrument receives is based on the impedance at both instruments; a greater share of the power will go to the lower impedance.

SHARED COAG Setup

SHARED COAG can be entered by touching the displayed COAG mode for either Monopolar 1 or Monopolar 2 (if the default two-button pencil screen is presented) and, on the Monopolar settings popup, selecting SHARED and selecting the COAG mode. To exit the monopolar settings popup without applying any changes to the settings, touch the cancel button in the top right corner of the screen.

Important

RF energy cannot be activated while the settings popup is displayed. Touch the cancel button in the top right corner to return to the Clinical screen.

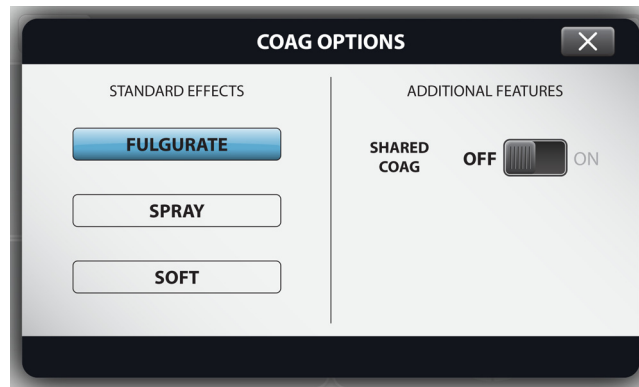

When SHARED COAG is entered, the available power can be selected.

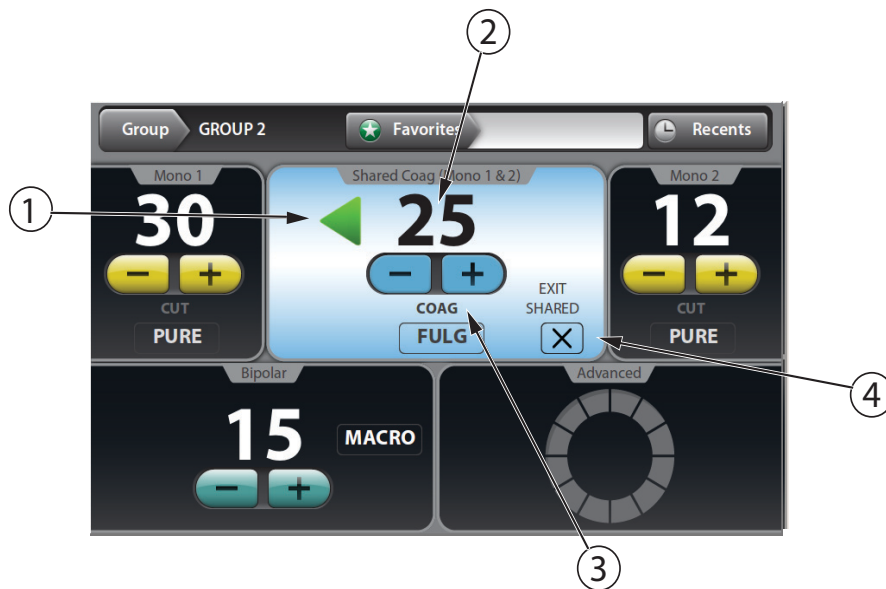

- ① Monopolar device COAG activation indicator
- ② SHARED COAG power setting
- ③ COAG mode indicator
- ④ SHARED COAG exit button

COAG Activation Indicator

An arrow appears on the screen to indicate which monopolar device is activating. The arrow appears on the left side and points to the left for Monopolar 1 activation, and it appears on the right side and points to the right for Monopolar 2 activation. Both arrows appear when the two monopolar devices are activating simultaneously.

SHARED COAG Power

The SHARED COAG power can be set to OFF or a power setting from 1 to 120 Watts in the same manner that power is normally selected. The displayed power is the total monopolar COAG power output available to the two connected monopolar instruments. This power is shared between the two monopolar devices when the devices are activated simultaneously, so one instrument receives a portion of the selected power and the other instrument receives the remainder. The amount of power each instrument receives is based on the impedance at both instruments; a greater share of the power will go to the lower impedance.

Warning

Use the lowest power setting that achieves the desired effect for a single user.

COAG Mode

SHARED COAG can be set to either FULGURATE or SPRAY mode in the same manner that mode is normally selected. The setting is displayed on the screen. Both monopolar instruments use the same COAG mode.

SHARED COAG Exit

SHARED COAG can be exited by touching the Exit Shared button on the touchscreen. This changes the monopolar quadrants back to their standard display. The previous COAG settings are restored.

Note: The SHARED COAG settings are retained while the energy platform remains powered on. Reentering SHARED COAG will restore the previous settings.

Closing Monopolar Settings Window

The **Monopolar Settings** popup can be exited quickly in response to the surgeon's needs. Any of the following actions closes the Monopolar Settings window without applying the selected changes.

- Touch the **Cancel** button in the top-right corner.
- Press the power, volume, or gear button on the front panel.
- Time out after 10 seconds.

After Surgery

Disconnect the instruments

1. Turn off the energy platform.
2. Disconnect all instruments from the front panel.
3. Dispose of the instrument according to the procedures for your institution.
4. Disconnect and store any foot pedals used. For the cleaning procedure, see *Cleaning* on page 10-3.
5. Disconnect the power plug from the wall receptacle by pulling the plug, not the cable.

Chapter 5

Bipolar

This chapter describes the bipolar function of the Valleylab™ FT10 energy platform.

Precaution

Read the instructions, warnings, and precautions provided with this energy platform and associated accessories before using. Specific instructions for electro-surgical instruments are not included in this manual.

Front Panel Bipolar Features

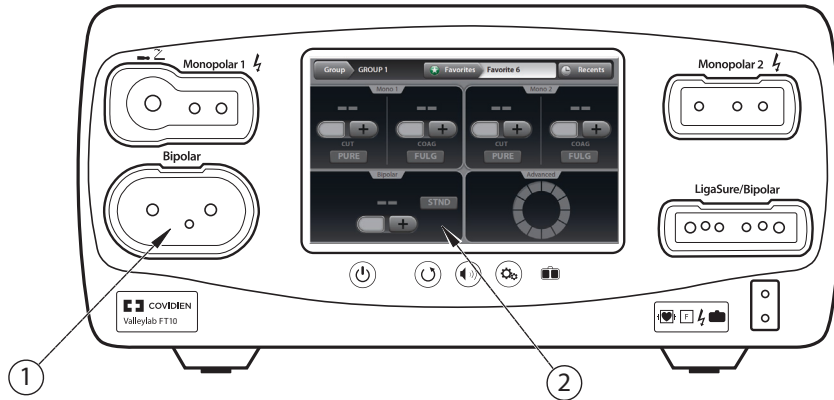

- ① Bipolar receptacle
- ② Bipolar touchscreen quadrant

Rear Panel Bipolar Features

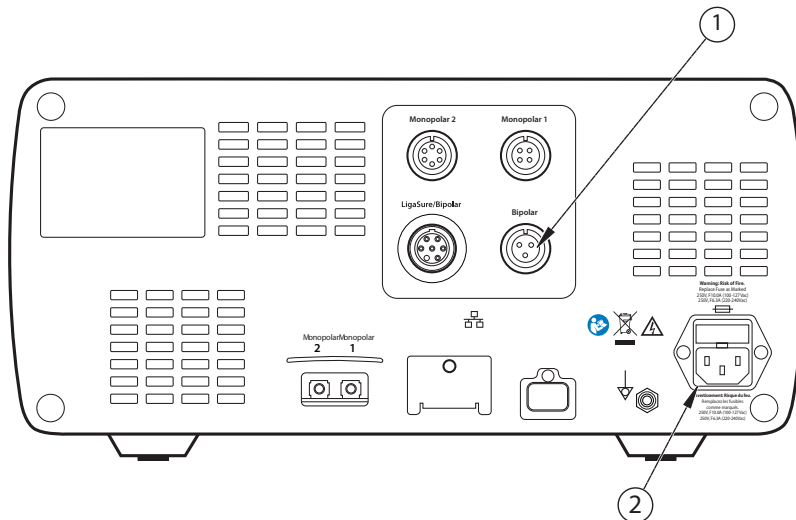

- ① Bipolar foot-pedal receptacle
- ② Power cord receptacle

Bipolar Quick Setup Instructions

If the user is familiar with the Valleylab™ FT10 energy platform, follow this abbreviated procedure to set up the system for bipolar surgery.

If the user is not familiar with the Valleylab™ FT10 energy platform, refer to the following sections in this chapter for detailed instructions on how to set up the system for bipolar surgery.

1. Plug the system power cord into the rear panel receptacle.
2. Plug the system power cord into a grounded wall receptacle.

Important

Do not plug the system power cord into a power strip or extension cord.

3. Turn on the system and verify that the power-on self-test successfully completes.
4. If using a foot pedal, connect it to the bipolar foot-pedal receptacle on the rear panel and position it on the floor within reach of the surgeon.

Warning

Connect only foot pedals from the compatibility list beginning on page 1-8. Use of other foot pedals may cause unexpected output to occur and may lead to patient injury.

5. Connect the instrument to the bipolar instrument receptacle on the front panel.
6. Verify or change the mode and power settings.

Bipolar Function Overview

Delicate tissue requires less energy to desiccate. The Valleylab™ FT10 energy platform provides low-voltage, continuous wave current for faster dessication with minimal sparking.

The possibility of sparking increases as desiccated tissue becomes more resistant to energy flow. The system reduces the possibility of sparking by limiting or reducing the bipolar voltage at relatively high levels of tissue impedance.

Bipolar Power Output Modes

The Valleylab™ FT10 energy platform produces three bipolar modes : PRECISE (0.5 -70 watts), STANDARD (1-70 watts), and MACRO (1-70 watts).

Warning

Electric Shock Hazard

- Do not connect wet instruments to the energy platform.
- Ensure that all instruments and adapters are correctly connected and that no metal is exposed at any connection point.

Connect instruments to the proper receptacle. Improper connection may result in inadvertent instrument activation or other potentially hazardous conditions. Follow the instructions provided with electro-surgical instruments for proper connection and use.

The instrument receptacles on this system are designed to accept only one instrument at a time.

Precaution

Read the instructions, warnings, and precautions provided with electro-surgical instruments before use. Specific instructions are not included in this manual.

Inspect instruments and cords—especially for laparoscopic/endoscopic instruments—for breaks, cracks, nicks, and other damage before every use. If damaged, do not use. Damaged instruments or cords may result in injury or electrical shock to the patient or surgical team.

Do not use instruments with flying leads with the Valleylab™ FT10 energy platform.

Do not use the FT0501 ForceTriad™ bipolar adapter on the Valleylab™ FT10 energy platform.

Bipolar Default Settings

Output	Default
Bipolar	<ul style="list-style-type: none"> • STANDARD mode • Power—disabled (–) • Ammeter—off

Foot Pedal

The Valleylab™ FT10 energy platform in bipolar mode can accommodate a three-pin, single-pedal bipolar foot pedal.

If pedal activation is to be used with a bipolar instrument, attach the bipolar foot-pedal connector to the bipolar foot-pedal receptacle on the rear panel.

Warning

Connect only foot pedals from the compatibility list beginning on page 1-8. Use of other foot pedals may cause unexpected output to occur and may lead to patient injury.

Virtual Ammeter

The virtual ammeter on the bipolar quadrant displays the current delivered during bipolar-instrument activation. The ammeter registers current between 1 and 1,000 milliamps. An audio tone sounds to indicate increases and decreases in current delivery.

Note: The virtual ammeter is a feature that is not available on the clinical screen until it is enabled. This feature can be enabled through Valleylab™ Exchange by a Covidien sales representative.

Setting the Ammeter

To setup the ammeter to display during bipolar procedures:

1. Access the bipolar settings by touching the mode button in the bipolar quadrant. The **Bipolar Settings** popup appears with the ammeter default setting OFF.

Important

RF energy cannot be activated while the settings popup is displayed. Touch the cancel button in the top right corner to return to the Clinical screen.

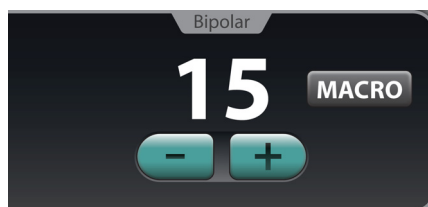

2. Touch the ammeter **ON/OFF** switch to turn on the visual ammeter and audio ammeter tones for bipolar procedures.

Important

The ammeter setting is not available when Auto Bipolar is ON.

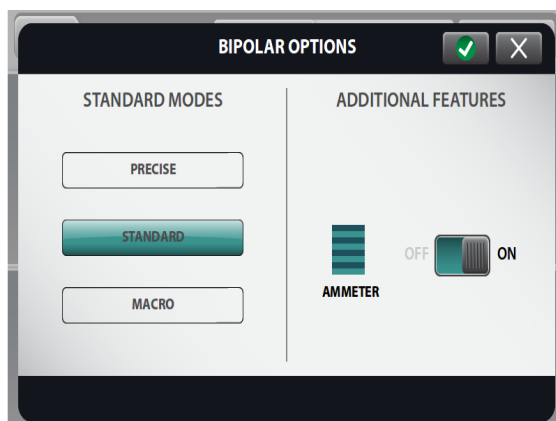

3. Touch **Confirm** to close the ammeter settings window and retain any changes. The visual ammeter is added to the bipolar screen and the audio and visual feedback is in use during bipolar activation. To exit the bipolar settings popup without applying any change to the settings, touch the cancel button in the right corner.

Ammeter settings are retained in the bipolar quadrant until the system is powered down.

Auto Bipolar Function

The Valleylab™ FT10 energy platform is equipped with an Auto Bipolar feature that configures the system for automatic activation and cessation of bipolar energy.

Auto Bipolar must be ON in the Bipolar Settings window before the Auto Bipolar function can be used as the default Auto Bipolar setting is OFF.

Note: Auto Bipolar is a feature that is not available on the clinical screen until it is enabled. This feature can be enabled through Valleylab™ Exchange by a Covidien sales representative.

Turning Auto Bipolar ON/OFF

1. Access the bipolar settings by touching the **Mode** button in the bipolar quadrant. The bipolar settings popup appears with the default Auto Bipolar setting OFF.

Important

RF energy cannot be activated while the settings popup is displayed. Touch the cancel button in the top right corner to return to the Clinical screen.

2. Touch the AUTO **ON/OFF** switch.

Important

When Auto Bipolar is turned ON, the ammeter setting option disappears. If the ammeter was ON before, it must be turned OFF to turn ON Auto Bipolar.

3. Set the Auto Bipolar activation delay and touch the **Confirm** button. The bipolar quadrant shows the Auto Bipolar symbol and the delay time to indicate that Auto Bipolar is ON. To exit the bipolar settings popup without applying any change to the settings, touch the **Cancel** button in the top right corner.

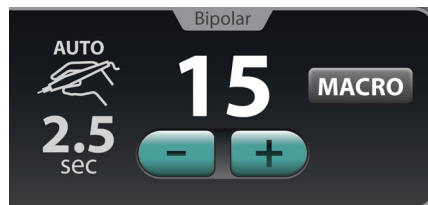

Important

When Auto Bipolar is turned ON while no bipolar instrument is inserted, an Auto Bipolar confirmation window will appear upon instrument insertion.

Auto Bipolar Activation Impedance

The impedance of the tissue grasped by the bipolar device must be within a factory-set range of up to 2200 Ω to activate. If impedance during activation increases to greater than 4000 Ω , RF energy will deactivate. The activation impedance range is a safety feature that prevents power delivery if the grasped tissue is not within the anticipated range.

Tissues such as scar tissue, moles, and others with low blood flow are likely to have impedance greater than 2200 Ω . While grasping high-impedance tissue, the Valleylab™ FT10 will not activate regardless of customer-set preferences.

Warning

Use of different Covidien cord models or cords from other manufacturers may not achieve proper electrical output for this device, thereby failing to produce the desired clinical effect. For example, Auto Bipolar activation/deactivation settings may not work properly using cords other than those specified by Covidien.

Precaution

Bipolar forceps should not be set down while Auto Bipolar is active. Contact with any material may cause activation. Turn off Auto Bipolar before setting down an instrument.

Setting the Auto Bipolar Activation Delay

Specify a delay between the instrument's initial contact with tissue and delivery of bipolar energy.

1. When Auto Bipolar is ON, access the activation delay settings by touching the **Mode** button in the bipolar quadrant.

Important

RF energy cannot be activated while the settings popup is displayed. Touch the cancel button in the top right corner to return to the Clinical screen.

2. Use the plus or minus buttons to set the activation delay time (in seconds). Delay selections are 0.0 (default), 0.5, 1.0, 1.5, 2.0, and 2.5 sec.

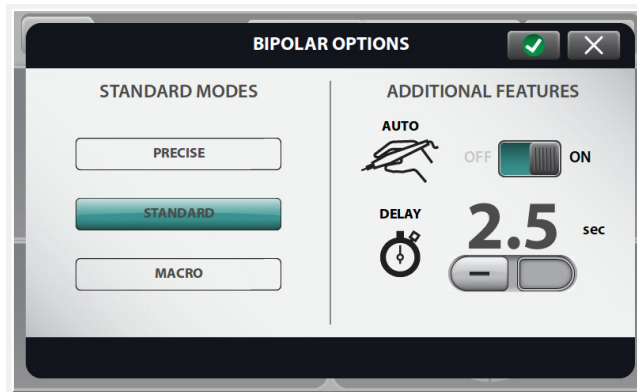

3. Touch **Confirm** to close the window and apply the delay setting. The delay time will be displayed in the bipolar quadrant.

Important

The tines of the bipolar instrument must be removed from the tissue between each Auto Bipolar activation.

Closing the Bipolar Settings Window

The **Bipolar Settings** popup can be exited quickly in response to the surgeon's needs. Any of the following actions closes the Bipolar Settings window without applying the selected changes.

- Touch the **Cancel** button in the top-right corner.
- Press the power, volume, or gear button on the front panel.
- Time out after 10 seconds.

Bipolar Adapter

The VLFT10ADP1 Bipolar Adapter turns the LigaSure™ technology/Bipolar receptacle into a second bipolar receptacle with all of the same functionality as the first.

1. Connect a compatible bipolar cord to the VLFT10ADP1 bipolar adapter.
2. Insert the VLFT10ADP1 bipolar adapter into the LigaSure™ technology/Bipolar receptacle.
3. If using a foot pedal, connect it to the LigaSure/Bipolar foot-pedal receptacle on the rear panel and position it on the floor within reach of the surgeon.

Warning

Connect only foot pedals from the compatibility list beginning on page 1-8. Use of other foot pedals may cause unexpected output to occur and may lead to patient injury.

**Important**

If the VLFT10ADP1 bipolar adapter is used, only one bipolar instrument can set the Auto Bipolar feature to ON.

After Surgery

Disconnect the instruments

1. Turn off the energy platform.
2. Disconnect all instruments from the front panel.
3. Dispose of the instrument according to the procedures for your institution.
4. Disconnect and store any foot pedals used. For the cleaning procedure, see *Cleaning* on page 10-3.
5. Disconnect the power plug from the wall receptacle by pulling the plug, not the cable.

Chapter 6

LigaSure™ Technology

This chapter describes how to set up and operate the LigaSure™ technology tissue-fusion function of the Valleylab™ FT10 energy platform.

Precaution

Read the instructions, warnings, and precautions provided with this energy platform and associated accessories before using. Specific instructions for electro-surgical instruments are not included in this manual.

Front Panel LigaSure™ Technology Features

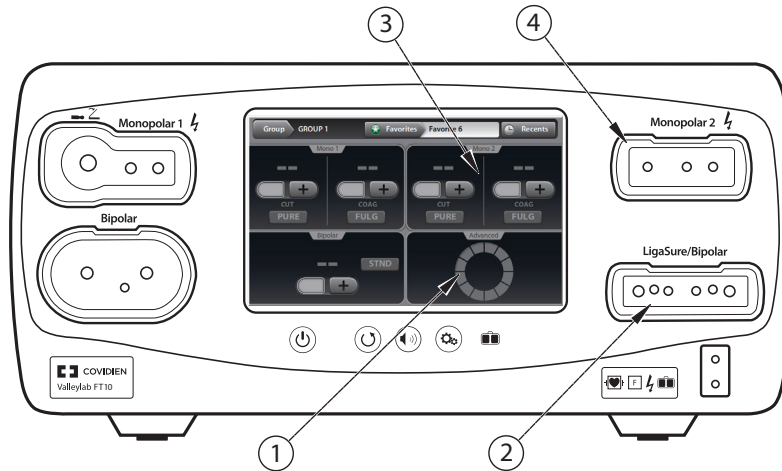

- ① LigaSure™ technology quadrant
- ② LigaSure™ technology/Bipolar receptacle
- ③ Monopolar 2 quadrant (for LigaSure™ technology dual-plug instruments)
- ④ Monopolar 2 receptacle (for LigaSure™ technology dual-plug instruments)

Rear Panel LigaSure™ Technology Features

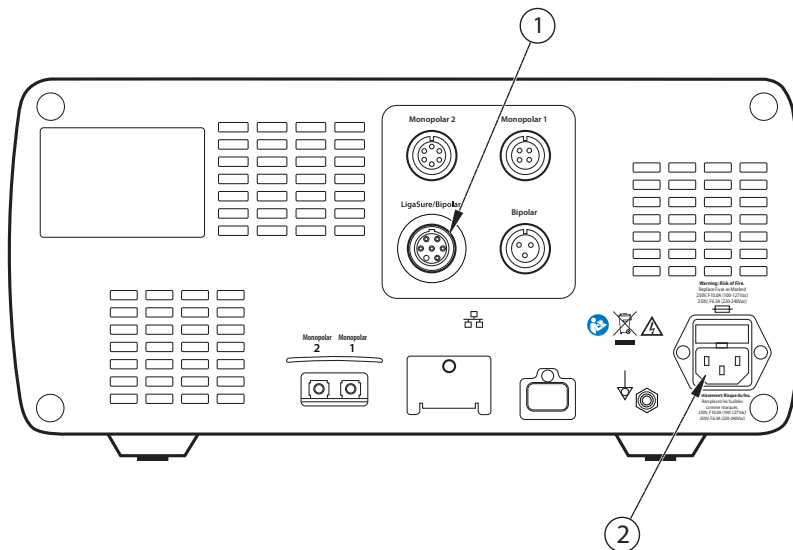

- ① LigaSure™ technology/Bipolar foot-pedal receptacle
- ② Power cord receptacle

LigaSure™ Technology Quick Setup Instructions

If the user is familiar with the Valleylab™ FT10 energy platform, follow this abbreviated procedure to setup the system for LigaSure™ technology tissue fusion.

The following instructions are for a single-plug instrument, which covers most LigaSure™ technology devices. For devices that have two plugs and provide both LigaSure™ technology and monopolar functionality, see *Connecting Dual-Plug LigaSure™ Technology Instruments* on page 6-8.

If the user is not familiar with the Valleylab™ FT10 energy platform, refer to the following sections in this chapter for detailed instructions on how to set up the system for LigaSure™ tissue fusion.

1. Plug the system power cord into the rear panel receptacle.
2. Plug the system power cord into a grounded wall receptacle.

Important

Do not plug the system power cord into a power strip or extension cord.

3. Turn on the system and verify that the power-on self-test has successfully completed.
4. If using a foot pedal, connect it to the LigaSure™ technology/Bipolar foot-pedal receptacle on the rear panel and position it on the floor within reach of the surgeon.

Warning

Connect only foot pedals from the compatibility list beginning on page 1-8. Use of other foot pedals may cause unexpected output to occur and may lead to patient injury.

5. Connect the instrument to the LigaSure™ technology/Bipolar instrument receptacle on the front panel.

LigaSure™ Technology Function Overview

LigaSure™ technology tissue fusion can be used on arteries, veins, and lymphatics, up to and including, 7 mm in diameter and tissue bundles. This system provides precise energy delivery and electrode pressure to tissues for a controlled time period to achieve a complete and permanent fusion of tissues and vessel lumens. The system is designed to produce minimal sticking, charring, or thermal spread to adjacent tissue.

There are no editable parameters in the LigaSure™ technology quadrant.



During instrument activation, the progress wheel in the LigaSure™ technology display control panel illuminates, and a tone sounds for the duration of energy delivery.

Some instruments cause the hand-activation **ON/OFF** switch to appear on the control panel when the instrument is recognized.



Important

If using an instrument that causes the Hand-Activation button to appear on the LigaSure™ technology control panel, see *Hand-Activation ON/OFF Switch* on page 6-9.

LigaSure™ Technology Default Settings

Output or Instrument	Default
LigaSure™ technology	Handswitching—enabled (On)
LF5544 Pistol Grip	<ul style="list-style-type: none"> • MONOPOLAR mode—VALLEYLAB <ul style="list-style-type: none"> – 15 W
LF5637 and LF5644	<ul style="list-style-type: none"> • MONOPOLAR mode—VALLEYLAB • Monopolar power <ul style="list-style-type: none"> – CUT—15 W – VALLEYLAB—15 W – COAG—15 W

LigaSure™ Technology/Bipolar Receptacle

The LigaSure™ technology/Bipolar receptacle is located adjacent to the lower-right quadrant of the screen. This receptacle accepts LigaSure™ technology instruments and can read bar codes or the RFID chip on the LigaSure™ technology connector.

Warning

Electric Shock Hazard

- Do not connect wet instruments to the energy platform.
- Ensure that all instruments and adapters are correctly connected and that no metal is exposed at any connection point.

Connect instruments to the proper receptacle. Improper connection may result in inadvertent instrument activation or other potentially hazardous conditions. Follow the instructions provided with LigaSure™ technology instruments for proper connection and use.

Each instrument receptacle on the energy platform is designed to accept only one instrument at a time. Follow the instructions provided with electrosurgical instruments for proper connection and use.

Precaution

Read the instructions, warnings, and precautions provided with LigaSure™ technology instruments before use. Specific instructions are not included in this manual.

Inspect instruments and cords—especially for laparoscopic/endoscopic instruments—for breaks, cracks, nicks, and other damage before every use. If damaged, do not use. Damaged instruments or cords may result in injury or electrical shock to the patient or surgical team.

Foot Pedal

A single-pedal LigaSure™ technology foot pedal can be used when the energy platform is using the LigaSure™ technology quadrant.

Warning

Connect only foot pedals from the compatibility list beginning on page 1-8. Use of other foot pedals may cause unexpected output to occur and may lead to patient injury.

LigaSure™ Technology Instruments

Reusable-Instrument Assembly

To prepare the reusable LigaSure™ technology instruments for use in a procedure, refer to the following steps for the general preparation. To find detailed directions for each instrument, refer to the individual instrument instructions that accompany the instrument electrode.

1. Slip the base of the disposable electrode's white shaft onto the retaining post on the instrument ring handle.
2. Attach the body of the electrode shaft to the instrument handle. The white shaft of the electrode must be completely flush with the reusable-instrument shaft.
3. Attach each electrode to the appropriate instrument jaw, matching electrode curvature to jaw curvature. Insert the proximal pin first. Verify that there is no gap between the electrode and the instrument jaw.

Important

Bent or broken electrode pins will not function properly and may result in an alert situation. In this case, the electrode must be discarded.

4. Gently ratchet the instrument closed on a folded 4"x 4" gauze pad to ensure the electrodes are properly seated in the instrument jaws.

Connecting LigaSure™ Technology Instruments to the Energy Platform

Connect the LigaSure™ technology instrument's purple connector to the LigaSure™ technology/Bipolar receptacle on the front panel of the Valleylab™ FT10 energy platform. The system detects and sets the appropriate settings.

Other than the handswitching ON/OFF switch, there are no editable settings in the LigaSure™ technology quadrant.

If applicable, refer to the following sections:

- *Hand-Activation ON/OFF Switch* on page 6-9
- *Invalid Instrument* on page 6-9

Connecting Single-Plug LigaSure™ Technology Instruments

There are multiple instrument designs, but the general LigaSure™ technology-instrument connection process is the same for LigaSure™ technology instruments with a single purple LigaSure™ technology connector. For devices that have two plugs and provide both LigaSure™ technology and monopolar functionality, see *Connecting Dual-Plug LigaSure™ Technology Instruments* on page 6-8.

Setup for LigaSure™ Technology Instruments with a Single Connector

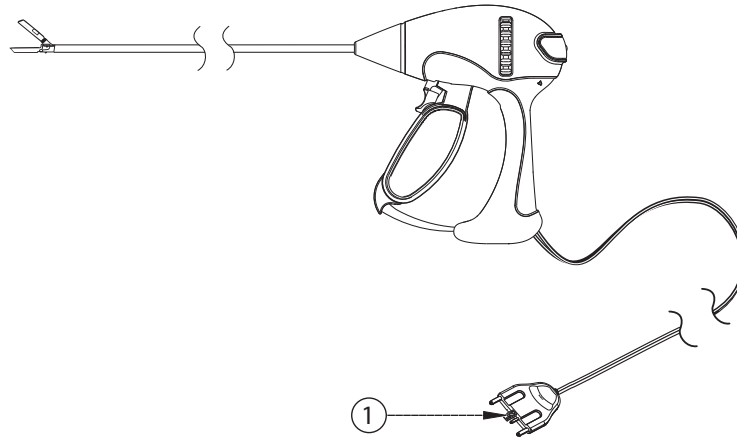

- ① LigaSure™ technology purple connector

Setup

1. With the bar code on the purple connector (1) facing up, firmly insert it into the LigaSure™ technology/Bipolar receptacle (2) on the energy platform front panel.

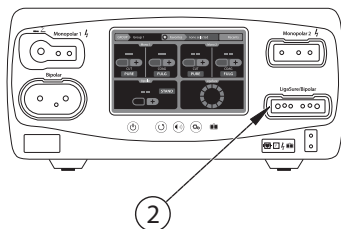

- ② LigaSure™ technology/Bipolar receptacle

2. The energy platform detects the instrument type and selects the intensity setting. The settings cannot be changed.

Connecting Dual-Plug LigaSure™ Technology Instruments

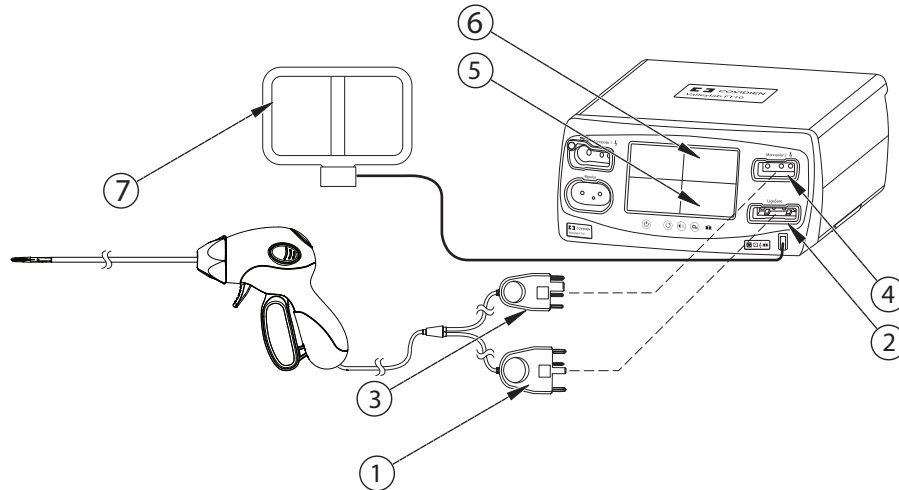

- ① LigaSure™ technology connector (purple)
- ② LigaSure™ technology/Bipolar instrument receptacle
- ③ Monopolar connector (blue)
- ④ Monopolar 2 instrument receptacle
- ⑤ LigaSure™ technology touchscreen quadrant
- ⑥ Monopolar 2 touchscreen quadrant
- ⑦ REM patient return electrode

Setup

1. With the bar code on the purple LigaSure™ technology connector **(1)** facing up, firmly insert it into the LigaSure™ technology/Bipolar receptacle **(2)** next to the LigaSure™ technology touchscreen quadrant **(5)**.
2. With the bar code on the blue monopolar connector **(3)** facing up, firmly insert it into the Monopolar 2 receptacle **(4)** next to the Monopolar 2 quadrant **(6)**.

The energy platform reads the information from the two connectors and sets the power output accordingly:

- LigaSure™ technology – Power output is selected automatically and cannot be changed from the LigaSure™ technology touchscreen.
- Monopolar – Power output is set to the default values and can be edited in the Monopolar 2 quadrant.

Hand-Activation ON/OFF Switch

Some LigaSure™ technology instruments cause the hand-activation icon to appear in the lower right corner of the LigaSure™ technology control panel. The hand-activation switch toggles between the ON and OFF setting.

For example, the LF1212 curved, small jaw, open sealer/divider, is a LigaSure™ technology instrument that can be used with hand-activation on or off. When hand-activation is off, a foot pedal is used to initiate energy delivery.



① Hand activation enabled

In this example, the enabled hand activation appears in the lower-right corner of the LigaSure™ technology quadrant. Touching the **ON/OFF** switch turns off the hand activation, requiring the use of a foot pedal.

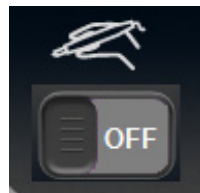

Invalid Instrument

If the Valleylab™ FT10 energy platform does not recognize the attached instrument, a pop-up will display the words "INVALID INSTRUMENT." Refer to the following steps to resolve the issue.

1. Confirm that a LigaSure™ technology instrument is in use.
2. Reconnect the instrument using firm pressure to insert the instrument into the LigaSure™ technology/Bipolar instrument receptacle.
3. If "INVALID INSTRUMENT" continues to appear in the status bar, use a new LigaSure™ technology instrument or electrode.

Activating the LigaSure™ Technology Instrument

1. Fully grasp the target tissue in accordance with the LigaSure™ technology instrument's IFU.
2. Activate the LigaSure™ technology instrument either by pressing and holding the activation button on the instrument or by depressing and holding the foot pedal. During instrument activation, the LigaSure™ technology quadrant of the display illuminates purple and rotates clockwise, and an activation tone sounds for the duration of energy delivery.
3. When the end tone sounds, release the activation button or foot pedal. In the case of an alert condition, refer to the following section.
4. Inspect the vessel or tissue prior to cutting by releasing the tissue from between the instrument jaws.

Alert Situations

A four-pulsed tone will sound when an alert condition occurs, and the LigaSure™ technology quadrant will display an alert message with a list of corrective actions. When an alert condition occurs, energy delivery is interrupted, but is available immediately after correcting the alert condition.

Incomplete Seal Cycle - Interrupted

The seal cycle was interrupted before completion. The handswitch or foot pedal was released before the end tone activated.



If this message appears the user should

1. Release the foot pedal or handswitch button.
2. Open the instrument jaws and inspect for a successful seal.
3. If the seal is incomplete, regrasp the tissue (with the jaws in the same position or overlapping the first seal, if possible).
4. Reactivate the seal cycle.

Incomplete Seal Cycle - Short

The energy platform detected a short circuit between the LigaSure™ technology instrument jaws—possibly due to contact with a metal object or excess fluid around the surgical site.



If this message appears the user should

1. Release the foot pedal or handswitch button.
2. Check for metal clips or staples.
3. Reposition the instrument to avoid contact with metal.
4. Remove excess fluids from the surgical site.
5. Reactivate the seal cycle.

Incomplete Seal Cycle - Open Circuit

The LigaSure™ technology instrument jaws were not fully closed or the grasped tissue was too thin.



If this message appears, the user should

1. Release the foot pedal or activation button.
2. Open the instrument jaws and inspect for a successful seal.
3. If possible, regrasp thicker tissue.
4. Fully close the instrument jaws.
5. Reactivate the seal cycle.

Incomplete Seal Cycle - Time Out

Additional time and energy are needed to complete the seal cycle.



If this message appears, the user should

1. Release the foot pedal or activation button.
2. Open the instrument jaws and inspect for a successful seal.
3. Remove excess fluids from the surgical site.
4. Clean and dry the LigaSure™ technology instrument jaws.
5. Regrasp the tissue.
6. Reactivate the seal cycle.

BiZact™ Function Overview

BiZact™ tissue fusion can be used on arteries, veins, and lymphatics, up to and including 3 mm in diameter and tissue bundles. The BiZact™ instruments connected to the FT10 are controlled in the same manner as LigaSure™ technology instruments. The only difference is that insertion of a BiZact™ instrument will bring up a differently colored display in the LigaSure™ technology quadrant.



① BiZact™ instrument inserted

After Surgery

Disconnect the instruments

1. Turn off the energy platform.
2. Disconnect all instrument cords from the front panel.
 - If the instrument is single-use only (disposable), dispose of it according to the procedures for your institution.
 - If the instrument is reusable, clean and sterilize it according to the manufacturer's instructions for use.
3. Disconnect and store the foot pedals used. For the cleaning procedure, see *Cleaning* on page 10-3.
4. Disconnect the power plug from the wall receptacle by pulling the plug, not the cable.

Chapter 7

Bipolar Resection

This chapter describes how to set up and operate the bipolar resection application on the energy platform.

For information about setting up and using the bipolar resection application, refer to these documents:

- This chapter.
- *ForceTriad™ bipolar resection footswitch instructions for use (FT6009)* - Instructions for the only foot pedal that supports bipolar resection mode.
- *ForceTriad™ bipolar resection cord instructions for use (FT0021S or FT0022W)* - Instructions for the two types of cords supported for use with supported bipolar resection instruments. Also contains a list of supported bipolar resection instruments.

Precaution

Read the instructions, warnings, and precautions provided with this energy platform and associated accessories before using. Specific instructions for electro-surgical instruments are not included in this manual.

Front Panel Bipolar Resection Features

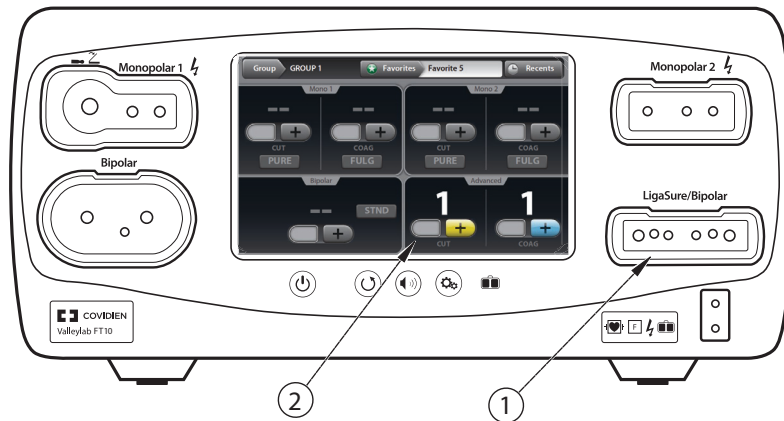

- ① LigaSure™ technology/Bipolar receptacle
- ② Bipolar resection quadrant (appears upon insertion of a bipolar resection cord)

Rear Panel Bipolar Resection Features

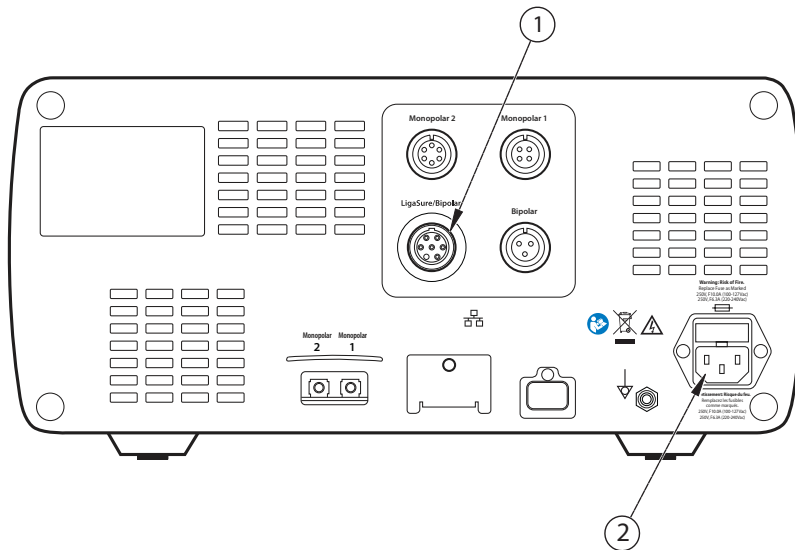

- ① LigaSure™ technology/Bipolar foot-pedal receptacle
- ② Power cord receptacle

Bipolar Resection Quick Setup Instructions

If the user is familiar with the Valleylab™ FT10 energy platform, follow this abbreviated procedure to set up the system for bipolar resection surgery.

If the user is not familiar with the Valleylab™ FT10 energy platform, refer to the following sections in this chapter for detailed instructions on how to set up the system for bipolar resection surgery.

1. Plug the system power cord into the rear panel receptacle.
2. Plug the system power cord into a grounded wall receptacle.

Important

Do not plug the system power cord into a power strip or extension cord.

3. Turn on the system and verify that the power-on self-test successfully completes.
4. Connect the bipolar resection foot pedal to the LigaSure™ technology/Bipolar foot-pedal receptacle on the rear panel, and position it on the floor within reach of the surgeon.

Warning

Connect only foot pedals from the compatibility list beginning on page 1-8. Use of other foot pedals may cause unexpected output to occur and may lead to patient injury.

5. Connect the instrument to the LigaSure™ technology/Bipolar instrument receptacle on the front panel.
6. Verify or change the mode and power settings.

Bipolar Resection Function Overview

Certain urology and gynecology procedures use resection electrodes in a saline environment requiring high Bipolar-power outputs to obtain resection and hemostasis performance.

Bipolar resection function provides two different modes:

- CUT effect for resection, activated by the yellow (left) foot pedal
- COAG effect for desiccation, activated by the blue (right) foot pedal

When a compatible bipolar resection cord is plugged into the LigaSure™ technology/Bipolar receptacle on the front panel, the Bipolar Resection screen appears in the LigaSure™ technology quadrant.



The Bipolar Resection screen has controls for both CUT and COAG modes. The effect setting may be adjusted for either mode from 1 to 6—1 being the minimum effect for the selected mode. During instrument activation, the Bipolar Resection screen illuminates brightly as yellow for CUT and blue for COAG. A tone sounds for the duration of energy delivery.

LigaSure™ Technology/Bipolar Receptacle

The LigaSure™ technology/Bipolar receptacle accepts both LigaSure™ technology and bipolar resection instruments. The connector recognizes the bar code printed on the bipolar resection connector.

Bipolar Resection Default Settings

Output	Default
Bipolar Resection	<ul style="list-style-type: none"> CUT effect—1 COAG effect—1

Warning

Electric Shock Hazard

- Do not connect wet instruments to the energy platform.
- Ensure that all instruments and adapters are correctly connected and that no metal is exposed at any connection point.

Connect instruments to the proper receptacle. Improper connection may result in inadvertent instrument activation or other potentially hazardous conditions. Follow the instructions provided with bipolar resection instruments for proper connection and use.

The instrument receptacles on this system are designed to accept only one instrument at a time.

Precaution

Read the instructions, warnings, and precautions provided with bipolar resection instruments before use. Instrument instructions are not included in this manual.

Inspect instruments and cords—especially for laparoscopic/endoscopic instruments—for breaks, cracks, nicks, and other damage before every use. If damaged, do not use. Damaged instruments or cords may result in injury or electrical shock to the patient or surgical team.

Foot Pedal

The LigaSure™ technology/Bipolar foot-pedal receptacle is located on the rear panel of the energy platform.

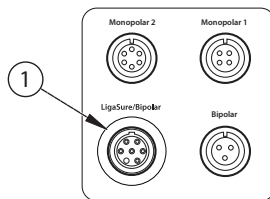

① LigaSure™ technology/Bipolar foot-pedal receptacle

When bipolar resection mode is in use, a single dual-pedal bipolar resection footswitch can be attached to the LigaSure™ technology/Bipolar foot-pedal receptacle using a 1060355 adapter. The foot pedal is used to activate a bipolar resection instrument attached to the LigaSure™ technology/Bipolar receptacle on the front panel.

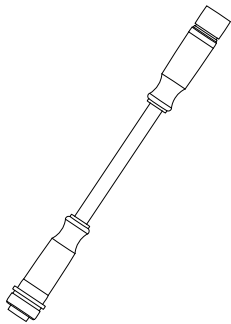
**1060355 adapter**

The purple end of the adapter connects to the energy platform. The orange end of the adapter connects to the foot pedal.

Warning

Connect only foot pedals from the compatibility list beginning on page 1-8. Use of other foot pedals may cause unexpected output to occur and may lead to patient injury.

Connecting Bipolar Resection Instruments to the VLFT10GEN

Warning

Malfunction may be caused by a loose or incorrect connection of the cord to the energy platform or instrument. Worn cords cannot be repaired. Replace cords on a routine basis to maintain optimum functionality and reliability in operating-room use.

Connect accessories to the proper receptacle. Improper connection of accessories may result in potentially hazardous conditions.

Inspect the cord insulation before and after each use for cracks, nicks, cuts, dents, or depressions which may decrease the insulation effectiveness. If the cord is compromised, do not use. Unintended thermal injury could occur.

Precaution

Always disconnect the cord from the instrument or energy platform by gripping the connector. Do not pull on the cord when disconnecting from the instrument and energy platform. Improper disconnection may damage the cord insulation.

1. Plug the system power cord into the rear panel receptacle.
2. Plug the system power cord into a grounded wall receptacle.

Notice

Do not plug the system power cord into a power strip or extension cord.

3. Turn on the system and verify the power-on self-test successfully completes.
4. Connect a bipolar resection cord (FT0021S or FT0022W) to the LigaSure™ technology/ Bipolar receptacle on the front panel.
5. Connect a supported bipolar resection instrument to the bipolar resection cord used in the previous step.
6. Connect the bipolar resection footswitch (FT6009) with adapter (1060355) to the LigaSure™ technology/Bipolar foot-pedal receptacle on the rear panel.
7. Adjust the bipolar resection CUT or COAG effect setting to values between 1 and 6 from the lower-right quadrant of the touchscreen.

Bipolar Resection Settings

Changing the Energy-Delivery Setting

Warning

Confirm proper power or intensity settings before proceeding with surgery.

Touch either the plus or minus buttons to increase or decrease the effect setting by one. The effect setting does not advance from 6 to 1 when touching the plus button or from 1 to 6 when touching the minus button. Instead a warning tone sounds indicating the minimum or maximum effect setting is reached.

Activating a Bipolar Resection Instrument

Supported bipolar resection instruments may be used on the energy platform once the required accessories are connected.

1. Activate the bipolar resection instrument by stepping on and holding the pedal for the desired mode. During instrument activation, the bipolar resection touchscreen controls illuminate brightly.
2. To deactivate the mode and stop energy delivery, release the foot pedal.

Incorrect Foot-Pedal Error

If a warning tone is heard when depressing a foot pedal and no energy is delivered, an incorrect foot pedal may be installed.

To correct this situation, perform the following steps:

1. Confirm that a bipolar resection footswitch with adapter (1060355) is plugged into the LigaSure™ technology/Bipolar foot-pedal receptacle on the rear panel of the energy platform.
2. If there is no foot pedal connected, locate the proper foot pedal and connect it to the LigaSure™ technology/Bipolar foot-pedal receptacle.
3. If there is a foot pedal connected to the LigaSure™ technology/Bipolar foot-pedal receptacle, but it is not a bipolar resection footswitch, disconnect the foot pedal. Locate the proper foot pedal and connect it to the receptacle.

After Surgery

Disconnect the Instruments

1. Turn off the energy platform.
2. Disconnect the bipolar resection cord from the LigaSure™ technology/Bipolar receptacle from the front panel.
3. Disconnect the instrument from the cord.
 - If the instrument is single-use only (disposable), dispose of it according to the procedures for your institution.
 - If the instrument is reusable, clean and sterilize it according to the manufacturer's instructions for use.
 - Clean and sterilize the cord according to the instructions for use.
4. Disconnect and clean the foot pedal. For the cleaning procedure, see *Cleaning* on page 10-3.
5. Disconnect the power plug from the wall receptacle by pulling the plug, not the cable.

Chapter 8

Cardioblate™ Surgical Ablation System

This chapter describes the Cardioblate™ surgical ablation function of the Valleylab™ FT10 energy platform.

Precaution

Read the instructions, warnings, and precautions provided with this energy platform and associated accessories before using. Specific instructions for electro-surgical instruments are not included in this manual.

Front Panel Cardioblate™ Ablation Features

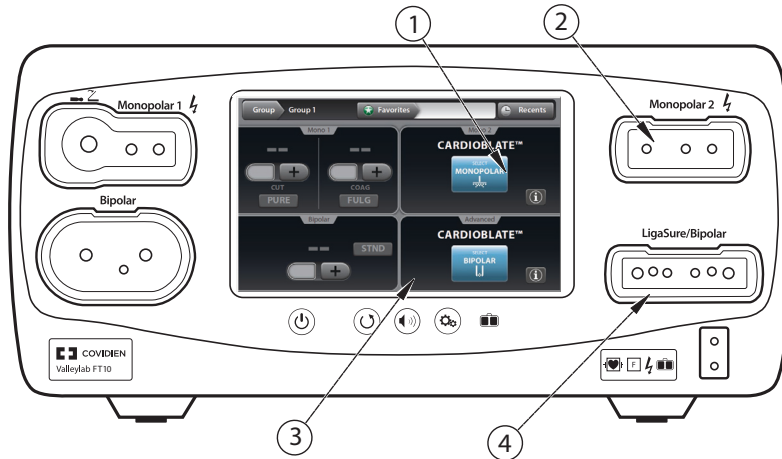

- ① Cardioblate™ monopolar touchscreen quadrant
- ② Monopolar 2 receptacle for Cardioblate™ monopolar pens
- ③ Cardioblate™ bipolar touchscreen quadrant
- ④ LigaSure™ technology/Bipolar receptacle for Cardioblate™ bipolar devices

Rear Panel Cardioblate™ Ablation Features

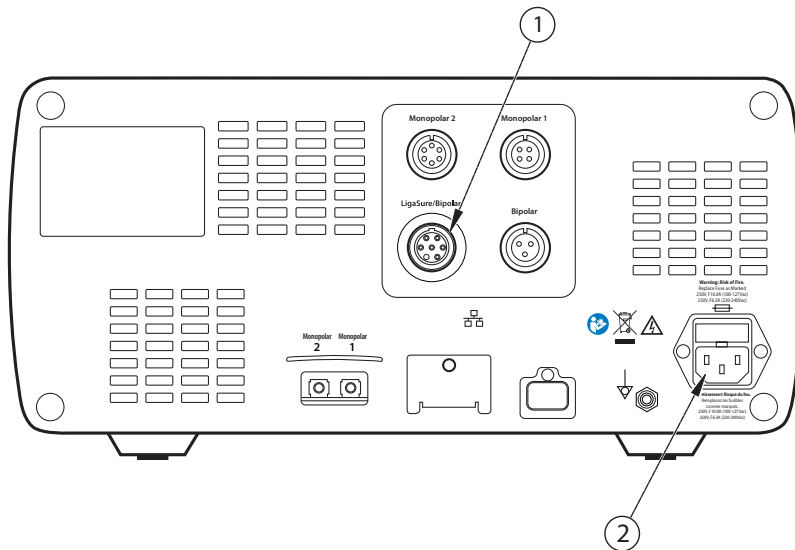

- ① LigaSure™ technology/Bipolar foot-pedal receptacle for Cardioblate™ devices
- ② Power cord receptacle

Cardioblate™ Ablation System Quick Setup Instructions

To find the quick setup aids for the Cardioblate™ system, select the **Settings and Service (Gears)** button on the front panel, then touch the **Cardioblate™ system Help** menu. There is a graphic to assist setup:

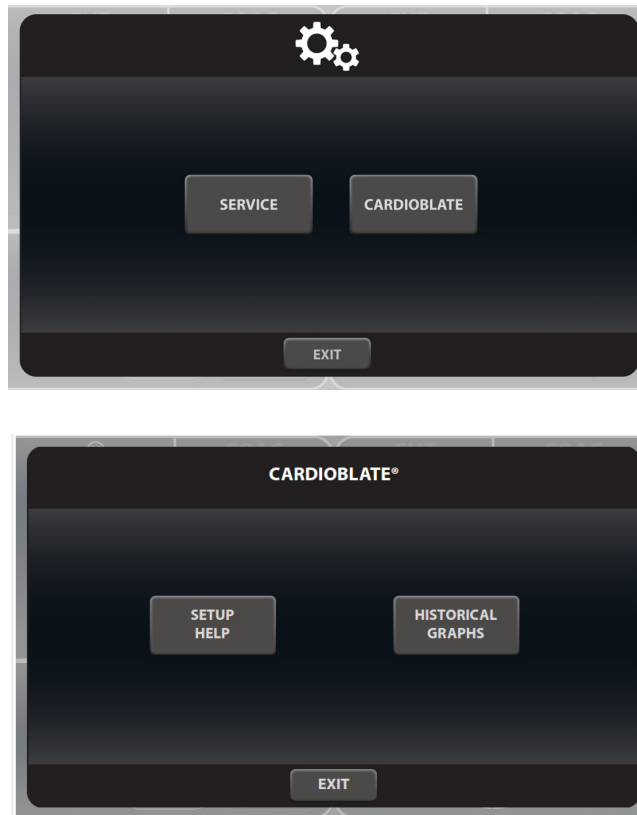

If the user is familiar with the Valleylab™ FT10 energy platform, follow this abbreviated procedure to set up the system for Cardioblate™ ablation surgery.

If the user is not familiar with the Valleylab™ FT10 energy platform, refer to the following sections in this chapter for detailed instructions on how to set up the system for Cardioblate™ surgery.

1. Plug the system power cord into the rear panel receptacle.
2. Plug the system power cord into a grounded wall receptacle.

Important

Do not plug the system power cord into a power strip or extension cord.

3. If using the foot pedal, connect it to the LigaSure™ technology/Bipolar foot-pedal receptacle on the rear panel and position it on the floor within reach of the surgeon.

4. Turn on the system and verify that the power-on self test has successfully completed.

Warning

Connect only foot-pedals from the compatibility list beginning on page 1-8. Use of other foot pedals may cause unexpected output to occur and may lead to patient injury.

5. Connect the bipolar Cardioblate™ device to the LigaSure™ technology/Bipolar instrument receptacle on the front panel. Connect the saline lines.

Optional: Connect the monopolar Cardioblate™ device to the Monopolar 2 receptacle on the front panel.
6. Connect the saline line(s) as described in the Cardioblate™ device instructions for use. Ensure the 1000 mL saline bag is pressurized between 150 – 300 mmHg.

Cardioblate™ Ablation System Function Overview

Cardioblate™ surgical ablation is designed to deliver radiofrequency (RF) energy to selected sites using a Cardioblate™ surgical ablation device (hereafter referred to only as the ablation device). The system provides precise energy delivery in one of the following energy modes:

Monopolar Mode

The Valleylab™ FT10 energy platform monitors and controls the amount of RF energy delivered to the tissue between the ablation device and the dispersive electrode at a power set-point throughout the ablation.

Bipolar Mode

The Valleylab™ FT10 energy platform monitors tissue impedance and adjusts the amount of power delivered to the tissue between the active electrode jaws to create transmural lesions.

Safety Shutdowns

RF energy delivery stops if the manufacturer-programmed impedance or power limits are exceeded. If a warning message appears, refer to Chapter 9, *Troubleshooting* for detailed information.

Note: Cardioblate™ ablation is a feature that is not available on the clinical screen until it has been enabled. This feature can be enabled through Valleylab™ Exchange by a Covidien sales representative.

Cardioblate™ Ablation System Default Settings

Output or Instrument/Device	Default Setting
Monopolar	<ul style="list-style-type: none"> • Monopolar default power - 25 Watts • Monopolar default maximum time - 120 seconds
Bipolar	No user settings

Cardioblate™ Ablation System Receptacles

Monopolar 2 Receptacle

Cardioblate™ ablation system monopolar pens

The Monopolar 2 receptacle is located adjacent to the upper-right quadrant of the screen. This receptacle accepts and identifies monopolar Cardioblate™ devices if the Valleylab™ FT10 energy platform software version is 3.0 or higher.

LigaSure™ Technology/Bipolar Receptacle

Cardioblate™ ablation system bipolar devices

The LigaSure™ technology/Bipolar receptacle is located adjacent to the lower-right quadrant of the screen. This receptacle accepts and identifies bipolar Cardioblate™ devices if the Valleylab™ FT10 energy platform software version is 3.0 or higher.

Warning

Electric Shock Hazard

- Do not connect wet instruments to the energy platform.
- Ensure that all instruments and adapters are correctly connected and that no metal is exposed at any connection point.

Connect instruments to the proper receptacle. Ensure the instrument is properly seated by observing the tactile feedback and listening for the click. An improper connection may result in inadvertent instrument activation or other potentially hazardous conditions. Follow the instructions provided with Cardioblate™ devices for proper connection and use.

Each instrument receptacle on the energy platform is designed to accept only one instrument at a time. Follow the instructions provided with electro-surgical instruments for proper connection and use.

Precaution

Read the instructions, warnings, and precautions provided with the Cardioblade™ ablation instruments before use. Specific instructions are not included in this manual.

Inspect instruments and cords for breaks, cracks, nicks, and other damage before each use, especially those for laparoscopic/endoscopic instruments. If instruments or cords are damaged, do not use. Damaged instruments or cords may result in injury or electrical shock to the patient or surgical team.

Cardioblade™ Ablation System Single Foot Pedal for Monopolar and Bipolar

A single-pedal LigaSure™ technology (purple) foot pedal can be used when the energy platform is using either the Monopolar 2 receptacle or LigaSure™ technology/Bipolar receptacle for the Cardioblade™ system.

- **Monopolar:** The single-pedal LigaSure™ technology (purple) footswitch is active for monopolar Cardioblade™ ablation when the monopolar graphing screen for the Cardioblade™ ablation system is selected and displayed.
- **Bipolar:** The single-pedal LigaSure™ technology (purple) footswitch is active for bipolar Cardioblade™ ablation when the bipolar graphing screen for the Cardioblade™ ablation system is selected and displayed.

Warning

Connect only foot-pedals from the compatibility list beginning on page 1-8. Use of other foot pedals may cause unexpected output to occur and may lead to patient injury.

Cardioblade™ Ablation System Instruments and Devices

Connecting Monopolar Cardioblade™ Devices to the Energy Platform

Connect the Cardioblade™ monopolar device connector to the Monopolar 2 receptacle on the front panel of the Valleylab™ FT10 energy platform. Upon detection of the Cardioblade™ monopolar device, the system sets the power and maximum time to their default settings.

Setup:

1. With the Medtronic logo on the connector facing up, firmly insert the connector of the Cardioblade™ ablation pen into the Monopolar 2 receptacle on the energy platform front

panel. A **Cardioblate™ system Select** button will appear in the upper right-hand quadrant.

2. Select the button to display the Cardioblate™ monopolar graphing full screen display which enables Cardioblate™ monopolar operation. Adjustments to the Cardioblate™ monopolar power setting and maximum time setting may be made on the monopolar graphing full screen display. The **Restore Settings** button on the front panel may be used to restore settings.
3. Connect saline line(s) as described in the Cardioblate™ device instructions for use. Ensure the 1000 mL saline bag is pressurized between 150 – 300 mmHg.

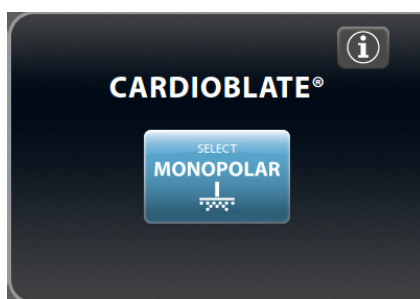

Connecting Bipolar Cardioblate™ Devices to the Energy Platform

Connect the bipolar Cardioblate™ device connector to the LigaSure™ technology/Bipolar receptacle on the front panel of the Valleylab™ FT10 energy platform. The system automatically detects and sets the bipolar delivery default settings. A **Cardioblate™ system Select** button will appear in the lower right-hand quadrant.

Setup:

1. With the Medtronic logo on the connector facing up, firmly insert the connector of the bipolar Cardioblate™ device into the LigaSure™ technology/Bipolar receptacle on the energy platform front panel. The **Cardioblate™ system Select** button will appear in the lower right-hand quadrant.
2. Select the button to display the Cardioblate™ ablation system bipolar graphing full screen display which enables the Cardioblate™ ablation system bipolar operation.
3. Connect the saline line(s) as described in the Cardioblate™ device instructions for use. Ensure the 1000 mL saline bag is pressurized to between 150-300 mmHg.

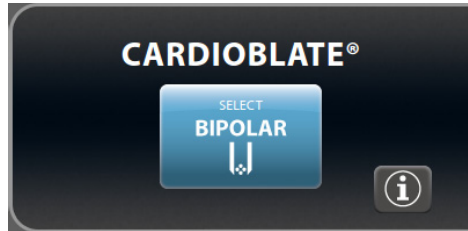

Cardioblate™ Ablation System Monopolar Settings

Changing the Cardioblate™ Ablation System Monopolar Energy-Delivery Setting

Power Setting

Warning

Confirm proper power setting before proceeding with surgery.

Select either the up or down arrows on the power setting to increase or decrease the setting in increments of one watt.

The power setting will not advance from the maximum power setting to the minimum power setting (e.g., 50 to '--') when selecting the up arrow or from the minimum power setting to the maximum power setting (e.g., '--' to 50) when selecting the down arrow. Instead a warning tone sounds indicating the minimum or maximum power setting is reached.

Note that power will not be delivered when the power setting is set at '--'.

Monopolar power settings can be modified during RF activation.

Maximum Time Setting

Select either the up or down arrows on the maximum time setting to increase or decrease the setting in increments of one second.

The time setting will not advance from the maximum time setting to the minimum time setting (e.g., 2:00 to 0:01) when selecting the up arrow or from the minimum time setting to the maximum time setting (e.g., 0:01 to 2:00) when selecting the down arrow. Instead a warning tone sounds indicating the minimum or maximum time setting is reached.

Cardioblate™ Ablation System Bipolar Settings

There are no user settings for Cardioblate™ ablation system bipolar operation.

Switching between Cardioblate™ Ablation System Monopolar and Bipolar Operation

There are two ways to switch between Cardioblate™ ablation system monopolar operation and Cardioblate™ ablation system bipolar operation. This assumes that both a monopolar Cardioblate™ device and a bipolar Cardioblate™ device have been inserted into and identified by the Valleylab™ FT10 energy platform.

When both a monopolar Cardioblate™ device and a bipolar Cardioblate™ device are inserted in the Valleylab™ FT10 energy platform, a toggle switch is displayed in the middle-right section of the respective Cardioblate™ ablation system full screen graphing display. Select the toggle switch to switch between monopolar Cardioblate™ device operation and bipolar Cardioblate™ device operation.

Switching between Cardioblate™ ablation system monopolar and bipolar operation

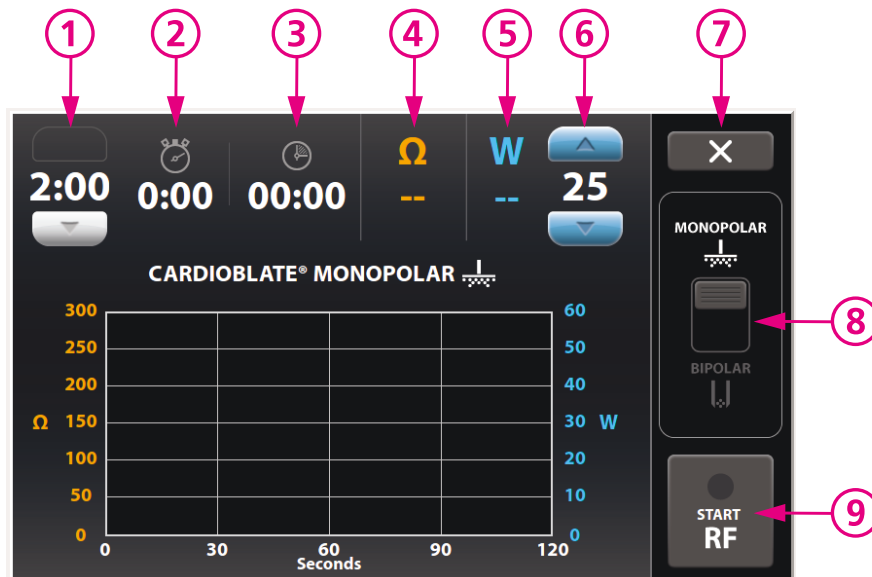

- ① Maximum activation time (mm:ss)
- ② Elapsed activation time (m:ss)
- ③ Cumulated activation time (mm:ss)
- ④ Tissue impedance (Ω)
- ⑤ Power delivered (W)
- ⑥ Power setting (W)

- ⑦ Screen exit
- ⑧ Monopolar/bipolar modality switch
- ⑨ Start/Stop RF

Alternatively, the Cardioblate™ ablation system full screen graphing display may be closed by selecting the “X” button in the upper right-hand corner. The desired Cardioblate™ ablation system modality may then be selected in the quadrant screen. Cumulated activation time is the accumulated RF activation time for all monopolar and bipolar Cardioblate™ ablation system RF activations.

Activating a Cardioblate™ Ablation System Monopolar Pen

Supported Cardioblate™ ablation system monopolar pens may be used on the energy platform with software version 3.0 or greater once the required accessories are connected. There are two ways a Cardioblate™ ablation system monopolar pen may be activated on the Valleylab™ FT10 energy platform.

1. Select the Cardioblate™ ablation system monopolar modality so that the monopolar full graphing screen for the Cardioblate™ ablation system is displayed. Activate the Cardioblate™ ablation system pen by stepping on and holding the single-pedal purple LigaSure™ technology foot pedal while in the Cardioblate™ ablation system screen.
- or
2. Select the Cardioblate™ ablation system monopolar modality so that the monopolar full graphing screen for the Cardioblate™ ablation system is displayed. Activate the Cardioblate™ ablation system pen by selecting the START RF button in the lower right-hand corner of the full screen graphing display.

To deactivate the mode and stop energy delivery, release the foot pedal or select the STOP RF button in the lower right-hand corner of the full screen graphing display.

Activating a Cardioblate™ Ablation System Bipolar Device

Supported Cardioblate™ ablation system bipolar devices may be used on the energy platform with software version 3.0 or greater once the required accessories are connected. There are three ways a Cardioblate™ ablation system bipolar device may be activated on the Valleylab™ FT10 energy platform.

1. Select the Cardioblate™ ablation system bipolar modality so that the bipolar full graphing screen for the Cardioblate™ ablation system is displayed. Activate the Cardioblate™ ablation system bipolar device by stepping on and holding the single-

pedal purple LigaSure™ technology foot pedal while in the Cardioblate™ ablation system bipolar full screen display.

or

2. Select the Cardioblate™ ablation system bipolar modality so that the bipolar full graphing screen for the Cardioblate™ ablation system is displayed. Activate the Cardioblate™ ablation system bipolar device by selecting the START RF button in the lower right-hand corner of the full screen graphing display.

or

3. Select the Cardioblate™ ablation system bipolar modality so that the bipolar full graphing screen for the Cardioblate™ ablation system is displayed. Activate the Cardioblate™ ablation system bipolar device by selecting and holding the handswitch control on the ablation device (if available).

To deactivate the mode and stop energy delivery, release the handswitch or release the foot pedal or select the STOP RF button in the lower right-hand corner of the full screen graphing display.

Transmurality Indicator for Bipolar Lesions

The achievement of a transmural lesion in the bipolar mode is indicated by the energy platform tone changing from a beeping to a steady tone. The green transmural symbol will appear on the screen next to the power output. RF energy will continue until the surgeon stops ablating or the maximum time-out is reached.

A vertical green line will appear on the bipolar graph at the point where transmural is indicated. Power is indicated by a blue line and impedance is indicated by an orange line.

Transmurality indicator for bipolar lesions

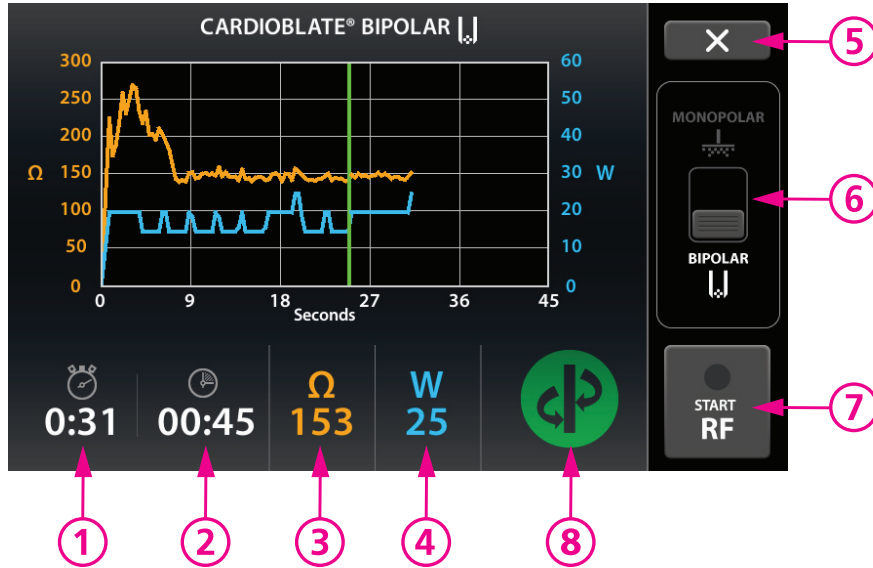

- ① Activation elapsed time (m:ss)
- ② Cumulated activation time (mm:ss)
- ③ Tissue impedance (Ω)
- ④ Power delivered (W)
- ⑤ Screen exit
- ⑥ Monopolar/bipolar modality switch
- ⑦ Start or Stop RF
- ⑧ Transmurality indicator

Alert Situations

A three-pulsed tone will sound when a CardioBlate™ ablation system specific alert condition occurs.

High Impedance Detected

This alert means the RF activation cycle was interrupted before completion. An open circuit or high impedance situation was detected. In the case of monopolar, this alert can happen if the pen is lifted from the tissue.

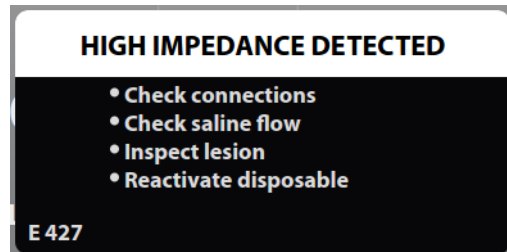

If this message is displayed the user should perform the following steps:

1. Check connections for an open circuit.
2. Check the saline flow.
3. Inspect the lesion.
4. Reactivate the ablation device if desired.

Low Impedance Detected

The RF activation cycle was interrupted before completion. A short circuit or low impedance situation was detected.

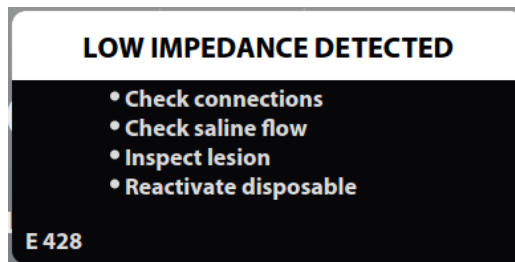

If this message is displayed the user should perform the following steps:

1. Check connections for a short circuit.
2. Check the saline flow.
3. Inspect the lesion.
4. Reactivate the ablation device if desired.

Prolonged Activation

The RF activation cycle was stopped due to the time limit.

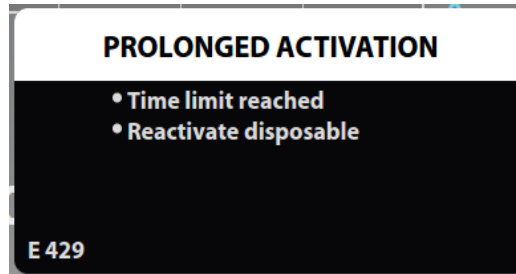

If this message appears the user should reactivate the ablation device if desired.

Return Electrode Over-Temperature

The RF activation cycle was stopped due to the current delivered over time was detected to exceed the nominal expectations for return electrode heating.

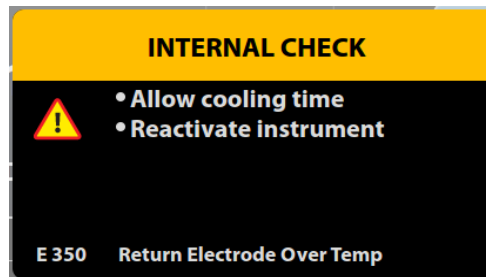

If this message appears the user should allow some return electrode cooling time and then reactivate the ablation device if desired.

Verification Error

The Cardioblate™ ablation system disposable device was unable to communicate with the Valleylab™ FT10 energy platform.

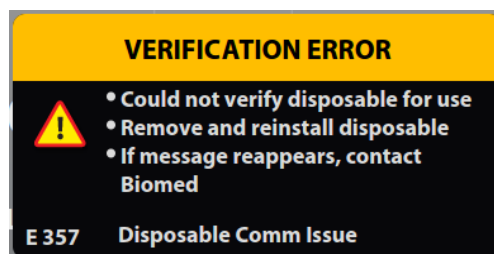

If this message appears the user should remove and re-insert the Cardioblate™ ablation system disposable device into the receptacle.

Cardioblate™ Ablation System Historical Graph Review

To review the graphs of lesions made during surgery, open the **Settings and Service (Gears)** button on the front panel, select the **Cardioblate™ system** button, then select the **Cardioblate™ system Graphs** menu.

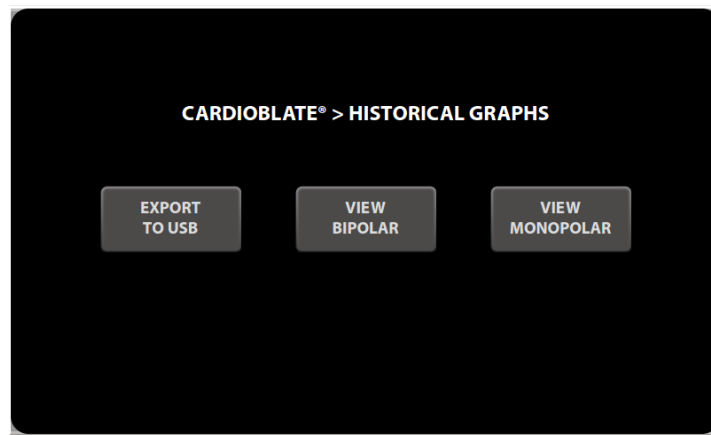

Once **View Bipolar** or **View Monopolar** is selected, historical graphs can be searched for using the left and right control buttons. Up to 200 historical graphs are stored and preserved through power downs in the Valleylab™ FT10 energy platform memory.

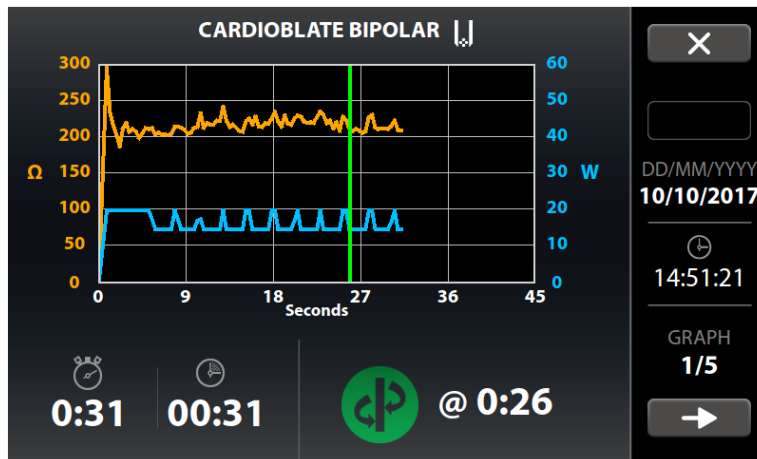

Cardioblate™ Ablation System Historical Graph Data Export

An **Export to USB** button is also available in the Cardioblate™ ablation system Graphs menu. This allows graph data to be exported to a FAT formatted USB stick. The USB receptacle is

behind a cover on the rear panel of the Valleylab™ FT10 energy platform. The data will be exported to a comma separated value (.csv) type file.

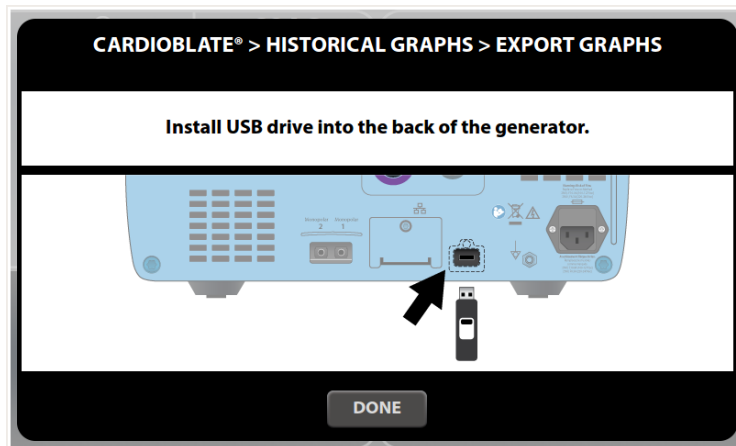

After Surgery

Disconnect the instruments/devices

1. Turn off the energy platform.
2. Disconnect all instrument and device cords from the front panel.
3. Dispose of the used Cardioblade™ devices according to the procedures of your institution.
4. Disconnect and store the foot pedal(s) used. For the cleaning procedure, see *Cleaning* on page 10-3.
5. Disconnect the power plug from the wall receptacle by pulling the plug. Do not pull the cable to disconnect the power plug.

Chapter 9

Troubleshooting

Precaution

Read the instructions, warnings, and precautions provided with this energy platform and associated accessories before using. Specific instructions for electro-surgical instruments are not included in this manual.

General Troubleshooting Guidelines

If the Valleylab™ FT10 energy platform malfunctions, check for obvious conditions that may have caused the problem:

- Check the system for visible signs of physical damage.
- Make sure the fuse drawer is tightly closed.
- Verify that all cords are connected and attached properly.
- If an error code is displayed on the touchscreen, note the code along with all information in the error log and use the information in this chapter to proceed. See *Logs* on page 3-18.
- If the problem is still unclear, turn the Valleylab™ FT10 energy platform off, wait 10 seconds before turning on again.

If the malfunction persists, the system may require service. Contact your institution's biomedical engineering department. Covidien Technical Service contact information is listed on page 10-6.

REM Alarms

If the Valleylab™ FT10 energy platform does not sense the correct impedance for the connected REM Polyhesive™ patient return electrode, monopolar energy is disabled, the REM indicator on the front panel illuminates red, the REM message appears on the touchscreen, and an alarm tone sounds twice. After some time the REM message disappears, the REM symbol appears and remains red, and RF energy remains disabled until the REM alarm is corrected.

When you correct a REM-alarm condition, the system is enabled and the REM-alarm indicator on the front panel illuminates green.

Precaution

Covidien REM Polyhesive™ patient return electrodes are recommended for use with the Valleylab™ FT10 energy platform. Return electrodes from other manufacturers may not provide proper impedance to work correctly with the energy platform.

Notice

Alarm characteristics cannot be changed.

Correcting a REM-Alarm Condition

To correct a REM-alarm condition, follow these steps:

1. Inspect the return-electrode plug and cord. If there is evidence of cracks, breaks, or other visible damage, replace the return electrode and/or the cord.
2. Verify that the patient-return-electrode cord is correctly connected to the energy platform.

3. Verify that there is full contact between the patient and return electrode. Follow the instructions for use provided with the REM Polyhesive™ patient return electrode to ensure proper attachment.
4. If the REM alarm persists, it may be necessary to use more than one patient return electrode. Refer to the troubleshooting flow chart in the REM Polyhesive™ patient return electrode instructions for use for more detail.

Correcting Malfunctions

If a solution is not readily apparent, use the table below to help identify and correct specific malfunctions. After you correct the malfunction, verify that the system completes the self-test as described in Chapter 3, *System Setup*.

Situation	Possible Cause	Solution
Abnormal neuromuscular stimulation (<i>stop surgery immediately</i>).	Metal-to-metal sparking.	Check all connections to the energy platform, patient return electrode, and active electrodes.
	High settings used for the FULGURATE and the SPRAY modes.	Use a lower power setting for the FULGURATE and the SPRAY modes.
	Abnormal 50–60 Hz leakage currents.	Contact your biomedical engineering department or a Covidien technical service representative for assistance.
Energy platform does not respond when turned on.	Disconnected power cord or faulty wall outlet.	Check power cord connections (energy platform and wall outlet). Connect the power cord to a functional outlet.
	Faulty power cord.	Replace the power cord.
	Fuse drawer is open or fuses are blown.	Replace the blown fuse(s). Close the fuse drawer. See Chapter 11, <i>Technical Specifications</i> .
	Internal component malfunction.	Use a backup energy platform. Contact your biomedical engineering department or a Covidien technical service representative for assistance.

Situation	Possible Cause	Solution
System is on, but did not complete the self-test.	Software malfunction.	Turn off the energy platform, then turn on.
	Internal component malfunction.	Note the code along with all information on the error screen and refer to <i>System Errors</i> on page 9-8. Use a backup energy platform. Contact your biomedical engineering department or a Covidien technical service representative for assistance.

Situation	Possible Cause	Solution
Energy platform is on and instrument is activated, but system does not deliver output.	Malfunctioning foot pedal or handswitching instrument.	Turn off the energy platform. Check and correct all instrument connections. Turn on the energy platform. Replace the instrument if it continues to malfunction.
	Power is set too low or turned off.	Increase the power setting.
	An alarm condition exists.	Note the code along with all information on the error screen. Refer to <i>System Errors</i> on page 9-8. In case of a REM alarm, refer to <i>Correcting a REM-Alarm Condition</i> on page 9-2.
	Internal component malfunction.	Contact your biomedical engineering department or a Covidien technical service representative for assistance.
	System does not detect tissue-fusion instrument.	Firmly insert the LigaSure™ technology connector into the appropriate receptacle on the energy platform front panel. Ensure the LigaSure™ technology quadrant indicates that it has detected the instrument.
	System does not detect monopolar instrument.	Firmly insert the monopolar connector into the appropriate receptacle on the energy platform front panel. Ensure the associated monopolar quadrant indicates that it has detected the instrument.
	System does not detect bipolar instrument.	Firmly insert the bipolar connector into the appropriate receptacle on the energy platform front panel. Ensure the Bipolar quadrant indicates that it has detected the instrument.

Situation	Possible Cause	Solution
Continuous monitor interference.	Malfunctioning monitor.	Replace the monitor.
	Faulty chassis-to-ground connections.	<p>Check and correct the chassis ground connections for the monitor and for the energy platform.</p> <p>Check other electrical equipment in the room for defective grounds.</p>
	Electrical equipment is grounded to different objects rather than a common ground. The energy platform may respond to the resulting voltage differences between grounded objects.	Plug all electrical equipment into line power at the same location. Contact your biomedical engineering department or a Covidien technical service representative for assistance.
Interference with other devices only when the energy platform is activated.	Metal-to-metal sparking.	Check all connections to the energy platform, patient return electrode, and instruments.
	High settings used for FULGURATE and SPRAY modes.	Use lower power settings for FULGURATE and SPRAY modes.
	Electrically inconsistent ground wires in the operating room.	Verify that all ground wires are as short as possible and go to the same grounded metal.
	If interference continues when the energy platform is activated, the monitor is responding to radiated frequencies.	<p>Ask your biomedical engineering department to check with the manufacturer of the monitor.</p> <p>Some manufacturers offer RF choke filters for use in monitor leads. The filters reduce interference when the energy platform is activated and minimize the potential for an electrosurgical burn at the site of the monitor electrode.</p>

Situation	Possible Cause	Solution
Pacemaker interference.	Intermittent connections or metal-to-metal sparking.	<p>Check the active and patient return electrode cord connections.</p> <p>It may be necessary to reprogram the pacemaker.</p>
	<p>Current traveling from active to return electrode during monopolar electrosurgery is passing too close to pacemaker.</p>	<p>Consult the pacemaker manufacturer or hospital cardiology department for further information when use of electrosurgical appliances is planned in patients with cardiac pacemakers.</p> <p>Use bipolar instruments, if possible.</p> <p>If you must use a monopolar instrument, place the patient return electrode as close as possible to the surgical site. Make sure the current path from the surgical site to the patient return electrode does not pass through the vicinity of the heart or the site where the pacemaker is implanted.</p> <p>Always monitor patients with pacemakers during surgery and keep a defibrillator available.</p>
Internal Cardiac Defibrillator (ICD) activation.	ICD is activated by energy platform.	Stop the procedure and contact the ICD manufacturer for instructions.
Touchscreen button does not respond to touch.	Touchscreen is out of calibration.	Request biomedical department to perform touchscreen calibration as described in the service manual.
	Touchscreen is broken.	Request biomedical department to replace the touchscreen as described in the service manual.

System Errors

Most system errors require some action on the user's part to correct the condition; however, some are corrected automatically. Use the following list to determine how to correct an error condition.

After correcting the error condition, verify that the system completes the self-test as described in Chapter 3, *System Setup*.

All errors are classified as Information Signals in IEC 60601-1-8, with the exception of E334 (classified as Other Alarm Conditions).

Note: Alarm priorities marked with * signify a high priority if the error is discovered during POST, and medium priority if the error occurs at any time outside of POST.

Error Code

Error Code	Title	Description	Troubleshooting	Alarm Priority
E101	System Error	FPGA Failure	Contact Biomed	High Priority
E102	System Error	CPLD Failure	Contact Biomed	High Priority
E103	System Error	FPGA Failure	Contact Biomed	High Priority
E104	System Error	Boot Sector Failure	Contact Biomed	High Priority
E105	System Error	RAM Test Failure	Contact Biomed	High Priority
E106	System Error	Processor Exception	Contact Biomed	High Priority
E107	System Error	Unexpected Interrupt	Contact Biomed	High Priority
E201	System Error	Storage Failure	Contact Biomed	High Priority
E202	System Error	RTOS Failure	Contact Biomed	High Priority
E203	System Error	OS Failure	Contact Biomed	High Priority
E204	System Error	Assert Error	Contact Biomed	High Priority
E205	System Error	Null Pointer Error	Contact Biomed	High Priority
E206	System Error	Database Error	Contact Biomed	High Priority
E207	System Error	Mem Allocate Error	Contact Biomed	High Priority
E208	System Error	Stack Overflow	Contact Biomed	High Priority
E209	System Error	DMA Failure	Contact Biomed	High Priority
E210	System Error	Thread Limit Error	Contact Biomed	High Priority
E211	System Error	Internal Messaging Error	Contact Biomed	High Priority
E212	System Error	PCBA Failure	Contact Biomed	High Priority

Error Code	Title	Description	Troubleshooting	Alarm Priority
E213	System Error	SR PCBA Failure	Contact Biomed	High Priority
E214	System Error	RF PCBA Failure	Contact Biomed	High Priority
E215	System Error	Software State Error	Contact Biomed	High Priority
E216	System Error	Low Voltage Rail Failure	Contact Biomed	High Priority
E217	System Error	High Voltage Rail Failure	Contact Biomed	High Priority
E218	System Error	Display Driver Error	Contact Biomed	High Priority
E219	System Error	Audio Circuit Failure	Contact Biomed	High Priority
E220	System Error	Multi-tasking Error	Contact Biomed	High Priority
E221	System Error	Processor Timebase Error	Contact Biomed	High Priority
E222	System Error	Processor Timebase Error	Contact Biomed	High Priority
E223	System Error	FPGA Timebase Error	Contact Biomed	High Priority
E224	System Error	System Timebase Error	Contact Biomed	High Priority
E225	System Error	Processor Watchdog Error	Contact Biomed	High Priority
E226	System Error	FPGA Comm Error	Contact Biomed	High Priority
E227	System Error	REM Circuit Failure	Contact Biomed	High Priority
E228	System Error	Relay Feedback Failure	Contact Biomed	High Priority
E229	System Error	Connector Diagnostic Failure	Contact Biomed	High Priority
E230	System Error	Critical Data Failure	Contact Biomed	High Priority
E231	System Error	Security Access Error	Contact Biomed	High Priority
E232	Configuration Mismatch	Invalid System Configuration	Dock to Valleylab™ Exchange	High Priority
E233	Configuration Mismatch	Field Replaceable Unit Updated	Dock to Valleylab™ Exchange	High Priority
E234	System Error	Processor Comm Failure	Contact Biomed	High Priority

Error Code	Title	Description	Troubleshooting	Alarm Priority
E235	REM Pad Contact Quality	None	<ul style="list-style-type: none"> • Connect REM pad • Check connection at patient site • Replace REM pad 	Medium Priority
E236	System Error	Processor Watchdog Error	Contact Biomed	High Priority
E238	System Error	Software Failure	Contact Biomed	High Priority
E239	System Error	Software Failure	Contact Biomed	High Priority
E240	System Error	Thread Check Failure	Contact Biomed	High Priority
E241	System Error	RF Data Error	Contact Biomed	High Priority
E242	System Error	RF Data Timing Error	Contact Biomed	High Priority
E243	System Error	RF Data Delay Error	Contact Biomed	High Priority
E244	System Error	RF Interrupt Error	Contact Biomed	High Priority
E246	System Error	HWC Control Selection Error	Contact Biomed	High Priority
E247	System Error	PS PCBA Failure	Contact Biomed	High Priority
E248	System Error	FP PCBA Failure	Contact Biomed	High Priority
E301	Internal Check	Network Diagnostic Issue	<ul style="list-style-type: none"> • Internal check completed • Press to dismiss • If message reappears, contact Biomed 	High Priority Medium Priority*
E302	Internal Check	Mono 1 Port Comm Issue	<ul style="list-style-type: none"> • Internal check completed • Press to dismiss • If message reappears, contact Biomed 	High Priority Medium Priority*

Error Code	Title	Description	Troubleshooting	Alarm Priority
E303	Internal Check	Mono 2 Port Comm Issue	<ul style="list-style-type: none"> • Internal check completed • Press to dismiss • If message reappears, contact Biomed 	High Priority Medium Priority*
E304	Internal Check	Bipolar Port Comm Issue	<ul style="list-style-type: none"> • Internal check completed • Press to dismiss • If message reappears, contact Biomed 	High Priority Medium Priority*
E305	Internal Check	LigaSure™ technology Port Comm Issue	<ul style="list-style-type: none"> • Internal check completed • Press to dismiss • If message reappears, contact Biomed 	High Priority Medium Priority*
E306	Internal Check	Instrument Scanner Issue	<ul style="list-style-type: none"> • Internal check completed • Press to dismiss • If message reappears, contact Biomed 	Medium Priority
E307	Internal Check	Unsupported Command	Press to dismiss	Medium Priority
E308	Internal Check	Software Timeout Issue	<ul style="list-style-type: none"> • Internal check completed • Press to dismiss • If message reappears, contact Biomed 	Medium Priority

Error Code	Title	Description	Troubleshooting	Alarm Priority
E309	Internal Check	Activation Timing Issue	<ul style="list-style-type: none"> • Internal check completed • Press to dismiss • If message reappears, contact Biomed 	Medium Priority
E310	Touchscreen Error	Unintentional Screen Input	<ul style="list-style-type: none"> • Inspect Touchscreen • If message reappears, contact Biomed 	Medium Priority
E312	Internal Check	Absolute Integrated Error	<ul style="list-style-type: none"> • Internal check completed • Press to dismiss • If message reappears, contact Biomed 	High Priority Medium Priority*
E313	Internal Check	Voltage Sensor Compare Error	<ul style="list-style-type: none"> • Internal check completed • Press to dismiss • If message reappears, contact Biomed 	High Priority Medium Priority*
E314	Internal Check	Current Sensor Compare Error	<ul style="list-style-type: none"> • Internal check completed • Press to dismiss • If message reappears, contact Biomed 	High Priority Medium Priority*
E315	Internal Check	Power Sensor Compare Error	<ul style="list-style-type: none"> • Internal check completed • Press to dismiss • If message reappears, contact Biomed 	High Priority Medium Priority*

Error Code	Title	Description	Troubleshooting	Alarm Priority
E316	Internal Check	Power Compare Error	<ul style="list-style-type: none"> Internal check completed Press to dismiss If message reappears, contact Biomed 	High Priority Medium Priority*
E317	Internal Check	PVI Curve Compare Error	<ul style="list-style-type: none"> Internal check completed Press to dismiss If message reappears, contact Biomed 	High Priority Medium Priority*
E318	Internal Check	Voltage Sensor Clip Error	<ul style="list-style-type: none"> Internal check completed Press to dismiss If message reappears, contact Biomed 	High Priority Medium Priority*
E319	Internal Check	Current Sensor Clip Error	<ul style="list-style-type: none"> Internal check completed Press to dismiss If message reappears, contact Biomed 	High Priority Medium Priority*
E320	Check Instrument	N/A	<ul style="list-style-type: none"> Mono 1 handswitch pressed Release switch Replace instrument 	Medium Priority
E321	Check Foot Pedal	N/A	<ul style="list-style-type: none"> Mono 1 foot pedal pressed Release pedal If issue persists, replace foot pedal 	Medium Priority

Error Code	Title	Description	Troubleshooting	Alarm Priority
E322	Check Instrument	N/A	<ul style="list-style-type: none"> • Mono 2 handswitch pressed • Release switch • If issue persists, replace instrument 	Medium Priority
E323	Check Foot Pedal	N/A	<ul style="list-style-type: none"> • Mono 2 foot pedal pressed • Release pedal • If issue persists, replace foot pedal 	Medium Priority
E324	Check Instrument	N/A	<ul style="list-style-type: none"> • Bipolar handswitch pressed • Release switch • If issue persists, replace instrument 	Medium Priority
E325	Check Foot Pedal	N/A	<ul style="list-style-type: none"> • Bipolar foot pedal pressed • Release pedal • If issue persists, replace foot pedal 	Medium Priority
E326	Check Instrument	N/A	<ul style="list-style-type: none"> • LigaSure™ technology handswitch pressed • Release switch • If issue persists, replace instrument 	Medium Priority

Error Code	Title	Description	Troubleshooting	Alarm Priority
E327	Check Foot Pedal	N/A	<ul style="list-style-type: none"> • LigaSure™ technology foot pedal pressed • Release pedal • If issue persists, replace foot pedal 	Medium Priority
E328	Unintentional Input	Panel Button Error	<ul style="list-style-type: none"> • Release front panel button • If message reappears, contact Biomed 	Medium Priority
E329	Check Foot Pedal	Invalid Foot Pedal Input	<ul style="list-style-type: none"> • Release pedal • If issue persists, replace foot pedal 	Medium Priority
E330	Prolonged Activation	Prolonged Activation	<ul style="list-style-type: none"> • Internal check completed • Press to dismiss or reactivate • If message reappears, contact Biomed 	Medium Priority
E331	Invalid Instrument	Invalid Instrument	Replace Instrument	Medium Priority
E332	System Issue	Chassis Over Temp Detected	Contact Biomed	High Priority Medium Priority*
E333	System Issue	Cooling Fan Failure	Contact Biomed	High Priority Medium Priority*
E334	REM Check Issue	REM Automated Check Error	<ul style="list-style-type: none"> • REM check completed • Press to dismiss or reactivate 	High Priority Medium Priority*
E335	System Issue	Driver Comm Issue	Contact Biomed	Medium Priority

Error Code	Title	Description	Troubleshooting	Alarm Priority
E336	Internal Check	ADC Sync Issue	<ul style="list-style-type: none"> • Internal check completed • Press to dismiss or reactivate • If message reappears, contact Biomed 	High Priority Medium Priority*
E337	Internal Check	Real Time Clock Issue	<ul style="list-style-type: none"> • Internal check completed • Press to dismiss or reactivate • If message reappears, contact Biomed 	High Priority Medium Priority*
E339	Internal Check	RF Control Limit Check Issue	<ul style="list-style-type: none"> • RF Limit Error check completed • Press to dismiss or reactivate • If message reappears, contact Biomed 	Medium Priority
E340	Configuration Mismatch	Invalid Country Code	<ul style="list-style-type: none"> • Energy temporarily disabled • Contact Biomed • Dock to Valleylab™ Exchange 	Medium Priority
E341	Internal Check	Panel Comm Issue	<ul style="list-style-type: none"> • Internal check completed • Press to dismiss • If message reappears, contact Biomed 	High Priority Medium Priority*

Error Code	Title	Description	Troubleshooting	Alarm Priority
E342	Internal Check	Foot Pedal Comm Issue	<ul style="list-style-type: none"> • Internal check completed • Press to dismiss • If message reappears, contact Biomed 	High Priority Medium Priority*
E343	Internal Check	REM Comm Issue	<ul style="list-style-type: none"> • Internal check completed • Press to dismiss • If message reappears, contact Biomed 	High Priority Medium Priority*
E344	Internal Check	REM Comm Issue	<ul style="list-style-type: none"> • Internal check completed • Press to dismiss • If message reappears, contact Biomed 	High Priority Medium Priority*
E345	Internal Check	REM Comm Issue	<ul style="list-style-type: none"> • Internal check completed • Press to dismiss • If message reappears, contact Biomed 	High Priority Medium Priority*
E346	Internal Check	REM Comm Issue	<ul style="list-style-type: none"> • Internal check completed • Press to dismiss • If message reappears, contact Biomed 	High Priority Medium Priority*
E347	Internal Check	REM Data Issue	<ul style="list-style-type: none"> • Internal check completed • Press to dismiss • If message reappears, contact Biomed 	High Priority Medium Priority*

Error Code	Title	Description	Troubleshooting	Alarm Priority
E348	Internal Check	Software Assert Issue	<ul style="list-style-type: none"> • Internal check completed • Press to dismiss • If message reappears, contact Biomed 	Medium Priority
E349	Internal Check	Thread Check Issue	<ul style="list-style-type: none"> • Internal check completed • Press to dismiss • If message reappears, contact Biomed 	Medium Priority
E350	Internal Check	Return Electrode Overtemp	<ul style="list-style-type: none"> • Allow cooling time • Reactivate instrument 	Medium Priority
E351	System Issue	Processor Watchdog Error	<ul style="list-style-type: none"> • Internal check completed • Press to dismiss • If message reappears, contact Biomed 	Medium Priority
E352	Internal Check	Software Update Issue	Contact Biomed	Medium Priority
E353	System Issue	Touchscreen Calibration Reset	Contact Biomed	Medium Priority
E354	Internal Check	SWC Target Variance	<ul style="list-style-type: none"> • Internal check completed • Press to dismiss • If message reappears, contact Biomed 	High Priority Medium Priority*

Error Code	Title	Description	Troubleshooting	Alarm Priority
E355	Invalid Activation	Foot Pedal Not Supported	<ul style="list-style-type: none"> • Press to dismiss • Reactivate instrument • Activation from instrument only 	Medium Priority
E356	System Error	Invalid RF Calibration	Contact Biomed	Medium Priority
E357	Verification Error	Disposable Comm Issue	<ul style="list-style-type: none"> • Could not verify disposable for use • Remove and reinstall disposable • If message reappears, contact Biomed 	Medium Priority
E401	Authorization Issue	Invalid Pairing Code	Press to dismiss	Low Priority
E402	Incomplete Seal Cycle	Hold until complete seal cycle	<ul style="list-style-type: none"> • Inspect seal • Press activation button 	Information Signal
E403	Incomplete Seal Cycle	Reactivate Instrument	<ul style="list-style-type: none"> • Inspect seal • Check for metal clips/staples • Remove excess fluids 	Information Signal
E404	Incomplete Seal Cycle	Reactivate Instrument	<ul style="list-style-type: none"> • Inspect seal • Grasp thicker tissue • Fully close instrument handle 	Information Signal
E405	Incomplete Seal Cycle	Reactivate Instrument	<ul style="list-style-type: none"> • Inspect seal • Remove excess fluids • Clean and dry jaws 	Information Signal

Error Code	Title	Description	Troubleshooting	Alarm Priority
E407	Instrument Not Ready	N/A	<ul style="list-style-type: none"> • Dual modality instrument. • Insert other plug into Mono 2 receptacle. 	Information Signal
E408	Instrument Not Ready	N/A	<ul style="list-style-type: none"> • Dual modality instrument. • Insert other plug into LigaSure™ technology/ Bipolar receptacle. 	Information Signal
E411	Invalid Activation Attempt	N/A	<ul style="list-style-type: none"> • Dual modality instrument. • Both plugs are required. • Insert other plug into LigaSure™ technology/ Bipolar receptacle. 	Medium Priority
E412	Invalid Activation Attempt	N/A	<ul style="list-style-type: none"> • Dual modality instrument. • Both plugs are required. • Insert other plug into Monopolar 2 receptacle. 	Medium Priority
E413	Invalid Combination	N/A	<ul style="list-style-type: none"> • Instrument combination not allowed. • Remove current instrument in LigaSure™ technology/ Bipolar receptacle. 	Medium Priority

Error Code	Title	Description	Troubleshooting	Alarm Priority
E414	Invalid Combination	N/A	<ul style="list-style-type: none"> Instrument combination not allowed. Remove current instrument in Monopolar 2 receptacle. 	Medium Priority
E415	Feature Not Enabled	N/A	<ul style="list-style-type: none"> The feature is not enabled. Contact Covidien to enable this feature. 	Medium Priority
E416	Unknown Instrument	N/A	<ul style="list-style-type: none"> Instrument not recognized. Replace instrument. 	Medium Priority
E419	Incomplete Setup	N/A	<ul style="list-style-type: none"> Separate forceps tips Remove from tissue Remove from fluids 	Information Signal
E420	Usage Limit	N/A	The inserted device has already been used. It has not been recertified by the original manufacturer.	Information Signal
E421	Usage Limit	N/A	The inserted device has already been used. It has not been recertified by the original manufacturer.	Information Signal

Error Code	Title	Description	Troubleshooting	Alarm Priority
E422	Incomplete Setup	N/A	<ul style="list-style-type: none"> • Check cable insertion • Separate forceps tips • Remove from tissue 	Information Signal
E424	Activation Time Exceeded	N/A	<ul style="list-style-type: none"> • Remove from tissue • Separate forceps tips • Remove from fluids 	Information Signal
E425	Contact time Exceeded	N/A	<ul style="list-style-type: none"> • Remove from tissue • Separate forceps tips • Remove from fluids 	Information Signal
E426	Incomplete Setup	N/A	Check cable insertion.	Information Signal
E427	High Impedance Detected	N/A	<ul style="list-style-type: none"> • Check connections • Check saline flow • Inspect lesion • Reactivate disposable 	Information Signal
E428	Low Impedance Detected	N/A	<ul style="list-style-type: none"> • Check connections • Check saline flow • Inspect lesion • Reactivate disposable 	Information Signal

Error Code	Title	Description	Troubleshooting	Alarm Priority
E429	Prolonged Activation	N/A	<ul style="list-style-type: none"> • Time limit reached • Reactivate disposable 	Information Signal
E430	Prolonged Activation	N/A	<ul style="list-style-type: none"> • Irrigate to cool field • Reactivate instrument 	Information Signal
E431	High Impedance Detected	N/A	<ul style="list-style-type: none"> • Check connections • Check saline flow • Check working element • Reactivate instrument 	Information Signal

Chapter 10

Maintenance and Repair

This chapter presents the following information:

- The manufacturer's responsibility
- Routine maintenance and safety checks
- Cleaning the energy platform
- Product service
- Service manual copies and updates
- Returning the energy platform for service
- Software updates
- Covidien Technical Service
- Training and education

Precaution

Read the instructions, warnings, and precautions provided with this energy platform and associated accessories before using. Specific instructions for electrosurgical instruments are not included in this manual.

Responsibility of the Manufacturer

Covidien is responsible for the safety, reliability, and performance of the energy platform only if all of the following conditions have been met:

- Installation and setup procedures in this manual are followed.
- Assembly, operation, readjustments, modifications, or repairs are carried out by persons authorized by Covidien.
- The electrical installation of the relevant room complies with local codes and regulatory requirements, such as IEC and BSI.
- The equipment is used in accordance with the Covidien instructions for use.

For warranty information, refer to the *Limited Warranty* section in this manual.

Routine Maintenance and Periodic Safety Checks

Notice

Refer to the energy platform service manual for maintenance recommendations and function and output-power verification procedures.

When should the energy platform be checked or serviced?

Covidien recommends that the energy platform be inspected by qualified service personnel at least once a year. This inspection should include adjusting the system to factory specifications.

When should the power cord be checked or replaced?

Check the power cord before each use of the system or at the intervals recommended by your institution. Check the power cord for exposed wires, cracks, frayed edges, or a damaged connector. Replace damaged cords.

When should the fuses be replaced?

An internal component malfunction can damage the fuses. The system fuses may need to be replaced if the system fails the power-on self-test or if the system stops functioning, even though it is receiving power from a wall outlet.

Cleaning

Warning

Shock Hazard Before cleaning or servicing the unit, disconnect the power plug from the power outlet in order to completely isolate the energy platform from mains power.

Notice

Do not clean the energy platform with abrasive cleaning or disinfectant compounds, solvents, or other materials that could scratch the panels or damage the energy platform.

Do not spray cleaning fluids directly on the energy platform as damage to the energy platform may occur.

1. Turn off the system and unplug the power cord from the wall outlet.
2. Thoroughly wipe all surfaces of the energy platform and power cord with a damp cloth and mild cleaning solution or disinfectant. The energy platform will withstand the effects of cleaning over time without degrading the enclosure or display quality.

Product Service

Covidien recommends that all Valleylab™ FT10 energy platform systems be returned to the manufacturer for all service requirements or suspected cybersecurity incidents. If any service is required without returning the system to the manufacturer, Covidien recommends that only qualified personnel service the Valleylab™ FT10 energy platform system.

Covidien defines qualified personnel as a person with electrosurgical equipment repair experience, such as biomedical personnel, and/or individuals who have taken official Covidien training courses.

Parts, services, and software updates will be available for the energy platform for seven years after final production. Contact your Covidien sales representative for information on the current level of support.

Returning the Energy Platform for Service

Before returning the energy platform, call a Covidien sales representative for assistance. If the energy platform is to be sent to Covidien, do the following:

1. Obtain a return authorization number.

Call the Covidien Technical Service Center (see page 10-6) to obtain a Return Authorization Number. Have the following information ready before calling:

- Hospital/clinic name/customer number
- Telephone number
- Department/address, city, state, and zip code
- Model number
- Serial number
- Description of the problem
- Type of repair to be done

2. Clean the energy platform.

See the previous section, *Cleaning*.

3. Ship the energy platform.

- a. Attach a tag to the energy platform that includes the return authorization number and the information (hospital, phone number, etc.) listed in step 1.
- b. Be sure the energy platform is completely dry before packing it for shipment. Package it in its original shipping container, if available.
- c. Ship the energy platform, prepaid, to the Covidien Service Center.

Software Updates

Software updates are available directly from Covidien by using the Valleylab™ Exchange Remote Software System application.

Go to <http://www.medtronic.com/covidien/support/valleylab-exchange> to download and install the latest version of the Valleylab™ Exchange application.

Important

The energy platform is protected against software corruption. If the software is corrupted, the energy platform enters a safe state and will need to be rebooted. If the error persists, return the energy platform to a Covidien service center.

Updating Energy Platform Software

Once the Valleylab™ Exchange application has been installed on the computer to be used for the update, follow these brief instructions.

To remotely update software on a Valleylab™ FT10 Energy Platform:

1. Turn on the facility computer that has Valleylab™ Exchange installed. Ensure that this computer is disconnected from the hospital network.
2. Remove cover on back of energy platform to expose the data ports.

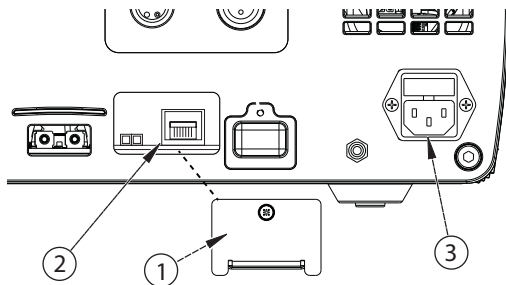

- ① Ethernet receptacle cover
- ② Ethernet receptacle
- ③ Power cord receptacle

3. Connect Ethernet cable to the Ethernet receptacle on the back of the energy platform.
4. Connect the other end of the cable to a LAN connector on the facility computer.
5. Plug the system power cord into the power cord receptacle.
6. Plug the other end of the cord into a grounded power receptacle.
7. Turn on the energy platform by pressing the **On/Off** button and wait for the power-on self-test to complete.
8. Touch the **Service/Settings** button on the front panel of the energy platform to view the *Service and Settings* menu.
9. Touch the **System** button from the menu to view the *System Menu*.
10. Touch **Network**.
11. Select **Enable Network Default Pt. to Pt.**
12. On the facility computer, open the Valleylab™ Exchange application.
13. Start the software update from Valleylab™ Exchange. Valleylab™ Exchange prompts the user to put the energy platform in service mode.
14. Confirm the start of the software upgrade on the energy platform touchscreen. A progress bar on the energy platform will inform the user that the software update is in progress.
15. After the successful completion of the software update, the energy platform will automatically restart.

16. Confirm that the proper software version is installed. The software version number will be displayed on the energy platform while it is booting and can also be viewed in Valleylab™ Exchange and in the service screen of the energy platform.
17. When Valleylab™ Exchange indicates the upgrade is complete, turn off the energy platform by depressing the On/Off button for 3 seconds.
18. Unplug the system power cord from the wall receptacle.
19. Unplug the system power cord from the rear panel receptacle.
20. Disconnect the Ethernet cable from the facility's LAN connector.
21. Disconnect the Ethernet cable from the back of the energy platform.
22. Replace cover on back of energy platform to cover the data ports.

Service Manual Copies and Updates

The latest version of the service manual is available at <https://quickassist.medtronic.com>.

To request a hard copy of the service manual, call the telephone numbers listed in the next section.

Covidien Technical Service

For service, contact Covidien Technical Service or your Valleylab™ FT10 energy platform sales representative. Contact a Covidien technical-service representative by telephone, email, or through the Internet:

- USA and Canada: 1 800 255 8522 Option 2
- International: 1 303 476 7996
- Email— valleylab.technicalservice@covidien.com
- Internet—<http://www.medtronic.com/covidien/support/service-centers>

or

<https://quickassist.medtronic.com>

Training/Education

For clinical professionals and service training options, please refer to the following web sites:

Clinical: <http://www.covidien.com/pace/clinical-education>

QuickAssist™ Product Support: <https://quickassist.medtronic.com>

Chapter 11

Technical Specifications

Precaution

Read the instructions, warnings, and precautions provided with this energy platform and associated accessories before using. Specific instructions for electrosurgical instruments are not included in this manual.

Valleylab™ FT10 Energy Platform Specifications

General

Output configuration	Isolated output
Cooling	Natural convection and fan
Display	7.0 in. (17.8 cm.) LCD touchscreen
Connector receptacles	LED illuminated connector readers on the LigaSure™/Bipolar receptacle
Enclosure	Magnesium
Mounting	<ul style="list-style-type: none"> Valleylab™ universal generator cart (VLFCRT) Operating-room boom systems Any stable, flat surface such as a table or cart top
Operating System	Linux™*

Important

The Valleylab™ FT10 energy platform contains substances of very high concern as defined in Article 57 and Annex XIV of Regulation (EC) No 1907/2006 (Registration, Evaluation, Authorization, and Restriction of Chemicals [REACH]). Specifically, it contains 1,2 dimethoxyethane, ethylene glycol dimethyl ether (EGDME) (CAS number 110-71-4; EC number EN 203-794-9) in concentrations above 0.1% by weight.

Dimensions and Weight

Height	7.0 in. (17.8 cm)
Width	14.5 in. (36.8 cm)
Length	18.2 in. (46.2 cm)
Weight	22.3 lb. (10.1 kg)

Environmental Parameters

	Operation	Transport and Storage ^{1,2}
Ambient temperature range	10 to 40 °C (50 to 104 °F)	-10 to +60 °C (14 to 140 °F)
Relative humidity	15% to 85% non-condensing	15% to 90% non-condensing
Atmospheric pressure	700 to 1060 millibars	500 to 1060 millibars

1. The system can be stored for up to one year without performance degradation upon use.
2. If the energy platform is stored at a temperature outside the normal operating range of 10 to 40 °C, the system is ready for use after at least one hour at ambient temperature 20 °C ± 5 °C.

Input Power

	Nominal Line Voltage		Units
	100–127 VAC	220–240 VAC	
Line Ranges			
Line Voltage Full Regulation Range ³	90–140	198–264	VAC
Line Frequency ²	47–63	47–63	Hz
Max VA nominal line Voltage ¹	950	950	VA
Max Mains Current ¹	9.5	4.8	A _{RMS}
Max Heat Dissipation	180	180	W
Fuses	10	6.3	A
	Fuses (2) – 5 mm x 20 mm 10 A, 250 V fast blow	Fuses (2) – 5 mm x 20 mm 6.3 A, 250 V fast blow	
Power Cord	NEMA 3-prong hospital-grade connector		

1. Max VA and current are based on nominal line voltages.
2. Includes margin on the international range of 50-60 Hz.
3. Includes margin per IEC 60601-1.

Power Cord Specifications

This system is factory equipped with a 110 VAC hospital grade NEMA 5-15 power cord. Should the AC power cord need to be replaced to match another plug configuration, the replacement plug/cable/receptacle configuration must meet or exceed the following specifications:

- **100-127 VAC**

Cable - SJT16/3, IEC color code, maximum length 15 ft. (5 m)

Plug - minimum 10 A - 125 VAC

Unit receptacle - IEC female, minimum 10 A - 125 VAC

- **220-240 VAC**

Cable - H05VVF3G1.0 VDE, maximum length 15 ft. (5 m)

Plug - minimum 6 A - 250 VAC

Unit receptacle - IEC female, minimum 6 A - 250 VAC

Important

Contact your local Covidien representative for alternative internationally approved power-cord options.

Backup Power

The energy platform retains all user programmed features, calibration, and statistical data when switched off and unplugged. The energy platform operates within specification when switched over to a supplied-line power by hospital backup systems.

Real time clock battery	Battery type – Lithium CR1620 or CR1632
	Battery life – 75 mAh minimum

Equipotential Ground Connection

An equipotential ground connection is provided to allow connection of the energy platform to a common ground by way of a potential equalization connector. This connection meets IEC 60601-1 requirements.

EKG Blanking and Smoke Evacuation

Interlink cable receptacles are provided to signal other devices, such as an EKG or smoke evacuator, that the energy platform is active. The receptacle is a 2.5 mm mono jack. It is electrically isolated from the internal ground referenced electronics. The shell is electrically isolated from chassis ground.

Internal Memory

Storage capacity	8 GB
-------------------------	------

Duty Cycle

The Valleylab™ FT10 energy platform is capable of operating a duty cycle of 25%, defined as 10 seconds active and 30 seconds inactive, in any mode for a period of four hours.

Precaution

Use of duty cycles greater than 25% (10 seconds active followed by 30 seconds inactive) will increase the risk that heat build-up under a return electrode may be high enough to injure the patient. Do not continuously activate for longer than one minute.

Leakage

Leakage Currents and Patient Auxiliary Currents (IEC 60601-1:2012)

Touch Current	< 100 μ A NC, < 500 μ A SFC
Earth Leakage Current	< 500 μ A NC, < 1000 μ A SFC
Patient Auxiliary Current (< 1kHz)	< 10 μ A NC, < 50 μ A SFC
Patient Auxiliary Current (> 1kHz)	Scaled with frequency per IEC 60601-1:2012, but does not exceed 10mA NC/SFC
Patient Leakage Current	< 10 μ A NC, < 50 μ A SFC
Total Patient Leakage Current	< 50 μ A NC, < 100 μ A SFC

NC—Normal Condition

SFC—Single Fault Condition (as defined in IEC 60601-1:2012)

Total Patient Leakage Current—Measurement of patient leakage current with all patient outputs connected together

High Frequency Leakage (IEC 60601-2-2)

Bipolar (short leads)	< 68.9 mA _{RMS}
Monopolar measured directly at the ESU terminals	< 100 mA _{RMS}
LigaSure™/BPR measured directly at the ESU terminals	< 100 mA _{RMS}

Radio Frequency Identification (RFID)

The RFID module is located above the LigaSure™ technology/Bipolar receptacle. The intended use of the RFID module is to identify the inserted instrument, configure the energy platform with the data included in the RFID tag, and write data to the RFID tag.

Transmit/Receive Frequency Range	13.56MHz
RF Output Power	-28.0dBμA/m at 10 meter
Type of Antenna	Integral Loop Antenna
Modulation	Amplitude-shift keying (ASK)
Mode of Operation (Simplex / Duplex)	Duplex

FCC Statement

This device complies with part 15 of the FCC Rules. Operation is subject to the following two conditions:

- 1) This device may not cause harmful interference, and
- 2) this device must accept any interference received, including interference that may cause undesired operation.

Changes or modifications to this equipment not expressly approved by the manufacturer may void the user's authority to operate this equipment.

Contains FCC ID: 2AAVI-JDK1901

IFETEL Radio Standards Warning Statement

The operation of radios within this equipment is subject to the following two conditions:

- 1) They shall not cause harmful interference, and
- 2) They must accept any interference received, including interference that may cause undesired operation.

Industry Canada Statement

This device complies with Innovation, Science and Economic Development Canada's licence-exempt RSS(s). Operation is subject to the following two conditions:

- 1) This device may not cause interference.
- 2) This device must accept any interference, including interference that may cause undesired operation of the device.

Contains IC ID: 11355A-JDK1901

RF Exposure Statement

This device meets the requirements for RF exposure when operated at a minimum distance of 20 cm from the user or nearby persons.

European Conformity

This product operates at 13.56 MHz with an H-field strength of -28.0dB μ A/m at 10 m. Hereby, Covidien declares that this Radio Equipment Valleylab™ product is in compliance with Directive 2014/ 53/EU. The full text of the EU declaration of conformity is available at the following internet address: www.MedtronicCompliance.eu

Ethernet

The Ethernet connection is located on the back of the energy platform. The intended use of the bi-directional Ethernet connection is to perform service operations on the energy platform.

Connected Speed	10/100/1000Base-T
Standards	IEEE 802.3, IPv4
Protocols	SFTP (for file transfer through port 22), UDP (non-file transfer), TCP/IP

USB

The USB connection is located on the back of the energy platform. The intended use of the USB port is to perform service operations on the energy platform (bi-directional communications) and to export Cardioblate™ graph information.

Monopolar 2 Communication

The Monopolar 2 communication is located in the Monopolar 2 port. The intended use of the Monopolar 2 communication is to read data from and write data to an inserted instrument.

Symbols Used



For prescription use only

Symbols Used



Consult instructions for use



Follow instructions for use (blue)



Caution: Consult accompanying documents



The energy platform output is floating (isolated) with respect to ground.



Defibrillation proof



DANGER

Explosion risk if used with flammable anesthetics



To reduce the risk of electric shock, do not remove the cover. Refer servicing to qualified service personnel.



- 1) Unit produces non-ionizing radiation
- 2) Unit includes RFID



Classified with respect to electrical shock, fire, and mechanical hazards only in accordance with AAMI ES standard 60601-1; certified to CSA standard C22.2 60601-1:2008.

IP21

Liquid Ingress/Spillage Classification



On/Off



Restore Settings



Audio Volume



Service/Settings



High voltage



REM patient return electrode



Monopolar 1 Universal Foot Pedal Port (UFP)

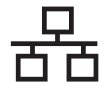

Ethernet



Fuse



Foot pedal



Volume adjustment for activation tones

Symbols Used



Equipotential grounding point



Equipment should not be disposed in trash



Cumulative time (clock face) - Cardioblate™ system



Elapsed time (stop watch) - Cardioblate™ system



Transmurality (green) - Cardioblate™ system



Cancel button



Options button

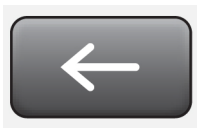

Back button



Confirm button



Keyboard language selection button



Delete icon



Favorites icon



Recents icon

Standards and IEC Classifications

The Valleylab™ FT10 energy platform meets all pertinent clauses of the IEC 60601-1 editions 2.0 and 3.1, IEC 60601-2-2 editions 4.0, 5.0, and 6.0, IEC 60601-1-2 editions 2.1 and 3.0 and 4.0, and IEC 60601-1-8 edition 2.1.

Class I Equipment (IEC 60601-1)

Accessible conductive parts cannot become live in the event of a basic insulation failure because of the way in which they are connected to the protective earth conductor.

Type CF Equipment/Defibrillator Proof (IEC 60601-1, IEC 60601-2-2, and ANSI/AAMI HF18)



This energy platform provides a high degree of protection against electric shock, particularly regarding allowable leakage currents. It is type CF isolated (floating) output and may be used for procedures involving the heart.

IP21 Liquid Ingress/Spillage (IEC 60601-1 and IEC 60601-2-2)

The energy platform is constructed so that liquid spillage in normal use does not wet electrical insulation or other components which when wetted are likely to adversely affect the safety of the equipment.

Voltage Transients – Energy Platform Mains Transfer (IEC 60601-1, IEC 60601-2-2, and ANSI/AAMI HF18)

The energy platform continues to operate normally with no errors or system failures when transfer is made between line AC and an emergency system-voltage source. The system may momentarily shut down in a safe mode depending on the switchover time.

CISPR 11 Class A

The emissions characteristics of this equipment make it suitable for use in industrial areas and hospitals (CISPR 11 class A). If it is used in a residential environment (for which CISPR 11 class B is normally required), this equipment may not offer adequate protection to radio-frequency communication services. The user may need to take mitigation measures, such as relocating or re-orienting the equipment.

Electromagnetic Compatibility (IEC 60601-1-2 and IEC 60601-2-2)

The energy platform complies with the appropriate IEC 60601-1-2 and 60601-2-2 specifications regarding electromagnetic compatibility.

Notice

The Valleylab™ FT10 energy platform requires special precautions regarding EMC and needs to be installed and put into service according to the EMC information provided in the Valleylab™ FT10 energy platform service manual.

Portable and mobile RF communications equipment can affect the Valleylab™ FT10 energy platform. Refer to the EMC information provided in the Valleylab™ FT10 energy platform service manual.

The system should not be used adjacent to or stacked with equipment other than specified in the Valleylab™ FT10 energy platform user's guide and the service manual. If adjacent or stacked use is necessary, the system should be observed to verify normal operation in the configuration in which it will be used.

The system intentionally applies RF energy for diagnosis or treatment during activation. Observe other electronic medical equipment in the vicinity during the system activation for any possible adverse electromagnetic effects. Ensure adequate separation of electronic medical equipment based on observed reactions.

Notice

The use of accessories, other than specified in the Valleylab™ FT10 energy platform user's guide and the service manual, may result in increased emissions or decreased immunity of the system.

Return Electrode Monitor (REM)

REM Specification	
Interrogation Frequency	64–76 kHz
Interrogation Current	< 100 μ A
Contact Resistance Sense Range	5 Ω to 135 Ω
Contact Resistance Accuracy (RF not activated)	\pm 7 Ω
Contact Resistance Accuracy (RF Activated)	Greater of \pm 14 Ω or 20%

REM Alarm Activation

REM patient return electrode: When the measured resistance exceeds the standard range of safe resistance (below 5 ohms or above 135 ohms) or when the measured contact resistance increases by 40% over the baseline, the REM alarm is activated and RF output is disabled.

Auto Bipolar

The Valleylab™ FT10 energy platform is equipped with an Auto Bipolar feature that allows for automatic activation of bipolar energy.

Warning

Use of different Covidien cord models or cords from other manufacturers may not achieve proper electrical output for this device, thereby failing to produce the desired clinical effect. For example, Auto Bipolar activation/deactivation settings may not work properly using cords other than those specified by Covidien.

In the Auto Bipolar setting, activation may occur with contact of any material. When not in use, place electro-surgical instruments in a safety holster or safely away from patients, the surgical team, and flammable materials

Auto Bipolar Specifications

Interrogation Frequency	434 kHz \pm 10%
Interrogation Current	< 10 μ A _{RMS} averaged over 1 second
Activation Impedance	\leq 2200 Ω \pm 20%
Deactivation Impedance	> 4000 Ω \pm 25%
Keying Delay	User selectable in 0.5 second increments from 0 sec. to 2.5 sec.
Minimum Power	1 W

Audio Tones

Activation Tones

Activation Tones	Tone	Duration	Volume
CUT	660 Hz \pm 5%	Entire activation duration	
COAG	940 Hz \pm 5%	Entire activation duration	
SHARED COAG	988 Hz \pm 5%	Entire activation duration	
Valleylab	800 Hz \pm 5%	Entire activation duration	
Bipolar	940 Hz \pm 5%	Entire activation duration	
LigaSure™	440 Hz \pm 5%	Entire activation duration	
Cardioblate™ monopolar	1200 Hz \pm 5%	350 msec tones separated by 650 msec of silence	User adjustable from 45 dBA to 65 dBA (-0/+6 dBA @ 1 m)
Cardioblate™ ablation bipolar before transmural	1200 Hz \pm 5%	Two 160 msec tones separated by 70-200 msec of silence. Two-tone sequence occurs once per second	
Cardioblate™ ablation bipolar after transmural	1130 Hz \pm 5%	Continuous tone	

Alarm Tones

Alarm Tones	Tone(s)	Duration	Volume
REM	660 Hz \pm 5%	Two 500 msec tones separated by 500 msec of silence	65 dBA (-0/+6 dBA @ 1 m)
Incomplete Seal Cycle (Regrasp/Reactivate)	High 784 Hz \pm 5% Low 587 Hz \pm 5%	Four 175 msec tones (high, low, high, low)	
Seal Cycle Complete	988 Hz \pm 5%	Two 175 msec tones separated by 175 msec of silence	
High System Alarm	Simultaneously play the following tones: 784 Hz \pm 5% 1568Hz \pm 5% 2352 Hz \pm 5% 3136 Hz \pm 5%	Ten 138 msec tones separated by 88, 88, 312, 88, 825, 88, 88, 312, and 88 msec of silence	
Medium System Alarm	Simultaneously play the following tones: 784 Hz \pm 5% 1568Hz \pm 5% 2352 Hz \pm 5% 3136 Hz \pm 5%	Three 188 msec tones separated by 188 msec of silence	
Low System Alarm	Simultaneously play the following tones: 784 Hz \pm 5% 1568Hz \pm 5% 2352 Hz \pm 5% 3136 Hz \pm 5%	One 188 msec tone	

Alert Tones

Alert Tones	Tone(s)	Duration	Volume
Informational Alert	Simultaneously play the following tones: 784 Hz \pm 5% 1568Hz \pm 5% 2352 Hz \pm 5% 3136 Hz \pm 5%	One 188 msec tone	User adjustable from 45 dBA to 65 dBA (-0/+6 dBA @ 1 m)
Cardioblate™ ablation Informational Alert	1300 Hz \pm 5%	Three 80 msec tones separated by 120 msec of silence	User adjustable from 45 dBA to 65 dBA (-0/+6 dBA @ 1 m)

Notice

Alarm characteristics cannot be changed.

Alarm response time is less than one second.

Displayed Time Accuracy

Activation elapsed time: The greater of $\pm 1\%$ or ± 1 second.

Cumulated activation time: The greater of $\pm 1\%$ or ± 1 second.

Energy Output Characteristics

The Valleylab™ FT10 energy platform automatically senses the tissue resistance and adjusts the output voltage to maintain a consistent effect across different tissue density. The adjustment is based on the selected mode or effect, power setting, and the level of tissue resistance. The maximum output voltage is controlled to reduce capacitive coupling and video interference and to minimize undesired sparking. The following table outlines the rated power, peak voltage, and current nominal maximum for a given modality. The peak voltage includes tolerance and identifies the maximum value across all loading conditions. Output power can vary $\pm 15\%$. Current nominal maximum does not include tolerance.

	Rated Load (Ω)	Rated Output Power (W)	Max Peak Voltage (V) ¹	Current Nominal Max (A)	Typical Crest Factor ²	Duty Cycle
Monopolar CUT						
PURE	300	300	1287	1.25	1.6	100%
BLEND	300	200	2178	1.0	2.2	50%
Valleylab						
VALLEYLAB	300	200	2783	1.0	3.2	25%
Monopolar COAG						
SOFT	100	120	264	1.55	1.5	100%
FULGURATE	500	120	3448	1.0	5.4	6.25%
SHARED FULGURATE	500 ³	120	3448	1.0	5.4	6.25%
SPRAY	500	120	3932	1.0	6.2	4.76%
SHARED SPRAY	500 ³	120	3932	1.0	6.2	4.76%
Bipolar						
PRECISE (0.5–70 W)	100	70	184	1.0	1.8	100%
STANDARD (1–70 W)	100	70	415	1.78	1.8	100%
MACRO (1–70 W)	100	70	530	2.0	1.7	100%
LigaSure™ technology						
LIGASURE	20	350	244	5.5	1.9	100%
Bipolar Resection						
CUT	200	300	849	4.5	1.45	100%
COAG	100	175	318	3.2	1.6	100%
Cardioblate™ monopolar device						
Cardioblate™ monopolar device	100	100	382	1.41	1.6	100%
Cardioblate™ bipolar device						
Cardioblate™ bipolar device	100	100	382	1.41	1.6	100%

1. Per IEC 60601-2-2: 2009 clause 201.7.9.2.2.101(c)(2), whenever the peak voltage is greater than 1600 V, the calculated variable y is less than the actual crest factor. The peak voltage at rated load can be calculated using the equation:

$$V_{\text{peak}}(U_{\text{max}}) = \text{TypicalCrestFactor} \sqrt{\text{Power} \cdot \text{RatedLoad}}$$

2. At rated load.

3. Rated load in SHARED COAG modes is the total energy channel load. For SHARED dual activation using two activating instruments, it is the parallel combination of the two loads. For SHARED single activation using one activating instrument, it is the load connected to the activating electrode only.

Output Waveforms

TissueFect™ Technology, an automatic adjustment, controls all modes and effects. As tissue resistance increases from zero, the energy platform outputs constant current, followed by constant power, followed by constant voltage. The maximum output voltage is controlled to reduce capacitive coupling and video interference and to minimize sparking.

Bipolar

PRECISE	434 kHz \pm 10% continuous sinusoid
STANDARD	434 kHz \pm 10% continuous sinusoid
MACRO	434 kHz \pm 10% continuous sinusoid

Monopolar CUT

CUT	434 kHz \pm 10% continuous sinusoid
BLEND	434 kHz \pm 10% bursts of sinusoid, recurring at 27.7 kHz \pm 10% intervals
	50% duty cycle

VALLEYLAB

VALLEYLAB	434 kHz \pm 10% bursts of sinusoid, recurring at 27.7 kHz \pm 10% intervals
	25% duty cycle

Monopolar COAG

SOFT	434 kHz \pm 10% continuous sinusoid
FULGURATE	434 kHz \pm 10% damped sinusoidal bursts with a repetition frequency of 27.7 kHz \pm 10%
	6.25% duty cycle
SHARED FULGURATE	434 kHz \pm 10% damped sinusoidal bursts with a repetition frequency of 27.7 kHz \pm 10%
	6.25% duty cycle
SPRAY	434 kHz \pm 10% damped sinusoidal bursts with a repetition frequency of 21.1 kHz \pm 10%
	4.76% duty cycle
SHARED SPRAY	434 kHz \pm 10% damped sinusoidal bursts with a repetition frequency of 21.1 kHz \pm 10%
	4.76% duty cycle

LigaSure™ Technology

LigaSure™ technology	434 kHz \pm 10% continuous sinusoid
-----------------------------	---------------------------------------

Bipolar Resection

BIPOLAR RESECTION	434 kHz \pm 10% continuous sinusoid
--------------------------	---------------------------------------

Cardioblate™ System

Monopolar Cardioblate™ device	434 kHz \pm 10% continuous sinusoid
Bipolar Cardioblate™ device	434 kHz \pm 10% continuous sinusoid

Output Power vs. Resistance Graphs

For the values stated in the graphs provided in this section:

- Output power at rated load is within the greater of 15% or 8 W.
- Peak voltage includes tolerances.
- The energy platform measures resistance within the greater of 15% or 5 Ω .
- Output power is measured using compatible instruments, not test leads.

Monopolar Graphs

PURE CUT

Output power versus resistance for Pure CUT mode

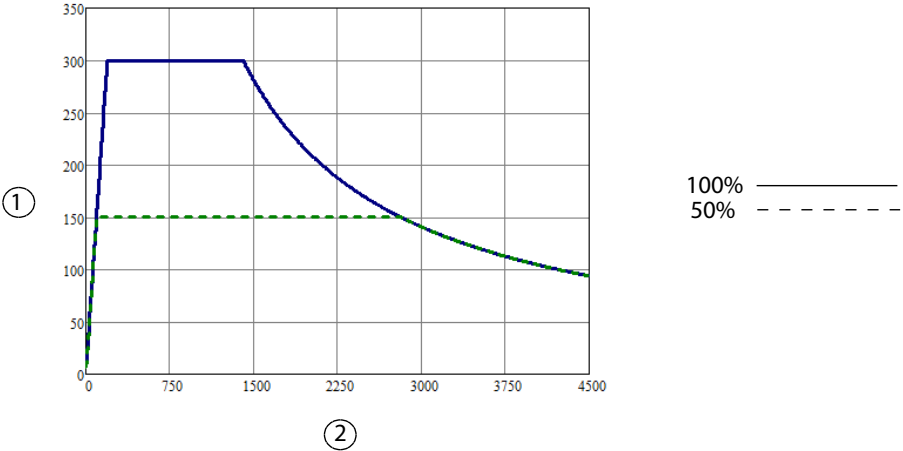

- ① Output power (watts)
- ② Load resistance (ohms)

Output Power vs. Resistance Graphs

Output power versus power setting for Pure CUT mode

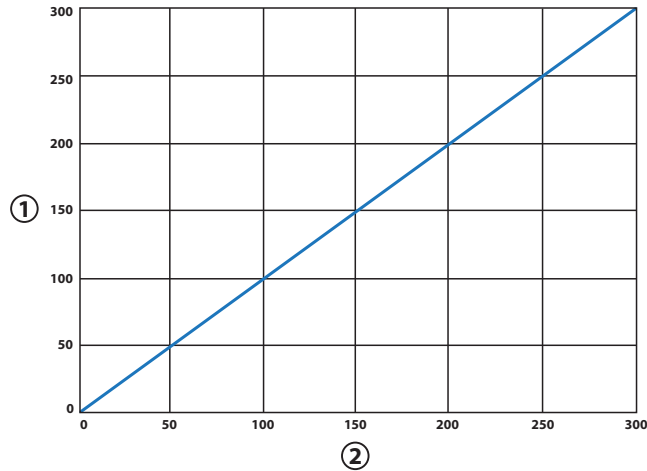

① Output power (watts)

② Power setting

Note: Rated load

Peak voltage versus power setting for Pure CUT mode

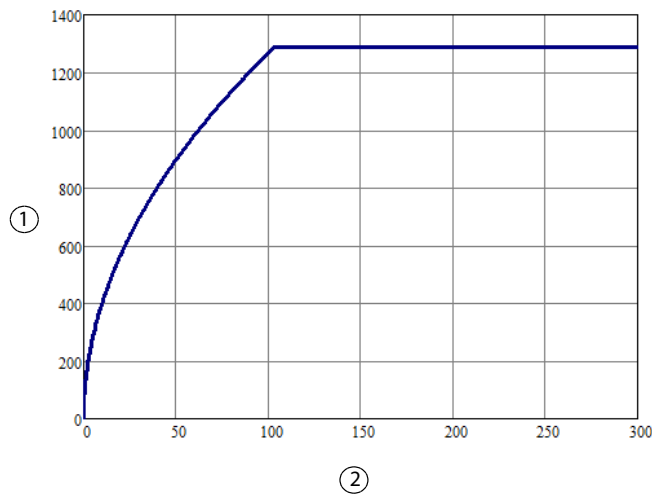

① Peak voltage (volts)

② Power setting

Note: Open circuit

BLEND

Output power versus resistance for BLEND mode

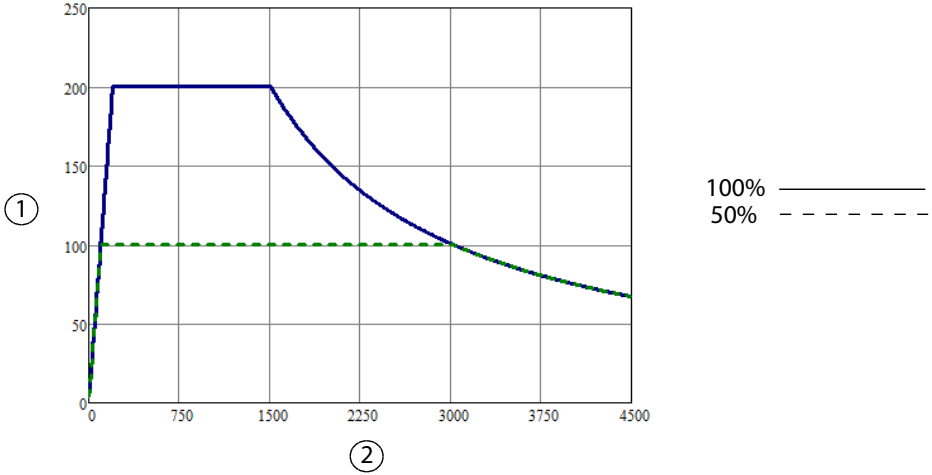

- ① Output power (watts)
- ② Load resistance (ohms)

Output power versus power setting for BLEND mode

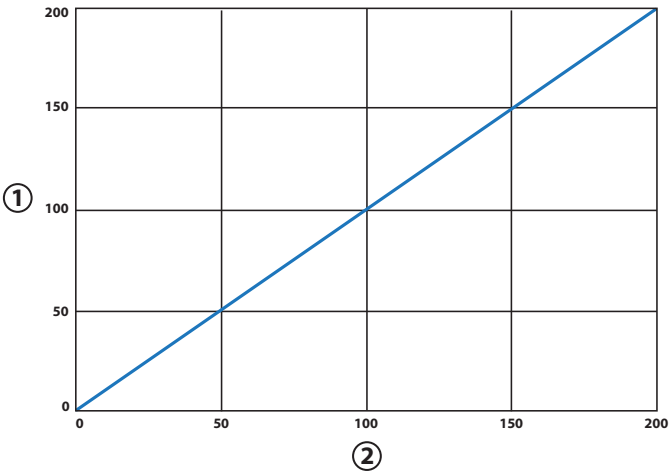

- ① Output power (watts)
- ② Power setting

Note: Rated load

Output Power vs. Resistance Graphs

Peak voltage versus power setting for BLEND mode

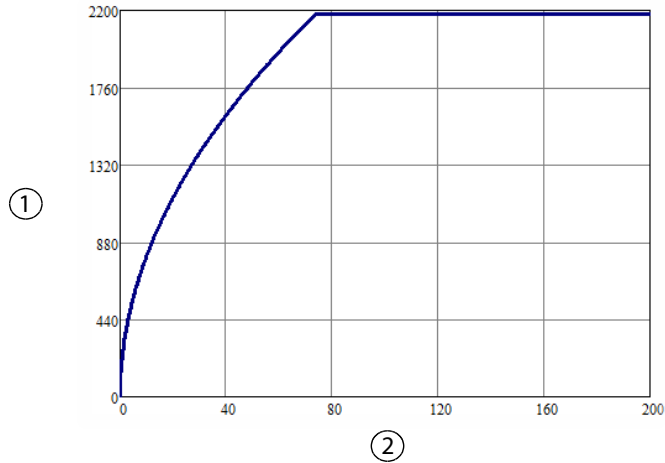

① Peak voltage (volts)

② Power setting

Note: Open circuit

VALLEYLAB™ Mode

Output power versus resistance for VALLEYLAB™ mode

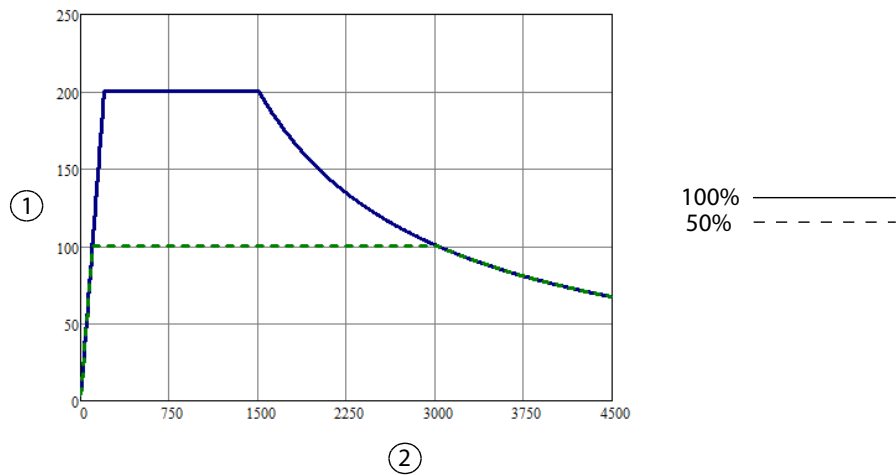

① Output power (watts)

② Load resistance (ohms)

Output power versus power setting for VALLEYLAB™ mode

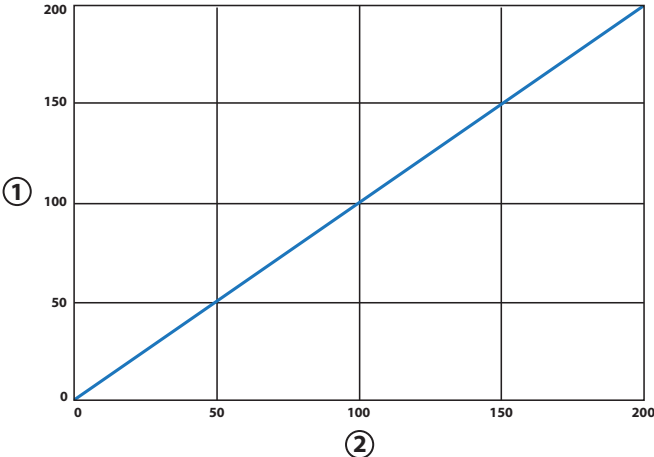

- ① Output power (watts)
- ② Power setting

Note: Rated load

Peak voltage versus power setting for VALLEYLAB™ mode

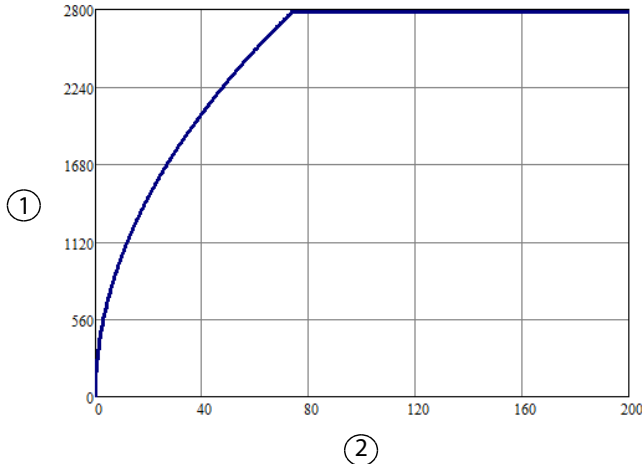

- ① Peak voltage (volts)
- ② Power setting

Note: Open circuit

Technical Specifications

SOFT

Output power versus resistance for SOFT mode

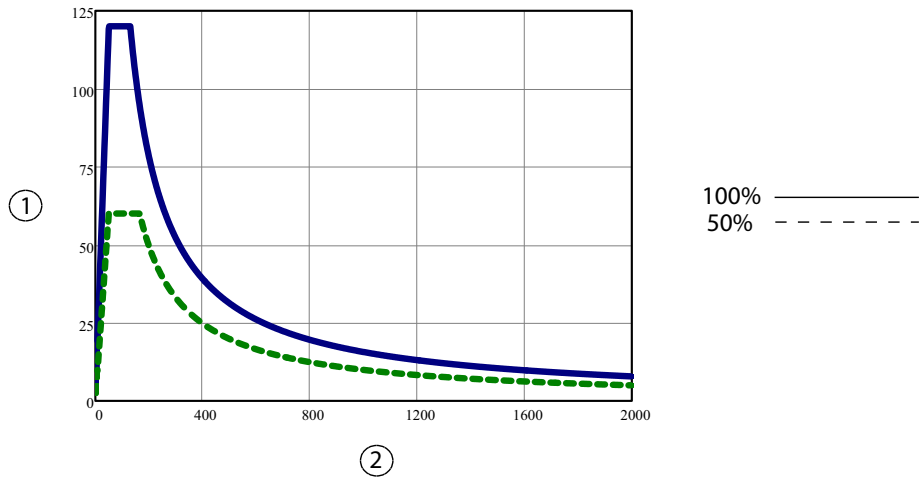

- ① Output power (watts)
- ② Load resistance (ohms)

Output power versus power setting for SOFT mode

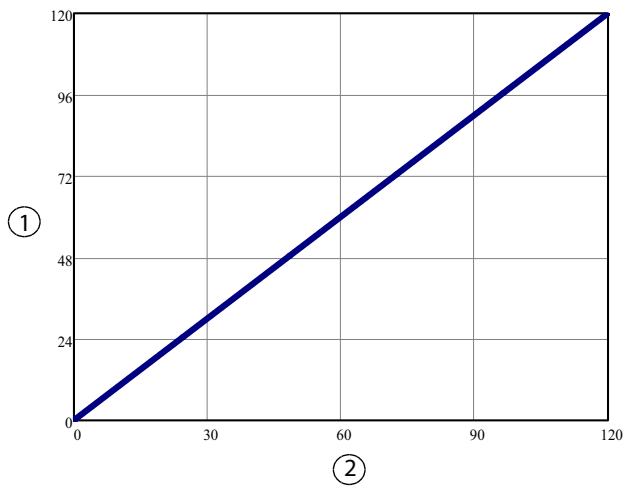

- ① Output power (watts)
- ② Power setting

Note: Rated load

Peak voltage versus power setting for SOFT mode

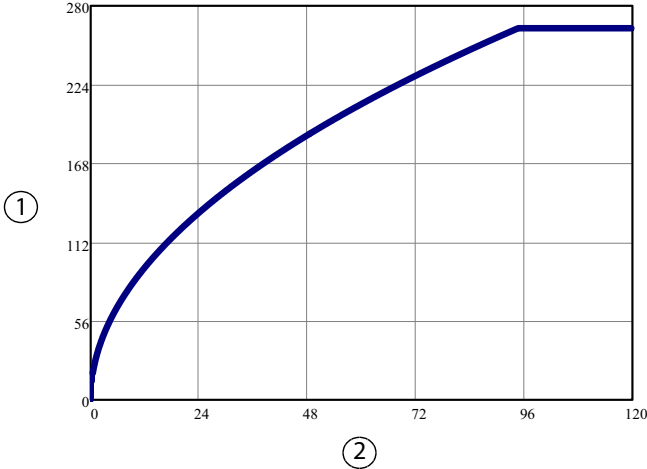

- ① Peak voltage (volts)
- ② Power setting

Note: Open circuit

FULGURATE

Output power versus resistance for FULGURATE mode

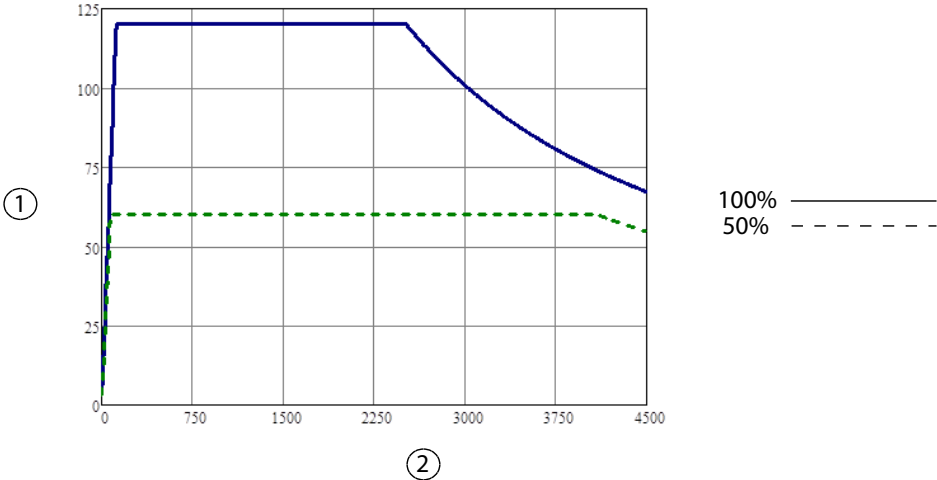

- ① Output power (watts)
- ② Load resistance (ohms)

Output power versus power setting for FULGURATE mode

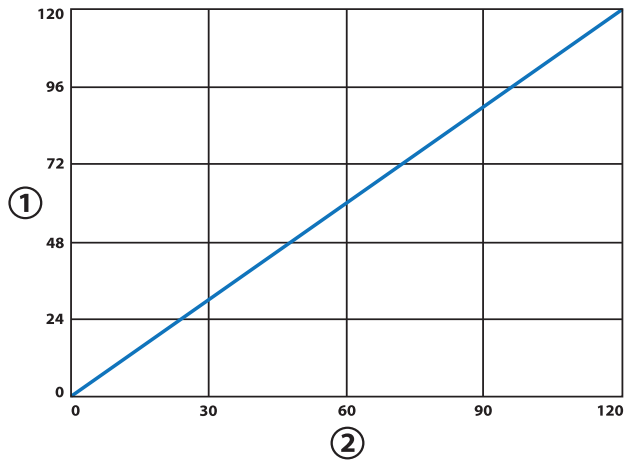

① Output power (watts)

② Power setting

Note: Rated load

Peak voltage versus power setting for FULGURATE mode

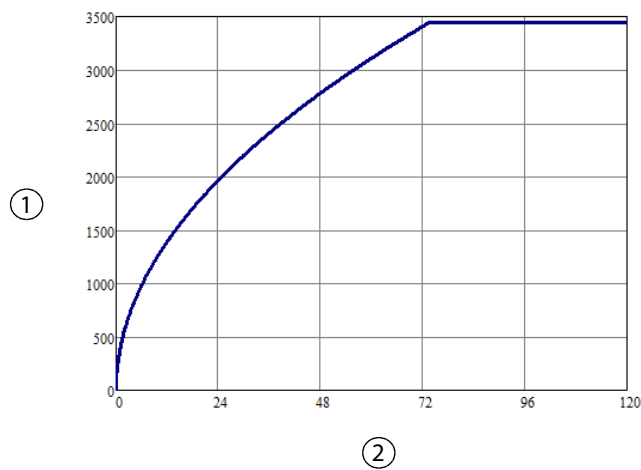

① Peak voltage (volts)

② Power setting

Note: Open circuit

SHARED FULGURATE - Single Activation (One Instrument Activated)

Output power versus resistance for SHARED FULGURATE (single activation) mode

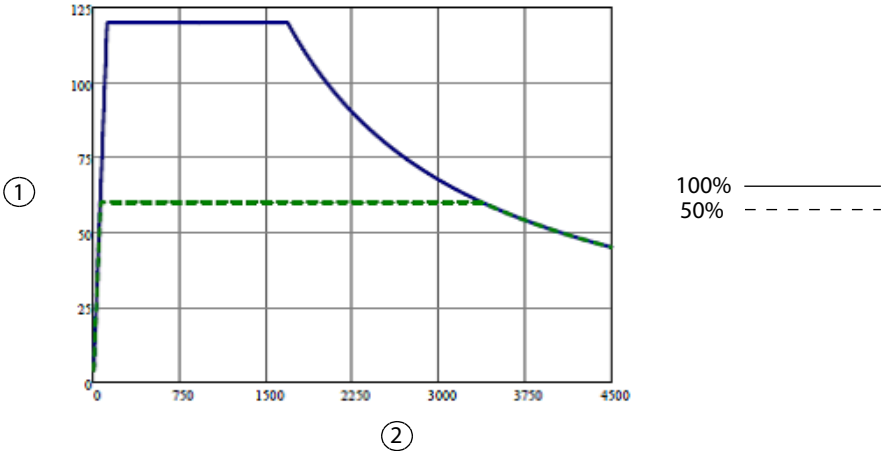

- ① Output power (watts)
- ② Load resistance (ohms)

Output power versus power setting for SHARED FULGURATE (single activation) mode

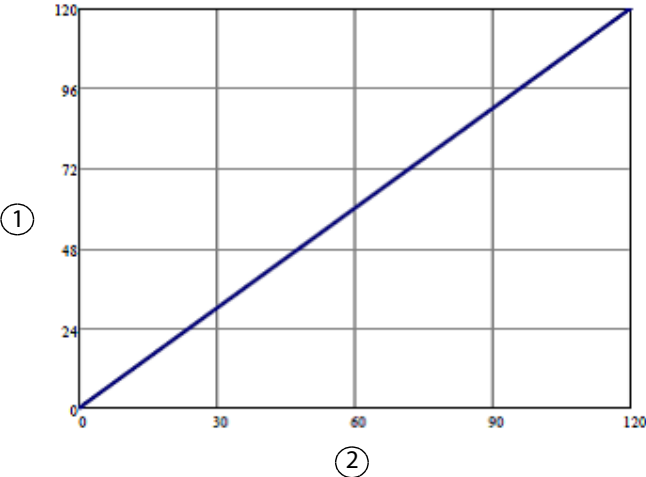

- ① Output power (watts)
- ② Power setting

Note: Rated load

Technical Specifications

Peak voltage versus power setting for SHARED FULGURATE (single activation) mode

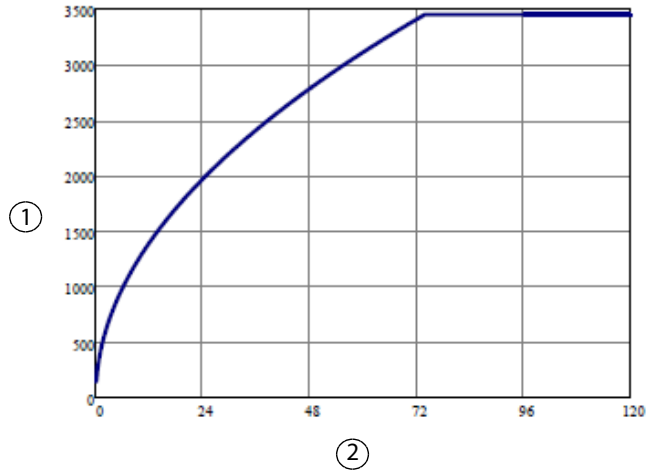

① Peak voltage (volts)

② Power setting

Note: Open circuit

SHARED FULGURATE - Dual Activation (Two Instruments Activated)

Output power versus resistance for SHARED FULGURATE (dual activation) mode

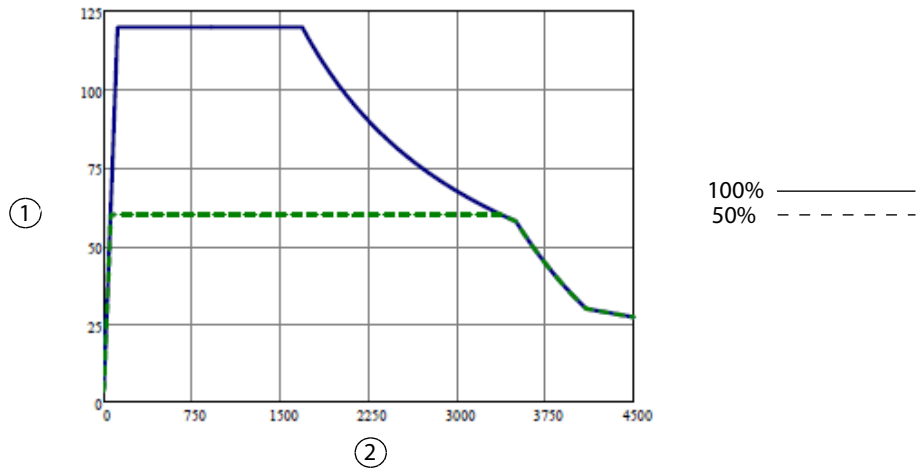

① Output power (watts)

② Load resistance (ohms)

Output power versus power setting for SHARED FULGURATE (dual activation) mode

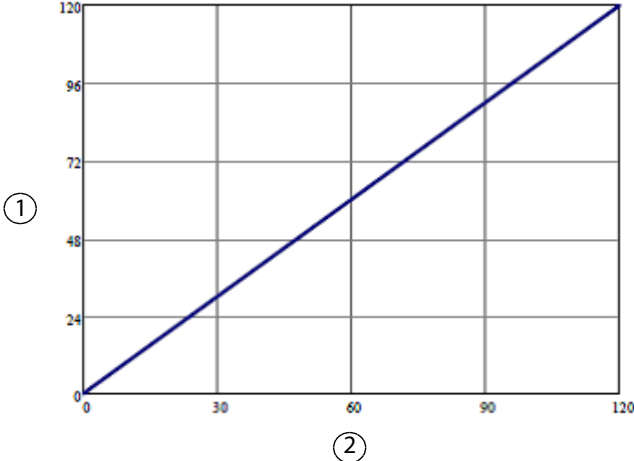

- ① Output power (watts)
- ② Power setting

Note: Rated load

Peak voltage versus power setting for SHARED FULGURATE (dual activation) mode

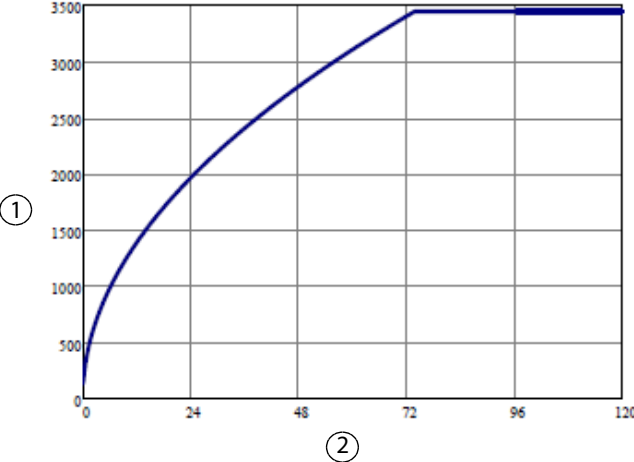

- ① Peak voltage (volts)
- ② Power setting

Note: Open circuit

Technical Specifications

SPRAY

Output power versus resistance for SPRAY mode

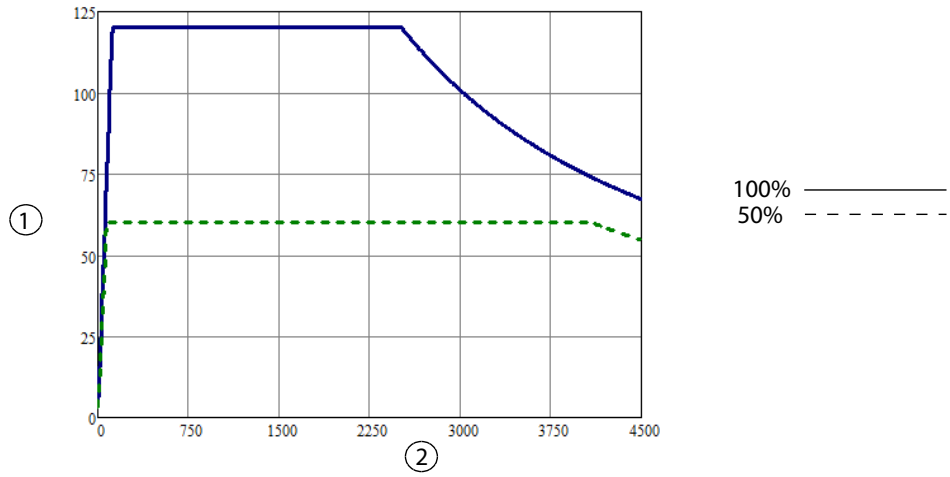

- ① Output power (watts)
- ② Load resistance (ohms)

Output power versus power setting for SPRAY mode

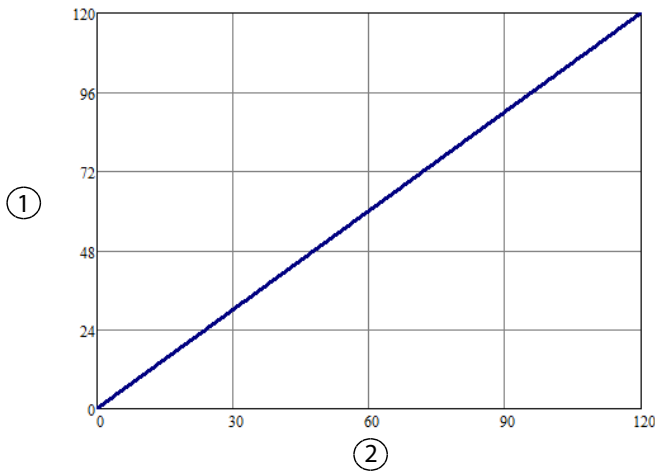

- ① Output power (watts)
- ② Power setting

Note: Rated load

Peak voltage versus power setting for SPRAY mode

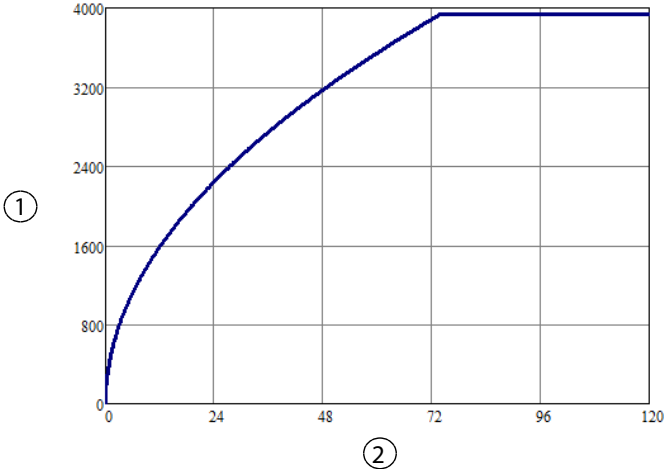

- ① Peak voltage (volts)
- ② Power setting

Note: Open circuit

SHARED SPRAY - Single Activation (One Instrument Activated)

Output power versus resistance for SHARED SPRAY (single activation) mode

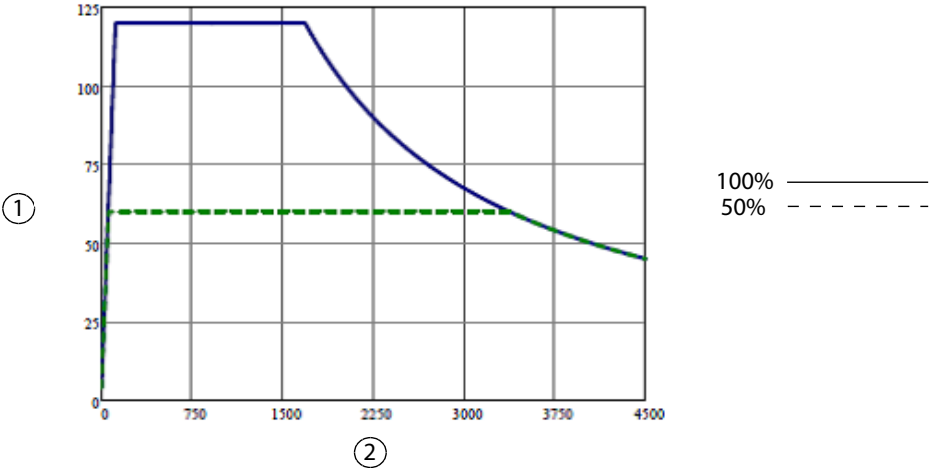

- ① Output power (watts)
- ② Load resistance (ohms)

Output power versus power setting for SHARED SPRAY (single activation) mode

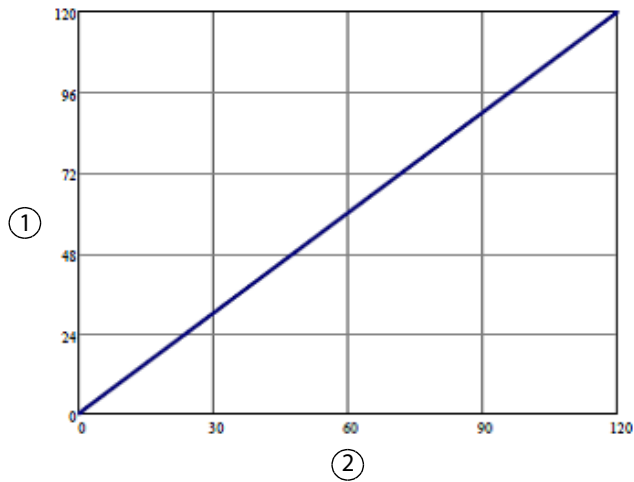

① Output power (watts)

② Power setting

Note: Rated load

Peak voltage versus power setting for SHARED SPRAY (single activation) mode

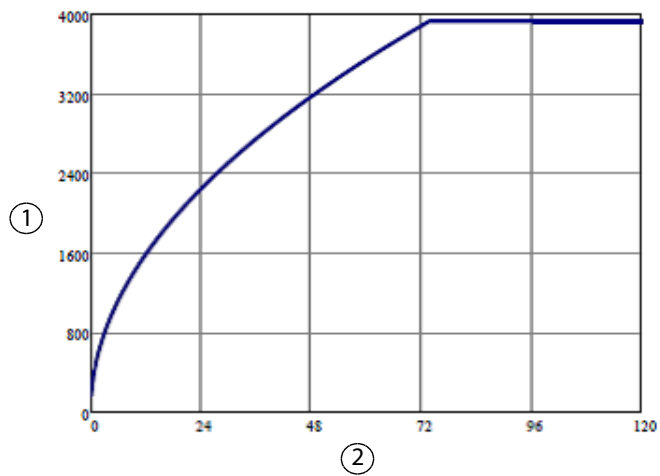

① Peak voltage (volts)

② Power setting

Note: Open circuit

SHARED SPRAY - Dual Activation (Two Instruments Activated)

Output power versus resistance for SHARED SPRAY (dual activation) mode

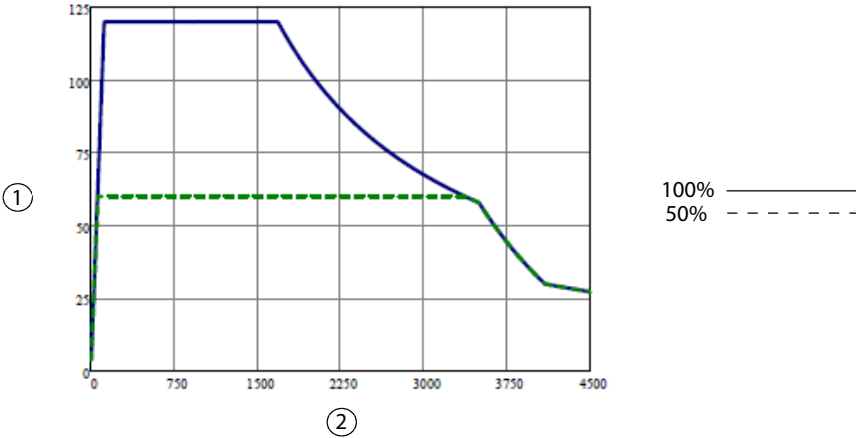

- ① Output power (watts)
- ② Load resistance (ohms)

Output power versus power setting for SHARED SPRAY (dual activation) mode

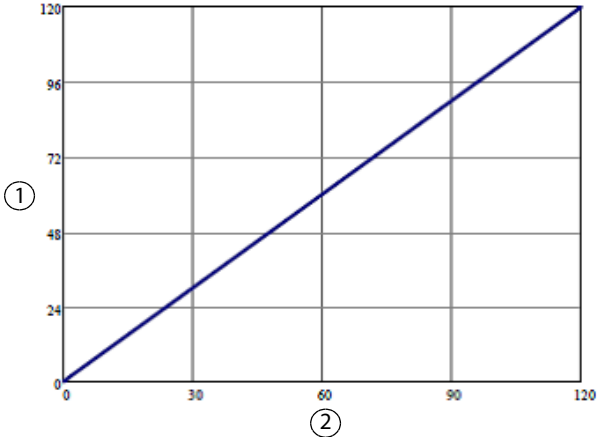

- ① Output power (watts)
- ② Power setting

Note: Rated load

Technical Specifications

Peak voltage versus power setting for SHARED SPRAY (dual activation) mode

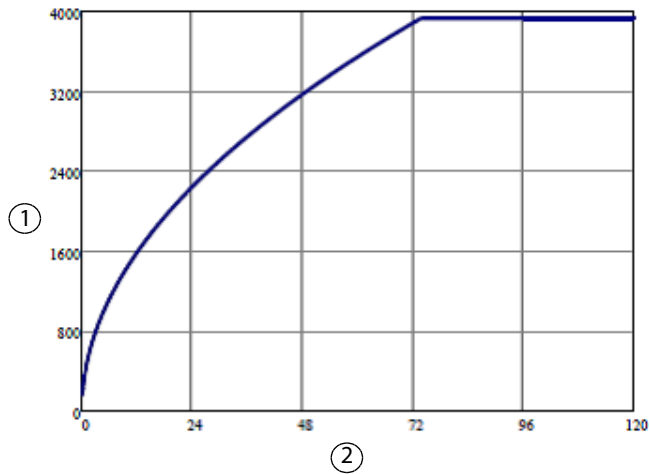

① Peak voltage (volts)

② Power setting

Note: Open circuit

Bipolar Graphs

Bipolar PRECISE Mode

Output power versus impedance for Bipolar PRECISE mode

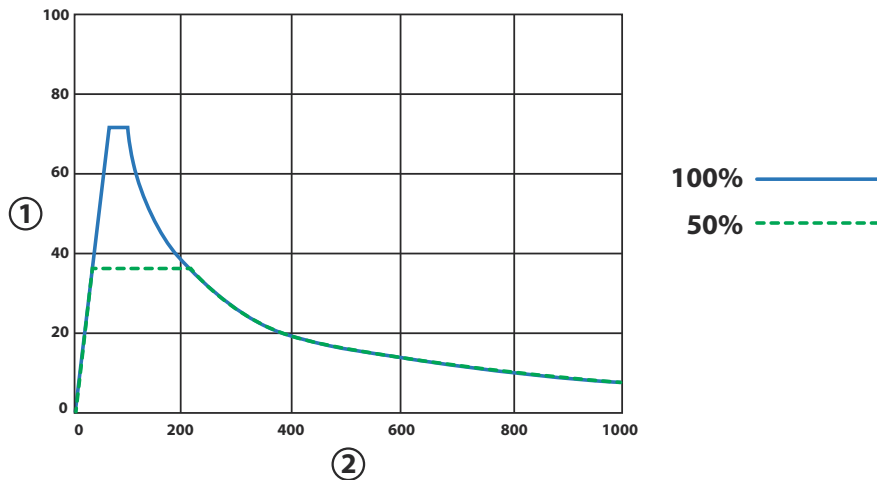

① Output power (watts)

② Load resistance (ohms)

Output power versus power setting for Bipolar PRECISE mode

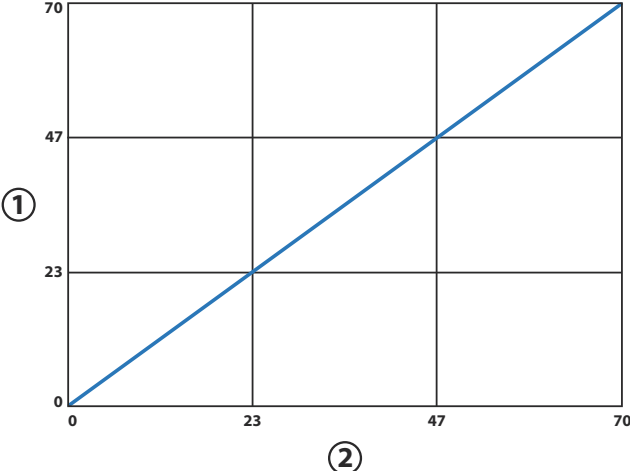

- ① Output power (watts)
- ② Power setting

Note: Rated load

Peak voltage versus power setting for Bipolar PRECISE mode

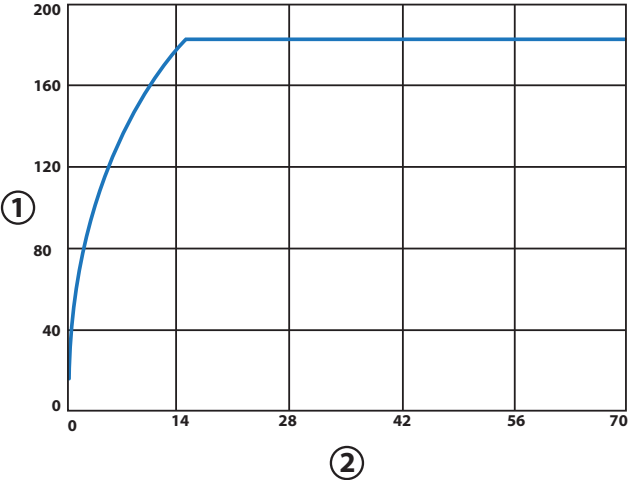

- ① Peak voltage (volts)
- ② Power setting

Note: Open circuit

Technical Specifications

Bipolar STANDARD Mode

Output power (maximum) versus resistance for Bipolar STANDARD mode

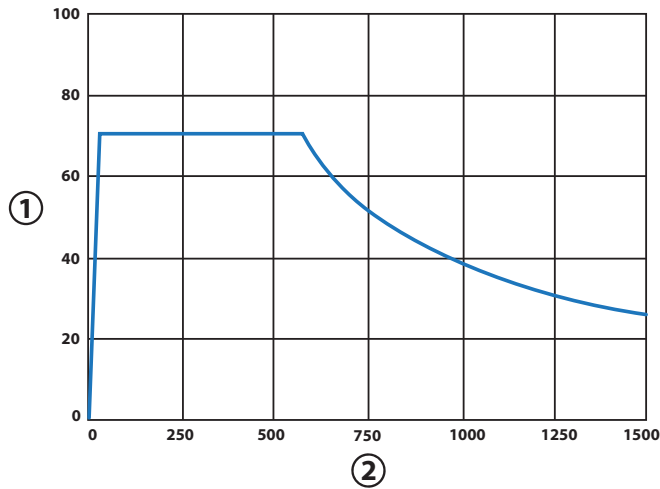

① Output power (watts)

② Load resistance (ohms)

Note: This power curve identifies the confines of the output power capability curve. An algorithm controls the power output in Bipolar STANDARD mode. Power control is dynamic for less than 1 second, after which it achieves a steady state power output.

Output power (steady state) versus resistance for Bipolar STANDARD mode

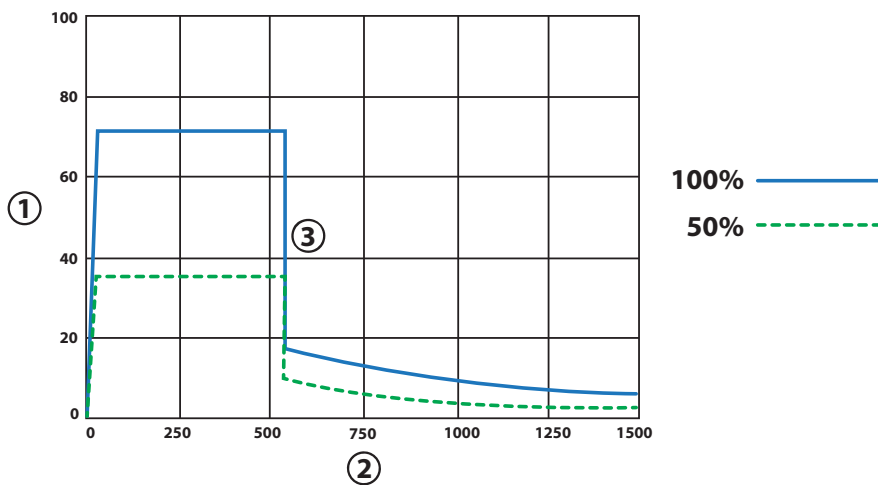

① Output power (watts)

② Load resistance (ohms)

③ See *Discontinuous Power Curves* on page 11-52 for additional details of this region of the power curve.

Output power (steady state) versus power setting for Bipolar STANDARD mode

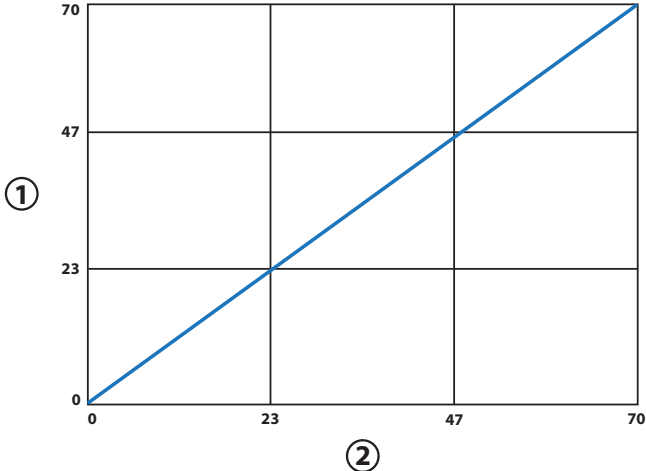

- ① Output power (watts)
- ② Power setting

Note: Rated load

Peak voltage (steady state) versus power setting for Bipolar STANDARD mode

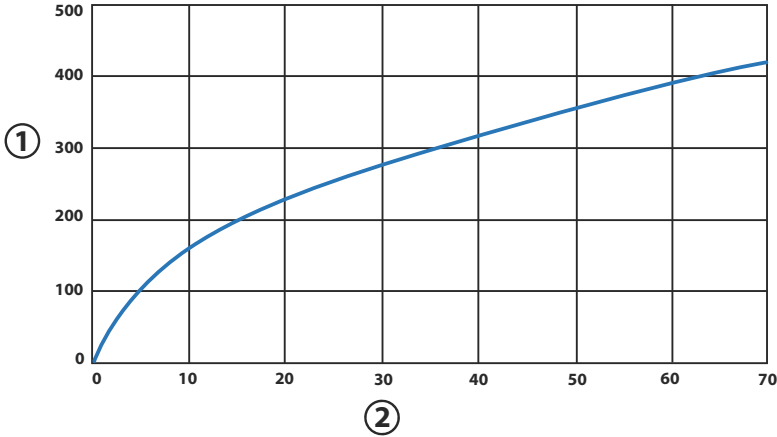

- ① Peak voltage (volts)
- ② Power setting

Note: Open circuit; includes tolerance.

Technical Specifications

Bipolar MACRO Mode

Output power (maximum) versus resistance for Bipolar MACRO mode

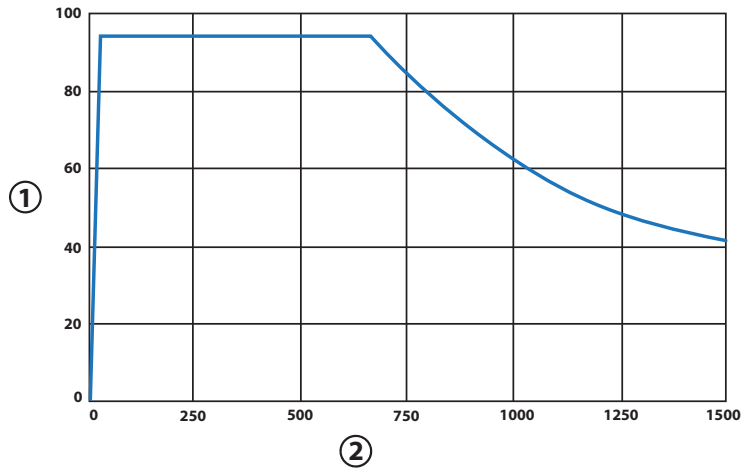

① Output power (watts)

② Load resistance (ohms)

Note: This power curve identifies the confines of the output power capability curve. An algorithm controls the power output in Bipolar MACRO mode. Power control is dynamic for less than 1 second, after which it achieves a steady state power output.

Output power (steady state) versus resistance for Bipolar MACRO mode

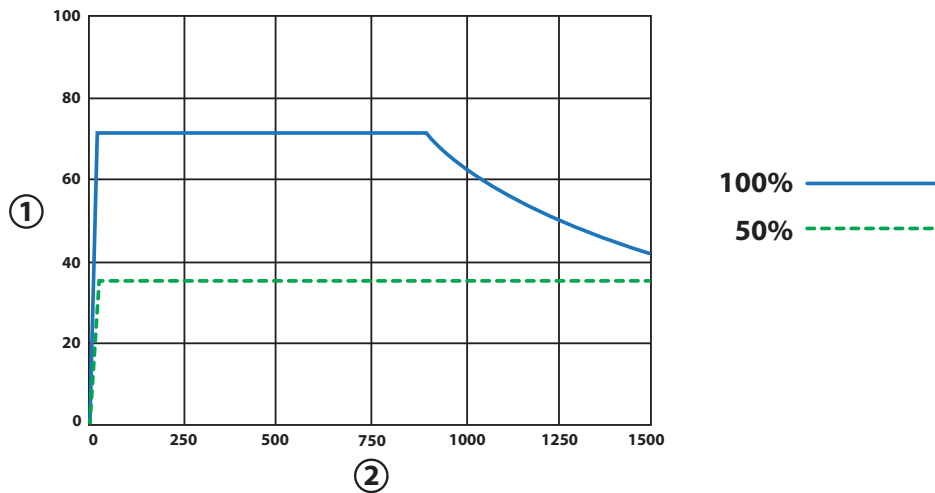

① Output power (watts)

② Load resistance (ohms)

Output power (steady state) versus power setting for Bipolar MACRO mode

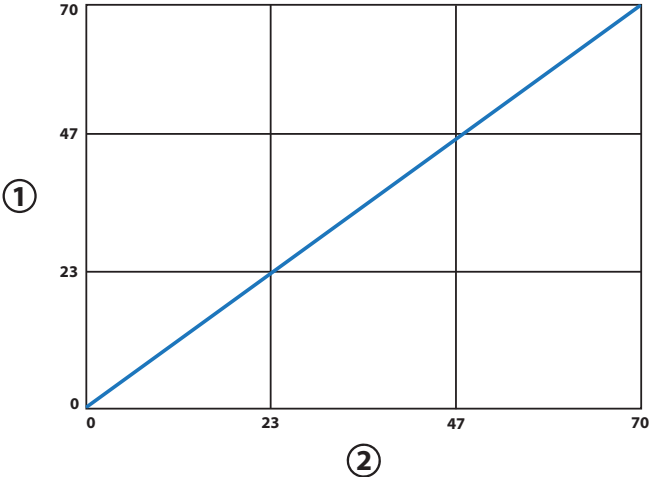

- ① Output power (watts)
- ② Power setting

Note: Rated load

Peak voltage (steady state) versus power setting for Bipolar MACRO mode

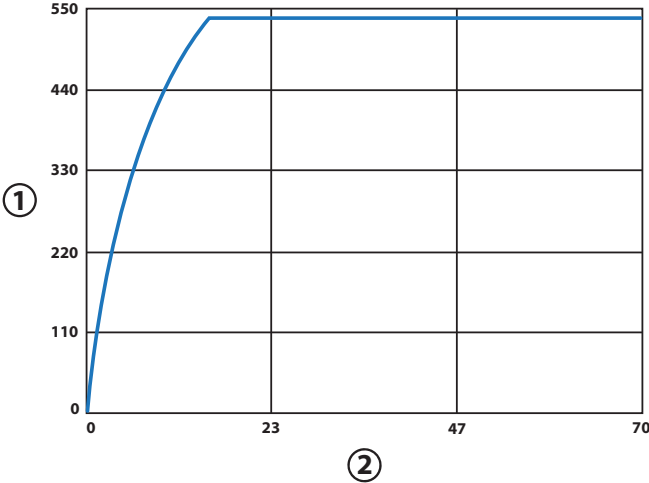

- ① Peak voltage (volts)
- ② Power setting

Note: Open circuit; includes tolerance.

Technical Specifications

LigaSure™ Technology

Output power versus resistance for LigaSure™ technology power

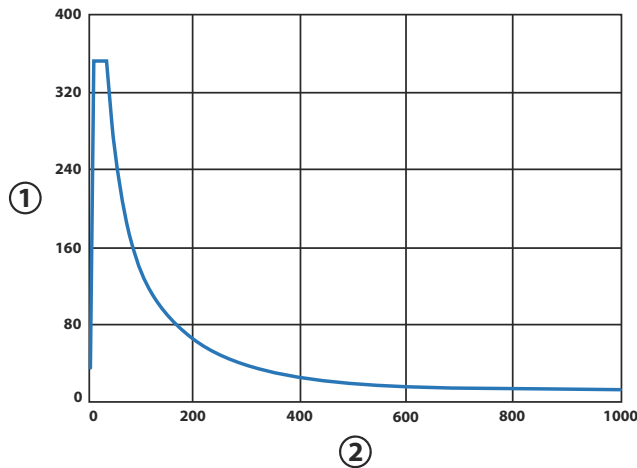

① Output power (watts)

② Load resistance (ohms)

Note: The LigaSure™ Vessel Sealing algorithm is a vessel adaptive algorithm. The LigaSure™ Vessel Sealing algorithm only requests the power it needs to optimally seal vessels; the power requested will be within the confines of the output power capability curve. Presentation of the “half output control setting” per IEC 60601-2-2 is not required.

Output power versus resistance for representative LigaSure™ technology instruments

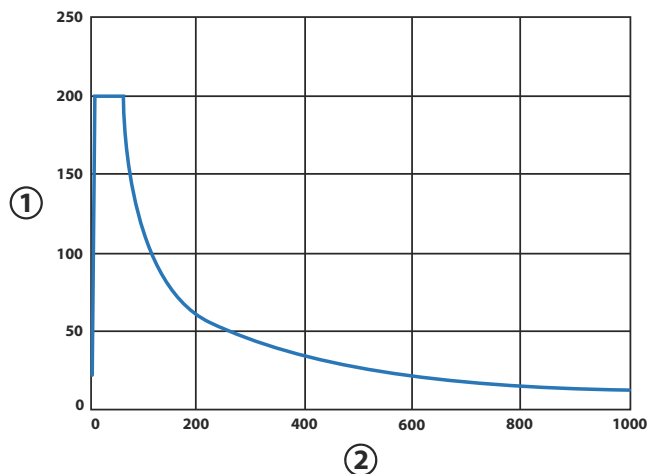

① Output power (watts)

② Load resistance (ohms)

Note: The LigaSure™ technology algorithm limits the power to 200 watts for the representative LigaSure™ technology instruments including LF1537, LF1544, LF5544,

LF1212, LF1212A, LF4200, LF4200T, LF1520, LF1723, LF1737, LF1744, LF1637, LF1623, LF1644, LF3225, LS1020, LS1037, LF4318, LF5637, and LF5644.

Peak voltage versus output power for LigaSure™ technology mode

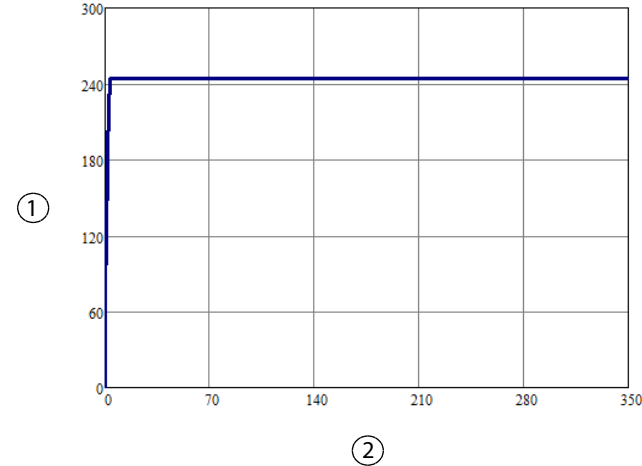

- ① Peak voltage (volts)
- ② Output power (watts)

Note: Open circuit

Bipolar Resection CUT

Note: Bipolar Resection CUT operates in two stages: there is an initiate stage for impedance values up to 400 Ω and a therapy stage above 400 Ω, with hysteresis down to 100 Ω.

Output power versus resistance for Bipolar Resection CUT mode - initiate stage

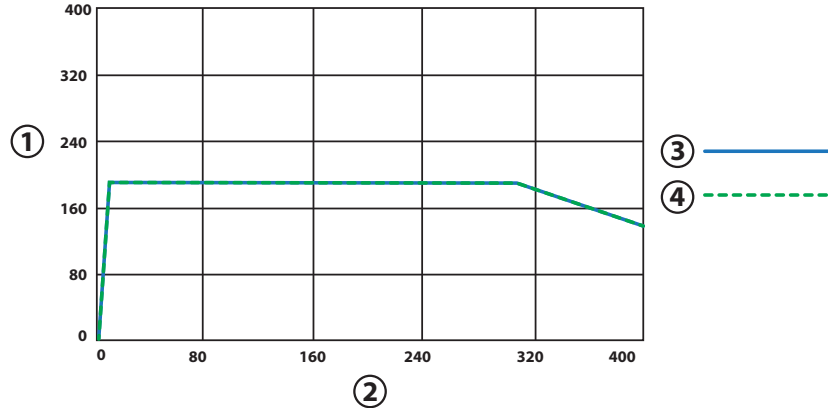

- ① Output power (watts)
- ② Load resistance (ohms)
- ③ CUT Effect 3
- ④ CUT Effect 6

Output Power vs. Resistance Graphs

Output power versus resistance for Bipolar Resection CUT mode - therapy stage

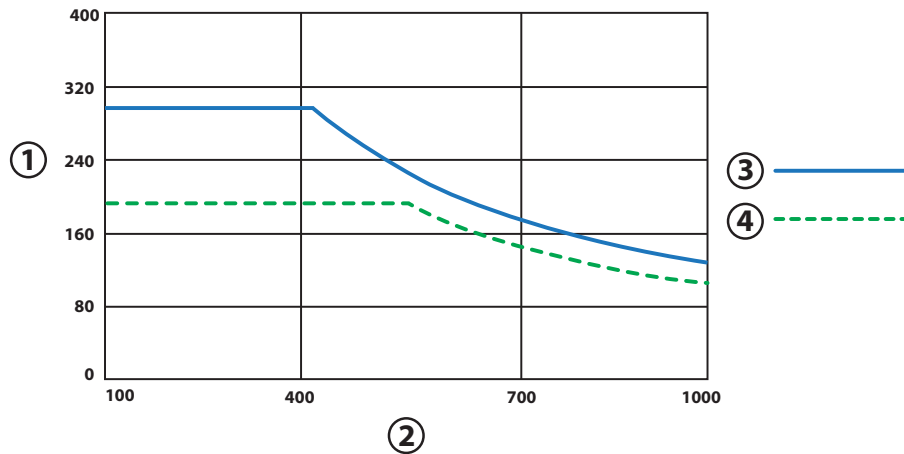

- ① Output power (watts)
- ② Load resistance (ohms)
- ③ CUT Effect 3
- ④ CUT Effect 6

Output power versus effect setting for Bipolar Resection CUT mode - initiate stage

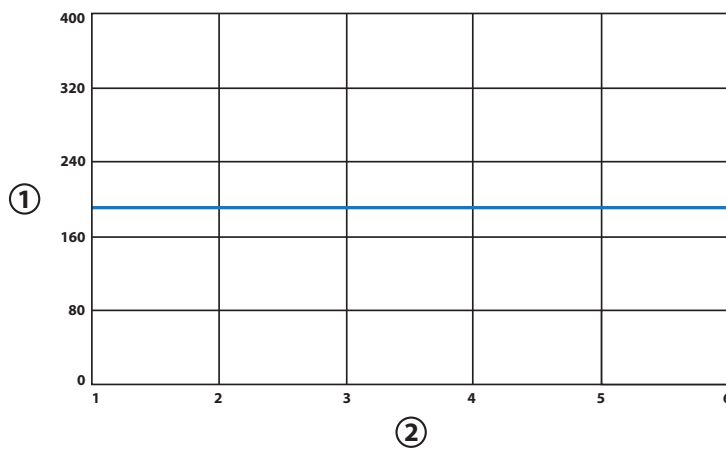

- ① Output power (watts)
- ② Effect setting

Note: Rated load

Output power versus effect setting for Bipolar Resection CUT mode - therapy stage

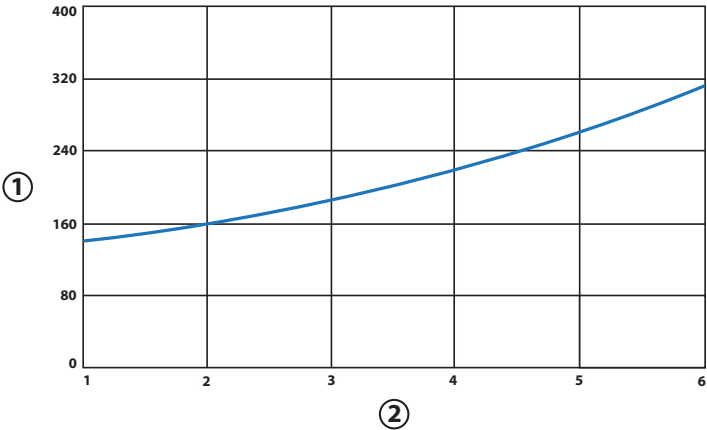

- ① Output power (watts)
- ② Effect setting

Note: Rated load

Peak voltage versus effect setting for Bipolar Resection CUT mode - initiate stage

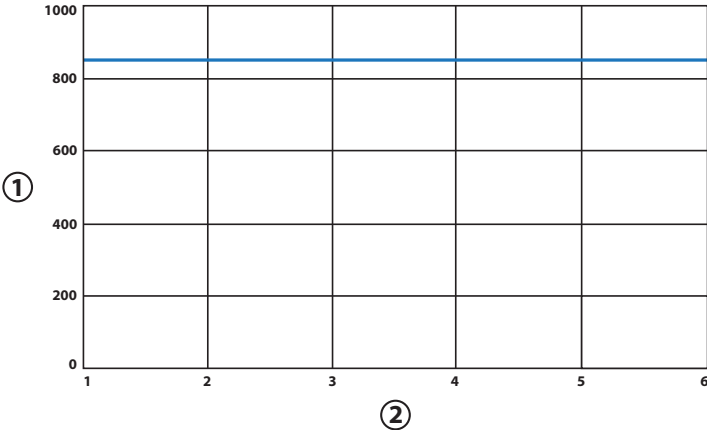

- ① Peak voltage (volts)
- ② Effect setting

Note: Open circuit

Technical Specifications

Peak voltage versus effect setting for Bipolar Resection CUT mode - therapy stage

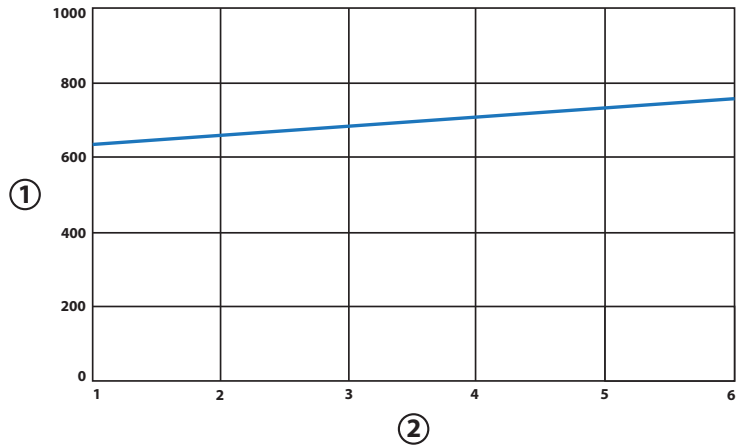

① Peak voltage (volts)

② Effect setting

Note: Open circuit

Bipolar Resection COAG

Output power versus resistance for Bipolar Resection COAG mode

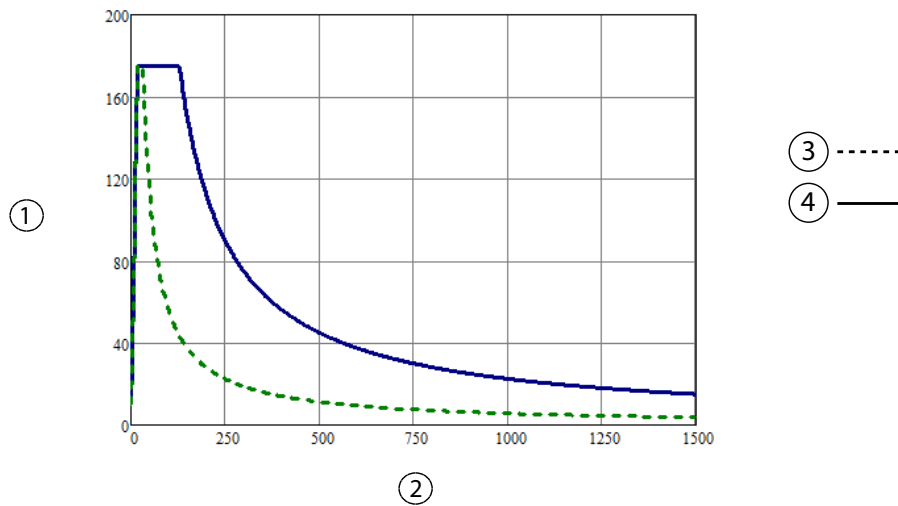

① Output power (watts)

② Load resistance (ohms)

③ COAG Effect 3

④ COAG Effect 6

Output power versus effect setting for Bipolar Resection COAG mode

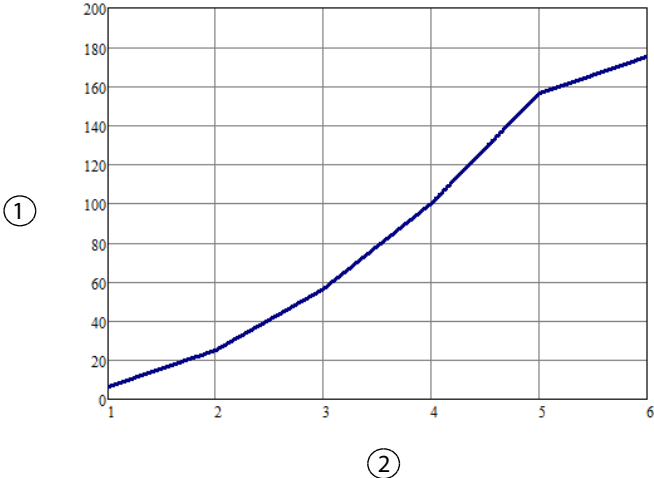

- ① Output power (watts)
- ② Effect setting

Note: Rated load

Peak voltage versus effect setting for Bipolar Resection COAG mode

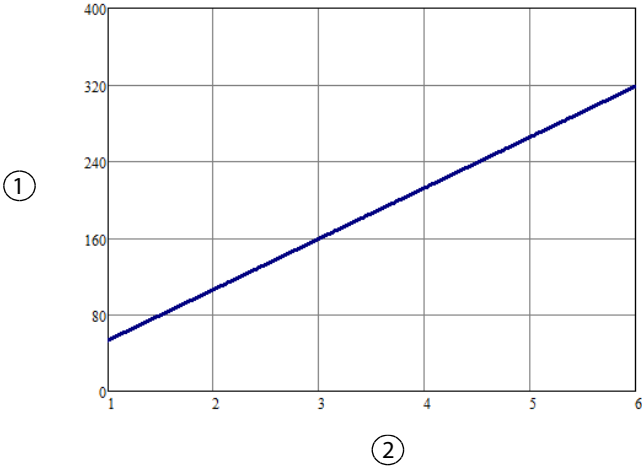

- ① Peak voltage (volts)
- ② Effect setting

Note: Open circuit

Technical Specifications

Cardioblate™ Ablation System Devices

Output power versus resistance capability for Cardioblate™ device MONOPOLAR mode

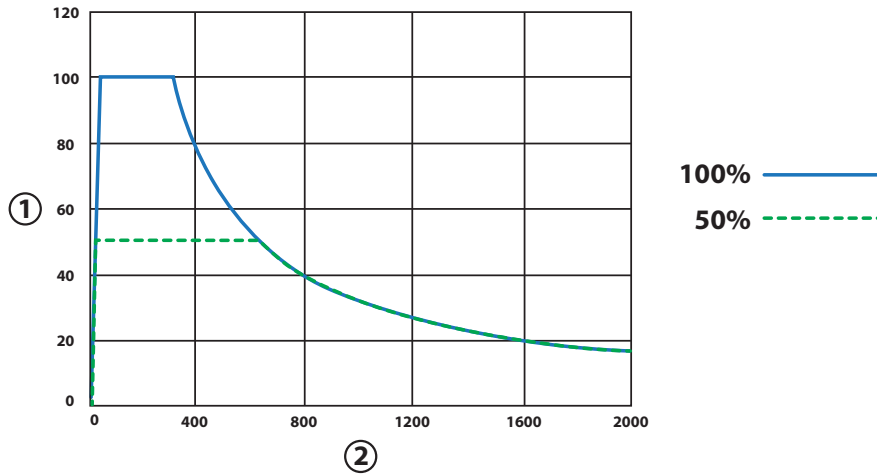

- ① Output power (watts)
- ② Load resistance (ohms)

Output power versus resistance for representative Cardioblate™ ablation system MONOPOLAR pens

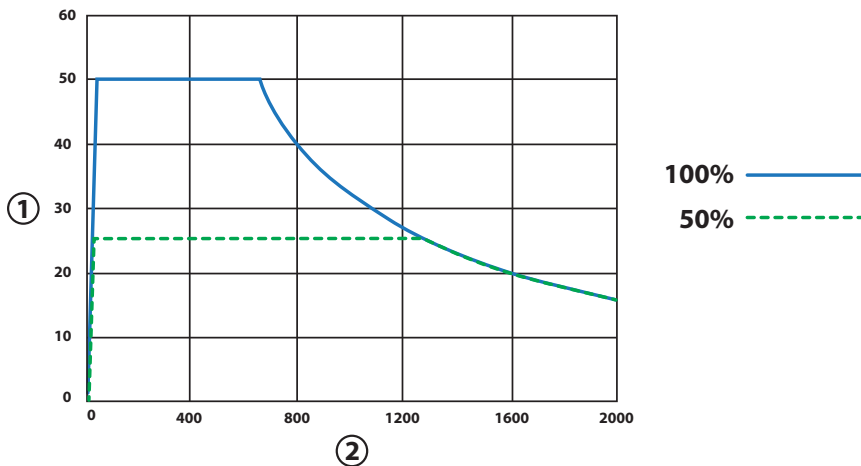

- ① Output power (watts)
- ② Load resistance (ohms)

Note: The generator limits the power to 50 watts for representative Cardioblate™ disposables including the VLFT Pen and XL VLFT Pen.

Output power versus power setting for Cardioblade™ ablation system MONOPOLAR mode

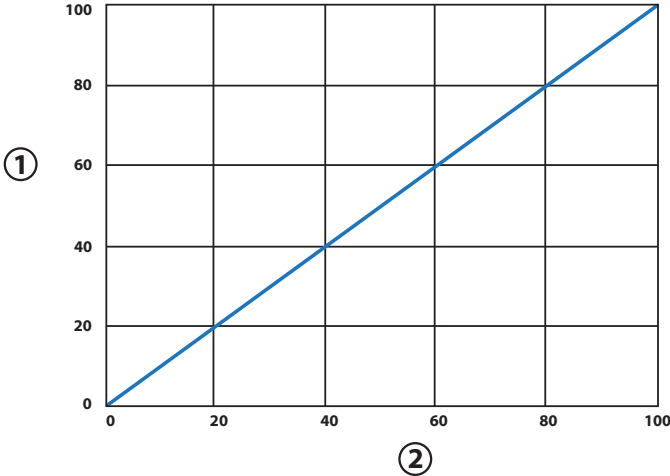

- ① Output power (watts)
- ② Power setting

Note: Rated load

Peak voltage versus power setting for Cardioblade™ device MONOPOLAR mode

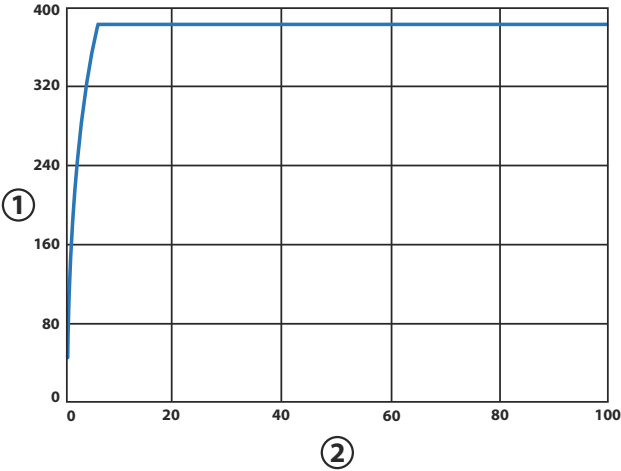

- ① Peak voltage (volts)
- ② Power setting

Note: Open circuit

Technical Specifications

Cardioblate™ Bipolar Devices

Output power versus resistance capability for Cardioblate™ ablation system BIPOLAR mode

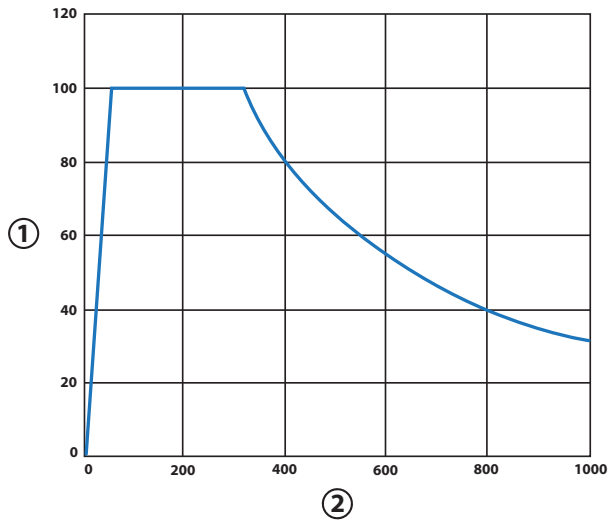

- ① Output power (watts)
- ② Load resistance (ohms)

Note: The Cardioblate™ bipolar algorithm is an adaptive algorithm. The Cardioblate™ bipolar algorithm only requests the power it needs to optimally ablate; the power requested will be within the confines of the output power capability curve. Presentation of the “half output control setting” per IEC 60601-2-2 is not required.

Output power versus resistance for representative Cardioblade™ BIPOLAR devices

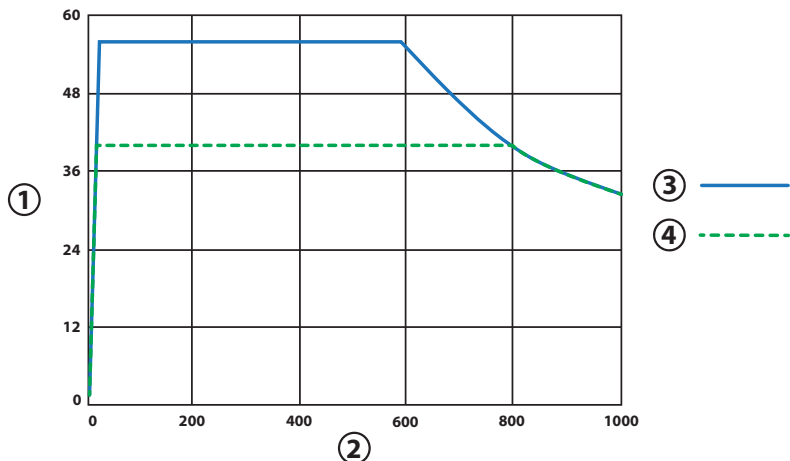

- ① Output power (watts)
- ② Load resistance (ohms)
- ③ Enhanced Device
- ④ BP2 and LP Devices

Note: The Cardioblade™ algorithm limits the power to 55 watts for the enhanced bipolar device and 40 watts for the BP2 and LP devices.

Peak voltage versus output power for Cardioblade™ BIPOLAR mode

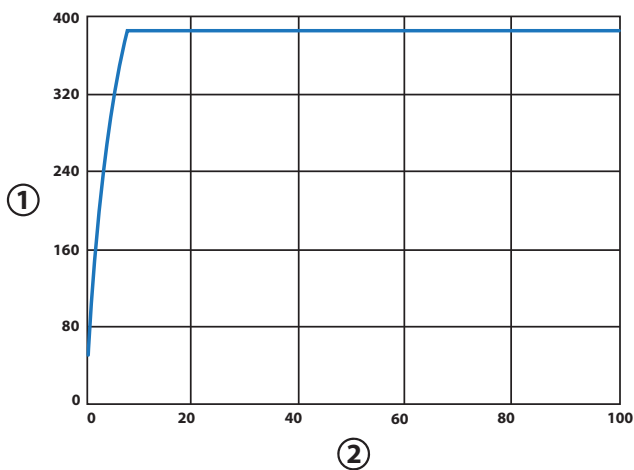

- ① Peak voltage (volts)
- ② Power setting

Note: Open circuit

Discontinuous Power Curves

The power curves depicted earlier in this section show a nominal situation – one where there is no sensor variance. As stated earlier in this section, there is an allowed tolerance in both the output power as well as the measured resistance, so any measurements that fall within the allowed tolerance, or “area of uncertainty,” are considered to meet requirements.

For most regions of the power curve, considering only the tolerance in power is an acceptable engineering approximation; however, in some modes there are regions in the power curves with sharp changes in output power with respect to measured resistance. In these power curve regions, the area of uncertainty in resistance should be considered when performing power output tests.

The following charts zoom in on the sharp changes in the power curves and provide an illustrative description of the area of uncertainty in resistance along just that portion of the power curve.

Bipolar STANDARD Mode Power vs. Resistance (Full Power - Steady State) with Area of Uncertainty in Resistance (Does Not Include Power Tolerance)

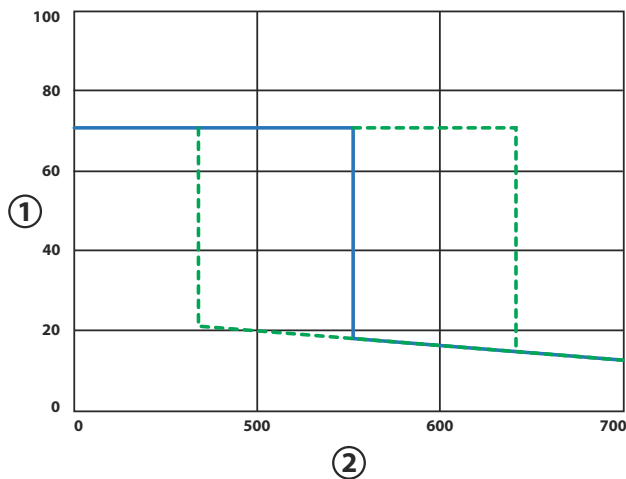

- ① Output power (watts)
- ② Load resistance (ohms)

Bipolar STANDARD Mode Power vs. Resistance (Half Power - Steady State) with Area of Uncertainty in Resistance (Does Not Include Power Tolerance)

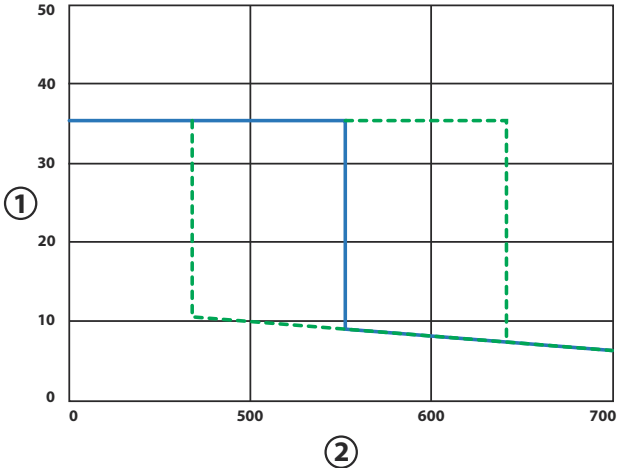

- ① Output power (watts)
- ② Load resistance (ohms)

Technical Specifications

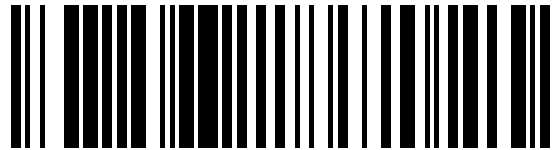

PT00093618

Part No. PT00093618

COVIDIEN, COVIDIEN with logo, and Covidien logo and Positive Results for Life are U.S. and internationally registered trademarks of Covidien AG. Cardioblate is a U.S. and internationally registered trademark of Medtronic. Other brands are trademarks of a Covidien company, TM* brands are trademarks of their respective owner.

May be covered by U.S. Patents: www.covidien.com/patents

©2013 Covidien.

Made in USA. Printed in USA.

 Covidien llc, 15 Hampshire Street, Mansfield, MA 02048 USA.

 Covidien Ireland Limited, IDA Business & Technology Park, Tullamore, Ireland.

www.covidien.com

1 303 530 2300 [T]

1 800 255 8522 [T]

REV 03/2019

Rx
ONLY



COVIDIEN