

ORDIN DE PLATA

2531

DATA EMITERII

21 iunie 2022

TIP DOC : 1

PLATITI:

7000-00

LEI

Sapte Mii LEI și 00 Ban

PLĂTITOR

(R) MEDIA SECURITY SRL

CODUL IBAN

MD48AG00000022512901602

CODUL FISCAL:

1006600023985

PRESTATORUL PLĂTITOR:

BC'MAIB'S.A. suc.'Ismail'

BENEFICIAR

(R) IP Serviciul Tehnologia Informaiei i Securitate Cibernetic

CODUL IBAN

MD21TRPCCC518430A01371AA

CODUL FISCAL:

1003600096694

PRESTATORUL BENEFICIAR:

Ministerul Finantelor - Trezoreria de Stat

DESTINAȚIA PLĂȚII:

/P102/7000,00 PLATA Pentru garania pentru oferta la licitaia public nr MTENDER OCDS-B3WDP1-MD1654261096497 DIN 03.06.22

TIPUL TRANSFERULUI NORMAL/URGENT

N

COD TRANZACȚIE:

101

DATA PRIMIRII:

21 iunie 2022 11:49:00

DATA EXECUTĂRII:

21 iunie 2022 11:49:00

Ora Primirii 1 1 : 4 9

L.Ș.

Victor Gaina

Victor Gaina

SEMNĂTURA PRESTATORULUI

SEMNĂTURILE EMITENTULUI

L.Ș. internet-banking

MOTIVUL REFUZULUI:



BST | A RELIABLE TESTING FOR TRUST

GLOBAL TESTING AND CERTIFICATION PRECISION SERVICE CLOUD FACTORY

Certificate of Compliance

Certificate No. : **BST180711353302Y-1EC-1**

Applicant : **PROVISION-ISR LIMITED.**
Room 403, F/4, Fu Fai Commercial Centre building, 27 Hillier Street, Sheung Wan, Hong-Kong

Manufacturer : **PROVISION-ISR LIMITED.**
Room 403, F/4, Fu Fai Commercial Centre building, 27 Hillier Street, Sheung Wan, Hong-Kong

Product Name : **CCTV CAMERA**

Trade Name : **PROVISION ISR**

Main Test Model : **I1-390AB36**

Additional Model : **See Annex**

Test Standard : **EN55032:2015**
EN61000-3-2:2014
EN61000-3-3:2013
EN55024:2010/A1:2015

As shown in the Test Report No. : **BST180711353301Y-1ER-1**

The EUT described above has been tested by us with the listed standards and found in compliance with the council EMC directive 2014/30/EU. It is possible to use CE marking to demonstrate the compliance with this EMC Directive.

The certificate applies to the tested sample above mentioned only and shall not imply an assessment of the whole production.



Christina Deng
Manager
Jul. 12, 2018

Shenzhen BST Technology Co.,Ltd.

Add: Building No.23-24, Zhiheng Industrial Park, Guankouer Road, Nantou, Nanshan District, Shenzhen, Guangdong, China

Certificate Search: <http://www.bst-lab.com>, Tel:400-882-9628, 8009990305, E-mail:christina@bst-lab.com



BST

A RELIABLE TESTING FOR TRUST

GLOBAL TESTING AND CERTIFICATION PRECISION SERVICE CLOUD FACTORY

Annex to Certificate No.: BST180711353302Y-1ER-1

Date: Jul. 12, 2018

M/N : DI-390AB36, XX-390ABYY (XX should be one or two letters from A-Z or 0-9, which stand for the type of case, YY should be "VF" which stand for varifocal lens or two digits stand for the lens focal). I1-380AB36, DI-380AB36, XX-380ABYY (XX should be one or two letters from A-Z or 0-9, which stand for the type of case, YY should be "VF" which stand for varifocal lens or two digits stand for the lens focal)

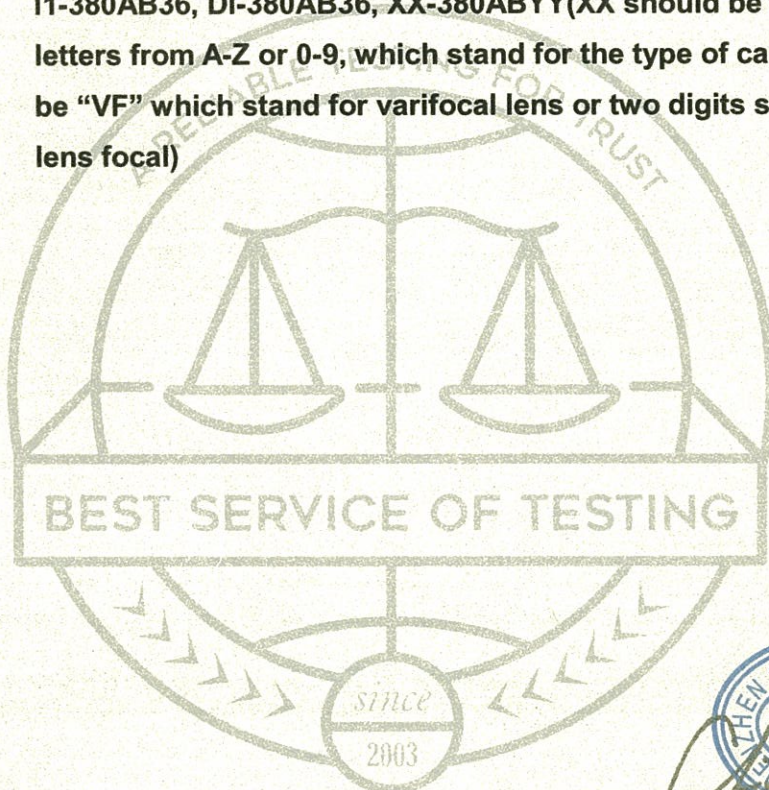

Christina Deng
Manager
Jul. 12, 2018

Shenzhen BST Technology Co.,Ltd.

Add: Building No.23-24, Zhiheng Industrial Park, Guankouer Road, Nantou, Nanshan District, Shenzhen, Guangdong, China

Certificate Search: <http://www.bst-lab.com>, Tel:400-882-9628, 8009990305, E-mail:christina@bst-lab.com

CERTIFICATION of Conformity

No.: MOSTCN19112288

Holder : **PROVISION-ISR LIMITED**
Room 403, F/4,Fu Fai Commercial Centre building, 27 Hillier Street, Sheung Wan, Hong-Kong

Product Name : **CAMERA**

Model Name : **I8-340IPE-MVF, I8-380IPE-MVF,I1-320IPB-28,I2-320IPS-28, I2-340IPS-28,I4-380IPS-28,I4-320IPS-VF,I4-380IPS-MVF, I4-320IPE-36,I4-320PE-MVF,I4-340IPE-36,I4-340IPE-MVF, I4-380IPE-28,I6-320IPE-MVF,I6-340IPE-MVF,I6-380IPE-MVF, I4-340IPS-MVF**

Brand Name : **PROVISION ISR**

Technical Data : **1:DC 12V**
2:POE power supply

Report No. : **MTEN19111847**

This certification refers to the conformity of the following Directive(s). It does not exclude the product(s) having to be in compliance with other applicable Directive(s):

According to the Electromagnetic Compatibility (EMC) directive 2014/30/EU.

It is to certify that the product identified above in compliance with the essential requirements of the following standard(s):

EN 55032:2015
EN 55035:2017

November 14, 2019
Date of Issue

Signed by: Yvette Zhou



This certification of conformity is based on an evaluation of the sample(s) of above mentioned product. Technical report and documentation are at the Holder's disposal. The CE marking as shown below can be affixed, under the responsibility of the manufacturer, after completion of an EC Declaration of Conformity and compliance with all relevant EC Directives. The affixing of the CE marking presumes in addition that the conditions in annexes III and IV of the Directive are fulfilled.

The original document contains watermark. Not to be reproduced without the permission of Shenzhen Most Technology Service Co., Ltd.



CERTIFICATION of Conformity

No.: MOSTCN19112292

Holder : **PROVISION-ISR LIMITED**
**Room 403, F/4,Fu Fai Commercial Centre building, 27 Hillier Street,
Sheung Wan, Hong-Kong**

Product Name : **CAMERA**

Model Name : **DI-320IPB-28, DI-320IPS-28,DI-340IPS-28,DI-380IPS-28,DI-320IPE-28,
DI-340IPE-28,DAI-320IPE-28,DAI-340IPE-28,DAI-380IPE-28,
DAI-320IPE-MVF,DAI-340IPE-MVF,DAI-380IPE-MVF,DI-320IPS-VF,
DI-340IPS-MVF,DI-380IPS-MVF,DI-320IPE-MVF,DI-340IPE-MVF,
DI-380IPE-MVF,DMA-320IPE-28,DMA-340IPE-28,BX-381IPE,BX-341IPE**

Brand Name : **PROVISION ISR**

Technical Data : **1:DC 12V
2:POE power supply**

Report No. : **MTEN19111851**

This certification refers to the conformity of the following Directive(s). It does not exclude the product(s) having to be in compliance with other applicable Directive(s):

According to the Electromagnetic Compatibility (EMC) directive 2014/30/EU.

It is to certify that the product identified above in compliance with the essential requirements of the following standard(s):

EN 55032:2015

EN 55035:2017

November 14, 2019

Date of Issue

Signed by: Yvette Zhou



This certification of conformity is based on an evaluation of the sample(s) of above mentioned product. Technical report and documentation are at the Holder's disposal. The CE marking as shown below can be affixed, under the responsibility of the manufacturer, after completion of an EC Declaration of Conformity and compliance with all relevant EC Directives. The affixing of the CE marking presumes in addition that the conditions in annexes III and IV of the Directive are fulfilled.

The original document contains watermark. Not to be reproduced without the permission of Shenzhen Most Technology Service Co., Ltd.





МИР БЕЗ ОПАСНОСТИ
www.media-security.eu

MEDIA SECURITY

SECURITY & COMMUNICATION SYSTEMS

Departamentul Tehnic

ACT DE CONFIRMARE

Prin prezentul, compania “Media Security”SRL, confirmă prezenta in cadrul companiei a Centrului de service suport tehnic si reparatii și garantează angajati instruiti si calificati pentru lucrarile de mentenanta, renovare si punere in functiune a Sistemelor de securitate:

- Sisteme supraveghere video** (*video analitica*);
- Sisteme control al accesului** (turnichete si bare de acces cu system de pontare);
- Sisteme antiefracție și securitate perimetru;**
- Sisteme detecție și avertizare la incendiu;**
- Sisteme conferinta si sonorizare voce;**
- Sisteme GPS** (*poziționarea geografica și monitorizarea traficului auto*).

Administrator

Gaina Victor



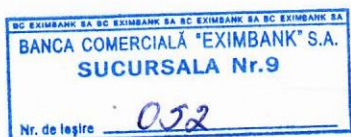

09. APR. 2021

CERTIFICAT

Prin prezentul se confirmă faptul deținerii de către "MEDIA SECURITY" S.R.L., IDNO: **1006600023985**, a următoarelor conturilor curente deschise la B.C. "EXIMBANK" S.A. Filiala nr. 9, codul băncii EXMMMD22, după cum urmează:

Nr. cont	IBAN	Codul valutei
2251109179EU	MD48EX0000002251109179EU	EUR
2251109179US	MD67EX0000002251109179US	USD
225109179MDL	MD50EX0000000225109179MD	MDL

Certificatul este eliberat pentru a fi prezentat la cerere.

Nicolae Turcan
Director Filiala nr. 9

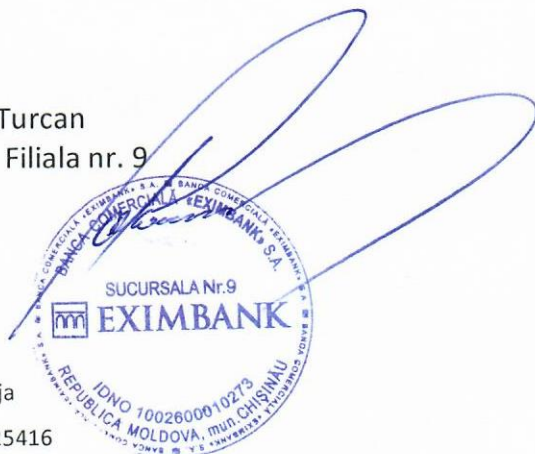

Ex. A Rebeja
Tel: 022 225416

IP S-SIGHT SERIES

Provision-ISR S-SIGHT series provides you with all that you need for a simple installation. S-Sight cameras guarantee a superior image quality, improved night performance and make an outstanding value for money solution.



DI-380IPS-MVF

40M IR 8MP MOTORIZED VARI-FOCAL LENS DOME/TURRET CAMERA

Equipped with a 2.8-12mm motorized lens, this 8MP Dome/Turret camera is designed for medium distance surveillance (up to 40m) in both indoor and outdoor scenarios.

With its great performances, reliability and affordable price, DI-380IPS-MVF camera is the perfect solution for any basic installation.



MAIN FEATURES

- 8MP
- 3840x2160 Resolution
- 2.8-12mm Motorized Vari-Focal (102.7° - 32.2°)
- 3D-DNR
- IP67
- Audio in + Built in microphone

ANALYTICS

- General Analytics: Camera Tampering
- Standard Analytics: Line Crossing, Sterile Area



SPECIFICATIONS

Image Sensor	1/2.7" CMOS (16:9)
Effective Pixels	3840x2160
Electronic Shutter	1s ~ 1/100000s
Frame Rate	1-20FPS
Day & Night	ICR
Min. Illumination	0.11 lux (@F1.4, AGC ON) 0 lux with IR on
Audio compression	G.711A/G.711U
Communication	One-way Audio
Image Settings	AWB, AGC Adjustable, Exposure Mode (Auto) Sharpness, Saturation, Brightness & Contrast Adjustable
Image Enhancement	Digital WDR, BLC, HLC, ROI
Noise Reduction	3D-DNR
Image Orientation	Mirror/Flip
Privacy Zone	Yes
Motion Detection	Yes
Analytics	General Analytics: Camera Tampering Standard Analytics: Line Crossing, Sterile Area
Video Compression	H.265 / H.264
Resolution	8MP / 6MP / 5MP / 4MP / 2MP / 1MP / D1 / QVGA / CIF
Multi-Stream	Master Stream: 8MP(3840x2160) / 6MP(3072x2048) / 5MP(2592x1944) / 4MP(2560x1440) / 2MP(1920x1080) Sub-Stream: 2MP/1MP/D1/CIF/QCIF Third Stream: 1MP/D1/CIF/QCIF (1~30fps)
Bit rate	64Kbps ~ 8Mbps@H.265 / 64Kbps ~ 8Mbps@H.264
Encode Mode	VBR/CBR
Image Quality	Five levels under VBR; Free adjustment under CBR
IR Distance	40m (3 High Power IR LED)
Lens (Field of View)	2.8-12mm MVF with Auto Focus (102.7°- 32.2°)

SPECIFICATIONS

Iris	Fixed Iris (@F1.4)
Lens Mount	Ø14 Mount
Protection Rate	Water Proof: IP67
Bracket	3-Axis Bracket
Dimensions	Ø113mm×99.6mm
Weight (gross)	~640g
Network	RJ45 (+PoE)
Power	DC Socket
Analog Video Output	No
Audio Connectivity	Built-In Microphone + Audio Input
SD Card	Event/Schedule based Main/Sub-Stream recording (Up to 128Gb)
Hard Reset Button	Yes
Alarm	No
Remote Monitoring	IE Browsing, CMS Software, Provision Cam2 Mobile App
User Access	Supports simultaneous monitoring for up to 4 users with multi-stream real time transmission
Network Protocol	IPv4, IPv6, TCP, UDP, DHCP, NTP, DDNS, 802.1X, RTSP, Multicast, UPnP, Email, FTP, HTTPS, QoS
ONVIF	Yes
Ethernet	100Mbps
PoE	Yes
Power Supply	DC12V/~900mA / PoE/~10W
Work Environment	-30°C~60°C, 10%~90% Humidity
Junction Box	PR-JB14IP66 - PR-JB14IP64 - PR-WB-A

DIMENSIONS

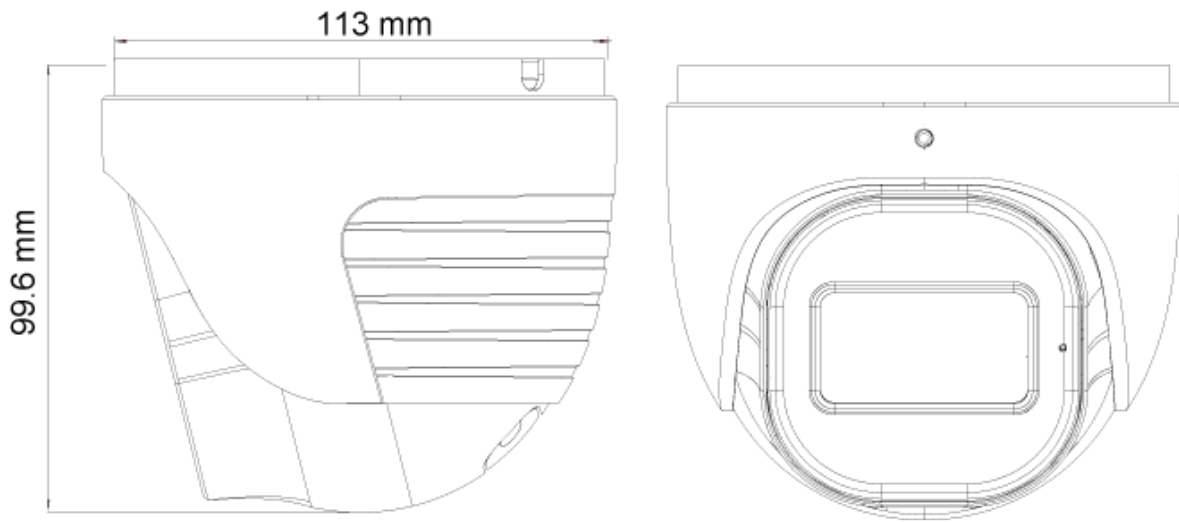

ACCESSORIES



PR-JB14IP66

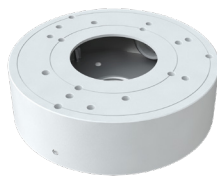

PR-JB14IP64



PR-WB-A



Now you can see!

Hereby appoints

"Media-Security" SRL
Moldova

As our partner to distribute PROVISION-ISR's
products for the year 2021-2022

PROVISION-ISR hereby appoints the above mentioned subject as PROVISION-ISR Authorized Distributor of products specified under the item "Products" in accordance with the PROVISION-ISR Authorized Distributor's Terms and Conditions, and the Authorized Distributor accepts this appointment, PROVISION-ISR grants the Authorized Distributor the rights to act as PROVISION-ISR Authorized Distributor and to promote sales of the "Products".

For and on behalf of
PROVISION-ISR LIMITED

Ari Pick, President
PROVISION-ISR LTD.

Authorized Signature(s)



I.P. "AGENȚIA SERVICII PUBLICE"

Departamentul înregistrare și licențiere a unităților de drept

EXTRAS
din Registrul de stat al persoanelor juridice

nr. 6526 din 18.04.2022

Denumirea completă: **Societatea cu Răspundere Limitată «MEDIA SECURITY».**

Denumirea prescurtată: **«MEDIA SECURITY» S.R.L.**

Forma juridică de organizare: **Societate cu Răspundere Limitată.**

Numărul de identificare de stat și codul fiscal: **1006600023985.**

Data înregistrării de stat: **22.05.2006.**

Sediul: **MD-2005, str. Colina Pușkin, 4, mun. Chișinău, Republica Moldova.**

Modul de constituire: **nou creată.**

Obiectul principal de activitate:

1 Activitatea în domeniul televiziunii și radiodifuziunii;

2 Publicitate;

3 Tipărirea altor publicații (cărți, broșuri etc);

4 Alte activități de servicii prestate întreprinderilor, neincluse în alte categorii;

5 Tipărirea ziarelor;

6 Montarea și (sau) reglarea, asistența tehnică a sistemelor automate de semnalizare și de stingere a incendiilor, precum și de protecție a clădirilor împotriva fumului și de înștiințare în caz de incendiu;

7 Activitatea particulară de detectiv sau de pază.

Capitalul social: **5400 lei.**

Administrator: GAINA VICTOR, IDNP 0961107011088,

Asociați:

1. GAINA VICTOR , IDNP 0961107011088

cota 5400.00 lei, ce constituie 100 %.

Prezentul extras este eliberat în temeiul art. 34 al Legii nr. 220-XVI din 19 octombrie 2007 privind înregistrarea de stat a persoanelor juridice și a întreprinzătorilor individuali și confirmă datele din Registrul de stat la data de: 18.04.2022.

Specialist coordonator
tel. 022-207-840

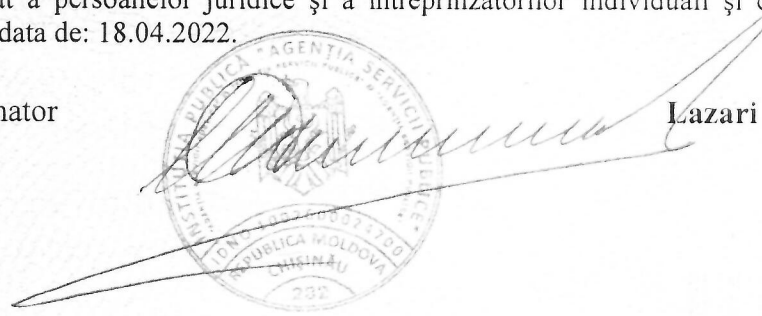
Lazari Aliona

IP S-SIGHT SERIES

Provision-ISR S-SIGHT series provides you with all that you need for a simple installation. S-Sight cameras guarantee a superior image quality, improved night performance and make an outstanding value for money solution.



I4-380IPS-MVF

40M IR 8MP MOTORIZED VARI-FOCAL LENS BULLET CAMERA

Equipped with a 2.8-12mm motorized lens, this 8MP bullet camera is designed for medium distance surveillance (up to 40m) in both indoor and outdoor scenarios.

With its great performances, reliability and affordable price, I4-380IPS-MVF camera is the perfect solution for any basic installation.



MAIN FEATURES

- 8MP
- 3840x2160 Resolution
- 2.8-12mm Motorized Vari-Focal (102.7° - 32.2°)
- 3D-DNR
- IP67
- Audio in

ANALYTICS

- General Analytics: Camera Tampering
- Standard Analytics: Line Crossing, Sterile Area



SPECIFICATIONS

Image Sensor	1/2.7" CMOS (16:9)
Effective Pixels	3840x2160
Electronic Shutter	1s ~ 1/100000s
Frame Rate	1-20FPS
Day & Night	ICR
Min. Illumination	0.11 lux (@F1.4, AGC ON) 0 lux with IR on
Audio compression	G.711A/G.711U
Communication	One-way Audio
Image Settings	AWB, AGC Adjustable, Exposure Mode (Auto) Sharpness, Saturation, Brightness & Contrast Adjustable
Image Enhancement	Digital WDR, BLC, HLC, ROI
Noise Reduction	3D-DNR
Image Orientation	Mirror/Flip
Privacy Zone	Yes
Motion Detection	Yes
Analytics	General Analytics: Camera Tampering Standard Analytics: Line Crossing, Sterile Area
Video Compression	H.265 / H.264
Resolution	8MP / 6MP / 5MP / 4MP / 2MP / 1MP / D1 / QVGA / CIF
Multi-Stream	Master Stream: 4K(3840x2160) / 6MP(3072x2048) / 5MP(2592x1944) / 2K(2560x1440) / 2MP(1920x1080) Sub-Stream: 2MP/1MP/D1/CIF/QCIF Third Stream: 1MP/D1/CIF/QCIF (1~30fps)"
Bit rate	64Kbps ~ 8Mbps@H.265 / 64Kbps ~ 8Mbps@H.264
Encode Mode	VBR/CBR
Image Quality	Five levels under VBR; Free adjustment under CBR
IR Distance	40m (2 High Power IR LED)
Lens (Field of View)	2.8-12mm MVF with Auto Focus (102.7°- 32.2°) @ F1.4

SPECIFICATIONS

Iris	Fixed Iris (F1.4)
Lens Mount	Ø14 Mount
Protection Rate	Water Proof: IP67
Bracket	3-Axis Bracket
Dimensions	220.8x79.4x81.2mm
Weight (gross)	~650g
Network	RJ45 (+PoE)
Power	DC Socket
Analog Video Output	No
Audio Connectivity	Audio Input
SD Card	Event/Schedule based Main/Sub-Stream recording (Up to 128Gb)
Hard Reset Button	Yes
Alarm	No
Remote Monitoring	IE Browsing, CMS Software, Provision Cam2 Mobile App
User Access	Supports simultaneous monitoring for up to 4 users with multi-stream real time transmission
Network Protocol	IPv4, IPv6, TCP, UDP, DHCP, NTP, DDNS, 802.1X, RTSP, Multicast, UPnP, Email, FTP, HTTPS, QoS"
ONVIF	Yes
Ethernet	100Mbps
PoE	Yes
Power Supply	DC12V/~780mA / PoE/~7.4W
Work Environment	-30°C~60°C, 10%~90% Humidity
Junction Box	PR-JB12IP66 - PR-JB12IP64

DIMENSIONS

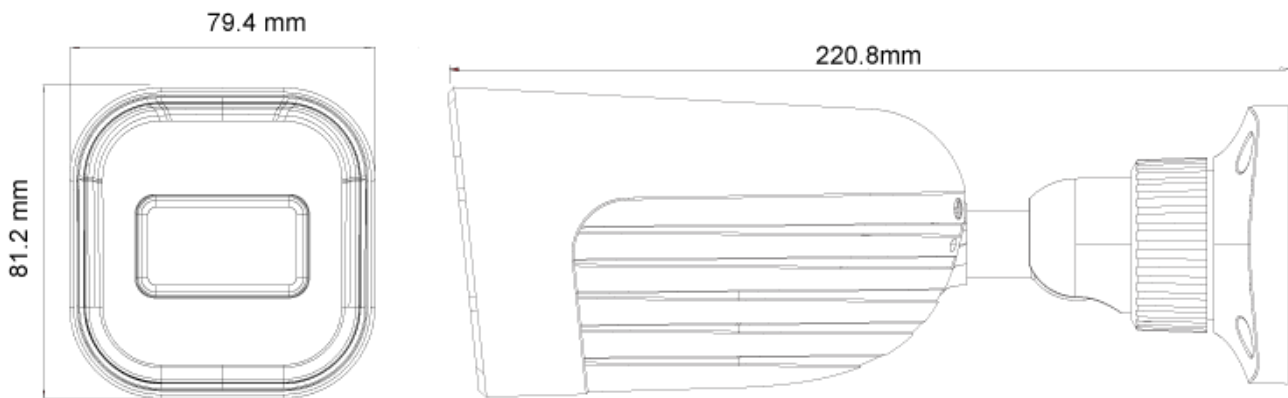

ACCESSORIES



PR-JB12IP66

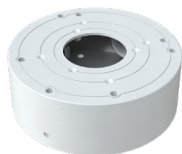

PR-JB12IP64

NVR SERIES

Provision-ISR conventional NVRs are intended for obtaining video streams from the IP cameras via the IP networks for the purpose of their storage and subsequent playback. These devices communicate with the IP cameras through the general network, without the need of direct IP camera connection, providing the installer with the highest flexibility in the design of the system and the wiring.



NVR8-32800RFA(2U)

32CH 8MP FACE RECOGNITION NVR WITH ALARMS AND RAID

Provision-ISR NVR8-32800RFA(2U) is a high performance network video recorder supporting both Face Recognition and Advanced Video Analytics (DDA).

The device, suitable for big-sized installations (up to 32 channels), features 8 alarm inputs + 4 alarm outputs and provides you with everything you need for a trouble-free CCTV project.

All hardware components, including the Raid, are validated to meet the demands for reliable high-definition surveillance.

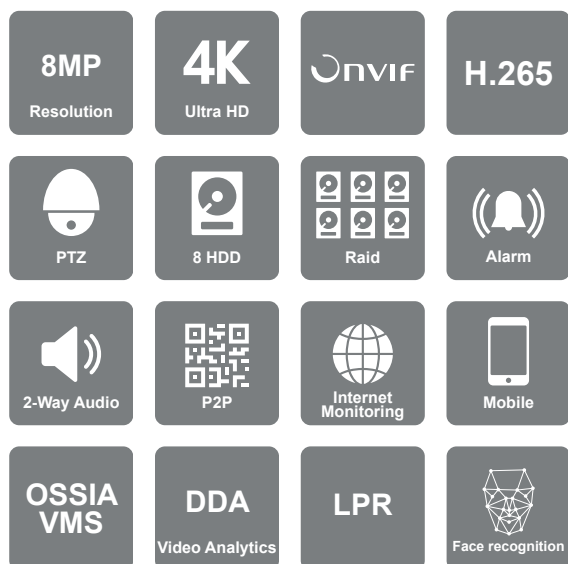

MAIN FEATURES

- Channels: 32
- Video output: HDMI1 (4K, 1080P, 1280X1024) HDMI2+VGA (1080P, 1280X1024) 32CH per monitor
- Max. Recording: 32CH 8MP Real Time
- HDD: 8 SATA (8TB each) with Smart Management
- Alarms: 8 in / 4 out + Depends on Camera
- Audio: In: 1 In RCA + 1 Out RCA + Depends on Camera
- Video Analytics: With IPC cameras
- DDA, Face recognition, LPR and FishEye support



SPECIFICATIONS

	Input	32Ch Over Network
	Output	HDMI1 (4K 30/60Hz, 1080P1280x1024), HDMI2 + VGA (1280x1024, 1080P)
Video	View Mode	Independent, Up to 32ch Per Monitor
	Decoding Format	H.265 / H.265+ / H.265S / H.264
	Decoding Capabilities	1Ch - 8MP ; 4Ch - 2x8MP + 2x5MP ; 9/16Ch - 1MP ; 32Ch - D1
	Input	1CH RCA (Linear, 1kΩ) + IPC Inputs
Audio	Output	1CH RCA (2.0 Vp-p, 1 kΩ) + IPC Inputs
	Compression	G.711A/G.711U
	Two Way Audio	Yes
	Analytics Channels	32Ch (Requires supporting IPC)
Analytics	Supported Analytics	Camera Tampering, Line Crossing (DDA / Pixel Based), Sterile Area (DDA / Pixel Based), Object Monitoring, Object Counting (DDA), Crowd Gathering, People Intrusion, Smart Search, Face Recognition, LPR
	Face Recognition Rate	180 Faces per minute (All Channels) / 3 Faces per second (Single Channel)
Bandwidth	Incoming	256Mbps
	Outgoing	256Mbps
	Real-Time Recording	32CH 8MP Real-Time
Record / Remote App Record/ Main Stream	Record Type	Video / Video + Audio
	8MP	960FPS (NTSC)/800FPS (PAL)
	5MP and lower	960FPS (NTSC)/800FPS (PAL)
	Master stream over network	Up to 32CH@Recording Resolution

SPECIFICATIONS

Sub Stream	Resolution	Depends on IPC
	Sub-Streams over Network	Up to Outgoing Bandwidth Capacity
General	Recording Modes	Schedule, Manual, Motion, Sensor, Analytics, POS and all of its combinations
	User Access	20 Users Online with Professional Authority Management
Record / Remote App	Mobile App	Provision Cam2 for iOS/Android
	PC/Mac Software	Ossia VMS Standard / Enterprise
	Plug-in free Web-Browser	Chrome, FireFox, Safari, Edge, Opera. (All Limited to 4Ch Live View / Playback)
	Plug-in based Web-Browser	Internet Explorer
Playback	Local Playback	16Ch
	Remote Playback (Web, App, VMS)	32Ch
Backup	Search Mode	DDA Object, Smart Search, LPR, Face Recognition, Time-Slice, Time, Event, POS
	USB	2 USB 2.0 Port + 1 USB 3.0 Port
	Backup Format	AVI (Unencrypted) / Private Format (Encrypted / Unencrypted)
Alarm	Input	8+IPC
	Output	4+IPC
Storage	HDD	8
	E-SATA	None
	Max Capacity	64TB (Up to 8TB Each)
	RAID	Yes (0/1/5/6/10)

SPECIFICATIONS

	Connection	Via Network
PTZ	Supported Controls	Pan, Tilt, Zoom, Preset, Cruise, Scan, Iris, Focus
	RS-485	Yes (C06 Keyboard Connection)
Network	Ethernet	2x1000/100/10Mbps self-adaptive Ethernet interface with Fault Tolerance / Dual Network Configuration
	Protocols	TCP/IPv4/IPv6, DHCP, DDNS, NTP, SMTP, SSL/TLS, UPnP, P2P, RTSP, FTP, HTTPS, 820.1X, SNMP, Auto Report (Ossia VMS)
	ONVIF	Full Device Support (Profile T/G, ONVIF Version 20.12)
	Ports	N/A
	Speed	N/A
PoE	Standard	N/A
	CCTV Mode	N/A
	Total Power	N/A
	Max. Power Output (Per Ch.)	N/A
	Power Supply	AC100/240V
Others	Power consumption (No HDD)	15W
	Dimension	W430xD445xH97mm
	Operation Temperature	0-50C

*Max power output will be reduced depending on cable quality and distance.

16 Port 10/100Mbps +2 RJ45 + 2SFP PoE Switch

PoES-16250CL+2G+2SFP



- Downlink: 16x100Mbps Ports
- Uplink: 2x1Gbps Port + 2 SFP
- Color LCD with menu and Enhanced Features
- 250W (Avg:15.6W Max 30W per ch)
- Internal Power Supply
- Distance: Up to 100 Meter
- Built-in Surge Protection
- Complies With IEEE802.3af/at
- Built-in LED for Status Indication
- CCTV mode:
 - Up to 250 meter at 10Mbps
 - Vlan function: no communication among downlink ports
- Rack mount bracket included

Specifications

MODEL	PoES-16250CL+2G+2SFP	
Interface	Downlink Ports	16 x 10/100Mbps
	Uplink Ports	2 x 10/100/1000Mbps
	SFP Ports	2 x 10/100/1000Mbps
PoE	PoE Ports	16
	PoE Standard	IEEE802.3af/at PoE
	PoE Total Power	250W
	Average Power Per Channel	15.6W
	Maximum Power Per Channel	30W
Data Processing	Backbone Bandwidth	11.2Gbps
	Buffer Size	4.1Mb
	MAC Address Table	8K
	VLAN	2 Auto Modes (VLAN / CCTV Modes)
Network Media	EIA/TIA-568	100Ω STP (Maximum 100m)
	10BASE-T	UTP Category 3, 4, 5 Cable (Maximum 100m)
	100BASE-TX	UTP Category 5, 5e Cable (maximum 100m)
	1000BASE-T	UTP Category 5e, 6, 7 Cable (Maximum 100m)
Special	CCTV Mode	Selectable Standard/CCTV Mode
	Surge Protector	Built-In
	Wall Bracket	No
	Rack Bracket	Yes
Power	PoE Status Monitor	Yes
	Power Supply	100-240VAC
	Power Consumption	PoE On: 263W Max. / PoE Off: 13W Max.
Others	Fan	Yes
	Dimensions	440*232*45mm
	Weight	4kg
	Operating Temperature	-10°C~60°C

Work Mode Selection

General Information

Overload Power → 01 OLP ---M531M 08 13.4W ---M928M
 Underload Power → 02 8.4 W ---M921M 09 18.9W 856M856M
 Short-Circuit Protection → 03 ULP ---M---M 10 ---W 238M238M
 Port in use, PoE Only → 04 SCP 125M M 11 OFF ---M---M
 Port in use, PoE + Data → 05 2.2W ---M---M 12 23.3W 323M323M
 → 06 23.7W ---M---M 13 5.8W 983M983M
 → 07 16.8W ---M---M 14 7.3W 223M223M
 Power Bank ← PB: 380W TP: 360.0W PD: 0 Norm Work Mode

Status LCD Monitor