



Speaker Systems

APPLICATIONS

- Band P.A.
- Personal monitor
- Small theatres
- Auditoriums
- Piano bar
- DJ
- Stage monitor
- Conference rooms
- Fixed installations in live clubs
- Pubs
- Gyms

KEY FEATURES

- 2-way processed active system
- Polypropylene enclosure
- 1 x 8" custom woofer
- 1 x 1" neodymium silk dome tweeter
- 150W/40W built-in amplifier cont. RMS LF/HF
- 200W/50W built-in amplifier max. RMS LF/HF
- 400W/100W built-in amplifier max. peak LF/HF
- 2 x M6 suspension points
- Low noise toroidal transformer power supply
- 2 DSP presets
- Available in white color
- Completely manufactured in Italy



Designed, Engineered
and Manufactured in ITALY

PRODUCT DESCRIPTION

The FBT J8A series speakers feature lightweight, yet rugged gas injected molded polypropylene cabinet construction. Available in black or white finish the FBT J8A series speakers modern cabinet appearance provides fixed installations with an elegant design that blends into any decor. The asymmetrical shape of the FBT J8A cabinet also allows use as a powered floor stage monitor. The FBT J8A is of two way design incorporating an 8" low frequency woofer and 1" HF custom compression driver coupled to a 90°H x 60°V horn. The active internal crossover is at a fixed frequency of 2.5kHz. With a frequency range of 60Hz - 20kHz the FBT J8A speakers provide high fidelity sound for both speech and music applications with a maximum SPL of 124dB. A front face steel grille protects the speaker from external damage. The bi-amplified FBT J8A active speaker feature a 200W RMS low frequency amp and a 50W RMS high frequency amp. The control panel features a level control, HP filter switch, mic/line selector, preset switch (original, boost) led power on, protection/limiter led indicators, a balanced XLR and Jack in, a balanced XLR link out. The two M6 fly points built into the cabinet along with the optional mounting brackets allow the FBT J8A speaker to be surface mounted on walls or ceilings. A standard 1,38" speaker stand socket allows the FBT J8A to be mounted on speaker stand.

ELECTRONIC SPECIFICATIONS

System Type	2 Way
Internal amplifiers*	cont.: 150W+40W RMS max.: 200W+50W RMS max peak: 400W+100W
Input Impedance	22 kOhm
Frequency Response	60Hz - 20kHz (@-6dB)
Maximum SPL cont.peak**	120dB / 124dB
Dispersion	90° H x 60°V
Crossover Frequency	2.5kHz
AC Power Requirement	160VA

PHYSICAL SPECIFICATIONS

Low Frequency Woofer	8" / 1.7" coil
High Frequency Driver	1" / 1" coil
Input Connectors	XLR-Jack with loop
Net Dimensions (WxHxD) inch	10.03 x 16.33 x 9.64
Shipping Dimensions (WxHxD) inch	12.99 x 18.89 x 12.59
Net Weight	18.7 lbs
Shipping Weight	21.38 lbs
Enclosure Material	polypropylene
Grille	Steel with powder coat black or white paint finish

* Cont.: 500mS burst, rms power on nominal speaker impedance
Max.: 2mS burst, rms power on nominal speaker impedance
Max peak: based on max peak output voltage and nominal speaker impedance

** Cont. SPL: free space, based on continuous power amp rating and LF transducer average sensitivity data, 125mS time average
Peak SPL: free space, based on max. peak power amp rating and system peak sensitivity, 10mS time average

DIAGRAMS

Horizontal polar diagrams

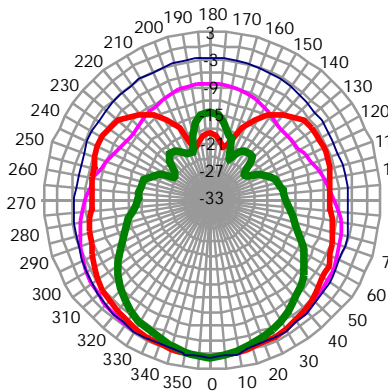

Horizontal polar diagrams

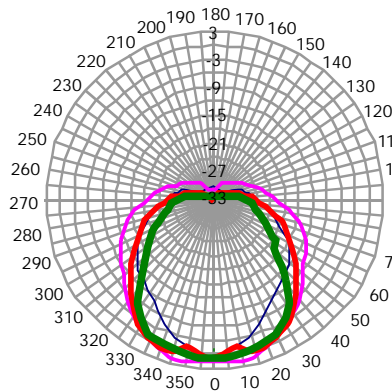

Vertical polar diagrams

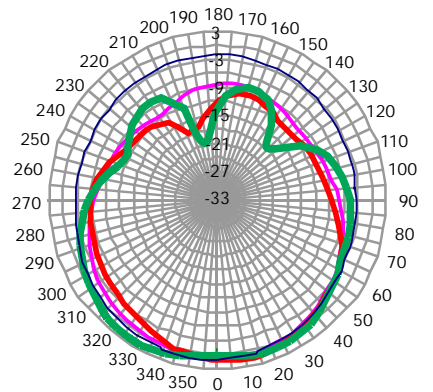

Vertical polar diagrams

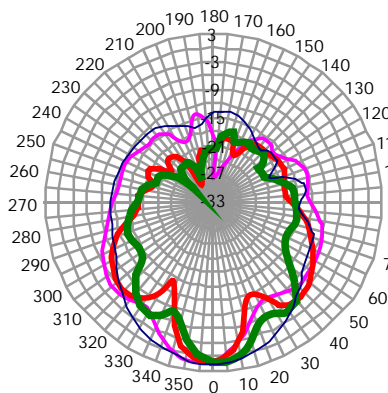
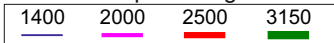

Vertical polar diagrams

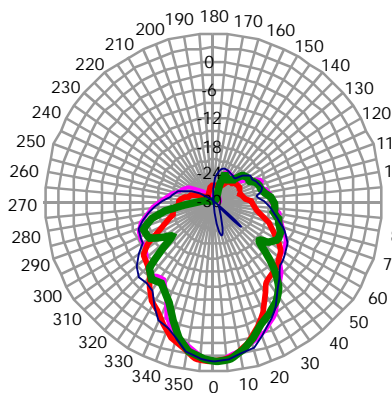
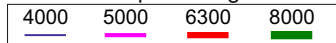

Vertical polar diagrams

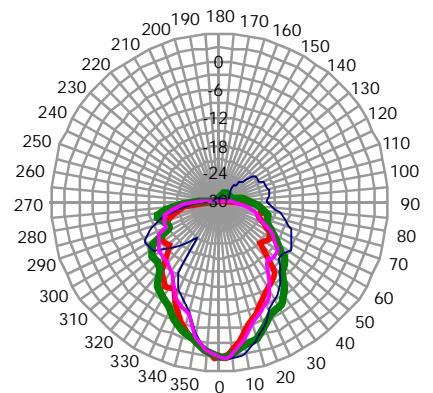
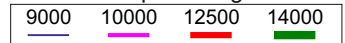

dB SPL FREQUENCY RESPONSE

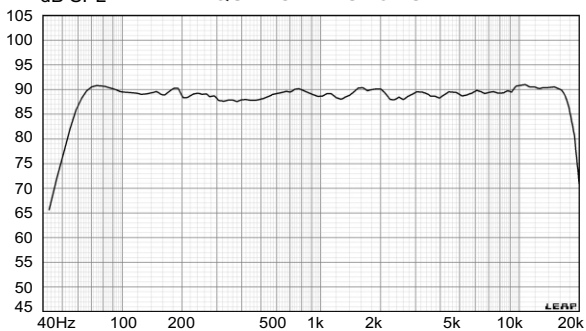

HORIZONTAL BEAMWIDTH (-6dB)

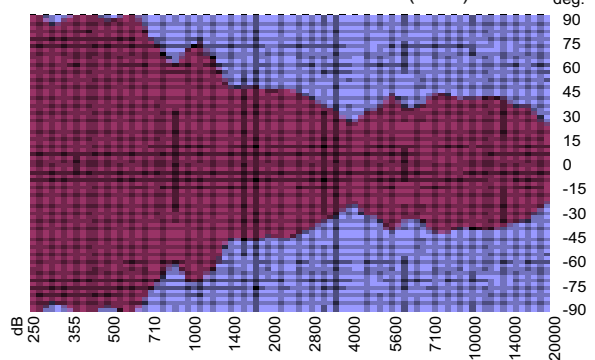

DIMENSIONAL DRAWINGS

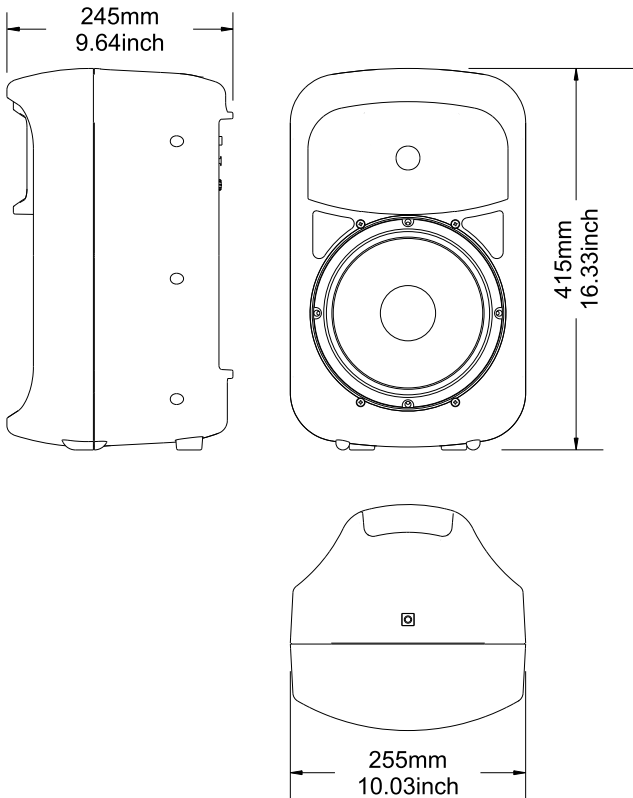

CONTROL PANEL

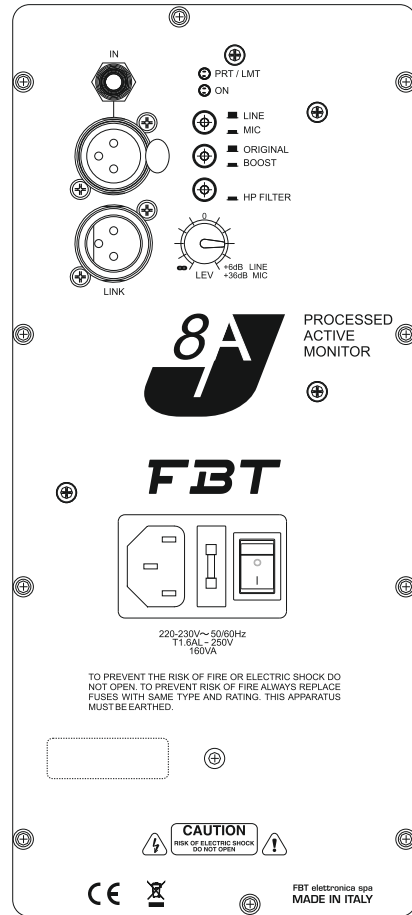

ACCESSORIES

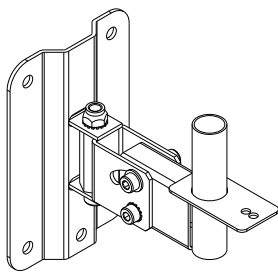

SJ 8
Directional wall mount bracket

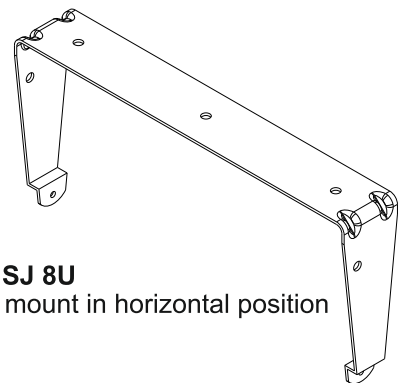

SJ 8U
Wall metal bracket to mount in horizontal position

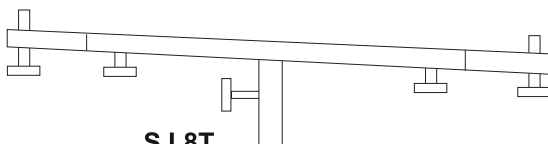

SJ 8T
Adjustable metal "T" stand for No.2 box

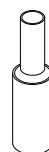

AJ 8
Adapter from Ø1.37inch to Ø0.98inch