

**BeneHeart R300/BeneHeart R30**

**Electrocardiograph**

**Operator's Manual**





© Copyright 2024 Shenzhen Mindray Bio-Medical Electronics Co., Ltd. All rights reserved.

Release time: November 2024

Revision: 3.0

# Intellectual Property Statement

SHENZHEN MINDRAY BIO-MEDICAL ELECTRONICS CO., LTD. (hereinafter called Mindray) owns the intellectual property rights to this Mindray product and this manual. This manual may refer to information protected by copyrights or patents and does not convey any license under the patent rights of Mindray, nor the rights of others.

Mindray intends to maintain the contents of this manual as confidential information. Disclosure of the information in this manual in any manner whatsoever without the written permission of Mindray is strictly forbidden.

Release, amendment, reproduction, distribution, rental, adaption and translation of this manual in any manner whatsoever without the written permission of Mindray is strictly forbidden.

**mindray** and **BeneHeart** are the registered trademarks or trademarks owned by Mindray in China and other countries. All other trademarks that appear in this manual are used only for editorial purposes without the intention of improperly using them. They are the property of their respective owners.

## Responsibility on the Manufacturer Party

Contents of this manual are subject to changes without prior notice.

All information contained in this manual is believed to be correct. Mindray shall not be liable for errors contained herein nor for incidental or consequential damages in connection with the furnishing, performance, or use of this manual.

Mindray is responsible for the effects on safety, reliability and performance of this product, only if:

- all installation operations, expansions, changes, modifications and repairs of this product are conducted by Mindray authorized personnel;
- the electrical installation of the relevant room complies with the applicable national and local requirements;
- the product is used in accordance with the instructions for use.

---

---

### WARNING

---

- **This equipment must be operated by skilled/trained clinical professionals.**
  - **It is important for the hospital or organization that employs this equipment to carry out a reasonable service/maintenance plan. Neglect of this may result in machine breakdown or personal injury.**
- 
-

# Warranty

THIS WARRANTY IS EXCLUSIVE AND IS IN LIEU OF ALL OTHER WARRANTIES, EXPRESSED OR IMPLIED, INCLUDING WARRANTIES OF MERCHANTABILITY OR FITNESS FOR ANY PARTICULAR PURPOSE.

## Exemptions

Mindray's obligation or liability under this warranty does not include any transportation or other charges or liability for direct, indirect or consequential damages or delay resulting from the improper use or application of the product or the use of parts or accessories not approved by Mindray or repairs by people other than Mindray authorized personnel.

This warranty shall not extend to

- Malfunction or damage caused by improper use or man-made failure.
- Malfunction or damage caused by unstable or out-of-range power input.
- Malfunction or damage caused by force majeure such as fire and earthquake.
- Malfunction or damage caused by improper operation or repair by unqualified or unauthorized service people.
- Malfunction of the instrument or part whose serial number is not legible enough.
- Others not caused by instrument or part itself.

## Company Contact

Manufacturer:	Shenzhen Mindray Bio-Medical Electronics Co., Ltd.
Address	Mindray Building, Keji 12th Road South, High-Tech Industrial Park, Nanshan, Shenzhen, 518057, P.R. China
Website	<a href="http://www.mindray.com">www.mindray.com</a>
E-mail Address:	<a href="mailto:service@mindray.com">service@mindray.com</a>
Tel:	+86 755 81888998
Fax:	+86 755 26582680
EC-Representative:	Shanghai International Holding Corp. GmbH (Europe)
Address:	Eiffestraße 80, 20537 Hamburg, Germany
Tel:	0049-40-2513175
Fax:	0049-40-255726

# Notification of Adverse Events

As a health care provider, you may report the occurrence of certain events to SHENZHEN MINDRAY BIO-MEDICAL ELECTRONICS CO., LTD., and possibly to the competent authority of the Member state in which the user and / or patient is established.

These events, include device-related death and serious injury or illness. In addition, as part of our Quality Assurance Program, SHENZHEN MINDRAY BIO-MEDICAL ELECTRONICS CO., LTD. requests to be notified of device failures or malfunctions. This information is required to ensure that SHENZHEN MINDRAY BIO-MEDICAL ELECTRONICS CO., LTD. provides only the highest quality products.

## Preface

### Manual Purpose

This manual contains the instructions necessary to operate the product safely and in accordance with its function and intended use. Observance of this manual is a prerequisite for proper product performance and correct operation and ensures patient and operator safety.

This manual is based on the maximum configuration and therefore some contents may not apply to your product. If you have any question, please contact us.

This manual is an integral part of the product. It should always be kept close to the equipment so that it can be obtained conveniently when needed.

### Intended Audience

This manual is geared for clinical professionals who are expected to have corresponding working knowledge of medical procedures, practices and terminology as required for the treatment of patients.

### Illustrations

All illustrations in this manual serve as examples only. They may not necessarily reflect the setup or data displayed on the equipment.

### Conventions

- *Italic text* is used in this manual to quote the referenced manuals, chapters, sections and formulas.
- **Bold text** is used to indicate the screen texts and names of hard keys.
- → is used to indicate operational procedures.

# Contents

<b>1 Safety</b> .....	<b>1 - 1</b>
1.1 Safety Information .....	1 - 1
1.1.1 Warnings .....	1 - 1
1.1.2 Cautions .....	1 - 2
1.1.3 Notes .....	1 - 2
1.2 Equipment Symbols .....	1 - 3
<b>2 Equipment Overview</b> .....	<b>2 - 1</b>
2.1 Intended Use .....	2 - 1
2.1.1 Intended Purpose Statement .....	2 - 1
2.1.2 Indication for Use .....	2 - 1
2.1.3 Intended Users .....	2 - 1
2.1.4 Intended Patient Population .....	2 - 1
2.1.5 Intended Medical Conditions .....	2 - 1
2.1.6 Contra-indications .....	2 - 1
2.1.7 Side-effects .....	2 - 1
2.1.8 Clinical Benefit .....	2 - 1
2.2 Applied Parts .....	2 - 1
2.3 Main Unit and Connectors .....	2 - 2
2.3.1 Top View .....	2 - 2
2.3.2 Side View .....	2 - 3
2.3.3 Bottom View .....	2 - 4
2.4 Input Devices .....	2 - 4
2.5 Printing Devices .....	2 - 4
<b>3 Equipment Preparation</b> .....	<b>3 - 1</b>
3.1 Equipment Preparation Introduction .....	3 - 1
3.2 Equipment Preparation Safety Information .....	3 - 1
3.3 Equipment Installation .....	3 - 2
3.3.1 Unpacking and Checking .....	3 - 2
3.3.2 Environmental Requirements .....	3 - 2
3.4 Inspection Before Power-On .....	3 - 2
3.4.1 Connecting the AC Power Supply .....	3 - 2
3.4.2 Installing the Battery .....	3 - 2
3.4.3 Loading the Paper .....	3 - 3
3.4.4 Connecting the Patient Cable .....	3 - 5
3.4.5 Connecting the Barcode Reader .....	3 - 5
3.5 Turning on the Equipment .....	3 - 6
3.6 Making Settings for First Use .....	3 - 6
3.7 Main Screen Display .....	3 - 6
3.7.1 On-screen Symbols .....	3 - 7
3.7.2 Menus .....	3 - 8
3.8 General Operations and Settings .....	3 - 8
3.8.1 Using the Hard Keys .....	3 - 8
3.8.2 Setting the Date and Time .....	3 - 9

3.8.3 Adjusting the Screen Brightness .....	3 - 9
3.8.4 Adjusting the Volume .....	3 - 9
3.8.5 Setting the Standby Time .....	3 - 9
3.8.6 Setting the Shutdown Time .....	3 - 10
3.8.7 Enabling Standby .....	3 - 10
3.9 Turning Off the Equipment .....	3 - 10
<b>4 Managing Patients .....</b>	<b>4 - 1</b>
4.1 Entering New Patient Information .....	4 - 1
4.1.1 Manually Inputting Patient Information .....	4 - 1
4.1.2 Reading Patient Information from a Barcode Reader .....	4 - 1
4.2 Editing the Current Patient Information .....	4 - 1
<b>5 Patient Preparation .....</b>	<b>5 - 1</b>
5.1 Patient Preparation Safety Information .....	5 - 1
5.2 Instructing the Patient .....	5 - 1
5.3 Preparing the Skin .....	5 - 2
5.4 Connecting Leadwires with Electrodes .....	5 - 2
5.4.1 Leadwires and Electrodes .....	5 - 2
5.4.2 Leadwires Color Codes .....	5 - 3
5.5 Applying Electrodes .....	5 - 4
5.5.1 Standard 12-Lead Electrode Placement .....	5 - 4
5.5.2 Pediatric Lead Placement .....	5 - 4
5.5.3 Applying Reusable Electrodes .....	5 - 5
5.5.4 Applying Disposable Electrodes .....	5 - 5
5.6 Viewing Reversal Lead Prompt .....	5 - 5
<b>6 Acquiring ECG and Printing Reports .....</b>	<b>6 - 1</b>
6.1 ECG Acquisition Safety Information .....	6 - 1
6.2 Configuring Displayed Waveforms .....	6 - 1
6.3 Acquiring ECG .....	6 - 2
6.3.1 Auto Mode .....	6 - 2
6.3.2 Manual Mode .....	6 - 2
6.3.3 Rhythm Mode .....	6 - 2
6.4 Previewing Reports .....	6 - 3
6.4.1 Transmitting a Report .....	6 - 3
6.4.2 Deleting a Report .....	6 - 3
6.4.3 Printing the Report Preview .....	6 - 3
6.4.4 Exiting the Report Preview .....	6 - 3
6.5 Printing Reports .....	6 - 3
6.5.1 Automatically Printing a Report .....	6 - 4
6.5.2 Printing the Current Report .....	6 - 4
6.5.3 Printing the Latest Report .....	6 - 4
6.5.4 Viewing Printing Status .....	6 - 4
6.5.5 Removing Paper Jam .....	6 - 4
6.5.6 Clearing Printer Errors .....	6 - 4
6.5.7 Stopping Printing .....	6 - 4
6.6 Viewing Printed Reports .....	6 - 5

<b>7 Managing Files .....</b>	<b>7 - 1</b>
7.1 Generating a File .....	7 - 1
7.2 Accessing the History File Window .....	7 - 1
7.3 Searching a File .....	7 - 1
7.4 Reviewing a File .....	7 - 2
7.4.1 Reviewing a Discharged Patient Report .....	7 - 2
7.4.2 Reanalyzing a File .....	7 - 2
7.5 Exporting Files .....	7 - 2
7.6 Deleting Files .....	7 - 2
7.7 Printing Files .....	7 - 3
7.8 Transmitting Files .....	7 - 3
7.9 Exiting the History File Window .....	7 - 3
<b>8 Data Communication .....</b>	<b>8 - 1</b>
8.1 Data Communication Introduction .....	8 - 1
8.2 Data Communication Safety Information .....	8 - 1
8.3 Connecting Networks .....	8 - 1
8.3.1 Connecting the Wired Network .....	8 - 1
8.3.2 Connecting the Wireless Network .....	8 - 2
8.4 Connecting the CMS .....	8 - 2
8.5 Connecting the eGateway .....	8 - 2
8.6 Connecting the NTP Server .....	8 - 2
8.7 Transmitting ECG Reports .....	8 - 2
<b>9 Managing Configurations .....</b>	<b>9 - 1</b>
9.1 Configuration Introduction .....	9 - 1
9.2 Accessing Configuration Management .....	9 - 1
9.3 Selecting Default Configurations .....	9 - 1
9.4 Saving Current Settings .....	9 - 1
9.5 Deleting a Configuration .....	9 - 1
9.6 Exporting Configurations .....	9 - 2
9.7 Importing Configurations .....	9 - 2
9.8 Loading Configurations .....	9 - 2
9.9 Modifying Configuration Management Password .....	9 - 2
<b>10 User Maintenance Settings .....</b>	<b>10 - 1</b>
10.1 User Authorization .....	10 - 1
10.2 Changing Maintenance Settings .....	10 - 1
10.2.1 Device Location Setup Menu .....	10 - 1
10.2.2 Waveform Setup Menu .....	10 - 2
10.2.3 Report Setup Menu .....	10 - 3
10.2.4 Patient Management .....	10 - 5
10.2.5 Print Setup Menu .....	10 - 6
10.2.6 Unit Setup Menu .....	10 - 6
10.2.7 Time Setup Menu .....	10 - 7
10.2.8 Version Information Menu .....	10 - 7

10.2.9 Battery Information Menu .....	10 - 7
10.2.10 Scanner Setup Menu .....	10 - 7
10.2.11 Network Setup Menu .....	10 - 8
10.2.12 Other Setup Menu .....	10 - 11
<b>11 Battery .....</b>	<b>11 - 1</b>
11.1 Battery Introduction .....	11 - 1
11.2 Battery Safety Information .....	11 - 1
11.3 Replacing the Battery .....	11 - 1
11.4 Battery Indications .....	11 - 1
11.4.1 Battery Indicator .....	11 - 1
11.4.2 Battery Symbols .....	11 - 2
11.4.3 Low Battery Prompts .....	11 - 2
11.5 Charging the Battery .....	11 - 2
11.6 Conditioning the Battery .....	11 - 2
11.7 Checking Battery Performance .....	11 - 2
11.8 Recycling Batteries .....	11 - 3
<b>12 Care and Cleaning .....</b>	<b>12 - 1</b>
12.1 Care and Cleaning Introduction .....	12 - 1
12.2 Care and Cleaning Safety Information .....	12 - 1
12.3 Cleaning .....	12 - 1
12.3.1 Cleaning the Main Unit .....	12 - 1
12.3.2 Cleaning the Thermal Print Head .....	12 - 2
12.4 Disinfection .....	12 - 2
12.5 Sterilization .....	12 - 2
12.6 Impact of Improper Cleaning .....	12 - 3
<b>13 Maintenance .....</b>	<b>13 - 1</b>
13.1 Maintenance Introduction .....	13 - 1
13.2 Maintenance Safety Information .....	13 - 1
13.3 Checking Software Information .....	13 - 1
13.4 Maintaining the Main Unit .....	13 - 2
13.4.1 Visual Inspection .....	13 - 2
13.4.2 Thorough Inspection .....	13 - 2
13.4.3 Electrical Safety Tests .....	13 - 2
13.5 Maintaining the Battery .....	13 - 2
13.6 Caring Accessories .....	13 - 2
13.7 Storing Paper Reports .....	13 - 3
<b>14 Accessories .....</b>	<b>14 - 1</b>
14.1 ECG Accessories .....	14 - 1
14.2 Others .....	14 - 2
<b>A Specifications .....</b>	<b>A - 1</b>
A.1 Safety Specifications .....	A - 1
A.1.1 Safety Classifications .....	A - 1

A.1.2 Environmental Specifications .....	A - 1
A.2 Power Supply Specifications .....	A - 2
A.2.1 AC Power Specifications .....	A - 2
A.2.2 Battery Specifications .....	A - 2
A.3 Physical Specifications .....	A - 2
A.4 Hardware Specifications .....	A - 2
A.4.1 Display Screen .....	A - 2
A.4.2 Recorder .....	A - 2
A.4.3 LEDs .....	A - 3
A.4.4 Audio Indicators .....	A - 3
A.4.5 External Connectors .....	A - 3
A.5 Data Storage .....	A - 3
A.6 Wi-Fi Specifications .....	A - 3
A.7 Measurement Specifications .....	A - 4
A.8 Software Operating Environment .....	A - 5
<b>B EMC and Radio Regulatory Compliance .....</b>	<b>B - 1</b>
B.1 EMC .....	B - 1
B.2 Radio Regulatory Compliance .....	B - 5
<b>C Troubleshooting .....</b>	<b>C - 1</b>
C.1 General Problems .....	C - 1
C.2 Messages .....	C - 2
C.2.1 Message 1 .....	C - 2
C.2.2 Message 2 .....	C - 4
<b>D Electrical Safety Inspection .....</b>	<b>D - 1</b>
D.1 Power Cord Plug .....	D - 1
D.2 Device Enclosure and Accessories .....	D - 1
D.2.1 Visual Inspection .....	D - 1
D.2.2 Contextual Inspection .....	D - 1
D.3 Device Labeling .....	D - 2
D.4 Protective Earth Resistance .....	D - 2
D.5 Earth Leakage Test .....	D - 2
D.6 Patient Leakage Current .....	D - 2
D.7 Mains on Applied Part Leakage .....	D - 3
D.8 Patient Auxiliary Current .....	D - 3
<b>E Abbreviations .....</b>	<b>E - 1</b>
<b>F Declaration of Conformity .....</b>	<b>F - 1</b>

**This page intentionally left blank.**

# 1 Safety

---

## 1.1 Safety Information

---

---

### WARNING

---

- Indicates a potential hazard or unsafe practice that, if not avoided, could result in death or serious injury.
- 
- 

### CAUTION

---

- Indicates a potential hazard or unsafe practice that, if not avoided, could result in minor personal injury or product/property damage.
- 

### NOTE

---

- Provides application tips or other useful information to ensure that you get the most from your product.
- 

### 1.1.1 Warnings

---

---

#### WARNING

---

- This equipment is not intended for direct cardiac application.
- This equipment is used for single patient at a time.
- The equipment is not intended to be used within the Magnetic Resonance (MR) environment.
- This equipment must be operated by skilled/trained clinical professionals.
- To avoid explosion hazard, do not use the equipment in the presence of oxygen-rich atmospheres, flammable anesthetics, or other flammable agents (such as gasoline). Keep the equipment and the operating environment dry and clean.
- Before putting the system into operation, the operator must verify that the equipment, connecting cables and accessories are in correct working order and operating condition.
- To avoid risk of electric shock, the equipment must only be connected to mains power with protective earth. If a protective earth conductor is not provided, operate it on battery power, if possible.
- Do not use the multiple portable socket outlets (MPSO) or AC mains extension cords. Insure that the sum of the individual ground leakage currents does not exceed the allowable limits.
- Do not disassemble the equipment. It contains no operator serviceable components and dangerous high voltages may be present. Contact authorized service personnel for repair.
- Do not touch the patient when connecting peripheral equipment via the I/O signal ports to prevent patient leakage current exceeds the requirements of applicable standards.
- This equipment is not intended for use with high frequency surgical units.
- The equipment and accessories shall not be served or maintained while in use with a patient.
- Do not contact the patient during defibrillation. Otherwise serious injury or death could result.
- For paced patients, the equipment may mistake a pace pulse for a QRS complex if several adverse conditions exist simultaneously. Always keep these patients under close surveillance.
- The physiological data and waveforms displayed on the equipment are for reference only and cannot be directly used for diagnostic interpretation.

- To avoid electric shock or equipment malfunction, liquids is not allowed to enter the equipment. If liquids have entered the equipment, remove the equipment from use and have it checked by service personnel before it is used again.
  - Place and secure cables and tubings carefully to prevent from stumbling, entanglement and patient strangulation.
  - The software equipment copyright is solely owned by Mindray. No organization or individual shall resort to modifying, copying, or exchanging it or to any other infringement on it in any form or by any means without due permission.
  - When disposing of the packaging material, be sure to observe the applicable waste control regulations and keep it out of children's reach.
  - Do not touch the patient and live parts simultaneously.
- 

## 1.1.2 Cautions

---

### CAUTION

---

- Only use parts and accessories specified in this manual. Follow the instructions for use and adhere to all warnings and cautions.
  - At the end of its service life, the equipment, as well as its accessories, must be disposed of in compliance with the guidelines regulating the disposal of such products. If you have any questions concerning disposal of the equipment, please contact us.
  - Magnetic and electrical fields are capable of interfering with the proper performance of the equipment. For this reason make sure that all external devices operated in the vicinity of the equipment comply with the relevant EMC requirements. Mobile phone, X-ray equipment or MRI devices are a possible source of interference as they may emit higher levels of electromagnetic radiation.
  - Before connecting the equipment to the external power supply, check that the voltage and frequency ratings are the same as those indicated on the equipment's label or in this manual.
  - Always install or carry the equipment properly to avoid damage caused by drop, impact, strong vibration or other mechanical force.
- 

## 1.1.3 Notes



























---

### NOTE



---

- The equipment use a mains plug as isolation means to the mains power. Do not locate the equipment in a place difficult to operate the mains plug.
  - Put the equipment in a location where you can easily view and operate the equipment.
  - In normal use, the operator is expected to be in front of the equipment.
  - Keep this manual in the vicinity of the equipment so that it can be obtained conveniently when needed.
  - The software was developed in compliance with IEC62304.
  - This manual includes information related to all features of the equipment. Some features may not be available on your equipment.
-

## 1.2 Equipment Symbols

	Refer to instruction manual/booklet		General warning sign
	Stand-by		"ON" for part of equipment
	Manufacturer		Date of manufacture
	Alternating current		Battery indicator
	DEFIBRILLATION-PROOF TYPE CF APPLIED PART		Serial number
	Equipotentiality	<b>IP20</b>	Protected against solid foreign objects of 12.5 mm and greater
	USB connector		Computer network
	Medical Device		Unique Device Identifier
	Stacking limit by number		Keep dry
	This way up		Fragile; handle with care
	Humidity limitations		Atmospheric pressure limitations
	Temperature limitations		Non-ionizing electromagnetic radiation
	General symbol for recovery/recyclable	<b>REF</b>	Catalogue number
	Authorised representative in the European Community		
	<p>The product bears CE mark indicating its conformity with the provisions of the REGULATION (EU) 2017/745 on medical devices and fulfills the general safety and performance requirements of Annex I of this regulation.</p> <p>Note: The product complies with the Council Directive 2011/65/EU.</p>		
	<p>The following definition of the WEEE label applies to EU member states only.</p> <p>This symbol indicates that this product should not be treated as household waste. By ensuring that this product is disposed of correctly, you will help prevent bringing potential negative consequences to the environment and human health. For more detailed information with regard to returning and recycling this product, please consult the distributor from whom you purchased it.</p> <p>* For system products, this label may be attached to the main unit only.</p>		

The general meaning assigned to geometric shapes, safety colors and contrast colors for safety signs are as follows:

<b>Geometric shape</b>	<b>Meaning</b>	<b>Safety color</b>	<b>Contrast color</b>	<b>Graphical symbol color</b>
	Mandatory action	Blue	White	White
	Warning	Yellow	Black	Black

# 2 Equipment Overview

---

## 2.1 Intended Use

### 2.1.1 Intended Purpose Statement

The equipment is intended for clinical electrocardiographic diagnosis and study.

### 2.1.2 Indication for Use

The equipment is intended to acquire, analyze, display, store, and record electrocardiographic information for adult and children of any age from birth upwards for clinical diagnosis and study.

### 2.1.3 Intended Users

The equipment must be used by clinical professionals or under their guidance. It must only be used by persons who have received adequate training in its use. Anyone unauthorized or untrained must not perform any operation on it.

### 2.1.4 Intended Patient Population

The equipment can be used in both adult, pediatric and neonatal patients.

### 2.1.5 Intended Medical Conditions

The equipment is for use in hospital and other professional medical institutions.

### 2.1.6 Contra-indications

None.

### 2.1.7 Side-effects

None.

According to the conclusion of clinical evaluation and residual risk evaluation, for the intended patients, there is no known side effects that can occur during or after the use of the medical device. And there is no need for the operator to make extra preparations. Thus, no residual risk associated with using the medical device should be disclosed.

### 2.1.8 Clinical Benefit

The clinical benefit using the equipment to complete an ECG test is assisting the medical professionals in diagnosis and evaluation of patient's heart conditions in a non-invasive, cost-effective, and fast-enough way.

## 2.2 Applied Parts



The applied parts of the equipment are:

- ECG electrodes
- Patient cable

## 2.3 Main Unit and Connectors

### 2.3.1 Top View



- (1) Display screen
- (2) Recorder
- (3) Power switch
  - ◆ When powered on, press it to turn on the equipment.
  - ◆ When turned on, press and hold it for 3 seconds to turn off the equipment.
- (4) Indicators:
  - Power-on indicator 
    - ◆ Illuminated: the equipment is turned on.
    - ◆ Off: the equipment is turned off.
  - AC power indicator 
    - ◆ Illuminated: the AC power is connected.
    - ◆ Off: the AC power is not connected.
  - Battery indicator 
    - ◆ Steady green: the battery is fully charged.
    - ◆ Flashing green: the equipment operates on battery power.
    - ◆ Steady orange: the battery is being charged.
    - ◆ Flashing orange: the battery fails.
    - ◆ Off: the battery is not installed.

#### Hard keys

Hard keys are located on the front panel, used for operating the screen, inputting information or acquiring an ECG. For details on using hard keys, see 3.8.1 *Using the Hard Keys*.

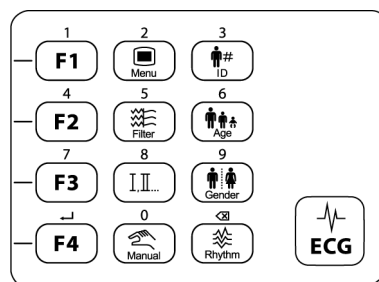

The following table lists all hard keys on the equipment.

Label	Description
0 to 9	Numeric key. When inputting the age, press it to input a corresponding number.
←	When inputting information, press it to confirm the entry.
✕	When inputting information, press it to delete the previous character.
F1 to F4	Function key. Press it to perform a operation corresponding with option on the screen at the left side.
Menu	<ul style="list-style-type: none"> <li>Accesses the main menu.</li> <li>Exits the main menu or the current menu.</li> </ul>
Filter	Switches the frequency of muscle artifact filter in the Auto mode.
Lead	Switches the leads to be recorded in the Manual mode.
Manual	Starts or stops acquiring an ECG in the Manual mode.
ID	Opens the <b>ID</b> window, and the cursor is switched to the textbox of patient ID.
Age	The cursor is switched to the patient age on the main screen.
Gender	Switches the patient gender.
Rhythm	Starts or stops acquiring a rhythm ECG.
ECG	Starts or stops acquiring an ECG.

### 2.3.2 Side View

The following pictures are right, back and left views of the equipment from left to right.

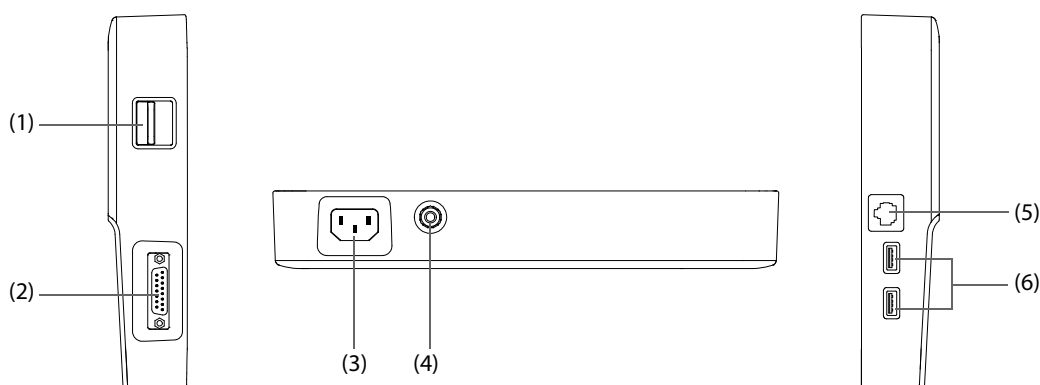

- (1) Recorder door latch: opens the recorder door.
- (2) Patient cable connector: connects the patient cable for ECG acquisition.
- (3) AC power input
- (4) Equipotential grounding terminal  
When the equipment and other devices are to be used together, their equipotential grounding terminals should be connected together to eliminate the potential difference between them.
- (5) Network connector: is a standard RJ45 connector which connects the equipment to the central monitoring system (CMS) or other network devices.
- (6) USB connector: connect USB devices, for example USB drive or barcode reader.

### 2.3.3 Bottom View

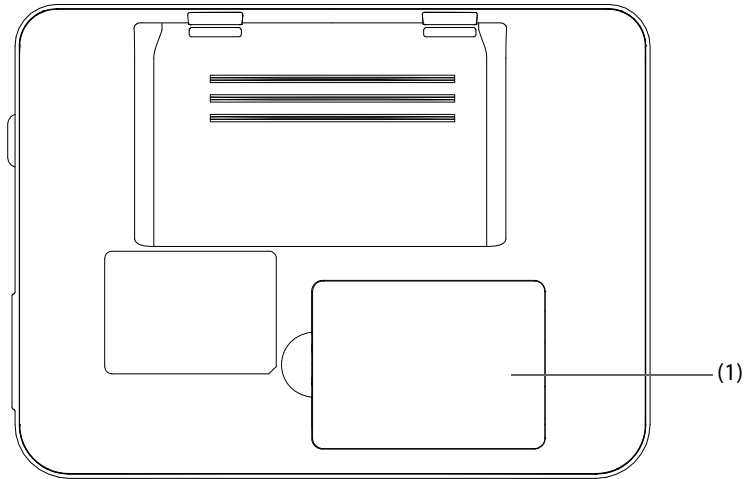

(1) Battery compartment: stores the battery.

## 2.4 Input Devices

The equipment allows data entry through hard key and barcode reader. You can only use Mindray specified input devices.

## 2.5 Printing Devices

You can use a build-in recorder to print patient report. When the equipment is connected to a Mindray specified printer through networks, you can also use the printer for printing.

# 3 Equipment Preparation

---

## 3.1 Equipment Preparation Introduction

Before putting the equipment in use, you should be thoroughly familiar with operations, and get your equipment well prepared and configured.

## 3.2 Equipment Preparation Safety Information

---

### WARNING

---

- Use only installation accessories specified by Mindray.
  - Connect only approved devices to this equipment. Devices connected to the equipment must meet the requirements of the applicable IEC standards (e.g. IEC 60950 safety standards for information technology equipment and IEC 60601-1 safety standards for medical electrical equipment). The system configuration must meet the requirements of the IEC 60601-1 medical electrical systems standard. Any personnel who connect devices to the equipment's signal input/output port are responsible for providing evidence that the safety certification of the devices has been performed in accordance to the IEC 60601-1. If you have any questions, please contact Mindray.
  - The equipment and accessories connected to the equipment are suitable for use within the patient environment. For other devices and accessories connected to the equipment, consult corresponding manufacturers for the suitability within the patient environment.
  - If it is not evident from the equipment specifications whether a particular combination with other devices is hazardous, for example, due to summation of leakage currents, please consult the manufacturer or an expert in the field. A determination must be made that the proposed combination will not negatively affect the devices themselves or the patient's safety.
  - Loss of power may result in an unacceptable risk. The equipment should be connected to a required power source.
  - The mains plug is used to isolate the equipment circuits electrically from the AC power. Do not position the equipment so that it is difficult to operate the plug.
  - If the accuracy of any value displayed on the equipment, or printed on a report is questionable, determine the patient's conditions by alternative means. Verify that all equipment is working correctly.
- 

### CAUTION

---

- The equipment should be installed by authorized Mindray personnel.
  - When disposing of the packaging material, be sure to observe the applicable waste control regulations and keep it out of children's reach.
  - Before use, verify whether the packages are intact, especially the packages of single use accessories. In case of any damage, do not apply it to patients.
  - Make sure that the equipment operating environment meets the specific requirements. Otherwise unexpected consequences, e.g. damage to the equipment, could result.
- 

### NOTE

---

- Put the equipment in a location where you can easily view and operate the equipment.
  - Save the packing case and packaging material as they can be used if the equipment must be reshipped.
-

### 3.3 Equipment Installation

The equipment can be installed on a trolley or placed on the table.

#### 3.3.1 Unpacking and Checking

Before unpacking, examine the packing case carefully for signs of damage. If any damage is detected, contact the carrier or us.

If the packing case is intact, open the package and remove the equipment and accessories carefully. Check all materials against the packing list and check for any mechanical damage. Contact us in case of any problem.

#### 3.3.2 Environmental Requirements

The operating environment of the equipment must meet the requirements specified in this manual.

The environment where the equipment is used shall be reasonably free from noises, vibration, dust, corrosive, flammable and explosive substances. If the equipment is installed in a cabinet, sufficient space in front and behind shall be left for convenient operation, maintenance and repair. Moreover, to maintain good ventilation, the equipment shall be at least 2 inches (5cm) away from around the cabinet.

When the equipment is moved from one place to another, condensation may occur as a result of temperature or humidity difference. In this case, never start the system before the condensation disappears.

### 3.4 Inspection Before Power-On

#### 3.4.1 Connecting the AC Power Supply

The equipment can operate on the AC power supply.

To connect the equipment to the AC power supply, follow this procedure:

1. Connect one end of the power cord to the AC power input of the equipment.
2. Connect the other end of the power cord with a AC power outlet. Check that the AC power indicator is illuminated.

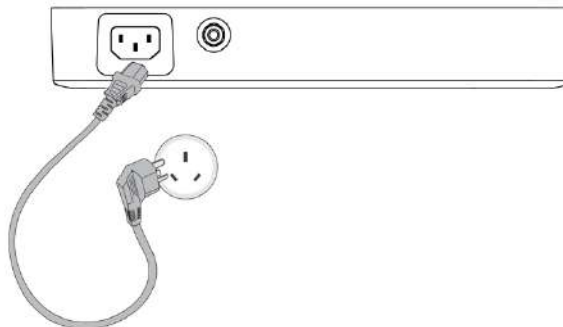

---

#### WARNING

---

- **Always use the accompanying power cord delivered with the equipment.**
  - **Before connecting the equipment to the power supply, check that the voltage and frequency ratings are the same as those indicated beside the power input of the equipment.**
  - **Connect the power cord to the AC power input of the equipment and plug it into place. Make sure the power cord is properly connected.**
  - **Use the battery if the integrity of the protective earth conductor or the protective earthing system in the installation is in doubt.**
- 

#### 3.4.2 Installing the Battery

The equipment can operate on the battery power when the AC power supply is not available. For details on installing the battery, see *11.3 Replacing the Battery*.

### 3.4.3 Loading the Paper

A built-in recorder is used for printing reports. Either rolled or folded paper can be loaded on the recorder. The paper used must be consistent with the setting of **Paper Type**. Otherwise, **Paper Type Error** is displayed during the printing. The setting of **Paper Type** can be changed in the **Maintenance** menu only. For more information, see *10.2.5 Print Setup Menu*.

You should make sure the paper is loaded before printing.

The following figure shows the internal structure of the recorder.

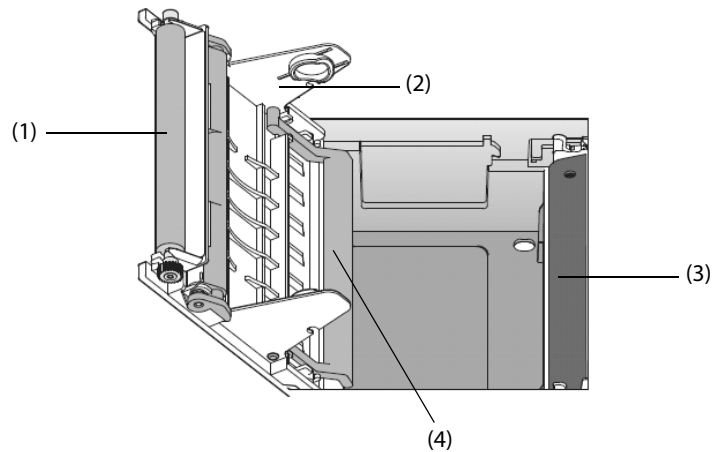

- |                        |                         |
|------------------------|-------------------------|
| (1) Platen             | (2) Paper roll holder   |
| (3) Thermal print head | (4) Paper jam protector |

#### NOTE

- **Use only specified thermal paper. Using other paper may result in print head wearing out prematurely or printing of poor quality.**
- **Make sure sufficient, but no more than one stack of recorder paper is available in the paper tray. Otherwise, paper jam may occur.**

#### 3.4.3.1 Loading Rolled Paper

To load rolled paper, follow this procedure:

1. Press down the recorder door latch to open the recorder door.

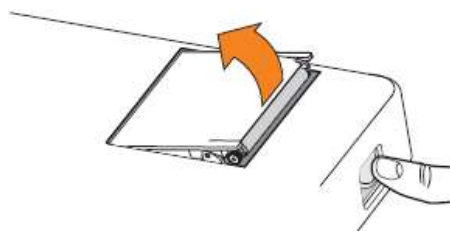

2. Check that the paper jam protector is released from the little openings at the bottom of the paper roll holder.

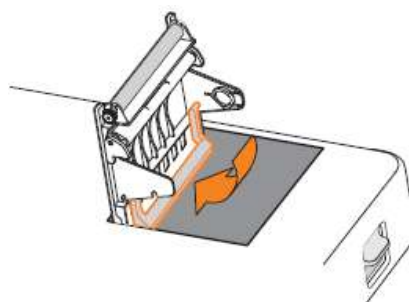

3. Insert a new paper roll, with the print side (grid side) facing the thermal print head, into the paper roll holder on the recorder door.

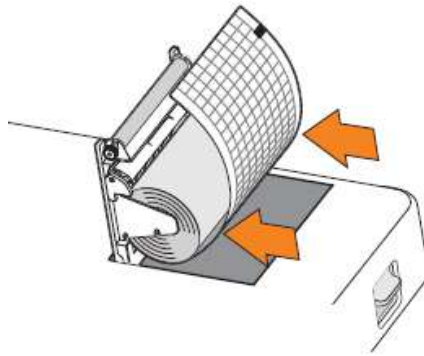

4. Unroll the beginning of the paper and close the recorder door.
5. Overlap the unrolled paper on the recorder door. Make sure the grid side is facing up.

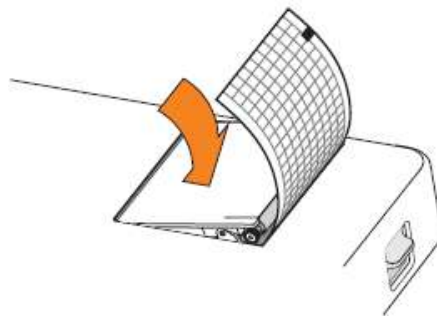

### 3.4.3.2 Loading Folded Paper

To load folded paper, follow this procedure:

1. Press down the recorder door latch to open the recorder door.

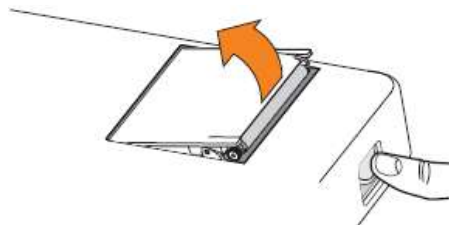

2. Place the folded paper pack into the paper compartment.

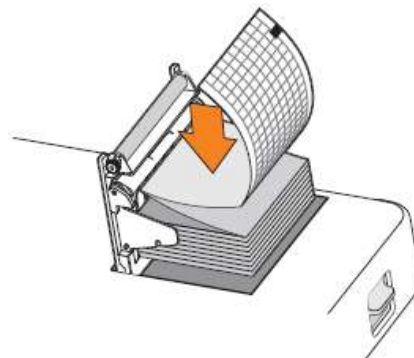

3. Lift the paper jam protector and click it into the little openings at the bottom of the paper roll holder.

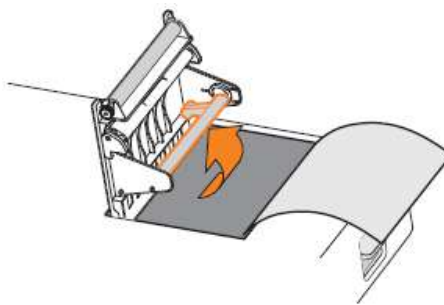

4. Unfold the first page of the folded paper pack. Make sure the print side (grid side) faces the thermal print head. Close the recorder door.
5. Overlap the unfolded paper on the recorder door. Make sure the grid side is facing up.

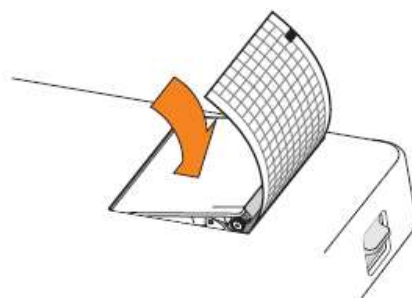

### 3.4.4 Connecting the Patient Cable

To connect the patient cable, follow this procedure:

1. Connect the patient cable to the patient cable connector of the equipment.
2. Tight the screws to securely attach the patient cable to the equipment.

### 3.4.5 Connecting the Barcode Reader

A barcode reader can be used for read patient ID.

If the equipment is configured with a barcode reader, you can connect it to USB connector of the equipment. You should configure the barcode reader before use. For more information, see *10.2.10 Scanner Setup Menu*.

If the Mindray-customized 2D barcode reader is used, you should clear previous data formats before configuring the barcode reader. To do, follow this procedure:

1. Scan the engineering barcode to clear the previous data format.
2. Scan the 2D engineering barcode which contains your hospital's data format.

#### NOTE

- You can use the Mindray-customized barcode reader to scan both 2D and 1D barcodes. Using other barcode readers can only output the patient's medical record number (MRN) and visit number.
- Contact the scanner manufacturer or Mindray to obtain the engineering barcodes for clearing data formats and obtaining the hospital's data format.

### 3.5 Turning on the Equipment

Before turning on the equipment, perform the following inspections:

1. Check the equipment for any mechanical damage. Make sure that the patient cable is properly connected.
2. Connect the equipment to the AC power supply. Make sure the battery power is sufficient if the equipment is powered by the battery.

Press the power switch to turn on the equipment. After the start-up screen is displayed, the equipment automatically enters the main screen.

---

#### CAUTION

- **Do not use the equipment on a patient if you suspect it is not working properly, or if it is mechanically damaged. Contact the service personnel or Mindray.**
- 

### 3.6 Making Settings for First Use

Before putting the equipment into use for the first time, you should make settings for the equipment. Otherwise, the equipment cannot be started.

To make settings for first use, follow this procedure:

1. Turn on the equipment. The equipment automatically display the **Basic Setup** menu.
2. Select the system language, and then select **Next**.
3. Select the system date and time, and then select **Next** to turn to the **Network Setup** menu. For details about the setup, see *3.8.2 Setting the Date and Time*.
4. Make network settings, and then press the **F1** hard key to return to the **Basic Setup** menu. For details about the setup, see *10.2.11 Network Setup Menu*.
5. Set **Notch Frequency** and **ECG Standard**. For details about the setup, see *10.2.2.2 Filter Setup Tab* and *10.2.2.3 Lead Setup Tab*.
6. Select **Next**, and then restart the equipment.

---



#### NOTE

- **If you do not complete settings for all items except network settings, the equipment will not save the settings and still display the Basic Setup menu for next startup.**
- 

### 3.7 Main Screen Display

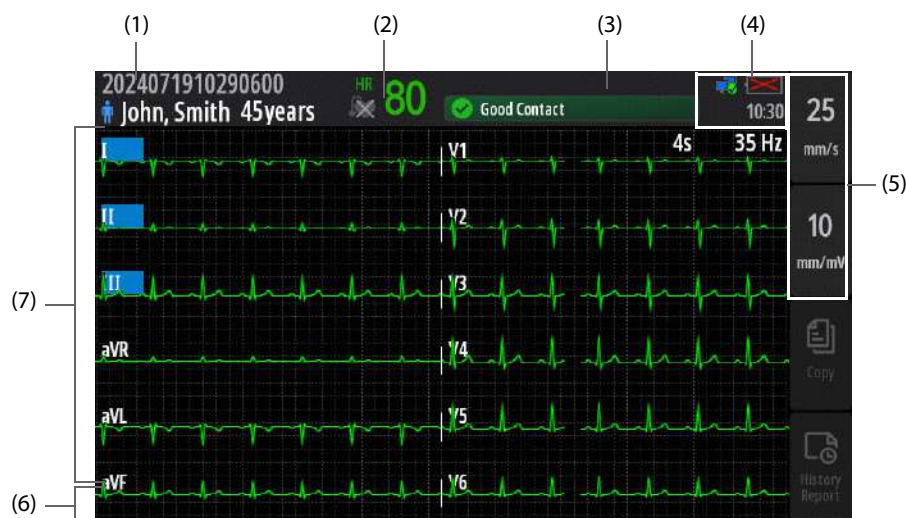











The following figure shows the main screen display.



- (1) Patient information area: displays gender icon, patient name, patient ID and age by default.
- (2) Patient status area: displays HR value and paced status.
  - If pacemaker pulses are detected,  is displayed.
  - If no pacemaker pulses are detected,  is displayed.
- (3) Message area: displays Message 1 in top row and Message 2 in bottom row.  
For more information, see *C.2 Messages*.
- (4) System information area: displays the network status, battery status and system time. For more information, see *3.7.1 On-screen Symbols*.
- (5) Waveform setup area: sets waveforms to be displayed and acquired. For more information, see *6.2 Configuring Displayed Waveforms*.
- (6) Pacemaker pulse marker area: when **Paced** is set to **Yes** or **Unspecified** and pacing signals are detected, displays pacemaker pulse marker and corresponding lead label.
- (7) Waveform area: displays waveforms and lead labels.

### 3.7.1 On-screen Symbols

The following table lists the on-screen symbols.

Symbol	Description	Symbol	Description
	Male (with a blue background)		Female (with a pink background)
	Unspecified gender (with a white background)		No battery is installed.
	The battery works correctly. The green portion represents the remaining charge.		The battery is being charged.
	The battery has low power and needs to be charged.		The battery has critically low charge and needs to be charged immediately. Otherwise, the equipment will soon automatically shut down.
	Wired network is connected.		Wired network is not connected.
	Wireless network is connected. The solid part indicates network signal strength.		Wireless network is not connected.

### 3.7.2 Menus

All menus of the equipment have similar a style and structure. The following figure shows the **Maintenance** menu:

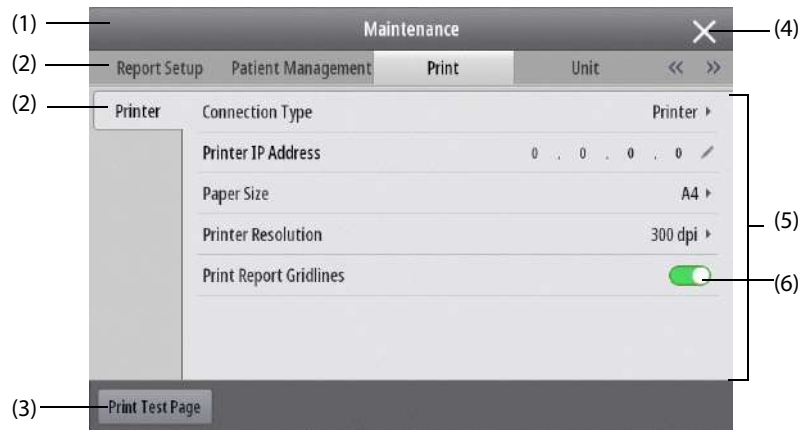









- (1) Menu heading: summarizes functions of the current menu.
- (2) Submenu tabs: provides an access to a submenu.  
Selecting << or >> can turn the tab pages.
- (3) Operation key: performs the corresponding operation.
- (4) Exit key: closes the current menu.
- (5) Main body area: displays the current menu items and options.
- (6) Switch:
  - ◆ Green: the item is switched on.
  - ◆ Grey: the item is switched off.

## 3.8 General Operations and Settings

### 3.8.1 Using the Hard Keys

In the this section, the **Maintenance** menu is taken as an example to describe how to display the menu, input information and change settings by using hard keys.

To do so, follow this procedure:

1. Press  to access the main menu.
2. Press the **F2** or **F3** hard key to move the cursor on **Maintenance**, and press the **F4** hard key for confirmation.
3. Move the cursor on a desired character, and press the **F4** hard key for confirmation.
4. Repeat step 3 until the password entry is completed.
5. If needed, input information.
  - ◆ Select one character after another for the entry.
  - ◆ Select  to show or  to hide the password entry.
  - ◆ Select  to delete the previous character or select  to clear the entire entry.
  - ◆ Select  to switch between uppercase and letters.
  - ◆ Select  to confirm the entry.
6. Move the cursor on a desired submenu tab, and press the **F4** hard key to display the submenu. Selecting << or >> can turn the tabs.
7. If the submenu contains more than one page, move the cursor on the scroll bar to display , press the **F4** hard key to display , and then press the **F2** or **F3** hard key scroll up or down.
8. Move the cursor on a desired character, and press the **F4** hard key for confirmation.

9. Change settings.
  - ◆ Move the cursor on a desired switch, press the **F4** hard key, and then press the **F4** hard key to switch it on or off.
  - ◆ Move the cursor on a menu item, press the **F4** hard key to display all setting items, then move the cursor on a desired setting item, and finally press the **F4** hard key for confirmation.

### 3.8.2 Setting the Date and Time

Before putting the equipment into use for the first time, you should set the time zone and system time in accordance with your local time.

To set the system date and time, follow this procedure:

1. Press  to access the main menu.
2. Select **Time** from the **System** column.
3. Set the system date.
  - ◆ **Date Format**: sets the system date format.
  - ◆ **Date**: sets the system date.
4. Set the system time.
  - ◆ **24-Hour Time** switch: if the 12-hour mode is needed, switch it off.
  - ◆ **Time**: sets the system time.
5. Set the **Daylight Savings Time** switch. If the daylight savings time is needed, switch it on.

If your equipment is connected to the NTP server, the date and time are automatically taken from the NTP server. In this case, you cannot change the date and time from your equipment. For more information about the connection, see 8.4 *Connecting the CMS* and 8.6 *Connecting the NTP Server*.

---

#### CAUTION

---

- **Changing the date and time affects the stored files and may result in loss of data.**
- 

### 3.8.3 Adjusting the Screen Brightness

To adjust the screen brightness, follow this procedure:

1. Press  to access the main menu.
2. Select **Display** from the **Device** column.
3. Set the screen brightness.
  - ◆ **Brightness**: applicable when AC power supply is used to run the equipment.
  - ◆ **Brightness On Battery**: applicable when a battery is used to run the equipment.

### 3.8.4 Adjusting the Volume

To adjust the system volume, follow this procedure:

1. Press  to access the main menu.
2. Select **Audio** from the **Device** column.
3. Set **Reminder Tone** and **QRS Volume**.

### 3.8.5 Setting the Standby Time

To set the standby time, follow this procedure:

1. Press  to access the main menu.
2. Select **Display** from the **Device** column.
3. Set **Auto Standby**.

### 3.8.6 Setting the Shutdown Time

To set the shutdown time, follow this procedure:

1. Press  to access the main menu.
2. Select **Display** from the Device column.
3. Set **Auto Shut Down**.

### 3.8.7 Enabling Standby

To reduce power consumption and extend the service life of display screen, you can enable standby.

When the preset standby time is reached, the equipment automatically disables the screen display and accesses the standby status in the following conditions:

- Limb lead off
- No operations taken using hard keys
- No operations taken for acquiring or printing ECG

For details on setting the standby time, see *3.8.5 Setting the Standby Time*.

When either ECG signal or information from the barcode reader is received, the equipment automatically exits the standby status. To exit the standby status, press any hard key on the equipment.

## 3.9 Turning Off the Equipment

Before turning off the equipment, perform the following checks:

1. Ensure that the patient measurement and recording have been is completed.
2. Disconnect the electrodes from the patient.

Press and hold the power switch for 3 seconds, "**System is shutting down...**" is displayed, and then the equipment will shut down in 10 seconds.

Turning off the equipment does not disconnect the equipment from the AC power supply. To completely disconnect the power supply, unplug the power cord.

When the preset shutdown time is reached, the equipment automatically shuts down in the following conditions:

- Limb lead off
- No operations taken using hard keys
- No operations taken for acquiring or printing ECG

The auto shutdown function is disabled by default. To enable this function, you need to set **Auto Shut Down**. For more information, see *3.8.6 Setting the Shutdown Time*.

---

### CAUTION

- **Press and hold the power switch for 10 seconds to forcibly shut down the equipment if it could not be shut down normally. This may cause loss of patient data.**
-

# 4 Managing Patients

---

## 4.1 Entering New Patient Information





Some patient information may directly affect ECG analysis. Complete and correct patient information is helpful for accurate diagnosis and treatment of the patient.

The displayed items of required and other patient information can be changed in the **Maintenance** menu only. For more information, see *10.2.4 Patient Management*.

If the equipment is connected to the Admit-Discharge-Transfer (ADT) server, after you enter the patient ID existing in the ADT server, the patient information is automatically loaded or updated from the ADT server. The settings for the ADT server connection can be changed in the **Maintenance** menu only. For more information, see *10.2.11.7 ADT Setup Tab*.

### 4.1.1 Manually Inputting Patient Information

To manually input the patient information, choose any the following ways:

- Press  <sub>ID</sub>, input patient ID and press the **F4** hard key for confirmation.
- Press  <sub>Age</sub>, input patient age by pressing numeric hard keys and press the **F4** hard key for confirmation.
- Continuously press  to select a desired symbol for patient gender.
- Press  <sub>Menu</sub> → from the **Manage** column select **Patient Management** → select the **New Patient** tab, input the desired information → select **OK**, and then press the **F4** hard key for confirmation.

#### NOTE

- **For patients under 16 years old, it is recommended to set V3 Placement to V4R and place chest electrodes at V4R, V1, V2, V4, V5, V6. This is a normal practice for a patient of this age.**
- 

### 4.1.2 Reading Patient Information from a Barcode Reader





To read patient information from a barcode reader, follow this procedure:

1. Connect the barcode reader. For more information, see *3.4.5 Connecting the Barcode Reader*.
2. Press down the button on the reader handle, and target the reader to the barcode. Then the **Patient Management** window is displayed with patient ID entered.
3. Select **OK**.

## 4.2 Editing the Current Patient Information

When patient information is found incomplete or incorrect, you can edit the information for the current patient.

To manually input the patient information, choose any the following ways:

- Press  <sub>ID</sub>, input patient ID and press the **F4** hard key for confirmation.
- Press  <sub>Age</sub>, input patient age by pressing numeric hard keys and press the **F4** hard key for confirmation.
- Continuously press  to select a desired symbol for patient gender.
- Press  <sub>Menu</sub> → from the **Manage** column select **Patient Management** → select the **Edit Patient ID** tab, input the desired information → select **OK**, and then press the **F4** hard key for confirmation.

**This page intentionally left blank.**

# 5 Patient Preparation

---

## 5.1 Patient Preparation Safety Information

---

### WARNING

---

- Ensure that all leadwires are connected and all electrodes are applied to correct sites. Ensure the conductive parts of the patient cable and electrodes, including the neutral electrode, do not contact other conductive parts including earth.
  - The bulb of chest electrodes contains latex, which could cause allergic reactions. Periodically inspect the electrode application site to ensure skin integrity. If the skin quality changes, replace the electrodes.
  - The metal electrode contains nickel, which could cause skin irritation. Periodically inspect the electrode application site to ensure skin integrity. If the skin quality changes, replace the electrodes.
- 

### CAUTION

---

- Polarizing electrodes may cause the electrodes to retain a residual charge after defibrillation. Residual charge will block the acquisition of ECG signal.
  - Never mix patient electrode types or brands. Dissimilar metals or other incompatibilities may cause considerable baseline drift and may increase trace recovery time after defibrillation.
  - Do not reuse disposable electrodes. Reuse may cause a risk of contamination and affect the measurement accuracy.
  - Reusable electrodes shall be cleaned and disinfected before applying to the patient.
  - Use disposable electrodes when the equipment is in use with a defibrillator.
- 

### NOTE

---

- To obtain high-quality ECG signal, make sure that the metal electrodes firmly contact the skin.
  - The metal electrodes and application sites must be clean.
  - When placing the chest electrodes, make that the metal electrodes do not touch each other and the conductive gel from one application site does not touch another site.
  - The metal plate of the limb electrode may be loose due to frequently plugging and unplugging the leadwire. Make sure the leadwire is firmly connected with the electrode.
  - Reusable electrodes must be cleaned and disinfected after each use.
- 

## 5.2 Instructing the Patient

Before start acquiring ECG, you can greet the patient and explain the procedure to decrease fear and anxiety.

Once the electrodes are applied, instruct the patient in the following positions:

- Arms and legs flat
- Relaxing and comfortably lying
- Remain still without talking
- Breathing normally without chewing or clenching teeth.

## 5.3 Preparing the Skin

Proper skin preparation is necessary to ensure good signal quality at the electrode sites, as the skin is a poor conductor of electricity.

To properly prepare the skin, follow this procedure:

1. Expose the skin for at chosen electrode sites.
2. Shave hair from each electrode site.
3. Degrease each electrode site with alcohol and abrade slightly with dry gauze to remove dead skin cells.
4. Dry the skin completely.

## 5.4 Connecting Leadwires with Electrodes

To connect leadwires with electrode, follow this procedure:

1. Check that the patient cable is securely connected with the equipment. For more information, see *3.4.4 Connecting the Patient Cable*.
2. Respectively plug the limb leadwires into the leadwire connectors of the 4 limb electrodes. Adjust each leadwire to make sure electrodes and leadwires are firmly connected.
3. Respectively plug the chest leadwires into the leadwire connectors of the 6 chest electrodes. Adjust each leadwire to make sure electrodes and leadwires are firmly connected.

### NOTE

- **The limb electrodes are color coded. Make sure limb leadwire and limb electrode of the same color are connected.**

### 5.4.1 Leadwires and Electrodes

#### Patient Cable

The patient cable consists of a connector, a trunk cable, 4 limb leadwires and 6 chest leadwires. The leadwires are color-coded.

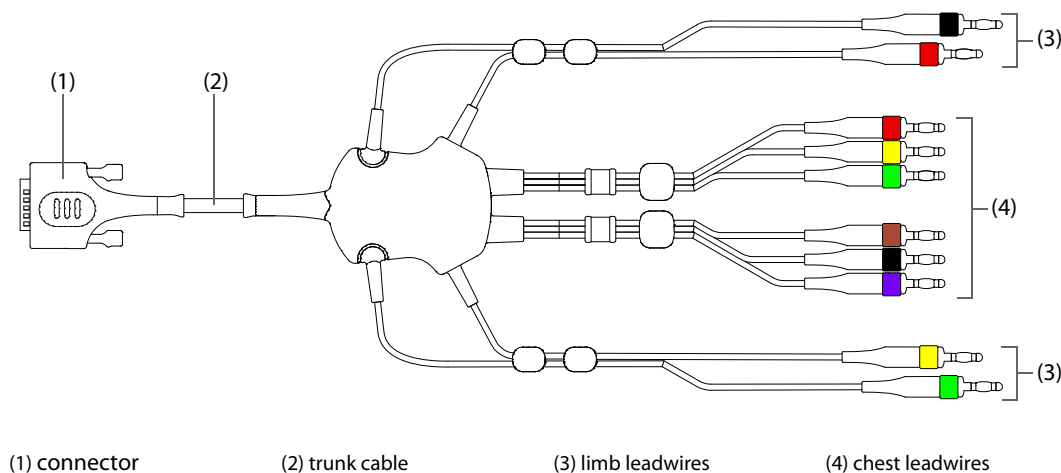

## Chest Electrode

The chest electrode consists of a bulb and a metal electrode. The leadwire connector on the metal electrode is used to connect the chest leadwire.

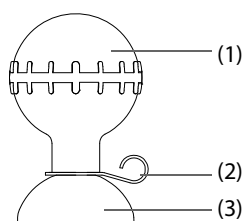

- (1) bulb
- (2) leadwire connector
- (3) metal electrode

## Limb Electrode

The limb electrode consists of a plastic clamp and a metal electrode. The leadwire connector on the metal electrode is used to connect the limb leadwire.

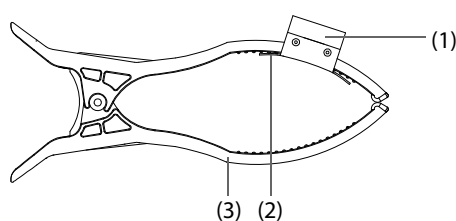

- (1) leadwire connectors
- (2) metal electrode
- (3) clamp

## 5.4.2 Leadwires Color Codes

The following table lists identifiers and color codes on leadwires for both AHA and IEC standards:

Lead	IEC		AHA	
	Label	Color	Label	Color
Right arm	R	Red	RA	White
Left arm	L	Yellow	LA	Black
Right leg (neutral)	N	Black	RL	Green
Left leg	F	Green	LL	Red
Chest 1	C1	White/Red	V1	Brown/Red
Chest 2	C2	White/Yellow	V2	Brown/Yellow
Chest 3	C3	White/Green	V3	Brown/Green
Chest 4	C4	White/Brown	V4	Brown/Blue
Chest 5	C5	White/Black	V5	Brown/Orange
Chest 6	C6	White/Violet	V6	Brown/Violet

## 5.5 Applying Electrodes

In this section, electrode placement is illustrated using the AHA naming convention.

### 5.5.1 Standard 12-Lead Electrode Placement

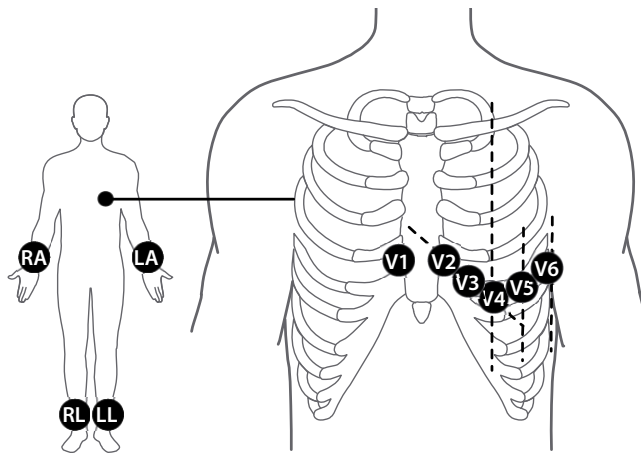

AHA	IEC	Electrode Placement
V1	C1	Fourth intercostal space at the right sternal border
V2	C2	Fourth intercostal space at the left sternal border
V3	C3	Midway between V2 (C2) and V4 (C4) electrode positions
V4	C4	Fifth intercostal space at the left midclavicular line
V5	C5	Left anterior axillary line, horizontal with the V4 (C4) electrode position
V6	C6	Left midaxillary line, horizontal with the V4 (C4) electrode position
RA	R	Above right wrist, inside the right arm and below the elbow
LA	L	Above left wrist, inside the left arm and below the elbow
RL	N	Above right ankle, inside the right leg and below the knee
LL	F	Above left ankle, inside the left leg and below the knee

### 5.5.2 Pediatric Lead Placement

For patients under 16 years old, chest electrodes should be placed at V4R, V1, V2, V4, V5, V6, and V3 electrode should be placed at the position of V4R as shown below.

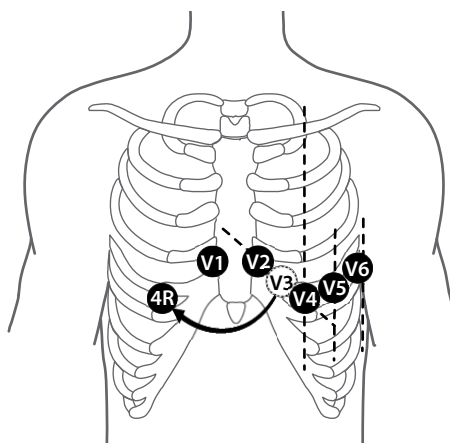

### 5.5.3 Applying Reusable Electrodes

To apply reusable electrodes, follow this procedure:

1. Check that the electrodes are clean.
2. Check that leadwires are firmly connected with electrodes. For more information, see *5.4 Connecting Leadwires with Electrodes*.
3. Route the leadwires to avoid twisting.
4. Prepare the skin. For more information, see *5.3 Preparing the Skin*.
5. Apply conductive gel evenly on each electrode application site.
6. Apply a thin layer of conductive gel evenly on the metal part of each limb electrode and on the brim of each chest electrode.
7. Place the limb electrodes on the limb sites.
8. Apply the chest electrodes by squeezing the rubber bulb and allowing suction to hold the electrodes in place.

### 5.5.4 Applying Disposable Electrodes

To apply disposable electrodes, follow this procedure:

1. Check that leadwires are firmly connected with electrodes. For more information, see *5.4 Connecting Leadwires with Electrodes*.
2. Route the leadwires to avoid twisting.
3. Prepare the skin. For more information, see *5.3 Preparing the Skin*.
4. Place all electrodes firmly on the correct sites.

## 5.6 Viewing Reversal Lead Prompt

The auto display function of reversal lead prompt is enabled by default. The switch setting of **Reversal Lead Prompt** can be changed in the **Maintenance** menu only. For more information, see *10.2.2.4 Advanced Setup Tab*.

In the Auto mode, the equipment automatically prompts you reversal lead in the following conditions:

- Mindray algorithm is configured, left and right limb leadwires are inversely connected.
- Glasgow algorithm is configured, all limb leadwires are inversely connected.

**This page intentionally left blank.**

# 6 Acquiring ECG and Printing Reports

---

## 6.1 ECG Acquisition Safety Information

---

### WARNING

---

- This equipment is not intended for direct cardiac application.
  - This equipment is not intended for use with high frequency surgical units.
  - Do not contact the patient during defibrillation. Otherwise serious injury or death could result.
  - For paced patients, the equipment may mistake a pace pulse for a QRS complex if several adverse conditions exist simultaneously. Always keep these patients under close surveillance.
  - For paced patients, you must set Paced to Yes. Otherwise the equipment could mistake a pace pulse for a QRS and fail to generate alarm when the ECG signal is too weak. For non-paced patients, you must set Paced to No.
  - Ensure that all leadwires are connected and all electrodes are applied to correct sites. Ensure the conductive parts of the patient cable and electrodes, including the neutral electrode, do not contact other conductive parts including earth.
  - The auto measurements and diagnoses are for reference only and cannot be directly used for patient treatment.
- 

### CAUTION

---

- Interference from ungrounded instrument near the patient and electrosurgery interference can induce noise and artifact into the waveforms.
  - If selected lead cannot provide valid ECG signals, a dash line is shown in the ECG waveform area.
- 

## 6.2 Configuring Displayed Waveforms

Before acquiring an ECG, you can configure displayed waveforms.

- When the main screen is displayed, continuously pressing the **F1** hard key to select the desired waveform speed.
- When the main screen is displayed, continuously pressing the **F2** hard key to select the desired waveform gain.
- Continuously pressing  to select the desired filter frequency.
- Continuously pressing **I, II...** to select the desired lead to be recorded.

The default settings of displayed waveforms can be also changed in the **Maintenance** menu. For more information, see *10.2.2 Waveform Setup Menu*.

## 6.3 Acquiring ECG

The equipment provides multiple modes for acquiring an ECG.

### 6.3.1 Auto Mode

In the Auto mode, the equipment acquires 10 seconds of ECG data and provides measured values and diagnostic results. Either Mindray or Glasgow algorithm can be configured for the equipment. For more information about the algorithm, see the physician's guide to corresponding algorithm

After acquiring ECG data, the equipment automatically prints out the report. You can configure to preview the report before the printing. The switch setting of **Report Preview** can be changed in the **Maintenance** menu only. For more information, see *10.2.3.1 Record Setup Tab*.

To start acquiring 12-lead ECG in the Auto mode, follow this procedure:



1. Check that patient information is correct.
2. Press  **ECG**.
3. If needed, set the equipment to acquire 10 seconds of ECG data before the acquisition. The pre-acquisition function is disabled by default. The switch setting of **Pre-acquisition** can be changed in the **Maintenance** menu only. For more information, see *10.2.3.1 Record Setup Tab*.
4. After acquiring 10 seconds of ECG data, the equipment automatically starts analysis and prints out the report.

During the acquisition, press the **F4** hard key to interrupt it at any time.

### 6.3.2 Manual Mode

In the Manual mode, the equipment continuously acquires the real-time ECG waveforms. The Manual mode does not provide measured values and diagnostic results.

To start acquiring an ECG in the Manual mode, follow this procedure:



1. Press .
2. Press  or the **F4** hard key to complete the acquisition.

The equipment starts acquiring ECG data, and automatically prints out the report at the same time. You can configure to preview the report after completing the acquisition. The switch setting of **Report Preview** can be changed in the **Maintenance** menu only. For more information, see *10.2.3.1 Record Setup Tab*.

### 6.3.3 Rhythm Mode

In the Rhythm mode, the equipment acquires 30 minutes of ECG data at most for the rhythm lead. The Rhythm mode does not provide measured values and diagnostic results.

To start acquiring an ECG in the Rhythm mode, follow this procedure:

1. Press .
2. Press  or the **F4** hard key to complete the acquisition.

After completing the acquisition, the equipment automatically prints out the report. You can configure to preview the report before the printing. The switch setting of **Report Preview** can be changed in the **Maintenance** menu only. For more information, see *10.2.3.1 Record Setup Tab*.

## 6.4 Previewing Reports

You can configure to preview the report after completing the acquisition. The contents of report preview and print report are consistent.

The switch setting of **Report Preview** and relevant report settings can be changed in the **Maintenance** menu only. For more information, see *10.2.3.1 Record Setup Tab*.

### 6.4.1 Transmitting a Report

To transmit a report, select **Send** in the report preview. For details about transmit setup, see *10.2.11.4 Transfer Setup Tab*.

If **Send After Saving** is switched on and **Report Preview** is switched off, the equipment automatically transmits a report after acquiring an ECG in the Auto, Manual or Rhythm mode. The switch settings of **Send After Saving** and **Report Preview** can be changed in the **Maintenance** menu only. For more information, see *10.2.3.1 Record Setup Tab* and *10.2.11.4 Transfer Setup Tab*.

### 6.4.2 Deleting a Report

The equipment can be configured to delete a report after transmitting it. This function is disabled by default. The switch setting of **Auto Delete after Sending** can be changed in the **Maintenance** menu only. For more information, see *10.2.11.4 Transfer Setup Tab*.

### 6.4.3 Printing the Report Preview

To print the current report preview, select **Print** in the report preview.

If **Report Print** is switched on and **Report Preview** is switched off, the equipment automatically print out a report after acquiring an ECG in the Auto mode. The switch settings of **Report Print** and **Report Preview** can be changed in the **Maintenance** menu only. For more information, see *10.2.3.1 Record Setup Tab*.

### 6.4.4 Exiting the Report Preview

To exit the report preview, press the **F1** hard key.

## 6.5 Printing Reports

You can choose either a built-in recorder or an external printer to print out reports. The equipment supports HP LaserJet Pro M203dn and HP LaserJet Pro M203dw printers.

The equipment can print out the following reports:

- Standard 12-lead ECG report
- Manual report (for recorder only)
- Rhythm report
- Review report
- Re-analysis report

For details about specific function printing, see corresponding sections of this manual.

The relevant print settings can be changed in the **Maintenance** menu. For more information, see *10.2.5 Print Setup Menu*.

---

### CAUTION

- **Never pull the recorder paper with force when the printing is in process. Otherwise, it may cause damage to the recorder.**
  - **Do not leave the recorder door open unless you reload paper or remove troubles.**
  - **To avoid skin burns, do not touch the print head after a long-time printing.**
-

### 6.5.1 Automatically Printing a Report

If **Report Print** is switched on and **Report Preview** is switched off, the equipment automatically prints out a report after acquiring an ECG in the Auto mode.

The switch settings of **Report Print** and **Report Preview** can be changed in the **Maintenance** menu only. For more information, see *10.2.3.1 Record Setup Tab*.

### 6.5.2 Printing the Current Report

When **Print** is displayed on the screen (such as report preview or the **History File** window with a file selected), you press the hard key corresponding with **Print** to print the current report.

### 6.5.3 Printing the Latest Report

To print the latest auto report or rhythm report, press the **F3** hard key.

### 6.5.4 Viewing Printing Status

If multiple printing tasks are started, you can view the printing status of latest 10 tasks.

To view the printing status, Press  and then select **Print Queue** from the **Manage** column.

Each printing task includes patient ID, exam item, acquisition time and printing status.

### 6.5.5 Removing Paper Jam

If the recorder works incorrectly or produces unusual sounds, check if there is a paper jam first. If a paper jam is detected, follow this procedure to remove it:

1. Open the recorder door.
2. Take out the paper and tear off the draped part.
3. Reload the paper and close the recorder door.

### 6.5.6 Clearing Printer Errors

When an external printer runs out of paper, the print request will not be responded. If there are too many print jobs that are not responded, a printer error may occur. In these cases, you need to install paper and then re-send the print request. Restart the printer if necessary.

### 6.5.7 Stopping Printing

To stop the printing, choose any of the following ways:

- The equipment automatically stops when auto printing is completed.
- Press the hard key corresponding with **Stop All Reports** to manually stop the printing.
- In the **Print Queue** window, select **Delete** or **Delete All** to clear the printing task.

## 6.6 Viewing Printed Reports

Items added into the print report can be changed in the **Maintenance** menu only. For more information, see *10.2.3.3 Added in Report Setup Tab*.

The following figure shows a standard 12-lead ECG report in the Auto mode

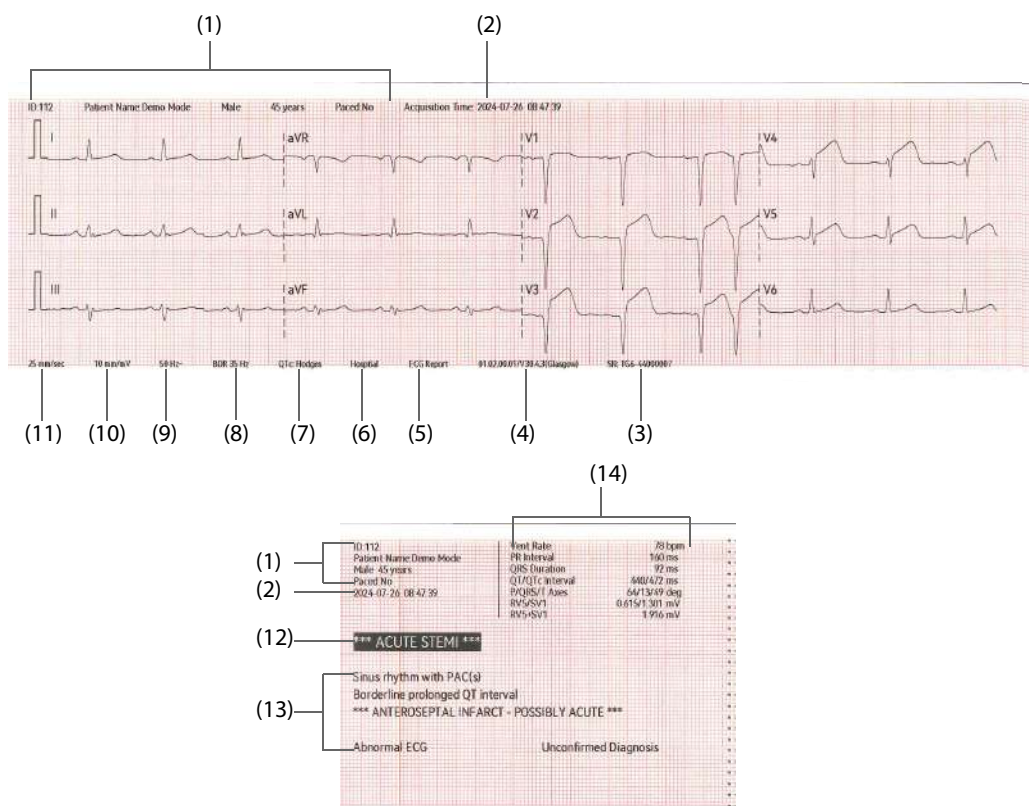

- (1) Patient information
- (2) Acquisition time
- (3) Equipment SN
- (4) System software version/algorithm version
- (5) Report name
- (6) Institution name
- (7) QTc formula
- (8) Frequency range
- (9) Notch filter
- (10) Gain
- (11) Paper speed
- (12) Critical values: includes "Consider Acute STEMI", "Acute MI/Ischemia", "Extreme Tachycardia", "Extreme Bradycardia", "Significant Arrhythmia".
- (13) Diagnostic results
- (14) Measured values: include heart rate, PR interval, QRS duration, QT/QTc interval, P/QRS/T axes, RV5/SV1, RV5+SV1.

**This page intentionally left blank.**

# 7 Managing Files

## 7.1 Generating a File

The equipment can automatically generate and save a file (also called “report”). The generation of a file is affected by the switch settings of **Report Preview** and **Report Print**.

- When **Report Preview** and **Report Print** are switched on, the equipment automatically displays the report preview and saves a file after the acquisition.
- When **Report Preview** is switched on and **Report Print** is switched off, the equipment automatically displays the report preview after the acquisition. A file is saved after you close the report preview.
- When **Report Preview** and **Report Print** are switched off, the equipment automatically starts printing after the acquisition. A file is saved after the printing.
- When **Report Preview** is switched off and **Report Print** is switched on, the equipment automatically saves a file after the acquisition.

**Report Preview** and **Report Print** are switched on by default. The switch settings of **Report Preview** and **Report Print** can be changed in the **Maintenance** menu only. For more information, see *10.2.3.1 Record Setup Tab*.

## 7.2 Accessing the History File Window

You can manage files. When the main screen is displayed, press the **F4** hard key to access the **History File** window.



ID	Name	Gender	Acquisition Time
2024071810581443		Unspecifie.	2024-07-18 13:58:09
2024071810581443		Unspecifie.	2024-07-18 13:57:41
2024071810581443		Unspecifie.	2024-07-18 13:57:20
2024071810581443		Unspecifie.	2024-07-18

The file list displays in the sequence of acquisition time, providing information of patient ID, name, gender and acquisition time. The latest generated file is displayed in top row of the file list.

## 7.3 Searching a File

To search a file, follow this procedure:

1. Access the **History File** window.
2. Input query criteria.
3. Select **Search**.

## 7.4 Reviewing a File

### 7.4.1 Reviewing a Discharged Patient Report

You can review one Auto report of a discharge patient. To do so, follow this procedure:

1. Access the **History File** window.
2. From the file list, select a desired file and press the **F4** hard key for confirmation.
3. Press the **F3** hard key.





Pressing the **F2** hard key can transmit the current review report.

Pressing the **F3** hard key can print out the current review report.

### 7.4.2 Reanalyzing a File

Incomplete or incorrect patient information may cause an inaccurate diagnostic results. You can input additional information to reanalyze a standard 12-lead ECG report.

To reanalyze a file, follow this procedure:

1. Access the **History File** window.
2. From the file list, select a desired file and press the **F4** hard key for confirmation.
3. Press the **F3** hard key.
4. Press , and then press any of ,  and  to edit the desired patient information.
5. Press the **F4** hard key for confirmation. The equipment automatically reanalyzes the file and displays the review report.

Pressing the **F2** hard key can transmit the reanalysis report.

Pressing the **F3** hard key can print out the reanalysis report.

## 7.5 Exporting Files

You can use a USB drive to export files. To do so, follow this procedure:

1. Connect the USB drive to the USB connector of the equipment.
2. Access the **History File** window.
3. Select **Export All**.

### NOTE

- **Do not remove the USB drive from the equipment before data is completely exported.**

## 7.6 Deleting Files

The auto display function of insufficient storage is enabled by default. The switch setting of **Insufficient Capacity Prompt** can be changed in the **Maintenance** menu only. For more information, see *10.2.4.5 Patient Data Setup Tab*.

When less than 10 reports can be stored, "**Storage space is nearly full**" is displayed. When only one report can be saved, "**Storage space is full, and history files will be automatically deleted.**" is displayed.

You can also manually to delete a file from the equipment. To do so, follow this procedure:

1. Access the **History File** window.
2. Select **Delete All**.

### NOTE

- **Earlier stored data will be overwritten by later ones if the equipment capacity is reached.**

## 7.7 Printing Files

You can print out the unprinted files or print files again. To do so, follow this procedure:

1. Access the **History File** window.
2. From the file list, select a desired file and press the **F4** hard key for confirmation.
3. Press the **F4** hard key.

## 7.8 Transmitting Files

You can transmit unsent files or transmit files again. To do so, follow this procedure:

1. Access the **History File** window.
2. Select **Send All**.

## 7.9 Exiting the History File Window

To exit the **History File** window, press the **F1** hard key.

**This page intentionally left blank.**

# 8 Data Communication

---

## 8.1 Data Communication Introduction

The equipment can communicate with the CMS, eGateway or CardioVista ECG Viewer software through wired or wireless networks. You can also transmit data from the equipment to a third-party system through FTP, HL7 and DICOM protocols.

## 8.2 Data Communication Safety Information

---

### CAUTION

---

- **Wireless network design, deployment, debugging, and maintenance should be executed by Mindray service personnel or authorized technicians.**
  - **Always deploy the wireless network according to local wireless regulations.**
  - **Using 5 GHz frequency band is recommended whenever possible. There are more interference sources in 2.4 GHz frequency band.**
  - **Private APs and wireless routers are not allowed. These devices may cause radio interference and result in data loss.**
  - **To ensure network security and stability, data communication must be performed within a closed network or within a virtually isolated hospital network. The hospital is responsible for ensuring the security of the virtually isolated network.**
  - **With higher security, WPA3-PSK and WPA3-Enterprise verification and encryption should be used if possible. Otherwise, the wireless information may be stolen or patient information may be leaked.**
  - **Keep network authentication information, for example password, from being accessed by unauthorized users.**
  - **If wireless network signal is poor, there may be a delay of data transmission or a risk of report missing.**
  - **Maximum number of equipments connected to a single AP is 8. Too many equipments connected to the same AP may result in network disconnection.**
  - **RF interference may result in wireless network disconnection.**
  - **Disconnecting from the network may result in data loss and function failure. In case of network disconnection, reconnect the network as soon as possible.**
  - **Ensure that IP address setting on the equipment is correct. Changing the network settings may result in network disconnection. Contact your service personnel if you have any problems on setting the IP address.**
- 

## 8.3 Connecting Networks

### 8.3.1 Connecting the Wired Network

To connect the wired network, follow this procedure:

1. Connect one end of the network cable to the network port of the equipment.
2. Connect the other end of the network cable to the network port of PC installed the desired communication system.
3. Change settings of the wired network. The wired network settings can be changed in the **Maintenance** menu only. For more information, see *10.2.11.1 Network Type Setup Tab* and *10.2.11.2 LAN1 IP Setup Tab*.

### 8.3.2 Connecting the Wireless Network

When the network is reconnected after a disconnection, or the equipment restarts, the last connected wireless network is automatically connected. If connecting the last connected wireless network fails, the equipment automatically connects other wireless networks by the sequence they were added.

The wireless network settings can be changed in the **Maintenance** menu only. For more information, see *10.2.11.1 Network Type Setup Tab* and *10.2.11.3 WLAN Setup Tab*.

## 8.4 Connecting the CMS

The equipment can be connected to the CMS through wired or wireless networks. When connected to the CMS, the equipment provides the following functions.

- The equipment transmits patient information and ECG reports to the CMS.
- The data mentioned above can be viewed from the CMS.
- Patient information and message status can be synchronized between the equipment and the CMS.

The settings for the CMS connection can be changed in the **Maintenance** menu only. For more information, see *10.2.11 Network Setup Menu*.

For details about operations on the CMS, see *BeneVision Monitoring System Operator's Manual*.

## 8.5 Connecting the eGateway

The equipment can be connected to the eGateway through wired or wireless networks, which can implement interactions between the equipment and other equipments. When connected to the eGateway, the equipment provides the following functions:

- The equipment transmits data to the eGateway, including patient information and ECG reports.
- The equipment system time automatically synchronizes with that on the eGateway.
- Patient information from HIS can be queried on the equipment through the eGateway.

The ADT (admit-discharge-transfer) gateway is normally deployed in the eGateway. The ADT gateway can be used to obtain patient information from the hospital ADT server.

The settings for the ADT server connection can be changed in the **Maintenance** menu only. For more information, see *10.2.11.7 ADT Setup Tab*.

## 8.6 Connecting the NTP Server

The equipment can be connected to the NTP server through wired or wireless networks. When connected to the NTP server, the equipment system time automatically synchronizes with that on the NTP server. The settings for the NTP server connection can be changed in the **Maintenance** menu only. For more information, see *10.2.7.1 Time Synchronization Setup Tab*.

## 8.7 Transmitting ECG Reports

The equipment can transmit ECG reports to the hospital servers by connecting any of the CMS, eGateway, CardioVista ECG Viewer software, HL7 server, FTP server and DICOM server.

The available format for ECG report includes PDF, PNG, JPEG, BMP, DICOM, FDA XML and MR XML. The settings for transmitting reports can be changed in the **Maintenance** menu only. For more information, see *10.2.11.4 Transfer Setup Tab*.

For details about operations on the CardioVista ECG Viewer software, see *CardioVista ECG Viewer software Operator's Manual*.

# 9 Managing Configurations

---

## 9.1 Configuration Introduction

According to the patient's condition, you can adjust settings of the equipment. The collection of all these changeable settings is called a configuration. The equipment provides a sets of default configurations. You can change some default configuration and then save it as a user configuration.

---



### WARNING

---

- **The configuration management function is password protected. The configuration management tasks must be performed by clinical professionals.**
- 

## 9.2 Accessing Configuration Management

To access the **Manage Configuration** window, follow this procedure:

1. Press  to access the main menu.
2. Select **Manage** from the **Configuration** column → input the required password → select .

## 9.3 Selecting Default Configurations

The equipment automatically loads the preset default configuration when a patient is admitted.

To select default configurations, follow this procedure:

1. Access the **Manage Configuration** window.
2. Select **Select Default Config.**
3. Select the desired configuration.
  - ◆ **Load the Latest Config:** the latest configuration is loaded when the equipment is started or a patient is admitted.
  - ◆ **Load Specified Config:** the selected configuration is loaded when the equipment is started or a patient is admitted. The specified configuration can be the factory default configuration, or a saved user defined configuration.

## 9.4 Saving Current Settings

You can save current settings as a user configuration. To do so, follow this procedure:

1. Access the **Manage Configuration** window.
2. Select **Save Current Settings.**
3. Input the configuration name.
4. Select **OK.**

## 9.5 Deleting a Configuration

You can delete a saved user defined configuration. To do so, follow this procedure:

1. Access the **Manage Configuration** window.
2. Select **Delete Configuration.**
3. Select the desired configuration.
4. Select **Delete.**
5. Select **OK.**

## 9.6 Exporting Configurations

The current configurations of the equipment can be exported through a USB drive. To do so, follow this procedure:

1. Connect the USB drive to the USB connector of the equipment.
2. Access the **Manage Configuration** window.
3. Select **Export Configuration**.
4. Select the desired configuration.
5. Select **Export**.

## 9.7 Importing Configurations

It is not necessary to configure each equipment separately when installing several equipments with identical configurations. A USB drive can be used to import configurations from one equipment to another. To do so, follow this procedure:

1. Prepare a USB drive with desired configurations.
2. Connect the USB drive to the USB connector of the target equipment.
3. Access the **Manage Configuration** window.
4. Select **Import Configuration**.
5. Select the desired configuration.
6. Select **Import**.

## 9.8 Loading Configurations

Settings you changed under some condition may not be correct or not be appropriate for the newly admitted patient. In this case, you can load configurations.

To load configurations, follow this procedure:

1. Press  to access the main menu.
2. Select **Load** from the **Configuration** column.
3. Select the configuration from a desired page.
  - ◆ **Local** page: displays configurations on this equipment.
  - ◆ **USB Drive** page: displays configurations on the USB drive.
4. Select **Load**.

### NOTE

- 
- **The equipment may configure some settings by default when you load a configuration of different software version with the current configuration.**
- 

## 9.9 Modifying Configuration Management Password

You can modify the password for accessing the Configuration Management. To do so, follow this procedure:

1. Access the **Manage Configuration** window.
2. Select **Modify Password**.
3. Respectively enter the old and new passwords.
4. Select **OK**.

# 10 User Maintenance Settings

## 10.1 User Authorization

User maintenance enables you to customize your equipment to best meet your needs.

The **Maintenance** menu provides multiple pages for users with different authorizations. The following table lists user roles and corresponding authorizations.

User Role	Authorization
Clinical professional	Access menus of <b>Waveform Setup, Report Setup, Patient Management, Print, Unit, Time, Other.</b>
Biotechnical personnel	Access menus of <b>Waveform Setup, Report Setup, Patient Management, Print, Unit, Time, Other, Version, Battery Information, Scanner, Network Setup.</b>
Service personnel	Access menus of <b>Waveform Setup, Report Setup, Patient Management, Print, Unit, Time, Other, Authorization Setup, Version, Battery Information, Scanner, Network Setup, Factory Maintenance.</b>

### CAUTION



- **The maintenance settings can only be changed by authorized personnel. Contact your department manager or biomedical engineering department for the passwords used at your facility.**

### NOTE

- **Settings related to factory maintenance can only be changed by authorized service personnel.**

## 10.2 Changing Maintenance Settings

To access the **Maintenance** menu, follow this procedure:

1. Press  to access the main menu.
2. Select **Maintenance** from the **System** column → input the required password → select .
3. Select the desired setup menu and change the settings.

### NOTE

- **The new setting of system language takes effect only after the equipment restarts.**

### 10.2.1 Device Location Setup Menu

Menu Item	Default	Description
Device Name	/	Input the equipment name.
Facility	/	Input the name of your facility.
Department	/	Input the location where the equipment located.

## 10.2.2 Waveform Setup Menu

### 10.2.2.1 Display Setup Tab

Menu Item	Default	Description
Waveform Layout	6x2	Sets the waveform layout. Take "3x4+1" as an example, ECG waveforms are displayed in 3 lines and 4 columns followed by a rhythm lead waveform.
Wave Refresh Sequence	Sequential	Sets the refreshing method of ECG waveforms. <ul style="list-style-type: none"><li>• <b>Sequential:</b> ECG waveforms of all leads are refreshed one by one in order.</li><li>• <b>Synchronize:</b> ECG waveforms of all leads are refreshed at the same time.</li></ul>
MainScreen Grid	On	Sets whether waveforms are displayed with gridlines on the main screen.

### 10.2.2.2 Filter Setup Tab

Menu Item	Default	Description
Muscle Artifact Filter	35 Hz	Muscle artifact filter attenuates noise in the waveform by restricting the included frequencies. The muscle artifact filter is a low-pass filter. Signals exceeding the set frequency are filtered out. <ul style="list-style-type: none"><li>• <b>35 Hz:</b> only signals at 35 Hz or less are displayed.</li><li>• <b>20 Hz:</b> only signals at 20 Hz or less are displayed.</li><li>• <b>Off:</b> signals at 350 Hz or less are displayed.</li></ul>
Lowpass Filter	150 Hz	Signals exceeding the set frequency are filtered out.
Baseline Drift Removal	0.56 Hz (BDR 0.56 Hz)	The baseline drift removal suppresses most baseline drift interference and also is able to preserve the fidelity of the ST-segment level.
Notch Filter	On	The notch filter removes the line frequency interference.
Notch Frequency	50 Hz	Sets notch filter frequency according to the power line frequency of your country.

### 10.2.2.3 Lead Setup Tab

Menu Item	Default	Description
Rhythm Lead 1	II	Sets the first rhythm lead to be displayed.
Lead Sequence	Standard	Sets the ECG waveform layout. <ul style="list-style-type: none"><li>• <b>Standard:</b> the waveform sequence is I, II, III, aVR, aVL, aVF, V1, V2, V3, V4, V5, V6.</li><li>• <b>Cabrera:</b> the waveform sequence is aVL, I, -aVR, II, aVF, III, V1, V2, V3, V4, V5, V6.</li></ul>
ECG Standard	AHA	Sets the ECG standard according to the leadwires you are using.

### 10.2.2.4 Advanced Setup Tab

Menu Item	Default	Description
Pacing Sampling	Normal	<ul style="list-style-type: none"> <li>• <b>Normal:</b> samples waveforms at an amplitude of <math>\pm 2</math> mV to <math>\pm 700</math> mV, width of 0.1 ms to 2.0 ms.</li> <li>• <b>High Sensitivity:</b> samples waveforms at an amplitude of <math>\pm 500</math> <math>\mu</math>V to <math>\pm 700</math> mV, width of 30 <math>\mu</math>s to 2.0 ms.</li> </ul>
Reversal Lead Prompt	On	Sets whether the equipment prompts limb electrodes are reversal in the Auto mode.

## 10.2.3 Report Setup Menu

### 10.2.3.1 Record Setup Tab

Menu Item	Default	Description
Printing Device	Recorder	Sets the output device to print the reports.
Pre-acquisition	Off	<p>In the Auto mode, sets whether the equipment acquires an ECG before you press .</p> <ul style="list-style-type: none"> <li>• <b>On:</b> if more than 10 seconds of ECG data has been acquired, the equipment immediately displays report preview after you start the acquisition; if less than 10 seconds of ECG data has been acquired, the message “<b>ECG acquiring... The printing will be started after acquisition.</b>” is displayed.</li> <li>• <b>Off:</b> the equipment displays report preview after you start the acquisition and 10 seconds of ECG data is acquired.</li> </ul>
Acquisition Duration for Rhythm/ Manual Report	1 min	Sets the duration for acquiring an ECG in the Manual and Rhythm modes.
Report Print	On	<p>Sets whether the equipment immediately starts printing after acquiring an ECG.</p> <p>If <b>Report Preview</b> is switch on:</p> <ul style="list-style-type: none"> <li>• <b>On:</b> the equipment automatically displays the report preview and saves a file after the acquisition.</li> <li>• <b>Off:</b> the equipment automatically displays the report preview after the acquisition. A file is saved after you close the report preview.</li> </ul> <p>If <b>Report Preview</b> is switch off:</p> <ul style="list-style-type: none"> <li>• <b>On:</b> the equipment automatically starts printing after the acquisition. A file is saved after the printing.</li> <li>• <b>Off:</b> the equipment automatically saves a file after the acquisition.</li> </ul>
Report Preview	Off	Sets whether the ECG report is previewed before being printed.
Thermal Paper Report Format	3x4	<p>Sets the format of ECG report generated in the Auto mode.</p> <ul style="list-style-type: none"> <li>• <b>3x4:</b> ECG waveforms are displayed in 3 lines and 4 columns, followed by median complex, measurement matrix, measurements and diagnoses.</li> <li>• <b>3x4+1:</b> is available when <b>Printout Sequence</b> is set to <b>Sequential</b>. ECG waveforms are displayed in 3 lines and 4 columns, followed by a line of rhythm lead, median complex, measurement matrix, measurements and diagnoses.</li> <li>• <b>3x4 Compact:</b> is available when <b>Printout Sequence</b> is set to <b>Sequential</b>. ECG waveforms are displayed in 3 lines and 4 columns, measurements and diagnoses are displayed on top of waveforms. Median complex and measurement matrix will not be included.</li> </ul>

Menu Item	Default	Description
Standard Report Format	3×4+1	Sets the format of a standard 12-lead ECG report generated in the Auto mode. Take "3×4+1" as an example, ECG waveforms are displayed in 3 lines and 4 columns followed by a rhythm lead waveform.
Manual	3 CH	Set the number of channels to be recorded in the report generated in the Manual mode. The recorded channels are highlighted on the screen. <ul style="list-style-type: none"> <li>• <b>3 CH:</b> real-time ECG data of three channels is simultaneously recorded.</li> <li>• <b>1 CH:</b> real-time ECG data of one channel is recorded.</li> </ul>
Paper Type	Rolled Paper	Sets the default recorder paper type.
Printout Sequence	Sequential	Sets the recording method of ECG report generated in the Auto mode. <ul style="list-style-type: none"> <li>• <b>Simultaneous:</b> 12-lead ECG data are recorded at the same time.</li> <li>• <b>Sequential:</b> 12-lead ECG data are recorded sequentially and displayed in 3 lines and 4 columns with 2.5 seconds of ECG data for each column.</li> </ul>
Printout Duration	2.5 s	Sets the duration of ECG data to be recorded. This option is available only when <b>Printout Sequence</b> is set to <b>Simultaneous</b> .

### 10.2.3.2 Report Analysis Setup Tab

Menu Item	Default	Description
Reanalyze	On	Sets whether the ECG data is reanalyzed when the discharged patient information (including age, date of birth, gender, race, medication, or V3 placement) is changed.
Tachy	100	Sets the tachycardia threshold. This setting is only effective for patients over 180 days.
Brady	50	Sets the bradycardia threshold. This setting is only effective for patients over 2191 days.
QTc Formula	Hodges	Sets the QTc formula used to correct the QT interval for heart rate. <ul style="list-style-type: none"> <li>• <b>Hodges:</b> <math>QTc = QT + 1.75 \times (HeartRate - 60)</math></li> <li>• <b>Bazett:</b> <math>QTc = QT \times \left( \frac{HeartRate}{60} \right)^{\frac{1}{2}}</math></li> <li>• <b>Fridericia:</b> <math>QTc = QT \times \left( \frac{HeartRate}{60} \right)^{\frac{1}{3}}</math></li> <li>• <b>Framingham:</b> <math>QTc = QT + 154 \times \left( 1 - \frac{60}{HeartRate} \right)</math></li> </ul>

### 10.2.3.3 Added in Report Setup Tab

Menu Item	Default	Description
Measurements/Interpretation/ Interpretation Summary/RV5/SV1	Selected	Sets the item to be added in the report. <ul style="list-style-type: none"> <li>• <b>Measurements:</b> includes heart rate, PR interval, QRS duration, QT/QTc interval, P/QRS/T axes, RV5/SV1, RV5+SV1.</li> <li>• <b>Median Complex:</b> displays a median complex waveform for each lead and a lead II waveform of 10 seconds in 3x4+1 format.</li> <li>• <b>Measurement Matrix</b> (for Glasgow algorithm): provides 32 measurements of each lead, including Pon (ms), Pdur (ms), QRSON (ms), QRSdur (ms), Qdur (ms), Rdur (ms), Sdur (ms), R'dur (ms), S'dur (ms), P+dur (ms), QRSdef (ms), P+amp (μV), P-amp (μV), QRSp2p (μV), Qamp (μV), Ramp (μV), Samp (μV), R'amp (μV), S'amp (μV), STamp (μV), 2/8STT (μV), 3/8STT (μV), T+amp (μV), T-amp (μV), QRSarea (μV*ms), Rnotch, DWconf (%), STslope (deg), Ton (ms), Tdur (ms), T+dur (ms), QTint (ms).</li> <li>• <b>Measurement Matrix</b> (for Mindray algorithm): provides 30 measurements of each lead, including Pon (ms), Pdur (ms), QRSON (ms), QRSdur (ms), Qdur (ms), Rdur (ms), Sdur (ms), R'dur (ms), S'dur (ms), P+dur (ms), QRSdef (ms), P+amp (μV), P-amp (μV), QRSp2p (μV), Qamp (μV), Ramp (μV), Samp (μV), R'amp (μV), S'amp (μV), STamp (μV), T+amp (μV), T-amp (μV), QRSarea (μV*ms), STslope (deg), Ton (ms), Tdur (ms), T+dur (ms), QTint (ms), STTmid (μV), STTend(μV).</li> </ul>
Median Complex/Measurement Matrix	Unselected	

### 10.2.3.4 Export Tab

Menu Item	Default	Description
File Type	PDF	Sets the default format of exported file.

## 10.2.4 Patient Management

### 10.2.4.1 Displayed Information Setup Tab

Menu Item	Default	Description
Middle Name/Secondary ID/Race/V3 Placement/Department/Room No/Bed No/Physician/Technician/ Indication/Medication/Weight/BP	Unselected	Sets the default item displayed on <b>New Patient</b> and <b>Edit Patient ID</b> pages of the <b>Patient Management</b> window.

### 10.2.4.2 Reserved Information Setup Tab

Menu Item	Default	Description
Race/Physician/Technician/ Department/Room No	Unselected	Sets the item remaining information for the next patient.

### 10.2.4.3 Required Information Setup Tab

Menu Item	Default	Description
Patient ID/Patient Name/Gender/ DOB/Age/Paced	Unselected	Sets the item required on <b>New Patient</b> and <b>Edit Patient ID</b> pages of the <b>Patient Management</b> window.

### 10.2.4.4 Privacy Setup Tab

Menu Item	Default	Description
Primary Screen Display Full Name	On	Sets whether patient name is displayed in the patient information area of the main screen.
Primary Screen Display Full Patient ID	On	Sets whether patient ID is displayed in the patient information area of the main screen.

### 10.2.4.5 Patient Data Setup Tab

Menu Item	Default	Description
Insufficient Capacity Prompt	On	Sets whether the equipment automatically displays the prompt for insufficient storage.
Clear All Patient Data	/	Deletes all patient information and data from the equipment.

### 10.2.5 Print Setup Menu

Menu Item	Default	Description	
Connection Type	Printer	Selects patient report is printed out through the print server or a network printer.	
Print Test Page	/	Tests whether the printer works properly.	
If <b>Connection Type</b> is set to <b>Printer</b> , the following items are available.			
Printer IP Address	0.0.0.0	Inputs IP address of the network printer	
Paper Size	A4	Sets the default size of printed paper report.	
Printer Resolution	300 dpi	Sets the default resolution of printed paper report.	
Printout Grids	On	Sets whether grids are displayed on printed paper report.	
If <b>Connection Type</b> is set to <b>Print Server</b> , the following items are available.			
Print Server Address	/	If the CMS is used as the printer server, set <b>Port</b> to 6603.	
Print Server IP Address	0.0.0.0		
Port	6603		
ECG Report	Printer	/	Selects the default printer for printed paper report.
	Printer Resolution	/	Sets the default resolution for printed paper report.
	PDF Resolution	600 dpi	Sets the default resolution for PDF report.
	Print Action	Paper	Sets the printing media of reports.
	Color Mode	Color	Sets whether reports are in color printing.

### 10.2.6 Unit Setup Menu

Menu Item	Default	Description
Weight Unit	kg	Sets the default unit for each measurement.
ST Unit	mV	
Pressure Unit	mmHg	

## 10.2.7 Time Setup Menu

### 10.2.7.1 Time Synchronization Setup Tab

Menu Item	Default	Description
Time Zone	UTC-0 0	Sets the system time zone.
Start NTP Time Sync	Off	Sets whether the equipment system time synchronizes with that on the NTP server.
Interval	1 hr	Sets the interval for time synchronization.
Time Server Address	/	Sets the name of the desired NTP server.
Time Server	0.0.0.0	Sets the IP address of the desired NTP server.
Connected Status	/	Displays the connection status of the desired NTP server.
Network Test	/	Tests whether the desired NTP server is properly connected.

### 10.2.7.2 Daylight Savings Time Setup Tab

Menu Item	Default	Description
Auto Daylight Savings Time	Off	Sets whether to automatically enable the daylight saving time.

## 10.2.8 Version Information Menu

Menu Item	Description
Version	Displays system software version, module version, firmware version and algorithm type.

## 10.2.9 Battery Information Menu

Menu Item	Description
Battery1	Displays related information to the installed battery.

## 10.2.10 Scanner Setup Menu

### 10.2.10.1 Scanner Information Setup Tab

Menu Item	Default	Description
Data Parse Mode	2D Scanner	Uses the default settings for 2D barcode. You do not need to change them.
Data Encoding Type	UTF8	
Patient Barcode	/	Sets to distinguishing the patient barcode.

### 10.2.10.2 2D Barcode Setup Tab (for Mindray-Customized 2D Barcode Reader)

Menu Item	Default	Description
Patient Category/Gender/Month/ Age	/	Establishes the relationship between patient data for equipment and barcode data.  For example, the equipment has an option of <b>Ped</b> for patient category. In your hospital barcode, it may read as Pediatric. You need to input "Pediatric" for the field <b>Ped</b> to establish their relationship.

### 10.2.10.3 Scanner Identification Setup Tab (for non Mindray-Customized 2D Barcode Reader)

Menu Item	Default	Description
Select the scanner	/	When you are using a non mindray-customized 2D barcode reader, you should select the barcode reader from the USB device list, so that the equipment can identify the barcode reader.

### 10.2.10.4 Field Setup Tab (for Mindray-Customized 2D Barcode Reader)

Menu Item	Default	Description
Patient ID/First Name/Last Name/ Gender/DOB	Selected	Sets desired patient information to be output by the barcode reader.
Secondary ID/Room No/Bed No/ Age/Department	Unselected	

## 10.2.11 Network Setup Menu

### 10.2.11.1 Network Type Setup Tab

Menu Item	Default	Description
Device	Auto	Sets the network type. <b>Auto:</b> the equipment automatically identifies your network type.

### 10.2.11.2 LAN1 IP Setup Tab

Menu Item	Default	Description
Obtain IP Address Automatically	Selected	Sets whether the equipment automatically gets the IP address.
Use the Following Address	Unselected	If <b>Use the Following Address</b> is selected, you need to manually input IP address, subnet mask and gateway.
IP Address	0.0.0.0	
Subnet Mask	0.0.0.0	
Gateway	0.0.0.0	
Obtain DNS address automatically	Selected	Sets whether the equipment automatically gets the DNS address.
Using the Following DNS Address	Unselected	If <b>Using the Following DNS Address</b> is selected, you need to manually input IP addresses of preferred DNS server and alternate DNS server.
Preferred DNS Server	0.0.0.0	
Alternate DNS Server	0.0.0.0	

### 10.2.11.3 WLAN Setup Tab

Menu Item		Default	Description
Add WLAN		/	Adds wireless network and set the network in the pop-up dialog box.
Network Test		/	Tests whether the wireless network is properly connected.
WLAN	Name	/	Sets the name of the wireless network.
	SSID	/	
	Security	OPEN	Sets the security method.
	Password	/	Sets the password for accessing the wireless network.
WLAN IP	Obtain IP Address Automatically	Selected	Sets whether the equipment automatically gets the IP address.
	Use the Following Address	Unselected	If <b>Use the Following Address</b> is selected, you need to manually input IP address, subnet mask and gateway.
	IP Address	0.0.0.0	
	Subnet Mask		
	Gateway		
	Obtain DNS address automatically	Selected	Sets whether the equipment automatically gets the DNS address.
	Using the Following DNS Address	Unselected	If <b>Using the Following DNS Address</b> is selected, you need to manually input IP addresses of preferred DNS server and alternate DNS server.
	Preferred DNS Server	0.0.0.0	
Alternate DNS Server			
WLAN Setup	WLAN Band	Auto	Set the desired band that the equipment can identify.
	2.4G Channel	All	Sets the desired channels.
	5G Channel	All	
	6G Channel	All	
Certificate Management	Local	/	<b>Delete:</b> deletes the selected certifications.
	USB Drive	/	Selects certifications you want to import from the USB derive, and then select <b>Import</b> to import the desired certifications.

### 10.2.11.4 Transfer Setup Tab

Menu Item	Default	Description
Send After Saving	On	Sets whether the equipment automatically transmits the report to the destination after saving it.
Auto Delete after Sending	Off	Sets whether the equipment automatically deletes the report after transmitting it.
Send Destination	FTP	Sets the desired destination.
Network Test	/	Tests whether the destination server is properly connected.
<b>Central Station Setup</b>		

Menu Item	Default	Description
Server Address	/	Sets the desired CMS.
IP Address	0.0.0.0	
<b>HL7 Configuration</b>		
Server Address	/	Sets the desired HL7 server.
IP Address	0.0.0.0	
Port	0	
File Type	FDA XML	Sets the report format to be transmitted.
<b>FTP Setup</b>		
Server Address	/	Sets the desired FTP server.
Port	21	
User Name	/	
Password	/	
File Type	PDF	Sets the report format to be transmitted.
<b>eGateway Setup</b>		
Server Address	/	Sets the desired eGateway server.
IP Address	0.0.0.0	
Port	0	
File Type	FDA XML	
<b>CardioVista Setup</b>		
Server Address	/	Sets the desired server installed with CardioVista ECG Viewer software.
IP Address	0.0.0.0	
<b>DICOM Setup</b>		
Server Address	/	Sets the desired DICOM server.
IP Address	0.0.0.0	
Port	0	
AETitle	/	

### 10.2.11.5 Device Discover Setup Tab

Multicast helps device discovery between the equipments, or between the equipment and CMS. Equipments in the same multicast group can be mutually discovered.

Menu Item	Default	Description
Multicast TTL	1	Sets the live time and IP address of multicast group.
Multicast Address	225.0.0.8	
Master Server Address	/	Sets the desired master server.
Master Server IP Address	0.0.0.0	
Connected Status	Disconnected	Displays the connection status of the master server.
Network Test	/	Tests whether the master server is properly connected.

### 10.2.11.6 QoS Setup Tab

Menu Item	Default	Description
QoS	0	Sets the service quality of network connection.

### 10.2.11.7 ADT Setup Tab

Menu Item	Default	Description
Server Address	192.168.0.100	Sets the desired ADT gateway.
IP Address	192.168.0.100	
Port	3502	
ADT Query	Off	Selects whether patient information can be loaded to the equipment from the ADT server.
Network Test	/	Tests whether the ADT server is properly connected.

### 10.2.11.8 Information Security Setup Tab

Menu Item	Default	Description
Encryption Connection Type	Only Private Encryption	<ul style="list-style-type: none"><li>• <b>Only Private Encryption:</b> Mindray private encryption is used to encrypt the transmitted data. You cannot connect devices supporting SSL (secure sockets layer) encryption.</li><li>• <b>SSL Encryption Priority:</b> for devices supporting SSL encryption, SSL encryption is used when connecting the devices. For devices not supporting SSL encryption, private encryption is used when connecting the devices.</li></ul>

### 10.2.12 Other Setup Menu

Menu Item	Default	Description
Language	/	Sets the system language.
Screenshot	Off	Sets whether to enable the screen capture function.
Browse System Log	/	Views the system log. <ul style="list-style-type: none"><li>• <b>Search:</b> views the selected logs.</li><li>• <b>Jump To:</b> views logs of certain date and time.</li></ul>
Export System Log	/	Exports the system log to the USB drive.
Modify Password	/	Modifies the user maintenance password for the equipment.

**This page intentionally left blank.**

# 11 Battery

---

## 11.1 Battery Introduction

When AC power is not available, the equipment is designed to operate on the battery power. In case of a sudden power failure, the equipment automatically operates on the battery power without interruptions. Therefore, it is recommended that the equipment is always connected with a fully charged battery.

## 11.2 Battery Safety Information

---

### WARNING

---

- **Keep batteries out of children's reach.**
  - **Use only specified battery. Use of a different battery may present a risk of fire or explosion.**
  - **Keep the batteries in their original package until you are ready to use them.**
  - **Do not expose batteries to liquid.**
  - **Do not crush, drop or puncture the battery. Mechanical abuse can lead to internal damage and internal short circuits. If a battery has been dropped or banged against a hard surface, whether damage is externally visible or not, remove the battery from use and dispose of it properly.**
  - **If the battery shows signs of damage or signs of leakage, replace it immediately.**
  - **The battery should be charged in this equipment or the specified charger station.**
  - **Extremely high ambient temperature may cause battery overheat protection, resulting in equipment shutdown.**
  - **Do not open batteries, heat batteries above 60 °C, incinerate batteries, or short battery terminals. They may ignite, explode, leak or heat up, causing personal injury.**
- 

## 11.3 Replacing the Battery

The battery can only be replaced by authorized personnel. To replace the battery, contact your service personnel.

### WARNING

---

- **The battery installation or replacement performed by unauthorized personnel may cause the battery to ignite, explode, leak or heat up. Personal injury may also result.**
- 

## 11.4 Battery Indications

The battery indicator, on-screen battery symbol, and related prompt messages indicate the battery status.

### NOTE

---

- **After long term use, the power capacity indicated by the battery symbol may be different from the actual capacity. Always observe the prompt messages displayed on the screen.**
- 

### 11.4.1 Battery Indicator





The battery indicator indicates the following status:

- Steady green: the battery is fully charged.
- Flashing green: the equipment operates on battery power.

- Steady orange: the battery is being charged.
- Flashing orange: the battery fails.
- Off: the battery is not installed.

## 11.4.2 Battery Symbols

The on-screen battery symbols indicates the following status:

-  indicates that the battery operates properly. The green portion represents the remaining charge.
-  indicates that the battery power is low and needs to be charged.
-  indicates that the battery is almost depleted and needs to be charged immediately. Otherwise, the equipment will soon automatically shut down.
-  indicates that the battery is being charged.
-  indicates that no battery is installed or the battery fails.

## 11.4.3 Low Battery Prompts

When the battery power is low, the message “**Low Battery**” is displayed. When the battery power is almost depleted, the message “**Critically Low Battery**” is displayed. In this case, you should immediately connect the equipment to AC power. Otherwise, the equipment will automatically shut down soon.

## 11.5 Charging the Battery

The battery is automatically charged when connected to the AC power, regardless of the equipment is turned on or off. The charging will be slower with the equipment turned on.

## 11.6 Conditioning the Battery

The performance of batteries deteriorates over time. To extend the battery service life, you should condition the batteries at least every three months. If the battery is not conditioned for a prolonged time, its charge indication may not be accurate and you may wrongly evaluate the remaining battery runtime.

To condition a battery, follow this procedure:

1. Disconnect the equipment from the patient and stop all performances.
2. Allow the battery to be charged uninterruptedly till it is fully charged.
3. Allow the equipment to operate on the battery until the battery is completely depleted and the equipment automatically shuts down.
4. Fully charge the battery again for use or charge it to 40% to 60% for storage.

### NOTE

- **Do not use the equipment during battery conditioning.**
- **Do not interrupt battery conditioning.**

## 11.7 Checking Battery Performance

The performance of a rechargeable battery deteriorates over time. To extend the battery service life, it is recommended to check the battery performance every three months or if you doubt that the battery may fail.

See steps 1 to 3 of *11.6 Conditioning the Battery* to check battery performance. The operating time of the batteries reflects their performance directly. If the operating time of a battery is noticeably shorter than that stated in the specifications, the battery may reach its service life or malfunction.

If the battery performance meets the requirement, fully charge the battery again for use or charge it to 40% to 60% for storage.

## NOTE

---

- **Life expectancy of a battery depends on how frequent and how long it is used. When properly used, the lithium-ion battery has a useful life of approximately three years. If improperly used, its life expectancy can be shortened. It is recommended to replace the battery every three years.**
  - **To optimize the battery performance, a fully discharged (or near fully discharged) battery should be charged as soon as possible.**
  - **Battery operating time depends on the equipment configuration and operation. For example, high display brightness or repeated measurements will shorten the battery operating time.**
- 

## 11.8 Recycling Batteries

Discard a battery in the following situations:

- The battery has visual signs of damage.
- The battery fails.
- The battery is aged and its runtime is significantly less than the specification.
- The battery service life is reached.

Properly dispose of batteries according to local regulations.

**This page intentionally left blank.**

# 12 Care and Cleaning

---

## 12.1 Care and Cleaning Introduction

This chapter only describes cleaning and disinfection of the equipment. For the cleaning and disinfection of other reusable accessories, see the corresponding instructions for use.

## 12.2 Care and Cleaning Safety Information

---

### WARNING

---

- **Use only cleaners, disinfectants and methods specified in this chapter. Using unapproved substances or methods may damage the equipment and void the warranty.**
  - **Do not mix disinfecting solutions, as hazardous gases may result.**
  - **Mindray is not liable for the efficacy of the specified cleaners, disinfectants, or methods as a means for controlling infection. Refer to your hospital for infection controlling.**
  - **Be sure to power off the equipment and disconnect all power cables from the outlets before cleaning the equipment.**
  - **The responsible hospital or institution shall carry out all cleaning and disinfection procedures specified in this chapter.**
- 

### CAUTION

---

- **Never immerse any part of the equipment or accessories in liquids or allow liquid to enter the interior.**
  - **Any contact of cleaners or disinfectants with connectors or metal parts may cause corrosion.**
  - **Do not pour or spray any liquid directly on the equipment or accessories or permit fluid to seep into connections or openings.**
  - **If you spill liquid on the equipment or accessories, disconnect the power supply, dry the equipment, and contact your service personnel.**
  - **Never use abrasive materials (such as steel wool or silver polish), or erosive cleaners (such as acetone or acetone-based cleaners).**
  - **Dilute and use the cleaners or disinfectants according to the manufacturer's instructions.**
  - **Check the equipment after cleaning and disinfecting. If there is any sign of damage, remove it from use.**
- 

## 12.3 Cleaning

### 12.3.1 Cleaning the Main Unit

Clean your equipment on a regular basis. Before cleaning the equipment, consult your hospital's regulations for cleaning the equipment.

To clean the equipment, follow this procedure:

1. Dampen a soft lint-free cloth with water or ethanol (70%).
2. Wring excess liquid from the cloth.
3. Wipe the display screen of the equipment
4. Wipe the external surface of the equipment with the damp cloth, avoiding the connectors and metal parts.
5. Dry the surface with a clean cloth. Allow the equipment air dry in a ventilated and cool place.

---

**CAUTION**

---

- **During the cleaning procedure, disable the touch function by turning off the equipment.**
- 

### 12.3.2 Cleaning the Thermal Print Head

Dirty print head deteriorates printing quality. Check the printout to ensure the printing is legible and dark. Light printing may indicate a dirty print head.

To clean the thermal print head, follow this procedure:

1. Take measures against the static electricity, such as the wrist strap.
2. Open the recorder door and remove the recorder paper.
3. Gently wipe the print head with cotton swabs dampened with ethanol to remove the dust and foreign particles.
4. Wipe off excess moisture with dry cotton swabs.
5. Allow the print head air dry.
6. Reload the recorder paper and close the recorder door.

---

**CAUTION**

---

- **Do not use anything that may destroy the thermal element.**
  - **Do not add unnecessary force to the thermal head.**
  - **The thermal print head gets hot when printing. Do not clean the print head immediately after printing.**
- 

## 12.4 Disinfection

Disinfect the equipment as required in your hospital's servicing schedule. Cleaning the equipment before disinfecting is recommended. Always dilute and use disinfectants according to the manufacturer's instructions. The following table lists approved disinfectants:

Product Name	Product Type	Manufacturer
Ethanol, 70%	Liquid	/
Isopropanol, 70%	Liquid	/
Hydrogen peroxide, 3%	Liquid	/
Perform® Classic Concentrate OXY, 0.5%	Powder	Schülke & Mayr GmbH

## 12.5 Sterilization

Do not sterilize the equipment, accessories, or supplies unless otherwise specified in the instructions for use delivered with the accessories and supplies.

## 12.6 Impact of Improper Cleaning

Using cleaners other than those recommended may have the following impacts:

- Product discoloration
- Metal part corrosion
- Brittle and breaking wires, connectors, and equipment housing
- Reduced cable and leadwire life
- Overall system performance degradation
- Equipment malfunction or failure

**This page intentionally left blank.**

# 13 Maintenance

---

## 13.1 Maintenance Introduction

The equipment must be maintained to be ready for immediate use. To ensure proper performance of the equipment, you should strictly perform the maintenance in this chapter.

In case of any damage or abnormality, remove the equipment from use. Contact the hospital's biomedical engineers or your service personnel immediately.

## 13.2 Maintenance Safety Information

---

### WARNING

---

- **Stop using the equipment for any signs of visible damages. If damaged, contact your service personnel.**
  - **Follow the maintenance and testing schedule or local regulations to perform testing and maintenance. Not implementing the maintenance schedule may cause equipment failure and possible health hazards.**
  - **No modification of this equipment is allowed.**
  - **This equipment contains no user serviceable parts.**
  - **Do not open the equipment housings. The safety checks or maintenance involving any disassembly of the equipment should be performed by professional servicing personnel. Otherwise, undue equipment failure and possible health hazards could result.**
  - **The service personnel must be properly qualified and thoroughly familiar with the operation of the equipment.**
- 

### CAUTION

---

- **The equipment and accessories shall not be served or maintained while in use with a patient.**
  - **If a problem occurs to the equipment, contact the service personnel.**
  - **At the end of its service life, the equipment, as well as its accessories, must be disposed of in compliance with the guidelines regulating the disposal of such products. If you have any questions concerning disposal of the equipment, please contact Mindray.**
- 

### NOTE

---

- **If needed, contact the manufacture for circuit diagrams, component part lists, descriptions, calibration instructions, or other information concerning the repair of the equipment.**
- 

## 13.3 Checking Software Information

You may be asked for information on the equipment software.

To view the system software information, Press  and select **Version** from the **System** column.

You can view more equipment information in **Maintenance** menu. For more information, see *10.2.8 Version Information Menu*.

## 13.4 Maintaining the Main Unit

### 13.4.1 Visual Inspection

A visual inspection should be performed before the equipment is first used every day. Check that the following requirements are followed:

- The enclosure and display screen are free from cracks or other damages.
- All hard keys function properly.
- Connectors, plugs, and cables are not damaged and kinked.
- Power cord and patient cable are securely connected with the equipment.
- Recorder paper is properly loaded and sufficient.
- Battery is installed and has sufficient charge.
- Chest electrode bulbs are free from cracks and limb electrodes can properly clamp.

### 13.4.2 Thorough Inspection

After your equipment has been used for 6 to 12 months, or whenever your equipment is repaired or upgraded, a thorough inspection should be performed by qualified service personnel to ensure the reliability.

Check that the following requirements are followed:

- The environment and power supply meet the requirements.
- The equipment and accessories have no mechanical damages.
- The power cord is not damaged and the insulation is in good condition.
- Specified accessories are used.
- The battery meets the performance requirements.
- The recorder functions correctly and the recorder paper meets the requirements.
- The equipment works correctly.

### 13.4.3 Electrical Safety Tests

Electrical safety tests should be performed by qualified service personnel only. For more information, see *D Electrical Safety Inspection*.

## 13.5 Maintaining the Battery

For details about battery maintenance, see *11.6 Conditioning the Battery* and *11.7 Checking Battery Performance*.

## 13.6 Caring Accessories

To ensure proper performance of cables and leadwires, follow these guidelines:

- Store cables and leadwires in a dry and well-ventilated place.
- Hang cables and leadwires vertically or around a big wheel, avoiding twisting or sharp-angle bending.
- Do not coil cables or leadwires around the equipment.

## 13.7 Storing Paper Reports

A proper storage of paper reports can help to slow down paper fading. To store paper reports, follow these guidelines:

- Store reports in a cool, dark, and dry place, avoiding high temperature, moisture and direct sunlight.
- Store each report separately in a paper bag, avoid long-term overlapping or heavy pressure.
- Avoid long-term exposure to bright light and ultraviolet sources.
- Avoid contact with polyvinyl chloride or other chemicals which cause yellowing and fading.
- Avoid contact with cleaning fluids and solutions, such as alcohols, ketones, esters, ether, and so on.

**This page intentionally left blank.**

# 14 Accessories

The accessory material that contacts the patients has undertaken the bio-compatibility test and is verified to be in compliance with ISO 10993-1.

## WARNING

- **Use accessories specified in this chapter. Using other accessories may cause damage to the equipment or not meet the claimed specifications.**
- **Single-use accessories are not designed to be reused. Reuse may cause a risk of contamination and affect the measurement accuracy.**

## CAUTION

- **The accessories may not meet the performance specifications if stored or used outside the specified temperature and humidity ranges. If accessory performance is degraded due to aging or environmental conditions, contact your service personnel.**
- **Check the accessories and their packages for any sign of damage. Do not use them if any damage is detected.**
- **Use the accessories before the expiry date if their expiry date is indicated.**
- **The disposable accessories shall be disposed of according to hospital's regulations.**

## 14.1 ECG Accessories

Model	PN	Description	Applicable Patient
EC6408**	040-001642-00	12-pin integrative patient cable, reusable, AHA, $\Phi$ 4 banana plugs, defibrillation-proof	Adult
EC6409**	040-001643-00	12-pin integrative patient cable, reusable, AHA, clip (MR), defibrillation-proof	Adult, Pediatric
EC6410**	040-001644-00	12-pin integrative patient cable, reusable, IEC, $\Phi$ 4 banana plugs, defibrillation-proof	Adult
EC6411**	040-001645-00	12-pin integrative patient cable, reusable, IEC, clip (MR), defibrillation-proof	Adult, Pediatric
ECG-FD09X4	040-007423-00	12-pin integrative patient cable, reusable, AHA, $\Phi$ 4 banana plugs, defibrillation-proof	Adult
ECG-FD10X4	040-007643-00	12-pin integrative patient cable, reusable, IEC, $\Phi$ 4 banana plugs, defibrillation-proof	Adult
ECG-FJ01	040-007640-00	Multifunction limb electrode, reusable, IEC, copper alloy (MR)	Adult
ECG-FJ01	040-007641-00	Multifunction limb electrode, reusable, IEC, Ag/AgCl (MR)	Adult
ECG-FJ02	040-007639-00	Multifunction limb electrode, reusable, AHA, copper alloy (MR)	Adult
ECG-FJ02	040-007642-00	Multifunction limb electrode, reusable, Ag/AgCl (MR)	Adult
ECG-FQX41	040-007428-00	Multifunction chest electrode, reusable	Adult
ECG-FQX42	040-007429-00	Multifunction chest electrode, reusable	Adult
SF06	040-002711-00	Disposable electrode, 5 pcs/package	Adult

Model	PN	Description	Applicable Patient
SF07	040-002833-00	Disposable electrode	Pediatric, Neonate
TJ-V001A-P	040-001646-00	Multifunction electrode adapter	Adult, Pediatric
15-25	0000-10-10775	Reusable electrode gel	All

## 14.2 Others

PN	Description
022-000600-00	Rechargeable lithium-ion battery
1000-21-00122	Grounding cables
095-002708-00	Recorder paper, folded, 80mm×70m×200 pages
095-003380-00	Recorder paper, folded, 80mm×70m×200 pages
095-003386-00	Recorder paper, rolled, 80mm×20m
M002-10-69954	Recorder paper, rolled
009-016580-00	Power cord
009-016581-00	Power cord, American
009-016582-00	Power cord, UK
009-016583-00	Power cord, European
009-007190-00	Power cord, Indian
009-001791-00	Power cord, South African
009-001075-00	Power cord, Brazil
009-007191-00	Power cord, Swiss
009-002636-00	Power cord, Australian
009-016788-00	Power cord, Korean
045-001370-00	Barcode reader mounting kit
115-008393-00	1D barcode reader kit
023-002134-00	2D barcode reader
025-000038-00	RFID handheld 2D barcode reader
025-000256-00	Medical-grade 2D barcode reader
048-003791-00	Reusable carrying case
045-006372-00	Trolley
115-032940-00	CardioVista ECG Viewer software kit

# A Specifications

---

## A.1 Safety Specifications

### A.1.1 Safety Classifications

The equipment is classified, according to IEC 60601-1:

Type of protection against electrical shock	Class I, equipment energized from an internal electrical power source.
Degree of protection against electrical shock	Type CF defibrillation proof
Degree of protection against harmful ingress of solid Degree of protection against harmful ingress of water	IP20
Degree of safety of application in the presence of flammable anesthetic mixture with air or with oxygen or nitrous oxide	The equipment is not suitable for use in the presence of a flammable anesthetic mixture with air or with oxygen or nitrous oxide
Mode of operation	Continuous
Degree of mobility	Portable

### A.1.2 Environmental Specifications

---

#### CAUTION

---

- **The equipment may not meet the performance specifications if stored or used outside the specified temperature and humidity ranges. If the performance of the equipment is degraded due to aging or environmental conditions, contact your service personnel.**
- 

Item	Temperature	Relative humidity	Barometric
Operating condition	5°C to 40°C	15% to 95%, non-condensing	427.5 mmHg to 805.5 mmHg (57.0 kPa to 107.4 kPa)
Storage condition	-20°C to 60°C	10% to 95%, non-condensing	120 mmHg to 805.5 mmHg (16.0 kPa to 107.4 kPa)

## A.2 Power Supply Specifications

### A.2.1 AC Power Specifications

Input voltage	100 to 240 VAC
Input current	1.0 to 0.5A
Frequency	50/60Hz

### A.2.2 Battery Specifications

Battery type	Rechargeable lithium-ion battery
Battery voltage	10.95V
Battery capacity	2600 mAh
Battery charge time	At an ambient temperature of 25°C±5 °C: <ul style="list-style-type: none"><li>• Less than 3 hours to 90% and less than 3.5 hours to 100% with equipment turned off.</li><li>• Less than 6 hours to 90% and less than 7 hours to 100% with equipment turned on (no recording).</li></ul>
Battery run time	At least 500 auto reports, or 2 hours of continuous paper recording, or 6 hours of paperless recording. Testing condition: <ul style="list-style-type: none"><li>• Ambient temperature of 25°C±5 °C.</li><li>• Standard equipment configuration (screen brightness set to the factory default, Wi-Fi is not configured, barcode reader is not connected).</li><li>• The equipment loads the default configurations.</li></ul>
Shutdown delay	at least 5 minutes after the low battery alarm first occurs.

## A.3 Physical Specifications

Dimensions (Length × Width × Height)	≤ 270 mm×210 mm×60 mm
Weight	≤ 1.5 kg (including battery and recorder, excluding recorder paper and cables)

## A.4 Hardware Specifications

### A.4.1 Display Screen

Screen type	Color TFT LCD
Screen size	5 inches
Resolution	800×480 pixels

### A.4.2 Recorder

Method	High-resolution thermal recorder
Number of waveform channels	4 at maximum
Printing resolution	Vertical resolution: 8 dots/mm Horizontal resolution: at least 32 dots/mm (25 mm/s paper speed), or 16 dots/mm (50 mm/s paper speed)

Recorder paper	Paper type: rolled paper, folded paper Paper size: 80 mm×20 m (rolled paper), 80mm×70m×200 pages (folded paper)
Paper speed	5 mm/s, 12.5 mm/s, 25 mm/s, 50 mm/s. Error no more than ± 5%

### A.4.3 LEDs

Power-on LED	1 (green)
AC power LED	1 (green)
Battery LED	1 (two color-coded: orange and green)

### A.4.4 Audio Indicators

Buzzer	Gives power-on tone, heartbeat tone, acquisition done tone and failure tone
--------	---

### A.4.5 External Connectors

Power input	1, AC power input with equipotential grounding terminal, connects the external power supply.
Network connector	1 RJ45 connector, 100 Base-TX, IEEE 802.3, connects a standard network cable.
USB connector	2 USB 2.0 connectors, connects the USB drive and barcode reader.
Patient cable connector	1, connects patient cable for ECG acquisition.

## A.5 Data Storage

Data stored in the equipment is not affected by a power failure.

The equipment store 1200 ECG reports.

## A.6 Wi-Fi Specifications

Protocol	IEEE 802.11a/b/g/n/ac/ax
Modulation mode	BPSK, QPSK, 16QAM, 64QAM, 256QAM, 1024QAM
Operating frequency	2400 MHz to 2483.5 MHz 5150 MHz to 5250 MHz, 5250 MHz to 5350 MHz, 5470 MHz to 5725 MHz, 5725 MHz to 5850 MHz, 5925 MHz to 7125 MHz
Wireless baud rate	IEEE 802.11a: 6 Mbps to 54 Mbps IEEE 802.11b: 1 Mbps to 11 Mbps IEEE 802.11g: 6 Mbps to 54 Mbps IEEE 802.11n: MCS0-MCS7 IEEE 802.11ac: MCS0-MCS9 IEEE 802.11ax: MCS0-MCS11
Output power	≤ 20 dBm (CE requirement: detection mode- RMS)
Operating mode	As station, access AP for data transmission
Data security	Standards: WPA/WPA2-PSK, WPA/WPA2-EAP, WPA3-OWE, WPA3-SAE, WPA3-EAP EAP method: EAP-TTLS, EAP-TLS, PEAP-MsChapV2, PEAP-TLS, PEAP-GTC, LEAP, EAP-FAST Encryption: TKIP, AES
Distinct vision distance	The distinct vision distance between the equipment and the AP: ≥ 50 m.

Wi-Fi performance	
System capacity, interference immunity and network stability	<p>Meets the following requirements:</p> <ul style="list-style-type: none"> <li>The total delay of report transmission from the equipment to the CMS or Cardio Vista <math>\leq</math> 5 seconds.</li> <li>The retransmission percentage for data with over 5-second delay: <math>\leq</math> 0.1%.</li> </ul>
Test conditions	<p>Meets the following conditions simultaneously:</p> <ul style="list-style-type: none"> <li>Number of the equipments supported by a single AP: <math>\leq</math> 8.</li> </ul> <p>NOTE: In the worst case, one ECG room contains four exam rooms, providing two equipments in each room.</p> <ul style="list-style-type: none"> <li>The weakest strength of the AP signal where the equipment is located is not less than -65 dBm.</li> <li>The distance between the interfering devices and the equipment is greater than 20 cm. A Wi-Fi interference (no greater than -85 dBm) in the same channel and a Wi-Fi interference (no greater than -50 dBm) in an adjacent-channel are presented synchronously. The interfering devices include, but are not limited to, 2.4 G wireless devices, cellular mobile networks, microwave ovens, interphones, cordless phones, and ESU equipment. The interfering devices do not include Wi-Fi devices.</li> </ul>

---



---

## WARNING

---

- Do perform all network functions of data communication within an enclosed network.
- 
- 

## A.7 Measurement Specifications

ECG	
Standards	Meet standards of IEC 60601-2-25
Measurement mode	Auto, manual, rhythm
Lead type	12-lead
ECG standard	AHA, IEC
Display sensitivity	Auto, 1.25 mm/mV ( $\times 0.125$ ), 2.5 mm/mV ( $\times 0.25$ ), 5 mm/mV ( $\times 0.5$ ), 10 mm/mV ( $\times 1$ ), 20 mm/mV ( $\times 2$ ), L=10 mm/mV C=5 mm/mV, L=20 mm/mV C=10mm/mV, less than $\pm 5\%$ error
Notch filter	50/60Hz Rejection on power frequency interference: $\geq 20$ dB
Frequency response	0.01 Hz to 500 Hz Time constant: $\geq 3.2$ s In compliance with the requirements in clause 201.12.4.107.1.1.1 of IEC 60601-2-25
Filter	The EMG filter, baseline filter and lowpass filter can be configurable: <ul style="list-style-type: none"> <li>EMG filter: 20 Hz, 35 Hz, Off</li> <li>Baseline filter: 0.01 Hz, 0.05 Hz, 0.56 Hz (BDR 0.56 Hz)</li> <li>Lowpass filter: 150 Hz, 270 Hz, 350 Hz</li> </ul>
Common mode rejection	$\geq 123$ dB (with notch filter off) $\geq 140$ dB (with notch filter on)
Analog-to-digital converter	64kHz (A/D) A/D: 24 bits Resolution: 0.1192 $\mu$ V/LSB
PACE sampling rate	96000 samples/s (A/D)
Input signal range	$\pm 10$ mV (peak-to-peak value), at 1.25 mm/mV sensitivity
Input impedance	$\geq 100$ M $\Omega$ @10 Hz, any two electrodes

Electrode offset potential tolerance	$\pm 900\text{mV}$ , less than $\pm 5\%$ sensitivity change
Minimum signal	$20\ \mu\text{Vp-p}(10\text{Hz})$
Defibrillation proof	Enduring $5000\text{V}$ ( $360\ \text{J}$ ) charge without data loss or corruption
Baseline recovery time	$< 5\ \text{s}$ (after defibrillation)
Electrode polarization recovery time	$< 10\ \text{s}$
Defibrillation energy absorption	$\leq 10\%$ ( $100\ \Omega$ load)
Calibration signal	$1\ \text{mV}$ , less than $\pm 1\%$ error
Noise level	$\leq 12.5\ \mu\text{V}$ (p-p)
AC overload protection	$10\ \text{s}$ The equipment can operate correctly after a $10\ \text{s}$ application of $50\text{Hz}/60\text{Hz}$ and $1\text{Vp-p}$ differential voltage.
Channel crosstalk	$\leq 0.5\text{mm}$ , at $10\ \text{mm/mV}$ sensitivity
Time deviation between channels	$< 100\ \mu\text{s}$
Lead-off detection current	$\leq 0.1\ \mu\text{A}$ (drive electrode $\leq 1\ \mu\text{A}$ )
Pacer detection	In high sensitivity mode: Amplitude: $\pm 500\ \mu\text{V}$ to $\pm 700\ \text{mV}$ Width: $30\ \mu\text{s}$ to $2\ \text{ms}$
	In normal mode: Amplitude: $\pm 2\ \text{mV}$ to $\pm 700\ \text{mV}$ Width: $0.1\ \text{ms}$ to $2\ \text{ms}$
<b>HR</b>	
Measurement range	$30$ to $300\ \text{bpm}$
Accuracy	$\pm 1\%$ or $\pm 1\ \text{bpm}$ , which ever is greater
Resolution	$1\ \text{bpm}$

## A.8 Software Operating Environment

Host CPU	TI AM62X
Primary programming language	C++
Operating system	Linux 5.10.109

**This page intentionally left blank.**

# B EMC and Radio Regulatory Compliance

---

## B.1 EMC

The electrocardiograph meets the requirements of IEC 60601-1-2:2014+A1:2020. All the accessories listed in *14 Accessories* also meet the requirements of IEC 60601-1-2:2014+A1:2020 when in use with this electrocardiograph.

Intended environments: professional healthcare environment.

---

### WARNING

---

- **The use of unapproved accessories may diminish system performance.**
  - **Use of components, accessories, probes, and cables other than those specified may result in increased emission or decreased immunity of system.**
  - **The system needs special precautions regarding EMC and needs to be installed and put into service according to the EMC information provided below.**
  - **Use of this electrocardiograph adjacent to or stacked with other equipment should be avoided because it could result in improper operation. If such use is necessary, The electrocardiograph and the other equipment should be observed to verify that they are operating normally.**
  - **Use of accessories, transducers and cables other than those specified or provided by the manufacturer of this electrocardiograph could result in increased electromagnetic emissions or decreased electromagnetic immunity of this electrocardiograph and result in improper operation.**
  - **Portable RF communications equipment (including peripherals such as antenna cables and external antennas) should be used no closer than 30 cm (12 inches) to any part of the system, including cables specified by the manufacturer. Otherwise, degradation of the performance of this electrocardiograph could result.**
  - **Other devices may interfere with this electrocardiograph even though they meet the requirements of CISPR.**
  - **When the input signal is below the minimum amplitude provided in technical specifications, erroneous measurements could result.**
  - **Use of portable or mobile communications devices can degrade the performance of the electrocardiograph.**
  - **The system is not intended for use in residential environments and can possibly not provide adequate protection to radio reception in such environments.**
- 

If the electrocardiograph is operated within the electromagnetic environment listed in TABLE EMC-2, TABLE EMC-3 and TABLE EMC-4, the electrocardiograph will remain safe and will provide the following basic performances:

- Defibrillation protection function
- ECG filters function
- Automated measurement
- Accuracy (heart rate, amplitude, duration, interval)
- Display
- Data storage
- Accessory identification
- Battery prompt

**TABLE EMC-1:**

<b>Guidance and Mindray Declaration - Electromagnetic Emissions</b>		
The electrocardiograph is intended for use in the electromagnetic environment specified below. The customer or the user of the electrocardiograph should assure that it is used in such an environment.		
<b>Emission test</b>	<b>Compliance</b>	<b>Electromagnetic environment - guidance</b>
RF emissions CISPR 11	Group 1	The electrocardiograph uses RF energy only for its internal function. Therefore, its RF emissions are very low and are not likely to cause any interference in nearby electronic equipment.
RF emissions CISPR 11	Class A	The electrocardiograph is suitable for use in all establishments other than domestic and those directly connected to the public low-voltage power supply network that supplies buildings used for domestic purposes.
Harmonic emissions IEC 61000-3-2	Class A	
Voltage fluctuations/flicker emissions IEC 61000-3-3	Complies	

**TABLE EMC-2:**

<b>Guidance and Mindray Declaration - Electromagnetic Immunity</b>			
The electrocardiograph is intended for use in the electromagnetic environment specified below. The customer or the user of the electrocardiograph should assure that it is used in such an environment.			
<b>Immunity test</b>	<b>IEC 60601 test level</b>	<b>Compliance level</b>	<b>Electromagnetic environment - guidance</b>
Electrostatic discharge (ESD) IEC 61000-4-2	±8 kV contact; ±2 kV, ±4 kV, ±8 kV, ±15 kV air	±8 kV contact; ±2 kV, ±4 kV, ±8 kV, ±15 kV air	Floors should be wood, concrete or ceramic tile. If floors are covered with synthetic material, the relative humidity should be at least 30%.
Electrical fast transient/burst IEC 61000-4-4	±2 kV for power supply lines; ±1 kV for input/output lines (length greater than 3 m)	±2 kV for power supply lines; ±1 kV for input/output lines (length greater than 3 m)	Mains power quality should be that of a typical commercial or hospital environment.
Surge IEC 61000-4-5	±0.5 kV, ±1 kV line(s) to line(s); ±0.5 kV, ±1 kV, ±2 kV line(s) to earth	±0.5 kV, ±1 kV line(s) to line(s); ±0.5 kV, ±1 kV, ±2 kV line(s) to earth	
Voltage dips, short interruptions and voltage variation on power supply input voltage IEC 61000-4-11	0% U <sub>T</sub> ; 0.5 cycle at 0°, 45°, 90°, 135°, 180°, 225°, 270° and 315°  0% U <sub>T</sub> ; 1 cycle 70% U <sub>T</sub> for 25/30 cycles at 0°  0% U <sub>T</sub> ; 250/300 cycle	0% U <sub>T</sub> ; 0.5 cycle at 0°, 45°, 90°, 135°, 180°, 225°, 270° and 315°  0% U <sub>T</sub> ; 1 cycle 70% U <sub>T</sub> for 25/30 cycles at 0°  0% U <sub>T</sub> ; 250/300 cycle	Mains power quality should be that of a typical commercial or hospital environment. If the user of our product requires continued operation during power mains interruptions, it is recommended that our product be powered from an uninterruptible power supply or a battery.
Power frequency (50/60 Hz) magnetic field IEC 61000-4-8	30 A/m	30 A/m	Power frequency magnetic fields should be at levels characteristic of a typical location in a typical commercial or hospital environment.
NOTE: U <sub>T</sub> is the A.C. mains voltage prior to application of the test level.			

**TABLE EMC-3:**

<b>Guidance and Mindray Declaration - Electromagnetic Immunity</b>			
The electrocardiograph is intended for use in the electromagnetic environment specified below. The customer or the user of the electrocardiograph should assure that it is used in such an environment.			
<b>Immunity test</b>	<b>IEC 60601 Test level</b>	<b>Compliance level</b>	<b>Electromagnetic environment - guidance</b>
Conducted RF IEC 61000-4-6	3 Vrms 0.15 MHz to 80 MHz  6 Vrms in ISM and amateur radio bands <sup>a</sup> between 0.15 MHz and 80 MHz	3 Vrms 0.15 MHz to 80 MHz  6 Vrms in ISM and amateur radio bands <sup>a</sup> between 0.15 MHz and 80 MHz	Portable and mobile RF communications equipment should be used no closer to any part of system, including cables, than the recommended separation distance calculated from the equation applicable to the frequency of the transmitter. Recommended separation distance: $d = 1.2 \times \sqrt{P}$ 0.15 MHz to 80 MHz $d = 1.2 \times \sqrt{P}$ 80 MHz to 800 MHz $d = 2.3 \times \sqrt{P}$ 800 MHz to 2.7 GHz
Radiated RF IEC 61000-4-3	3V/m 80 MHz to 2.7 GHz	3 V/m 80 MHz to 2.7 GHz	Where, P is the maximum output power rating of the transmitter in watts (W) according to the transmitter manufacturer and d is the recommended separation distance in meters (m).  Field strengths from fixed RF transmitters, as determined by an electromagnetic site survey <sup>b</sup> , should be less than the compliance level in each frequency range <sup>c</sup> .  Interference may occur in the vicinity of equipment marked with the following symbol: 
Proximity fields from RF wireless communications equipment IEC 61000-4-3	See the RF wireless communication equipment table in "Recommended minimum separation distances"		
Proximity magnetic fields IEC 61000-4-39	65 A/m 134.2 kHz Pulse modulation 2.1 kHz	65 A/m 134.2 kHz Pulse modulation 2.1 kHz	/
	7.5 A/m 13.56 MHz Pulse modulation 50 kHz	7.5 A/m 13.56 MHz Pulse modulation 50 kHz	
NOTE 1: At 80 MHz and 800 MHz, the higher frequency range applies.			
NOTE 2: These guidelines may not apply in all situations. Electromagnetic propagation is affected by absorption and reflection from structures, objects and people.			
<sup>a</sup> The ISM (industrial, scientific, and medical) bands between 150 kHz and 80 MHz are 6.765 MHz to 6.795 MHz; 13.553 MHz to 13.567 MHz; 26.957 MHz to 27.283 MHz; and 40.66 MHz to 40.70 MHz. The amateur radio bands between 0.15 MHz and 80 MHz are 1.8 MHz to 2.0 MHz, 3.5 MHz to 4.0 MHz, 5.3 MHz to 5.4 MHz, 7 MHz to 7.3 MHz, 10.1 MHz to 10.15 MHz, 14 MHz to 14.2 MHz, 18.07 MHz to 18.17 MHz, 21.0 MHz to 21.4 MHz, 24.89 MHz to 24.99 MHz, 28.0 MHz to 29.7 MHz and 50.0 MHz to 54.0 MHz.			
<sup>b</sup> Field strengths from fixed transmitters, such as base stations for radio (cellular/cordless) telephones and land mobile radios, amateur radio, AM and FM radio broadcast and TV broadcast cannot be predicted theoretically with accuracy. To assess the electromagnetic environment due to fixed RF transmitters, an electromagnetic site survey should be considered. If the measured field strength in the location in which the device is used exceeds the applicable RF compliance level above, the device should be observed to verify normal operation. If abnormal performance is observed, additional measures may be necessary, such as reorienting or relocating the device.			
<sup>c</sup> Over the frequency ranges 150 kHz to 80 MHz, field strengths should be less than 3V/m.			

**TABLE EMC-4:**

<b>Recommended separation distances between portable and mobile RF communications equipment and the electrocardiograph</b>						
<p>The electrocardiograph is intended for use in an electromagnetic environment in which radiated RF disturbances are controlled. The customer or the user of the electrocardiograph can help prevent electromagnetic interference by maintaining a minimum distance between portable and mobile RF communications equipment (transmitters) and the electrocardiograph as recommended below, according to the maximum output power of the communications equipment. Portable and mobile radio communications equipment (e.g. two-way radio, cellular/ cordless telephones and similar equipment) should be used no closer to any part of this electrocardiograph, including cables, than determined according to the following method:</p>						
<b>Test frequency (MHz)</b>	<b>Band (MHz)</b>	<b>Service</b>	<b>Modulation</b>	<b>Maximum power (W)</b>	<b>Distance (m)</b>	<b>Immunity test level (V/m)</b>
385	380 to 390	TETRA 400	Pulse modulation 18Hz	1.8	0.3	27
450	430 to 470	GMRS 460 FRS 460	FM $\pm$ 5 kHz deviation 1 kHz sine	2	0.3	28
710	704 to 787	LTE Band 13,17	Pulse modulation 217 Hz	0.2	0.3	9
745						
780						
810	800 to 960	GSM 800/900, tetra 800, iDEN 820, CDMA 850, LTE Band 5	Pulse modulation 18 Hz	2	0.3	28
870						
930						
1720	1700 to 1990	GSM 1800, CDMA 1900, GSM 1900, DECT, LTE Band 1, 3, 4, 25, UMTS	Pulse modulation 217 Hz	2	0.3	28
1845						
1970						
2450	2400 to 2570	Bluetooth, WLAN, 802.11 b/g/n, RFID 2450, LTE Band 7	Pulse modulation 217 Hz	2	0.3	28
5240	5100 to 5800	WLAN, 802.11 a/n	Pulse modulation 217 Hz	0.2	0.3	9
5500						
5785						
1845						
1970						
5785						

**TABLE EMC-5:**

<b>Recommended separation distances between portable and mobile RF communications equipment and the electrocardiograph</b>				
The electrocardiograph is intended for use in an electromagnetic environment in which radiated RF disturbance are controlled. The customer or the user of the electrocardiograph can help prevent electromagnetic interference by maintaining a minimum distance between portable and mobile RF communication equipment (transmitters) and system as recommended below, according to the maximum output power of the communication equipment.				
<b>Rated maximum output power of transmitter (W)</b>	<b>Separation distance according to frequency of transmitter (m)</b>			
	150 kHz to 80 MHz out ISM and amateur radio bands $d = 1.2 \times \sqrt{P}$	150 kHz to 80 MHz in ISM and amateur radio bands $d = 2 \times \sqrt{P}$	80 MHz to 800 MHz $d = 1.2 \times \sqrt{P}$	800 MHz to 2.7 GHz $d = 2.3 \times \sqrt{P}$
0.01	0.12	0.2	0.12	0.23
0.1	0.38	0.64	0.38	0.73
1	1.2	2	1.2	2.3
10	3.8	6.4	3.8	7.3
100	12	20	12	23
For transmitters at a maximum output power not listed above, the recommended separation distance in meters (m) can be determined using the equation applicable to the frequency of the transmitter, where P is the maximum output power rating of the transmitter in watts (W) according to the transmitter manufacturer. NOTE 1: At 80 MHz and 800 MHz, the higher frequency range applies. NOTE 2: These guidelines may not apply in all situations. Electromagnetic propagation is affected by absorption and reflection from structures, objects and people.				

## B.2 Radio Regulatory Compliance

For details about RF parameters, see *A.6 Wi-Fi Specifications*. Wireless parameters include operating frequency and modulation mode.



The electrocardiograph complies with the essential requirements and other relevant provisions of Directive 2014/53/EU.

---

### WARNING

---

- **Keep a distance of at least 20 cm away from the electrocardiograph when wireless function is in use.**
-

**This page intentionally left blank.**

# C Troubleshooting

## C.1 General Problems

Symptom	Possible Cause	Corrective actions
The equipment cannot be started up.	<ul style="list-style-type: none"> <li>The equipment is not connected to the AC power or the power cord is not properly connected.</li> <li>External power supply problems, such as damaged power cord or AC power outlet.</li> <li>Battery is not installed or has no power when the AC power is not connected.</li> </ul>	<ul style="list-style-type: none"> <li>Make sure the equipment is properly connected to the AC power.</li> <li>Make sure the equipment is turned on. Replace the power cord or AC power outlet if necessary.</li> <li>Make sure the battery is installed and has sufficient power. Otherwise, connect the equipment to the AC power to run the equipment and charge the battery.</li> </ul>
The display is completely blank.	The equipment is in the Standby status, or is turned off.	<ul style="list-style-type: none"> <li>Press any hard key to exit the Standby status.</li> <li>Press the power switch to turn on the equipment.</li> </ul>
The display is frozen.	Software failure	<ul style="list-style-type: none"> <li>Press and hold the power switch for 10 seconds to forcibly shut down the equipment.</li> <li>Restart the equipment.</li> </ul>
Wrong characters are inputted.	Wrong input method	Make sure the input method is correct.
No response to hard key press.	Software failure	<ul style="list-style-type: none"> <li>Press and hold the power switch for 10 seconds to forcibly shut down the equipment.</li> <li>Restart the equipment.</li> </ul>
The barcode reader cannot read the patient ID.	The barcode reader is not properly connected to the equipment.	Properly connect the barcode reader to the USB port of the equipment.
The recorder does not work.	<ul style="list-style-type: none"> <li>Recorder paper is not loaded.</li> <li>The paper tray is not closed in place.</li> <li>Print head is too hot.</li> </ul>	<ul style="list-style-type: none"> <li>Make sure the recorder paper is properly loaded.</li> <li>Make sure the paper tray is closed in place.</li> <li>Wait until the print head cools down.</li> </ul>
Paper is jammed or misaligned.	<ul style="list-style-type: none"> <li>Unspecified paper is used.</li> <li>Recorder paper is not properly loaded.</li> <li>Paper jam occurs during the printing.</li> </ul>	<ul style="list-style-type: none"> <li>Make sure specified paper is used.</li> <li>Take out the paper and tear off the jammed part. Reload the paper as described in <i>3.4.3 Loading the Paper</i>.</li> <li>Make sure the paper tray spacer is placed appropriately for the paper size. Refer to <i>3.4.3 Loading the Paper</i> for detail.</li> </ul>
Some or all leads have no waveforms.	<ul style="list-style-type: none"> <li>Defective or broken patient cable.</li> <li>The patient cable is not connected.</li> <li>Electrodes are not applied, or leadwires are entanglement or bending.</li> </ul>	<ul style="list-style-type: none"> <li>Replace the patient cable with a new one.</li> <li>Check the patient cable is properly connected.</li> <li>Make sure electrodes are correctly applied as described in <i>5.5 Applying Electrodes</i>.</li> </ul>
Baseline drift for one or more leads.	<ul style="list-style-type: none"> <li>Unspecified electrodes are used or different types and brands of electrodes are mixed.</li> <li>Poor skin preparation.</li> <li>Electrode problems.</li> </ul>	<ul style="list-style-type: none"> <li>Use specified accessories. Do not mix electrode types or brands.</li> <li>Prepare the patient skin as described in <i>5.3 Preparing the Skin</i>.</li> <li>Make sure electrodes are correctly applied as described in <i>5.5 Applying Electrodes</i>. Check for defective or expired electrodes. Replace with disposable electrodes if necessary.</li> </ul>

Symptom	Possible Cause	Corrective actions
ECG waveforms display unacceptable noise.	<ul style="list-style-type: none"> <li>• Patient movement during ECG acquisition.</li> <li>• AC interference from external devices or improper notch filter setting.</li> <li>• Muscle artifact or improper muscle artifact filter setting.</li> <li>• Poor skin preparation.</li> <li>• Electrode problems.</li> </ul>	<ul style="list-style-type: none"> <li>• Make sure the patient keep still during ECG acquisition.</li> <li>• Turn of the adjacent devices or move this equipment away from the interference if possible. Properly set the notch filter.</li> <li>• Properly set the muscle artifact filter.</li> <li>• Prepare the patient skin as described in <i>5.3 Preparing the Skin</i>.</li> <li>• Make sure electrodes are correctly applied as described in <i>5.5 Applying Electrodes</i>. Check for defective or expired electrodes. Replace with disposable electrodes if necessary.</li> </ul>
The equipment automatically shuts down.	<ul style="list-style-type: none"> <li>• The auto shutdown function is enabled.</li> <li>• The battery is depleted when the equipment runs on battery power.</li> </ul>	<ul style="list-style-type: none"> <li>• Turn on the equipment.</li> <li>• Connect the equipment to AC power to run the equipment and charge the battery.</li> </ul>
Partially missing or not clear printout.	<ul style="list-style-type: none"> <li>• Dirty print head.</li> <li>• Some thermal points on print head are damaged.</li> </ul>	Clean the print head. If the problem persists, contact your service personnel.
The display is too dark to be seen clearly.	The setting of brightness is low.	Adjust screen brightness as described in <i>3.8.3 Adjusting the Screen Brightness</i> .

## C.2 Messages

The equipment provides two types of messages in the message area.

- Message 1: locates in top row of the message area. It displays other messages except messages relevant to lead status and noise existence.
- Message 2: locates in bottom row of the message area. It displays messages relevant to lead status and noise existence.

### NOTE

- **When multiple messages occur, they will be displayed circularly.**
- **The equipment always gives a reminder if failure-related message occurs. For details on configuring the reminder tone, see *3.8.4 Adjusting the Volume*.**

### C.2.1 Message 1

Message	Possible Cause	Corrective actions
Low Battery	The battery power is too low.	Connect the equipment to the AC power to run the equipment and charge the battery.
Critically Low Battery	The battery power is almost depleted.	Immediately connect the equipment to the AC power to run the equipment and charge the battery.
Battery Error. Please contact your service personnel.	Failure is detected when the battery is being charged.	Contact your service personnel.
Recorder Unavailable	Communication with the recorder fails or the recorder does not work.	<ol style="list-style-type: none"> <li>1. Make sure that the recorder paper is properly loaded.</li> <li>2. Make sure that the print head is not overheat.</li> <li>3. If the problem persists, contact your service personnel.</li> </ol>
Recorder Head Hot: Please Wait	Print head becomes too hot due to heavy use.	Stop printing and wait until the print head cools down.

Message	Possible Cause	Corrective actions
Recorder Door Open	Paper tray is open.	Push the paper tray back in position and start the printing again.
Recorder Out Of Paper	The thermal recorder runs out of paper.	Load the paper as described in 3.4.3 <i>Loading the Paper</i> .
Paper Type Error	<ul style="list-style-type: none"> <li>Unspecified paper is used.</li> <li>The black mark on the recorder paper cannot be detected.</li> </ul>	<ol style="list-style-type: none"> <li>Make sure the specified paper is used.</li> <li>Load the paper as described in 3.4.3 <i>Loading the Paper</i>.</li> </ol>
Printer Unavailable	<ul style="list-style-type: none"> <li>The printer is not turned on.</li> <li>The printer model is not the specified one.</li> <li>The printer automatically shuts down.</li> <li>Communication with the printer fails.</li> </ul>	<ol style="list-style-type: none"> <li>Turn on the printer.</li> <li>Make sure the printer model is the specified one.</li> <li>Disable the auto shutdown function on the printer.</li> <li>Disable the smart drive installation function on the printer.</li> <li>Make sure the printer is properly connected with the equipment.</li> <li>If the problem persists, contact your service personnel.</li> </ol>
ECG Module Error. Please contact your service personnel.	Damaged ECG board or software failure causes ECG communication error or communication stops.	Contact your service personnel.
Device Voltage Abnormal. Please contact your service personnel.	The voltage of PCBA power supply is abnormal.	Contact your service personnel.
Storage Error	The internal storage is damaged.	Restart the equipment. If the problem persists, contact your service personnel.
USB drive not found.	The system fails to find the USB drive.	<ol style="list-style-type: none"> <li>Make sure that the USB drive is properly connected to the equipment.</li> <li>If the problem persists, contact your service personnel.</li> </ol>
Storage space is nearly full	Less than 10 files can be stored.	Delete useless files to release storage space.
RT Clock Reset Required. Please contact your service personnel.	The real-time clock displays the initial value because button cell failed and reset, or button cell is not available.	Contact your service personnel.
Acquiring...	The equipment is acquiring an ECG in the Rhythm mode.	Wait until countdown is reached. If needed, press  or <b>F4</b> to stop.
ECG acquiring... The printing will be started after acquisition.	The pre-acquisition function is enabled, and acquired ECG data is less than 10 seconds before you start acquiring an ECG.	Wait until sufficient data is acquired.
Analyzing...	The algorithm is analyzing acquired ECG data in the Auto mode.	Wait until analysis is completed.
Analysis Failed	The algorithm fails to analyze acquired ECG data and is unable to give diagnostic results.	See the physician's guide to corresponding algorithm.
Reanalyzing...	The equipment is reanalyzing ECG data after you modify patient information.	Wait until reanalysis is completed.
Generating Preview...	The equipment is generating a preview of the ECG report.	Wait until the preview is generated.
Printing...	The report is being printed out.	Wait until the printing is completed. If needed, press the <b>F4</b> hard key.
Printing Stopped	Printing is manually stopped.	/
Printing Retry:	The printing fails, the equipment try to start printing again.	Wait until the printing is completed.

Message	Possible Cause	Corrective actions
Printing Failed:	The external printer runs out of paper or cannot be connected.	Check the printer, and start printing again.
Sending....	Files are being transmitted to an external system.	Wait until all files have been transmitted.
Sent Successfully	The files are successfully transmitted to an external system.	/
Sending Failed	The files fail to be transmitted to the an external system.	<ol style="list-style-type: none"> <li>1. Check network connection and network settings. Then try again.</li> <li>2. If the problem persists, contact your service personnel.</li> </ol>
Configurations exported successfully.	Configuration is successfully exported.	/
Exporting configurations failed.	Configuration fails to be exported.	<ol style="list-style-type: none"> <li>1. Make sure that the USB drive is properly connected to the equipment and file system is not damaged.</li> <li>2. Make sure that the USB drive has sufficient space.</li> </ol>
Configurations imported successfully.	Configuration is successfully imported.	/
Importing configurations failed.	Configuration fails to be imported.	<ol style="list-style-type: none"> <li>1. Make sure that the USB drive is properly connected to the equipment and file system is not damaged.</li> <li>2. If the problem persists, contact your service personnel.</li> </ol>
Connection failed, please check network.	The server cannot be connected when files are transmitted to the server.	<ol style="list-style-type: none"> <li>1. Check network connection and network settings. Then try again.</li> <li>2. If the problem persists, contact your service personnel.</li> </ol>
Incorrect username or password	Wrong user name or password is entered.	Enter the correct user name and password.
LAN1 IP Address Conflict	IP address conflict.	<ol style="list-style-type: none"> <li>1. Check network connection and network settings. Then try again.</li> <li>2. If the problem persists, contact your service personnel.</li> </ol>
WLAN IP Address Conflict		
System is shutting down...	The system is shutting down.	Wait until the equipment shuts down.

## C.2.2 Message 2

Message	Possible Cause	Corrective actions
Good Contact	All electrodes and leadwires are properly connected.	/
Limb Lead Off	<ul style="list-style-type: none"> <li>• RL lead off or more than one limb lead off.</li> <li>• Patient cable is detached from the equipment.</li> </ul>	<ol style="list-style-type: none"> <li>1. Check corresponding electrodes and leadwires. Re-apply the electrodes or reconnect the leadwires if necessary.</li> <li>2. Make sure that patient cable is properly connected to the equipment.</li> </ol>
Lead Off: XX*	The referred lead is off.	Check corresponding electrodes and leadwires. Re-apply the electrodes or reconnect the leadwires if necessary.

Message	Possible Cause	Corrective actions
Muscle Artifact: XX*	Noise or artifact is detected.	<ol style="list-style-type: none"> <li>1. Perform skin preparation again.</li> <li>2. Re-apply the electrodes, avoiding muscular areas.</li> </ol>
Baseline Drift: XX*		<ol style="list-style-type: none"> <li>1. Check for excessive patient movement or muscle tremor.</li> <li>2. Check that all electrodes and leadwires are properly connected.</li> </ol>
Powerline Noise: XX*		<ol style="list-style-type: none"> <li>1. Check that notch filter is switch on.</li> <li>2. Check that the equipment is properly connected to the earth.</li> </ol>
Poor Contact: XX*	The referred lead is not properly connected.	Check corresponding electrodes and leadwires. Re-apply the electrodes or reconnect the leadwires if necessary.
*: XX represents LA/L, LL/F, RA/R, V1(C1) to V6(C6).		

**This page intentionally left blank.**

# D Electrical Safety Inspection

The following electrical safety tests are recommended as part of a comprehensive preventive maintenance program. They are a proven means of detecting abnormalities that, if undetected, could prove dangerous to either the patient or the operator. Additional tests may be required according to local regulations.

All tests can be performed by using commercially available safety analyzer test equipment. These procedures assume the use of a 601PROXL International Safety Analyzer or equivalent safety analyzer. Other popular testers complying with IEC 60601-1 used in Europe, such as Fluke, Metron or Gerb, may require modifications to the procedure. Please follow the instructions of the analyzer manufacturer.

The electrical safety inspection should be periodically performed ever two years. The safety analyzer also proves to be an excellent troubleshooting tool to detect abnormalities of line voltage and grounding, as well as total current loads.

## D.1 Power Cord Plug

Test Item		Acceptance Criteria
The power plug	The power plug pins	No broken or bent pin. No discolored pins.
	The plug body	No physical damage to the plug body.
	The strain relief	No physical damage to the strain relief. No plug warmth for device in use.
	The power plug	No loose connections.
The power cord		No physical damage to the cord. No deterioration to the cord.
		For devices with detachable power cords, inspect the connection at the device.
		For devices with non-detachable power cords, inspect the strain relief at the device.

## D.2 Device Enclosure and Accessories

### D.2.1 Visual Inspection

Test Item	Acceptance Criteria
The enclosure and accessories	No physical damage to the enclosure and accessories.
	No physical damage to meters, switches, connectors, etc.
	No residue of fluid spillage (e.g., water, coffee, chemicals, etc.).
	No loose or missing parts (e.g., knobs, dials, terminals, etc.).

### D.2.2 Contextual Inspection

Test Item	Acceptance Criteria
The enclosure and accessories	No unusual noises (e.g., a rattle inside the case).
	No unusual smells (e.g., burning or smoky smells, particularly from ventilation holes).
	No taped notes that may suggest device deficiencies or operator concerns.

## D.3 Device Labeling

Check the labels provided by the manufacturer or the healthcare facilities are present and legible.

- Main unit label
- Integrated warning labels

## D.4 Protective Earth Resistance

1. Plug the probes of the analyzer into the device's protective earth terminal and protective earth terminal of the AC power cord.
2. Test the earth resistance with a current of 25 A.
3. Verify the resistance is less than limits.

### LIMITS

For all countries,  $R = 0.2 \Omega$  Maximum

## D.5 Earth Leakage Test

Run an Earth Leakage test on the device being tested before performing any other leakage tests.

The following outlet conditions apply when performing the Earth Leakage test:

- normal polarity (Normal Condition)
- reverse polarity (Normal Condition)
- normal polarity with open neutral (Single Fault Condition)
- reverse polarity with open neutral (Single Fault Condition)

### LIMITS

For UL60601-1,

- ◆ 300  $\mu$ A in Normal Condition
- ◆ 1000  $\mu$ A in Single Fault Condition

For IEC60601-1,

- ◆ 500  $\mu$ A in Normal Condition
- ◆ 1000  $\mu$ A in Single Fault Condition

## D.6 Patient Leakage Current

Patient leakage currents are measured between a selected applied part and mains earth. All measurements have a true RMS only

The following outlet conditions apply when performing the Patient Leakage Current test.

- normal polarity (Normal Condition)
- reverse polarity (Normal Condition)
- normal polarity with open neutral (Single Fault Condition)
- reverse polarity with open neutral (Single Fault Condition)
- normal polarity with open earth (Single Fault Condition)
- reverse polarity with open earth (Single Fault Condition)

### LIMITS

For CF  applied parts

- ◆ 10 $\mu$ A in Normal Condition
- ◆ 50 $\mu$ A in Single Fault Condition

## D.7 Mains on Applied Part Leakage

The Mains on Applied Part test applies a test voltage, which is 110% of the mains voltage, through a limiting resistance, to selected applied part terminals. Current measurements are then taken between the selected applied part and earth. Measurements are taken with the test voltage (110% of mains) to applied parts in the normal and reverse polarity conditions

The following outlet conditions apply when performing the Mains on Applied Part test.

- Normal Polarity
- Reversed Polarity

### LIMITS

- For CF  applied parts: 50 µA

## D.8 Patient Auxiliary Current

Patient Auxiliary currents are measured between any selected Applied Part connector and the remaining Applied Part connectors. All measurements may have a true RMS only response.

The following outlet conditions apply when performing the Patient Auxiliary Current test.

- normal polarity (Normal Condition)
- reverse polarity (Normal Condition)
- normal polarity with open neutral (Single Fault Condition)
- reverse polarity with open neutral (Single Fault Condition)
- normal polarity with open earth (Single Fault Condition)
- reverse polarity with open earth (Single Fault Condition)

### LIMITS

For CF  applied parts,

- ◆ 10µA in Normal Condition
- ◆ 50µA in Single Fault Condition

### NOTE

- 
- **Make sure the safety analyzer is authorized comply with requirement of IEC60601-1.**
  - **Follow the instructions of the analyzer manufacturer.**
-

**This page intentionally left blank.**

# E Abbreviations

Abbreviation	Full Name
°C	centigrade
°F	fahrenheit
μA	microampere
μV	microvolt
μs	microsecond
Ω	ohm
A	ampere
A/D	analog/digital
AC	alternating current
AES	advanced encryption standard
Adu	adult
AHA	American Heart Association
AP	access point
aVF	left foot augmented lead
aVL	left arm augmented lead
aVR	right arm augmented lead
BP	blood pressure
bpm	beat per minute
bps	bit per second
CE	Conformité Européenne
CISPR	International Special Committee on Radio Interference
cm	centimeter
CMS	central monitoring system
dB	decibel
dBm	decibel miliwatt
ECG	electrocardiograph
EMC	electromagnetic compatibility
ESU	electrosurgical unit
FDA	Food and Drug Administration
g	gram
GHz	gigahertz
h	hour
HIS	hospital information system
HR	heart rate

<b>Abbreviation</b>	<b>Full Name</b>
Hz	hertz
ID	identification
IEC	International Electrotechnical Commission
IEEE	Institute of Electrical and Electronic Engineers
IP	internet protocol
kg	kilogram
kPa	kilopascal
kV	kilovolt
L	litre
LA	left arm
lb	pound
LED	light emitting diode
LL	left leg
LSB	least significant bit
m	meter
MΩ	megaohm
mAh	Milliampere hour
MHz	megahertz
min	minute
mm	millimeter
mm/s	millimeter/second
mmHg	millimeters of mercury
ms	millisecond
mV	millivolt
MR	magnetic resonance
MRI	magnetic resonance imaging
N/A	not applied
Neo	neonate
Ped	pediatric
R	right
RA	right arm
RL	right leg
s	second
TKIP	temporal key integrity protocol
USB	universal serial bus
V	volt
VAC	volts alternating current

# F Declaration of Conformity

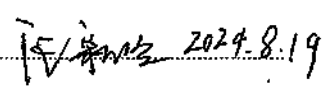
Declaration of Conformity VI.0		<b>CE</b>
<b>Declaration of Conformity</b>		
<b>Manufacturer:</b>	Shenzhen Mindray Bio-Medical Electronics Co., Ltd. Mindray Building, Keji 12th Road South, High-Tech Industrial Park, Nanshan, Shenzhen, 518057, P. R. China	
<b>EC-Representative:</b>	Shanghai International Holding Corp. GmbH (Europe) Eiffestraße 80 20537 Hamburg, Germany	
<b>Product:</b>	<b>Electrocardiograph</b>	
<b>Model:</b>	BeneHeart R900/ BeneHeart R90/ BeneHeart R700/ BeneHeart R70/ BeneHeart R300/ BeneHeart R30	
<p><b>We herewith declare under our sole responsibility that the above mentioned products meet the provisions of the Council Directive 2014/53/EU concerning radio equipment. All supporting documentation is retained under the premises of the manufacturer.</b></p>		
<b>Standards Applied:</b>		
<input checked="" type="checkbox"/> EN 60601-1:2006+A1:2013+A2:2021	<input checked="" type="checkbox"/> EN 60601-1-2: 2015/A1:2021	
<input checked="" type="checkbox"/> EN 62311:2020	<input checked="" type="checkbox"/> EN 50385:2002	
<input checked="" type="checkbox"/> EN 62479:2010	<input checked="" type="checkbox"/> ETSI EN 301 489-1 V2.2.3	
<input checked="" type="checkbox"/> ETSI EN 301 489-17 V3.2.4	<input checked="" type="checkbox"/> ETSI EN 301 489-3 V2.1.1	
<input checked="" type="checkbox"/> EN 300 328 V2.1.1	<input checked="" type="checkbox"/> ETSI EN 301 893 V2.1.1	
<b>Start of CE-Marking:</b>		
<b>Place, Date of Issue:</b>	Shenzhen,	
<b>Signature:</b>		
<b>Name of Authorized Signatory:</b>	Mr. Wang Xinbing	
<b>Position Held in Company:</b>	Deputy Director, Technical Regulation	

**This page intentionally left blank.**



