

NeoGen

Femoral Nail System



**LESS
IS MORE**

Surgical Technique

TABLE OF CONTENT

Preface		
	Indication	01
	Patient Preparation	01
<hr/>		
Standard Femoral Mode		
	Entry Portal	02
	Fracture Reduction	03
	Canal Preparation	03
	Nail Selection	04
	Assembly and Insertion of Nail	04
	Proximal Locking	05
	Stabilizing Distal Aiming Bar(Femur)	07
	Distal Locking Screw Insertion	10
	End Cap Placement	12
<hr/>		
Recon Mode		13
	Proximal Locking	14
	Distal Locking	17
	End Cap Placement	17
	Closure	17
<hr/>		
Post-Operative Management		
	Weight Bearing	18
	Nail Extraction Technique	18
<hr/>		
Appendix		
	Appendix Table 1	20
	Appendix Table 2	21
<hr/>		
Products Information		
	Implants	22
	Instruments	26

PREFACE

The femoral nails are designed to accommodate a standard femoral locking mode or the reconstruction locking mode in the same leg. Utilizing the same NeoGen instruments, simplify the surgical approach by allowing placement of the nail through the tip of the greater trochanter. The proximal section of the implant is 13mm screw placement for the reconstruction mode is at the standard 130°. The nail has a 5° anteversion and an anterior bow to match the femur.

Indications

- The indications for intramedullary locking nail include:
- Traumatic fracture
- Pathological fracture
- Re-fractures
- Non-unions
- Reconstructive surgery

Patient Preparation

Patient is placed supine with unaffected limb extended below the affected limb and trunk. The affected limb is abducted. Flex the affected hip 15°-30°. Apply traction through a skeletal pin or the foot with the fracture table foot holder. Adjust the affected limb for length and rotation by comparison with the unaffected limb. Rotation is further checked by rotating the arm to align the femoral neck anteversion and then making the appropriate correction by foot, usually 0°-15° of external rotation. Decubitus position may also be used with the fracture table, in this situation because of the change of position if the femoral head, the leg is usually internally rotated 10°-15°. It is better to check by visualizing the femoral anteversion proximally and matching it with correct rotation at the knee.

Palpate the greater trochanter. Make a 1-3cm incision proximal to the greater trochanter. Angle this incision posteriorly at its proximal end. Make the incision through the fascia.

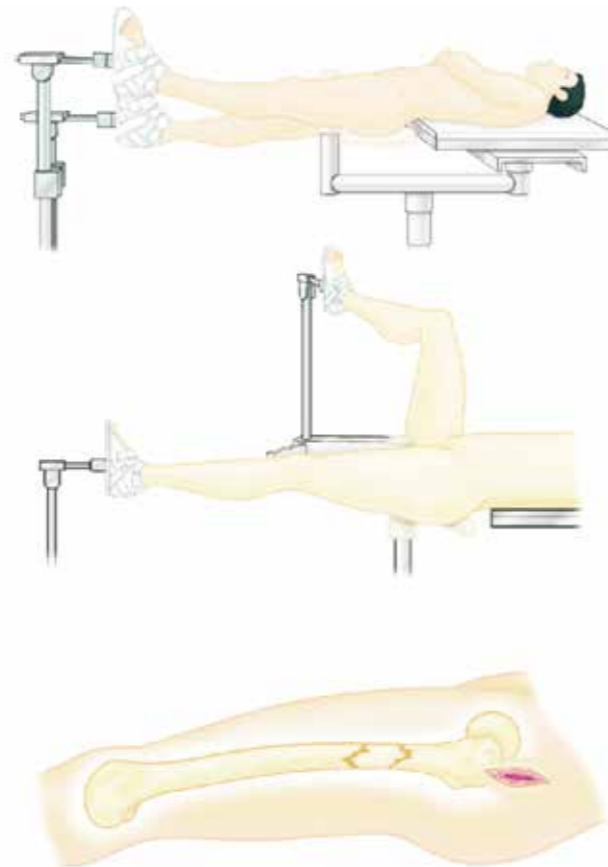

STANDARD FEMORAL MODE

1. Entry Portal

Assemble the Entry Drill Sleeve (Femur) (899463) with Entry Inner Trochar (Femur) (899462) and place through the incision to the bone. Adjust to align the Inner Trochar with axial line of the femoral shaft in A/P and lateral image views. This may require placing pressure on the Inner Trochar to align the Guide Wire, $\Phi 2.5\text{mm}$ (899490) with the axial line of the femur. Insert the Guide Wire into bone when the axial line and drill alignment is acceptable. The position will usually locate on the tip of greater trochanter. In addition, Awl (899461) can also be used for initial opening of the greater trochanter tip.

Remove the Entry Inner Trochar, attach the Entry Reamer (Femur) (899465) with power tool to ream the proximal femur through the Guide Wire. The Entry Reamer enlarges the proximal femur 0.5mm over the diameter of the proximal femur nail head. Stopper, $\Phi 7$ (899466) on the Entry Reamer is able to prevent further excessive reaming of the proximal femur.



Instrument

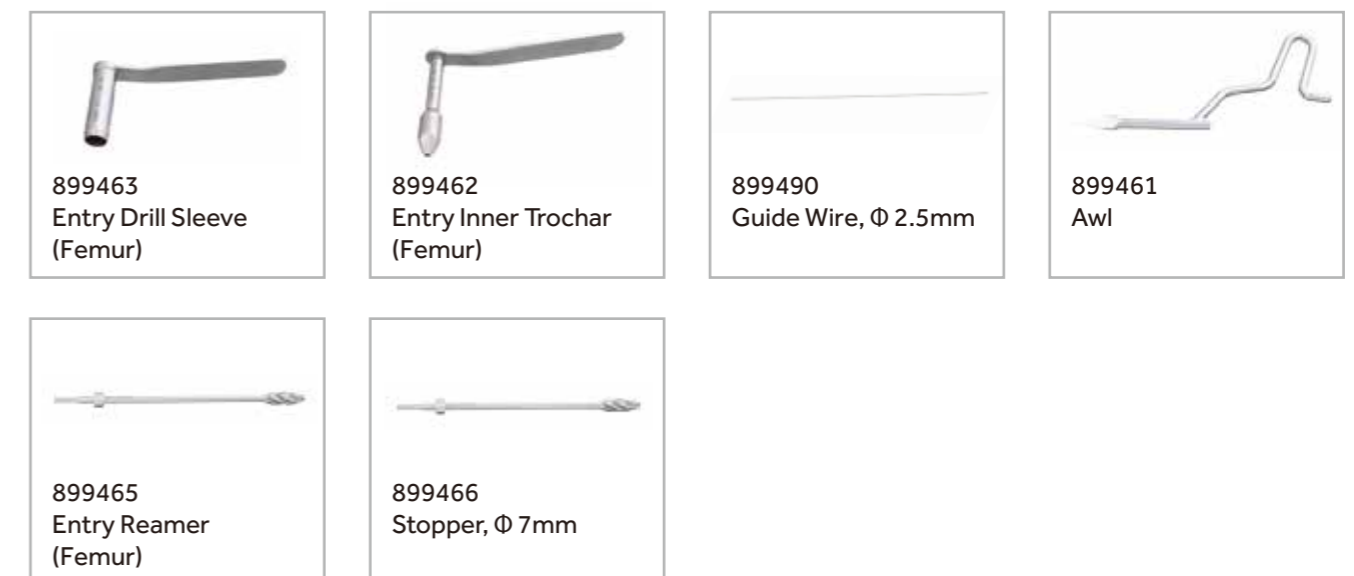

STANDARD FEMORAL MODE

2. Fracture Reduction

Remove the Guide Wire, place the Reducer (899469) through the Entry Drill Sleeve to reduce the fracture. Once the Reducer is in the medullary canal and has captured the distal fragment, the Ball Tip Guide Wire (899470) is inserted through it with using of the Guide Wire Holder (899471) into the distal femur. The Guide Wire Holder is useful in holding onto the Ball Tip Guide Wire during insertion and can be used to steer the Guide Wire tip to the center of the canal.



Instrument

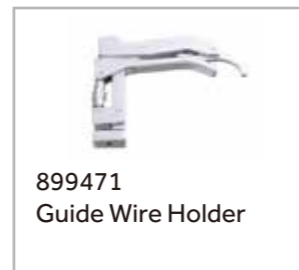
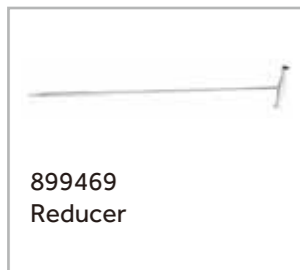

3. Canal Preparation

Canal preparation is dependent on surgical decision. If reaming is planned, use progressive reamers through the Entry Drill Sleeve. Unreamed nails are selected based on preoperative planning but should offer sufficient size to provide translational fill of the intramedullary canal in the mid-diaphysis. Once the Ball Tip Guide Wire is in place, remove the Reducer but leave the Entry Drill Sleeve in place. Proceed to sequentially ream the femoral shaft 0.5 to 1.0mm or more above the chosen nail diameter through the Entry Drill Sleeve. For more curved femoral shaft 0.5 to 1.0mm of over reaming may be beneficial.



STANDARD FEMORAL MODE

4. Nail Selection

Determine nail diameter from image intensifier or sounding the canal if necessary. Never insert a nail that is larger than the last reamer used.

The length of the nail can be decided by pre-operation measuring of patient's affected limb by measuring the X-ray image.

5. Assembly and Insertion of the Nail

Assemble the nail and Insertion Handle (899499) by using the Guide Bolt (899500). Use the Guide Bolt Wrench assembly (Guide Bolt Wrench Shaft (899497) and T-Handle with quick coupling (899468)) to secure the bolt to the nail.

Place the Tissue Protector (899464) in the incision parallel to the Entry Drill Sleeve and remove the Entry Drill Sleeve. Insert the nail into the medullary canal by twisting the nail gently over the Ball Tip Guide Wire. If necessary, connect the Impactor (899502) onto the top of the Insertion Handle to assist nail insertion.

Remove the Guide Wire when the nail is in position.



Instrument



STANDARD FEMORAL MODE

6. Proximal Locking

Insert the assembly of Trochar Sleeve for Locking Screw (899511) and Trochar for Locking Screw (899512) through the hole on the Insertion Handle. Make a 1-3cm incision and advance the trochar assembly to blunt separate the soft tissue.

The Trochar Sleeve for Locking Screw is now further inserted to the bone. Replace the Trochar by inserting the Drill Sleeve 4.3 (899514).

a. Pre-drilling technique

After placing the Drill Sleeve 4.3, attach the Drill Bit, $\Phi 4.3\text{mm}$ to the power tool and drill to but not through the opposite cortex and measure for proper length. The length measurements are taken from the calibrations of the drill in relation to the end of the drill sleeve.



STANDARD FEMORAL MODE

The appropriate 5.0mm screw is attached to the Screwdriver for Locking Screw (899487/899488). Remove the drill bit and drill sleeve. Insert the screw through the Trochar Sleeve for Locking Screw. Release the screwdriver by turning the bolt on the handle anti-clock wise.



b. Screw Depth Gauge

Drill through both cortices. The surgeon should check that the Trochar Sleeve for Locking Screw is attaching the bone. Insert the Screw Depth Gauge (899484) through The Trochar Sleeve for Locking Screw. Draw back the Screw Depth Gauge so that the hook engages the far cortex. The correct length of screw now can be read at the top of the Trochar Sleeve. The appropriate 5.0mm screw is attached to the Screwdriver for Locking Screw (899487/899488). Remove the drill bit and drill sleeve. Insert the screw through the Trochar Sleeve for Locking Screw. Release the screwdriver by turning the bolt on the handle anti-clock wise.

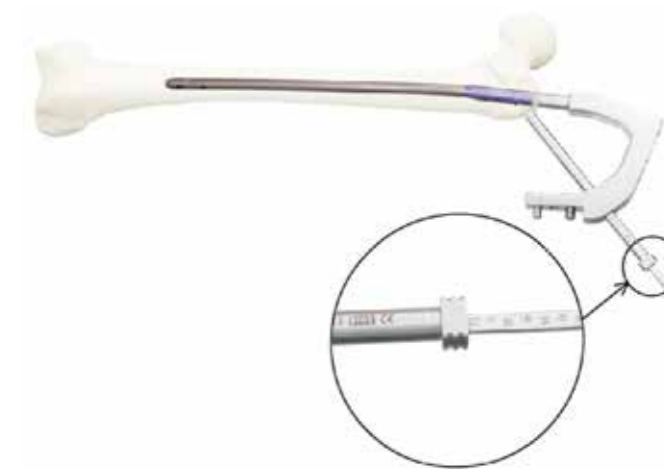

Instrument

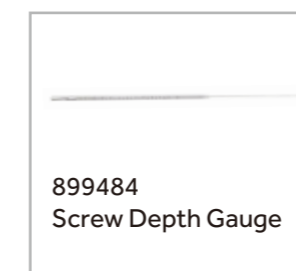
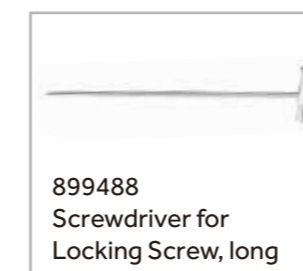
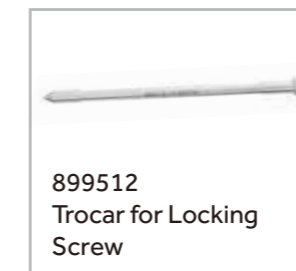
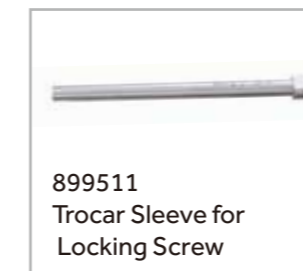

STANDARD FEMORAL MODE

7. Stabilizing Distal Aiming Bar

There may be some bending of the nail due to the pressure and weight of the soft tissue and the bone. Medio-lateral bending of the nail will not affect the targeting significantly, since this is the plane of screw insertion, but any bending will result in failure of the locking. The stabilizing system is therefore designed to correct antero-posteriorly alignment between the guide bar and the nail.

Attach the Distal Aiming Bar (899521) onto the Proximal Aiming Bar (Femur) (899520) by using the Distal Bolt (899504). There are two holes at the distal end marked L/R on the Proximal Aiming Bar. Make sure to choose the correct one which ensures the curvature of the aiming bar structure matches the curvature of the femoral nail. Fix the assembly on to the Insertion Handle by securing the Proximal Bolt (899503) using Bolt Wrench SW5.0 (899505).

Attach the Targeter (Femur) (899522) on the distal anterior side of the Distal Aiming Bar (Femur) and tighten it by using the Distal Bolt (899504) at the bottom of the Targeter.

The Trochar Sleeve (Position Rod) (899506) is inserted through the hole in the Targeter (Femur) down to the skin anteriorly, and by palpation is centered over the middle of femur. The point of contact with the skin is noted. An incision is made at this point, down to the deep fascia. The muscle is then split longitudinally down to the bone.



STANDARD FEMORAL MODE

The Trochar (Position Rod) (899507) is inserted into the Trochar Sleeve (Position Rod) and the two pushed together down to the bone. This assembly is centered over the middle of the femoral shaft by palpation. Withdraw the Trochar (Position Rod). Insert the Drill Sleeve 5.2 (899508) and start drilling by using Drill Bit, $\Phi 5.2\text{mm}$ (899509). The anterior cortex is only then drilled.

Replace the Drill Sleeve 5.2 and Drill Bit, $\Phi 5.2\text{mm}$ by the Position Rod Drill (899510) to clear the small bone chips. Remove the Position Rod Drill and then Position Rod (899523) is inserted through the hole in the Distal Targeter and the hole in the anterior femoral cortex down to the nail. Contact is confirmed by tapping its tip on to the distal platform of the nail.

The E Block (Femur) (899524/899525) is now attached so that the upper fork which laser marked the number corresponding with the nail diameter fits into the groove on the Position Rod shaft. The other two forks grip the Targeter (Femur).

Position Rod (Femur) is now properly held so that its tip is in contact with the nail platform. The surgeon maintains this contact throughout.















STANDARD FEMORAL MODE

Note:

If the contact with the nail platform is not achieved ever after attaching the E block properly, a medical assistant is required to assist to push the Position Rod tip down until it touches the platform for M/L view insertion. Otherwise, there probably a risk of M/L screw will miss its position for distal locking.

If the Position Rod handle is pushed too hard, it is sometimes possibly to push the tip of the Position Rod passing by the nail which needs to be avoided since it will result in the drill bit passing posterior to the nail. Gentle contact between the Position rod and the nail is required.

Instrument

 899506 Trochar Sleeve (Position Rod)	 899507 Trochar(Position Rod)	 899508 Drill Sleeve 5.2 (Position Rod)	 899509 Drill Bit, Ø 5.2mm (Position Rod)
 899510 Position Rod	 899523 Position Rod(Femur)	 899521 Distal Aiming Bar (Femur)	 899520 Proximal Aiming Bar (Femur)
 899504 Distal Bolt	 899503 Proximal Bolt	 899524 E Block 10/9 (Femur)	 899525 Locking Block 12/11 (Femur)
 899505 Bolt Wrench, SW5.0	 899522 Targeter (Femur)		

STANDARD FEMORAL MODE

8. Distal Locking Screw Insertion

Trochar Sleeve for Locking Screw (899511) are now inserted through each of the media-lateral holes in the Targeter (Femur) (899522). A single 1-3cm incision is made over the points over contact with the skin, down through the deep fascia. The incision is deepened by blunt dissection, splitting the ilio-tibial tract longitudinally, down to the bone, taking care to keep the incision in line with the fibers of the ilio-tibial band.

The Trochar Sleeve for Locking Screw is now further inserted down to the bone with the aid of the Trochar for Locking Screw (899512). Remove the Trochar, insert either the Drill Sleeve 4.0 (899513) or Drill Sleeve 4.3 (899514) depending on the chosen femoral nail's diameter. Correspondingly, Drill Bit, ϕ 4.0mm (899515) or Drill Bit, ϕ 4.3mm (899517) is chosen accordingly. (Detailed information, please see Appendix Table 1).

The surgeon now grip the T-handle of the Positioning Rod (Femur) (899523) to keep its tip against the nail, and maintains this position throughout the drilling procedures. The Drill Sleeves inserted into the Targeter (Femur) (899522)-close to the proximal side hole at the distal area of the nail-now is chosen to be drilled as the first media-lateral locking screw hole.

Remove the Drill Sleeve 4.0 (899513) or Drill Sleeve 4.3 (899514), then the Replacement Rod (899519) is now inserted into the Trochar Sleeve for Locking Screw (899511), so that it passes through the nail, and engages the far cortex. This Replacement Rod has now stabilized the position of the aiming bar. Do not drill the second hole until the Replacement Rod in position.

Now the screw guide alignment is maintained by this Replacement Rod and the surgeon may release the handle of Positioning Rod (Femur).

Another Drill Sleeve inserted in the Targeter (Femur) (899522) now is chosen to be drilled as the second media-lateral locking screw hole by using the same techniques which have been applied for the first locking screw.



STANDARD FEMORAL MODE

Screw length is able to be obtained by reading directly from the drill's calibration or using the Screw Depth Gauge (899484) (Screw Depth Gauge using method, please see: Screw Depth Gauge). Remove the Drill Sleeve (899513 or 899514), a locking screw of correct length and diameter is now inserted through the Trochar Sleeve for Locking Screw (899511), rotate through the bone with the Screwdriver for Locking Screw.



The Replacement Rod is removed from the first Trochar Sleeve for Locking Screw (899511), and the surgeon again maintains the position of the Positioning Rod by gripping its T-handles. The same technique is followed for insertion of the remaining screw. A check is now carried out with the Image Intensifier or by X-ray to confirm that both screws have passed through the nail and that reduction has been maintained. The Positioning Rod, Trochar Sleeve for Locking Screw and Targeter are removed.

Instrument



899511
Trocar Sleeve for
Locking Screw



899522
Targeter (Femur)



899512
Trocar for Locking
Screw



899513
Drill Sleeve 4.0



899514
Drill Sleeve 4.3



899515
Drill Bit, Ø 4.0mm



899523
Position Rod(Femur)

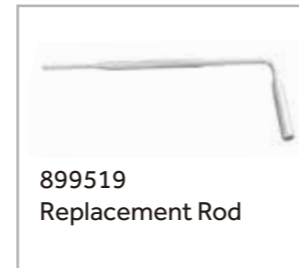

899519
Replacement Rod

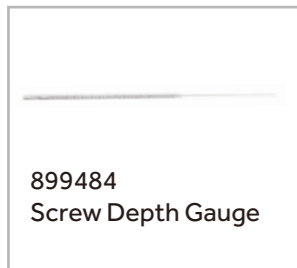

899484
Screw Depth Gauge

STANDARD FEMORAL MODE

10. End Cap Placement

If the end cap is considered, then attach the appropriate end cap by the Screwdriver for Locking Screw. Insert the end cap, and then turn the bolt on the screwdriver handle counterlockwise to release the screwdriver.



RECON MODE

6.3 mm screws are to be used into the femoral neck for reconstruction mode.

Assemble the nail and Insertion Handle (899499) by using the Guide Bolt (899500). Use the Guide Bolt Wrench assembly (Guide Bolt Wrench Shaft (899497) and T-Handle with quick coupling (899468)) to secure the bolt to the nail.

Place the Tissue Protector (899464) in the incision parallel to the Entry Drill Sleeve and remove the Entry Drill Sleeve. Insert the nail into the medullary canal by twisting the nail gently over the Ball Tip Guide Wire. If necessary, connect the Impactor (899502) onto the top of the Insertion Handle to assist nail insertion. Remove the Guide Wire when the nail is in position.

Note:
Nail insertion of Recon Mode applies the same techniques of Standard Femoral Mode.



Instrument

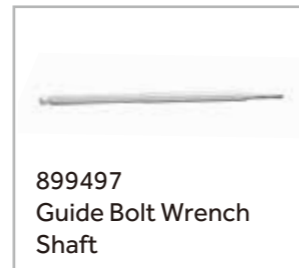

RECON MODE

1. Proximal Locking

Note:

Two aspects of 6.3mm proximal lag screw placement into the femoral neck must be noted before drilling into the femoral neck:
(1) Alignment of the anteversion angle;
(2) Depth of nail insertion

Rotate the C-Arm proximally until a true line of the hip is visualized. This gives the correct axis of alignment of anteversion. Rotate the handle of Proximal Aiming Bar (Femur) (899520) until it bisects the femoral head in the lateral view. This should assist in setting the correct anteversion position of the screws. Mark this position with a skin marker on the leg parallel to the driving handle.

Next, rotate the C-Arm into an A/P view. The half-concaved screw hole shape on the proximal side of femoral nail which is visualized radiographically to generally determine from preoperative planning what depth of nail insertion will be required to allow both screws to be centered in the femoral neck (Insertion of 2 Guide Wires with Threaded Tip, $\phi 2.5$ (899491) into the femoral head with proper image intensifier checking is very useful techniques before the proper position of 6.3mm lag screws placement into the femoral neck) as a rule. The lower screw is placed first. These screws are angled at 130° in relation to the shaft. If both screws are not able to seat within the femoral neck, it is possible that too much varus positioning of the proximal fragment has occurred, improper fracture reduction of the proximal nail entry portal is too lateral. In that case, surgeon should re-check the fracture reduction.

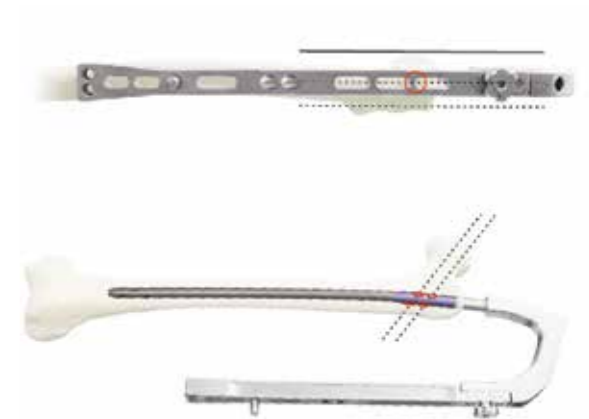

RECON MODE

6.3mm Screw Placement Technique:

Make an incision at the entry holes of the proximal screw sleeves, and then connect the 2 punctures wounds for approximately a 3cm incision that will accommodate the insertion of both screws. Insert the assembly of Trochar Sleeve for Locking Screw (899511) & Trochar for Locking Screw (899512) and push the assembly close to the bone as much as possible.

Replace the Trochar by the Guide Wire Sleeve 2.5 (899489), insert the Guide Wire, ϕ 2.5mm (899490) into the Guide Wire Sleeve. Drill into the femoral neck and head to the desired depth and position, but at a distance of at least 5mm from the joint surface, check with image intensifier to ensure the proper position.

Remove the Guide Wire Sleeve and insert the Direct Measuring Device for Guide Wire (899492) to decide the desired drill length of femoral neck. The length should be 10mm less than the reading from the Direct Measuring Device.

Set the Stopper, ϕ 6.4mm (899495) to the appropriate position on the Drill Bit, ϕ 6.4mm (899494). Remove Guide Wire and Sleeve and insert the Drill Sleeve 6.4 (899493). Check the alignment in A/P and 15° lateral views before drilling into the femoral neck. Once the drill bit comes to the stop, remove it. Use the Tap, ϕ 6.4mm (899496) through the Trochar Sleeve for Locking Screw (899511) to prepare the hole for lag screw insertion.



RECON MODE

Attach the appropriate length 6.3mm screw to the Screwdriver for Locking Screw (899487/899488). Tighten the lag screws when the traction is released to maximize compression at the fracture site. Once an acceptable position is obtained, detach the Screwdriver for Locking Screw from the screws by rotate the bolt on the screwdriver handle counter-clockwise. Remove the Trochar Sleeves for Locking Screw (899511) and now prepare for distal locking.



Instrument

899520 Proximal Aiming Bar (Femur)	899491 Guide Wire with Threaded Tip , Ø 2.5mm	899511 Trocar Sleeve for Locking Screw	899512 Trocar for Locking Screw
899489 Guide Wire Sleeve 2.5	899490 Guide Wire, Ø 2.5mm	899492 Direct Measuring Device for Guide Wires	899495 Stopper, Ø 6.4mm
899494 Drill Bit, Ø 6.4mm	899493 Drill Sleeve 6.4	899496 Tap, Ø 6.4mm	899487 Screwdriver for Locking Screw
899488 Screwdriver for Locking Screw, long			

RECON MODE

2. Distal Locking

The distal locking screw insertion of Recon Mode follows the same techniques of the distal locking screw placement of Standard Femoral Mode.



3. End Cap Placement

If the end cap is considered, then attach the appropriate end cap by the Screwdriver for Locking Screw. Insert the end cap, and then turn the bolt on the screwdriver handle counterclockwise to release the screwdriver.



4. Closure

On completion of the procedure, unscrewed the Distal & Proximal locking screws, remove the aiming bars, wounds are irrigated and closed in a standard fashion.

POST-OPERATIVE MANAGEMENT

1. Weight Bearing

The patient is mobilized on crutches immediately, but the knee is rested in an immobilizer for 1-2 days. Dressings are changed daily, and, after the drain has been removed, the knee may be mobilized freely. With a stable fracture, a patient may weight bear as able increasing to full weight bearing by 4 weeks. If the fracture is unstable, toe touchweight bearing is permitted immediately, with gradually increasing partial weight bearing over the next 6 weeks. Full weight bearing is only advised once there is some continuity of callus across the fracture site. Fractures with severe comminution, should be supported before weight bearing with an external brace, if an 9.5mm nail has been used, until the fracture is healed.

2. Neogen Femoral Nail Extraction Technique

Nail removal may normally be carried out after 18-24 months provided that there is a radiographical evidence of union. Union may be expected to occur after 6 months with nailing procedures in the femur. The situation may be different in open fractures, nonunions or corrective osteotomies. In such cases the nail should be left in situ for a minimum of 24 months.

Place the patient in the supine position on a radiolucent table. After prepping and draping, remove any distal screws and all but one proximal screw from the nail, leaving the screw closest to the driving end of the nail.

Under fluoroscopy, the proximal end of nail is exposed through a small incision.

POST-OPERATIVE MANAGEMENT

It may be necessary to clear some new bone from the end of the nail. The nail end cap is removed with the Screwdriver for Locking Screw, and the Extractor (899498) is screwed on to the nail, and tightened firmly. This should be accomplished prior to the removal of the proximal locking screws to prevent the nail from deflecting posteriorly.



The proximal locking screw is now removed. The nail is then removed, either by manual traction on the Extractor, or by reverse hammering using Impactor (899502), after the Impactor screwing on to the proximal end of the Extractor.



Instrument

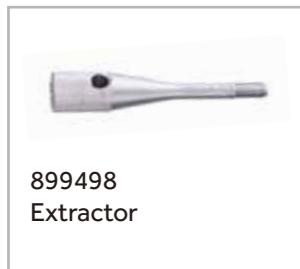

APPENDIX

Table 1

NeoGen Femoral Nails(Standard Femoral Mode)				
Process	Factors	Φ 9mm& Φ 10mm	Φ 11mm& Φ 12mm	
Entry	Proximal Color	L: Rose, R: Dark Golden		
	Proximal Dia.	13mm		
	Entry Reamer-13.5mm	Entry Reamer(Femur)(899465)		
	Entry Sleeve	Entry Inner Trochar(Femur)(899462)		
Proximal Locking	No.of Proximal Locking Screws	1		
	Proximal Locking Screws	5.0 mm		
	Locking Screw Color	Dark Golden		
	Drill Bits for Proximal Locking	Drill Bit, Φ 4.3mm (899517)		
	Drill Sleeve for Proximal Locking	Drill Sleeve, 4.3 (899514)		
Distal Locking	Locking Screw Color	Blue	Dark Golden	
	No.of Distal Locking Holes	2		
	Distal Locking Screws	4.5 mm	5.0 mm	
	Position Instruments	Trochar Sleeve(Position Rod)(899506)		
		Drill Sleeve,5.2(Position Rod)(899508)		
		Drill Bit, Φ 5.2mm(Position Rod)(899509)		
		Position Rod Drill(Position Rod)(899510)		
		Position Rod (899523)		
	Drill Bits for Distal Locking	E-Block, 10/9(Femur)(899524)		E-Block, 12/11(Femur)(899525)
		Drill Bit, Φ 4.0mm (899515)		Drill Bit, Φ 4.3mm (899517)
Drill Sleeve, 4.0 (899513)		Drill Sleeve, 4.3 (899514)		
Trochar Sleeve for Locking Screw (899511)				

APPENDIX

Table 2

NeoGen Femoral Nails (Recon Mode)				
Process	Factors	Φ 9.5mm & Φ 10mm	Φ 11mm & Φ 12mm	
Entry	Proximal Color	L: Rose, R: Dark Golden		
	Proximal Dia.	13mm		
	Entry Reamer-13.5mm	Entry Reamer(Femur)(899465)		
	Entry Sleeve	Entry Inner Trochar(Femur)(899462)		
Proximal Locking	No.of Proximal Locking Screws	2		
	Proximal Locking Screws	6.4 mm		
	Locking Screw Color	Dark Golden		
	Drill Bits for Proximal Locking	Drill Bit, Φ 6.4mm (899494)		
	Drill Sleeve for Proximal Locking	Drill Sleeve, 6.4 (899493)		
Trochar Sleeve for Locking Screw (899511)				
Distal Locking	Locking Screw Color	Blue	Dark Golden	
	No.of Distal Locking Holes	2		
	Distal Locking Screws	4.5 mm	5.0 mm	
	Position Instruments	Trochar Sleeve(Position Rod)(899506)		
		Drill Sleeve,5.2(Position Rod)(899508)		
		Drill Bit, Φ 5.2mm(Position Rod)(899509)		
		Position Rod Drill(Position Rod)(899510)		
		Position Rod (899523)		
	Drill Bits for Distal Locking	E-Block, 10/9(Femur)(899524)		E-Block, 12/11(Femur)(899525)
		Drill Bit, Φ 4.0mm (899515)		Drill Bit, Φ 4.3mm (899517)
Drill Sleeve, 4.0 (899513)		Drill Sleeve, 4.3 (899514)		
Trochar Sleeve for Locking Screw (899511)				

PRODUCTS INFORMATION

Implants



NeoGen Femoral Nails			
Code	Description	Size	Materials
33101232	NeoGen Femoral Nail, left	9.5X320mm	TA
33101234	NeoGen Femoral Nail, left	9.5X340mm	TA
33101236	NeoGen Femoral Nail, left	9.5X360mm	TA
33101238	NeoGen Femoral Nail, left	9.5X380mm	TA
33101240	NeoGen Femoral Nail, left	9.5X400mm	TA
33101242	NeoGen Femoral Nail, left	9.5X420mm	TA
33101244	NeoGen Femoral Nail, left	9.5X440mm	TA
33102232	NeoGen Femoral Nail, left	10X320mm	TA
33102234	NeoGen Femoral Nail, left	10X340mm	TA
33102236	NeoGen Femoral Nail, left	10X360mm	TA
33102238	NeoGen Femoral Nail, left	10X380mm	TA
33102240	NeoGen Femoral Nail, left	10X400mm	TA
33102242	NeoGen Femoral Nail, left	10X420mm	TA
33102244	NeoGen Femoral Nail, left	10X440mm	TA
33103232	NeoGen Femoral Nail, left	11X320mm	TA
33103234	NeoGen Femoral Nail, left	11X340mm	TA
33103236	NeoGen Femoral Nail, left	11X360mm	TA
33103238	NeoGen Femoral Nail, left	11X380mm	TA
33103240	NeoGen Femoral Nail, left	11X400mm	TA
33103242	NeoGen Femoral Nail, left	11X420mm	TA
33104244	NeoGen Femoral Nail, left	11X440mm	TA
33104232	NeoGen Femoral Nail, left	12X320mm	TA
33104234	NeoGen Femoral Nail, left	12X340mm	TA
33104236	NeoGen Femoral Nail, left	12X360mm	TA
33104238	NeoGen Femoral Nail, left	12X380mm	TA
33104240	NeoGen Femoral Nail, left	12X400mm	TA
33104242	NeoGen Femoral Nail, left	12X420mm	TA
33104244	NeoGen Femoral Nail, left	12X440mm	TA

PRODUCTS INFORMATION

NeoGen Femoral Nails			
Code	Description	Size	Materials
33101132	NeoGen Femoral Nail,right	9.5X320mm	TA
33101134	NeoGen Femoral Nail,right	9.5X340mm	TA
33101136	NeoGen Femoral Nail,right	9.5X360mm	TA
33101138	NeoGen Femoral Nail,right	9.5X380mm	TA
33101140	NeoGen Femoral Nail,right	9.5X400mm	TA
33101142	NeoGen Femoral Nail,right	9.5X420mm	TA
33101144	NeoGen Femoral Nail,right	9.5X440mm	TA
33102132	NeoGen Femoral Nail,right	10X320mm	TA
33102134	NeoGen Femoral Nail,right	10X340mm	TA
33102136	NeoGen Femoral Nail,right	10X360mm	TA
33102138	NeoGen Femoral Nail,right	10X380mm	TA
33102140	NeoGen Femoral Nail,right	10X400mm	TA
33102142	NeoGen Femoral Nail,right	10X420mm	TA
33102144	NeoGen Femoral Nail,right	10X440mm	TA
33103132	NeoGen Femoral Nail,right	11X320mm	TA
33103134	NeoGen Femoral Nail,right	11X340mm	TA
33103136	NeoGen Femoral Nail,right	11X360mm	TA
33103138	NeoGen Femoral Nail,right	11X380mm	TA
33103140	NeoGen Femoral Nail,right	11X400mm	TA
33103142	NeoGen Femoral Nail,right	11X420mm	TA
33104144	NeoGen Femoral Nail,right	11X440mm	TA
33104132	NeoGen Femoral Nail,right	12X320mm	TA
33104134	NeoGen Femoral Nail,right	12X340mm	TA
33104136	NeoGen Femoral Nail,right	12X360mm	TA
33104138	NeoGen Femoral Nail,right	12X380mm	TA
33104140	NeoGen Femoral Nail,right	12X400mm	TA
33104142	NeoGen Femoral Nail,right	12X420mm	TA
33104144	NeoGen Femoral Nail,right	12X440mm	TA

PRODUCTS INFORMATION



NeoGen Reconstruction Locking Screw			
Code	Description	Size	Materials
33113065	Reconstruction Locking Screw	6.3x65mm	TA
33113070	Reconstruction Locking Screw	6.3x70mm	TA
33113075	Reconstruction Locking Screw	6.3x75mm	TA
33113080	Reconstruction Locking Screw	6.3x80mm	TA
33113085	Reconstruction Locking Screw	6.3x85mm	TA
33113090	Reconstruction Locking Screw	6.3x90mm	TA
33113091	Reconstruction Locking Screw	6.3x95mm	TA
33113092	Reconstruction Locking Screw	6.3x100mm	TA
33113093	Reconstruction Locking Screw	6.3x105mm	TA
33113094	Reconstruction Locking Screw	6.3x110mm	TA
33113095	Reconstruction Locking Screw	6.3x115mm	TA
33113096	Reconstruction Locking Screw	6.3x120mm	TA
33113097	Reconstruction Locking Screw	6.3x125mm	TA



NeoGen Locking Screws			
Code	Description	Size	Materials
33111025	NeoGen Locking Screws	4.5X26mm	TA
33111030	NeoGen Locking Screws	4.5X30mm	TA
33111035	NeoGen Locking Screws	4.5X35mm	TA
33111040	NeoGen Locking Screws	4.5X40mm	TA
33111045	NeoGen Locking Screws	4.5X45mm	TA
33111050	NeoGen Locking Screws	4.5X50mm	TA
33111055	NeoGen Locking Screws	4.5X55mm	TA
33111060	NeoGen Locking Screws	4.5X60mm	TA
33111065	NeoGen Locking Screws	4.5X65mm	TA
33111070	NeoGen Locking Screws	4.5X70mm	TA
33111075	NeoGen Locking Screws	4.5X75mm	TA
33111080	NeoGen Locking Screws	4.5X80mm	TA
33111085	NeoGen Locking Screws	4.5X85mm	TA
33111090	NeoGen Locking Screws	4.5X90mm	TA

PRODUCTS INFORMATION

NeoGen Locking Screws			
Code	Description	Size	Materials
33112025	NeoGen Locking Screws	5.0x26mm	TA
33112030	NeoGen Locking Screws	5.0x30mm	TA
33112035	NeoGen Locking Screws	5.0x35mm	TA
33112040	NeoGen Locking Screws	5.0x40mm	TA
33112045	NeoGen Locking Screws	5.0x45mm	TA
33112050	NeoGen Locking Screws	5.0x50mm	TA
33112055	NeoGen Locking Screws	5.0x55mm	TA
33112060	NeoGen Locking Screws	5.0x60mm	TA
33112065	NeoGen Locking Screws	5.0x65mm	TA
33112070	NeoGen Locking Screws	5.0x70mm	TA
33112075	NeoGen Locking Screws	5.0x75mm	TA
33112080	NeoGen Locking Screws	5.0x80mm	TA
33112085	NeoGen Locking Screws	5.0x85mm	TA
33112090	NeoGen Locking Screws	5.0x90mm	TA
33112091	NeoGen Locking Screws	5.0x95mm	TA
33112092	NeoGen Locking Screws	5.0x100mm	TA



NeoGen Nail Cap			
Code	Description	Size	Material
33110000	NeoGen Nails Caps(Femur)	∅ 8.2	TA
33110005	NeoGen Nails Caps(Femur)	∅ 13, +5	TA
33110010	NeoGen Nails Caps(Femur)	∅ 13, +10	TA
33110015	NeoGen Nails Caps(Femur)	∅ 13, +15	TA

PRODUCTS INFORMATION

Instruments

Code	Description	QTY.
899460	Neogen Nail Instruments Set	
898357	Neogen Nail Basic Instruments Set (Empty)-PPSU	1
898358	NeoGen Nail Special Instruments Set (Empty)-PPSU	1
898196	NeoGen Nail Special Instruments Set Empty Tray	1
899461	Awl	1
899464	Tissue Protector	1
899467	L-Hex Wrench, SW3 for Stopper ∅ 7mm	1
899469	Reducer	1
899470	Ball Tip Guide Wire	1
251170	Guide Wire Holder	1
050013	Hex Reamer Shaft-Dual Direction	1
899472	Hex Reamer Shaft-Mono Direction	1
050085	Reamer, ∅ 8.5mm	1
050090	Reamer, ∅ 9mm	1
050095	Reamer, ∅ 9.5mm	1
050100	Reamer, ∅ 10mm	1
050105	Reamer, ∅ 10.5mm	1
050110	Reamer, ∅ 11mm	1
050115	Reamer, ∅ 11.5mm	1
050120	Reamer, ∅ 12mm	1
050125	Reamer, ∅ 12.5mm	1
050130	Reamer, ∅ 13mm	1
050135	Reamer, ∅ 13.5mm	1
899468	T-Handle with Quick Coupling	1
899497	Guide Bolt Wrench Shaft	1
899498	Extractor	1
899499	Insertion Handle	1
899500	Guide Bolt	2
899502	Impactor	1
899489	Guide Wire Sleeve 2.5	1
899490	Guide Wire, ∅ 2.5mm	3
899491	Guide Wire with Threaded Tip, ∅ 2.5mm	3
899492	Direct Measuring Device for Guide Wires	1
899484	Screw Depth Gauge	1
899485	Tap, ∅ 4.5mm	1
899486	Tap, ∅ 5.0mm	1
899496	Tap, ∅ 6.4mm	1
899493	Drill Sleeve 6.4	2
899494	Drill Bit, ∅ 6.4mm	1
899495	Stopper, ∅ 6.4mm	1

Optional

Code	Description
898381	Awl
898382	Radiographic Ruler
251620	Joint Screwdriver for End Cap

Code	Description	QTY.
899487	Screwdriver for Locking Screw	1
899488	Screwdriver for Locking Screw, Long	1
899503	Proximal Bolt	2
899504	Distal Bolt	3
899505	Bolt Wrench, SW5.0	1
899506	Trochar Sleeve (Position Rod)	1
899507	Trochar (Position Rod)	1
899508	Drill Sleeve 5.2 (Position Rod)	1
899509	Drill Bit, ∅ 5.2mm (Position Rod)	1
899510	Position Rod Drill (Position Rod)	1
899511	Trocar Sleeve for Locking Screw	2
899512	Trocar for Locking Screw	1
899513	Drill Sleeve 4.0	1
899514	Drill Sleeve 4.3	1
899515	Drill Bit, ∅ 4.0mm	2
899516	Stopper, ∅ 4.0mm	1
899517	Drill Bit, ∅ 4.3mm	2
899518	Stopper, ∅ 4.3mm	1
899519	Replacement Rod	1
899462	Entry Inner Trochar (Femur)	1
899463	Entry Drill Sleeve (Femur)	1
899465	Entry Reamer (Femur)	1
899466	Stopper, ∅ 7mm	2
899520	Proximal Aiming Bar (Femur)	1
899521	Distal Aiming Bar (Femur)	1
899522	Targeter (Femur)	1
899523	Position Rod	1
899524	E Block 10/9 (Femur)	1
899525	E Block 12/11 (Femur)	1
898127	Entry Inner Trochar (Knee)	1
898128	Entry Drill Sleeve (Knee)	1
898122	Entry Reamer (Knee)	1
899526	Proximal Aiming Bar (Knee), Left	1
899527	Proximal Aiming Bar (Knee), Right	1
899531	Proximal Aiming Device (Knee)	1
899528	Distal Aiming Bar (Knee)	1
899529	Targeter (Knee)	1
899530	Position Rod (Knee)	1
899532	E Block 9/8(Knee)	1
899533	E Block 11.5/10 (Knee)	1

Implant Case

Code	Description
898371	NeoGen Femoral Nails implant case
898372	NeoGen Tibia Nails implant case
98702	NeoGen Femoral nail Implant case (Paragon)
98701	NeoGen Tibia nail Implant case (Paragon)

PRODUCTS INFORMATION

 <p>899461 Awl</p>	 <p>899464 Tissue Protector</p>	 <p>899467 L-Hex Wrench, SW3 for Stopper Φ 7mm</p>
 <p>899469 Reducer</p>	 <p>899470 Ball Tip Guide Wire</p>	 <p>251170 Guide Wire Holder</p>
 <p>050013 Hex Reamer Shaft-Dual Direction</p>	 <p>899472 Hex Reamer Shaft-Mono Direction</p>	 <p>050085 Reamer, Φ 8.5mm</p>
 <p>050090 Reamer, Φ 9mm</p>	 <p>050095 Reamer, Φ 9.5mm</p>	 <p>050100 Reamer, Φ 10mm</p>

PRODUCTS INFORMATION

 <p>050105 Reamer, Φ 10.5mm</p>	 <p>050110 Reamer, Φ 11mm</p>	 <p>050115 Reamer, Φ 11.5mm</p>
 <p>050120 Reamer, Φ 12mm</p>	 <p>050125 Reamer, Φ 12.5mm</p>	 <p>050130 Reamer, Φ 13mm</p>
 <p>050135 Reamer, Φ 13.5mm</p>	 <p>899468 T-Handle with Quick Coupling</p>	 <p>899497 Guide Bolt Wrench Shaft</p>
 <p>899498 Extractor</p>	 <p>899499 Insertion Handle</p>	 <p>899500 Guide Bolt</p>

PRODUCTS INFORMATION



899502
Impactor



899489
Guide Wire Sleeve 2.5



899490
Guide Wire, Ø 2.5mm



899491
Guide Wire with Threaded Tip,
Ø 2.5mm



899492
Direct Measuring Device for
Guide Wires

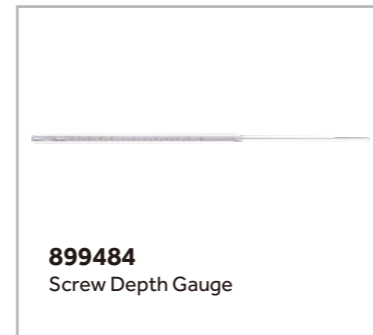

899484
Screw Depth Gauge



899485
Tap, Ø 4.5mm



899486
Tap, Ø 5.0mm

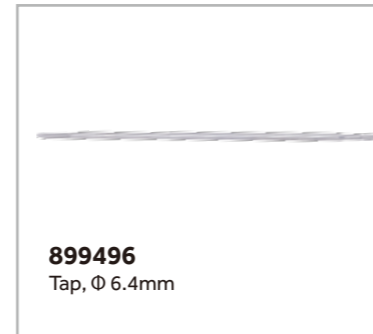

899496
Tap, Ø 6.4mm



899493
Drill Sleeve 6.4



899494
Drill Bit, Ø 6.4mm



899495
Stopper, Ø 6.4mm

PRODUCTS INFORMATION



899487
Screwdriver for Locking Screw



899488
Screwdriver for Locking Screw,
Long



899503
Proximal Bolt



899504
Distal Bolt



899505
Bolt Wrench, SW5.0



899506
Trochar Sleeve (Position Rod)



899507
Trochar (Position Rod)



899508
Drill Sleeve 5.2 (Position Rod)



899509
Drill Bit, Ø 5.2mm (Position Rod)

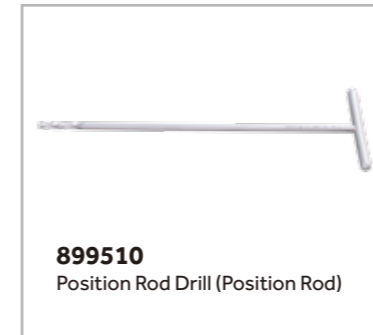

899510
Position Rod Drill (Position Rod)



899511
Trocar Sleeve for Locking Screw

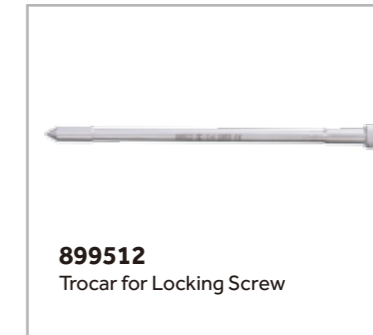

899512
Trocar for Locking Screw

PRODUCTS INFORMATION

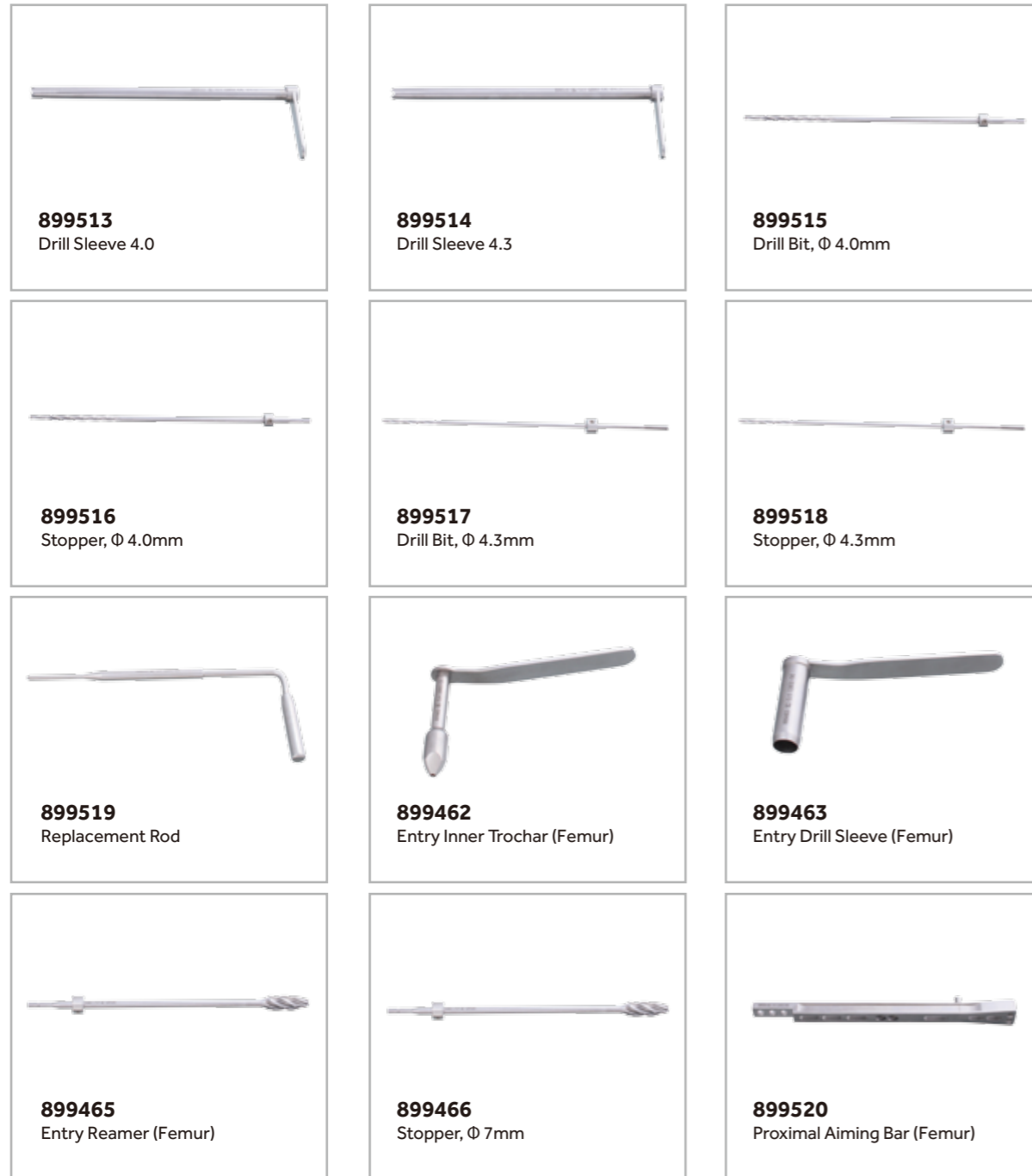

PRODUCTS INFORMATION



PRODUCTS INFORMATION

NOTE



NOTE
