

# Dissecting and Grasping Forceps

CLICK*line* – rotating, dismantling, insulated, with connector pin for unipolar coagulation



**Size 5 mm**

Operating instruments, lengths 30 and 36 cm, for use with trocars size 6 mm

Operating instruments, length 43 cm, for use with telescopes with inbuilt working channel and trocars size 6 mm

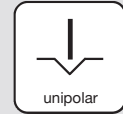

Length	Handle					
	33151	33152	33153	33156	33121	33149
30 cm						
36 cm						
43 cm						

**Double action jaws**

Working Insert	Complete Instrument					
33210 MD	33251 MD	33252 MD	33253 MD	33256 MD	33221 MD	33249 MD
33310 MD	33351 MD	33352 MD	33353 MD	33356 MD	33321 MD	33349 MD
33410 MD	33451 MD	33452 MD	33453 MD	33456 MD	33421 MD	33449 MD

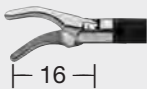

CLICK*line* KELLY Dissecting and Grasping Forceps

33210 ML	33251 ML	33252 ML	33253 ML	33256 ML	33221 ML	33249 ML
33310 ML	33351 ML	33352 ML	33353 ML	33356 ML	33321 ML	33349 ML
33410 ML	33451 ML	33452 ML	33453 ML	33456 ML	33421 ML	33449 ML

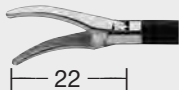

CLICK*line* KELLY Dissecting and Grasping Forceps, long

33310 DK	33351 DK	33352 DK	33353 DK	33356 DK	33321 DK	33349 DK
----------	----------	----------	----------	----------	----------	----------



CLICK*line* DeBAKEY Grasping Forceps, curved and slender jaws, atraumatic

33310 UY	33351 UY	33352 UY	33353 UY	33356 UY	33321 UY	33349 UY
----------	----------	----------	----------	----------	----------	----------



CLICK*line* UYAMA Dissecting and Grasping Forceps, long jaws, with reservoir, fine, for dissection

33310 NO	33351 NO	33352 NO	33353 NO	33356 NO	33321 NO	33349 NO
----------	----------	----------	----------	----------	----------	----------

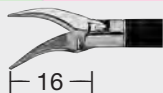

CLICK*line* NOSHIRO Dissecting and Grasping Forceps, short jaws, fine, for dissection

# Dissecting and Grasping Forceps

CLICK<sup>line</sup> – rotating, dismantling, insulated,  
with connector pin for unipolar coagulation

Size 5 mm

Operating instruments, lengths 30 and 36 cm,  
for use with trocars size 6 mm

Operating instruments, length 43 cm,  
for use with telescopes with inbuilt  
working channel and trocars size 6 mm

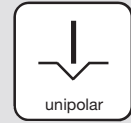

Length	Handle						
	33151	33152	33153	33156	33121	33125	33149
30 cm							
36 cm							
43 cm							

## Double action jaws

Working Insert	Complete Instrument						
33210 R	33251 R	33252 R	33253 R	33256 R	33221 R	33225 R	33249 R
33310 R	33351 R	33352 R	33353 R	33356 R	33321 R	33325 R	33349 R
33410 R	33451 R	33452 R	33453 R	33456 R	33421 R	33425 R	33449 R



CLICK<sup>line</sup> Dissecting and Grasping Forceps, right-angled

33210 UL	33251 UL	33252 UL	33253 UL	33256 UL	33221 UL	33225 UL	33249 UL
33310 UL	33351 UL	33352 UL	33353 UL	33356 UL	33321 UL	33325 UL	33349 UL
33410 UL	33451 UL	33452 UL	33453 UL	33456 UL	33421 UL	33425 UL	33449 UL



CLICK<sup>line</sup> REDDICK-OLSEN Dissecting and Grasping Forceps, robust

33210 HM	33251 HM	33252 HM	33253 HM	33256 HM	33221 HM	33225 HM	33249 HM
33310 HM	33351 HM	33352 HM	33353 HM	33356 HM	33321 HM	33325 HM	33349 HM
33410 HM	33451 HM	33452 HM	33453 HM	33456 HM	33421 HM	33425 HM	33449 HM



CLICK<sup>line</sup> Dissecting and Grasping Forceps, "alligator jaws"

5 mm

# Coagulation and Dissection Electrodes

without suction channel, insulated sheath,  
with connector pin for unipolar coagulation

## Size 5 mm

Operating instruments, **lengths 30 and 36 cm**,  
for use with **trocars size 6 mm**

Operating instruments, **length 43 cm**,  
for use with telescopes with inbuilt  
working channel and trocars size 6 mm



Length	Instrument
30 cm	
36 cm	
43 cm	

Distal Tip	Instrument
	26772 UF 26775 UF 26778 UF <b>Coagulation and Dissection Electrode, L-shaped</b>
	26775 UE 26778 UE <b>Coagulation and Dissection Electrode, spatula-shaped, blunt</b>
	26775 S <b>Coagulation and Dissection Electrode, knife-shaped</b>
	26775 R <b>MANGESHIKAR Coagulation Electrode, with ball end</b>

### Special Features:

- The hook electrode is suitable for resection, insulating structures as well as dissection and coagulation.
- The distal tip is semicircular: The thick outer curvature enables safe dissection.
- The thin inner curvature enables fast work with minimal coagulation.
- The striated handle allows easier gripping.
- The hook length enables ergonomic work.

Length	Instrument
36 cm	
43 cm	

Distal Tip	Instrument
	26775 C 26775 CL <b>CADIERE Coagulation and Dissection Electrode, L-shaped, with cm-marking, distal tip tapered</b>

Units for use with Coagulation and Dissection Electrodes see chapter 20, UNITS

## Accessories for Uretero-Renoscopes and Ureteroscopes

For use with 27001 L/K



27424 F

**Grasping Forceps**, rigid, for stone fragments, double action jaws, 4 Fr., length 60 cm, color code: blue



27424 P

**Grasping Forceps**, rigid, for larger stones and fragments, double action jaws, 4 Fr., length 60 cm, color code: blue



27424 Z

**Biopsy Forceps**, rigid, double action jaws, 4 Fr., length 60 cm, color code: blue



27424 R

**PÉREZ-CASTRO Forceps**, rigid, long double action jaws, for Steinstrasse, 4 Fr., length 60 cm, color code: blue



27424 U

**Splitting Forceps**, rigid, cutting upwards, single action jaws, 4 Fr., length 60 cm, color code: blue



27023 VB

**Stone Basket**, sterile, for single use, 2.5 Fr., length 120 cm



27023 Y

**Brush for Cytology**, unsterile, for single use, 3 Fr., package of 5

# Dissecting and Grasping Forceps

CLICK'liné – rotating, dismantling,  
without connector pin for unipolar coagulation

## Size 10 mm

Operating instruments, length 36 cm,  
for use with trocars size 11 mm

Length	Handle						
	33161	33162	33163	33166	33131	33146	33147
36 cm		<b>NEW</b> 	<b>NEW</b> 	<b>NEW</b> 			

## Double action jaws

Working Insert	Complete Instrument						
33510 TH	33561 TH	33562 TH	33563 TH	33566 TH	33531 TH	33546 TH	33547 TH
   15	CLICK'liné Grasping Forceps, fenestrated						
33510 BC	33561 BC	33562 BC	33563 BC	33566 BC	33531 BC	33546 BC	33547 BC
   34	CLICK'liné BABCOCK Clamp						
33510 BLS	33561 BLS	33562 BLS	33563 BLS	33566 BLS	33531 BLS	33546 BLS	33547 BLS
   33	CLICK'liné BABCOCK Clamp, rounded jaws, long						

10 mm

# RASSWEILER Needle Holders

## Size 5 mm

Operating instruments, length 33 cm,  
for use with trocars size 6 or 11 mm with reduction sleeves



26173 SKG RASSWEILER **Needle Holder**, straight jaws, axial ring handle with ratchet, size 5 mm, length 33 cm, for use with suture material 2/0 – 4/0, needle size SH and RB (Ethicon)



26173 SKL RASSWEILER **Needle Holder**, convex/concave, slender jaws, curved to left, axial ring handle with ratchet, size 5 mm, length 33 cm, for use with suture material 3/0, needle size LH and RB-1 (Ethicon)

# 30141RS

[Home page](#) > Online Catalog - Human Medicine



Item no: 30141RS

## Reducer

Quantity:

− 1 +

On the offer list



### Product details

Reducers, for use with trocars with valve seals

Technical details

Documents & Films

Product group / field of application

Type of usage	Reusable
Sterile	No
For instruments size	11 mm
For reduction of diameter	5 mm

# Trocars

Size 11 mm



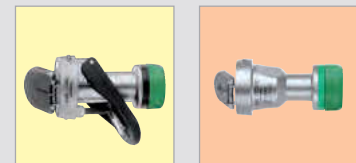
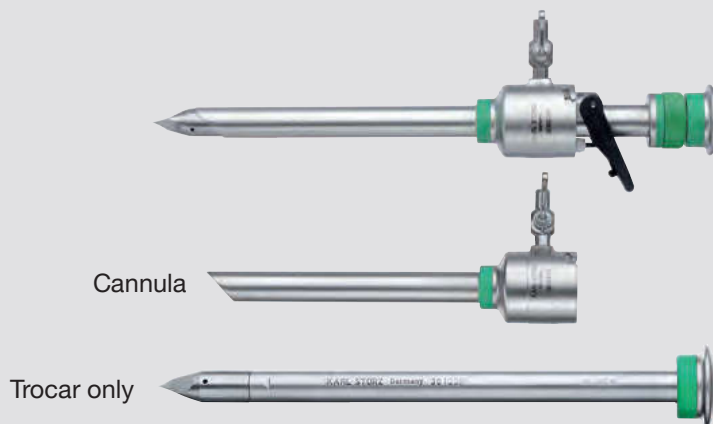

For use with telescopes and instruments size 11 mm



Multifunctional Valve



Automatic Valve

Size:		11 mm			
Working length:		8.5 cm	10.5 cm	8.5 cm	10.5 cm
Color code:		green-white	green	green-white	green
		Multifunctional Valve		Automatic Valve	
	<b>Trocar, with conical tip</b> including: <b>Cannula</b> <b>Trocar only</b> <b>Valve</b>	<b>30103 WY</b> 30103 H1 30103 Y 30103 M1	<b>30103 MC</b> 30103 H2 <b>30103 C</b> 30103 M1	<b>30103 FY</b> 30103 H1 30103 Y 30103 A1	<b>30103 AC</b> 30103 H2 30103 C 30103 A1
	<b>Trocar, with pyramidal tip</b> including: <b>Cannula</b> <b>Trocar only</b> <b>Valve</b>	<b>30103 WZ</b> 30103 H1 30103 Z 30103 M1	<b>30103 MP</b> 30103 H2 30103 P 30103 M1	<b>30103 FZ</b> 30103 H1 30103 Z 30103 A1	<b>30103 AP</b> 30103 H2 30103 P 30103 A1
	<b>Trocar, with blunt tip</b> including: <b>Cannula</b> <b>Trocar only</b> <b>Valve</b>	<b>30103 WX</b> 30103 H1 30103 X 30103 M1	<b>30103 MA</b> 30103 H2 30103 A 30103 M1	<b>30103 FX</b> 30103 H1 30103 X 30103 A1	<b>30103 AA</b> 30103 H2 30103 A 30103 A1
	<b>MOTSON Trocar,</b> with conical, blunt tip, including: <b>Cannula</b> <b>Trocar only</b> <b>Valve</b>	—	<b>30103 MMO</b> 30103 H2 30103 MO 30103 M1	—	<b>30103 AMO</b> 30103 H2 30103 MO 30103 A1
	<b>Trocar</b> including: <b>Cannula</b> <b>Trocar only</b> <b>Valve</b>	—	<b>30103 WSB</b> 30103 H2 30103 SB 30103 M1	—	<b>30103 FSB</b> 30103 H2 30103 SB 30103 A1

Telescopes for use with trocars size 11 mm see pages 31, 35, 38-40  
HEINKEL-SEMM Dilatation Set see page 78, Accessories for Trocars see pages 76-77



# Trocars

Size 6 mm

For use with telescopes and instruments size 5 mm

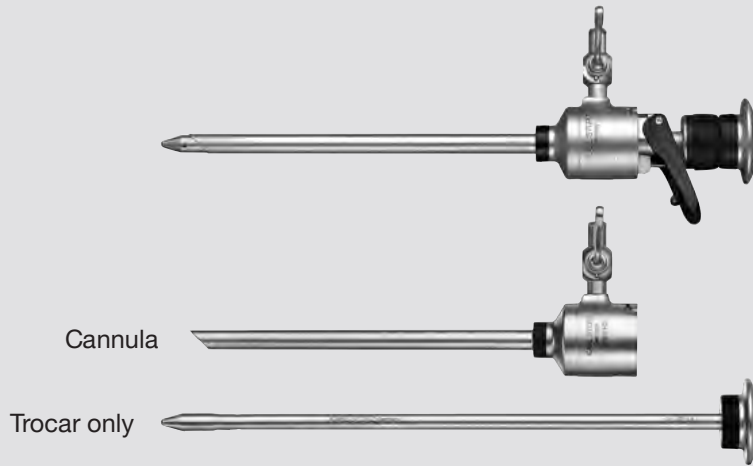





Multifunctional Valve



Automatic Valve



Size:		6 mm			
Working length:		8.5 cm	10.5 cm	8.5 cm	10.5 cm
Color code:		black-white	black	black-white	black
		Multifunctional Valve		Automatic Valve	
	<b>Trocar, with conical tip</b> including: <b>Cannula</b> <b>Trocar only</b> <b>Valve</b>	<b>30160 WY</b> 30160 H1 30160 Y 30160 M1	<b>30160 MC</b> 30160 H2 <b>30160 C</b> 30160 M1	<b>30160 FY</b> 30160 H1 30160 Y 30160 A1	<b>30160 AC</b> 30160 H2 30160 C 30160 A1
	<b>Trocar, with pyramidal tip</b> including: <b>Cannula</b> <b>Trocar only</b> <b>Valve</b>	<b>30160 WZ</b> 30160 H1 30160 Z 30160 M1	<b>30160 MP</b> 30160 H2 30160 P 30160 M1	<b>30160 FZ</b> 30160 H1 30160 Z 30160 A1	<b>30160 AP</b> 30160 H2 30160 P 30160 A1
	<b>Trocar, with blunt tip</b> including: <b>Cannula</b> <b>Trocar only</b> <b>Valve</b>	<b>30160 WX</b> 30160 H1 30160 X 30160 M1	<b>30160 MA</b> 30160 H2 30160 A 30160 M1	<b>30160 FX</b> 30160 H1 30160 X 30160 A1	<b>30160 AA</b> 30160 H2 30160 A 30160 A1
	<b>Trocar</b> including: <b>Cannula</b> <b>Trocar only</b> <b>Valve</b>	–	<b>30160 MB</b> 30160 H2 30160 B 30160 M1	–	<b>30160 AB</b> 30160 H2 30160 B 30160 A1

Telescopes for use with trocars size 6 mm see page 33  
HEINKEL-SEMM Dilatation Set see page 78, Accessories for Trocars see pages 76-77