

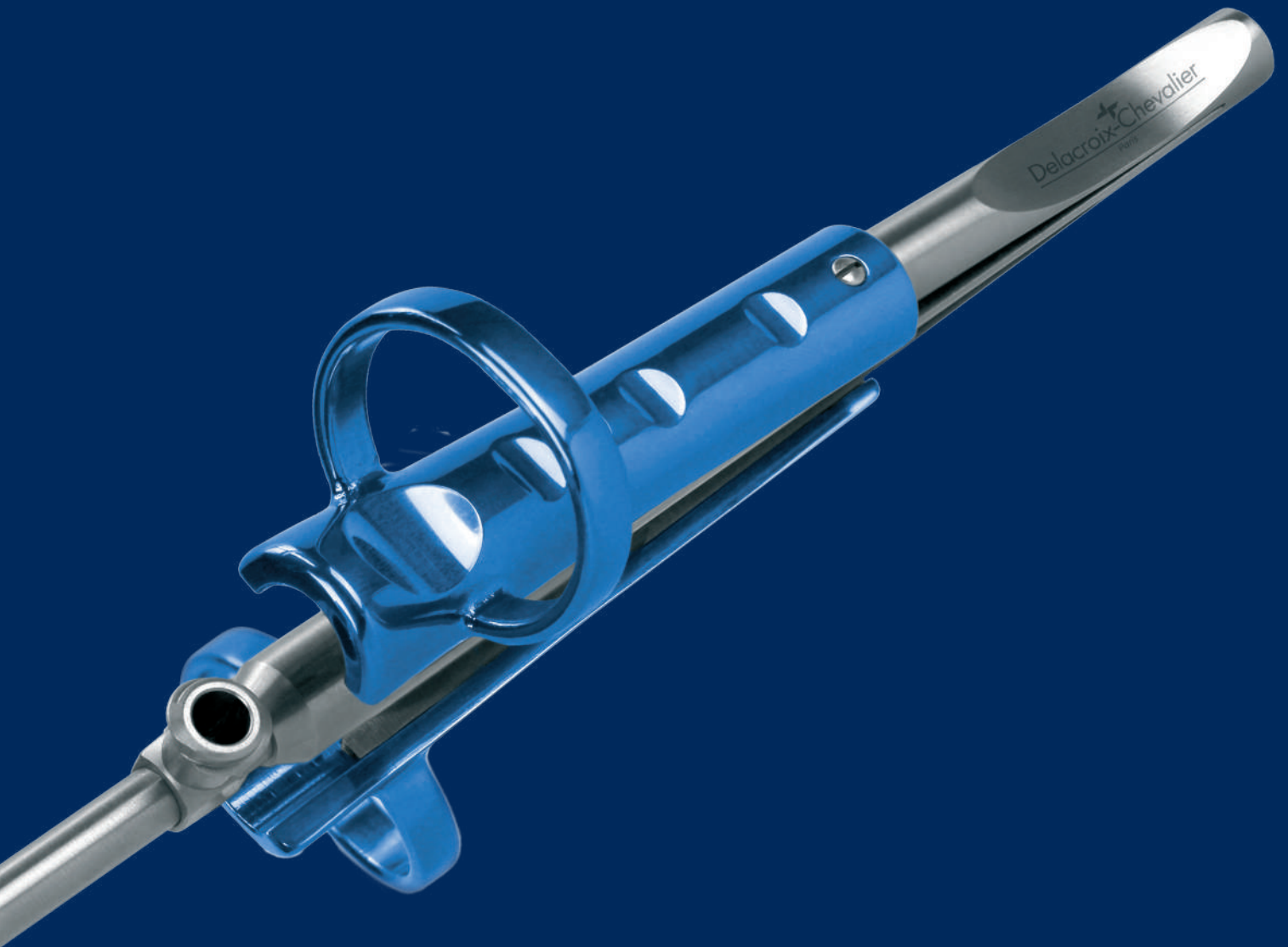

Delacroix-Chevalier
Paris



Minimally Invasive Surgery Instruments

Instruments de Chirurgie Mini-Invasive - Instrumentos de Cirugía Mini-Invasiva

2021

For all information :

Pour tout renseignement :

Para más información :



Tel. (World -Mundo) : +33 3 25 02 10 35

Tél. (France) : 03 25 02 10 10

Monday to Friday - Du lundi au vendredi - De lunes a viernes

From 8:00 am to 6:00 pm (non stop) - De 8 heures à 18 heures - De las 8 a las 18



contact@landanger.com



Corporate office - Siège - Sede

LANDANGER

217 Rue du Faubourg Saint-Honoré

75008 Paris

FRANCE

Manufacturing & Logistic - Production et Logistique - Fabricación y logística

Rue Renée et Louis Landanger

52000 Chaumont

FRANCE

Delacroix-Chevalier® is a brand of LANDANGER Company

Contact - Contact - Contacto :



Delacroix-Chevalier

Paris

Since - Depuis - Desde
1920

Code Référence Referencia	Page Page Página	Code Référence Referencia	Page Page Página	Code Référence Referencia	Page Page Página	Code Référence Referencia	Page Page Página	Code Référence Referencia	Page Page Página
DC30159-00	131	DC80022-36	90	DC80132-36	39	DC80231-36	11	DC80995-26	83
DC30212-20	63	DC80023-30	90	DC80132-43	39	DC80232-30	8	DC80995-32	83
DC30222-38	63	DC80023-36	90	DC80133-25	39	DC80232-36	8	DC80995-36	83
DC30223-43	63	DC80024-30	90	DC80133-30	39	DC80233-30	14	DC80996-26	83
DC30300-00	63	DC80024-36	90	DC80133-36	39	DC80233-36	14	DC80996-32	83
DC30600-00	60	DC80025-30	94	DC80133-43	39	DC80234-30	14	DC80996-36	83
DC30800-00	64	DC80025-36	94	DC80140-40	31	DC80234-36	14	DC80997-26	84
DC30810-25	64	DC80040-28	88	DC80200-24	8	DC80235-30	15	DC80997-32	84
DC30811-35	64	DC80100-30	34	DC80200-28	8	DC80235-36	15	DC80997-36	84
DC30812-45	64	DC80100-36	34	DC80200-30	8	DC80240-28	5	DC80998-26	84
DC30813-55	64	DC80101-30	34	DC80200-36	8	DC80241-40	13	DC80998-32	84
DC32300-00	58	DC80101-36	34	DC80200-43	8	DC80242-40	78	DC80998-36	84
DC32900-00	59	DC80101-43	34	DC80201-30	8	DC80300-30	102	DC81000-00	59
DC71337-33	114	DC80102-30	34	DC80201-36	8	DC80300-36	102	DC81010-00	65
DC71337-33-C	114	DC80102-36	34	DC80201-43	8	DC80302-30	102	DC81020-00	65
DC71337-33-S	114	DC80102-43	34	DC80202-25	10	DC80302-36	102	DC81050-00	47
DC71710-50	104	DC80103-30	30	DC80202-30	10	DC80303-30	102	DC81050-01	47
DC80009-25	96	DC80103-36	30	DC80202-36	10	DC80303-36	102	DC81050-02	47
DC80009-30	96	DC80104-30	30	DC80202-43	10	DC80304-30	102	DC81050-03	47
DC80009-36	96	DC80104-36	30	DC80203-28	4	DC80304-36	102	DC81115-00	48
DC80009-43	96	DC80105-28	28	DC80203-30	4	DC80417-24	118	DC81117-94	48
DC80010-30	92	DC80105-30	28	DC80204-30	9	DC80418-36	118	DC81118-50	48
DC80010-36	92	DC80106-28	28	DC80204-36	9	DC80419-36	118	DC81118-60	48
DC80011-30	92	DC80106-30	28	DC80204-43	9	DC80420-24	118	DC81118-70	48
DC80011-36	92	DC80107-30	34	DC80205-28	4	DC80459-28	106	DC81301-00	72
DC80012-25	93	DC80107-36	34	DC80205-30	4	DC80459-34	106	DC81301-01	72
DC80012-30	93	DC80109-28	32	DC80205-36	9	DC80459-38	106	DC81301-30	72
DC80012-36	93	DC80109-30	32	DC80207-30	9	DC80461-27C	43	DC81302-00	72
DC80012-43	93	DC80110-30	37	DC80207-36	9	DC80461-27S	43	DC81302-30	72
DC80013-25	93	DC80110-36	37	DC80207-43	9	DC80461-29	43	DC81303-33	74
DC80013-30	93	DC80110-44	37	DC80208-30	8	DC80461-34	43	DC81304-00	72
DC80013-36	93	DC80111-25	35	DC80208-36	8	DC80462-22	44	DC81304-30	72
DC80013-44	93	DC80112-25	35	DC80208-43	8	DC80462-29	44	DC81305-21	73
DC80014-28	87	DC80113-30	30	DC80209-36	9	DC80700-30	115	DC81305-30	73
DC80014-30	93	DC80113-36	30	DC80220-30	6	DC80701-30	115	DC81307-00	72
DC80014-36	93	DC80114-30	27	DC80220-36	6	DC80702-30	115	DC81307-30	72
DC80015-28	89	DC80115-30	27	DC80221-30	6	DC80710-23	116	DC81308-00	103
DC80015-36	89	DC80116-28	25	DC80221-36	6	DC80710-30	116	DC81308-28	103
DC80017-28	89	DC80117-28	25	DC80222-30	7	DC80711-23	116	DC81308-35	103
DC80017-36	89	DC80120-30	33	DC80222-36	7	DC80711-30	116	DC81310-00	112
DC80018-28	87	DC80121-30	33	DC80224-30	6	DC80730-30	117	DC81310-28	112
DC80018-36	87	DC80122-30	33	DC80224-36	6	DC80731-30	117	DC81320-38	110
DC80019-25	96	DC80123-30	29	DC80227-30	6	DC80915-29	43	DC81322-38	110
DC80019-30	96	DC80124-30	29	DC80227-36	6	DC80915-42	43	DC81323-21	103
DC80019-36	96	DC80127-30	33	DC80228-30	3	DC80993-26	82	DC81323-30	103
DC80019-43	96	DC80130-30	36	DC80228-36	3	DC80993-26C	82	DC81330-00	119
DC80020-30	91	DC80130-36	36	DC80229-30	3	DC80993-32	82	DC81330-01	119
DC80020-36	91	DC80131-30	36	DC80229-36	3	DC80993-36	82	DC81330-33	119
DC80021-30	91	DC80131-36	36	DC80230-30	3	DC80994-26	82	DC81331-33	119
DC80021-36	91	DC80132-25	39	DC80230-36	3	DC80994-32	82	DC81363-24	48
DC80022-30	90	DC80132-30	39	DC80231-30	11	DC80994-36	82	DC81364-36	48

Code Référence Referencia	Page Page Página	Code Référence Referencia	Page Page Página	Code Référence Referencia	Page Page Página	Code Référence Referencia	Page Page Página	Code Référence Referencia	Page Page Página
DC81400-00	113	DC82120-95	56	DC82163-40	52	DC83201-44	12	DC84204-35	20
DC81400-01	113	DC82121-16	56	DC82163-50	52	DC83202-36	12	DC84204-41	20
DC81410-28	111	DC82121-20	56	DC82164-30	52	DC83202-44	12	DC84207-35	20
DC81410-36	111	DC82122-22	57	DC82164-40	52	DC83207-36	12	DC84207-41	20
DC81900-05	131	DC82122-24	57	DC82164-50	52	DC83207-44	12	DC84240-26	18
DC81901-00	135	DC82122-26	57	DC82165-35	52	DC83208-36	17	DC84241-45	22
DC81902-00	135	DC82124-30	56	DC82169-00	51, 136	DC83208-44	17	DC84242-45	81
DC81903-00	134	DC82125-05	56	DC82200-00	61	DC83209-36	17	DC84243-45	81
DC81904-00	134	DC82130-00	55	DC82210-00	62	DC83209-44	17	DC84244-45	22
DC81907-00	136	DC82131-30	55	DC82940-38	66	DC83210-36	80	DC84300-35	105
DC81908-00	137	DC82131-40	55	DC82940-40	66	DC83210-44	80	DC84300-41	105
DC81910-01	132	DC82131-50	55	DC82950-38	67	DC83211-36	80	DC89100-00	121
DC81910-02	132	DC82132-30	55	DC82960-07	68	DC83211-44	80	DC89100-01	121
DC81910-03	132	DC82132-40	55	DC82960-10	68	DC83213-36	79	DC89100-02	121
DC81912-01	130	DC82132-50	55	DC82961-07	68	DC83213-36WR	79	DC89100-19	121
DC81912-02	130	DC82133-30	55	DC82961-10	68	DC83213-44	79	DC89101-00	121
DC81912-03	130	DC82133-40	55	DC82962-07	68	DC83213-44WR	79	DC89111-01	121
DC81913-01	133	DC82133-50	55	DC82962-10	68	DC83216-36	77	DC89111-01	121
DC81913-02	133	DC82141-30	55	DC82963-07	68	DC83216-44	77	DC89111-10	121
DC81913-03	133	DC82141-40	55	DC82963-10	68	DC83221-44	79	DC89112-01	121
DC81914-00	48, 137	DC82141-50	55	DC82964-07	68	DC83221-44WR	79	DC89112-05	121
DC81930-01	120	DC82142-30	55	DC82964-10	68	DC83224-36	16	E229006	71
DC81930-02	120	DC82142-40	55	DC82965-70	69	DC83224-44	16	E229011	71
DC82100-00	53	DC82142-50	55	DC82966-07	68	DC83225-36	16	E229013	71
DC82100-01	54	DC82143-30	55	DC82966-10	68	DC83225-44	16	E229015	71
DC82100-02	54	DC82143-40	55	DC82970-07	69	DC84010-41	100	E229121	69
DC82100-99	53	DC82143-50	55	DC82970-10	69	DC84011-41	100	J00011	26
DC82101-30	53	DC82150-00	50	DC82980-07	70	DC84012-35	101	J00012	26
DC82101-40	53	DC82150-01	50	DC82981-07	70	DC84012-41	101	J00021	109
DC82101-50	53	DC82151-20	49	DC82981-10	70	DC84013-33	101	J00022	109
DC82102-30	53	DC82151-20	50	DC82982-07	70	DC84013-35	101	O600406	47
DC82102-40	53	DC82151-30	49	DC82982-10	70	DC84013-41	101		
DC82102-50	53	DC82151-30	50	DC82983-07	70	DC84017-41	99		
DC82103-30	53	DC82151-40	49	DC82983-10	70	DC84040-26	98		
DC82103-40	53	DC82151-40	50	DC82984-07	70	DC84101-35	42		
DC82103-50	53	DC82152-00	49	DC82984-10	70	DC84101-41	42		
DC82104-40	54	DC82152-99	49	DC83002-36	95	DC84102-35	42		
DC82111-30	53	DC82153-30	49	DC83002-44	95	DC84102-41	42		
DC82111-40	53	DC82153-30	50	DC83003-36	95	DC84116-26	40		
DC82111-50	53	DC82160-00	51	DC83003-44	95	DC84117-26	40		
DC82112-30	53	DC82160-00	51	DC83009-36	97	DC84140-45	41		
DC82112-40	53	DC82160-99	52	DC83019-36	97	DC84141-45	41		
DC82112-50	53	DC82161-30	51	DC83110-02	37	DC84200-35	19		
DC82113-30	53	DC82161-40	51	DC83110-12	38	DC84200-41	19		
DC82113-40	53	DC82161-50	51	DC83110-36	38	DC84200-41R	19		
DC82113-50	53	DC82161-60	51	DC83110-44	38	DC84201-35	19		
DC82114-40	54	DC82161-70	51	DC83112-36	37	DC84201-41	19		
DC82115-40	54	DC82162-30	52	DC83112-44	37	DC84202-35	21		
DC82120-30	56	DC82162-40	52	DC83200-36	12	DC84202-41	21		
DC82120-50	56	DC82162-50	52	DC83200-44	12	DC84202-41R	21		
DC82120-90	56	DC82163-30	52	DC83201-36	12	DC84203-26	18		

DISSECTING FORCEPS / PINCES À DISSECTION / PINZAS PARA DISECCIÓN

Ø 2,7 mm



P 3

Ø 3,5 mm



P 4 - 5

Ø 3,5 mm / Ø 5 mm



P 6 - 7

Ø 5 mm



P 8 - 11

Ø 5 mm



Titanium

P 12

DISSECTORS / DISSECTEURS / DISECTORES

HF DISSECTORS / DISSECTEURS HF / HF DISECTORES

Ø 3.5 mm



Titanium

P 13

Ø 5 mm



P 14 - 16

Ø 5 mm



Titanium

P 17

MICROMICS DISSECTING FORCEPS / PINCES À DISSECTION MICROMICS / PINZAS PARA DISECCIÓN MICROMICS

Ø 5 mm



P 18 - 21

MICROMICS DISSECTORS / DISSECTEURS MICROMICS / DISECTORES MICROMICS

Ø 3,5 mm / Ø 5 mm



P 22



TC Inserts

Ø 2.7 mm

NEW
NOUVEAU
NUEVO

Patent
Breveté
Patentado

Straight
Droite
Recta

1 mm
1-1



DC80228-30

L : 300 mm - 11 4/5"



DC80228-36

L : 360 mm - 14 1/5"

Only One Mobile Jaw
Un Seul Mors Mobile
Sólo Una Boca Móvil



10°

1 mm
1-1



DC80229-30

L : 300 mm - 11 4/5"

DC80229-36

L : 360 mm - 14 1/5"

25°

1 mm
1-1



DC80230-30

L : 300 mm - 11 4/5"

DC80230-36

L : 360 mm - 14 1/5"



Dissecting Forceps / Pincés à Dissection / Pinzas para Disección

Ø 3.5 mm



DeBakey

Straight
Droite
Recta

2.75 mm



DC80203-28

L: 280 mm - 11"

DC80203-30

L: 300 mm - 11 4/5"

Only One Mobile Jaw
Un Seul Mors Mobile
Sólo Una Boca Móvil



Angled on Flat
Coudée sur le Plat
Anglada en el Plano

1.5 mm

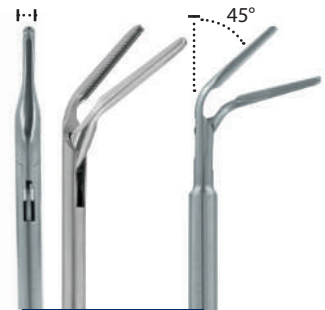

DC80205-28

L: 280 mm - 11"

DC80205-30

L: 300 mm - 11 4/5"



Diamonite

Ø 3.5 mm

NEW
NOUVEAU
NUEVO



Straight
Droite
Recta

2 mm



6 mm

DC80240-28

L : 280 mm - 11"



Dissecting Forceps / Pincés à Dissection / Pinzas para Disección

Ø 3.5 mm / Ø 5 mm



DeBakey

Straight
Droite
Recta

1.5 mm



DC80221-30

L : 300 mm - 11 4/5"

DC80221-36

L : 360 mm - 14 1/4"

NEW
NOUVEAU
NUEVO

2.75 mm



DC80220-30

L : 300 mm - 11 4/5"

DC80220-36

L : 360 mm - 14 1/5"

NEW
NOUVEAU
NUEVO

Curved
Courbe
Curva

2.75 mm



DC80224-30

L : 300 mm - 11 4/5"

DC80224-36

L : 360 mm - 14 1/5"

NEW
NOUVEAU
NUEVO

2.75 mm



DC80227-30

L : 300 mm - 11 4/5"

DC80227-36

L : 360 mm - 14 1/5"

NEW
NOUVEAU
NUEVO

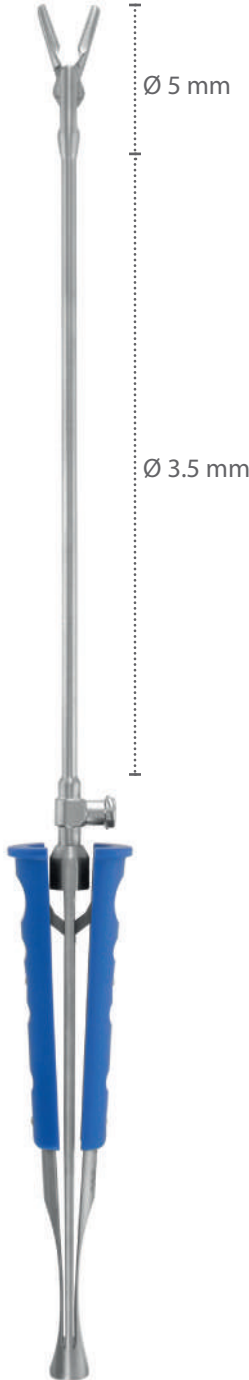

Ø 3.5 mm / Ø 5 mm



Resano

Straight
Droite
Recta

2.9 mm
|---|



DC80222-30

L : 300 mm - 11 4/5"

DC80222-36

L : 360 mm - 14 1/5"

NEW
NOUVEAU
NUEVO

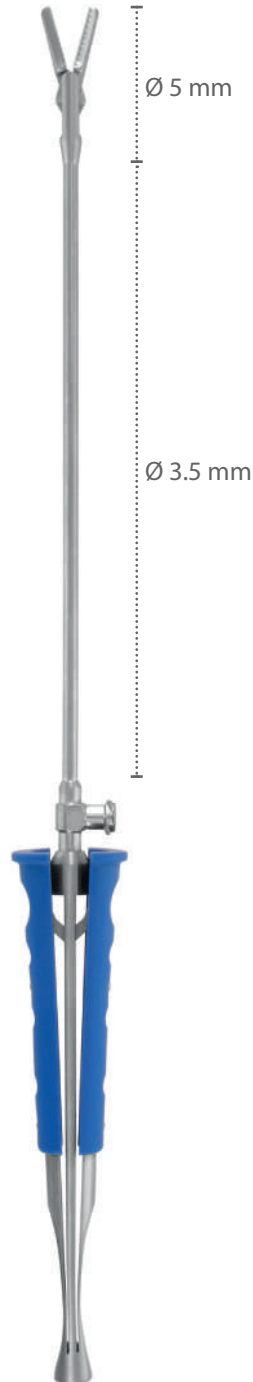

Dissecting Forceps / Pincés à Dissection / Pinzas para Disección

Ø 5 mm



DeBakey

Straight
Droite
Recta

1.5 mm
I-I



DC80201-30
L : 300 mm - 11 4/5"

DC80201-36
L : 360 mm - 14 1/5"

DC80201-43
L : 430 mm - 17"

2.75 mm
I-I



DC80200-24 **NEW NOUVEAU NUEVO**
L : 240 mm - 9 1/2"

DC80200-28
L : 280 mm - 11"

DC80200-30
L : 300 mm - 11 4/5"

DC80200-36
L : 360 mm - 14 1/5"

DC80200-43 **NEW NOUVEAU NUEVO**
L : 430 mm - 17"



3/5

Straight
Droite
Recta

Only One Mobile Jaw
Un Seul Mors Mobile
Sólo Una Boca Móvil
Teeth / Dents / Dientes : 2 x 3

5 mm
I-I



DC80208-30 **NEW NOUVEAU NUEVO**
L : 300 mm - 11 4/5"

DC80208-36
L : 360 mm - 14 1/5"

DC80208-43 **NEW NOUVEAU NUEVO**
L : 430 mm - 17"

2.8 mm
I-I

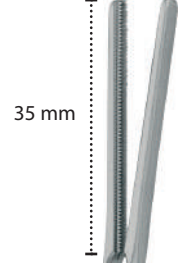

DC80232-30 **NEW NOUVEAU NUEVO**
L : 300 mm - 11 4/5"

DC80232-36 **NEW NOUVEAU NUEVO**
L : 360 mm - 14 1/5"

DC80232-43 **NEW NOUVEAU NUEVO**
L : 430 mm - 17"



DeBailey

Curved
Courbe
Curva



DC80207-30

L : 300 mm - 11 ⁴/₅"

DC80207-36

L : 360 mm - 14 ¹/₅"

DC80207-43

L : 430 mm - 17"

NEW
NOUVEAU
NUEVO

Angled
Angulés
Anguladas



DC80204-30

L : 300 mm - 11 ⁴/₅"

DC80204-36

L : 360 mm - 14 ¹/₅"

DC80204-43

L : 430 mm - 17"

NEW
NOUVEAU
NUEVO

Very Curved
Très Courbe
Muy Curva



DC80209-36

L : 360 mm - 14 ¹/₅"

Angled on Flat - Only One Mobile Jaw
Coudée sur le Plat - Un seul Mors Mobile
Angulada en el plano - Sólo Una Boca Móvil

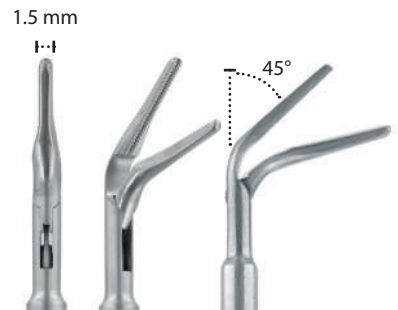

DC80205-36

L : 360 mm - 14 ¹/₅"

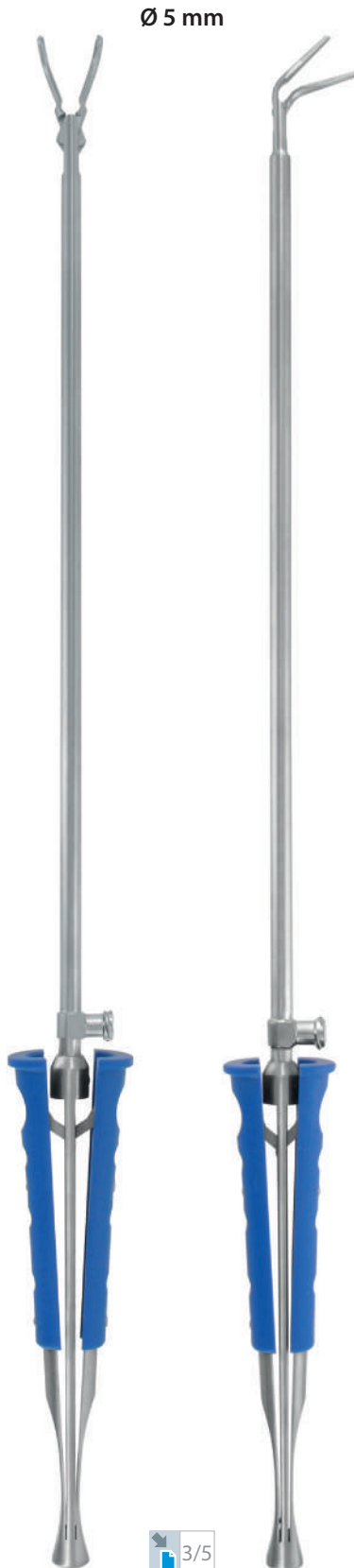

Ø 5 mm

3/5

Dissecting Forceps / Pincès à Dissection / Pinzas para Disección



Resano

Ø 5 mm

Straight
Droite
Recta

2.9 mm
t...t



DC80202-25

L : 250 mm - 10"

NEW
NOUVEAU
NUEVO

DC80202-30

L : 300 mm - 11 ⁴/₅"



DC80202-36

L : 360 mm - 14 ¹/₅"

DC80202-43

L : 430 mm - 17"

NEW
NOUVEAU
NUEVO



3/5

Ø 5 mm

Smooth Jaws
Mors Lisses
Mandibulas Lisas

NEW
NOUVEAU
NUEVO

4.3 mm



DC80231-30

L : 300 mm - 11 ⁴/₅"



DC80231-36

L : 360 mm - 14 ¹/₅"



3/5

Dissecting Forceps With Ratchet / Pincés à Dissection à Crémaillère / Pinzas para Dissección con Cremallera



DeBailey

Straight
Droite
Recta

2.75 mm



DC83200-36

L : 360 mm - 14 1/5"

DC83200-44

L : 440 mm - 17 1/3"

Ø 5 mm



Registered Design
Modèle déposé
Diseño registrado

Curved
Courbe
Curva

2.75 mm



DC83207-36

L : 360 mm - 14 1/5"

DC83207-44

L : 440 mm - 17 1/3"

1.5 mm



DC83201-36

L : 360 mm - 14 1/5"

DC83201-44

L : 440 mm - 17 1/3"



Resano

Straight
Droite
Recta

2.9 mm



DC83202-36

L : 360 mm - 14 1/5"

DC83202-44

L : 440 mm - 17 1/3"

NEW
NOUVEAU
NUEVO

NEW
NOUVEAU
NUEVO

Titanium

Progressive Locking System
Crémaillère Progressive
Cremallera Progressiva



Ø 3.5 mm

NEW
NOUVEAU
NUEVO
Patent
Breveté
Patentado

MARYLAND

Curved
Courbe
Curva



DC80241-40
L : 400 mm - 15 3/4"



Ø 5 mm

Serrated Jaws
Mors Striés
Mandíbulas Serradas

NEW
NOUVEAU
NUEVO

With Ratchet
Avec Verrou
Con Cerrojo



DC80233-30
L : 300 mm - 11 ⁴/₅"
DC80233-36
L : 360 mm - 14 ¹/₅"

Without Ratchet
Sans Verrou
Sin Cerrojo



DC80234-30
L : 300 mm - 11 ⁴/₅"
 **DC80234-36**
L : 360 mm - 14 ¹/₅"



Ø 5 mm

Smooth Jaws
Mors Lisses
Mandibulas Lisas

NEW
NOUVEAU
NUEVO



1.2 mm

DC80235-30

L : 300 mm - 11 ⁴/₅"



DC80235-36

L : 360 mm - 14 ¹/₅"



3/5

Patent
Breveté
Patentado

Ø 5 mm

90°



DC83225-36

L : 360 mm - 14 1/5"

DC83225-44

L : 440 mm - 17 1/3"

To be Used with Oval 16x25mm
Trocar DC82970-70

À Utiliser avec un Trocart Oval
de 16 x 25 mm DC82970-70
Usar con un Óvalo Trocar de
16 x 25 mm DC82970-70

Very Curved Jaws
Mors Très Courbes
Bocas Muy Curvas



DC83224-36

L : 360 mm - 14 1/5"

DC83224-44

L : 440 mm - 17 1/3"

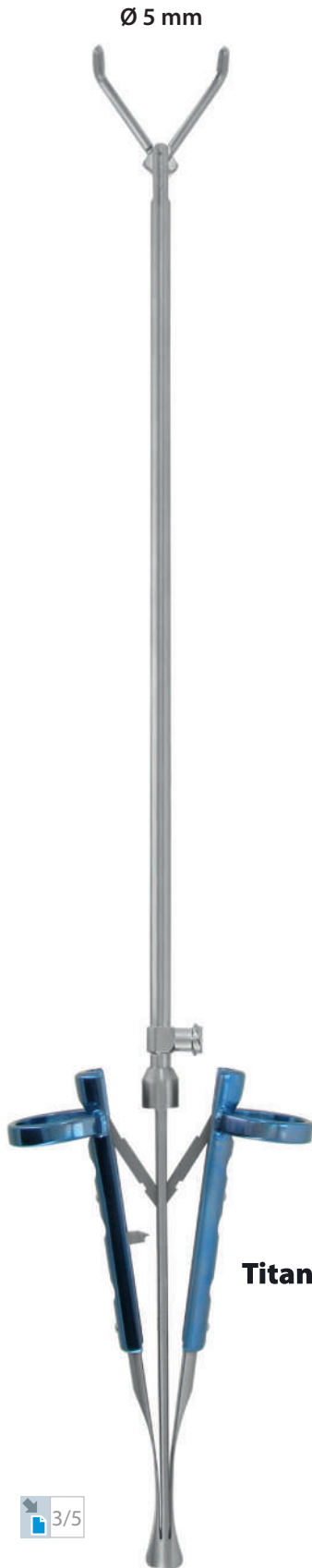

Titanium *line*

3/5

Patent
Breveté
Patentado

Ø 5 mm

Maryland

Curved
Courbe
Curva

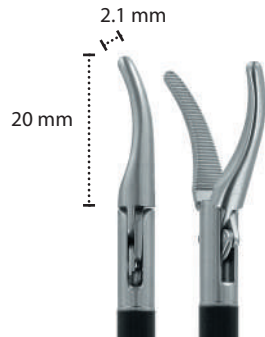

DC83208-36 *

L : 360 mm - 14 1/5"

DC83208-44 *

L : 440 mm - 17 1/3"

Gossot

Long Curved Jaws
Mors Courbes Longs
Bocas Curvas Largas



DC83209-36 *

L : 360 mm - 14 1/5"

DC83209-44 *

L : 440 mm - 17 1/3"

To be Used with Ø 10mm Trocar
À Utiliser avec un Trocart de Ø 10 mm
Usar con un Trocar de Ø 10 mm



Titanium

3/5

* For regulatory reason, please check with your distributor for availability in your country

* Por razones reglamentarias, por favor póngase en contacto con su distribuidor para conocer la disponibilidad en su país

MicroMICS Dissecting Forceps / Pincas à Dissection MicroMICS / Pinzas para Disección MicroMICS

Yilmaz
Ø 3.5 mm

NEW
NOUVEAU
NUEVO

Registered Design
Modèle déposé
Diseño registrado



Diamonite

Straight
Droite
Recta

2 mm
6 mm



DC84240-26

WL: 90 mm - 3 1/2"
L: 260 mm - 10"



DeBakey

Straight
Droite
Recta

2.75 mm

DC84203-26

WL: 90 mm - 3 1/2"
L: 260 mm - 10"

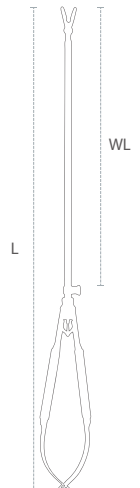



DeBakey

Ø 5 mm

NEW
NOUVEAU
NUEVO

Registered Design
Modèle déposé
Diseño registrado

Straight
Droite
Recta

1.5 mm



DC84201-35

WL: 180 mm - 7"
L: 350 mm - 13^{4/5}"

DC84201-41

WL: 240 mm - 9^{1/2}"
L: 410 mm - 16"

Straight
Droite
Recta

2.75 mm



DC84200-35

WL: 180 mm - 7"
L: 350 mm - 13^{4/5}"

 **DC84200-41**

WL: 240 mm - 9^{1/2}"
L: 410 mm - 16"

With Ratchet
Avec Verrou
Con Sistema de Cierre

DC84200-41R

WL: 240 mm - 9^{1/2}"
L: 410 mm - 16"



MicroMICS Dissecting Forceps / Pinces à Dissection MicroMICS / Pinzas para Disección MicroMICS



DeBakey

Ø 5 mm

NEW
NOUVEAU
NUEVO

Registered Design
Modèle déposé
Diseño registrado

Anguled
Angulés
Anguladas



DC84204-35

WL: 180 mm - 7"
L: 350 mm - 13 4/5"



DC84204-41

WL: 240 mm - 9 1/2"
L: 410 mm - 16"

Curved
Courbe
Curva



DC84207-35

WL: 180 mm - 7"
L: 350 mm - 13 4/5"

DC84207-41

WL: 240 mm - 9 1/2"
L: 410 mm - 16"





Resano

Ø 5 mm

NEW
NOUVEAU
NUEVO

Registered Design
Modèle déposé
Diseño registrado

Straight
Droite
Recta

2.9 mm
I-I



DC84202-35

WL: 180 mm - 7"
L: 350 mm - 13^{4/5}"



DC84202-41

WL: 240 mm - 9^{1/2}"
L: 410 mm - 16"

With Ratchet
Avec Verrou
Con Sistema de Cierre

DC84202-41R

WL: 240 mm - 9^{1/2}"
L: 410 mm - 16"



1/2

Yilmaz

MARYLAND

NEW
NOUVEAU
NUEVO

Registered Design
Modèle déposé
Diseño registrado

Curved
Courbe
Curva

Ø 3.5 mm



 DC84241-45

WL: 280 mm - 11"
L: 450 mm - 17^{4/5}"

Curved
Courbe
Curva

Ø 5.0 mm

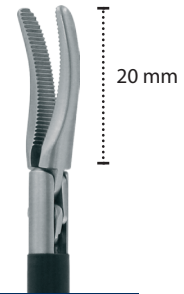

DC84244-45

WL: 280 mm - 11"
L: 450 mm - 17^{4/5}"



ANGLED SCISSORS / CISEAUX ANGULÉS / TIJERAS ANGULADAS

Ø 2 mm / Ø 2.5 mm



P 25

Ø 2 mm / Ø 2.5 mm

Angled shaft / Tube angulé / Tubo anguladas



P 26

Ø 3 mm



P 27

Ø 3,5 mm



P 28

Ø 3,5 mm / Ø 5 mm



P 29

Ø 5 mm



P 30

CURVED SCISSORS / CISEAUX COURBES / TIJERAS CURVAS

Ø 3,5 mm

Ø 3,5 mm

Ø 3,5 mm / Ø 5 mm

Ø 5 mm

Ø 5 mm

Ø 5 mm / Ø 7 mm

TC blades / Lames TC / Hojas TC



P 31



P 32



P 33



P 34 - 35



P 36



P 39

HANDLES FOR SCISSORS TIPS / MANCHES POUR EMBOUTS CISEAUX / MANGOS PARA PUNTAS DE TIJERAS

Ø 5mm



P 37

HF HANDLES FOR SCISSORS TIPS / MANCHES HF POUR EMBOUTS CISEAUX / MANGOS HF PARA PUNTAS DE TIJERAS

Ø 5mm



Titanium

P 38

MICROMICS SCISSORS / CISEAUX MICROMICS / TIJERAS MICROMICS

Ø 2 mm / Ø 2,5 mm



P 40

Ø 3,5 mm



P 41

Ø 5 mm



P 41 - 42

TRANSTHORACIC SCISSORS / CISEAUX TRANSTHORACIQUES / TIJERAS TRANSTORÁDICAS

Ø 10 mm



P 43 - 44

Angled Scissors / Ciseaux Angulés / Tijeras Anguladas

Ø 2 mm / Ø 2.5 mm



Angled Scissors / Ciseaux Angulés / Tijeras Anguladas

Ø 3 mm

Only One Mobile Blade
Une Seule Lame Mobile
Sólo Una Hoja Móvil

45°



 **DC80114-30**

L : 300 mm - 11 ⁴/₅"

120°



DC80115-30

L : 300 mm - 11 ⁴/₅"



Angled Scissors / Ciseaux Angulés / Tijeras Anguladas

Ø 3.5 mm

45°



DC80105-28

L : 280 mm - 11"

DC80105-30

L : 300 mm - 11^{4/5}"

Only One Mobile Blade
Une Seule Lame Mobile
Sólo Una Hoja Móvil



125°



 **DC80106-28**

L : 280 mm - 11"

DC80106-30

L : 300 mm - 11^{4/5}"

Angled Scissors / Ciseaux Angulés / Tijeras Anguladas

Ø 3.5 mm / Ø 5 mm

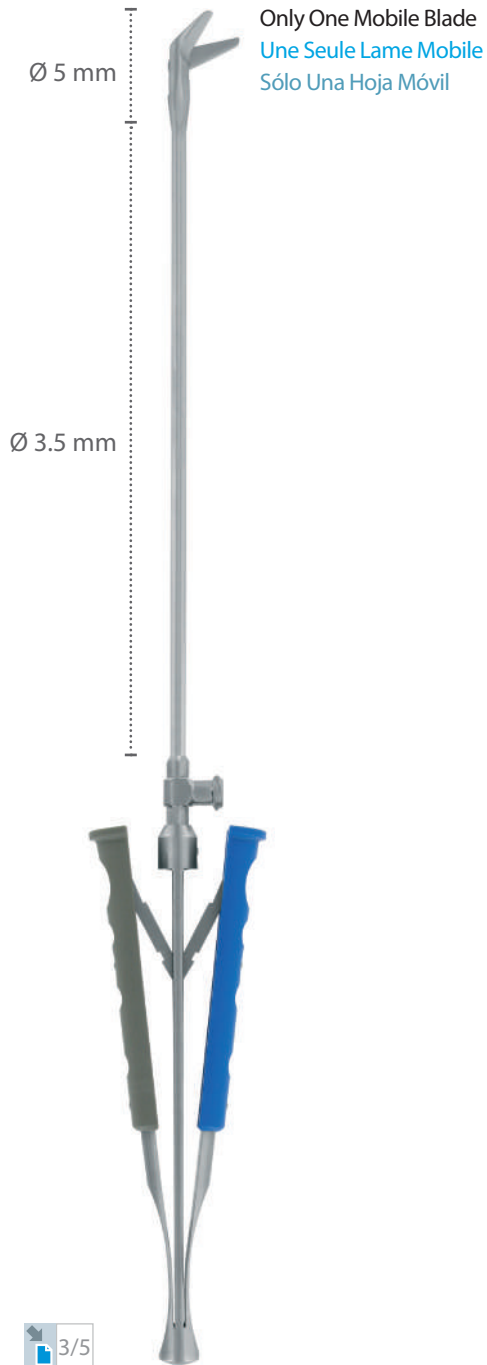

Angled Scissors / Ciseaux Angulés / Tijeras Anguladas

Ø 5 mm

30°



DC80113-30

L : 300 mm - 11 4/5"

DC80113-36

L : 360 mm - 14 1/5"

NEW
NOUVEAU
NUEVO

45°



DC80103-30

L : 300 mm - 11 4/5"



DC80103-36

L : 360 mm - 14 1/5"



90°



DC80104-30

L : 300 mm - 11 4/5"

DC80104-36

L : 360 mm - 14 1/5"



Ø 3.5 mm

NEW
NOUVEAU
NUEVO



Curved Scissors / Ciseaux Courbes / Tijeras Curvas

Ø 3.5 mm

Curved
Courbe
Curva



DC80109-28

L : 280 mm - 11"

DC80109-30

L : 300 mm - 11^{4/5}"

Only One Mobile Blade
Une Seule Lame Mobile
Sólo Una Hoja Móvil



Curved Scissors / Ciseaux Courbes / Tijeras Curvas

Ø 3.5 mm / Ø 5 mm

Curved - Only One Mobile Blade
Courbe - Une Seule Lame Mobile
Curva - Sólo Una Hoja Móvil



DC80127-30
L : 300 mm - 11 4/5"

Curved
Courbe
Curva



DC80121-30
L : 300 mm - 11 4/5"

Lightly Curved
Légèrement Courbes
Ligeramente Curvas



DC80120-30
L : 300 mm - 11 4/5"

Strongly Curved
Très Courbes
Muy C urvas



DC80122-30
L : 300 mm - 11 4/5"

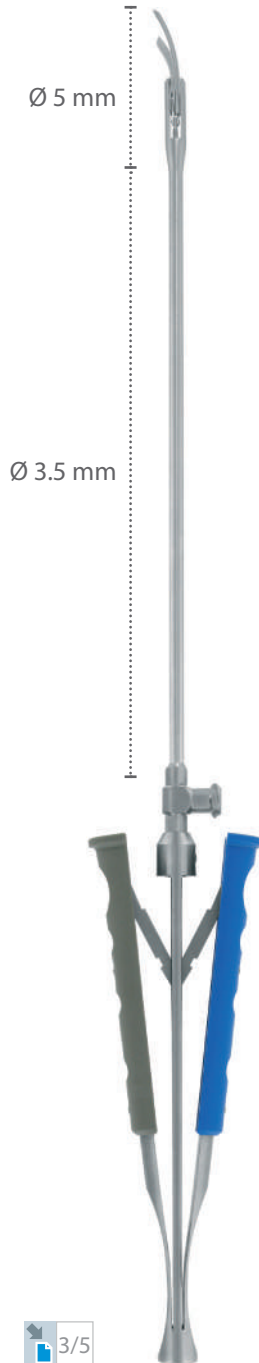

Curved Scissors / Ciseaux Courbes / Tijeras Curvas

Curved - Only One Mobile Blade
Courbe - Une Seule Lame Mobile
Curva - Sólo Una Hoja Móvil



DC80107-30

L : 300 mm - 11 4/5"

DC80107-36

L : 360 mm - 14 1/5"

Lightly Curved
Légèrement Courbes
Ligeramente Curvas



DC80100-30

L : 300 mm - 11 4/5"

DC80100-36

L : 360 mm - 14 1/5"

Ø 5 mm



3/5

Curved
Courbe
Curva



DC80101-30

L : 300 mm - 11 4/5"



DC80101-36

L : 360 mm - 14 1/5"

DC80101-43

L : 430 mm - 17"

Strongly Curved
Très Courbes
Muy Curvas



DC80102-30

L : 300 mm - 11 4/5"

DC80102-36

L : 360 mm - 14 1/5"

DC80102-43

L : 430 mm - 17"

Curved Scissors / Ciseaux Courbes / Tijeras Curvas

Ø 5 mm

With Reduced Spring Action Force
Avec Effort de Fermeture Réduit
Con Fuerza de Cierre Reducida

Curved
Courbe
Curva



DC80111-25

L : 250 mm - 10"

Strongly Curved
Très Courbes
Muy Curvas



DC80112-25

L : 250 mm - 10"



Curved Scissors with TC blades / Ciseaux Courbes avec Lames TC / Tijeras Curvas con Hojas TC



TC Insert

Ø 5 mm

TC Blades
Lames TC
Hojas TC

Lightly Curved
Légèrement Courbes
Ligeramente Curvas



DC80130-30

L : 300 mm - 11 ⁴/₅"



DC80130-36

L : 360 mm - 14 ¹/₅"

Curved
Courbe
Curva



DC80131-30

L : 300 mm - 11 ⁴/₅"

DC80131-36

L : 360 mm - 14 ¹/₅"



Ø 5 mm

Patent
Breveté
Patentado

Reusable Curved Metzenbaum Scissors
Ciseaux Metzenbaum Courbes Réutilisables
Tijeras Metzenbaum Curvas Desechables



15 mm

DC83110-02

Ø : 5 mm

Registered Design
Modèle déposé
Diseño registrado



DC80110-30

L : 300 mm - 11 4/5"



DC80110-36

L : 360 mm - 14 1/5"

DC80110-44

L : 440 mm - 17 1/4"

NEW
NOUVEAU
NUEVO



DC83112-36

L : 360 mm - 14 1/5"

DC83112-44

L : 440 mm - 17 1/4"

NEW
NOUVEAU
NUEVO

NEW
NOUVEAU
NUEVO



Titanium



HF Monopolar Handles for Scissors Tips / Manches HF Monopolaires pour Embouts Ciseaux
Mangos HF Monopolares para Puntas de Tijeras

Patent
Breveté
Patentado

Reposable Curved Metzenbaum Scissors
Ciseaux Metzenbaum Courbes Réutilisables
Tijeras Metzenbaum Curvas Desechables



DC83110-12 *

Ø : 5 mm

Box of 10 tips

Boîte de 10 embouts

Caja de 10 puntas

Straight Shaft

Tube droit

Tubo recto



DC83110-36 *

L : 360 mm - 14 1/5"

DC83110-44 *

L : 440 mm - 17 1/3"

Ø 5 mm



Titanium^{line}



Robust Curved Scissors / Ciseaux Courbes Robustes / Tijeras Curvas Robustas

Ø 5 mm / Ø 7 mm

Very Strong Cutting Force
Pouvoir de Coupe Élevé
Fuerza de Corte muy Fuerte

Curved
Courbe
Curva

DC80132-25 **NEW NOUVEAU NUEVO**
L : 250 mm - 10"

DC80132-30
L : 300 mm - 11^{4/5}"

DC80132-36 **NEW NOUVEAU NUEVO**
L : 360 mm - 14^{1/5}"

DC80132-43 **NEW NOUVEAU NUEVO**
L : 430 mm - 17"

Ø 7 mm

Ø 5 mm

Strongly Curved
Très Courbes
Muy Curvas

DC80133-25 **NEW NOUVEAU NUEVO**
L : 250 mm - 10"

DC80133-30 **NEW NOUVEAU NUEVO**
L : 300 mm - 11^{4/5}"

DC80133-36 **NEW NOUVEAU NUEVO**
L : 360 mm - 14^{1/5}"

DC80133-43 **NEW NOUVEAU NUEVO**
L : 430 mm - 17"

MicroMICS Scissors / Ciseaux MicroMICS / Tijeras MicroMICS

YILMAZ

Ø 2 mm / Ø 2.5 mm

Only One Mobile Blade
Une Seule Lame Mobile
Sólo Una Hoja Móvil

NEW
NOUVEAU
NUEVO

Registered Design
Modèle déposé
Diseño registrado



45°



DC84116-26

WL: 90 mm - 3 1/2"
L : 260 mm - 10"

125°

DC84117-26

WL: 90 mm - 3 1/2"
L : 260 mm - 10"

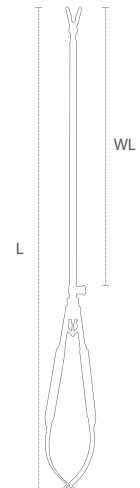

YILMAZ

METZENBAUM

NEW
NOUVEAU
NUEVO

Registered Design
Modèle déposé
Diseño registrado

Ø 3.5 mm



 DC84140-45

WL: 180 mm - 11"
L: 450 mm - 17⁴/₅"

Ø 5.0 mm



DC84141-45

WL: 180 mm - 11"
L: 450 mm - 17⁴/₅"



 2/5

Ø 5 mm

NEW
NOUVEAU
NUEVO

Registered Design
Modèle déposé
Diseño registrado

Curved
Courbe
Curva

Strongly Curved
Très Courbes
Muy Curvas



DC84101-35

WL: 180 mm - 7"
L: 350 mm - 13⁴/₅"



DC84101-41

WL: 240 mm - 9¹/₂"
L: 410 mm - 16"



DC84102-35

WL: 180 mm - 7"
L: 350 mm - 13⁴/₅"

DC84102-41

WL: 240 mm - 9¹/₂"
L: 410 mm - 16"

Transthoracic Scissors / Ciseaux Transthoraciques / Tijeras Transtorácicas

Curved Blades
Lames Courbes
Lamas Curvas



NEW
NOUVEAU
NUEVO

Curved Blades
Lames Courbes
Cuchillas Curvas



DC80462-22

L : 220 mm - 8³/₅"

DC80462-29

L : 290 mm - 11¹/₂"

NEW
NOUVEAU
NUEVO

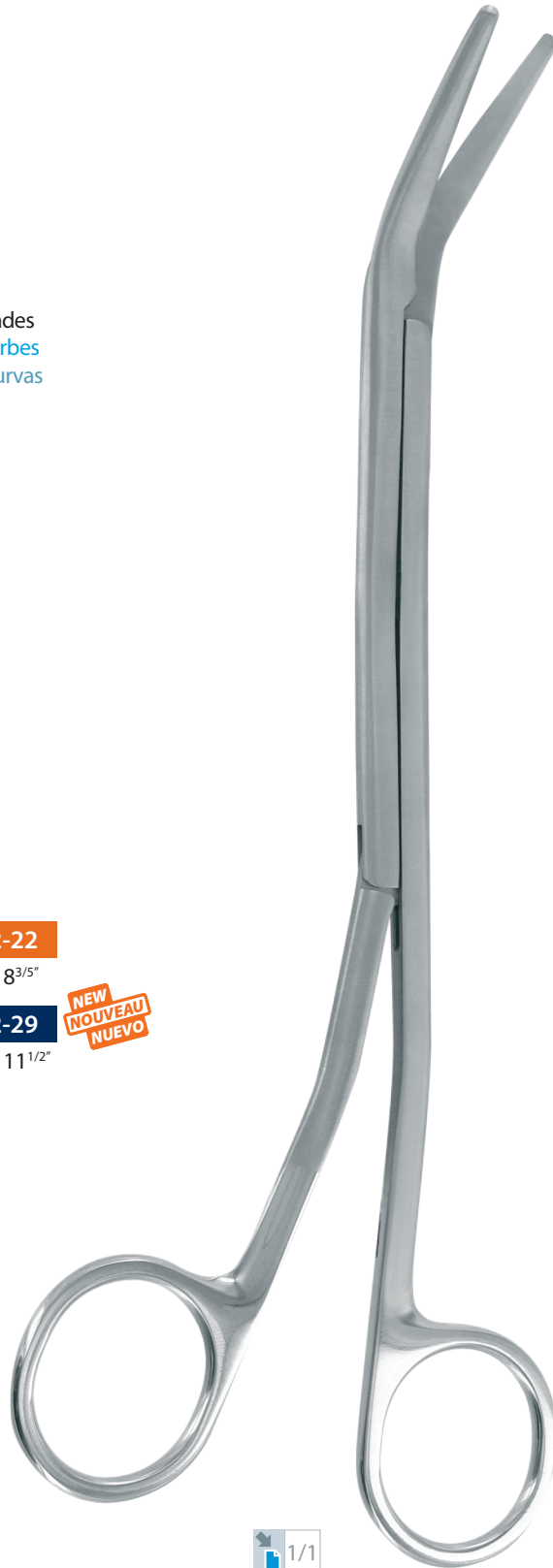

BOUCHOT RETRACTORS / ÉCARTEURS BOUCHOT / SEPARADORES BOUCHOT

Bouchot



P 47

RETRACTORS / ÉCARTEURS / SEPARADORS

Obadia



P 48

RING RETRACTORS / ÉCARTEURS CIRCULAIRES / SEPARADORES CIRCULAR

Obadia

C Ring Retractor/ Écarteur en C / C Separador

Ring Retractor/ Écarteur Circulaire / Separador Circular



P 49



P 50

RETRACTORS / ÉCARTEURS / SEPARADORES

Yan

Mini-Access

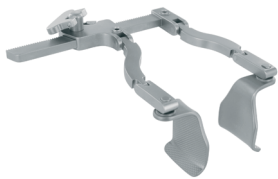

P 51 - 52

ThorAccess

Intercostal / Intercostal / Intercostal



P 53 - 54

ThorAccess

Sternal / Sternal / Esternal



P 55

Accessories / Accessoires / Accesorios



P 56 - 57

MIS

Double Hinged / Double Articulation / Doble Articulación

MIS Retractors / Écarteurs / Separadores



P 58



P 59

Mini Finochietto-Mathey



P 60

RETRACTORS / ÉCARTEURS / SEPARADORES

MIDAccess

Small Thoracotomy

Mini Sternotomy

Direct Vision



P 61



P 62



P 63



P 64

APPROXIMATOR / APPROXIMATEUR / APROXIMADORES

Yilmaz

Sarraj



P 65



P 65

RETRACTORS / ÉCARTEURS / SEPARADORES

Gossot



P 66

P 67

TROCARS / TROCARTS / TROCARES

Gossot

Trocars for Thoracoscopy / Trocarts pour Thoracoscopie / Trocares para Toracosopia



Magnetic Trocars
Trocarts magnétiques
Trocares magnéticos

P 68 - 71

HOOKS / CROCHETS / GANCHOS

Obadia

Hooks / Crochets / Ganchos



P 72

Yilmaz

Hooks / Crochets / Ganchos



P 73

Obadia

Double hooks / Double crochets / Doble ganchos



P 74

Bouchot

Reposable
Usage Court
Uso Corto

NEW
NOUVEAU
NUEVO

Registered Design
Modèle déposé
Diseño registrado



DC81050-00

Ø 36 mm



DC81050-01

Ø 40 mm



DC81050-02

Ø 44 mm



DC81050-03

Ø 48 mm



No Scale / Pas d'Échelle / Sin Escala

O600406

Recommended Sterilization Tray
Panier de Stérilisation Recommandé
Cesta de Esterilización Recomendada

3D Retractor / Écarteur 3D / Separador 3D

DC81115-00

Included

Incluses

Incluidas

DC81116-30 : 35 mm x 30 mm

DC81116-40 : 35 mm x 40 mm

DC81116-50 : 35 mm x 50 mm

DC81117-94

L: 94 mm

Flexible Additional Blades for DC81115-00

Valves Additionnelle Flexible pour DC81115-00

Válvulas Adicionales Flexibles para DC81115-00



Optional Blades for DC81115-00

Valves Optionnelles pour DC81115-00

Valvas Opcionales para DC81115-00



DC81118-50

40 mm x 50 mm

NEW
NOUVEAU
NUEVO



DC81118-60

40 mm x 60 mm

NEW
NOUVEAU
NUEVO



DC81118-70

40 mm x 70 mm

NEW
NOUVEAU
NUEVO

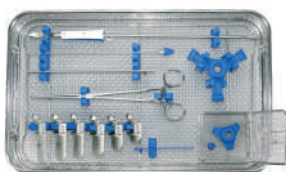

No Scale / Pas d'Échelle / Sin Escala

DC81914-00

Special Tray for Full Retractor System

Provided with Lid and Accessories, Instruments not Included

Panier Spécial pour le Système d'Écarteur Complet

Livré avec Couvercle et Accessoires, Instruments non Inclus

Cesto Especial para el Sistema Retractor Completo

Entregado con Tapa y Accesorios, Instrumentos no Incluidos

Obadia



Registered Design
Modèle déposé
Diseño registrado

Illustration Picture
Image d'illustration
Imagen de Ilustración

Forceps for DC81117-94

Pince pour DC81117-94

Pinza para DC81117-94

Forceps for Blades
Pince Pose Valves
Pinza para Colocar Valvas

1/4

DC81363-24

L: 240 mm - 9 1/2"

1/4

DC81364-36

L: 360 mm - 14 1/5"

3/4

"C-Ring" Retractors / Écarteurs en "C" / "C" Separadores

Obadia

Illustration Picture
Image d'illustration
Imagen de Ilustración

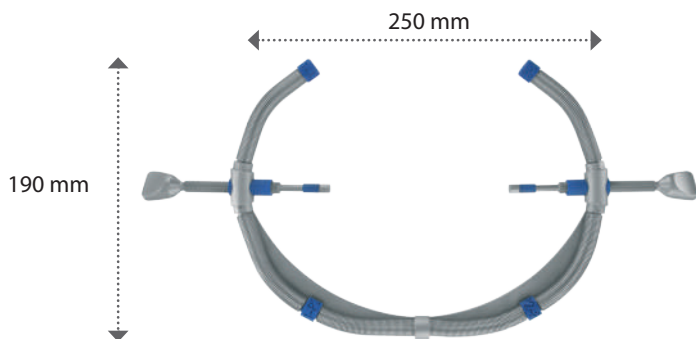

DC82152-99

c max with Blades DC82153-30 : 70 mm
c max avec Valves DC82153-30 : 70 mm
c max con Valvas DC82153-30 : 70 mm



DC82153-30

a : 70 mm - b : 30 mm

1 Pair of Blades - 1 Paire de Valves - 1 Pares de Valvas

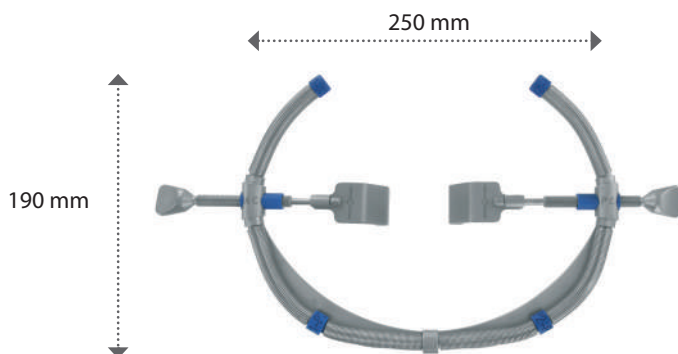

DC82152-00

c max : 100 mm



DC82151-20

DC82151-30

DC82151-40

Included 3 Pairs of Blades - 3 Paires de Valves Incluses - 3 Pares de Valvas Incluidas:

DC82151-20

+

DC82151-30

+

DC82151-40

a : 27 mm - b : 20 mm

a : 27 mm - b : 30 mm

a : 27 mm - b : 40 mm

Ring Retractors / Écarteurs Circulaires / Separadores Circular

Obadia



DC82150-00

Ø : 220 mm - 8^{2/3}" - c max : 85 mm

Included 3 Pairs of Blades - 3 Paires de Valves Incluses - 3 Pares de Valvas Incluidas:

DC82151-20

a : 27 mm - b : 20 mm

+

DC82151-30

a : 27 mm - b : 30 mm

+

DC82151-40

a : 27 mm - b : 40 mm



DC82150-01

With Luer Lock - Avec Raccord Luer Lock - Con Conexión Luer Lock

Included the same 3 Pairs of Blades

3 mêmes Paires de Valves Incluses

3 mismos Pares de Valvas Incluidas

Also Compatible with this Version of Obadia Ring Retractor
Également Compatible avec cette Version de l'Écarteur Circulaire Obadia
También es Compatible con esta Versión del Separador Circular Obadia



DC82153-30

a : 70 mm - b : 30 mm

1 Pair of Blades - 1 Paire de Valves - 1 Pares de Valvas

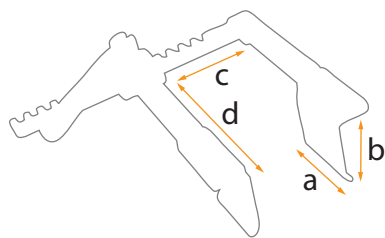

Yan Mini-Access Retractor / Écarteur Mini-Access Yan / Separador Mini-Access Yan

DC82160-00

c : 108 mm - d : 96 mm

Included - **Inclus - Incluidos**

DC82161-30 (pair / **paire / par**)

DC82161-40 (pair / **paire / par**)

DC82161-50 (pair / **paire / par**)

Prof. Yan Blades

Valves Pr Yan

Valvas Pr Yan

DC82161-30

a : 36 mm - b : 30 mm



DC82161-40

a : 36 mm - b : 40 mm

DC82161-50

a : 36 mm - b : 50 mm

DC82161-60

a : 36 mm - b : 60 mm

DC82161-70

a : 36 mm - b : 70 mm

NEW
NOUVEAU
NUEVO

NEW
NOUVEAU
NUEVO



DC82160-00

c : 108 mm - d : 96 mm

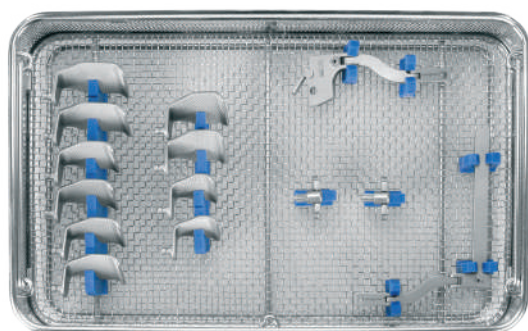

DC82169-00

NEW
NOUVEAU
NUEVO

Special Tray for Full Retractor System

Provided with Lid and Accessories, Instruments not Included

Panier Spécial pour le Système d'Écarteur Complet

Livré avec Couvercle et Accessoires, Instruments non Inclus

Cesto Especial para el Sistema Retractor Completo

Entregado con Tapa y Accesorios, Instrumentos no Incluidos

No Scale / Pas d'Échelle / Sin Escala

Products presented on this page are **NOT** compatible with ThorAccess retractors
Les produits de cette page ne sont **PAS** compatibles avec les écarteurs ThorAccess
Los productos de esta página **NO** son compatibles con separadores ThorAccess

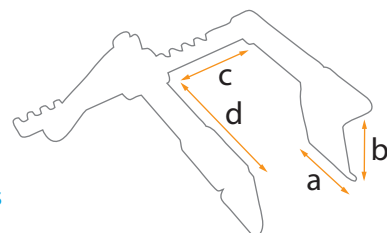

Yan Mini-Access Retractor / Écarteur Mini-Access Yan / Separador Mini-Access Yan

Yan

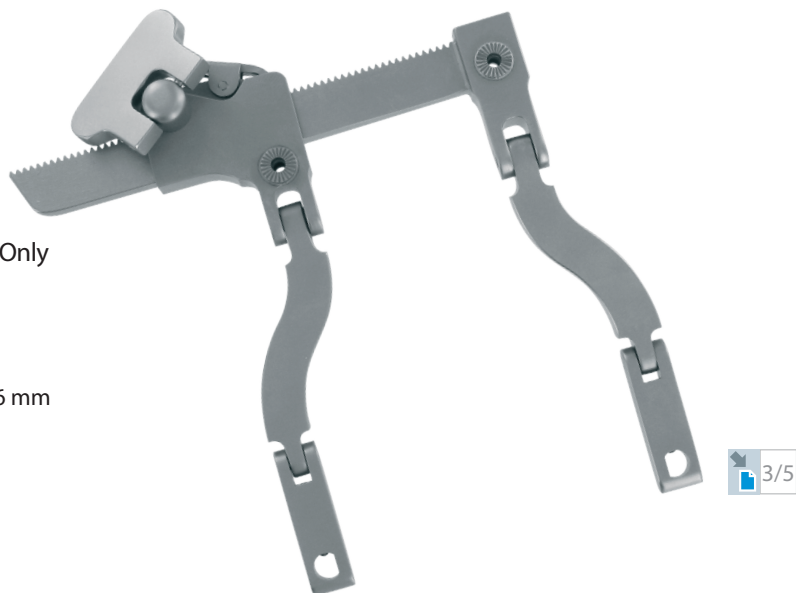

Retractor Frame Only
Cadre Seul
Base Solo

DC82160-99

c : 108 mm - d : 96 mm



Standard Blades
Valves Standards
Valvas Estándar



DC82162-30

a : 36 mm - b : 30 mm



DC82162-40

a : 36 mm - b : 40 mm

DC82162-50

a : 36 mm - b : 50 mm

Dr. Yilmaz Blades
Valves Dr Yilmaz
Valvas Dr Yilmaz



DC82163-30

a : 15 mm - b : 30 mm



DC82163-40

a : 15 mm - b : 40 mm

DC82163-50

a : 15 mm - b : 50 mm



DC82164-30

a : 20 mm - b : 30 mm



DC82164-40

a : 20 mm - b : 40 mm

DC82164-50

a : 20 mm - b : 50 mm

Key Handle
Poignée
Manejar

DC82165-35

L : 35 mm

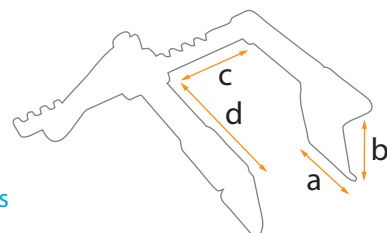

Products presented on this page are **NOT** compatible with ThorAccess retractors
Les produits de cette page ne sont **PAS** compatibles avec les écarteurs ThorAccess
Los productos de esta página **NO** son compatibles con separadores ThorAccess

DC82100-00

c : 160 mm - d : 96 mm

Included - Inklus - Incluidos

DC82102-30 (pair / paire / par)

DC82102-40 (pair / paire / par)

DC82102-50 (pair / paire / par)

DC82120-30

DC82121-16

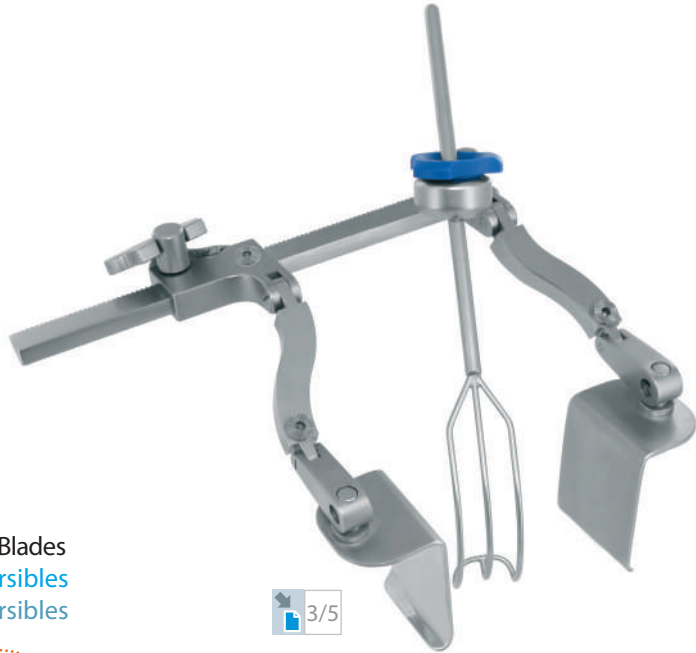

3/5

Swivel Standard Blades
Valves Standard Rotatives
Valvas Rotativas Estándar



Up & Down Blades
Valves Réversibles
Valvas Reversibles



Retractor Frame Only
Cadre Seul
Base Solo

DC82100-99

c : 160 mm - d : 96 mm

DC82101-30

a : 28 mm - b : 30 mm

DC82101-40

a : 28 mm - b : 40 mm

DC82101-50

a : 28 mm - b : 50 mm

DC82102-30

a : 36 mm - b : 30 mm

 **DC82102-40**

a : 36 mm - b : 40 mm

DC82102-50

a : 36 mm - b : 50 mm

DC82103-30

a : 44 mm - b : 30 mm

DC82103-40

a : 44 mm - b : 40 mm

DC82103-50

a : 44 mm - b : 50 mm

DC82111-30

a : 28 mm - b : 30 mm

DC82111-40

a : 28 mm - b : 40 mm

DC82111-50

a : 28 mm - b : 50 mm

DC82112-30

a : 36 mm - b : 30 mm

 **DC82112-40**

a : 36 mm - b : 40 mm

DC82112-50

a : 36 mm - b : 50 mm

DC82113-30

a : 44 mm - b : 30 mm

DC82113-40

a : 44 mm - b : 40 mm

DC82113-50

a : 44 mm - b : 50 mm

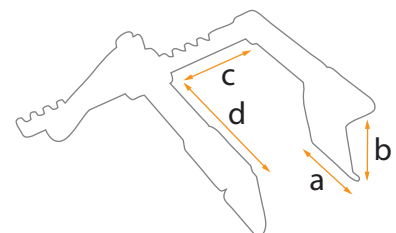

Intercostal ThorAccess Retractors / Écarteurs ThorAccess Intercostaux / Separadores ThorAccess Intercostal

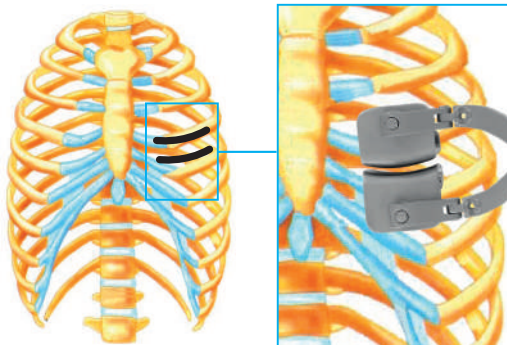

ThorAccess Retractor with Anatomical Blades
Écarteur ThorAccess avec Valves Anatomiques
ThorAccess Separador con Valvas Anatómicas

Reversible ThorAccess Retractor with Anatomical Blades
Écarteur ThorAccess Réversible avec Valves Anatomiques
ThorAccess Reversible Separador con Valvas Anatómicas

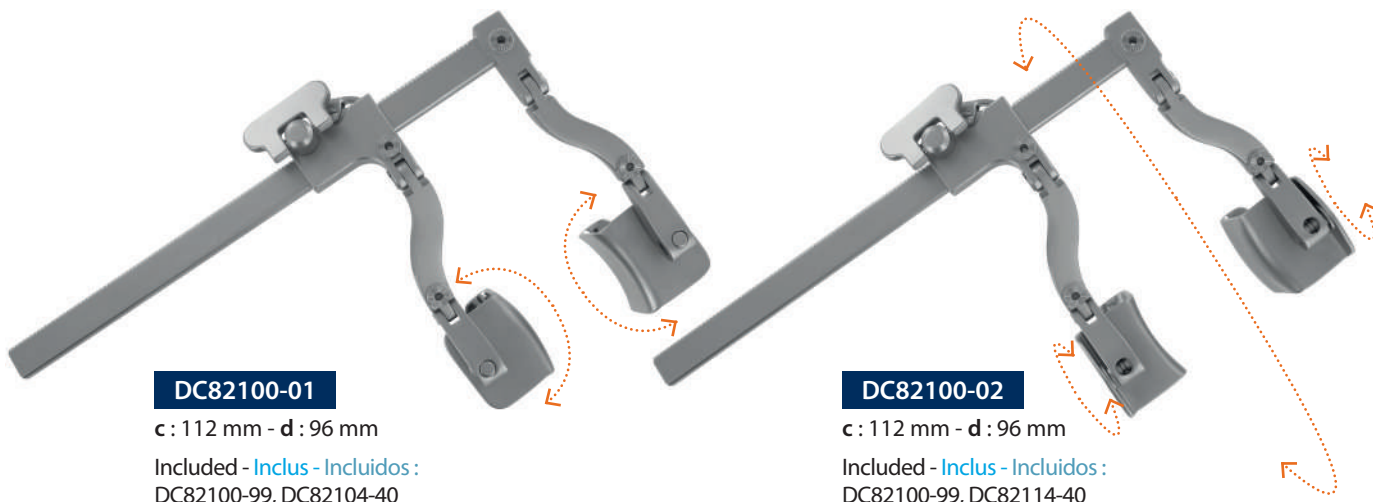

DC82100-01

c : 112 mm - d : 96 mm

Included - Inklus - Incluidos :
DC82100-99, DC82104-40

DC82100-02

c : 112 mm - d : 96 mm

Included - Inklus - Incluidos :
DC82100-99, DC82114-40

Swivel Standard Blades
Valves Standard Rotatives
Valvas Rotativas Estándar



DC82104-40

a : 36 mm - b : 40 mm

Up & Down Blades
Valves Réversibles
Valvas Reversibles



DC82114-40

a : 36 mm - b : 40 mm

Up & Down Blades With Light
Valves Lumineuses et Rotatives
Valvas Luminosas y reversibles



DC82115-40

a : 36 mm - b : 40 mm

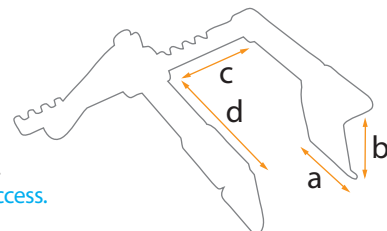

All products on this page are compatible with each other - They are not compatible with SternAccess.
Tous les produits de cette page sont compatibles entre eux - Non compatibles avec la version SternAccess.
Todos los productos de esta página son compatibles entre sí - No son compatibles con SternAccess.

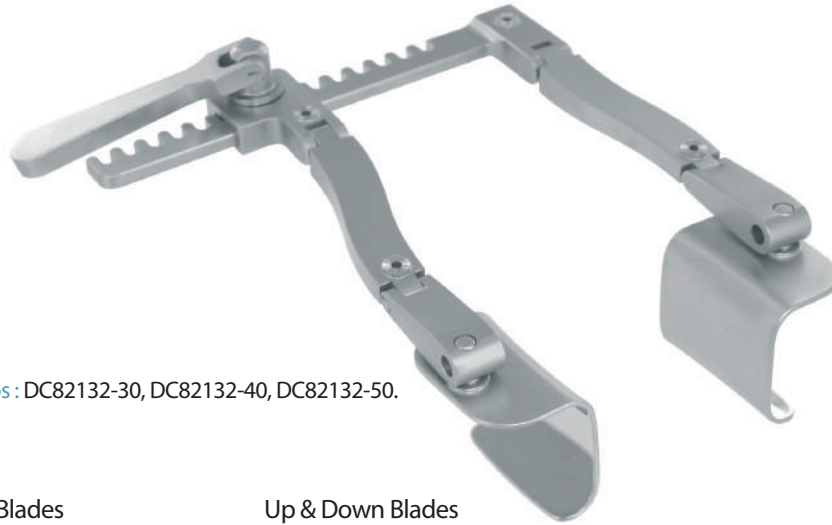

DC82130-00

c : 115 mm - d : 130 mm

Included - Inklus - Incluidos : DC82132-30, DC82132-40, DC82132-50.

Swivel Standard Blades
Valves Standard Rotatives
Valvas Rotativas Estándar



DC82131-30

a : 36 mm - b : 30 mm

DC82131-40

a : 36 mm - b : 40 mm

DC82131-50

a : 36 mm - b : 50 mm

DC82132-30

a : 50 mm - b : 30 mm

 **DC82132-40**

a : 50 mm - b : 40 mm

DC82132-50

a : 50 mm - b : 50 mm

DC82133-30

a : 64 mm - b : 30 mm

DC82133-40

a : 64 mm - b : 40 mm

DC82133-50

a : 64 mm - b : 50 mm

Up & Down Blades
Valves Réversibles
Valvas Reversibles

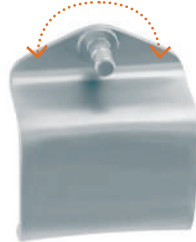

DC82141-30

a : 36 mm - b : 30 mm

DC82141-40

a : 36 mm - b : 40 mm

DC82141-50

a : 36 mm - b : 50 mm

DC82142-30

a : 50 mm - b : 30 mm

 **DC82142-40**

a : 50 mm - b : 40 mm

DC82142-50

a : 50 mm - b : 50 mm

DC82143-30

a : 64 mm - b : 30 mm

DC82143-40

a : 64 mm - b : 40 mm

DC82143-50

a : 64 mm - b : 50 mm

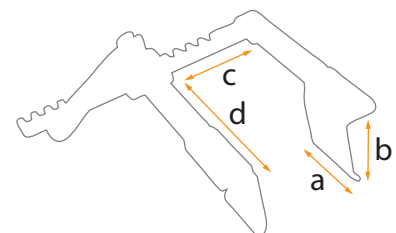

Connectors - Fixations - Fijaciones



DC82120-30

3D Arm - Bras 3D - Brazo 3D
L : 30 mm



DC82120-50

3D Arm - Bras 3D - Brazo 3D
L : 50 mm



DC82120-90

3D Arm - Bras 3D - Brazo 3D
L : 30 mm - 90°



DC82120-95

Additional 3D Arm - Bras 3D Additionnel - Brazo 3D Adicional
L : 90 mm



DC82125-05

Attachment bracket Extension - Bras de Fixation - Brazo de Fijación
L : 115 mm

Accessories - Accessoires - Accesorios



DC82121-16

Wire Hook - Valve en Fil - Valva en Hilo
L : 160 mm - a : 19 mm - b : 28 mm

DC82121-20

Wire Hook - Valve en Fil - Valva en Hilo
L : 200 mm - a : 28 mm - b : 38 mm



DC82124-30

Additional Blade - Valve Additionnelle - Valva Adicional
L : 155 mm - a : 35 mm - b : 30 mm

* Compatible with / Compatibles avec / Compatibles con :

DC82100-00, DC82100-01, DC82100-02, DC82100-99, DC82130-00, DC82160-00, DC82160-99

Malleable Spatula - Spatule Malléable - Espátula Maleable



DC82122-22

L : 220 mm - a : 15 mm - b : 65 mm



DC82122-24

L : 240 mm - a : 20 mm - b : 80 mm



DC82122-26

L : 260 mm - a : 25 mm - b : 95 mm

* Compatible with / Compatibles avec / Compatibles con :
DC82100-00, DC82100-01, DC82100-02, DC82100-99, DC82130-00, DC82160-00, DC82160-99

Double Hinged Retractor / Écarteur Double Articulation / Separador de Doble Articulación

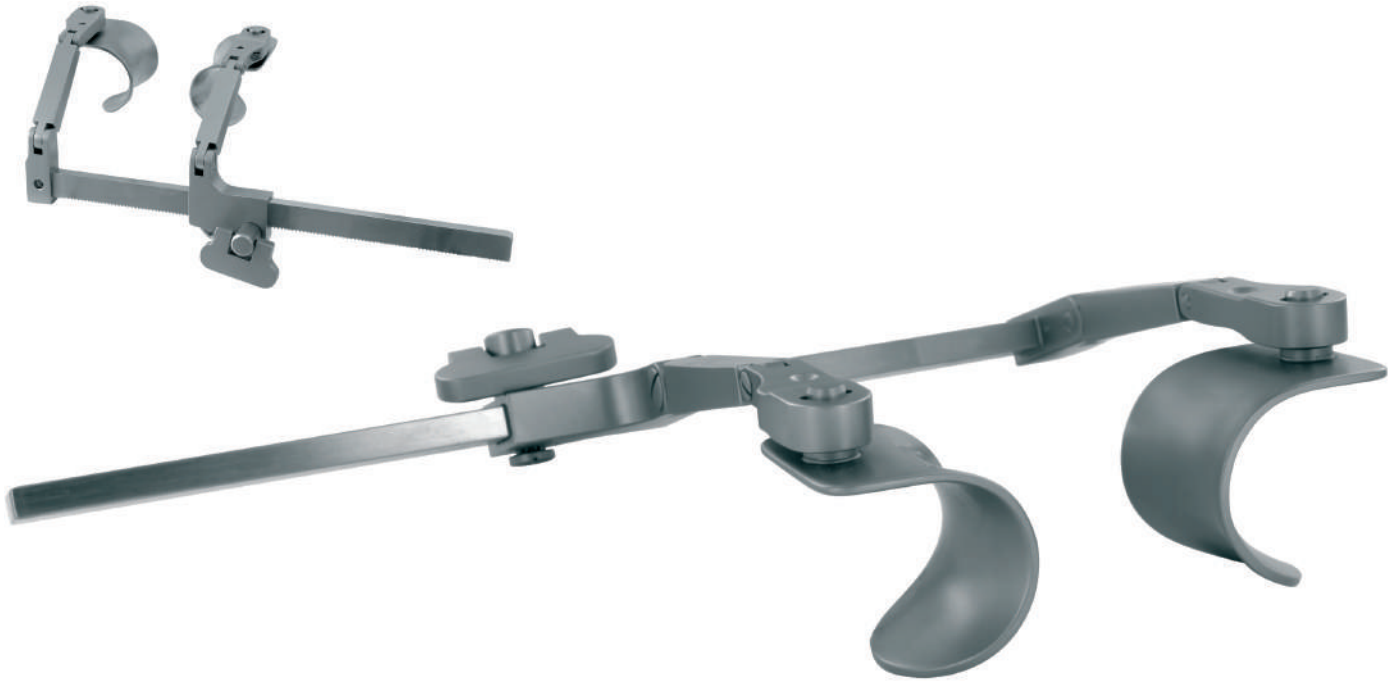

DC32300-00

c max : 130 mm - d : 100 mm

Included 3 Pairs of Blades - 3 Paires de Valves Incluses - 3 Pares de Valvas Incluidas

a : 35 mm - b : 35 mm

a : 35 mm - b : 50 mm

a : 35 mm - b : 63 mm

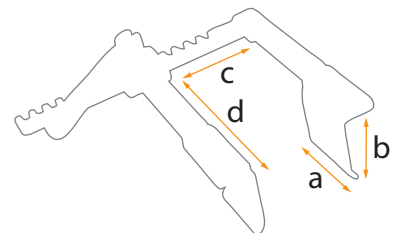

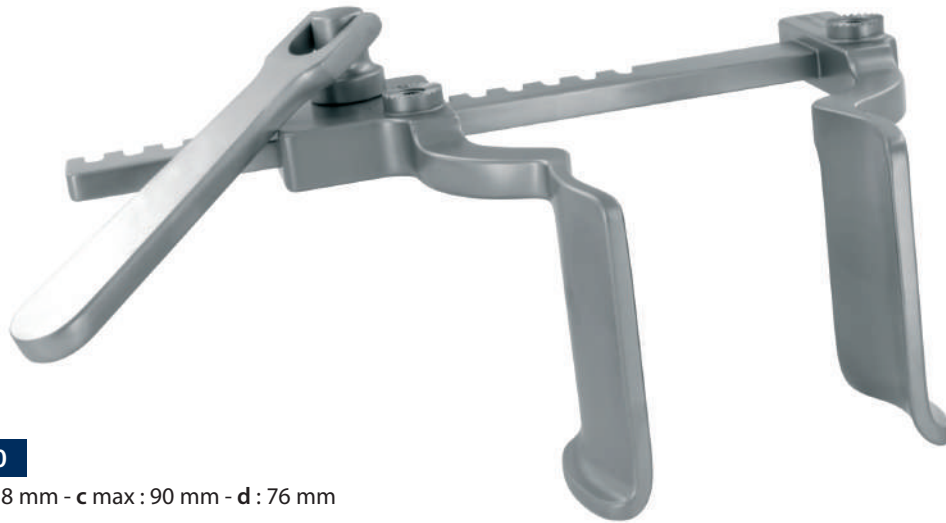

DC81000-00

a : 37 mm - b : 58 mm - c max : 90 mm - d : 76 mm



DC32900-00

Fixation System with Wire Hook for MIS Retractor

Valve en Fil et Système de Fixation pour Écarteur de Chirurgie Mini-Invasive

Valva en Hilo y Sistema de Fijación para Separador de Cirugía Mínimamente-Invasiva

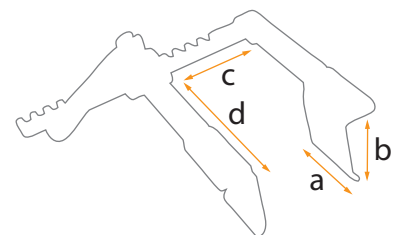

FINOCHIETTO-MATHEY

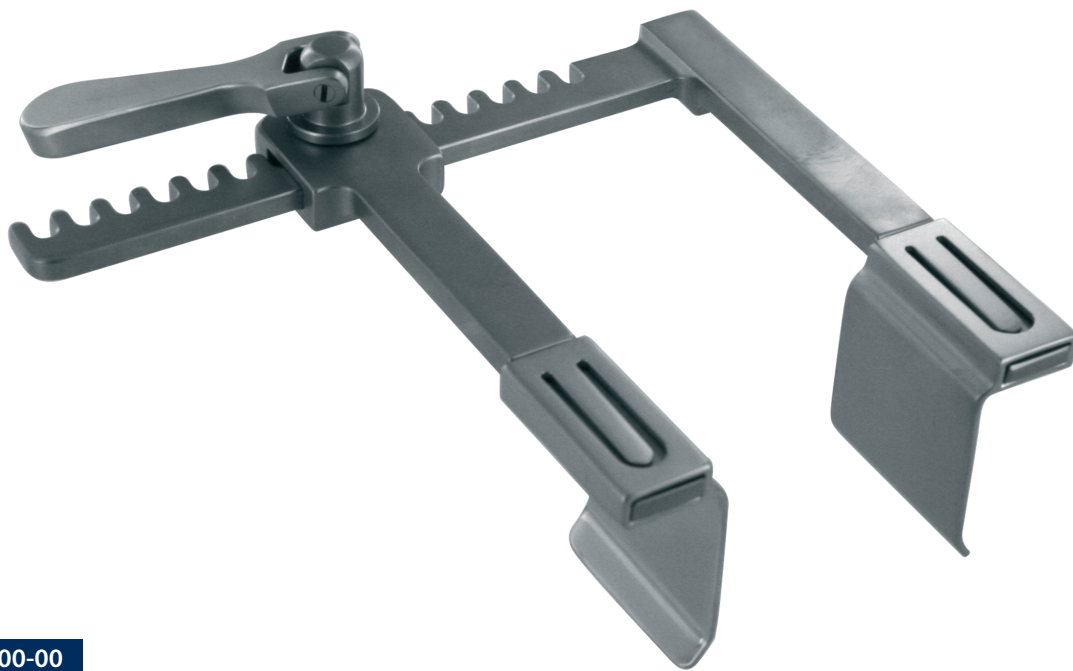

DC30600-00

c max : 130 mm - d : 105 mm

Included 3 Pairs of Blades - 3 Paires de Valves Incluses - 3 Pares de Valvas Incluidas

a : 40 mm - b : 25 mm

a : 40 mm - b : 35 mm

a : 40 mm - b : 40 mm

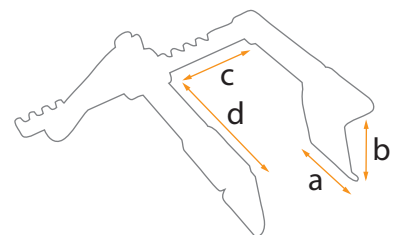

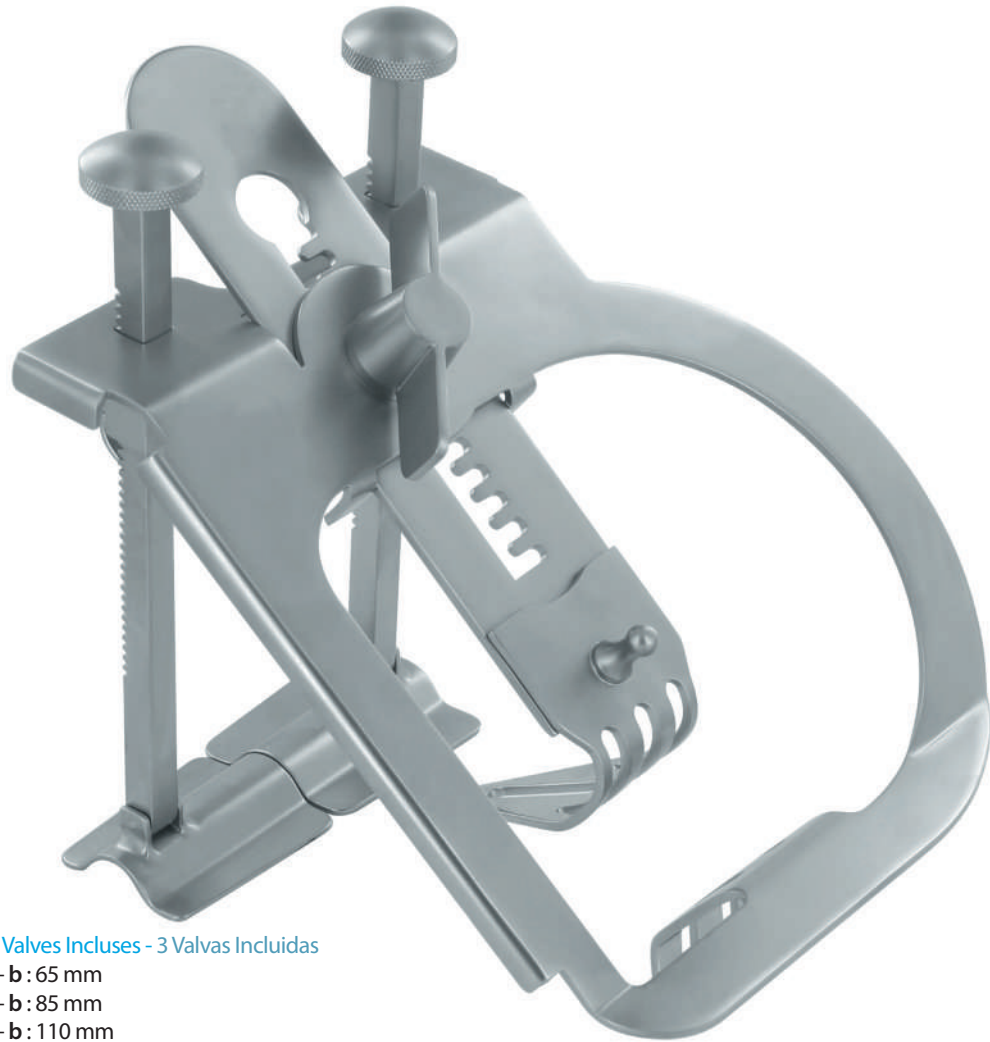

DC82200-00

Included 3 Blades - 3 Valves Incluses - 3 Valvas Incluidas

- a : 40 mm - b : 65 mm
- a : 40 mm - b : 85 mm
- a : 40 mm - b : 110 mm

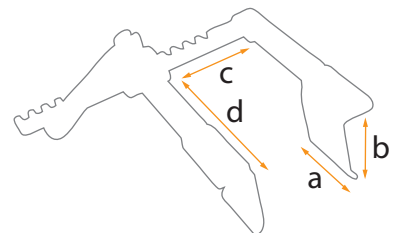

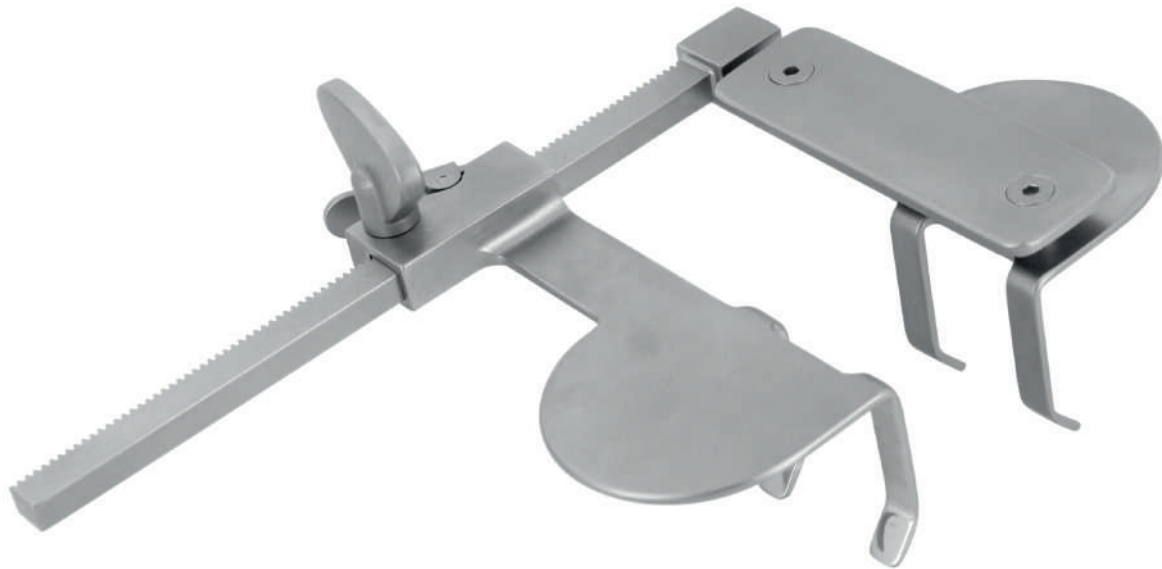

DC82210-00

a : 34 mm - b : 34 mm - c max : 110 mm - d : 82 mm

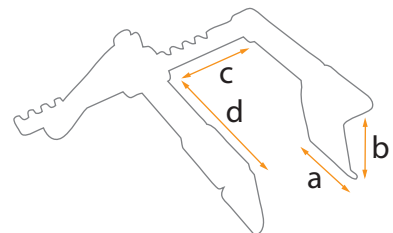

Mini-Sternotomy Retractor / Écarteur pour Mini-Sternotomie / Separador para Mini-Esternotomía

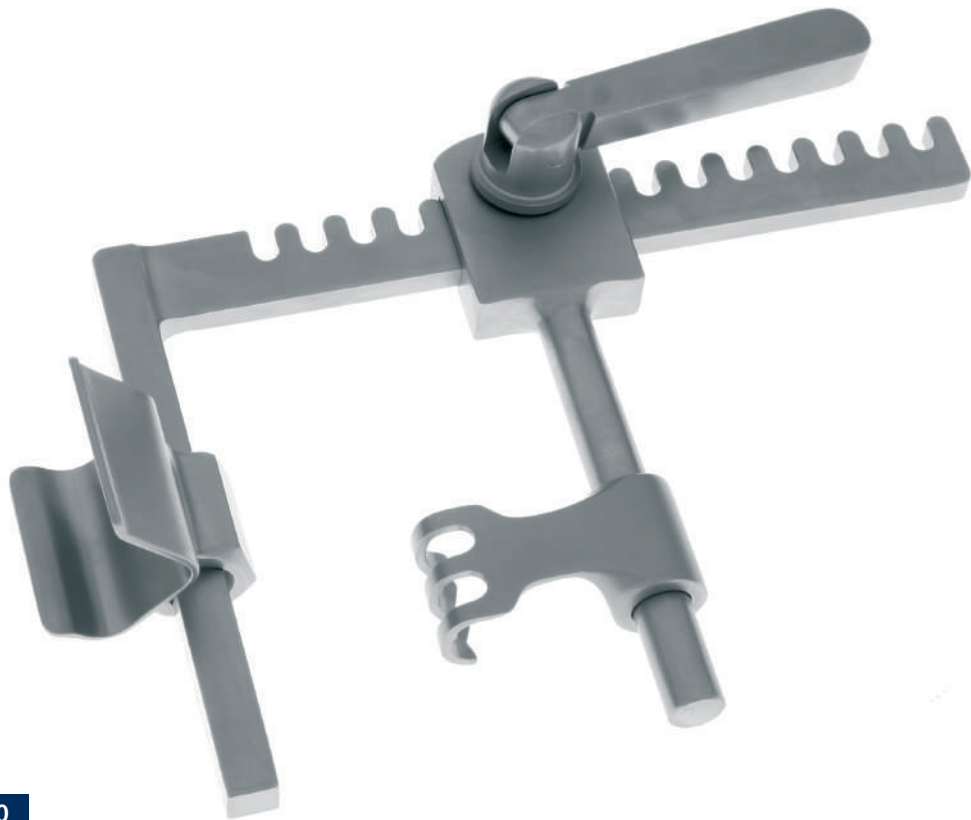

DC30300-00

a : 30 mm - b : 20 mm - c max : 120 mm - d : 75 mm

Included - Inklus - Incluidos : DC30222-38 - Hook - Crochet - Gancho - L : 38 mm
DC30223-43 - Hook - Crochet - Gancho - L : 43 mm
DC30212-20 - "U" shape Blade - Valve "U" - Válvula "U" - a : 38 mm

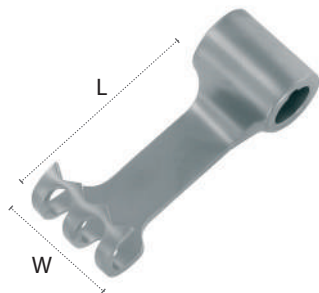

DC30222-38

L : 38 mm - W : 20 mm

DC30223-43

L : 43 mm - W : 20 mm



"U" Shape
Valve "U"
Válvula "U"

DC30212-20

a : 38 mm

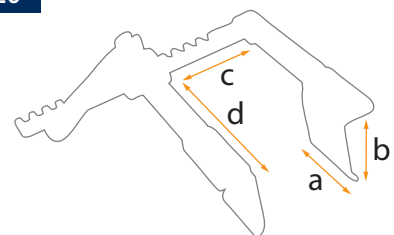

Direct Vision Intercostal Retractor / Écarteur Intercostal Direct Vision / Separador Intercostal Direct Visión

Soft Tissue Malleable Blades
Lames Malléables pour Tissus Mous
Hojas Maleables para Tejidos Blandos

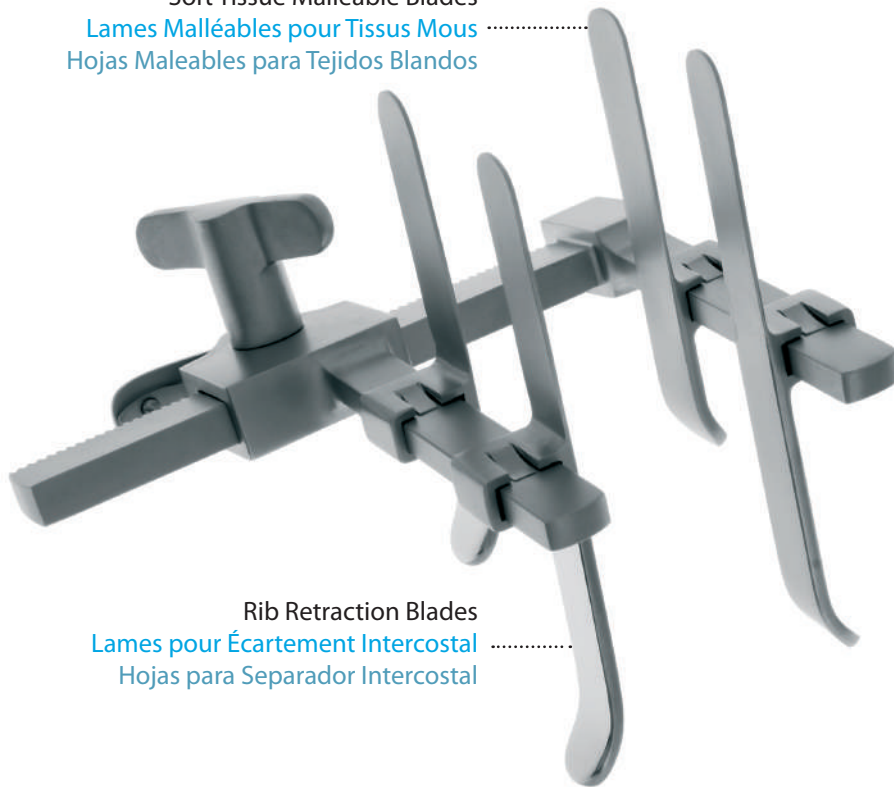

Rib Retraction Blades
Lames pour Écartement Intercostal
Hojas para Separador Intercostal

DC30800-00

a : 11 mm - c max : 90 mm - d : 80 mm

Included - Inklus - Incluidos : DC30810-25 (pair / paire / pares) - a : 11 mm - b : 25 mm
DC30813-55 (pair / paire / pares) - a : 11 mm - b : 55 mm



DC30810-25

a : 11 mm - b : 25 mm



DC30811-35

a : 11 mm - b : 35 mm



DC30812-45

a : 11 mm - b : 45 mm



DC30813-55

a : 11 mm - b : 55 mm

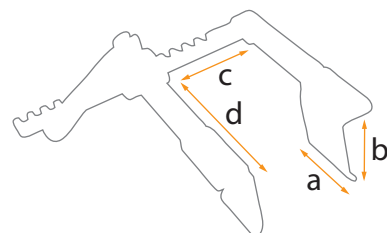

NEW
NOUVEAU
NUEVO

Yilmaz

Sarraj

Registered Design
Modèle déposé
Diseño registrado



DC81010-00
L : 220 mm - 8 1/5"



DC81020-00
L : 210 mm - 8"

Gossot

NEW
NOUVEAU
NUEVO

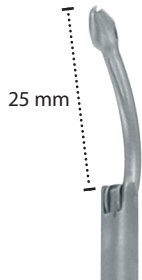

 **DC82940-38**
L : 380 mm - 15"

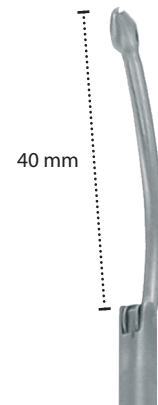

DC82940-40
L : 400 mm - 16"

Gossot



DC82950-38

L : 380 mm - 15" - Ø : 10 mm

Gossot

Reusable / Réutilisable / Reutilizable

Serrated Tube - Tube Strié - Tubo Acanalado



DC82960-07

L: 70 mm - 2^{3/4}" - Ø: 3,5 mm

DC82960-10

L: 100 mm - 4" - Ø: 3,5 mm

DC82961-07

L: 70 mm - 2^{3/4}" - Ø: 5 mm

DC82961-10

L: 100 mm - 4" - Ø: 5 mm

DC82962-07

L: 70 mm - 2^{3/4}" - Ø: 10 mm

DC82962-10

L: 100 mm - 4" - Ø: 10 mm



DC82963-07

L: 70 mm - 2^{3/4}" - Ø: 12 mm

DC82963-10

L: 100 mm - 4" - Ø: 12 mm

DC82966-07

L: 70 mm - 2^{3/4}" - Ø: 6 mm



DC82966-10

L: 100 mm - 4" - Ø: 6 mm



DC82966 Compatible with Robust 6 mm Jaws Needle Holder
DC82966 Compatible avec Porte Aiguille Robuses Mors 6 mm
DC82966 Compatible sin Portaaguja Robusto Serradas de 6 mm

Threaded Tube - Tube Fileté - Tubo Roscado



DC82964-07

L: 70 mm - 2^{3/4}" - Ø: 10 mm

DC82964-10

L: 100 mm - 4" - Ø: 10 mm

Gossot

Reusable / Réutilisable / Reutilizable

Flexible - Flexible - Flexible



DC82965-70

L : 70 mm - 2^{3/4}" - Ø : 5 mm

Smooth Tube - Tube Lisse - Tubo Liso



DC82970-07

L : 70 mm - 2^{3/4}" - Ø : 16 x 25 mm

DC82970-10

L : 100 mm - 4" - Ø : 16 x 25 mm

Disposable / Usage Unique / Desechable

Blood Deflecting Trocar - Trocart Anti-Goutte - Trócar Deflector de Sangre



Registered Design
Modèle déposé
Diseño registrado



E229121 *

L : 70 mm - 2^{3/4}" - Ø : 12 mm

For Ø 10mm Endoscope

Pour Endoscope Ø 10 mm

Para endoscopio de Ø 10 mm

Gossot

Magnetic Trocars / Trocarts Magnétiques / Trocares Magnéticos

Serrated Tube - Tube Strié - Tubo Acanalado



DC82980-07

L: 70 mm - 2^{3/4}" - Ø: 3.5 mm

NEW
NOUVEAU
NUEVO

DC82981-07

L: 70 mm - 2^{3/4}" - Ø: 5 mm

DC82981-10

L: 100 mm - 4" - Ø: 5 mm

DC82982-07

L: 70 mm - 2^{3/4}" - Ø: 10 mm



DC82982-10

L: 100 mm - 4" - Ø: 10 mm

DC82983-07

L: 70 mm - 2^{3/4}" - Ø: 12 mm

DC82983-10

L: 100 mm - 4" - Ø: 12 mm

DC82984-07

L: 70 mm - 2^{3/4}" - Ø: 6 mm

NEW
NOUVEAU
NUEVO

DC82984-10

L: 100 mm - 4" - Ø: 6 mm

NEW
NOUVEAU
NUEVO

DC82984 Compatible with Robust 6 mm Jaws Needle Holder
DC82984 Compatible avec Porte Aiguille Robuses Mors 6 mm
DC82984 Compatible sin Portaagujas Robusto Serradas de 6 mm

Disposable / Usage Unique / Uso único

NEW
NOUVEAU
NUEVO



E229006 *

L: 70 mm - 2^{3/4"} - Ø: 6 mm



E229011 *

L: 70 mm - 2^{3/4"} - Ø: 11 mm

E229013 *

L: 70 mm - 2^{3/4"} - Ø: 13 mm

E229015 *

L: 70 mm - 2^{3/4"} - Ø: 15 mm

Adjustable Length
Longueur Réglable
Longitud ajustable

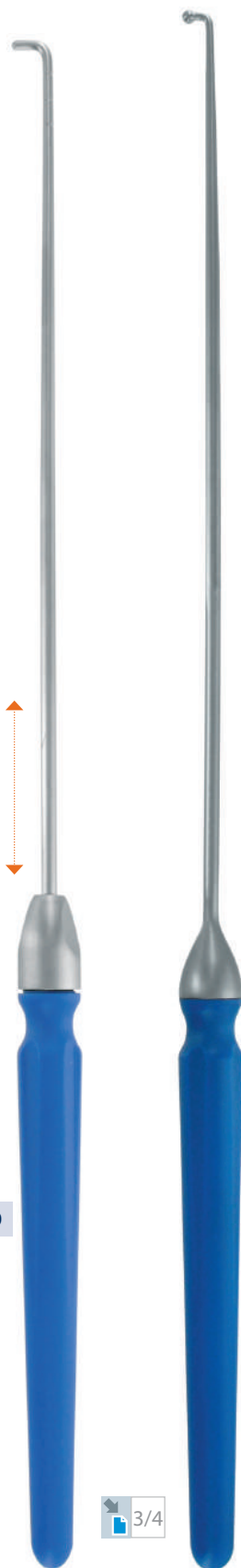

DC81301-00

DC81302-30



Obadia

Adjustable Length - Longueur Réglable - Longitud Ajustable



DC81301-00

L mini : 290 mm - 11^{2/5}" - L maxi : 360 mm - 14^{1/5}"

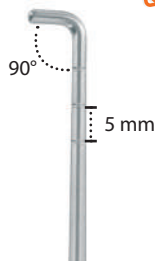

Adjustable Length - Longueur Réglable - Longitud Ajustable

DC81301-01

L mini : 200 mm - 7^{4/5}" - L maxi : 270 mm - 10^{3/5}"

Fixed Length - Longueur Fixe - Longitud Fija

DC81301-30

L : 300 mm - 11^{4/5}"

Adjustable Length - Longueur Réglable - Longitud Ajustable

DC81304-00

L mini : 290 mm - 11^{2/5}" - L maxi : 360 mm - 14^{1/5}"

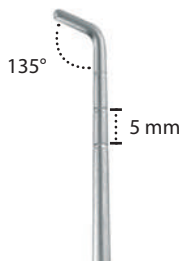

Fixed Length - Longueur Fixe - Longitud Fija

DC81304-30

L : 300 mm - 11^{4/5}"

With Ball Tip - À Embout Sphérique - Con Punta Esférica

Adjustable Length - Longueur Réglable - Longitud Ajustable

DC81302-00

L mini : 290 mm - 11^{2/5}" - L maxi : 360 mm - 14^{1/5}"

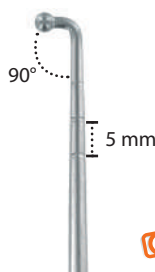

Fixed Length - Longueur Fixe - Longitud Fija



DC81302-30

L : 300 mm - 11^{4/5}"

With Sabot - À Sabot - Con Retorno

Adjustable Length - Longueur Réglable - Longitud Ajustable

DC81307-00

L mini : 290 mm - 11^{2/5}" - L maxi : 360 mm - 14^{1/5}"

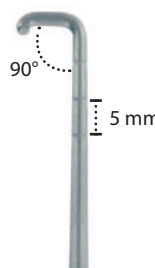

Fixed Length - Longueur Fixe - Longitud Fija

DC81307-30

L : 300 mm - 11^{4/5}"

Yilmaz



Fixed Length
Longueur Fixe
Longitud Fija

Ø : 0.5 mm



 DC81305-21

L : 210 mm - 8^{1/5}"

DC81305-30

L : 300 mm - 11^{4/5}"



Obadia



With Sliding Handle
Avec Manche Coulissant
Con Mango Corredero



DC81303-33

L : 330 mm - 13"



Clamp Chapter / Chapitre Clamps / Capitulo Pinzas

GRASPING FORCEPS / PINCES À PRÉHENSION / PINZAS DE AGARRE



MICROMICS GRASPING FORCEPS / PINCES À PRÉHENSION MICROMICS / PINZAS DE AGARRE MICROMICS

Ø 3.5 mm / Ø 5 mm



TRANSTHORACIC CLAMPS / PINCES À PRÉHENSION / PINZAS DE AGARRE

DeBakey

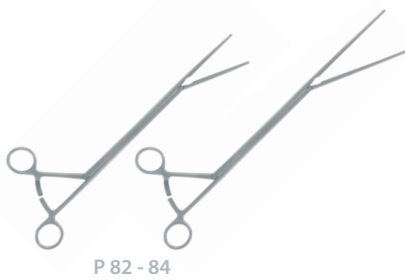

Ø 3 mm



Only One Mobile Jaw
Un Seul Mors Mobile
Sólo Una Boca Móvil

Registered Design
Modèle déposé
Diseño registrado

Straight
Droite
Recta



DC83216-36

L : 360 mm - 14 1/5"

DC83216-44

L : 440 mm - 17 1/3"

NEW
NOUVEAU
NUEVO

Progressive Locking System
Crémaillère Progressive
Cremallera Progressiva

Titanium *line*

Ø 3.5 mm



Straight
Droite
Recta

3.5 mm



20 mm

DC80242-40

L : 400 mm - 15 3/4"



Grasping Fenestrated Forceps / Pinces à Préhension Fenêtrées / Pinzas de Agarre Fenestradas

Registered Design
Modèle déposé
Diseño registrado

Ø 5 mm

To be Used with
Flexible Trocar DC82965-70
À Utiliser avec un
Trocart Flexible DC82965-70
Usar con un
Trocar Flexible DC82965-70

Straight
Droite
Recta

Curved Shaft
Tube Courbe
Tubo curvado

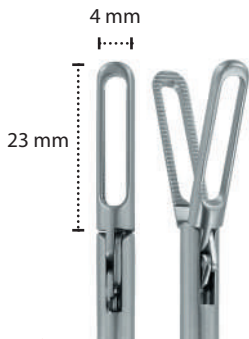

DC83213-36

L : 360 mm - 14 1/5"

DC83213-44

L : 440 mm - 17 1/3"

Progressive Locking System
Crémaillère Progressive
Cremallera Progressiva

DC83221-44

L : 440 mm - 17 1/3"

Without Locking System
Sans Crémaillère
Sin Cremallera

DC83213-36WR

L : 360 mm - 14 1/5"

DC83213-44WR

L : 440 mm - 17 1/3"

NEW
NOUVEAU
NUEVO

NEW
NOUVEAU
NUEVO

NEW
NOUVEAU
NUEVO

Titanium *line*



Lymph Node Forceps / Pincas à Ganglions / Pinzas para Ganglio

Registered Design
Modèle déposé
Diseño registrado

Gossot
Ø 5 mm

Straight
Droite
Recta



DC83210-36

L : 360 mm - 14 1/5"

DC83210-44

L : 440 mm - 17 1/3"

Straight
Droite
Recta

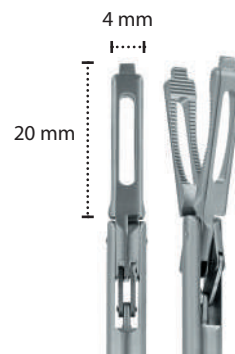

DC83211-36

L : 360 mm - 14 1/5"

DC83211-44

L : 440 mm - 17 1/3"



Progressive Locking System
Crémaillère Progressive
Cremallera Progressiva

Titanium

Yilmaz

NEW
NOUVEAU
NUEVO

Registered Design
Modèle déposé
Diseño registrado

Straight
Droite
Recta

Ø 3.5 mm

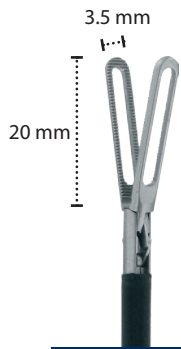

DC84242-45

WL: 280 mm - 11"
L : 450 mm - 17^{4/5}"

Straight
Droite
Recta

Ø 5.0 mm

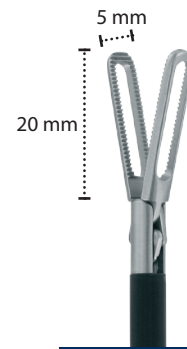

DC84243-45

WL: 280 mm - 11"
L : 450 mm - 17^{4/5}"

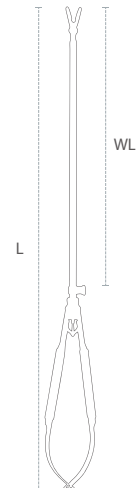

CHITWOOD DEBAKEY

1x2 DeBakey

65mm Jaws Length
Longueur Mors 65 mm
Longitud Bocas 65 mm

2x3 DeBakey



DC80993-26

L : 265 mm - 10 1/2"

DC80993-32

L : 320 mm - 12 3/4"



DC80993-36

L : 360 mm - 14 1/4"



DC80994-26

L : 265 mm - 10 1/2"

DC80994-32

L : 320 mm - 12 3/4"

DC80994-36

L : 360 mm - 14 1/4"

45° Angled Shanks
Branches Coudées 45°
Bocas Anguladas 45°

DC80993-26C

L : 260 mm - 10 1/2"

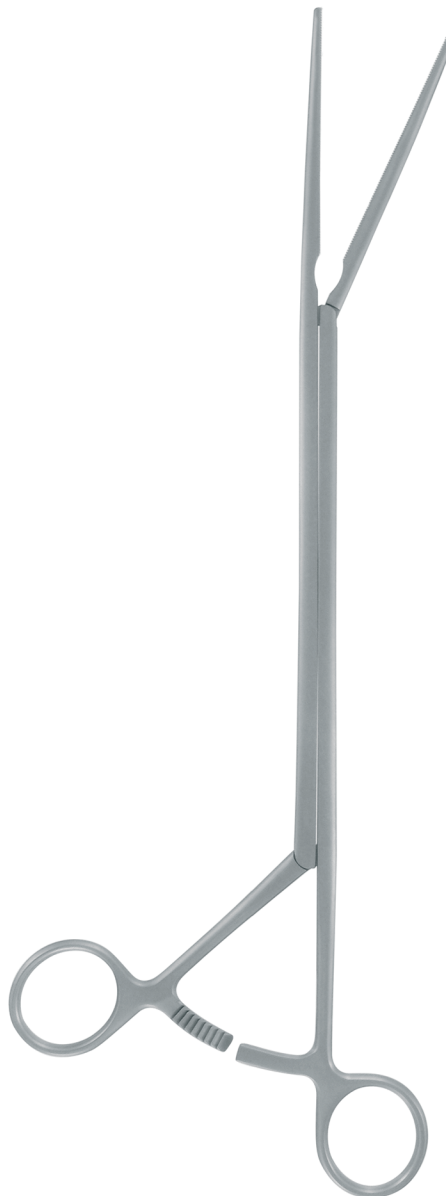

CHITWOOD DEBAKEY

1x2 DeBakey

80 mm Jaws Length
Longueur Mors 80 mm
Longitud Bocas 80 mm

2x3 DeBakey



DC80995-26

L : 265 mm - 10 1/2"

DC80995-32

L : 320 mm - 12 3/4"

 **DC80995-36**

L : 360 mm - 14 1/4"



DC80996-26

L : 265 mm - 10 1/2"

DC80996-32

L : 320 mm - 12 3/4"

DC80996-36

L : 360 mm - 14 1/4"

CHITWOOD DEBAKEY

100 mm Jaws Length
Longueur Mors 100 mm
Longitud Bocas 100 mm

1x2 DeBakey

2x3 DeBakey



DC80997-26

L : 265 mm - 10^{1/2}"

DC80997-32

L : 320 mm - 12^{3/4}"



DC80997-36

L : 360 mm - 14^{1/4}"



DC80998-26

L : 265 mm - 10^{1/2}"

DC80998-32

L : 320 mm - 12^{3/4}"

DC80998-36

L : 360 mm - 14^{1/4}"

NEEDLE HOLDERS / PORTE-AIGUILLES / PORTA AGUJAS

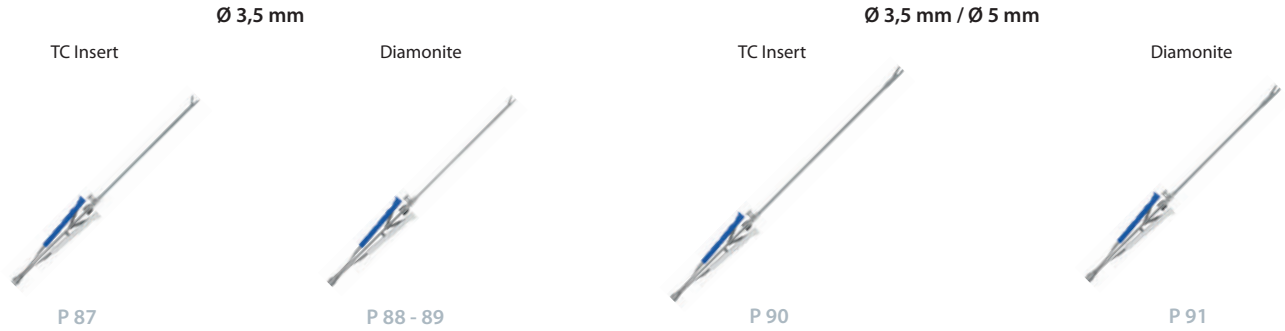

MICROMICS NEEDLE HOLDERS / PORTE-AIGUILLES MICROMICS / PORTA AGUJAS MICROMICS

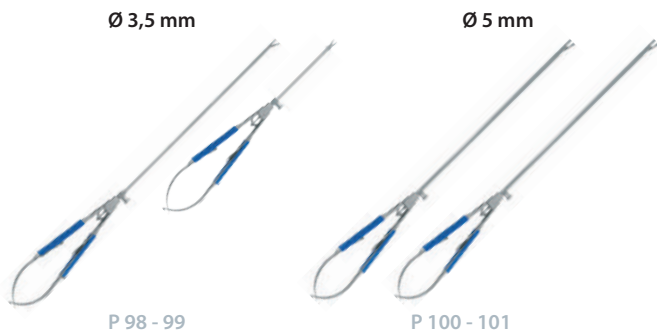

KNOT PUSHERS / POUSSE-NOEUDS / EMPUJA NUDOS



MICROMICS KNOT PUSHERS / POUSSE-NOEUDS MICROMICS/ EMPUJA NUDOS MICROMICS

Ø 5 mm



P 105

TRANSTHORACIC KNOT PUSHERS / POUSSE-NOEUDS TRANSTHORACIQUES / EMPUJA NUDOS TRANSTORÁCICA

Ø 5 mm



P 106

Tungsten Carbide Needle Holders / Porte-Aiguilles Tungstène / Porta Agujas de Tungsteno

Ø 3.5 mm



TC Inserts



Easy Lock System

Patent
Breveté
Patentado

Suture from 9/0 to 6/0
Suture de 9/0 à 6/0
Sutura desde 9/0 hasta 6/0

Straight
Droit
Recta

Ryder



DC80014-28

L : 280 mm - 11"

Curved
Courbe
Curva



DC80018-28

L : 280 mm - 11"

DC80018-36

L : 360 mm - 14 1/5"

NEW
NOUVEAU
NUEVO



Diamonite Needle Holders / Porte-Aiguilles Diamonite / Porta Agujas de Diamonite

Ø 3.5 mm

Patent
Breveté
Patentado



Diamonite



Easy Lock
System

Suture from 9/0 to 6/0
Suture de 9/0 à 6/0
Sutura desde 9/0 hasta 6/0

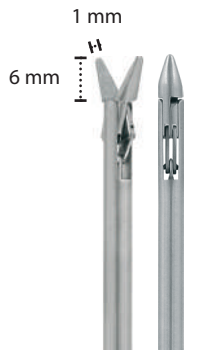

DC80040-28

L : 280 mm - 11"

NEW
NOUVEAU
NUEVO



Ø 3.5 mm

Patent
Breveté
Patentado



Diamonite



Easy Lock System

Suture from 9/0 to 6/0
Suture de 9/0 à 6/0
Sutura desde 9/0 hasta 6/0

Curved
Courbe
Curva

2.1 mm



DC80017-28

L : 280 mm - 11"

DC80017-36

L : 360 mm - 14^{1/5}"

1.3 mm



DC80015-28

L : 280 mm - 11"

DC80015-36

L : 360 mm - 14^{1/5}"

Tungsten Carbide Needle Holders / Porte-Aiguilles Tungstène / Porta Agujas de Tungsteno



TC Inserts



Easy Lock System

Ø 3.5 mm / Ø 5 mm

Suture from 8/0 to 5/0
Suture de 8/0 à 5/0
Sutura desde 8/0 hasta 5/0

Patent
Breveté
Patentado

Straight
Droit
Recta



DC80023-30

L : 300 mm - 11 4/5"

DC80023-36

L : 360 mm - 14 1/5"

NEW
NOUVEAU
NUEVO

Curved
Courbe
Curva



DC80022-30

L : 300 mm - 11 4/5"

DC80022-36

L : 360 mm - 14 1/5"



Ryder



DC80024-30

L : 300 mm - 11 4/5"

DC80024-36

L : 360 mm - 14 1/5"

NEW
NOUVEAU
NUEVO

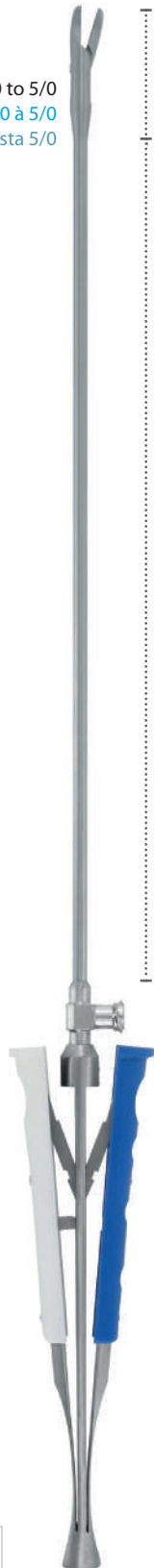

Ø 5 mm

Ø 3.5 mm

Diamonite Needle Holders / Porte-Aiguilles Diamonite / Porta Agujas de Diamonite



Diamonite



Easy Lock System

Patent
Breveté
Patentado

Ø 3.5 mm / Ø 5 mm

Suture from 8/0 to 5/0
Suture de 8/0 à 5/0
Sutura desde 8/0 hasta 5/0

Straight
Droit
Recta



DC80021-30

L : 300 mm - 11 4/5"

DC80021-36

L : 360 mm - 14 1/5"

NEW
NOUVEAU
NUEVO

NEW
NOUVEAU
NUEVO

Curved
Courbe
Curva



DC80020-30

L : 300 mm - 11 4/5"

DC80020-36

L : 360 mm - 14 1/5"

NEW
NOUVEAU
NUEVO

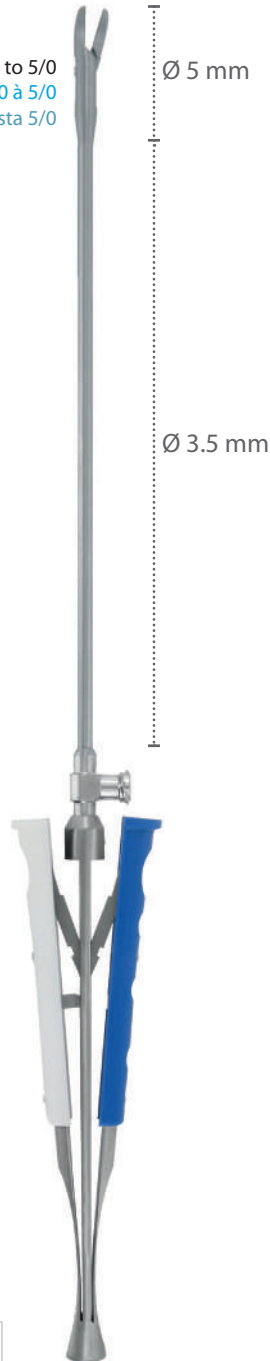

Diamonite Needle Holders / Porte-Aiguilles Diamonite / Porta Agujas de Diamonite



Diamonite



Easy Lock System

Ø 5 mm

Suture from 7/0 to 4/0
Suture de 7/0 à 4/0
Sutura desde 7/0 hasta 4/0

Patent
Breveté
Patentado

Straight
Droit
Recta



DC80011-30

L : 300 mm - 11 4/5"

NEW
NOUVEAU
NUEVO



DC80011-36

L : 360 mm - 14 1/5"

Curved
Courbe
Curva



DC80010-30

L : 300 mm - 11 4/5"

NEW
NOUVEAU
NUEVO

DC80010-36

L : 360 mm - 14 1/5"

Tungsten Carbide Needle Holders / Porte-Aiguilles Tungstène / Porta Agujas de Tungsteno



TC Inserts



Easy Lock System

Straight
Droit
Recta



DC80013-25

L : 250 mm - 10"

DC80013-30

L : 300 mm - 11 ⁴/₅"

DC80013-36

L : 360 mm - 14 ¹/₅"

DC80013-44

L : 440 mm - 17 ¹/₃"

Ryder



DC80014-30

L : 300 mm - 11 ⁴/₅"

DC80014-36

L : 360 mm - 14 ¹/₅"

Ø 5 mm

Suture from 6/0 to 3/0
Suture de 6/0 à 3/0
Sutura desde 6/0 hasta 3/0



Patent
Breveté
Patentado

Curved
Courbe
Curva



DC80012-25

L : 250 mm - 10"

DC80012-30

L : 300 mm - 11 ⁴/₅"

DC80012-36

L : 360 mm - 14 ¹/₅"

DC80012-43

L : 430 mm - 17"



Tungsten Carbide Needle Holders / Porte-Aiguilles Tungstène / Porta Agujas de Tungsteno



TC Inserts



Easy Lock System

Ø 5 mm

Suture from 6/0 to 3/0
Suture de 6/0 à 3/0
Sutura desde 6/0 hasta 3/0

NEW
NOUVEAU
NUEVO

Patent
Breveté
Patentado

Angles Upward
Angulé vers le Haut
Angulada Ariba



DC80025-30

L : 300 mm - 11 4/5"

DC80025-36

L : 360 mm - 14 1/5"



Tungsten Carbide Needle Holders / Porte-Aiguilles Tungstène / Porta Agujas de Tungsteno



TC Inserts

Ø 5 mm

Suture from 6/0 to 3/0
Suture de 6/0 à 3/0
Sutura desde 6/0 hasta 3/0

Straight
Droit
Recta



DC83003-36

L : 360 mm - 14 1/5"

DC83003-44

L : 440 mm - 17 1/3"

Curved
Courbe
Curva



DC83002-36

L : 360 mm - 14 1/5"

DC83002-44

L : 440 mm - 17 1/3"



Titanium
line





TC Inserts



Easy Lock System

Very Strong Tightening
Préhension Puissante
Apriete Muy Sólido

Ø 5 mm / Ø 6 mm

Suture from 5/0 to 2/0
Suture de 5/0 à 2/0
Sutura desde 5/0 hasta 2/0

Patent
Breveté
Patentado

Straight
Droit
Recta



DC80009-25

L : 250 mm - 10"

DC80009-30

L : 300 mm - 11 ⁴/₅"

DC80009-36

L : 360 mm - 14 ¹/₅"

DC80009-43

L : 430 mm - 17"

NEW
NOUVEAU
NUEVO

NEW
NOUVEAU
NUEVO

NEW
NOUVEAU
NUEVO

Curved
Courbe
Curva



DC80019-25

L : 250 mm - 10"

DC80019-30

L : 300 mm - 11 ⁴/₅"

DC80019-36

L : 360 mm - 14 ¹/₅"

DC80019-43

L : 430 mm - 17"

NEW
NOUVEAU
NUEVO

NEW
NOUVEAU
NUEVO



Ø 6 mm

Ø 5 mm



TC Inserts

Ø 5 mm / Ø 6 mm

Suture from 5/0 to 2/0
Suture de 5/0 à 2/0
Sutura desde 5/0 hasta 2/0

Ø 6 mm

NEW
NOUVEAU
NUEVO

Patent
Breveté
Patentado

Very Strong Tightening
Préhension Puissante
Apriete Muy Sólido

Straight
Droit
Recta



DC83009-36

L : 360 mm - 14 1/5"

Curved
Courbe
Curva



DC83019-36

L : 360 mm - 14 1/5"

Ø 5 mm



Titanium^{line}



Diamonite

Yilmaz
Ø 3.5 mm

NEW
NOUVEAU
NUEVO

Registered Design
Modèle déposé
Diseño registrado

Two Mobile Jaws
Deux Mors Mobiles
Dos Bocas Moviles

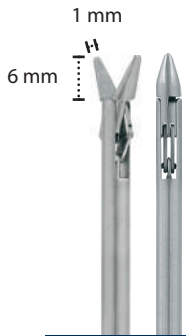

DC84040-26

WL : 90 mm - 3 1/2"
L : 260 mm - 10"

Suture from 10/0 to 7/0
Suture de 10/0 à 7/0
Sutura desde 10/0 hasta 7/0

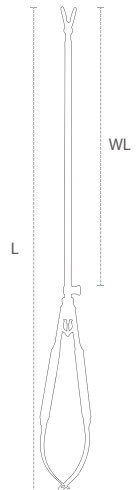

MicroMICS Needle Holder / Porte-Aiguilles MicroMICS / Porta-Agujas MicroMICS



Diamonite

Ø 3.5 mm

Suture from 9/0 to 6/0
Suture de 9/0 à 6/0
Sutura desde 9/0 hasta 6/0

NEW
NOUVEAU
NUEVO

Registered Design
Modèle déposé
Diseño registrado

2.1 mm



DC84017-41

WL : 240 mm - 9 1/2"
L : 410 mm - 16"



MicroMICS Needle Holder / Porte-Aiguilles MicroMICS / Porta-Agujas MicroMICS



Diamonite

Ø 5 mm

Suture from 8/0 to 5/0
Suture de 8/0 à 5/0
Sutura desde 8/0 hasta 5/0

NEW
NOUVEAU
NUEVO

Registered Design
Modèle déposé
Diseño registrado

Straight
Droite
Recta



DC84011-41

WL : 240 mm - 9 1/2"
L : 410 mm - 16"

Curved
Courbe
Curva



DC84010-41

WL : 240 mm - 9 1/2"
L : 410 mm - 16"



MicroMICS Needle Holder / Porte-Aiguilles MicroMICS / Porta-Agujas MicroMICS



TC Inserts

Ø 5 mm

Suture from 7/0 to 4/0
Suture de 7/0 à 4/0
Sutura desde 7/0 hasta 4/0

NEW
NOUVEAU
NUEVO

Registered Design
Modèle déposé
Diseño registrado

Straight
Droite
Recta



DC84013-33

WL : 160 mm - 6 1/2"
L : 330 mm - 12 4/5"

DC84013-35

WL : 180 mm - 7"
L : 350 mm - 13 4/5"

DC84013-41

WL : 240 mm - 9 1/2"
L : 410 mm - 16"

Curved
Courbe
Curva



DC84012-35

WL : 180 mm - 7"
L : 350 mm - 13 4/5"

 **DC84012-41**

WL : 240 mm - 9 1/2"
L : 410 mm - 16"



Active Knot Pushers / Pousse-Noeuds Actifs / Empuja-Nudos

Ø 3.5 mm / Ø 5 mm

Ø 5 mm

Ø 3.5 mm

Ø 5 mm

Patent
Breveté
Patentado



DC80302-30

L : 300 mm - 11 4/5"

NEW
NOUVEAU
NUEVO

DC80302-36

L : 360 mm - 14 1/5"

With Ratchet
Avec Verrou
Con Cerrojo

DC80303-30

L : 300 mm - 11 4/5"

NEW
NOUVEAU
NUEVO



DC80303-36

L : 360 mm - 14 1/5"

Without Ratchet
Sans Verrou
Sin Cerrojo

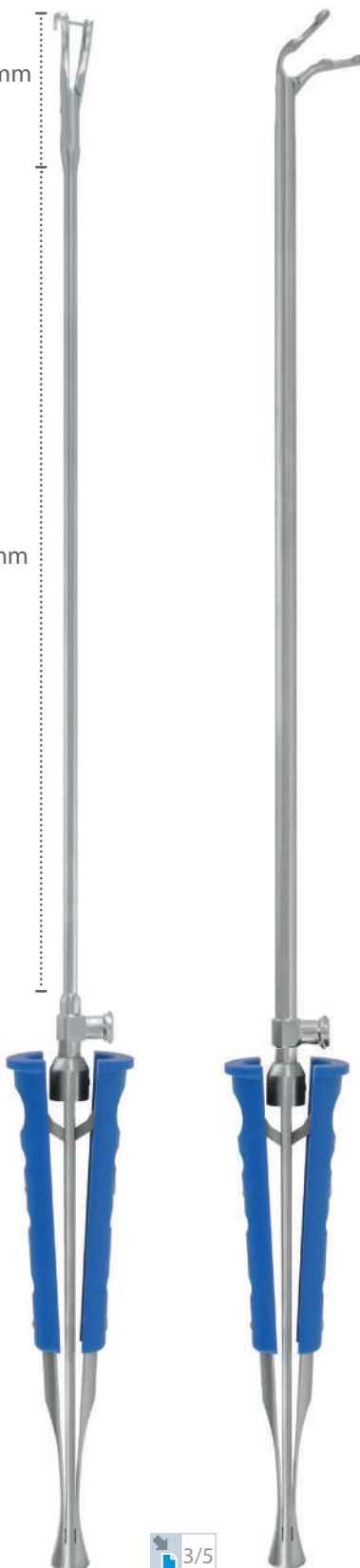

3/5



DC80304-30

L : 300 mm - 11 4/5"

NEW
NOUVEAU
NUEVO

DC80304-36

L : 360 mm - 14 1/5"

With Ratchet
Avec Verrou
Con Cerrojo

NEW
NOUVEAU
NUEVO

DC80300-30

L : 300 mm - 11 4/5"



DC80300-36

L : 360 mm - 14 1/5"

Without Ratchet
Sans Verrou
Sin Cerrojo

Knot Pushers / Pousse-Noeuds / Empuja-Nudos

Obadia

Yilmaz

Fixed Length
Longueur Fixe
Longitud Fija



DC81308-28

L : 280 mm - 11"

DC81308-35

L : 350 mm - 13^{3/4}"

Adjustable Length
Longueur Réglable
Longitud Adjustable



DC81308-00

L mini : 290 mm - 11^{2/5}"

L maxi : 360 mm - 14^{1/5}"



Fixed Length
Longueur Fixe
Longitud Fija
Ø 2 mm



DC81323-21

L : 210 mm - 8^{1/5}"

DC81323-30

L : 300 mm - 11^{4/5}"



Yan



DC71710-50

L : 50 mm - 2"

Ø 5 mm

NEW
NOUVEAU
NUEVO

Registered Design
Modèle déposé
Diseño registrado



DC84300-35

WL : 180 mm - 7"
L : 350 mm - 13 ⁴/₅"



DC84300-41

WL : 240 mm - 9 ¹/₂"
L : 410 mm - 16"

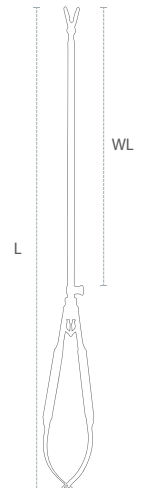
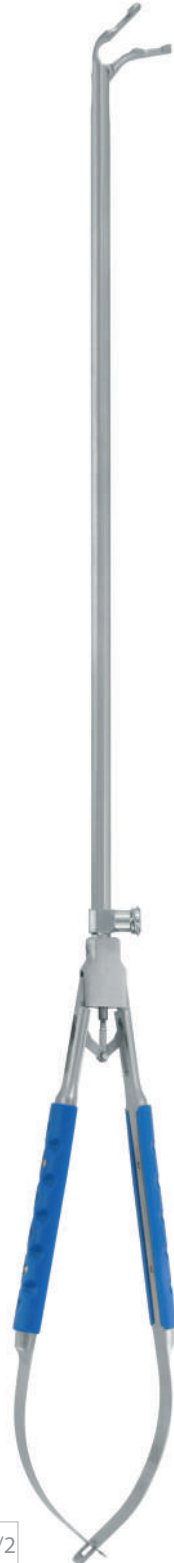

Knot-Pusher with Suture Cutter
Pousse-noeuds avec Coupe-Suture
Empuja-Nudos con Cortador de Suturas



DC80459-28

L: 280 mm - 11"

NEW
NOUVEAU
NUEVO



DC80459-34

L: 330 mm - 13"

DC80459-38

L: 380 mm - 14"

NEW
NOUVEAU
NUEVO

BIOPSY FORCEPS / PINCES À BIOPSIE / PINZAS DE BIOPSIA

Ø 2 mm / Ø 2.5 mm



P 109

SUTURE RULER / GABARITS / PLANTILLAS



P 110

ACCESSORIES / ACCESSOIRES / ACCESORIOS

Suture Catcher / Crochet à Suture / Gancho para Sutura

Needles Retriever / Récupérateur à Aiguilles / Recuperador de Aguja

Suture Ring / Anneau à Sutures / Anillo para Sutura



P 111



P 112



P 113

MIS CANNULAS / CANULE D'ASPIRATION MIS / CÁNULA DE ASPIRACIÓN MIS



P 114

MIS RONGEURS / RONGEURS MIS / GUBIAS



P 115



P 116



P 117

TUBE PASSERS / PASSES TUBES / TUBOS PAS SCALPEL BLADE HANDLES / MANCHES DE BISTOURI / MANGOS DE BISTURÍ



P 118



P 119

INSTRUMENTS HOLDERS / PORTE INSTRUMENTS / SOPORTE DEL INSTRUMENTO

Gossot



P 120

TRAINER+ / TRAINER+ / TRAINER+



P 121

Ø 2 mm / Ø 2.5 mm

Round Angled Cupules Ø 2 mm
Cupules Rondes Angulées Ø 2 mm
Redondo Angulado Cupula Ø 2 mm



Angled Jaws 2x4 mm
Mors Angulés 2x4 mm
Bocas Anguladas 2x4 mm

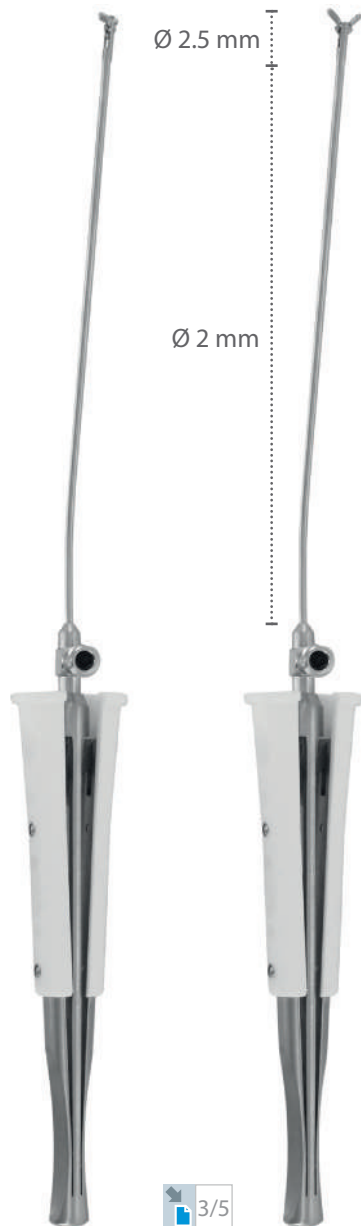

Obadia



Straight
Droite
Recta

DC81320-38

L : 380 mm - 15"

Laser Graduated
Graduation au Laser
Graduación Laser



Curved
Courbe
Curva

DC81322-38

L : 380 mm - 15"

Suture Catchers / Crochets à Suture / Ganchos para Sutura

Ø 2.5 mm



DC81410-28

L : 280 mm - 11"

DC81410-36

L : 360 mm - 14^{1/5}"

NEW
NOUVEAU
NUEVO



Needles Retrievers / Récupérateurs à Aiguilles / Recuperadores de Aguja



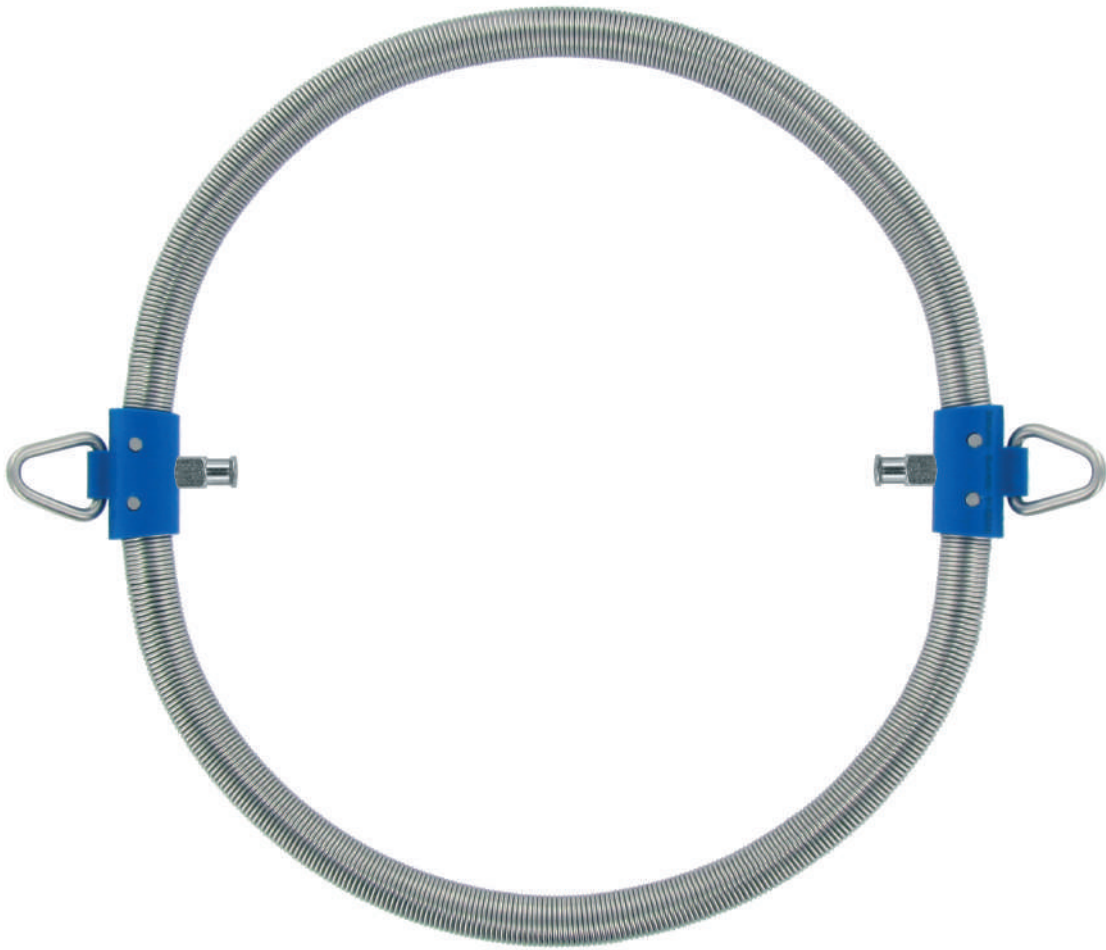

DC81400-00

Ø : 220 mm - 8^{2/3}"

Without Luer Lock

Sans Raccord Luer Lock

Sin Conexión Luer Lock



DC81400-01

Ø : 220 mm - 8^{2/3}"

With Luer Lock

Avec Raccord Luer Lock

Con Conexión Luer Lock

8 mm



DC71337-33 *
L : 330 mm - 13"



DC71337-33-C *
L : 260 mm - 10"



DC71337-33-S *
L : 260 mm - 10"

Straight / Droit / Recta

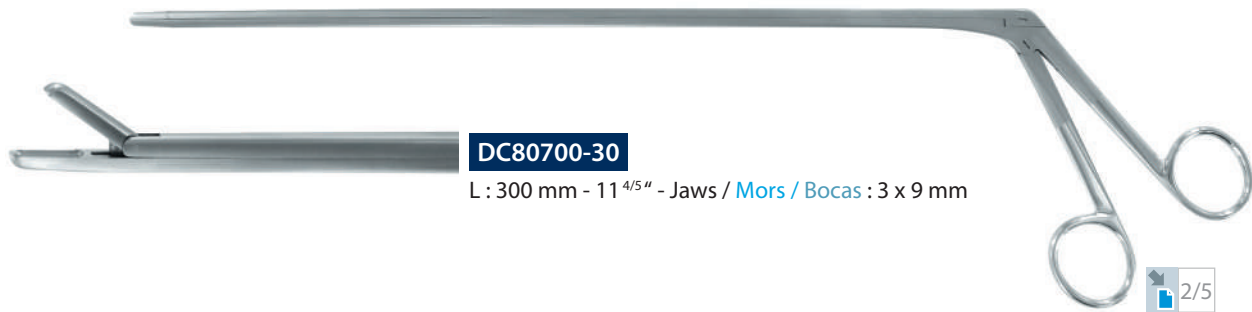

Angled Upwards 30° / Angulé Vers le Haut de 30° / Angulado Hacia Arriba de 30°



Angled Downwards 30° / Angulé Vers le Bas de 30° / Angulado Hacia Abajo de 30°



Straight / Droit / Recta



DC80710-23 

L : 230 mm - 9" - Jaws / Mors / Bocas : 6 x 12 mm

DC80710-30

L : 300 mm - 11 ⁴/₅" - Jaws / Mors / Bocas : 6 x 12 mm



Angled Upwards 45° / Angulé Vers le Haut de 45° / Angulado Hacia Arriba de 45°

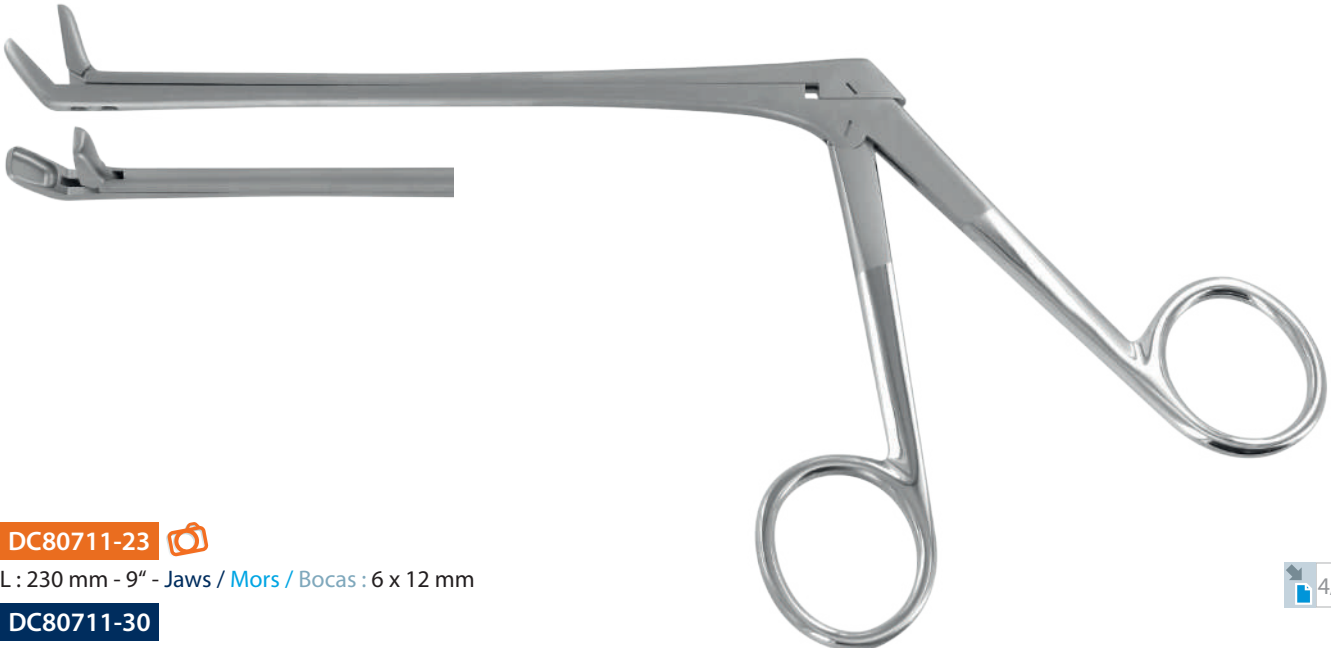

DC80711-23 

L : 230 mm - 9" - Jaws / Mors / Bocas : 6 x 12 mm

DC80711-30

L : 300 mm - 11 ⁴/₅" - Jaws / Mors / Bocas : 6 x 12 mm



Ø 5 mm

Straight
Droit
Recta



30°





 **DC80420-24**

L : 240 mm - 9 1/2"
With Ratchet
Avec Crémaillère
Con Cremallera

DC80417-24

L : 240 mm - 9 1/2"
Without Ratchet
Sans Crémaillère
Sin Cremallera

DC80419-36

L : 355 mm - 14"
With Ratchet
Avec Crémaillère
Con Cremallera

DC80418-36

L : 355 mm - 14"
Without Ratchet
Sans Crémaillère
Sin Cremallera



Scalpel Blade Handles / Manches de Bistouri / Mangos de Bisturí

Beaver

For Beaver Blades
Pour Lames Beaver
Para Hojas Beaver

For Blades Models
Pour Modèles de Lames
Para modelos de Hojas



- 10
- 11P
- 12
- 15S
- 18
- 19

Adjustable Length
Longueur Réglable
Longitud ajustable

DC81330-00

L mini : 290 mm - L maxi : 360 mm

DC81330-01

L mini : 180 mm - L maxi : 250 mm

Fixed Length
Longueur Fixe
Longitud Fija

 **DC81330-33**

L : 330 mm - 13"

DC81331-33

L : 330 mm - 13"



Gossot

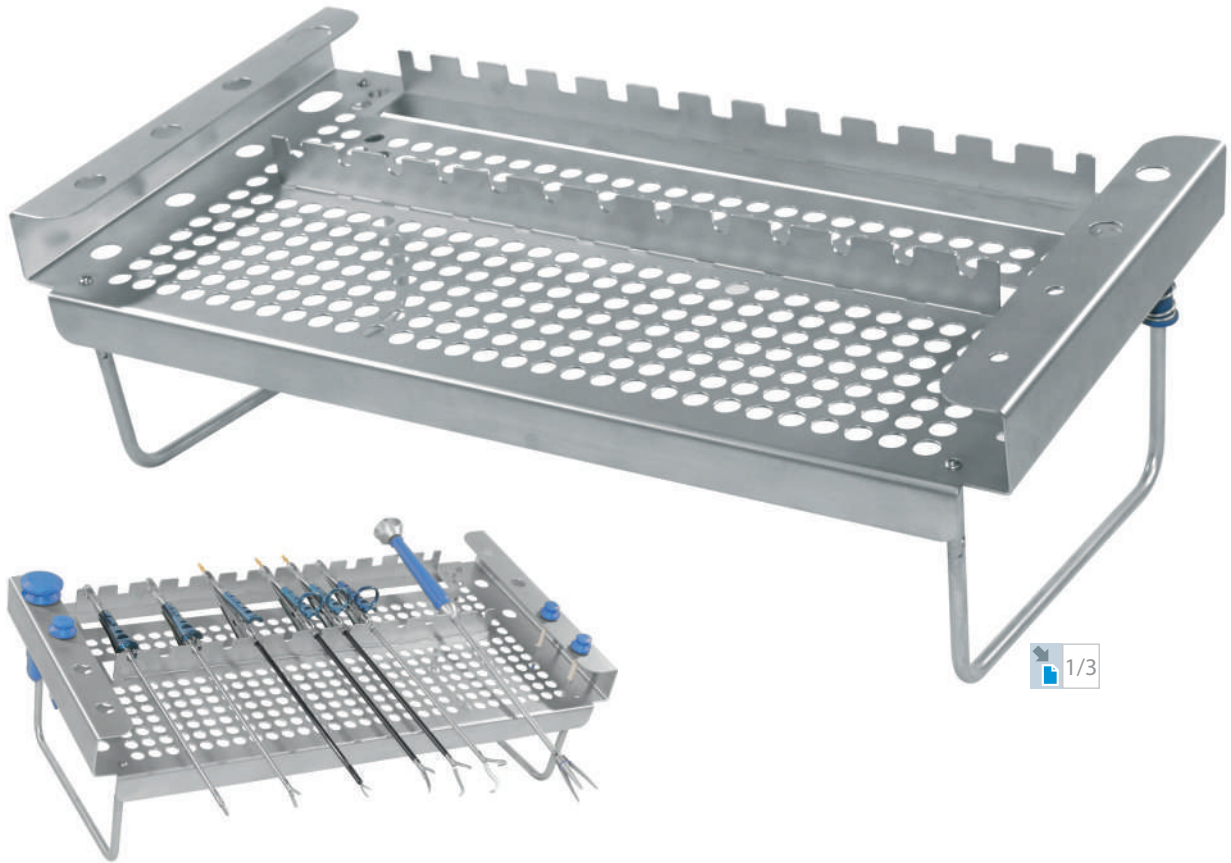

Comfort Model / [Modèle Confort](#) / [Modelo de Confort](#)

 **DC81930-01**

L : 543 mm x l : 277 mm x h : 84 mm

Instruments not Included / [Instruments non Inclus](#) / [Instrumentos no Incluidos](#)

Reduced Size Version for Sterilization in Container

[Version Réduite pour Stérilisation en Conteneur](#)

[Versión Reducida para Esterilización en Contenedores](#)

DC81930-02

L : 511 mm x l : 245 mm x h : 84 mm

Instruments not Included / [Instruments non Inclus](#) / [Instrumentos no Incluidos](#)

Trainer+ Pack / Pack Trainer+ / Paquete Trainer+



DC89100-00

Trainer+ Pack / Pack Trainer+ / Paquete Trainer+



Trainer+ holder
Support Trainer+
Soporte Trainer+

DC89100-01



Holder
Support
Soporte

DC89100-02



1 Sample
1 Échantillon
1 Muestra

DC89111-01



Trainer+ Bag
Valise Trainer+
Maleta Trainer+

Accessories / Accessoires / Accesorios



DC89111-10
10 Samples
10 Échantillons
10 Muestras

DC89111-01

1 Sample
1 Échantillon
1 Muestra



DC89112-05
5 Samples
5 Échantillons
5 Muestras

DC89112-01

1 Sample
1 Échantillon
1 Muestra

Options / Options / Opciones



DC89101-00
Endoscope holder
Porte-Endoscope
Soporte endoscopio

DC89100-19

Grommet for DC89100-01
Joint pour DC89100-01
Ojal para DC89100-01

INSTRUMENT PLATFORMS / KITS D'INSTRUMENTS / KITS DE INSTRUMENTOS

YAN



Prof. Yan Instrument Platform
Kit d'Instruments du Pr. Yan
Kit de Instrumentos del Prof. Yan

P 125

ADAMS



Dr. Adams Instrument Platform
Kit d'Instruments du Dr. Adams
Kit de Instrumentos del Dr. Adams

P 126

OBADIA II



Prof. Obadia Instrument Platform
Kit d'Instruments du Pr. Obadia
Kit de Instrumentos del Prof. Obadia

P 127

YILMAZ

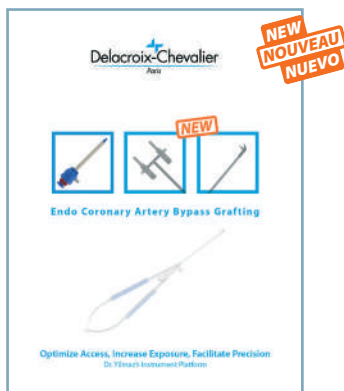

Dr. Yilmaz Instrument Platform
Kit d'Instruments du Dr. Yilmaz
Kit de Instrumentos del Dr. Yilmaz

P 128

GOSSOT

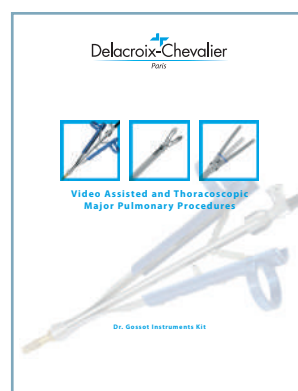

Dr. Gossot Instrument Platform
Kit d'Instruments du Dr. Gossot
Kit de Instrumentos del Dr. Gossot

P 129

STERILIZATION TRAYS / PANIERS DE STÉRILISATION / CESTA DE ESTERILIZACIÓN

YAN

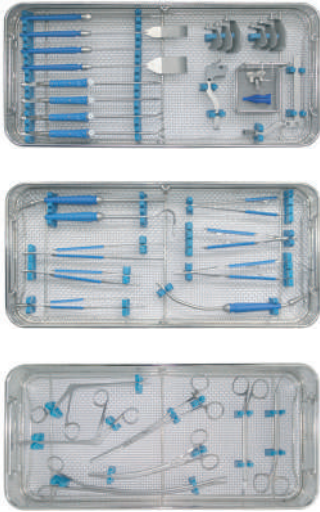

P 130

ADAMS



P 131

OBADIA II

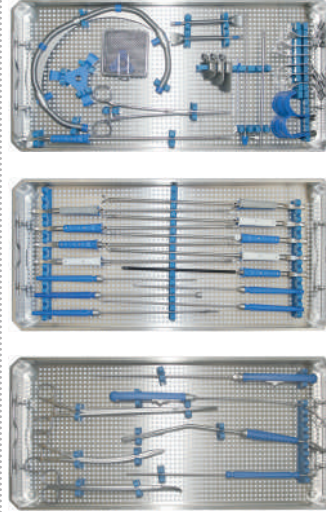

P 132

YILMAZ

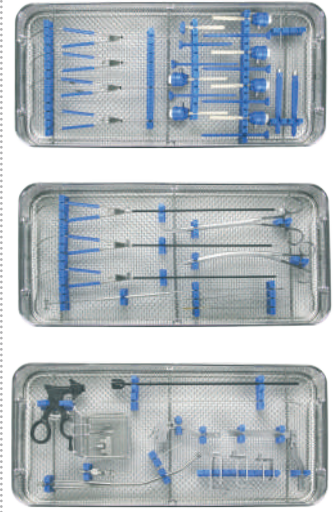

P 133

GOSSOT

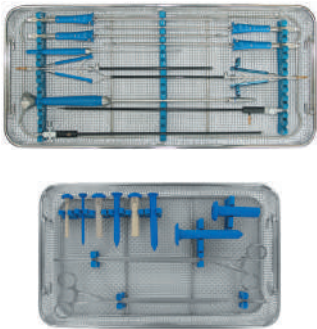

P 134

MIS

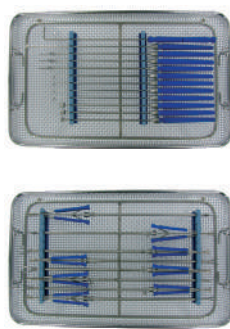

P 135

MIDACCESS

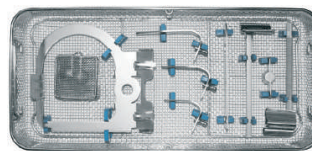

YAN



P 136

STERNACCESS



OBADIA

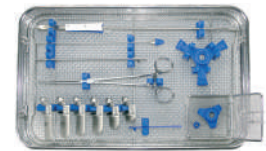

P 137

YAN

DC82160-00:
Yan Mini-Access Retractor

Écarteur Yan Mini-Access Etroit - Separador Mini-Access Yan



DC81330-01:
Scalpel Blade Handle

Manche de Bistouri MIS - Mangos de Bisturí MIS



DC33010-25:
Artery Protector

Protecteur d'Artère - Protección de la Arteria



DC40087-26:
Atraumatic Cross Clamp

Clamp Atraumatique - Pinza Atraumatic



DC13030-21S:
Strong Hybrid Forceps

Pince à Dissection Hybride - Pinzas de Disección Híbridas



DC13030-24S:
Strong Hybrid Forceps

Pince à Dissection Hybride - Pinzas de Disección Híbridas



DC80710-23:
Straight Rongeur

Rongeur - Droit - Gubias - Recta



DC80711-23:
45° Upper-cut Rongeur

Rongeur - 45° - Gubias - 45°



DC21120-22:
Curved Supercut Scissors

Ciseaux Supercut Courbes - Tijeras Supercut Curvas



DC80132-25:
MIS Robust Scissors, Curved

Ciseaux MIS Robustes, Courbes - Tijeras Robustas MIS, Curvadas



DC80133-25:
MIS Robust Scissors, Strongly Curved

Ciseaux MIS Robustes, Très Courbes - Tijeras Robustas MIS, Muy Curvadas



DC81301-01:
MIS Suture Hook

Crochet MIS - Gancho MIS



DC12550-24S:
Supergrip Micro Forceps

Micro Pince à Dissection Supergrip - Micro Pinzas de Disección



DC33020-20:
Narrow Hand Held Retractor

Écarteur à Main Etroit - Separador Estrecho



DC33020-30:
Broad Hand Held Retractor

Écarteur à Main Large - Separador Largo



DC71337-33-S: *
MIS Straight Sucker

Canule d'Aspiration Droite - Cánula de Aspiración Recta



DC71337-33-C: *
MIS Curved Sucker

Canule d'Aspiration Courbe - Cánula de Aspiración Curva



DC71710-50:
Finger-Extension Knot Pusher

Pousse-Nœuds à Doigt - Empuja Nudos a Dedo



DC50644-23S:
Yan Heavy Style SuperGrip Needle Holder

Porte-Aiguilles Supergrip Modèle Fort Yan

Porta Agujas Supergrip Modelo Fuerte



DC50644-25S:
Yan Heavy Style SuperGrip Needle Holder

Porte-Aiguilles Supergrip Modèle Fort Yan

Porta Agujas Supergrip Modelo Fuerte



DC80019-25:
MIS Robust Needle Holder, Curved

Porte-Aiguilles MIS Robuste, Courbe - Porta Agujas Robusto MIS, Curvado



DC80009-25:
MIS Robust Needle Holder, Straight

Porte-Aiguilles MIS Robuste, Droit - Porta Agujas Robusto MIS, Recto



DC80419-36:
Chest Tube Passer

Passe-Drains - Tubo Pase

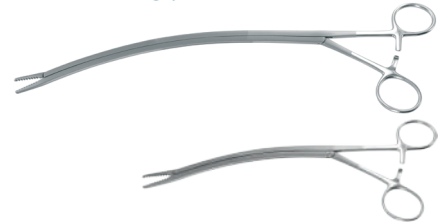

DC80420-24:
Chest Tube Passer

Passe-Drains - Tubo Pase



DC50203-23S:
Fine Supergrip Micro Needle Holder

Micro Porte-Aiguilles Supergrip Fin - Micro Supergrip Porta Agujas



* For regulatory reason, please check with your distributor for availability in your country

* Por razones reglamentarias, por favor póngase en contacto con su distribuidor para conocer la disponibilidad en su país

NEW
NOUVEAU
NUEVO

ADAMS

Example: Rack Down Configuration - Progressive Blade Sizes

DC30149-01:
Adams Retractor
Écarteur Adams - Separador Adams



DC30147-00:
Transverse Rail
Barre Transversale - Carril Transversal



DC30145-30:
Sternal Blades
Valves Sternales - Espadas Esternales



DC30159-02 x3:
Attachment Bracket for Hooks
Système de Fixation pour Crochet - Soporte de Fijación Para Ganchos



DC30145-40:
Sternal Blades
Valves Sternales - Espadas Esternales



DC30153-27 x2:
Long and Thin Hook
Crochet Long et Fin - Gancho Auricular Larga y Delgada



DC30145-70:
Sternal Blades
Valves Sternales - Espadas Esternales



DC30154-25:
Medium Hook
Crochet Moyen - Gancho Auricular Medio



DC30148-00:
Medial Rail System With Screw
Mât avec Vis - Sistema de Riel Medial con Tornillo



Adams Instruments and Accessories

DC80200-30 x2:
MIS DeBakey Forceps
Pince à Dissection DeBakey MIS - Pinza DeBakey MIS



DC80019-30 x2:
MIS Robust Needle Holder, Curved
Porte-Aiguilles MIS Robuste, Courbe - Porta Agujas Robusto MIS, Curvado



DC80202-30:
MIS Resano Forceps
Pince à Dissection Resano MIS - Pinza Resano MIS



DC81301-00:
MIS Hook
Crochet MIS - Gancho MIS



DC80132-30:
MIS Robust Scissors, Curved
Ciseaux MIS Robustes, Courbes - Tijeras Robustas MIS, Curvadas



DC81308-00:
MIS Knot Pusher
Pousse-Noeuds MIS Obadia - Empujador de Nudos MIS



DC80133-30:
MIS Robust Scissors, Strongly Curved
Ciseaux MIS Robustes, Très Courbes - Tijeras Robustas MIS, Muy Curvadas



DC81330-00:
MIS Scalpel Blade Holder
Manche de Bistouri MIS - Soporte de Hoja de Bisturí MIS



OBADIA II

DC81115-00:
3D Retractor with Flexible Blade
Écarteur pour Lamelle Souple Additionnelle
Retractor para Lamelle Flexible Adicional



DC82152-99:
C-Ring Retractor
Anneau écarteur en C
Anillo Separador en C

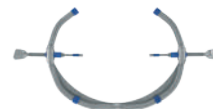

Included - Inclus - Incluido:

DC81116-30: Blade - Valve - Válva 35 x 30 mm
DC81116-40: Blade - Valve - Válva 35 x 40 mm
DC81116-50: Blade - Valve - Válva 35 x 50 mm



DC82153-30:
Soft Intercostal Blade (pair)
Valve Souple Intercostale
Válva Intercostal Flexible



Optional Blades - Valves Optionnelles - Cuchillas opcionales:

DC81118-80: Blade - Valve - Válva 40 x 50 mm
DC81118-60: Blade - Valve - Válva 40 x 60 mm
DC81118-70: Blade - Valve - Válva 40 x 70 mm



DC81117-94:
Flexible Additional Atrial Blade
Lamelle Souple Additionnelle - Lamelle Flexible Adicional



DC81310-28:
MIS Magnetic Retriever
Récupérateur à Aimant - Recuperador de agujas



DC81364-36:
Forceps for Flexible Additional Atrial Blade
Pince pour Lamelle Souple Additionnelle - Pinzas para Lamelle Flexible Adicional



DC81330-33:
MIS Scalpel Blade Holder
Manche de Bistouri MIS - Mangos de Bisturí MIS



DC81363-24:
Forceps for Atrial Blade
Pince pour Valve Atriale - Pinzas para Valvula Mitral



DC81302-30:
MIS Hook for Nerves and Vessel
Crochet pour Nerfs et Vaisseaux MIS - Ganchos Intracardíacos



DC80200-36:
MIS DeBakey Forceps
Pince DeBakey MIS - Pinzas DeBakey MIS



DC81303-33:
MIS Double Hook for Nerves and Vessel
Crochet Double pour Nerfs et Vaisseaux
Doble Gancho Intracardíaco



DC80202-36:
MIS Atraumatic Resano Forceps
Pince Atraumatique Resano MIS - Pinza Atraumatica Resano MIS



DC81322-38:
MIS Curved Suture Ruler
Gabarit Courbe
Plantillas Curvas



DC80132-36:
MIS Robust Scissors, Curved
Ciseaux MIS Robustes, Courbes - Tijeras Robustas MIS, Curvadas



B25925:
Double Curved Scissors
Ciseaux Double Courbure - Tijeras Doble Curva



DC80133-36:
MIS Robust Scissors, Strongly Curved
Ciseaux MIS Robustes, Très Courbes - Tijeras Robustas MIS, Muy Curvadas



DC80996-32:
MIS DeBakey Intercostal Clamp
Clamp Intercostal DeBakey MIS
Pinzas Transtorácicas MIS DeBakey



DC80009-36:
MIS Robust Needle Holder, Straight
Porte-Aiguilles MIS Robuste, Droit - Porta Agujas Robusto MIS, Recto



DC71337-33: *
MIS Suction Tube
Canule d'Aspiration MIS
Cánula de Aspiración MIS



DC80019-36:
MIS Robust Needle Holder, Curved
Porte-Aiguilles MIS Robuste, Courbe - Porta Agujas Robusto MIS, Curvado



DC80420-24:
Tube Passer
Passe Drain - Tubo Pase



DC81308-35:
MIS Knot Pusher
Pousse Noeud MIS - Empuja Nudos



DC81410-28:
MIS Suture Catcher
Crochet à Suture MIS - Gancho para sutura



* For regulatory reason, please check with your distributor for availability in your country

* Por razones reglamentarias, por favor póngase en contacto con su distribuidor para conocer la disponibilidad en su país

**NEW
NOUVEAU
NUEVO**

YILMAZ

E01AB2000: *

Endoscope
Endoscope - Endoscopio



DC84244-45:
MicroMICS Maryland Dissector
Dissecteur Maryland MicroMICS - Disector de Maryland MicroMICS



E0621121 + E0621122:

Horizon Clip Applier
Applicateur de clip rotatif Horizon - Aplicador de clip Horizon



DC84243-45:
MicroMICS Fenestrated Forceps
Pince Fénêtrée MicroMICS - Pinzas fenestradas MicroMICS



DC82981-07 x6:

Magnetic Trocar
Trocart Magnétique - Trocar Magnético



DC84141-45:
MicroMICS Metzenbaum Scissors
Ciseaux Metzenbaum MicroMICS - Tijeras Metzenbaum MicroMICS



DC82160-99:

Yan Mini-Access Retractor
Écarteur Yan Mini-Access - Separador Mini-Access Yan
+ DC82163-30 + DC82163-40 + DC82163-50:
Narrow Blades
Valves étroites - Cuchillas Estrechas



DC14900-18:
Cushing Forceps
Pince à dissection Cushing - Pinzas Cushing



DC71337-33-C: *
MIS Suction Tube
Canule d'Aspiration MIS - Tubo de Succión MIS



DC13202-20:

DeBakey Forceps
Pince à dissection DeBakey - Pinzas DeBakey



DC71350-05: *
45° Frazier Suction Tube
Canule d'aspiration Frazier 45° - Tubo de Succión de Frazier 45°



DC84240-26:

MicroMICS Grasping Forceps
Pince à dissection MicroMICS - Pinzas de Agarre MicroMICS



DC84040-26:
MicroMICS Needle Holder
Porte-aiguilles MicroMICS - Porta-agujas MicroMICS



DC84116-26:

MicroMICS Potts 45° Scissors
Ciseaux MicroMICS Potts 45° - Tijeras MicroMICS Potts 45°



DC81305-21:
MIS Hook
Crochet MIS - Gancho MIS



DC84117-26:

MicroMICS Potts 125° Scissors
Ciseaux Metzenbaum MicroMICS - Tijeras Metzenbaum MicroMICS



DC81323-21:
MIS Knot Pusher
Pousse-nœuds MIS - Empuja-Nudos MIS



DC80996-26:

MIS DeBakey Intercostal Clamp
Clamp Intercostal DeBakey MIS - Pinzas Transtorácicas MIS DeBakey



E0616008 + E0633002 + E0633442:
Fenestrated Forceps
Pince Fenêtrée Démontable - Pinzas Fenestradas



DC41029-40 x2:

Diethrich Bulldog Clamp
Clamp Culldog Diethrich - Pinzas Culldog Diethrich



DC82120-90:
90° 3D Connector
Bras 3D pour écarteur Yan Mini-Access - Pinzas fenestradas MicroMICS



DC82961-07:

Trocar for Thoracoscopy
Trocart - Trocar Para Toracosopia



DC81010-00:
Approximator
Approximateur - Aproximador



Accessories

DC80420-24:

Chest Tube Passer
Passe Drain Courbe - Tubo Pase



E500005: *
Surgical Arm with Rail Clamp
Bras articulé avec étau - Brazo articulado con vicio



GOSSOT

Trocars

Thoracic Trocars
Trocarts pour Thoroscopie
Trocares para Toroscopia

DC82961-07: (Ø 5 mm)
DC82966-07: (Ø 6 mm)
DC82962-07: (Ø 10 mm)



Magnetic Trocars - Serrated Tube
Trocarts Magnétique - Tube strié
Trocares Magnéticos - Tubo Rayado

DC82981-07: (Ø 5 mm)
DC82984-07: (Ø 6 mm)
DC82982-07: (Ø 10 mm)



DC82970-07: (Ø 16 x 25 mm)



E229121: (Ø 12 mm) *



DC82965-70: (Ø 5 mm)



Dissection Instruments

DC83208-36: *
Maryland dissector
Dissecteur Maryland - Disector Maryland



DC83209-36: *
Maryland dissector
Dissecteur Maryland - Disector Maryland



DC83200-36:
Straight DeBakey Forceps
Pince DeBakey Droite - Pinza DeBakey Recta



DC83201-36:
Straight DeBakey Forceps
Pince DeBakey Droite - Pinza DeBakey Recta



DC83207-36:
Curved DeBakey Forceps
Pince DeBakey Courbe - Pinza DeBakey Curva



E0623001: *
Dissecting Monopolar Hook
Crochet à Dissection Monopolaire - Gancho para Disección Monopolar



E0623004: *
Button tip HF Suction Tube
Tube d'Aspiration à Électrode Boule - Tubo de Aspiración con Electrodo Bola



DC83224-36:
Double Curved Dissector
Dissecteur Double Courbe - Disector Doble Curva



DC83225-36:
MIS 90° Dissector
Dissecteur 90° MIS - Disector 90° MIS



DC83110-36: *
Handle for Disposable Scissors Tips
Manche pour embouts ciseaux - Mango para Punta Tijeras



DC83110-12: *
Reusable Curved Scissors Tips
Embouts ciseaux à usage court - Puntas de Tijeras Reutilizable



DC82940-38:
Ligature Carrier Retractor
Retrateur passe-lac - Retractor Portador de Ligadura



DC82940-40:
Ligature Carrier Retractor
Retrateur passe-lac - Retractor Portador de Ligadura



Prehension Instruments

DC83213-36:
Fenestrated Forceps
Pince Fenêtrée - Pinza Fenestrada



DC83216-36:
Fenestrated Forceps
Pince Fenêtrée - Pinza Fenestrada



Instruments for Lymph Node Resection

DC83210-36:
Lymph Node Forceps
Pince à Ganglions - Pinza para Ganglios



DC82950-38:
3 Legs Retractor
Ecarteur à 3 Branches - Separador con 3 Ramas



DC83211-36:
Lymph Node Forceps
Pince à Ganglions - Pinza para Ganglios



Additional Instruments

DC83003-36:
MIS Needle Holder, Straight
Porte-Aiguilles MIS, Droit - Porta Agujas MIS, Recto



DC81330-33:
Scalpel Blade Holder
Manche de Bistouri - Mango de Bisturí



DC83009-36:
MIS Robust Needle Holder, Straight
Porte-Aiguilles MIS Robuste, Droit - Porta Agujas Robusto MIS, Recto



DC83221-44:
Grasping Fenestrated Forceps
Pincas à Préhension Fenêtrées - Pinzas de Agarre Fenestradas



DC83019-36:
MIS Robust Needle Holder, Curved
Porte-Aiguilles MIS Robuste, Courbe - Porta Agujas Robusto MIS, Curvado



DC80996-36:
Curved Parenchyma Clamp
Clamp Courbe à Parenchyme - Pinza Curva para Parénquima



* For regulatory reason, please check with your distributor for availability in your country

* Por razones reglamentarias, por favor póngase en contacto con su distribuidor para conocer la disponibilidad en su país

Prof. Yan Instrument Platform - Trays Kit d'Instruments du Pr. Yan - Paniers / Kit de Instrumentos del Prof. Yan - Cestas

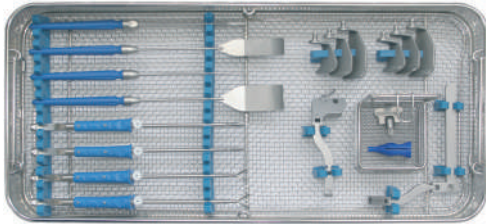

DC81912-01 *

540 x 250 x 70 mm

Provided with Lid, Instruments not Included

Livré avec Couvercle, Instruments non Inclus

Entregado con Tapa, Instrumentos no Incluidos

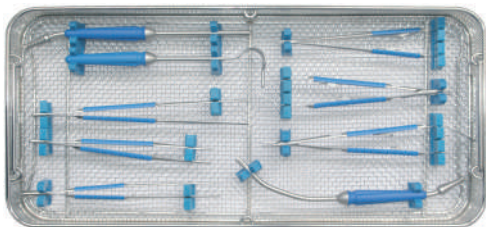

DC81912-02 *

540 x 250 x 70 mm

Provided with Lid, Instruments not Included

Livré avec Couvercle, Instruments non Inclus

Entregado con Tapa, Instrumentos no Incluidos

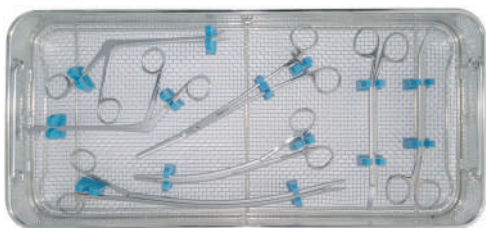

DC81912-03 *

540 x 250 x 70 mm

Provided with Lid, Instruments not Included

Livré avec Couvercle, Instruments non Inclus

Entregado con Tapa, Instrumentos no Incluidos

* For regulatory reason, please check with your distributor for availability in your country

* Por razones reglamentarias, por favor póngase en contacto con su distribuidor para conocer la disponibilidad en su país

Dr. Adams Instrument Platform - Trays

Kit d'Instruments du Dr. Adams - Paniers / Kit de Instrumentos del Dr. Adams - Cestas

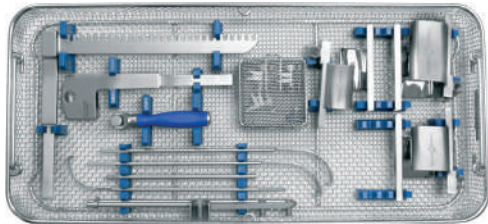

DC30159-00 *

540 x 250 x 100 mm

Provided with Lid, Instruments not Included

Livré avec Couvercle, Instruments non Inclus

Entregado con Tapa, Instrumentos no Incluidos

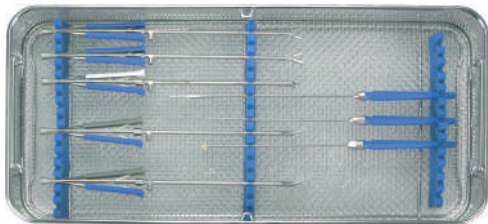

DC81900-05 *

535 x 250 x 70 mm

Provided with Lid, Instruments not Included

Livré avec Couvercle, Instruments non Inclus

Entregado con Tapa, Instrumentos no Incluidos

* For regulatory reason, please check with your distributor for availability in your country

* Por razones reglamentarias, por favor póngase en contacto con su distribuidor para conocer la disponibilidad en su país

Prof. Obadia Instrument Platform - Trays Kit d'Instruments du Pr. Obadia - Paniers / Kit de Instrumentos del Prof. Obadia - Cestas

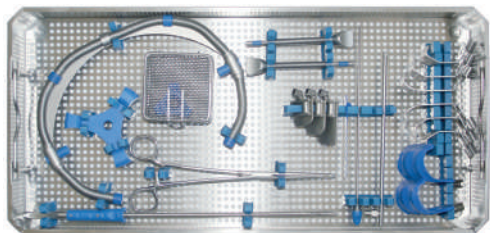

DC81910-01 *

540 x 250 x 70 mm
Provided with Lid, Instruments not Included
Livré avec Couvercle, Instruments non Inclus
Entregado con Tapa, Instrumentos no Incluidos



DC81910-02 *

540 x 250 x 70 mm
Provided with Lid, Instruments not Included
Livré avec Couvercle, Instruments non Inclus
Entregado con Tapa, Instrumentos no Incluidos

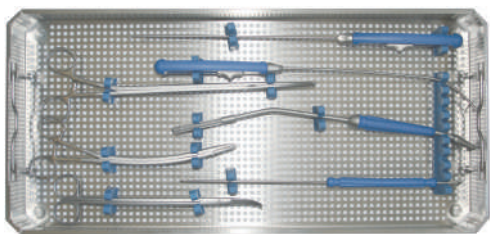

DC81910-03 *

540 x 250 x 70 mm
Provided with Lid, Instruments not Included
Livré avec Couvercle, Instruments non Inclus
Entregado con Tapa, Instrumentos no Incluidos

* For regulatory reason, please check with your distributor for availability in your country

* Por razones reglamentarias, por favor póngase en contacto con su distribuidor para conocer la disponibilidad en su país

Dr. Yilmaz Instrument Platform - Trays

Kit d'Instruments du Dr. Yilmaz - Paniers / Kit de Instrumentos del Dr. Yilmaz - Cestas

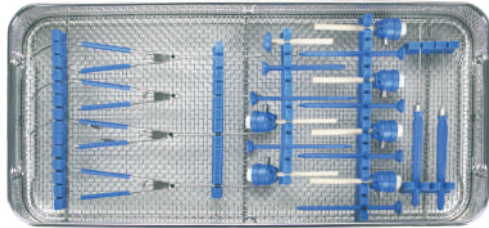

DC81913-01 *

NEW
NOUVEAU
NUEVO

540 x 250 x 70 mm

Provided with Lid, Instruments not Included

Livré avec Couvercle, Instruments non Inclus

Entregado con Tapa, Instrumentos no Incluidos

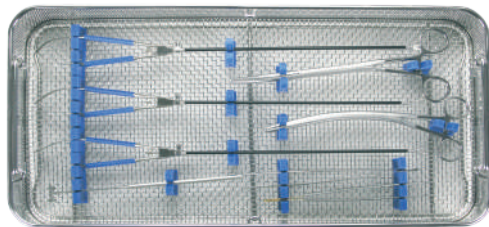

DC81913-02 *

NEW
NOUVEAU
NUEVO

540 x 250 x 70 mm

Provided with Lid, Instruments not Included

Livré avec Couvercle, Instruments non Inclus

Entregado con Tapa, Instrumentos no Incluidos

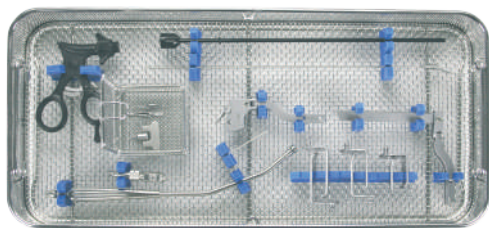

DC81913-03 *

NEW
NOUVEAU
NUEVO

540 x 250 x 70 mm

Provided with Lid, Instruments not Included

Livré avec Couvercle, Instruments non Inclus

Entregado con Tapa, Instrumentos no Incluidos

* For regulatory reason, please check with your distributor for availability in your country

* Por razones reglamentarias, por favor póngase en contacto con su distribuidor para conocer la disponibilidad en su país

Dr. Gossot Instrument Platform - Trays

Kit d'Instruments du Dr. Gossot - Paniers / Kit de Instrumentos del Dr. Gossot - Cestas

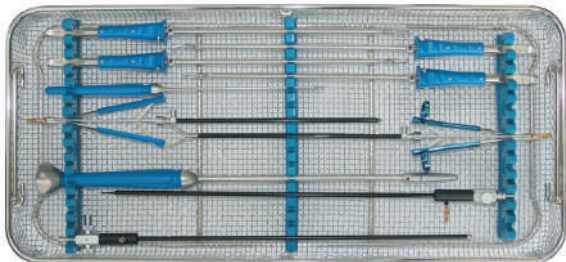

DC81903-00 *

540 x 250 x 70 mm

Provided with Lid, Instruments not Included

Livré avec Couvercle, Instruments non Inclus

Entregado con Tapa, Instrumentos no Incluidos

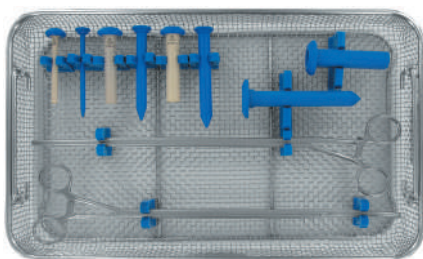

DC81904-00 *

405 x 250 x 70 mm

Provided with Lid, Instruments not Included

Livré avec Couvercle, Instruments non Inclus

Entregado con Tapa, Instrumentos no Incluidos

* For regulatory reason, please check with your distributor for availability in your country

* Por razones reglamentarias, por favor póngase en contacto con su distribuidor para conocer la disponibilidad en su país

MIS Instruments Trays Paniers Instruments MIS / Cestas Instrumentos MIS

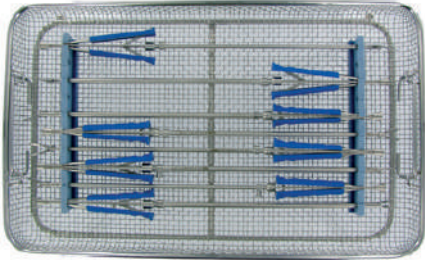

DC81901-00 *

405 x 250 x 50 mm

Provided without Lid, Instruments not Included

Livré sans Couvercle, Instruments non Inclus

Entregado sin Tapa, Instrumentos no Incluidos

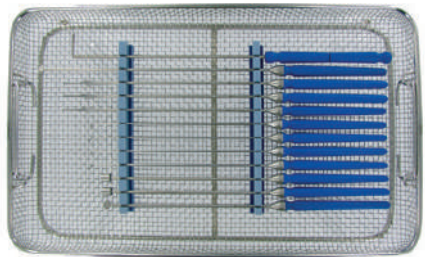

DC81902-00 *

405 x 250 x 50 mm

Provided without Lid, Instruments not Included

Livré sans Couvercle, Instruments non Inclus

Entregado sin Tapa, Instrumentos no Incluidos

* For regulatory reason, please check with your distributor for availability in your country

* Por razones reglamentarias, por favor póngase en contacto con su distribuidor para conocer la disponibilidad en su país

MidAccess Retractor Trays **Paniers Écarteur Mid Access / Cestas Separador Mid Access**

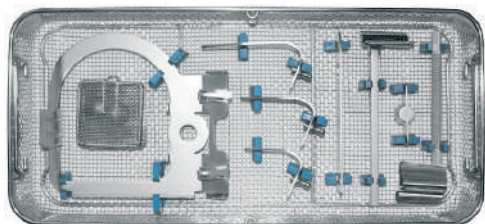

DC81907-00 *

540 x 250 x 70 mm

Provided with Lid, Instruments not Included

Livré avec Couvercle, Instruments non Inclus

Entregado con Tapa, Instrumentos no Incluidos

Yan Mini-Access Retractor Tray **Panier Écarteur Yan Mini-Access / Cesta Separador Yan Mini-Access**

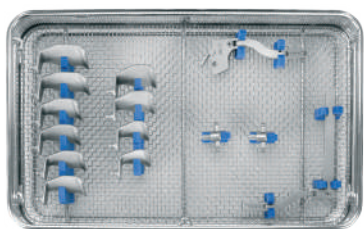

DC82169-00 *

**NEW
NOUVEAU
NUEVO**

405 x 250 x 70 mm

Provided with Lid, Instruments not Included

Livré avec Couvercle, Instruments non Inclus

Entregado con Tapa, Instrumentos no Incluidos

Sternal ThorAccess Retractor Tray Panier Écarteur Sternal ThorAccess / Cesta Separador Esternal ThorAccess

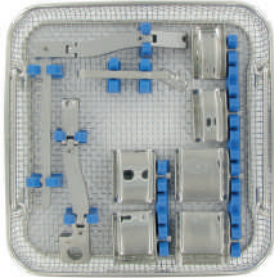

DC81908-00 *

250 x 250 x 50 mm

Provided with Lid, Instruments not Included

Livré avec Couvercle, Instruments non Inclus

Entregado con Tapa, Instrumentos no Incluidos

Full 3D Retractor Tray Panier Écarteur 3D Complet / Cesta Separador 3D Completo

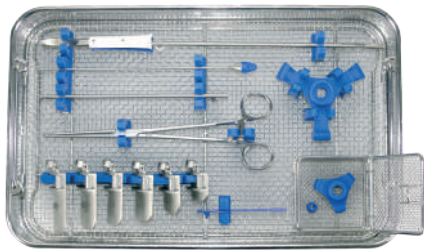

DC81914-00 *

NEW
NOUVEAU
NUEVO

405 x 250 x 70 mm

Provided with Lid, Instruments not Included

Livré avec Couvercle, Instruments non Inclus

Entregado con Tapa, Instrumentos no Incluidos

* For regulatory reason, please check with your distributor for availability in your country

* Por razones reglamentarias, por favor póngase en contacto con su distribuidor para conocer la disponibilidad en su país

Important notice

The content of this catalogue (including the trademarks, the texts, the drawings, illustrations, layouts, etc.) is, unless otherwise specified, the exclusive property of LANDANGER. It is not allowed to reproduce, represent, display, modify, adapt an/or translate - whether in part or in whole and whether for free or for financial consideration - the catalogue and/or any material composing the catalogue, without the prior and written consent of LANDANGER.

We can at any time recall the catalogue, in case that it has been not used according to our interests, i.e. sale or purchase of our products. We preserve the right for further steps in that case. Patterns are subject to change.

The instruments in this catalog are medical devices, CE marked, of classes I, IIa and IIb, manufactured by Landanger, ZI La Vendue, 52000 Chaumont, France .

Before any use, please read carefully the instructions on the label and / or the instructions and / or the technical sheet to ensure the correct use of the devices.

Document reserved for healthcare professionals.

Indications importantes

Le contenu de ce catalogue de vente (y compris les marques, les textes, les dessins, illustrations, présentations, etc.) est, sauf mention contraire, la propriété exclusive de la société LANDANGER. Toute reproduction, représentation, modification, adaptation, et/ou traduction de ce catalogue - qu'elle soit totale ou partielle, à titre gratuit ou onéreux - est interdite sans l'accord préalable écrit de la société LANDANGER.

Nous pouvons demander le retour du catalogue dans le cas où celui-ci n'est pas utilisé conformément à nos intérêts, pour la vente ou l'achat de nos produits. Dans ce cas nous nous réservons le droit de mener des actions juridiques.

Sous réserve des modifications techniques.

Les instruments présents dans ce catalogue sont des dispositifs médicaux, marqués CE, de classes I, IIa et IIb, fabriqués par Landanger, ZI La Vendue, 52000 Chaumont, France.

Avant toute utilisation, veuillez lire attentivement les instructions figurant sur l'étiquette et/ou la notice et/ou la fiche technique pour s'assurer de la correcte utilisation des dispositifs.

Dispositifs non pris en charge au titre des produits et prestations remboursable par la sécurité sociale.

Document réservé aux professionnels de santé.

Indicaciones importantes

El contenido de este catálogo (marcas, textos, dibujos, ilustraciones, presentaciones incluidos, etc.) es, excepto mención contraria, exclusiva propiedad de la empresa LANDANGER. Toda reproducción, representación, modificación, adaptación, y/o traducción de este catálogo - que sea total o parcial, gratuitamente o pagando - esta prohibida sin el acuerdo escrito de la empresa LANDANGER.

Podemos pedir el retorno del catálogo en caso de que este no sea usado conforme a nuestro interés, para la venta o la compra de nuestros productos. En aquel caso, nos reservamos el derecho de dirigir acciones jurídicas.

Bajo reserva de modificaciones técnicas.

Los instrumentos de este catálogo son dispositivos médicos, con marcado CE, de las clases I, IIa et IIb, fabricados por Landanger, ZI La Vendue, 52000 Chaumont, France .

Antes de cualquier uso, lea detenidamente las instrucciones en la etiqueta y / o las instrucciones y / o la hoja técnica para garantizar el uso correcto de los dispositivos.

Documento reservado para profesionales de la salud.

Intellectual Property - **Propriété Intellectuelle** - Propiedad Intelectual:

N° 002444083-0001, N° 001919895-002, N° 001919895-003, N° 003433846-0001, N° 2018 2372, N° 005501871-0001, N° 005501871-0002.

Patent Number - **Numéro de Brevet** - Número de Patente:

FR3010626.

Version 2020-11 - Catalogue de vente - ZA-B00007

Concept and design - **Conception et design** - Concepto y diseño : Copyright©LANDANGER - 2009 - 2021.

All rights reserved - **Tous droits réservés** - Todos derechos reservados.

The photos and pictures are not contractual - **Photos et illustrations non contractuelles** - Fotos e ilustraciones no contractuales.





Delacroix-Chevalier
Paris

Corporate Office - *Siège - Sede*

217 rue du Faubourg Saint-Honoré - 75008 Paris - France

Manufacturing and logistic - *Production et logistique - Fabricacion y logistica*

Rue Renée et Louis Landanger
52000 Chaumont - France

Phone : +33 (0) 3 25 02 10 35 - Fax : +33 (0) 3 25 02 10 20
Email : export@delacroix-chevalier.com www.delacroix-chevalier.com