

A3/A3C

Anesthesia system

Flexibility with Finesse





Anaesthesia applications are continually evolving, from traditional operating rooms to Non-Operating Room Anesthesia (NORA). A change in the clinical applications, locations coupled with diverse patient populations and procedures these have generated new demands from clinicians and anesthesia systems. The brand-new A3/A3C anesthesia system from Mindray offers flexibility to adapt to various clinical applications, provides precise anesthesia management tools, and facilitates lean workflow practices, thereby helping to enhance the quality and efficiency of anesthesia care.



Full-featured for professional care



Highly adaptable for diverse scenarios



Stay together for better efficiency

Full-featured for professional care

Electronic flow measurement as essential

Electronic flow measurement with the virtual flowmeter on main screen has been introduced by A3/A3C as an essential to ensure precise anesthesia management, which can realize accurate and fast setting of O₂ concentration and flow of fresh gas.



Intuitive and customizable user interface

12.1" high resolution touchscreen enables a maximum of 3 ventilation waveforms (etCO₂, Anesthetic Agent, Pressure, Flow & Volume as optional), and Spirometry Loop to display at the same time, and the screen contents can be configured due to individualized procedures.



12.1 inch capacitive touchscreen



1280X800 HD



10 customized profiles



Graphical instruction



High Flow Nasal Cannula

High flow nasal cannula (HFNC) is proven to improve oxygenation and wash out dead space to better prepare for intubation and support extubation.

- Direct setting O₂ flow with maximum flow up to 60L/min
- Built-in design with no additional gas or power source required, saving space and minimizing clutter



Precise and individualized ventilation

The A3/A3C supports a full range of controlled and support modes of ventilation and with dynamic tidal volume compensation, support Tve as low as 10ml(5ml for PCV-VG), is suitable for all patient categories from neonates to adult.

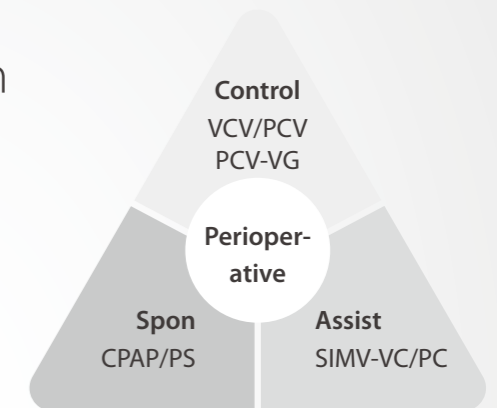

PnP Multi-Gas Module

With improved single slot CO₂ module or double slot anesthetic agent capability the Mindray Plug-and-Play Multi-Gas modules provide comprehensive breath-by-breath analysis of Fi/EtO₂, Et/FiCO₂, Et/Fi N₂O, auto-detection of five anesthetic agents.



Easy for maintenance

- Integrated compact breathing system with heating module to reduce water condensation, and support tool-free to disassemble with few parts
- Compatible with both reusable and disposable soda lime canisters, ease to replace the absorbent
- All parts are autoclavable, preventing cross-infection
- FlowSecure™ ensures accuracy of flow sensors with a long service life



Highly adaptable for diverse scenarios

Extend application scenarios from central operating room to Non-Operating Room Anesthesia (NORA) with multi-forms adaption.

Multi forms adaptive to different scenarios



Standard Version

Pendant Version

Compact Version

Wall-mount version

More options for gas supply

Beyond its flexible form, the A3/A3C anesthesia system can also adapt to different gas source conditions. The ventilator can be operated normally even under limited gas supply conditions.

Optional Driven Gas Auto-switch

When the primary gas supply fails, Auto-switch function can switch the driven gas supply to the back-up gas resource automatically, to ensure the safe mechanical ventilation at all times.

Optional built-in turbine module

Flexible and alternative to configure built-in turbine as driven gas supply when high-pressure gas supply is not available.

Optional internal air supply module

Optional internal air supply module serves as backup air for fresh gas to ensure safe ventilation when high-pressure air supply fails.



Stay together for better efficiency

Overview of patient status in each operating room

Through IT solutions, enabling remote monitoring of patient status in real-time across all operating rooms and detail information of one OR.

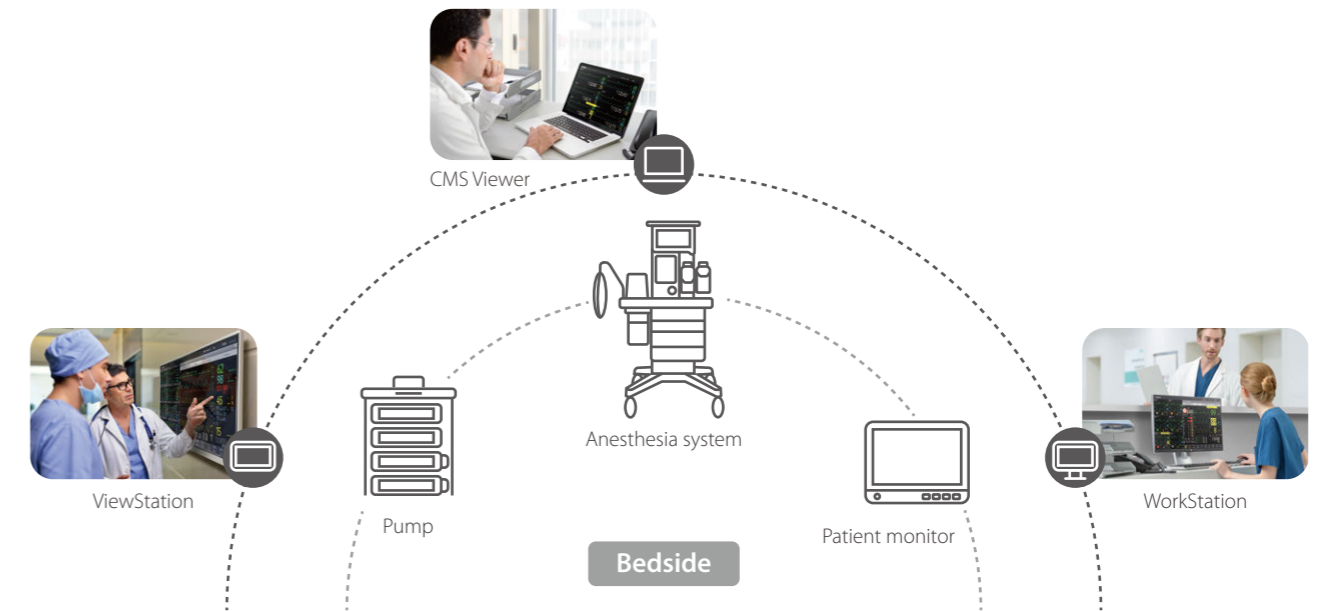

Overview of the operational status of devices

- Overview of anesthesia machine distribution and utilization
- Summary of anesthesia machine self-test results

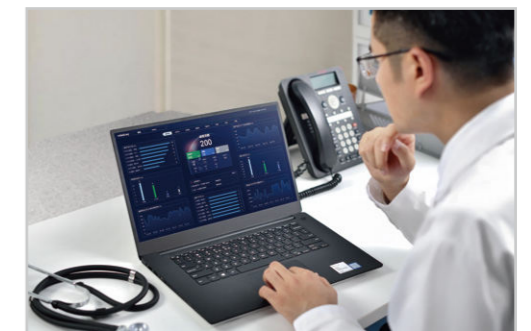

Not all features are for sale in all countries.

A3

Anesthesia system

Physical Specifications

Dimensions and Weight of Standard Version

Height	1410 mm
Width	762 mm
Depth	767 mm
Weight	≤110 kg (with 3 yokes, without vaporizers and gas cylinders)

Dimensions and Weight of Pendant Version

Height	1169 mm
Width	745 mm
Depth	827 mm
Weight	≤135 kg (with 1 yoke and Pendant adapter, without vaporizers and gas cylinders)

Dimensions and Weight of Compact Version

Height	1410 mm
Width	775 mm
Depth	659 mm
Weight	≤90 kg (with 3 yokes, without vaporizers and gas cylinders)

Dimensions and Weight of Wall Mount Version

Height	1095 mm
Width	765 mm
Depth	630 mm
Weight	≤115 kg (with wall mount adapter, without vaporizers and gas cylinders)

Work Surface of Standard Version

Height	827 mm
Width	430 mm
Depth	345 mm
Weight limit	30 kg

Flip-up Work Surface

Length	379 mm
Width	303 mm
Weight limit	15 kg

Drawer (2 or 3 drawers, Internal Dimension) of Standard and Pendant Version

Height	123 mm/ 72 mm
Width	275 mm
Depth	340 mm
Weight limit	5 kg

Storage Basket of Wall Mount and Compact Version

Height	78 mm
Width	398 mm
Depth	200 mm
Weight limit	2.5 kg

Bag Arm

Height	1108 mm
Length	510 mm
Swiveling angle	±90 degrees

Casters

Diameter	125 mm
Brake	All four casters with brakes

Work Light

Settings	OFF, Low, High
----------	----------------

Main Screen

Display size	12.1 inch
--------------	-----------



Display type	Capacitive touch screen
Resolution	1280x 800
Display parameters	All setting and alarm parameters (including Breath rate, I/E ratio, Tidal volume, Minute volume, PEEP, MEAN, PEAK, PLAT, and O ₂ concentration, EtCO ₂ , N ₂ O, Anesthesia gas concentration)
Graphic waveforms	Pressure, Flow, Volume, CO ₂ , O ₂ , Anesthetic gas, N ₂ O Up to 3 waveforms display simultaneously
Spirometry loops	Pressure-Volume, Flow-Volume and Pressure-Flow
Timer	Display on screen timer

Ventilator Specifications

Modes of Ventilation

Manual/Spontaneous ventilation/CPB
Volume Control Ventilation (VCV) with PLV function
Pressure Control Ventilation (PCV)
Pressure Control Ventilation with volume guarantee (PCV-VG)
Continuous Positive Airway Pressure/Pressure Support Ventilation with apnea backup (CPAP/PS)
Pressure Support Ventilation (PS) with apnea backup
Synchronized Intermittent Mandatory Ventilation (SIMV-Volume Controlled and SIMV-Pressure Controlled)

Compensation

Circuit gas leakage compensation and automatic compliance compensation

Ventilation Parameters Range

Tidal volume	10 to 1500 mL (VCV, SIMV-VC) 5 to 1500 mL (PCV-VG) With TV/IBW indicator
Pinsp	3 to 80 cmH ₂ O
Plimit	10 to 100 cmH ₂ O
ΔPsupp	0, 3 to 60 cmH ₂ O (CPAP/PS)
Respiration rate	2 to 100 bpm
I:E	4:1 to 1:10

Tpause	OFF, 5% to 60%
Tinsp	0.2 to 10.0 s
Trigger window	5% to 90%
Flow trigger	0.2 to 15 L/min
Pressure trigger	-20 to -1 cmH ₂ O
Exp%	5% to 80%
Min rate	2 to 60 bpm
Tslope	0.0 to 2.0 s
Apnea I: E	4:1 to 1:10
ΔPapnea	3 to 60 cmH ₂ O
Positive End Expiratory Pressure (PEEP)	
Type	Integrated, electronic controlled
Range	OFF, 2 to 50 cmH ₂ O
Monitoring Parameters	
Tidal volume	0 to 3000 ml
Minute volume	0 to 100 L/min
Peak pressure	-20 to 120 cmH ₂ O
Mean pressure	-20 to 120 cmH ₂ O
Plateau pressure	-20 to 120 cmH ₂ O
I:E	50:1 to 1:50
Rate	0 to 150 bpm
PEEP	0 to 70 cmH ₂ O
Delta Tidal volume	0 to 3000 ml
Minute volume leakage	0 to 10.0 L/min
Resistance (R)	0 to 600 cmH ₂ O/(L/s)
Compliance (C)	0 to 300 ml/cmH ₂ O
Inspired oxygen (FiO ₂)	18% to 100%
Control Accuracy	
Volume delivery	≤60 ml: ± 10 ml >60 ml and ≤ 210 ml: ±15 ml >210 ml: ±7 % of the set value
Pressure delivery	± 2.5 cmH ₂ O or ± 7% of the set value, whichever is greater
PEEP	± 2.0 cmH ₂ O or ± 7% of the set value, whichever is greater
Rate	± 1bpm or ± 10% of the reading, whichever is greater
Monitoring Accuracy	
Volume monitoring	≤60 mL: ± 10 mL >60 and ≤210 mL: ± 15 mL >210 mL: ± 7% of the reading
Pressure monitoring	± 2.0 cmH ₂ O or ± 4% of the reading, whichever is greater
Rate	± 1bpm or ± 5% of the reading, whichever is greater
MV	± 0.1L/min or ± 8% of the reading, whichever is greater
Alarm Setting	
Paw High	2 to 100 cmH ₂ O
Paw Low	0 to 98 cmH ₂ O
TV High	5 to 1600 mL
TV Low	OFF, 0 to 1595 mL
MV High	0.2 to 100 L/min
MV Low	0 to 99 L/min
Rate High	4 to 100 bpm, OFF
Rate Low	OFF, 2 to 98 bpm
FiO ₂ High	20% to 100%, OFF
FiO ₂ Low	18% to 98 %
Apnea alarm	No breath has been detected within the apnea time.
Apnea delay time	5 to 60 s (by volume or pressure) 10 to 40 s (by CO ₂ waveform)
Data Storage and Recording	
Configuration storage	up to 10 customized profiles
Log storage	10000 entries of alarm and activity logs
History trend	48 hours of continuous trend data

Screenshot up to 50

Pneumatic Specifications

Pipeline Supply

Gas type	O ₂ , N ₂ O and Air
Pipeline input range	280 to 600 kPa (40 to 87 psi)
Pipeline connections	DISS or NIST

Pipeline Supply Pressure Monitoring

Display type	Mechanical or Electronic
Ranges	0 to 1000kPa (0 to 140 psi)
Accuracy	± (4% of the full scale reading + 8% of the actual reading)

Cylinder Supply

Cylinder supply	E Cylinder (American style or UK style)
O ₂ input range	6.9 to 20 MPa (1000 to 2900 psi)
N ₂ O input range	4.2 to 6 MPa (600 to 870 psi)
Air input range	6.9 to 20 MPa (1000 to 2900 psi)
Cylinder connections	Pin-Index Safety System (PISS)
Yoke configuration	O ₂ , N ₂ O, Air

Cylinder Supply Pressure Gauges

Display type	Mechanical or Electronic
Air range	0 to 25 MPa (0 to 3500 psi)
O ₂ range	0 to 25 MPa (0 to 3500 psi)
N ₂ O range	0 to 10 MPa (0 to 1400 psi)
Accuracy	± (4% of the full scale reading+8% of the actual reading)

Ventilator Performance

Peak gas flow	180 L/min + Fresh Gas Flow
---------------	----------------------------

O₂ Controls

Supply failure alarm	≤ 220 kPa
----------------------	-----------

ACGO (Auxiliary Common Gas Outlet)

Control type	Mechanical
Safety pressure	A relief valve limits fresh gas pressure at ACGO outlet port to not more than 12.5 kPa

O₂ Flush

Flow rate	25 to 75 L/min
-----------	----------------

Auxiliary Flowmeter (2 options)

Auxiliary O ₂ Flowmeter		
Range		0 ~ 15 L/min
Indicator		Flow tube

High Flow Nasal Cannula

Flow range	0 to 60 L/min
Indicator	Flow tube

Anesthetic Gas Scavenging System (AGSS)

Type of disposal system	Passive
	Active: High-flow or low-flow
Pump rate	75 to 105 L/min (High-flow) 25 to 50 L/min (Low-flow)

Venturi Suction Regulator

Supply	Air, from system gas source
Gas supply range	280 to 600 kPa
Maximum vacuum	≥50 kPa
Maximum flow	≥25 L/min

Continuous Suction Regulator

Supply	External vacuum
Gas supply range	-72 to -40 kPa
Maximum vacuum	≥ 65 kPa with external vacuum applied of 72 kPa
Maximum flow	≥ 40 L/min with external vacuum applied of 72 kPa

Electronic Flow Meters

O ₂ flow range	0 to 15 L/min
Air flow range	0 to 15 L/min
N ₂ O flow range	0 to 12 L/min

Accuracy ± 10% of the indicated value or ± 0.12L/min, whichever is greater
O2 concentration range in the O2/N2O mixed gas: ≥ 25%

Breathing System Specification

Breathing system volume

Automatic ventilation 1800 ml
Manual ventilation 1950 ml

CO₂ Absorber Assembly

Absorber capacity 1500 ml
Absorber type 1 Pre-Pak canister or Loose fill absorbent

Inspiratory Airway Pressure Gauge

Range -20 to 100 cmH₂O
Accuracy ± (2% of the full scale reading + 4% of the actual reading)

Flow Sensor

Type Variable orifice flow sensor
Location Inspiratory and expiratory port

Oxygen Sensor

Type Galvanic fuel cell
FiO₂ displayed 18% to 100%
Accuracy ± (volume fraction of 2.5 % +2.5 % gas level)
Response time < 20 seconds

Breathing System Connectors

Exhalation 22 mm OD / 15 mm ID conical
Inhalation 22 mm OD /15 mm ID conical
Manual bag port 22 mm OD /15 mm ID conical

Bag-to-Ventilator Switch

Type Bi-stable
Control Switch between manual and mechanical ventilation

Adjustable Pressure Limiting (APL) Valve

Type Manually control with quick relief function
Range Approximately 0 (SP), 5 to 70 cmH₂O
Tactile knob indication ≥ 30 cmH₂O

Breathing Circuit Parameters

System compliance ≤ 2 mL/cmH₂O in manual ventilation
Automatically compensates for compression losses within the breathing circuit in automatic ventilation mode
Expiration resistance < 6.0 cm H₂O @60 L/min
Inspiration resistance < 6.0 cm H₂O @60 L/min
Leakage ≤ 50 mL @ 3 kPa
System safety pressure on patient circuit 110 ± 10 cmH₂O

Breathing System Temperature Controller

Breathing system temperature maintained at least 31°C typical at 20°C ambient temperature in normal condition

Materials

All materials in contact with exhaled patient gases are autoclavable up to a maximum temperature of 134°C, except O₂ sensor and mechanical pressure gauge.
All materials in contact with patient gas are latex free.

Vaporizers

Anesthetic agent delivery

Vaporizer Mindray V60/V80 Anesthetic Vaporizer
Support agents Halothane, Isoflurane, Sevoflurane, Desflurane
Position Max.3 positisons (2 active, 1 inactive)
Mounting mode Selectatec®, with interlocking function

Monitor Modules

Side-stream CO₂ Module

CO₂ Measurement range 0 ~ 152 mmHg (0 to 20%)

CO₂ Accuracy ±2 mmHg (0 ~ 40 mmHg)
± 5% of the real reading (41 ~ 76 mmHg)
± 10% of the real reading (77 ~152 mmHg)

CO₂ Resolution 1 mmHg
O₂ Measurement range 0 to 100%

O₂ Accuracy ±1% (V/V) (0 ~ 25%)
±2% (V/V) (25 ~ 80%)
±3% (V/V) (80 ~ 100%)

O₂ Resolution 1%
Pump rate Neonatal: 100 mL/min or 120 mL/min
Adult/Pediatric: 120 mL/min or 150 mL/min
Response time <4.5 s@100 mL/min; <4.5 s@120 mL/min
<5 s@120 mL/min; <5 s@150 mL/min

Anesthesia Gas (AG) Module

Measurement mode Infrared absorption, side-stream
Monitor gases CO₂, O₂ (Paramagnetic O₂ module), N₂O, and any of the five anesthetic agents: DES, ISO, ENF, SEV and HAL
Warm-up time <45 s (ISO accuracy mode)
<10min (full accuracy mode)
Sample rate Adu/Ped: 150, 180, 200 ml/min
Neo: 100, 110, 120 ml/min
Monitoring range CO₂: 0 to 30% (0.0 to 226mmHg)
O₂/N₂O: 0 to 100%
HAL, ISO, ENF: 0 to 30%
SEV: 0 to 30%
DES: 0 to 30%

Electrical Specifications

Main Electrical Power

Power input 220-240 V~, 50/60 Hz, 8A max
100-240 V~, 50/60 Hz, 8A max
Power consumption OFF mode: <4W
Standby mode: <40W
Active mode: <45W (under typical condition)
Maximum: <80W
Power cord 5 m (length)

Battery Power

Battery type Li-ion, 10.8VDC, 5.2Ah per battery
Run-time One new battery: minimum 120 minutes under typical operating conditions
Two new batteries: minimum 240 minutes under typical operating conditions

Battery charge time ≤ 8 hours
Time to shut down from the first Lower Battery Alarm 5 minutes minimum (new fully-charged battery)
Safety feature in case of electricity and battery failure, manual ventilation, gas delivery and agent delivery are possible

Auxiliary Electrical Outlets

Number of outlets 2 or 3
Output current 3 A max. for each outlet, 5 A max. for total

Communication Port

Communication port RS-232 compatible serial interface
LAN port RJ-45 network port
USB port 2 USB ports
Video signal port HDMI port for inputting the video signal of the main to external display

Environmental Specifications

Operating

Temperature 10 to 40°C

Relative humidity 15 to 95% (noncondensing)
Barometric 70 to 106.7 kPa
Storage
Temperature -20 to 60°C for main unit,
-20 to 50°C for O₂ sensor
Relative humidity 10 to 95% (noncondensing)
Barometric 50 to 106.7 kPa
Resistance to Ingress of Fluids

Complies with the requirements of clause 11.6.3 in IEC 60601-1 and also the requirements in IEC 60529 for protection against vertically falling water drops equipment (IPX1)

Not all features are for sale in all countries.
Please contact your local Mindray sales representative for the most current information.

A3

Anesthesia System

Operator's Manual





© 2024 Shenzhen Mindray Bio-Medical Electronics Co., Ltd. All rights Reserved. For this Operator's Manual, the issue date is March, 2024.

Intellectual Property Statement

SHENZHEN MINDRAY BIO-MEDICAL ELECTRONICS CO., LTD. (hereinafter called Mindray) owns the intellectual property rights to this Mindray product and this manual. This manual may refer to information protected by copyright or patents and does not convey any license under the patent rights or copyright of Mindray, or of others.

Mindray intends to maintain the contents of this manual as confidential information. Disclosure of the information in this manual in any manner whatsoever without the written permission of Mindray is strictly forbidden. Release, amendment, reproduction, distribution, rental, adaptation, translation or any other derivative work of this manual in any manner whatsoever without the written permission of Mindray is strictly forbidden.

  and **MINDRAY** are the trademarks, registered or otherwise, of Mindray in China and other countries. All other trademarks that appear in this manual are used only for informational or editorial purposes. They are the property of their respective owners.

Responsibility on the Manufacturer Party

Contents of this manual are subject to change without prior notice.

All information contained in this manual is believed to be correct. Mindray shall not be liable for errors contained herein or for incidental or consequential damages in connection with the furnishing, performance, or use of this manual.

Mindray is responsible for the effects on safety, reliability and performance of this product, only if:

- all installation operations, expansions, changes, modifications and repairs of this product are conducted by Mindray authorized personnel;
- the electrical installation of the relevant room complies with the applicable national and local requirements; and
- the product is used in accordance with the instructions for use.

WARNING: It is important for the hospital or organization that employs this equipment to carry out a reasonable service/maintenance plan. Neglect of this may result in machine breakdown or personal injury.

NOTE: This equipment must be operated by skilled/trained clinical professionals.

1.1.3 Notes

- NOTE:** Figures in this manual are provided for reference purposes only. Screens may differ based on the system configuration and selected parameters.
- NOTE:** Put the equipment in a location where you can easily see the screen and access the operating controls.
- NOTE:** Keep this manual close to the equipment so that it can be obtained conveniently when needed.
- NOTE:** The software was developed in compliance with IEC 60601-1. The possibility of hazards arising from software errors is minimized.
- NOTE:** This manual describes all features and options. Your equipment may not have all of them.
- NOTE:** The equipment is intended to be operated with its integral Breathing Pressure monitoring in use.
- NOTE:** The equipment is intended to be operated with its integral Breathing Pressure limiting devices in use.
- NOTE:** The equipment is intended to be operated with its integral Expiratory Volume monitoring in use.
- NOTE:** The equipment is intended to be operated with its integral Breathing System integrity Alarm System in use.
- NOTE:** The equipment is intended to be operated with its integral Continuous Pressure Alarm in use.
- NOTE:** The equipment is intended to be operated with its integral O₂ monitoring in use.
- NOTE:** An Anesthesia Vapor Delivery Device is to be used with an Anesthetic Agent Monitor complying with ISO 80601-2-55. The connection of Patient Circuit and Agent monitor should be made by a sample line.
- NOTE:** Continuously monitor the anesthetic agent concentration when using the anesthesia system to ensure accurate output of the anesthetic agent.
- NOTE:** Check the liquid level of the anesthetic agent before and during all operations. When the liquid level is below the warning line, more anesthetic agent needs to be added. Refer to the vaporizer Instructions For Use for filling the vaporizer and other information.
- NOTE:** The system is designed to be equipped with an anesthetic vapor delivery device that complies with ISO 80601-2-13.
- NOTE:** The battery supply of this equipment is not a user serviceable component. Only an authorized service representative can replace the battery supply. If the system is not used for a long time, contact a service representative to have the battery supply disconnected. The disposal of battery should comply with local regulations. At the end of the battery life, dispose of the battery supply in accordance with local regulations.
- NOTE:** Areas designated for the servicing of oxygen equipment shall be clean, free of oil and grease, and not be used for the repair of other equipment.

4. The breathing system is correctly connected, the breathing tubes are undamaged. The self-inflating manual ventilation device is available and functioning.
5. The gas supply system has been connected and the pressure is normal.
6. The necessary emergency equipment is available and in good condition.
7. Equipment for airway maintenance and tracheal intubation is available and in good condition.
8. Inspect the color of the soda lime in the canister. Replace the soda lime immediately if obvious color change is detected.
9. Applicable anesthetic and emergency drugs are available.
10. The casters are not damaged or loose, the brake(s) is set and prevents movement.
11. Ensure that the breathing system is in proper position.
12. The AC mains indicator turns on when the power cord is connected to the AC power source. If the indicators are not displayed, the system does not have electrical power.
13. The anesthesia system can be switched on or off normally.
14. Check if the O₂ flush button is functioning properly.

5.4 System Check

1. When the system is turned on, it automatically initiates the Power On Self Test (POST). After the POST is over, the system check screen is displayed. Follow the instructions on the Main Screen for operations.
2. Select the [**Continue**] key and the system starts the check.
3. Select [**Test Details**] to view the test results of each test item.
4. Proceed to standby or troubleshoot the equipment based on the test results.
5. After the system check is over, the preoperative check screen is displayed. Perform desired preoperative checks as per the prompts on the screen.

SYSTEM CHECK ITEMS	DESCRIPTION	NOTE
1 Startup	When the system is turned on, it performs a self-test to ensure its alarm system (buzzer) and hardware are functioning properly.	Confirm that the buzzer plays the check sound when the power on self test is started. Otherwise, stop using the anesthesia system and contact your service personnel or Mindray.
2 System Check	Perform leak and compliance tests. Check the hardware, valves, sensors, flowmeters, gas supplies, power supplies and modules.	
3 Preoperative Check List	Display the checks to be performed before operating the system.	

TABLE 5-1 System Check

5.4.1 Leak and Compliance Test

2. Touch the waveform zone on the screen or turn on the fresh gas, or select the **[Start Case]** key, and follow the on-screen prompts to exit standby mode.

6.3.2 Set Patient Information

See section 4.2 (Pages 4-4) "Patient Information Field".

6.4 O₂ Sensor Calibration

If O₂ sensor calibration is needed, please see section 12.4 (Pages 12-4) "O2 Sensor Calibration".

6.5 Set Fresh Gas

6.5.1 Set O₂, N₂O and Air Inputs

You can set the O₂, N₂O and air flow in the fresh gas through the O₂, N₂O and air flow control knobs. The corresponding electronic flowmeter on the screen displays the reading of the gas flow. The total flowmeter displays the total flow of mixed gases.

Ensure that the O₂ and N₂O flow control knobs are fully closed (clockwise) at the beginning and end of each ventilation cycle.

When adjusting the N₂O and O₂ flow rates, always adjust the O₂ flow rate before adjusting the N₂O flow rate. When increasing N₂O to the fresh gas, make sure to first open the O₂ flowmeter valve before opening the N₂O flowmeter valve.

Auto cut-off of N₂O:

When the O₂ pressure is lower than the threshold, N₂O is automatically cut off to zero the N₂O flow rate.

O₂ pressure loss alarm:

When the O₂ pressure is lower than 220 kPa (32 psi), the O₂ pressure failure alarm is triggered.

O₂ ratio controller:

The O₂ ratio controller ensures that the O₂ concentration in the fresh gas is always not lower than 25% when the N₂O valve is fully opened.

NOTE: The float flowmeter is calibrated based on 100% O₂. For other gas, the accuracy of the flowmeter may degrade.

NOTE: When checking the readings on the float flowmeter, keep the visual angle at the same level of the float. The reading of the scale may vary when viewed at a different angle.

NOTE: If the readings shown on the electronic flowmeters differ from that on the total flowmeter, the electronic flowmeter will prevail and the total flowmeter is an approximate value.

6.5.2 Set Anesthetic Agent

NOTE: You do not need to perform this operation if inspiratory anesthetic agent is not used.

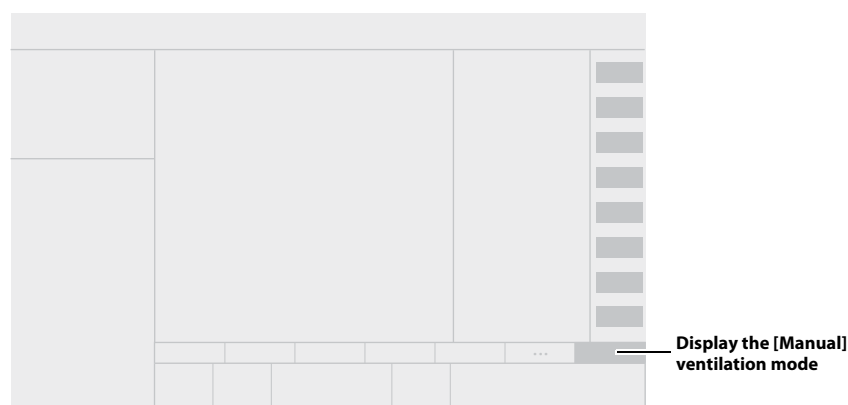

FIGURE 6-3 Manual Ventilation Mode Tab

Set the APL Valve for Manual Ventilation

Rotate the APL valve adjustment knob to the desired pressure. The number on the knob that lines up with the index mark on the bottom section of the valve indicates the approximate pressure setting.

NOTE: Clockwise rotation increases the pressure, and counterclockwise rotation decreases the pressure.

The patient can be ventilated manually using the breathing bag. The pressure will be limited to the value set on the APL valve.

Set the APL Valve for Spontaneous Breathing

Rotate the APL valve adjustment knob fully counter clockwise until the SP marking on the knob lines up with the index mark on the bottom section of the valve. The valve will then be open for the patient to breathe spontaneously.

NOTE: In the manual ventilation mode, you can use the APL valve to adjust the pressure limit of breathing system and gas volume in the manual bag. When the pressure in the breathing system reaches the pressure limit set for the APL valve, the valve opens to release excess gas.

NOTE: The APL valve adjusts the breathing system pressure limit during manual ventilation. Its scale shows approximate pressure.

Set Alarms

In the manual ventilation mode, when the **[Alarms]** key is set to **[Off]**, the pressure, volume and apnea alarms are disabled, and the related alarm limits will be displayed as **[Off]**. Pressure, volume and apnea alarms can be turned on by setting the **[Alarms]** button key to **[On]**. The related alarm limits will be restored to their original settings.

Set CO₂ Alarms

In the manual ventilation mode, the CO₂ and the CO₂ apnea alarms can be turned off by setting the **[CO₂ Alarms]** soft key to **[Off]**, and the related alarm limits will be displayed as **[Off]**. The **[CO₂ and CO₂ Apnea Alarms are OFF]** prompt will be displayed in the alarm area. The CO₂ and the CO₂ apnea alarms can be turned on by setting the **[CO₂ Alarms]** key to **[On]** by turning the Auto/Manual Switch to the Auto position. The related alarm limits will be restored to their original settings.

8.1 Introduction

The anesthetic gas (AG) module measures the patient's anesthetic and respiratory gases, and incorporates the features of the O₂ module as well.

The AG (anesthesia gas) module determines the concentrations of certain gases using the infrared (IR) light absorption measurement. The gases that can be measured by the AG module absorb IR light. Each gas has its own absorption characteristic. The gas is transported into a sample cell, and an optical IR filter selects a specific band of IR light to pass through the gas. For multiple gas measurement, there are multiple IR filters. This means that higher concentration of IR absorbing gas causes a lower transmission of IR light. From the amount of IR light measured, the concentration of gas present can be calculated.

Oxygen does not absorb IR light as other breathing gases and is therefore measured relying on its paramagnetic properties. Inside the O₂ sensor are two nitrogen-filled glass spheres hung on a torsion device in a symmetrical magnetic field. This assembly is suspended in a symmetrical non-uniform magnetic field. In the presence of paramagnetic oxygen, the glass spheres are pushed further away from the strongest part of the magnetic field. The strength of the torque acting on the suspension is proportional to the oxygen concentration. From the strength of the torque, the concentration of oxygen is calculated.

AG measurement provides:

1. Waveforms: CO₂, N₂O, O₂ and AA waveforms.
2. Measurement parameters: EtCO₂, FiCO₂, EtN₂O, FiN₂O, FiO₂, EtO₂, EtAA, FiAA and MAC.

Specifically, AA stands for any of the following anesthetic agents: Des (Desflurane), Iso (Isoflurane), Enf (Enflurane), Sev (Sevoflurane), or Hal (Halothane).

The rated respiration rate for AG module is 2 to 100 bpm. The data sample rate is 25 Hz. The peak value of the CO₂ waveform in the corresponding breathing cycle applies as the EtCO₂ gas reading. The peak value of the O₂ waveform in the corresponding breathing cycle applies as the O₂ gas reading. The EtN₂O and EtAA values at the time of the recorded CO₂ waveform apply as the EtN₂O and EtAA gas readings.

8.2 MAC Values

The minimum alveolar concentration (hereinafter referred to as MAC) can be displayed on the screen when the anesthesia system is configured with external AG module.

MAC is a basic index indicating the depth of inhaled anesthesia. The ISO 80601-2-55 defines MAC as follows: alveolar concentration of an inhaled anesthetic agent that, in the absence of other anesthetic agents and at equilibrium, prevents 50% of subjects from moving in response to a standard surgical stimulus.

The following table lists 1 MAC of various inhaled anesthetic agents.

Anesthetic agent	Des	Iso	Enf	Sev	Hal	N ₂ O
1 MAC	6.65 %	1.15 %	1.70 %	2.10 %	0.77 %	105%*

* 1 MAC of nitrous oxide can only be reached in a hyperbaric chamber.

TABLE 8-1 1 MAC of Various Inhaled Anesthetic Agents

NOTE: The data shown in this table are from ISO 80601-2-55, which are published by the U.S. Food and Drug Administration for a healthy 40-year-old male patient.

NOTE: In actual applications, although the gas module accounts for patient age, the effects of weight and other factors on the inhaled anesthetic agent should be considered.

When one or more anesthetic agents are used, the formula for calculating MAC is as follows:

$$MAC = \sum_{i=0}^{N-1} \frac{EtAgent_i}{AgentVol_{age}^i}$$

Where, N stands for the number of all anesthetic agents (including N₂O) which the AG module can measure, EtAgent_i stands for the end-tidal concentration of each kind of inhaled anesthetic agent, and AgentVol_{age}ⁱ stands for the 1 MAC value corresponding to the each kind of inhaled anesthetic agent after age correction.

The formula for calculating age correction of 1 MAC is as follows:

$$MAC_{age} = MAC_{40} \times 10^{(-0.00269 \times (age-40))}$$

NOTE: The formula above is only available for patients who are older than one year old. If the patient is less than one year old, the system will use one year old to do age correction.

For example, the AG module measures that a 60-year-old patient's end-expiratory concentrations of Iso is 0.9% and that of N₂O is 50%. Based on the above age correction formula, the 1 MAC value of Iso is 1.01% and that of N₂O is 92.7% for the 60-year-old patient, and the MAC value is:

$$MAC = \frac{0.9\%}{1.01\%} + \frac{50\%}{92.7\%} = 1.4$$

8.3 Agent Usage Calculation





CAUTION: The Agent Usage Calculation feature is intended for management purposes only and shall not be used as a basis for clinical decision-making.

The agent usage is displayed on the standby screen. The agent usage accumulates from 0 when the anesthesia system exits the standby mode. When the anesthesia system enters standby, the agent usage stops accumulating.

XX	2022-10-09	4:33:07PM	Displays the start time of anesthetic agent consumption
XX	2022-10-09	4:33:13PM	Displays the end time of anesthetic agent consumption
XX	70.83L		Displays consumption volume of gas and anesthetic agent and anesthetic agent consumption cost
XX	63.75L		
XX	0.00L		
XX	0.1L	\$10	

图 8-1 Agent Usage Calculation

Enable or disable the Agent Usage Calculation feature following the steps below:

1. Select the  key > **[System]** key (system password needed) > **[Setup]** > **[Optimizer]** tab.
2. The **[Agent Usage]** can be set to  (off) or  (on). If the **[Agent Usage]** is set to  (off), no agent usage data is displayed on the Main Screen. If the **[Agent Usage]** is set to  (on), the agent usage is displayed on the Main Screen.

8.4 Agent Consumption Speed

CAUTION: The Agent Consumption Rate feature is intended for management purposes only and shall not be used as a basis for clinical decision-making.

The anesthesia system supports calculation of the agent consumption speed and cost.

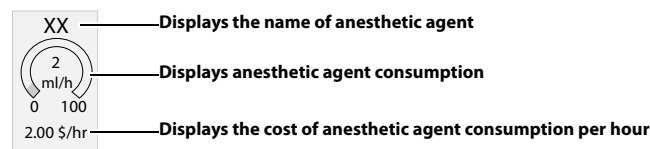









FIGURE 8-2 Agent Consumption Speed



Enable or disable the Agent Consumption Rate feature following the steps below:

1. Select the  key > **[System]** key (system password needed) > **[Setup]** > **[Optimizer]** tab.
2. The **[Agent Usage]** can be set to  (off) or  (on). If the **[Agent Usage]** is set to  (off), no agent consumption speed is displayed on the Main Screen. If the **[Agent Usage]** is set to  (on), the agent consumption speed is displayed on the Main Screen.
3. Set the cost of anesthetic agent per ml. When the **[Agent Usage]** is set to  (on), the cost of used agent is displayed on the Main Screen.



8.7.5 Set O₂ Scale

1. Select the  key > [AG] tab.
2. Select the [O₂ Scale] tab.
3. Choose the appropriate scale.
4. Select  to close the dialog box and confirm the changes.



8.7.6 Set N₂O Scale

1. Select the  key > [AG] tab.
2. Select the [N₂O Scale] tab.
3. Choose the appropriate scale.
4. Select  to close the dialog box and confirm the changes.

8.7.7 Set AA Scale

1. Select the  key > [AG] tab.
2. Select the [AA Scale] key. Specifically, AA stands for any of the following anesthetic agents: Des (Desflurane), Iso (Isoflurane), Enf (Enflurane), Sev (Sevoflurane), or Hal (Halothane).
3. Choose the appropriate scale.
4. Select  to close the dialog box and confirm the changes.

8.7.8 Set Types of Agent

1. Select the  key > [System] key (system password needed) > [Setup] > [AG] tab.
2. Select the [Types of Agent] tab.
3. Select the appropriate anesthetic agent. The system will automatically identify related types of anesthetic agent based on the settings.
4. Select  to close the dialog box and confirm the changes.

8.7.9 Set Alarm Limits

You can set the high and low alarm limits of N₂O, CO₂, O₂ and agents to keep alarm conditions consistent with patient needs. The alarm is then triggered when the parameter value is greater than the High Limit or lower than the Low Limit.

NOTE: When using the anesthesia system, ensure that the alarm limits of each parameter are set to the appropriate values for the patient.

1. On the Main Screen, select the [Alarms] soft key > [Agents] tab.
Or, select the monitoring area to display the alarm limits settings menu.
2. Select a parameter key that needs to be changed.

NOTE: When the monitoring value on the main screen flashes due to an alarm, select the flashing area to open the corresponding Alarm Limits setting menu.

3. Enter the desired parameter value using the keyboard on the screen. For each parameter, the range of values is displayed above the keypad.

11.1 Introduction

The system provides alarms and messages that are indicated to the user by visual and audible alerts. The alarm messages are displayed in the top graph area of the main screen.

11.1.1 Alarm System Self-test

The system performs a self-test of its alarm system when powered on. The self-test is described as follows:

- The system speaker and buzzer produce one tone.

11.1.2 Types of Alarms and Messages

The equipment provides the following types of alarms and prompt messages. See section 11.8 (Pages 11-8) "Alarms and Prompt Messages" for the list of alarms and prompt messages.

- **Physiological Alarms:**
Patient-related variables cause physiological alarms. These alarms require a user response. Physiological alarms can have the following priorities: high, medium, and low.
- **Technical Alarm:**
Machine-related variables cause technical alarms. These alarms require a user response and may have a high, medium, or low priority. Technical alarms can have the following priorities: high, medium and low.
- **Prompt Message:**
This is a message to the user. They do not require an immediate user response. These messages always have the lowest priority, below physiological and technical alarms. It is displayed in white.

11.1.3 Alarm Indicators

The equipment provides the following alarm indicators:

- **Colored alarm messages displayed on the Main Screen.** High priority messages are red. Medium priority messages are yellow. Low priority messages are cyan. Prompt messages are white. Messages display according to priority and time. (See section 11.2.1 (Pages 11-4) "Display Rules of Alarm Messages".)
- **Alarm audio from the system alarm speaker.** TABLE 11-1 lists the audio behavior for each type of alarm.

NOTE: The “Disable in Standby Mode” column indicates whether the physiological alarm is blocked in the standby mode.

NOTE: You can view past alarms in the [History] menu.

NOTE: The Alarm Delay time between the anesthesia system and the external interconnected device or system is smaller than or equal to 3s.

11.8.1 Physiological Alarm Messages

MESSAGE	CAUSE	ACTION	ALARM PRIORITY
Apnea	No breath has been detected within the apnea time.	1. Check alarm limit: Tapnea. 2. Check whether the breathing system is leaking or disconnected. 3. Ensure the position of Auto/manual switch is correct.	Medium
Apnea>2 min	No breath has been detected within the last 120 seconds.	1. Check whether ventilation starts. 2. Check whether the breathing system is leaking or disconnected. 3. Ensure the position of Auto/manual switch is correct.	High
Paw Too High	PEAK > high alarm limit setting.	1. Check alarm limit: PEAK High. 2. Check ventilation settings: P _{insp} /ΔP _{insp} , V _t , PEEP, etc. 3. Check whether the breathing system is kinked or blocked.	High
Paw Too Low	PEAK < low alarm limit setting for 20 seconds.	1. Check alarm limit: PEAK Low. 2. Check ventilation settings: P _{insp} /ΔP _{insp} , V _t , PEEP, etc. 3. Check whether the breathing system is leaking or disconnected.	High
Pressure Limiting	Paw ≥ P _{limit} .	Check ventilation settings: P _{limit} .	Low
MV Too High	MV > high alarm limit setting.	1. Check alarm limit: MV High. 2. Check ventilation settings: P _{insp} /ΔP _{insp} , V _t , RR, etc.	Medium
MV Too Low	MV < low alarm limit setting.	1. Check alarm limit: MV Low. 2. Check ventilation settings: P _{insp} /ΔP _{insp} , V _t , RR... 3. Check whether the breathing system is leaking or blocked.	Medium
Vte Too High	Vte > high alarm limit setting.	1. Check alarm limit: Vte High. 2. Check ventilation settings: P _{insp} /ΔP _{insp} , V _t , etc.	Medium
Vte Too Low	Vte < low alarm limit setting.	1. Check alarm limit: Vte Low. 2. Check ventilation settings: P _{insp} /ΔP _{insp} , V _t , etc. 3. Check whether the breathing system is leaking or blocked.	Medium
RR Too High	RR > high alarm limit setting.	1. Check alarm limit: RR High. 2. Check ventilation settings: RR, F-Trig/P-Trig, etc. 3. Check whether the breathing system is leaking or blocked.	Low

TABLE 11-3 Physiological Alarm Messages

MESSAGE	CAUSE	ACTION	ALARM PRIORITY
RR Too Low	RR < low alarm limit setting.	1. Check alarm limit: RR Low. 2. Check ventilation settings: RR, F-Trig, etc.	Low
Continuous Airway Pressure	Paw in the breathing system > continuous airway pressure alarm limit for 15 seconds.	1. Check APL valve setting in manual mode. 2. Check whether the breathing system is kinked or blocked.	High
Negative Pressure	Paw < -10 cmH ₂ O for 1 second.	1. Check the negative pressure suction. 2. Check whether AGSS works normally.	High
EtCO₂ Too High	EtCO ₂ > high alarm limit setting.	1. Check alarm limit: EtCO ₂ High 2. Check whether it is necessary to replace soda lime of the CO ₂ absorbent canister.	Medium
EtCO₂ Too Low	EtCO ₂ < low alarm limit setting.	1. Check alarm limit: EtCO ₂ Low. 2. Check whether the sampling line of AG module is disconnected.	Medium
FiCO₂ Too High	FiCO ₂ > high alarm limit setting.	1. Check alarm limit: FiCO ₂ High. 2. Check whether it is necessary to replace soda lime of the CO ₂ absorbent canister.	Medium
FiN₂O Too High	FiN ₂ O > high alarm limit setting.	Check fresh gas balance gas setting.	Medium
EtHal Too High	EtHAL > high alarm limit setting.	1. Check alarm limit: EtHal High. 2. Check AA% setting.	Medium
EtHal Too Low	EtHAL < low alarm limit setting.	1. Check alarm limit: EtHal Low. 2. Check AA% setting. 3. Check whether the sampling line of AG module is disconnected.	Medium
FiHal Too High	FiHAL > high alarm limit setting.	1. Check alarm limit: FiHal High. 2. Check AA% setting.	Medium
FiHal Too Low	FiHAL < low alarm limit setting.	1. Check alarm limit: FiHal Low. 2. Check AA% setting. 3. Check whether the sampling line of AG module is disconnected.	Medium
EtEnf Too High	EtENF > high alarm limit setting.	1. Check alarm limit: EtEnf High. 2. Check AA% setting.	Medium
EtEnf Too Low	EtENF < low alarm limit setting.	1. Check alarm limit: EtEnf Low. 2. Check AA% setting. 3. Check whether the sampling line of AG module is disconnected.	Medium
FiEnf Too High	FiENF > high alarm limit setting.	1. Check alarm limit: FiEnf High. 2. Check AA% setting.	Medium
FiEnf Too Low	FiENF < low alarm limit setting.	1. Check alarm limit: FiEnf Low. 2. Check AA% setting. 3. Check whether the sampling line of AG module is disconnected.	Medium
EtIso Too High	EtISO > high alarm limit setting.	1. Check alarm limit: EtIso High. 2. Check AA% setting.	Medium

TABLE 11-3 Physiological Alarm Messages

Auxiliary O₂ Flowmeter:	Flow adjustable range: 0.0 L/min to 15.0 L/min Flow control accuracy: ± 0.5 L/min or $\pm 10\%$ of the indicated value, whichever is greater
High Flow Nasal Cannula Oxygen (HFNC)	Flow control range: 0 L/min to 60 L/min Flow control accuracy: $\pm (2$ L/min + 10% of the setting value) Safety pressure: With pressure release protection, pressure at the outlet ≤ 6.0 kPa.
O₂ Flush:	Flow range: 25 to 75 L/min
Airway Pressure Gauge:	Range: -20 to 100 cmH ₂ O Accuracy: $\pm (2\%$ of full scale reading + 4% of actual reading)

TABLE 13-54 Pneumatic Controls

13.14 Alarms

Alarm Indicators:	Audible: speaker Visual: on-screen alarm messages (Audible and visual alarms comply with the requirements of IEC 60601-1-8.)
Alarm Categories:	Physiological alarms: three levels (high, medium, low) Technical alarms: three levels (high, medium, low)
Sound Levels:	10 alarm sound levels, adjustable (levels 1 to 10)

TABLE 13-55 Alarms

Vte:	High Limit	5 mL to 1600 mL
	Low Limit	OFF, 0 mL to 1595 mL
MV:	High Limit	0.2 L/min to 100 L/min
	Low Limit	0.0 to 15.0 L/min: 0.0 L/min to (high limit - 0.2) L/min 15.0 to 100.0 L/min: 15 L/min to (high limit - 1) L/min
RR:	High Limit	4 bpm to 100 bpm, OFF
	Low Limit	OFF, 2 bpm to 98 bpm
Paw:	High Limit	2 cmH ₂ O to 100 cmH ₂ O
	Low Limit	0 cmH ₂ O to 98 cmH ₂ O

Apnea alarm delay time is adjustable, Range: 5s to 60s, Accuracy: ± 3 s

CO₂ apnea delay time is adjustable, Range: 10s to 40s, Accuracy: ± 3 s

It has Negative Pressure alarm function. **Negative Pressure in Airway** alarm is triggered when the airway pressure is lower than the atmospheric pressure by 10 cmH₂O.

TABLE 13-56 Alarm Limits

V60 Anesthetic Vaporizer

Operator's Manual

© 2009-2016 Shenzhen Mindray Bio-Medical Electronics Co., Ltd. All rights Reserved.
For this Operator's Manual, the issue date is September, 2016.

11 Theory of Operation

11.1 Operating Principle

The following image illustrates the operating principle of the vaporizer.

Control dial position above 0--Vaporizer switched on:

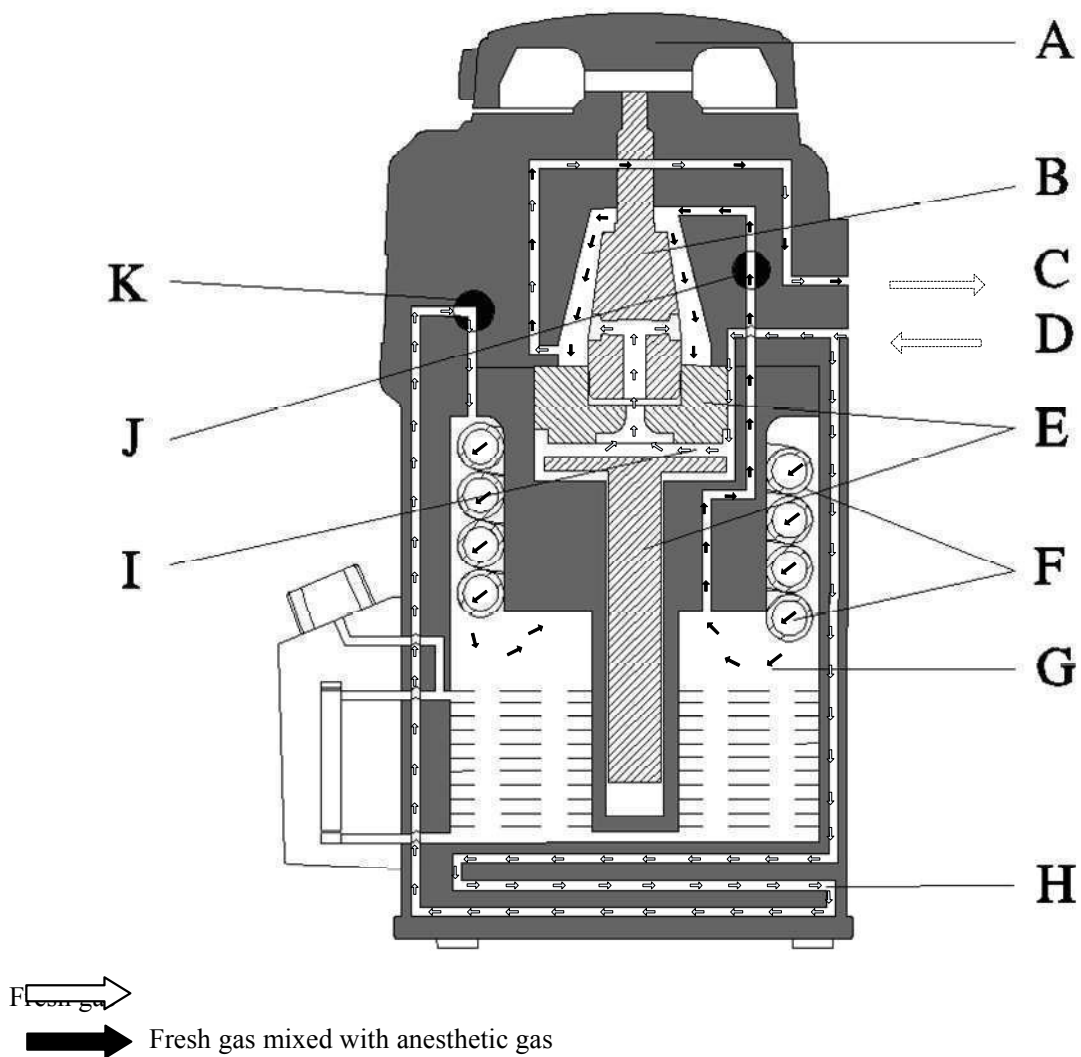

The fresh gas is routed through valves J and K, which are linked to the control dial A, and through the vaporizing chamber G.

Fresh gas enters by the inlet D. Some of the fresh gas is routed through the vaporizing chamber G, and charged with anesthetic agent in soaked wick F. The rest of the fresh gas is routed past the airway I and through the temperature compensator E.

The two flows are mixed in the space behind the two flow controls (cone valve B), and routed to the outlet C.

The output concentration control of anesthetic agent vapor is important.

1. The concentration is influenced by the temperature compensator E, which makes use of the thermal expansion characteristics of different materials to expand or contract, based on heating or cooling, the airway I. This process compensates for the influence of temperature on the saturation concentration.
2. The pressure compensating system H effectively reduces the pumping effect.

Control dial position at 0—Vaporizer switched off

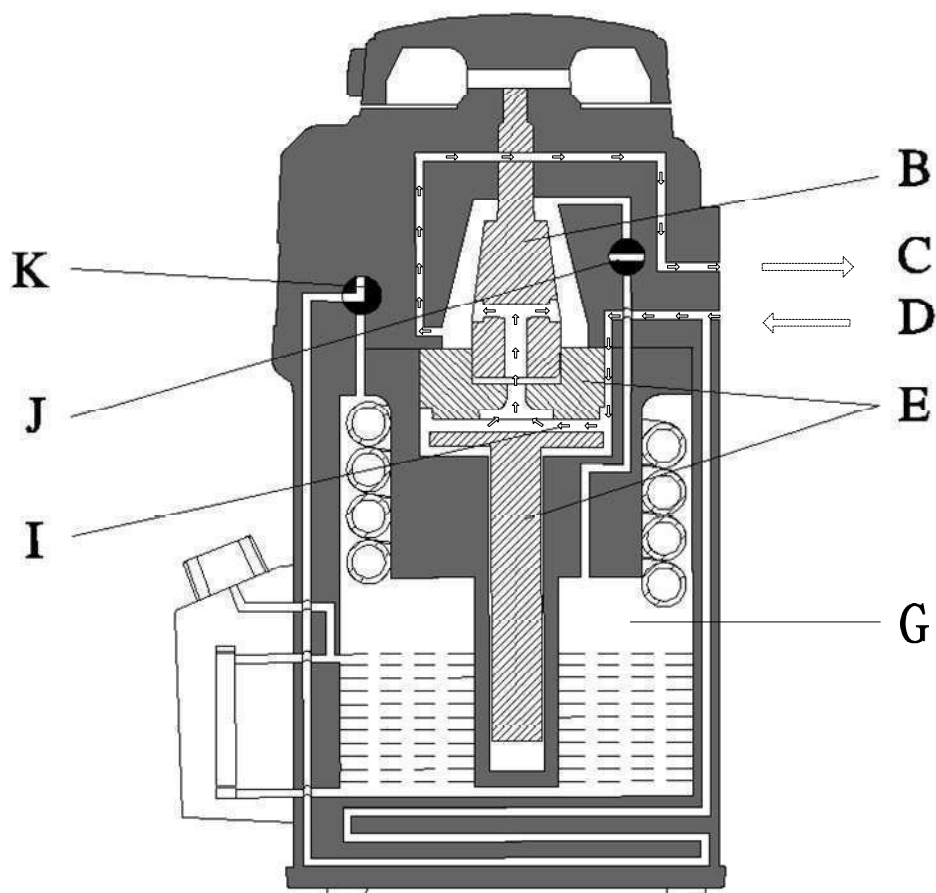

Fresh gas flows from the inlet D to the airway I, and then passes the temperature compensator E and the cone valve B, finally flows out from the outlet C.

The vaporizing chamber G is completely shut off from the gas flow by valves J and K. No anesthetic-agent can escape from the vaporizing chamber G.



Anesthesia accessory

CATALOGUE

2022.06

www.mindray.com

P/N:ENG-Anesthesia accessory catalogue-210210X64P-20220606
©2022 Shenzhen Mindray Bio-Medical Electronics Co.,Ltd. All rights reserved.





CONTENTS

01	Anesthesia mask, bag, breathing circuit	2
02	Vaporizer	14
03	Module & Sensor	20
04	AGSS, Suction unit, Gas supply	33
05	Mounting solution	47
06	Other accessories	53

Finding the Right Part

This catalog has been designed to make finding the right part easy. Chapters are organized by specific accessory categories. Simply locate the type of part you are looking for under the appropriate category.

Note:





This catalog is not an Operating Instructions Manual. This catalog will assist you in identifying the correct parts and accessories to connect to your Mindray Anesthesia machine, please refer to the Operating Instructions Manual. Warnings, Precautions and Notes can also be found in the Operating Instructions.

Anesthesia Mask



Disposable Anesthesia Mask

- Single patient use to avoid cross-infection
- Ergonomic design for convenient one-hand operation
- Adjustable air cushion design for optimal comfort and tightness
- Transparent design for optimal visibility
- Materials in accordance with ISO-10993:10993 biological compatibility requirements
- Complete range of models with color-coded hook for easier identification

Picture	Part No.	Description	Apply to
	040-001817-00	Aircushion mask, disposable, size #0	All
	040-001818-00	Aircushion mask, disposable, size #1	All
	040-001819-00	Aircushion mask, disposable, size #2	All
	040-001820-00	Aircushion mask, disposable, size #3	All

Picture	Part No.	Description	Apply to
	040-001821-00	Aircushion mask, disposable, size #4	All

	040-001822-00	Aircushion mask, disposable, size #5	All
-----------------------------------------------------------------------------------	---------------	--------------------------------------	-----





Reusable Anesthesia Mask

- Ergonomic design for convenient one-hand operation
- Transparent design for optimal visibility
- Materials in accordance with ISO-10993:10993 biological compatibility requirements
- Full range of models for different clinical applications

Picture	Part No.	Description	Apply to
	040-001835-00	Silicon face mask, reusable, size #0	All

	040-001836-00	Silicon face mask, reusable, size #1	All
-------------------------------------------------------------------------------------	---------------	--------------------------------------	-----

	040-001837-00	Silicon face mask, reusable, size #2	All
--------------------------------------------------------------------------------------	---------------	--------------------------------------	-----

	040-001841-00	Silicon face mask, reusable, size #3	All
---------------------------------------------------------------------------------------	---------------	--------------------------------------	-----

Picture	Part No.	Description	Apply to
	040-001842-00	Silicon face mask, reusable, size #4	All

	040-001843-00	Silicon face mask, reusable, size #5	All
-----------------------------------------------------------------------------------	---------------	--------------------------------------	-----

Breathing Bag

Disposable breathing bag

- Single patient use to avoid cross-infection
- Standard 22F connector compatible with all conventional devices
- Latex free materials to prevent latex allergy
- Full range of models for different clinical applications



Part No.	Description	Apply to
040-001827-00	Latex-free breathing bag, disposable, 0.5L	All
040-001828-00	Latex-free breathing bag, disposable, 1L	All
040-001829-00	Latex-free breathing bag, disposable, 2L	All
040-001830-00	Latex-free breathing bag, disposable, 3L	All

Reusable breathing bag

- Use of innocuous medical grade materials
- Standard 22F connector compatible with all conventional devices
- Full range of models for different clinical applications





Part No.	Description	Apply to
040-001856-00	Silicon breathing bag, reusable, 0.5L	All
040-001857-00	Silicon breathing bag, reusable, 1L	All
040-001858-00	Silicon breathing bag, reusable, 2L	All
040-001859-00	Silicon breathing bag, reusable, 3L	All

Anesthesia Breathing Circuit





Disposable breathing circuit

- Single patient use to avoid cross-infection
- Use of innocuous medical grade materials
- Good compliance and low flow resistance
- Transparent design for optimal visibility
- Light weight to easy operation
- Standardized and air-tight connectors for innovative assembly
- Elbow connector with air sampling and monitoring



Picture	Part No.	Description	Apply to
	040-001876-00	Disposable breathing circuit package, Adult, Including: <ul style="list-style-type: none"> - Adult circuit with Y-piece, 1.5 m, diameter 22mm, 22F, 1 pcs - Elbow connector with Luer lock port, 1 pcs - Straight connector, 22M-22M, 1 pcs - Bacteria filter, 1 pcs - Extension tube, 0.5 m, 22F, 1 pcs - Latex-free breathing bag, 3L, 1 pcs 	All
	040-001878-00	Disposable breathing circuit package, Child, Including: <ul style="list-style-type: none"> - Child circuit with Y-piece, 1.5m, diameter 15 mm, 22F, 1 pcs - Elbow connector with Luer lock port, 1 pcs - Straight connector, 22M-22M, 1 pcsz - Bacteria filter, 1 pcs - Extension tube, 0.5m, diameter 15 mm, 22F, 1 pcs - Latex-free breathing bag, 1L, 1 pcs 	All
	040-001831-00	Bacteria Filter, disposable, 1 pcs Bacterial removal: >99.9995% Viral removal: >99.995% Pressure Drop: <0.15kPa @ 30 L/min Dead space: 25.5 ml Connectors: 22F/15M-22M/15F	All

Part No.	Description	Apply to
115-030717-00	Disposable breathing circuit accessory kit with mask, Adult, including: - 040-001876-00 Disposable breathing circuit package, Adult (circuit with Y-piece 1.5m, Extension tube 0.5m, Elbow connector, Straight connector, Bacteria filter, Breathing bag 3L), 1 pcs - 040-001822-00 Aircushion mask, disposable, size #5, 1 pcs	All
115-030718-00	Disposable breathing circuit accessory kit with mask, Child, including: - 040-001878-00 Disposable breathing circuit package, Child, (circuit with Y-piece 1.5m, Extension tube 0.5m, Elbow connector, Straight connector, Bacteria filter, Breathing bag 1L), 1 pcs - 040-001819-00 Aircushion mask, disposable, size #2, 1 pcs	All

Open Circuit

Picture	Part No.	Description	Apply to
	040-001704-00	Mapleson C circuit, Adult open circuit, including: - Breathing tube, 1.8m, 1 pcs - Connector, 22/15M, 1 pcs - Latex-free breathing bag, 2L, 1 pcs - APL valve, 1 pcs	All
	040-001703-00	T-piece system circuit, Child open circuit, including: - Breathing tube, 1.8m, 1 pcs - Connector, 22/15M, 1 pcs - Latex-free breathing bag, 0.5L, 1 pcs - APL valve, 1 pcs	All



HFNC Circuit





Picture	Part No.	Description	Apply to
	040-006057-00	Single tube for HFNC, disposable, ID 22 mm, length 1.8 m	A9/ A8/ WATO EX-65 Pro
	040-006058-00	Tubing kit for HFNC, disposable, with heated wire, ID 22 mm, length 1m, 1.5m	A9/ A8/ WATO EX-65 Pro
	040-002376-00	Nasal cannula for HFNC (OPT842-small size)	A9/ A8/ WATO EX-65 Pro
	040-002377-00	Nasal cannula for HFNC (OPT844-medium size)	
	040-002378-00	Nasal cannula for HFNC (OPT846-large size)	

Reusable breathing circuit

- Use of innocuous medical grade materials
- Good compliance and low flow resistance
- Transparent design for optimal visibility
- Standardized and air-tight connectors for innovative assembly
- Y-piece with port for temperature and pressure monitoring



Picture	Part No.	Description	Apply to
	115-031780-00	Reusable breathing circuit accessory kit, Adult, including: - 040-001850-00 Breathing tube, silicon, adult, 1.5m, 2 pcs - 040-001859-00 Silicon breathing bag, 3L, 1 pcs - 040-001843-00 Silicon face mask, size #5, adult large, 1 pcs - 040-001866-00 connector, Y-piece, with sample port, 1pcs - 040-001868-00 connector, L type (Elbow), 22M/15F, 22F, 1pcs	All
	115-031781-00	Reusable breathing circuit accessory kit, Child, including: - 040-001851-00 Breathing tube, silicon, child/infant, 1.5m, 2 pcs - 040-001857-00 Silicon breathing bag, reusable, 1L, 1 pcs - 040-001837-00 Silicon face mask, size #2, child, 1 pcs - 040-001866-00 connector, Y-piece, with sample port, 1pcs - 040-001868-00 connector, L type (Elbow), 22M/15F, 22F, 1pcs	All
	040-001850-00	Breathing tube, silicon, reusable, Adult, 1.5m	All





Picture	Part No.	Description	Apply to
	040-001851-00	Breathing tube, silicon, reusable, Child/infant, 1.5m	All
	040-001854-00	Breathing tube, silicon, reusable, Adult, 0.45m	All
	040-001866-00	connector, Y-piece, reusable, with sample port	All
	040-001868-00	connector, L type (Elbow), reusable, 22M/15F, 22F	All





Vaporizer







- Large capacity
- Highly compatible supporting different anesthetic agents
- Automatic flow, temperature, pressure compensation
- Maintenance-free design

Mindray V60 Vaporizer



Picture	Part No.	Description	Apply to
	115-005348-00	Mindray V60 vaporizer, Isoflurane, Pour fill	All except A9
	115-005345-00	Mindray V60 vaporizer, Isoflurane, Key filler, with Key filler adapter	All except A9
	115-005349-00	Mindray V60 vaporizer, Sevoflurane, Pour fill	All except A9
	115-005346-00	Mindray V60 vaporizer, Sevoflurane, Key filler, with Key filler adapter	All except A9





Picture	Part No.	Description	Apply to
	115-005350-00	Mindray V60 vaporizer, Sevoflurane, Quik-Fil	All except A9
	115-014139-00	Mindray V60 vaporizer, Halothane, Pour fill	All except A9
	115-014138-00	Mindray V60 vaporizer, Halothane, Key filler, with Key filler adapter	All except A9
	115-017631-00	Vaporizer parking position (the third vaporizer position)	A8/A7/A5/ WATO EX-65 Pro/ EX-55 Pro/ EX-65/ EX-55/ EX-35

Mindray V90 Vaporizer

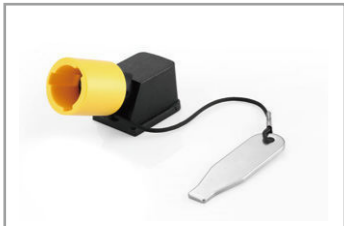

Picture	Part No.	Description	Apply to
	115-063020-00	Mindray V90 vaporizer, Isoflurane, Safety Filling, with adapter	A9
	115-063018-00	Mindray V90 vaporizer, Sevoflurane, Safety Filling, with adapter	A9
	115-063017-00	Mindray V90 vaporizer, Sevoflurane, Quik-Fil	A9
	115-063022-00	Mindray V90 vaporizer, Desflurane, Safe-T-Fil	A9

Adapter for Vaporizer





Picture	Part No.	Description	Apply to
	040-000065-00	Key filler Adapter for filling the vaporizer, Isoflurane	V60
	040-000066-00	Key filler Adapter for filling the vaporizer, Sevoflurane	V60
	115-026747-00	Quik-Fil Adapter for filling the vaporizer, Sevoflurane	V60, V90
	040-000067-00	Quik-Fil Drain Funnel adapter for draining the vaporizer, Sevoflurane	V60

Picture	Part No.	Description	Apply to
	040-000063-00	Key filler adapter for filling the vaporizer, Halothane	V60
	115-064147-00	Safety filling adapter for filling the Mindray V90 vaporizer, Isoflurane	V90
	115-064146-00	Safety filling adapter for filling the Mindray V90 vaporizer, Sevoflurane	V90
	115-082300-00	Filling converter for Sevoflurane	V60, V90





Flow sensor

Picture	Part No.	Description	Apply to
	0601-30-69700	Inspiration flow sensor, 1 pcs	WATO EX-65 Pro/ EX-55 Pro/ EX-65/EX-55/ EX-35/EX-30/ EX-20
	0601-30-78894	Expiration flow sensor, 1 pcs	
	115-001366-00	Flow sensor kit, including: - Inspiration flow sensor, 1 pcs 0601-30-69700 - Expiration flow sensor, 1 pcs 0601-30-78894	
	115-008262-00	Inspiration Flow sensor, 1 pcs	A7/A5
	115-008263-00	Expiration Flow sensor, 1 pcs	
	115-008264-00	Flow sensor kit, including: - Inspiration Flow sensor, 1 pcs 115-008262-00 - Expiration Flow sensor, 1 pcs 115-008263-00	
	115-041519-00	Flow sensor kit, autoclavable, including: - Inspiration flow sensor, 1 pcs 115-041507-00 - Expiration flow sensor, 1 pcs 115-041508-00	All

O₂ monitoring accessory

Picture	Part No.	Description	Apply to
	115-009958-00	Oxygen monitoring kit, including: Oxygen sensor Medcel MOX-2 and Oxygen sensor mounting kit	A7/A5/ WATO EX-65 Pro/ EX-55 Pro/EX-65/ EX-55/EX-35 with Pre-Pak circuit
	115-034487-00	Oxygen monitoring kit, including: Oxygen sensor OOM102-1 and Oxygen sensor cable	WATO EX-35 without Pre-Pak circuit WATO EX-30/EX-20
	115-065993-00	Oxygen monitoring kit, including: Base for Oxygen sensor and Oxygen sensor MOX-2	A9/A8
	115-016612-00	Oxygen sensor position choke plug kit, including: - 043-003033-00 Oxygen sensor position cap, 1 pcs - 115-016612-00 Oxygen sensor position choke plug, 1 pcs	A7/A5

O₂ monitoring accessory



Picture	Part No.	Description	Apply to
	0611-10-45654	Oxygen sensor, Medical MOX-2, 1 pcs	A9/A8/A7/A5/ WATO EX-65 Pro/ EX-55 Pro WATO EX-65/EX-55 WATO EX-35 with pre-pak circuit
	040-000898-00	Oxygen sensor, OOM102-1, 1pcs	WATO EX-35 without pre-pak circuit WATO EX-30/EX-20
	043-000616-00	Oxygen sensor cable	A7/A5/ WATO EX-65 Pro/ EX-55 Pro/ EX-65/EX-55/ EX-35
	115-064181-00	Base for Oxygen sensor	A9/A8

CO₂ module and accessory





Sidestream CO₂ module and accessory

- Sampling lines are disposable
- Water trap can be reused (Should be replaced every month)
- Latex free
- Good biocompatibility

Picture	Part No.	Description	Apply to
	115-030418-00	Sidestream CO ₂ module, without accessory	A7, A5
	120-013811-00	Sidestream CO ₂ module, without accessory	WATO EX-65 Pro/ EX-55 Pro/ EX-65/ EX-55/ EX-35
	115-024752-00	Sidestream CO₂ accessory kit, Adult/Pediatric, including: - Dryline airway adapter, straight, Adu/Ped, 2 pcs - DRYLINE II Water Trap, Adu/Ped, 2 pcs - Sampling line, Adu/Ped, 2.5 m, 2pcs - Quick connector for gas return, 1 pcs	A7/A5/ WATO EX-65 Pro/ EX-55 Pro/ EX-65/ EX-55/ EX-35



Picture	Part No.	Description	Apply to
	115-024753-00	Sidestream CO₂ accessory kit, Neonate, including: - Airway adapter, Neonate, 2 pcs - DRYLINE II Water Trap, Neonate, 2 pcs - Sampling Line, Neonate, 2.5 m, 2 pcs - Quick connector for gas return, 1 pcs	A7/A5/ WATO EX-65 Pro/ EX-55 Pro/ EX-65/ EX-55/ EX-35
	115-024797-00	Sidestream CO₂ module kit, with accessory, Adult/Ped, including: - CO ₂ module, 1-slot, 1 pcs - CO ₂ accessory kit, Adult/Pediatric	A7/A5
	115-024798-00	Sidestream CO₂ module kit, with accessory, Neonate, including: - CO ₂ module, 1-slot, 1 pcs - CO ₂ accessory kit, Neonate	A7/A5
	120-015033-00	Sidestream CO₂ module kit, with accessory, Adult/pediatric, including: - Sidestream CO ₂ module - Sidestream CO ₂ accessory kit, Adult/Pediatric	WATO EX-65 Pro/ EX-55 Pro/ EX-65/ EX-55/ EX-35
	120-015034-00	Sidestream CO₂ module kit, with accessory, Neonate, including: - Sidestream CO ₂ module - Sidestream CO ₂ accessory kit, Neonate	WATO EX-65 Pro/ EX-55 Pro/ EX-65/ EX-55/ EX-35

Picture	Part No.	Description	Apply to
	115-030421-00	External sidestream CO₂ module, with accessory, Adult/pediatric, including: - External sidestream CO ₂ module - External sidestream CO ₂ accessory kit, Adult/Pediatric	WATO EX-30
	115-030422-00	External sidestream CO₂ module, with accessory, Neonate, including: - External sidestream CO ₂ module - External sidestream CO ₂ accessory kit, Neonate	WATO EX-30
	115-002594-00	External sidestream CO₂ accessory kit, Adult/pediatric, including: - Dryline airway adapter, straight, Adu/Ped, 2 pcs - Water trap, Adu/Ped, 2 pcs - Sampling line, Adu/Ped, 2.5 m, 2pcs - Quick connector for gas return, 1 pcs	WATO EX-30
	115-002595-00	External sidestream CO₂ accessory kit, Neonate, including: - Airway adaptor, 2 pcs - Water trap, neonate, 2 pcs - Sampling Line, Neonate, 2.5 m, 2 pcs - Quick connector for gas return, 1 pcs	WATO EX-30

Mainstream CO₂ module and accessory

- Short response time
- Adapter are disposable
- Latex free
- Good biocompatibility



For A7, A5, WATO EX-65 Pro, EX-55 Pro, EX-65, EX-55, EX-35

Picture	Part No.	Description
	115-030414-00	Mainstream CO ₂ module, without accessory
	6800-30-50613	Mainstream CO₂ accessory kit, including: <ul style="list-style-type: none"> - Capnostat CO₂ sensor, with cable 2.4 m, 1 pcs - Airway adapter, Adu/Ped, disposable, 1 pcs - Airway adapter, Neonate, disposable, 1 pcs - Cable Holding Clips, 5 pcs
	115-030410-00	Mainstream CO₂ module kit, with accessory, including: <ul style="list-style-type: none"> - Mainstream CO₂ module, CAPNOSTAT - Mainstream CO₂ accessory kit

AG module and accessory

- Sampling lines are disposable
- Water trap can be reused (Should replaced every month)
- Latex free
- Good biocompatibility



For A9, A8, A7, A5, WATO EX-65 Pro, EX-55 Pro, EX-65, EX-55, EX-35



Picture	Part No.	Description
	115-030368-00	AG+O ₂ module, 2-slot, without accessory
	115-030369-00	AG module, 2-slot, without accessory
	115-030385-00	AG accessory kit, including: <ul style="list-style-type: none"> - Dryline airway adapter, straight, Adu/Ped, 2 pcs - Airway adapter, Neonate, 2 pcs - DRYLINE II Water Trap, Adu/Ped, 2 pcs - Sampling line, Adu/Ped, 2.5 m, 2 pcs - DRYLINE II Water Trap, Neonate, 2 pcs - Sampling Line, Neonate, 2.5 m, 2 pcs - Quick connector for gas return, 1 pcs
	115-030379-00	AG+O₂ module kit, with accessory, including: <ul style="list-style-type: none"> - AG+O₂ module , 2-slot - AG accessory kit
	115-030380-00	AG module kit, with accessory, including: <ul style="list-style-type: none"> - AG module , 2-slot - AG accessory kit

BIS module and accessory

- Flexible design adjusts to different head sizes
- Connector provides secure click-in connection with push button release
- BIS sensor single patient use, avoiding cross-infection
- Latex-free
- Good biocompatibility, avoiding allergic reactions to patient



For A9, A8, A7, A5, WATO EX-65 Pro, EX-65

Picture	Part No.	Description
	115-013194-00	BIS module, 1-slot, without accessory
	6800-30-50761	BIS Measuring Cable Assembly, 4.5 m, 1 pcs

Picture	Part No.	Description
	6800-30-50878	BIS accessory kit, Adult, including: - BIS Measuring Cable Assembly, 4.5 m, 1 pcs - BIS Sensor Quatro 186-0106, Adu, disposable, 5 pcs
	6800-30-50144	BIS accessory kit, Pediatric, including: - BIS Measuring Cable Assembly, 4.5 m, 1 pcs - BIS Sensor Quatro 186-0200, Pediatric, disposable, 5 pcs
	6800-30-50880	BIS module kit, with accessory, Adult, including: - BIS module, 1-slot - BIS accessory kit, Adult
	6800-30-50427	BIS module kit, with accessory, Pediatric, including: - BIS module, 1-slot - BIS accessory kit, Pediatric

BISx4 module and accessory

For A9, A8, A7, A5, WATO EX-65 Pro, EX-65

Picture	Part No.	Description
	115-005707-00	BISx4 Measuring Cable Assembly, 4.5 m, 1 pcs
	115-005614-00	BISx4 accessory kit, Adult, including: - BISx4 Measuring Cable Assembly, 4.5 m, 1 pcs - BISx4 Sensor Quatro 186-0212, Adult, disposable, 5 pcs
	115-030406-00	BISx4 module kit, with accessory, Adult, including: - BIS module, 1-slot - BISx4 accessory kit, Adult



AG+BIS module and accessory

For A9, A8, A7, A5, WATO EX-65 Pro, EX-65

Picture	Part No.	Description
	115-030370-00	AG+O ₂ +BIS module, 2-slot, without accessory
	115-030371-00	AG+BIS module , 2-slot, without accessory
	115-030381-00	AG+O₂+BIS module kit, with AG accessory, without BIS accessory, including: - AG+O ₂ +BIS module , 2-slot - AG accessory kit
	115-030382-00	AG+BIS module kit, with AG accessory, without BIS accessory, including: - AG+BIS module , 2-slot - AG accessory kit
	115-030383-00	AG+O₂+BIS module kit, with AG accessory, with BIS accessory, including: - AG+O ₂ +BIS module , 2-slot - AG accessory kit - BIS accessory kit, Adult
	115-030384-00	AG+BIS module kit, with AG accessory, with BIS accessory, including: - AG+BIS module , 2-slot - AG accessory kit - BIS accessory kit, Adult

NMT module and accessory

For A9, A8, A7, A5



Picture	Part No.	Description
	115-020916-00	NMT module, without accessory
	115-018586-00	NMT accessory kit, including: <ul style="list-style-type: none"> - NMT main cable - NMT transducer cable - ECG electrode (3M, 2245), 50 pcs - Bandage for NMT transducer, disposable, 20pcs
	115-020917-00	NMT module kit, with accessory, including: <ul style="list-style-type: none"> - NMT module, 1-slot - NMT accessory kit

Anesthetic gas scavenging system (AGSS)



Active AGSS assembly and accessory

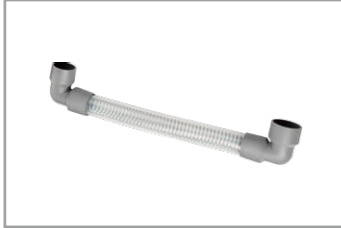

Picture	Part No.	Description	Apply to
	115-017376-00	AGSS Assembly, low-flow, high vacuum	A7/A5/ WATO EX-65 Pro/ EX-55 Pro
	115-017375-00	AGSS Assembly, high-flow, low vacuum	EX-65/EX-55 EX-35/EX-30 EX-20

Picture	Part No.	Description	Apply to
	115-006557-00	Waste gas transfer hose, from main unit to AGSS assembly (801-0631-00074-00)	A7/A5/ WATO EX-65 Pro/ EX-55 Pro EX-65/EX-55 EX-35/EX-30 EX-20
	115-009097-00	AGSS high flow receiving hose, from AGSS assembly to hospital's waste gas disposal system	All
	115-009073-00	AGSS low flow receiving hose, from AGSS assembly to hospital's waste gas disposal system	
	082-001372-00	AGSS receiving hosing, (35G-WAGD-DS/FG2-3), from AGSS assembly to vacuum system	

Active AGSS kit

Part No.	Description	Apply to
115-030332-00	AGSS kit, low flow, high vacuum, including: - AGSS Assembly, low-flow - Waste gas transfer hose, from main unit to AGSS assembly - AGSS low flow receiving hose, from AGSS assembly to hospital's waste gas disposal system - AGSS Three-way connector, from ACGO to AGSS	A7/A5/ WATO EX-65 Pro/ EX-55 Pro EX-65/EX-55 EX-35/
115-030333-00	AGSS kit, high flow, low vacuum, including: - AGSS Assembly, high-flow - Waste gas transfer hose, from main unit to AGSS assembly - AGSS high flow receiving hose, from AGSS assembly to hospital's waste gas disposal system - AGSS Three-way connector, from ACGO to AGSS	A7/A5/ WATO EX-65 Pro/ EX-55 Pro EX-65/EX-55 EX-35/
115-011860-00	AGSS kit, low flow, high vacuum, including: - AGSS Assembly, low-flow - Waste gas transfer hose, from main unit to AGSS assembly - AGSS low flow receiving hose, from AGSS assembly to hospital's waste gas disposal system - AGSS mounting kit	WATO EX-30/ EX-20
115-011859-00	AGSS kit, high flow, low vacuum, including: - AGSS Assembly, high-flow - Waste gas transfer hose, from main unit to AGSS assembly - AGSS high flow receiving hose, from AGSS assembly to hospital's waste gas disposal system - AGSS mounting kit	WATO EX-30/ EX-20

Passive AGSS accessory

Picture	Part No.	Description	Apply to
	115-002342-00	Passive AGSS accessory kit, including: - Tube, 32mm, 1 pcs - Adaptor, 1 pcs	All
	115-042912-00	AGSS Three-way connector, from ACGO to AGSS	All

Suction system



Venturi suction system (External)

Part No.	Description	Apply to
115-009509-00	Venturi suction kit, Air drive, NIST, including: - Suction main unit, venturi - Suction T connector, NIST - Suction liquid collection bottle bracket kit	WATO EX-30/ EX-20
115-011380-00	Venturi suction kit, Air drive, DISS, including: - Suction main unit, venturi - Suction T connector, DISS - Suction liquid collection bottle bracket kit	WATO EX-30/ EX-20

Part No.	Description	Apply to
115-041470-00	Venturi suction kit, Air drive, NIST, including: - Suction main unit, venturi - Suction T connector, NIST - Suction liquid collection bottle bracket kit, for rail	WATO EX-35
115-041471-00	Venturi suction kit, Air drive, DISS, including: - Suction main unit, venturi - Suction T connector, DISS - Suction liquid collection bottle bracket kit, for rail	WATO EX-35
115-015266-00	Venturi suction kit, Air drive, NIST, including: - Suction main unit, venturi - Suction T connector, NIST - Suction liquid collection bottle bracket kit, long, for rail	A5
115-015267-00	Venturi suction kit, Air drive, DISS, including: - Suction main unit, venturi - Suction T connector, DISS - Suction liquid collection bottle bracket kit, long, for rail	A5

Pipeline continuous vacuum suction system (External)



Pipeline continuous vacuum suction kit, including:

















- Suction main unit, vacuum
- Suction liquid collection bottle bracket kit
- Vacuum hose assembly

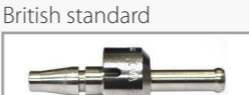

Part No.	Description	Apply to
115-020734-00	Pipeline continuous vacuum suction kit, US, US/DISS	WATO EX-30/ EX-20
115-020735-00	Pipeline continuous vacuum suction kit, US, DISS/PB	WATO EX-30/ EX-20
115-020736-00	Pipeline continuous vacuum suction kit, US, DISS/Ohmeda	WATO EX-30/ EX-20
115-020737-00	Pipeline continuous vacuum suction kit, US, DISS/Chemetron	WATO EX-30/ EX-20
115-020738-00	Pipeline continuous vacuum suction kit, US, DISS/BS	WATO EX-30/ EX-20
115-020739-00	Pipeline continuous vacuum suction kit, Australian, NIST/SIS	WATO EX-30/ EX-20
115-020740-00	Pipeline continuous vacuum suction kit, French, NIST/FS	WATO EX-30/ EX-20
115-020741-00	Pipeline continuous vacuum suction kit, Germany, NIST/GS	WATO EX-30/ EX-20
115-020742-00	Pipeline continuous vacuum suction kit, Britain, NIST/BS	WATO EX-30/ EX-20

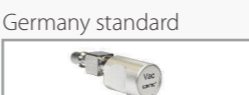
Part No.	Description	Apply to
115-041474-00	Pipeline continuous vacuum suction kit, US, US/DISS	WATO EX-35
115-041475-00	Pipeline continuous vacuum suction kit, US, DISS/PB	WATO EX-35
115-041476-00	Pipeline continuous vacuum suction kit, US, DISS/Ohmeda	WATO EX-35
115-041477-00	Pipeline continuous vacuum suction kit, US, DISS/Chemetron	WATO EX-35
115-041478-00	Pipeline continuous vacuum suction kit, US, DISS/BS	WATO EX-35
115-041479-00	Pipeline continuous vacuum suction kit, Australian, NIST/SIS	WATO EX-35
115-041480-00	Pipeline continuous vacuum suction kit, French, NIST/FS	WATO EX-35
115-041481-00	Pipeline continuous vacuum suction kit, Germany, NIST/GS	WATO EX-35
115-041482-00	Pipeline continuous vacuum suction kit, Britain, NIST/BS	WATO EX-35

Pipeline Vacuum Hose assembly

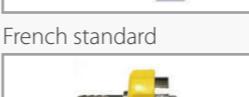
- Gas supply: Vacuum, Hose length: 5 m; Apply to all models

Part No.	Specification	Standard	Hose color	Gas outlet (machine)	Gas inlet (wall)
082-001333-00	35U-VAC-DS/DS-5	USA	White	DISS 	DISS 
082-001334-00	35U-VAC-PB/DS-5			DISS 	Puritan-Bennett 
082-001335-00	35U-VAC-OH/DS-5			DISS 	Ohmeda 
082-001336-00	35U-VAC-CH/DS-5			DISS 	Chemetron 
082-001340-00	35U-VAC-BS/DS-5			DISS 	British standard 
082-001341-00	35I-VAC-BS/NS-5	ISO	Yellow	NIST 	British standard 
082-001339-00	35I-VAC-GS/NS-5			NIST 	Germany standard 
082-001337-00	35I-VAC-SIS/NS-5			NIST 	Australian SIS standard 
082-001338-00	35I-VAC-FS/NS-5			NIST 	French standard 

Picture	Part No.	Description	Apply to
	040-001532-00	Vacuum Liquid collection bottle/flask, with overflow protection	All
	040-001533-00	Vacuum Liquid collection bottle/flask, without overflow protection	All
	115-033264-00	Suction tube connect the anesthesia machine and liquid collection bottles, 3m, with filters	All

Central gas supply hose







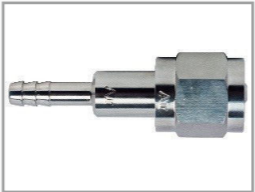
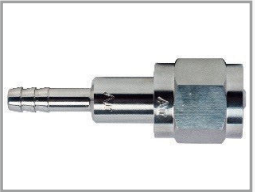

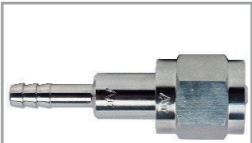

- Hose length 5 m
- Apply to all models

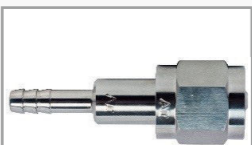

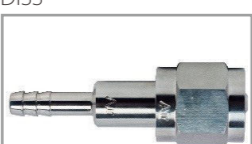





Standard: ISO

Part No.	Specification	Gas supply	Hose color	Gas outlet (machine)	Gas inlet (wall)
082-003443-00	34U-OXY-DS/DS-5	O ₂	Green	DISS	DISS
082-003445-00	34U-AIR-DS/DS-5	Air	Yellow		
082-003444-00	34U-N2O-DS/DS-5	N ₂ O	Blue		

Standard: USA

Part No.	Specification	Gas supply	Hose color	Gas outlet (machine)	Gas inlet (wall)
082-001227-00	34U-OXY-BS/DS-5	O ₂	Green	DISS	British standard
082-001228-00	34U-AIR-BS/DS-5	Air	Yellow		
082-001229-00	34U-N2O-BS/DS-5	N ₂ O	Blue		
082-001356-00	34U-OXY-CH/DS-5	O ₂	Green	DISS	Chemetron
082-001355-00	34U-AIR-CH/DS-5	Air	Yellow		
082-001354-00	34U-N2O-CH/DS-5	N ₂ O	Blue		
082-001376-00	34U-OXY-OH/DS-5	O ₂	Green	DISS	Ohmeda
082-001374-00	34U-AIR-OH/DS-5	Air	Yellow		
082-001373-00	34U-N2O-OH/DS-5	N ₂ O	Blue		
082-001375-00	34U-OXY-PB/DS-5	O ₂	Green	DISS	Puritan-Bennett
082-001378-00	34U-AIR-PB/DS-5	Air	Yellow		
082-001377-00	34U-N2O-PB/DS-5	N ₂ O	Blue		



Standard: ISO

Part No.	Specification	Gas supply	Hose color	Gas outlet (machine)	Gas inlet (wall)
082-001209-00	34I-OXY-BS/NS-5	O ₂	White	NIST	British standard
082-001210-00	34I-AIR-BS/NS-5	Air	Black & White		
082-001211-00	34I-N2O-BS/NS-5	N ₂ O	Blue		
082-001212-00	34I-OXY-GS/NS-5	O ₂	White	NIST	Germany standard
082-001213-00	34I-AIR-GS/NS-5	Air	Black & White		
082-001214-00	34I-N2O-GS/NS-5	N ₂ O	Blue		
082-001215-00	34I-OXY-SIS/NS-5	O ₂	White	NIST	Australian SIS standard
082-001216-00	34I-AIR-SIS/NS-5	Air	Black & White		
082-001217-00	34I-N2O-SIS/NS-5	N ₂ O	Blue		
082-001218-00	34I-OXY-FS/NS-5	O ₂	White	NIST	French standard
082-001219-00	34I-AIR-FS/NS-5	Air	Black & White		
082-001220-00	34I-N2O-FS/NS-5	N ₂ O	Blue		

Mounting solution



Mounting solution for patient monitor N19/N22

Picture	Part No.	Description	Apply to
	115-066025-00	GCX Bracket kit for N19/N22, fixed height	A7/A5
	115-066027-00	GCX Bracket kit for N19/N22, variable height	A7/A5
	115-069443-00	GCX bracket kit for N19/N22, fixed height	A9/A8

Mounting solution for patient monitor N17/N15/N12, ePM15

Picture	Part No.	Description	Apply to
	115-066028-00	GCX Bracket for N17/N15/N12/ePM15, fixed height	A7/A5 WATO EX-65 Pro/ EX-55 Pro/ EX-65/ EX-55/ EX-35/EX-30/EX-20
	115-066074-00	GCX bracket kit for N17/N15/N12/ePM15, fixed height, M series, 8"x8"	A9/A8
	115-066029-00	GCX Bracket for N17/N15/N12/ePM15, variable height	A9/A8/A7/A5 WATO EX-65 Pro/ EX-55 Pro/ EX-65/ EX-55/ EX-35

Mounting solution for patient monitor ePM10/12, uMEC10/12/15, iPM, iMEC

Picture	Part No.	Description	Apply to
	115-070011-00	GCX Bracket for ePM10/12, uMEC10/12/15, iPM, iMEC, fixed height	A7/A5 WATO EX-65 Pro/ EX-55 Pro/ EX-65/ EX-55/ EX-35/EX-30/EX-20
	115-070767-00	GCX bracket kit for ePM10/ePM12/uMEC, fixed height, M series, 8"x8"	A9/A8
	115-070768-00	GCX Bracket for ePM10/12, uMEC10/12/15, iPM, iMEC, variable height	A9/A8/A7/A5 WATO EX-65 Pro/ EX-55 Pro/ EX-65/ EX-55/ EX-35



Mounting solution for patient monitor T5/T8



Picture	Part No.	Description	Apply to
	115-015770-00	GCX bracket kit for Beneview T5, PM 9000, fixed height	A7/A5 WATO
	115-015783-00	GCX bracket kit for Beneview T8, fixed height	EX-65 Pro/ EX-55 Pro/ EX-65/ EX-55/ EX-35/EX-30/EX-20
	115-015771-00	GCX bracket kit for Beneview T5, fixed height, with module rack mounting pole	A7/A5 WATO EX-65 Pro/ EX-55 Pro/ EX-65/ EX-55/ EX-35/EX-30/EX-20
	115-015784-00	GCX bracket kit for Beneview T8, fixed height, with module rack mounting pole	EX-65 Pro/ EX-55 Pro/ EX-65/ EX-55/ EX-35/EX-30/EX-20
	115-069066-00	GCX bracket kit for T5/ePM15, fixed height, M series, 8"x8"	A9/A8
	115-069067-00	GCX bracket kit for T8, fixed height, M series, 8"x8"	
	115-069068-00	GCX bracket kit for T5, fixed height, M series, 8"x8", with SMR module rack mounting pole	A9/A8
	115-069069-00	GCX bracket kit for T8, fixed height, M series, 8"x8", with SMR module rack mounting pole	

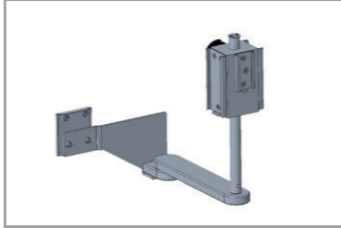

Top shelf mounting kit

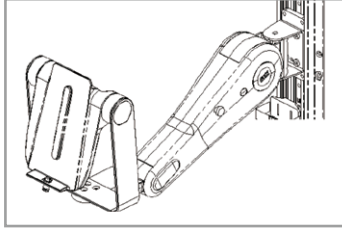
Picture	Part No.	Description	Apply to
	115-004003-00 115-004004-00	Top shelf mounting kit for Beneview T8, not support SMR Top shelf mounting kit for Beneview T5, not support SMR	All
	115-070794-00	Top shelf mounting kit for N15/17, ePM15	All
	115-074073-00	Top shelf mounting kit for N12, ePM12/10	All
	115-069445-00	Top shelf mounting bracket	A9/A8

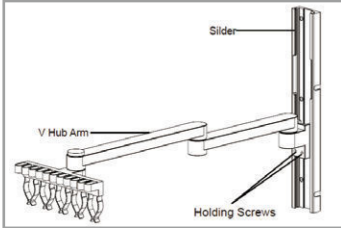

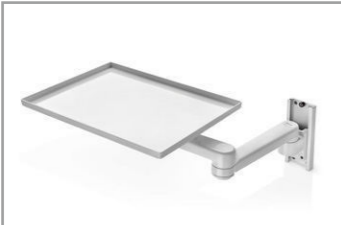

Other Accessories





Picture	Part No.	Description	Apply to
	115-054836-00	Bracket for liquid collection bottles and humidifier	A9/A8
	115-071657-00	Bracket for humidifier	WATO EX-65 Pro
	115-030486-00	GCX bracket kit for Pumps	A9/A8
	115-069585-00	GCX bracket kit for TE7	A9/A8

Picture	Part No.	Description	Apply to
	115-024614-00	GCX support arm(M series), V Hub Arm kit, for cable management	A9/A8/A7/A5
	115-024461-00	Support arm kit for holding breathing tubes, with tube clip	A9/A8/A7/A5
	115-014961-00	Trolley for Air compressor C3	All
	034-000460-00	GCX external auxiliary work surface, including 12" x 12" tray and articulating arm	A9/A8/A7/A5

Picture	Part No.	Description	Apply to
	043-010620-00	Hook mounting on the handles, for standard breathing tube	A9/A8
	115-011304-00	Tube clip, for coaxial breathing hoses, 1pcs	A9/A8/A7/A5 WATO EX-65 Pro/ EX-55 Pro/ EX-65/ EX-55/ EX-35
	115-017042-00	Quick connector for gas return, from gas module in the anesthesia machine to the AGSS or breathing circuit	A9/A8/A7/A5 WATO EX-65 Pro/ EX-55 Pro/ EX-65/ EX-55/ EX-35

Breathing system

Picture	Part No.	Description	Apply to
	115-030838-00	Sodalime canister, for WATO EX-55/65/55 Pro/65 Pro, or WATO EX-20/30/35 breathing circuit with bypass	WATO series
	115-034194-00	Sodalime canister, for WATO EX-20/30/35 breathing circuit without bypass	WATO EX-20/ EX-30/ EX-35
	801-0631-00066-00	Sodalime canister, for Pre-pak breathing circuit	A7/A5/ WATO EX-65 Pro/ EX-55 Pro/ EX-65/ EX-55/ EX-35
	115-066324-00	Sodalime canister with handle, for Pre-pak breathing circuit (A9/A8)	A9/A8

Picture	Part No.	Description	Apply to
	040-000358-00	Bellows	A7/A5 WATO Series
	0601-20-78976	Foam pad for soda-lime canister, for WATO EX-55/65/55 Pro/65 Pro, or WATO EX-20/30/35 breathing circuit with bypass , 20 pcs	WATO series
	115-046756-00	Quick Release APL Valve Assembly	A7
	115-048035-00	Flexible bag arm assembly	A9/A8/A7/A5 WATO EX-65 Pro/ EX-55 Pro/ EX-65/ EX-55/ EX-35

Picture	Part No.	Description	Apply to
	045-004527-00	Breathing system cleaning adaptor kit	A9/A8

Cylinder Accessory

Picture	Part No.	Description	Apply to
	0348-00-0185	Cylinder yoke seal, 6 pcs	All

	115-033063-00	Cylinder yoke spanner	All
------------------------------------------------------------------------------------	---------------	-----------------------	-----

Battery

Picture	Part No.	Description	Apply to
	115-018011-00	Li-ion Battery Package, 11.1 V, 4400mAh	WATO EX-30/ EX-20

	115-062081-00	Li-ion Bat Pack (10.95V) Li-ion Battery Package	A7/A5 WATO EX-65 Pro/ EX-55 Pro/ EX-65/ EX-55/ EX-35
-------------------------------------------------------------------------------------	---------------	-------------------------------------------------	---------------------------------------------------------------------

