

**PENTAX**  
MEDICAL

**INSTRUCTIONS FOR USE**

# ***EPIK-i7010***

*PENTAX Medical VIDEO PROCESSOR*

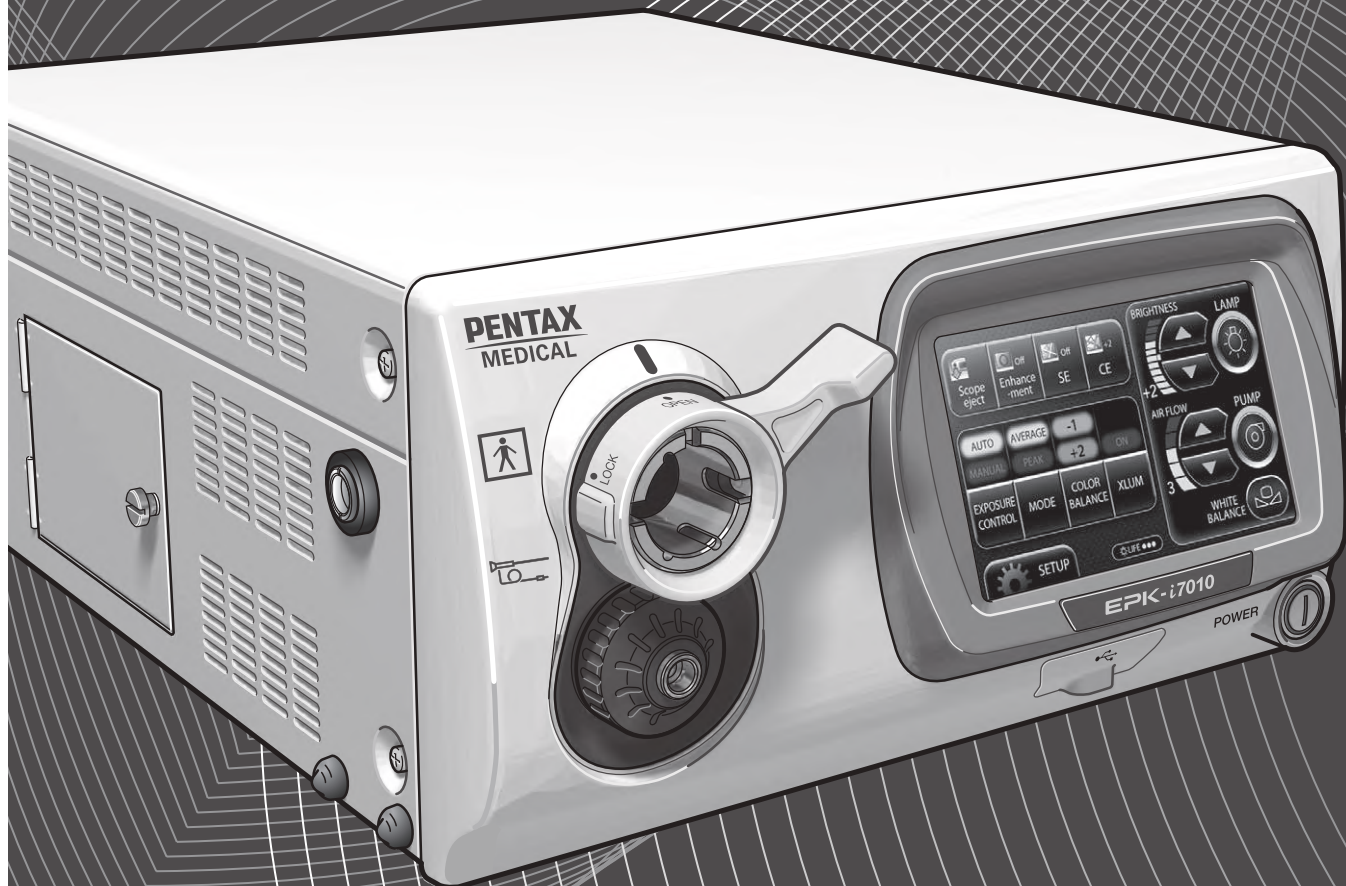

## INDICATION FOR USE:

The PENTAX Medical EPK-i7010 Video Processor is intended to be used with the PENTAX camera heads, endoscopes, light sources, monitors and other ancillary equipments for endoscopic diagnosis, treatment and video observation.

The PENTAX Medical EPK-i7010 includes a digital post-processing imaging enhancement technology (PENTAX i-Scan™) and a optical imaging enhancement technology (OE). These imaging enhancement technologies are intended to be used as an optional adjunct following traditional white light endoscopy and is not intended to replace histopathological sampling. i-Scan and OE are compatible with PENTAX video endoscopes.

### DEVICE DESCRIPTION:

The PENTAX Medical EPK-i7010 video processor consists of a video system, integrated light source, monitor, and ancillary equipment. This processor is intended for endoscopic diagnostic, treatment and video observation.

The PENTAX Medical EPK-i7010 video processor contains two types of contrast enhancement techniques: PENTAX i-Scan technology, and optical enhancement (OE) technology. PENTAX i-Scan technology is a digital filter-based contrast enhancement technique, while OE technology combines the band limited light and the digital processing.

PENTAX i-Scan technology has three modes, i-Scan 1, 2 and 3. i-Scan 1 enhances image topography and edges and i-Scan 2 and 3 enhances the color tone of the image by dissecting and recombining the individual red, green and blue (RGB) components of a white light image.

PENTAX i-Scan modes 1, 2, and 3, are intended to give the user an enhanced view of the texture of the mucosal surface and blood vessels. i-Scan 1 provides the user with a view that sharpens surface vessels and enhances surface texture of the mucosa. i-Scan 2 provides the user with increased visibility of blood vessels while also providing the same enhancements to the mucosa achieved in i-Scan 1. i-Scan 3 provides the user with increased visibility of blood vessels including dimly illuminated far-field regions while also providing the same enhancement to the mucosa achieved in i-Scan 1. The user can select either white light image or i-Scan modes by pressing a pre-programmed button on the scope, by using a pre-programmed foot pedal or by pressing a keyboard button. i-Scan is intended to be used as an optional adjunct following traditional white light endoscopy and is not intended to replace histopathological sampling.

The PENTAX Medical EPK-i7010 video processor is equipped with two optical filters placed inside Xenon lamp light path to provide optical enhancement (OE), which combines the band limited light and the digital processing. PENTAX OE technology has two modes, OE Mode1, 2.

In addition to i-Scan, OE Mode1 and 2 are intended to provide alternative methods to improve blood vessel visibility (emphasizes mucosal microvasculature and fine mucosal structures) on the mucosal surface by combination of band limited light illumination source. OE Mode1 uses a spectral filter that transmits band limited green and blue light and is intended to provide the user with enhanced image of blood vessels and fine structure of mucosa. OE Mode2 uses a different spectral filter that transmits band limited red, green and blue light and is intended to provide the user with enhanced image of blood vessels and fine structure of mucosa in an image closer to white light image.

The user can select either white light image or OE modes by pressing a pre-programmed button on the scope, by using a pre-programmed foot pedal or by pressing a keyboard button. OE is intended to be used as an optional adjunct following traditional white light endoscopy and is not intended to replace histopathological sampling.

White light is captured from a 300 Watt xenon lamp housed in the PENTAX Medical EPK-i7010 video processor. All visualization is done with the white light mode first. White light (BGR) illuminates the tissue and transfers the captured light through the video scope or a charged coupled device (CCD). Note that the white light visualization mode is always used first by the physician. For i-Scan image enhancement, the modification of the combination of RGB components for each pixel occurs when the i-Scan function is turned on in the PENTAX Medical EPK-i7010 video processor. The resulting i-Scan image is then displayed on the observation monitor. For OE image enhancement, one of the two optical filters corresponding to Mode1 and Mode2 are inserted into illumination light path when the OE function is turned on in the PENTAX Medical EPK-i7010 video processor. The resulting OE image is then displayed on the observation monitor.

## **FUNCTIONS USED FREQUENTLY:**

The functions used frequently on this equipment are the still image display function, image capture function, white balance adjustment function, and patient information registration/display function.

## **APPLICATION:**

- ① Intended medical use: Observation of body cavities (Lighting and air/water supply through a connected endoscope and monitor output of observed images from the endoscope itself)
- ② Patient populations: Patients ranging from pediatric to adult (Patients who are considered suitable for the application of equipment by the physician)
- ③ Intended anatomical area (tissues/organs):  
Pharynx; Larynx; Esophagus; Stomach; Duodenum; Small Intestine; Large Intestine; Pancreatic and Biliary Duct; Trachea; Bronchial Tree; Ear; Nasal Passage; Kidney; Renal Cavity; Renal Calyces; Urethra; Endometrial Canal (all require endoscope connection)
- ④ User: An operator with experience, or an operator working under the supervision of someone with experience
- ⑤ Usage environment: Hospitals, Ambulatory Surgery Centers, and Medical Clinics

## **IMPORTANT:**

This Instructions for Use (IFU) describes the recommended procedures for inspecting and preparing this video processor prior to its use and the care and maintenance after its use. It does not describe how an actual procedure is to be performed, nor does it attempt to teach the beginner the proper technique or any medical aspects regarding the use of the equipment.

Failure to follow the instructions in this IFU may result in damage to and/or malfunction of the equipment. If you have any questions regarding any of the information in this IFU or concerns pertaining to the safety and/or use of this equipment, please contact your local PENTAX Medical service facility.

### **CAUTION**

After the product has been delivered, promptly install, set up, and start using the equipment. Avoid storing the equipment over an extended period of time without using.

## **TRADEMARKS:**

- PENTAX is either registered trademark or trademark of HOYA Corporation.
- PENTAX Medical is the trademark of HOYA Corporation.
- Windows 7, Windows 7 Ultimate, Windows Media Player are either registered trademarks or trademarks of Microsoft Corporation in the United States and/or other countries.
- All other product names mentioned in this IFU provided with this processor are registered trademarks or trademarks of their respective manufacturers.

# Contents

<b>1</b>	<b>Safety Precautions - Important</b>	<b>1</b>
<b>2</b>	<b>Nomenclature, Controls, and Functions</b>	<b>5</b>
	Main Unit .....	5
	Touch Panel .....	6
	Rear Panel.....	7
	PENTAX Medical Water Bottle Assembly (OS-H5).....	8
<b>3</b>	<b>Preparation</b>	<b>9</b>
	System Configuration .....	9
	Installation .....	10
	Connecting a Video Endoscope .....	17
<b>4</b>	<b>Pre-use Inspections</b>	<b>19</b>
	Power-On and Lamp Inspection .....	19
	On-screen Image Check.....	20
	Automatic Brightness Control Inspection.....	20
	Endoscope Control Button.....	20
	Exposure and Measurement Inspection .....	21
	Color Adjustment .....	21
	Suction Inspection .....	21
	Air/Water Supply Inspection .....	22
<b>5</b>	<b>Operating Procedure</b>	<b>23</b>
	Turning On/Off the Processor.....	23
	Monitor Screens .....	23
	Touch Panel Operation.....	25
	i-scan .....	30
	Optical Enhancement (OE).....	32
	Image Processing Settings.....	33
	Setup Menu Operations.....	35
	[i-scan] Tab .....	35
	[Image] Tab.....	39
	[Customize] Tab.....	44
	[System] Tab.....	58
	[Peripheral] Tab .....	71
	Keyboard Operations.....	72
	Operations in the Keyboard Menu Screen .....	75
	Operations in the [Patient list preset] Tab.....	75
	Operations in the [User list preset] Tab .....	77
	Settings in the [Setup] Tab .....	78
<b>6</b>	<b>Maintenance</b>	<b>80</b>
	After Use.....	80
	Cleaning and Storage of the Water Bottle Assembly .....	81
	Storage .....	81
	Replacing the Lamp.....	82
	Replacing the Fuses .....	84
	Repair .....	85

<b>7</b>	<b>Troubleshooting</b>	<b>86</b>
<b>8</b>	<b>Specifications</b>	<b>91</b>
<b>9</b>	<b>Electromagnetic Compatibility</b>	<b>92</b>

The following precautions should always be exercised with the use of all electro-medical equipment to ensure safety to all involved parties - user(s), patient(s), etc.

Please carefully read and follow this IFU.

## 1-1. TRAINING

1. This equipment should only be used under the supervision of a trained physician in a medical facility. Do not use in other locations or for any other purposes than the intended application. Failure to observe this precaution may result in personal injury.

## 1-2. INSTALLATION

1. This equipment should NEVER be installed or used in areas where the unit could get wet or be exposed to any environmental conditions such as high temperature, humidity, direct sunlight, dust, salt, etc., which could adversely affect the equipment.
2. This equipment should NEVER be installed or used in the presence of flammable or explosive gases or chemicals.
3. This equipment should NEVER be installed, used or transported in an inclined position nor should it be subjected to impact or vibration.
4. For safety reasons, this equipment must be properly grounded.
5. Ensure that all power requirements are met and conform to those specified on the rating plate located on the rear panel.
6. Do not block the air intake vent grid of this equipment.
7. Do not allow the power cord to become twisted, crushed or pulled taut.
8. When using an isolation transformer for any ancillary equipment, ensure the power requirements of the devices do not exceed the capacity of the isolation transformer. For further information, contact your local PENTAX Medical service facility.

## 1-3. PRIOR TO USE

1. Confirm that this equipment functions properly and check the operation of all switches, indicators, etc.
2. To prevent electrical shock when used with endoscopes, this equipment is insulated (type BF electro-medical equipment). Do not allow it to be grounded to other electrical devices being used on the patient. Rubber gloves should always be worn to prevent grounding through user(s).
3. Confirm that other devices used in conjunction with this equipment function properly and that these other devices will not adversely affect the operation or safety of this equipment. If any component of the endoscopic system is not properly functioning, the procedure should not be performed.
4. Check and confirm that all cords or cables are connected correctly and securely.
5. The lamp life when used in this equipment is 500 hours. Prior to use, check the lamp life indicator on the operation panel to ensure the indicator is lit green. After 500 hours of use, the indicator turns red and the image quality will deteriorate. The lamp life could be affected by frequency of use. In which case, the lamp life might become shorter than 500 hours.
6. Right after turning on the power of the processor, wait till the backlight of the touch panel comes on. Using the operation panel or the keyboard before the backlight comes on would result in system malfunction.

## 1-4. DURING USE

1. To prevent electric shock, the endoscope and/or any other ancillary device should NEVER be applied directly to the heart.
2. Make sure that no contact is made between the patient and this equipment.

- 3. To avoid damage to the luminous display and flat membrane switches, do not press any keys with any sharp or pointed objects.
- 4. The light emitted by the Xenon lamp is extremely intense. Avoid looking directly at the light exiting the endoscope and/or this equipment.
- 5. To protect the users eyes and avoid risk of thermal injury during an endoscopic examination, use only the minimum amount of brightness required.
- 6. During clinical procedures, avoid unnecessary prolonged use which could compromise patient/user safety.
- 7. Continually monitor this equipment and the patient for any signs of irregularities.
- 8. In the event that some type of irregularity is noted to the patient or this equipment, take the appropriate action to ensure patient safety.
- 9. If the operation of any of the components of the endoscopic system fails during the procedure and the visualization of the procedure is lost or compromised, place the endoscope in the neutral position and slowly withdraw the endoscope.
- 10. This equipment should only be used according to the instruction and operating conditions described in this IFU. Failure to do so could result in compromised safety, equipment malfunction or instrument damage.
- 11. The equipment may become hot during use. Take special care when touching the equipment.
- 12. If an error message is displayed on the monitor, follow the message instruction. Failure to do so could result in compromised safety for patient and/or user or equipment malfunction.
- 13. When the observation object moves quickly, the after image might appear on the monitor.
- 14. The processor's performance could be negatively affected by electromagnetic waves emitted from cellular phones or other portable wireless equipments. Recommended separation distance between the processor and the portable/mobile equipment is shown on a table near the end of this IFU. Follow these recommendation to avoid electromagnetic interference by the portable/mobile equipments.

**1-5. AFTER USE**

- 1. The equipment may become hot immediately after use. Take special care when touching the equipment.
- 2. Refer to the operating instructions provided with all the components of the endoscopic system to establish the right order in which components should be turned off. Some peripheral devices may have to be turned off first to avoid compromising their operation.
- 3. Wipe all surfaces clean with gauze slightly dampened with alcohol.
- 4. Be sure connector interfaces and air intake vents are not allowed to become wet or splashed with liquids.
- 5. Clean this equipment regularly. Remove substances on movable units as well as dirt on the surface. Substances on endoscope locking lever and/or endoscope electrical connector may cause malfunction.

**1-6. STORAGE**

- 1. This equipment should NEVER be stored in areas where the unit could get wet or be exposed to any environmental conditions such as high temperature, humidity, direct sunlight, dust, salt, etc., which could adversely affect the equipment.
- 2. This equipment should NEVER be stored in the presence of flammable or explosive gases or chemicals.
- 3. This equipment should NEVER be stored or transported in an inclined position, nor should it be subjected to impact or vibration.
- 4. Cords, accessories, etc., should be cleaned by wiping the surface with alcohol-dampened gauze and neatly stored.
- 5. This equipment should be maintained in a clean condition during storage and be ready for subsequent use.

**1-7. SERVICE**

- 1. Alterations/modifications to the equipment should NEVER be made. Repairs should only be performed by an authorized PENTAX Medical service facility.
- 2. When replacing the lamp, use only the lamp recommended by PENTAX Medical and follow all PENTAX Medical instructions provided.

## 1-8. MAINTENANCE

- Periodically this equipment and any applicable accessories should be inspected for operation and safety.

## 1-9. DISPOSAL

- The equipment should be returned for disposal to PENTAX Medical.  
Contact your local PENTAX Medical representative or service facility.



### An information on Disposal for users in the European Union

This product is a medical device. In accordance with European Directive 2002/96/EC on Waste Electrical and Electronic Equipment, this symbol indicates that the product must not be disposed of as unsorted waste, but should be collected separately. Contact your local PENTAX Medical service facility for correct disposal and recycling.

By disposing of this product correctly you will help ensure that the waste undergoes the necessary treatment, recovery and recycling and thus prevent potential negative effects on the environment and human health which could otherwise arise due to inappropriate waste handling.

## POWER REQUIREMENTS

Check the standard power plug configurations that are used in your country. If the appropriate power cord is not included in your product, notify your local PENTAX Medical service facility.

## SOFTWARE VERSION

The software version of the products corresponding to this IFU is described on its back cover.

## SYMBOLS ON MARKING



Manufacturer



Date of manufacture



Alternating current



Type BF applied part (Safety degree specified by IEC 60601-1)



Switches the power on and off.



Warning



Warning, electricity



Caution



Warning; Hot surface



Protective earth (ground)



Equipotentiality



Instructions for Use



Follow the Instructions for Use



Endoscope



Illumination lamp model



Authorized representative in the European Community

## CONVENTIONS

The following conventions have been established in the text of this IFU to aid in the identification of potential hazards of operation:



: Could result in death or serious injury.



: May result in minor or moderate injury or property-damage.



: May result in property-damage. Also, advises owner/operator about important information on the use of this equipment.

## Main Unit

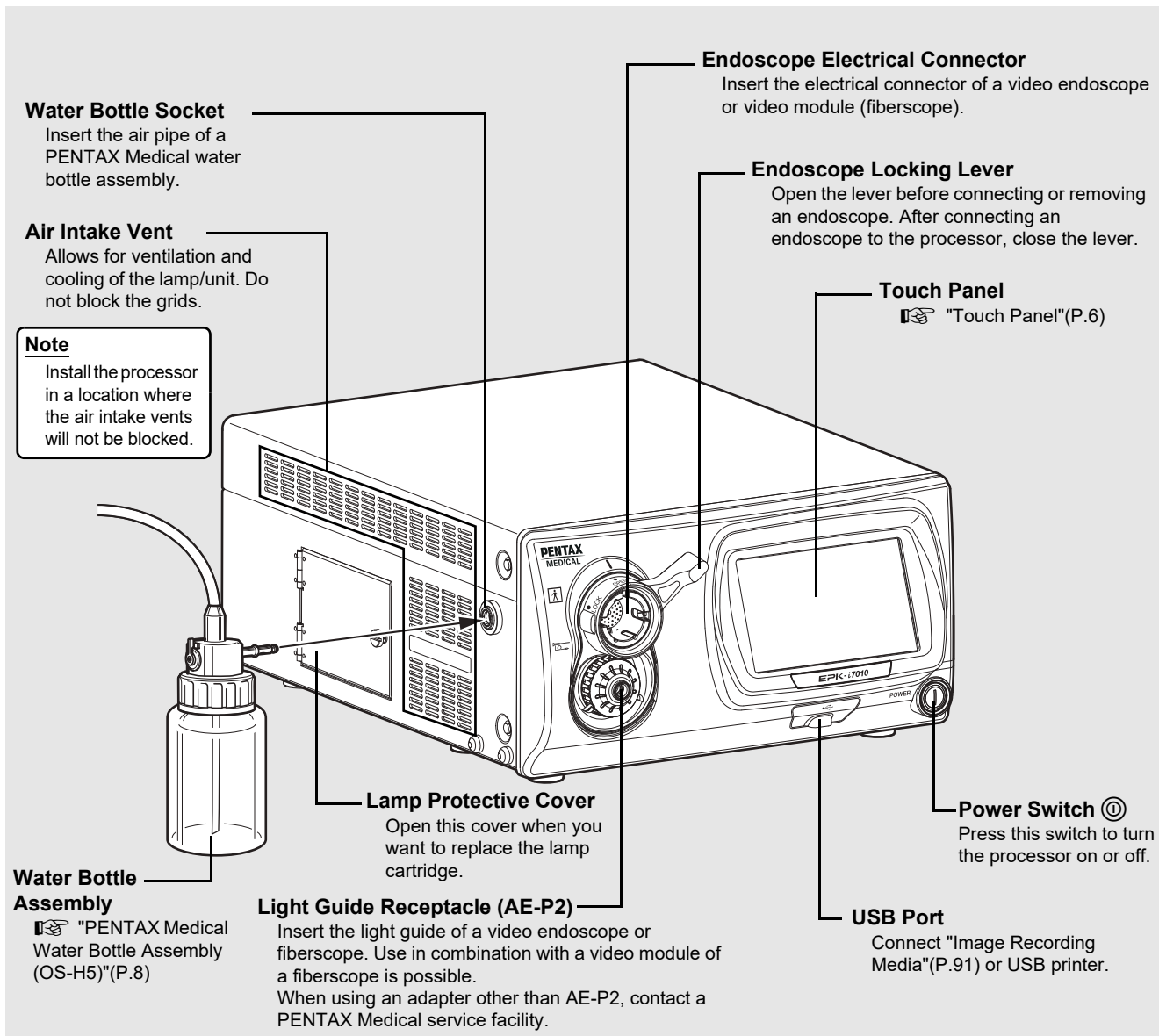



### NOTE

- Always insert an endoscope prior to turning on the processor. Also, always turn off the processor before removing an endoscope.
- Before turning on the processor, make sure the air intake vents are not blocked.
- The lamp of the processor should be turned off except during pre-use inspections and clinical use.
- After connecting an endoscope to the processor, check that the endoscope is firmly secured and that the endoscope locking lever is in the LOCK position.

### CAUTION



- Immediately after use, the metal light guide prong and the electrical contacts/pins of the endoscope may be hot. To avoid burns, do not touch these parts immediately after use. For safe handling after a procedure, grasp the PVE connector housing of the endoscope.
- The light emitted by the Xenon lamp is extremely intense. Avoid looking directly at the light exiting this equipment without Light Guide Receptacle being attached.



# Touch Panel

**COLOR BALANCE Button**  Use this button to display the color balance adjustment screen.  
 "Color Balance Button"(P.28)

**Brightness Setting Buttons**  
 Use  to adjust the brightness level.  
 "Brightness Setting Buttons"(P.26)

**Customize Buttons**  
 Each press of a button changes the setting of the indicated function. You can set the functions you use very frequently for these four buttons. Depending on the function, the setting may be displayed on the top right of a button.  
 "Customize Buttons"(P.29)

**XLUM ON/OFF Button**  Use this button to maximize the light intensity of the endoscope.  
 "XLUM ON/OFF Button"(P.29)



**Pump Level Setting Buttons**  
 Use  to adjust the strength of the pump.  
 "Pump Level Setting Buttons"(P.27)

**MODE Button**  Use this button to select the light measuring method.

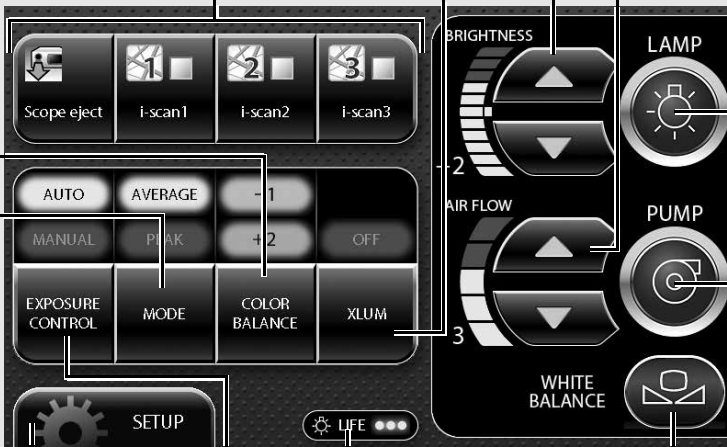

**AVERAGE:** Adjust the [BRIGHTNESS] level in relation to the average value of the brightness of the video signal.  
**PEAK:** Adjust the [BRIGHTNESS] level in relation to the maximum value of the brightness of the screen.



 "Mode Button"(P.28)



**EXPOSURE CONTROL Button**  Use this button to change the method of adjusting the screen brightness.  
**AUTO:** Adjust the screen brightness automatically.  
**MANUAL:** Adjust the screen brightness manually.  
 "Exposure Control Button"(P.28)

**LAMP Button**  Use this button to turn the lamp on or off.  
 "Lamp Button"(P.26)

**PUMP Button**  Use this button to operate or stop the air/water pump.  
 "Pump Button"(P.26)

**WHITE BALANCE Button**  Use this button to adjust the white balance.  
 "White Balance Button"(P.27)

**SETUP Button**  Use this button to display the setting menus.  
 "Setup Button"(P.29)

**Lamp Life Indicator [LIFE]**  
 The lamp usage time is indicated by this indicator.  
 3 green circles: Less than 400 hours  
 2 green circles: 400 hours to 449 hours  
 1 yellow circle: 450 hours to 499 hours  
 1 red circle: 500 hours or more (the lamp needs to be replaced)  
 "Replacing the Lamp"(P.82)

## NOTE

- The lamp life is 500 hours. Check the LIFE indicator (lamp life indicator) on the touch panel before using the processor. Replace the lamp cartridge if a red circle is displayed on the LIFE indicator. The lamp life may not be as long as 500 hours depending on the method of use and operating environment.  
 "Replacing the Lamp"(P.82)
- When pressing a button on the touch panel, make sure to press the center of the button. If the edge of the button is pressed, the system might activate the button that is next to the button you intended to press.
- When pressing a button on the touch panel, make sure that the setting/configuration change that was intended to be made in the previous press has been correctly applied. Pressing a button in succession may cause a system error. If a system error occurs, turn the power off and then on again.

# Rear Panel

2

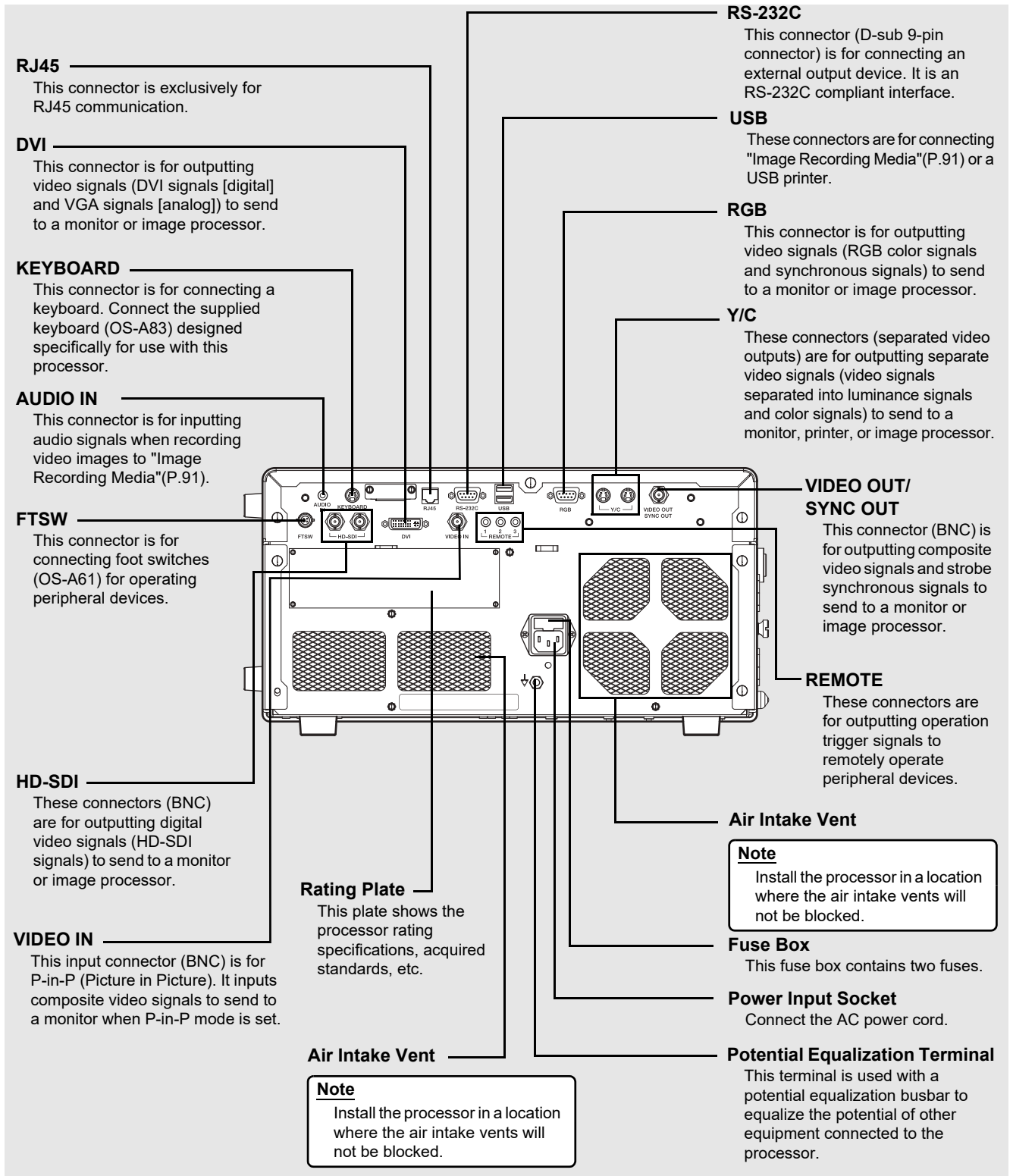

**WARNING**

- To avoid the risk of electric shock, this equipment must only be connected to a power supply with protective earth.
- This equipment must be connected to an appropriate power supply.

**CAUTION**

Make sure to firmly connect each connector to the specified position. Failing to do so could cause certain function to be unavailable.

## PENTAX Medical Water Bottle Assembly (OS-H5)

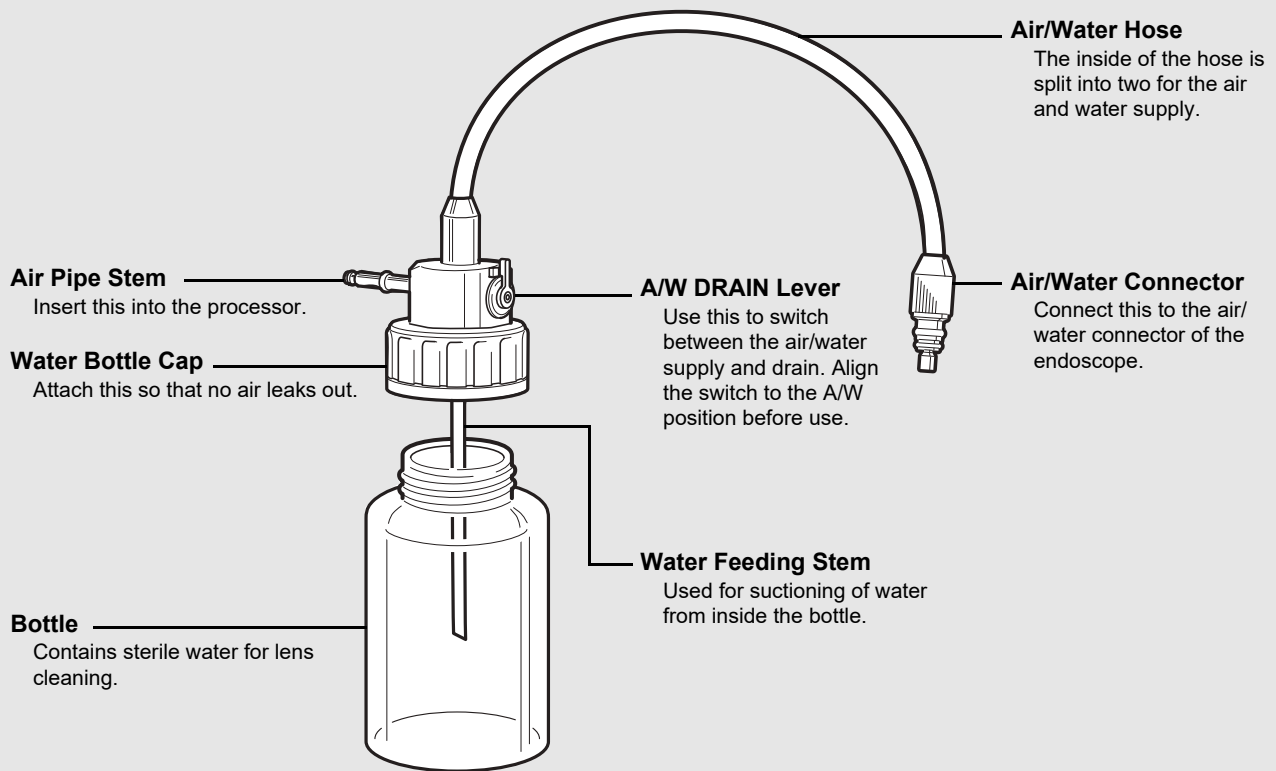

2

### NOTE

When cleaning and sterilizing the water bottle assembly (OS-H5), follow the instruction given in the Instructions for Use for OS-H5.

# 3 Preparation

## System Configuration

The following shows examples of system configurations for using the processor.

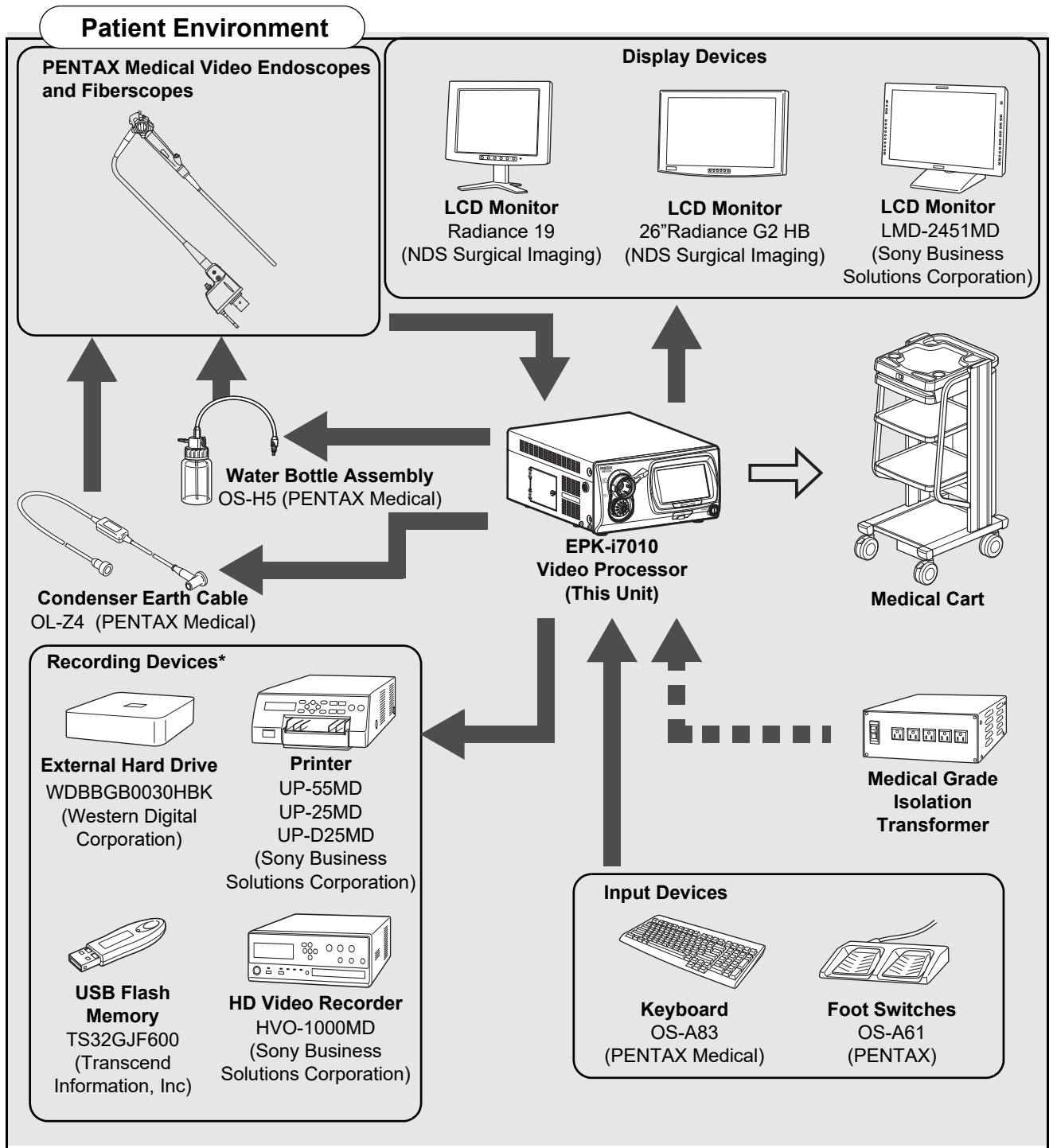

**NOTE**

Recording devices specified in the diagram have been tested for compatibility with the EPK-i7010. Equivalent devices can be used but may not be compatible with the EPK-i7010.

## NOTE

- For peripheral devices, use the recommended devices shown above or equivalent products.
- PENTAX Medical recommends the devices shown above based on the independent test results.
- The processor or the peripheral devices may not operate normally by the combination of their connections including the recommended devices.
- When any connected peripheral devices are added, use the processor and the peripheral devices after confirming their normal operations by checking their connected combinations.
- The data may not be recorded properly if non-compatible external hard drive or non-compatible USB flash memory is used, or if the USB flash memory is connected to the USB port of this product using USB extension cable.

## Installation

### ■ Installing the Processor in a Cart

Install the processor and peripheral devices in a cart while referring to the installation examples in "System Configuration" (P.9). Place the cart on a stable and level surface.

#### WARNING

- The processor is an electro-medical device incorporating precision components and sophisticated circuitry so do not install it in a location where it will be subject to harsh conditions, including excessive vibrations and/or severe impact. Never drop the processor or subject it to a severe impact as doing so could compromise the functionality and/or safety of the unit. Should this equipment be mishandled or dropped, do not use it. Return it to an authorized PENTAX Medical service facility for inspection and repair.
- Because of the adverse effect that one equipment could cause to another equipment, it is possible that the correct operation of this processor could be compromised if another equipment is placed right nearby or stacked on top of the processor. If such situations cannot be avoided for extenuating reasons, be sure to check the correct operation of each equipment before using them in clinical use.
- Do NOT block the ventilation grids on the sides and at the back of the processor. In particular make sure to separate the ventilation grids on the processor's left side at least 15 cm (6 inches) from the wall. Blocking ventilation may cause equipment temperature to rise.

#### CAUTION

- When you raise this processor, hold the portion from the both sides shown in the figure.
- Make sure to firmly connect each connector to the specified position. Failing to do so could cause certain function to be unavailable.
- Install the processor on a stable and level surface (cart, counter, stand, etc.).
  - Avoid places where the processor may be splashed with liquid.
  - Never use the processor where explosive or flammable gases are present.
  - Do not install the processor where it will be exposed to high temperature and humidity or direct sunlight.
  - Do NOT use this equipment by installing it to stand vertically. Doing so will hinder the air to vent through the ventilation grid, and eventually it will become the cause of product damage.
- Never install, operate, or store electro-medical equipment in a dusty place. The accumulation of dust within the equipment may cause a malfunction, smoke, or ignition.
- Do not block the air intake vents on the back and the sides of the processor.
- When moving the processor, do not hold the endoscope locking lever.
- Connect a water bottle assembly (OS-H5) before using the processor.
- When loading the processor on a shelf of the cart, provide sufficient space for attaching or detaching the water bottle assembly (OS-H5) easily.

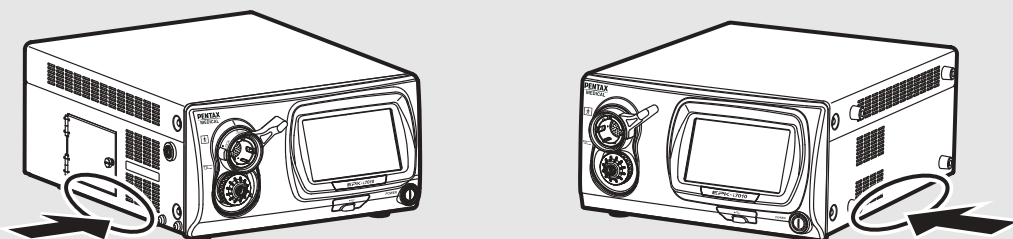

## ■ Connecting a Power Supply

Connect the power cord to a suitable power outlet with a protective earth terminal that meets the power rating indicated on the rating plate or a medical grade isolation transformer. When peripheral devices are used, connect the devices to the medical grade isolation transformer of the appropriate power rating in order to reduce the risk of electric shock.

### ⚠ WARNING

- To reduce the risk of electric shock, connect the power cord of the equipment into a power outlet with protective earth.
- When peripheral devices such as a monitor are used, connect the devices to the medical grade isolation transformer of the appropriate power rating. Do not connect the devices which are not used to the isolation transformer.

### ⚠ CAUTION

- Check that the total power consumption of all connected devices does not exceed the isolation transformer's power rating.
- Make sure that output is in compliance with IEC 60601-1.
- Make sure that the power cord is connected to a suitable power outlet with a protective earth terminal.

3

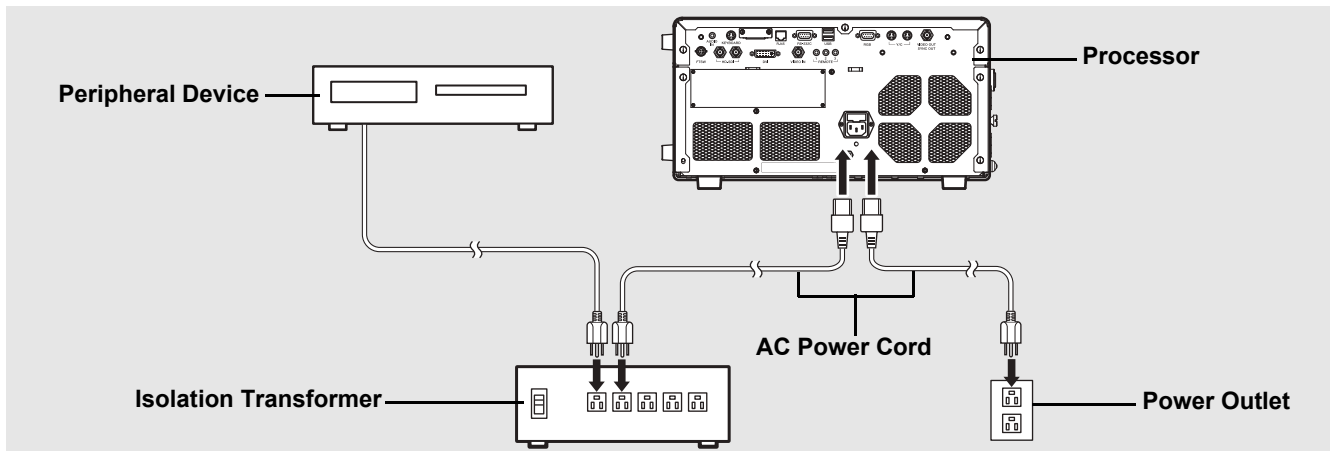

- 1 **Connect the AC power cord to the power input socket of the processor.**
- 2 **Connect the power cord to a suitable power outlet with a protective earth terminal that meets the power rating indicated on the rating plate or a medical grade isolation transformer.**
  - Make sure the processor is turned off beforehand. If the switch has “looseness”, the processor is turned on. If the switch has “looseness”, push the switch again and confirm there is no “looseness”.
  - When connecting peripheral devices to an isolation transformer, make sure the peripheral devices are turned off beforehand. For details, refer to the IFU for the peripheral devices.

## ■ Connecting Peripheral Devices

Connect the peripheral devices to the processor. Make sure the processor and peripheral devices are turned off beforehand.

### ! WARNING

When connecting peripheral equipments to the processor, use only the cables specified in this IFU. If different cables are used, the equipments' resistance to the electromagnetic waves will change, and the equipments could cause adverse effect to each other. If you use different cables, please contact your local PENTAX Medical service facility.

### ! CAUTION

- Before connecting peripheral devices, check that the devices operate correctly.
- Before connecting or removing peripheral devices, make sure the processor and peripheral devices are turned off.
- To avoid malfunction caused by changing the connecting configuration, use after confirming the normal operation of the processor and the peripheral devices by checking adequately.
- Since the processor may not operate normally if the peripheral devices are removed while in use, be sure to remove them after turning off the power.
- To avoid malfunction caused by updating or upgrading of the peripheral devices, use after confirming the normal operation of the processor and the peripheral devices by checking adequately.
- When used near a radio or TV receiver in clinical or residential areas, the processor may be subjected to radio interference.
- To reduce electromagnetic interference, do not keep turning on the main power switch of the processor while an endoscope is connected but not ready for use.
- To avoid and resolve adverse electromagnetic effects, do not operate the processor near RF (Radio Frequency) generating equipment.

3

## ● Connecting a Monitor or Recorder

Connect a monitor or recorder to the processor. For details, refer to the IFU for the monitor and recorder.

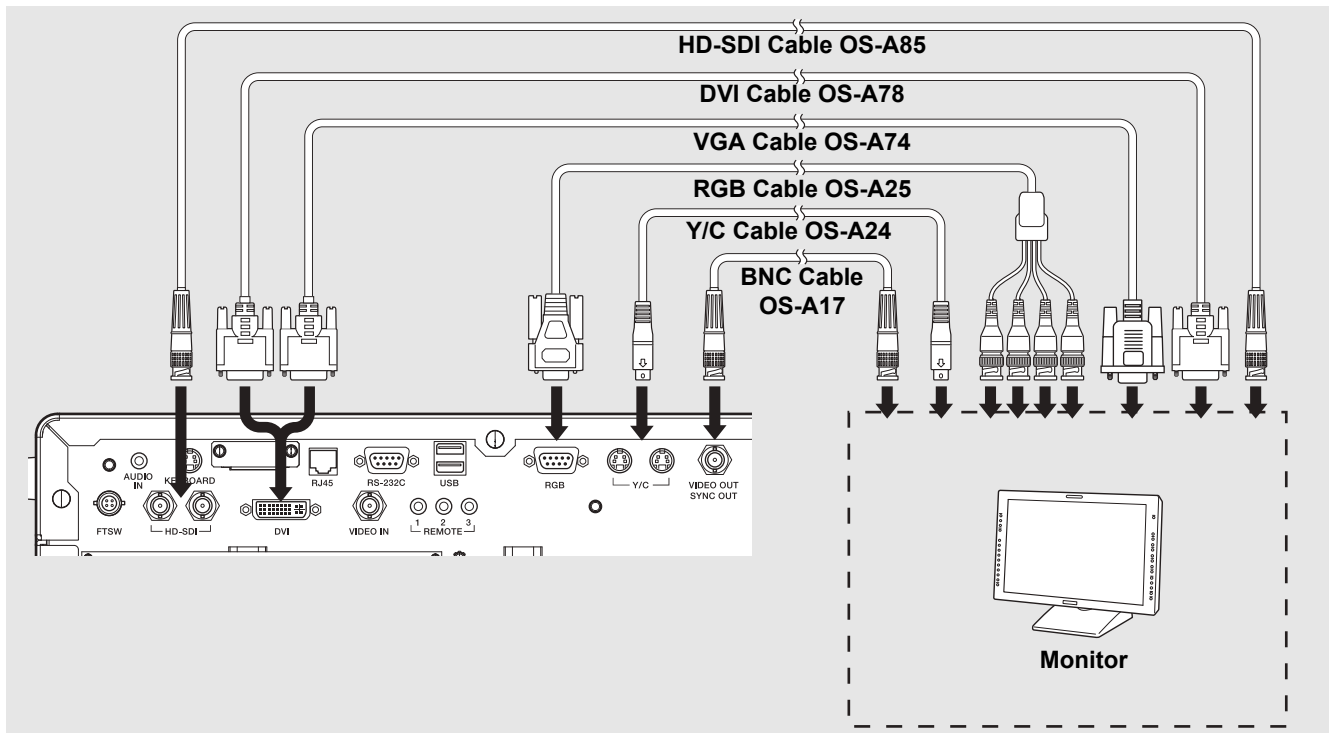

### ! CAUTION

- The range of display may not match with the following connection methods because the image output specifications differ.

### Connecting a monitor or recorder with an HD-SDI input connector (BNC) (recommended)

Use the PENTAX Medical HD-SDI cable (OS-A85) to connect an HD-SDI connector to an HD-SDI input connector on the monitor(26"Radiance G2 HB).

**Connecting a monitor or recorder with a DVI or VGA input connector**

Use the PENTAX Medical DVI cable (OS-A78) to connect the DVI connector to a DVI input connector of the recorder(HVO-1000MD), or use the PENTAX VGA cable (OS-A74) to connect the DVI connector to a VGA input connector on the monitor(Radiance19).

**Connecting a monitor or recorder with a composite video input connector**

Use the PENTAX Medical BNC video cable (OS-A17) to connect the VIDEO OUT/SYNC OUT connector to a video input connector on the monitor or recorder.

**Connecting a monitor or recorder with an RGB input connector (BNC)**

Use the PENTAX Medical RGB cable (OS-A25) to connect the RGB connector to the RGB input connector on the monitor.

**Connecting a monitor or recorder with a 4-pin female mini-DIN connector**

Use the PENTAX Medical Y/C cable (OS-A24) to connect a Y/C connector to the 4-pin female mini-DIN connector on the monitor or recorder.

**NOTE**

Depending on the setting of the monitor screen, endoscopic image or text information might spill out of the screen. Adjust the display position by performing overscan/underscan adjustment or vertical/horizontal adjustment and make sure that the image as well as text is correctly displayed on the screen.

## ● Connecting a Printer, USB Flash Memory or External Hard Disk Drive

Connect a printer or "Image Recording Media" (P.91) to the processor.  
For details on a printer, refer to the IFU for the printer.

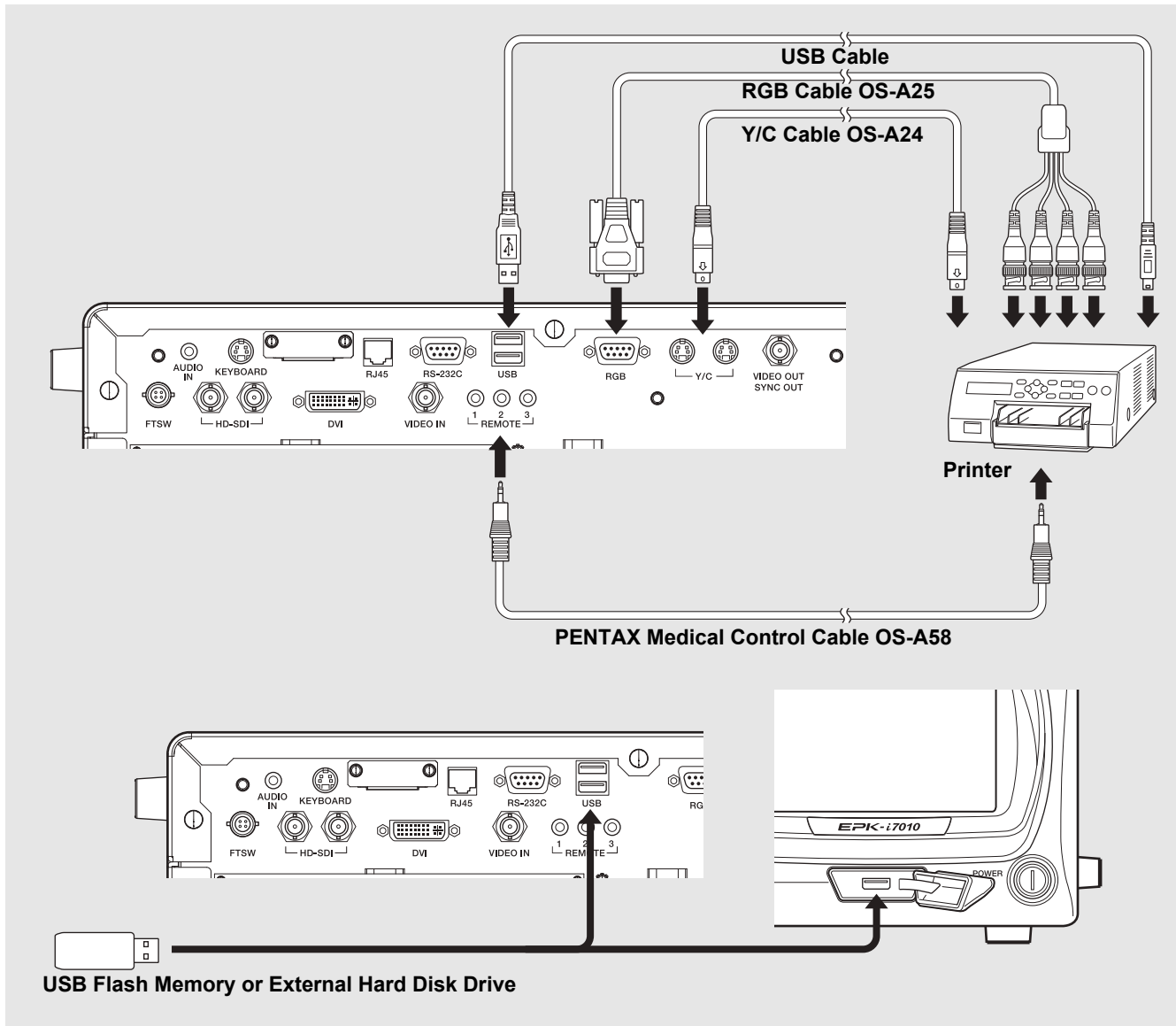

3

### Using RGB output method

Use an RGB cable (OS-A25) to connect the RGB connector to the connector on the printer.

### Using Y/C output method

Use a Y/C cable (OS-A24) to connect the Y/C connector to the connector on the printer(UP-55MD).

### Connecting a printer with an video input connector

Connect the VIDEO OUT/SYNC OUT terminal of the processor with video input terminal of the printer (UP-25MD) using a BNC cable (OS-A17).

### Connecting a USB printer

Use a USB cable(2.0m) to connect a USB port on the front or rear of the processor to the port on the USB printer(UP-D25MD ).

### ! CAUTION

- When using a printer, be sure to adjust the settings of the printer so that the colors in images appear the same on the monitor and in printouts.
- Compatible USB printer with the processor is UP-D25MD (Sony Business Solutions Corporation).

### Connecting USB flash memory

Connect the USB flash memory(TS32GJF600) to a USB port on the front or rear of the processor.

### Connecting an external hard disk drive

Connect the external hard disk drive (WDBBGB0030HBK) to a USB port on the front or rear of the processor.

#### NOTE

- Some Image Recording Media may not be recognized by the processor.
- It is possible that the correct data recording could be compromised because of using the USB3.0 compatible cable.

## ● Connecting Other Peripheral Devices

For details, refer to the corresponding IFU.

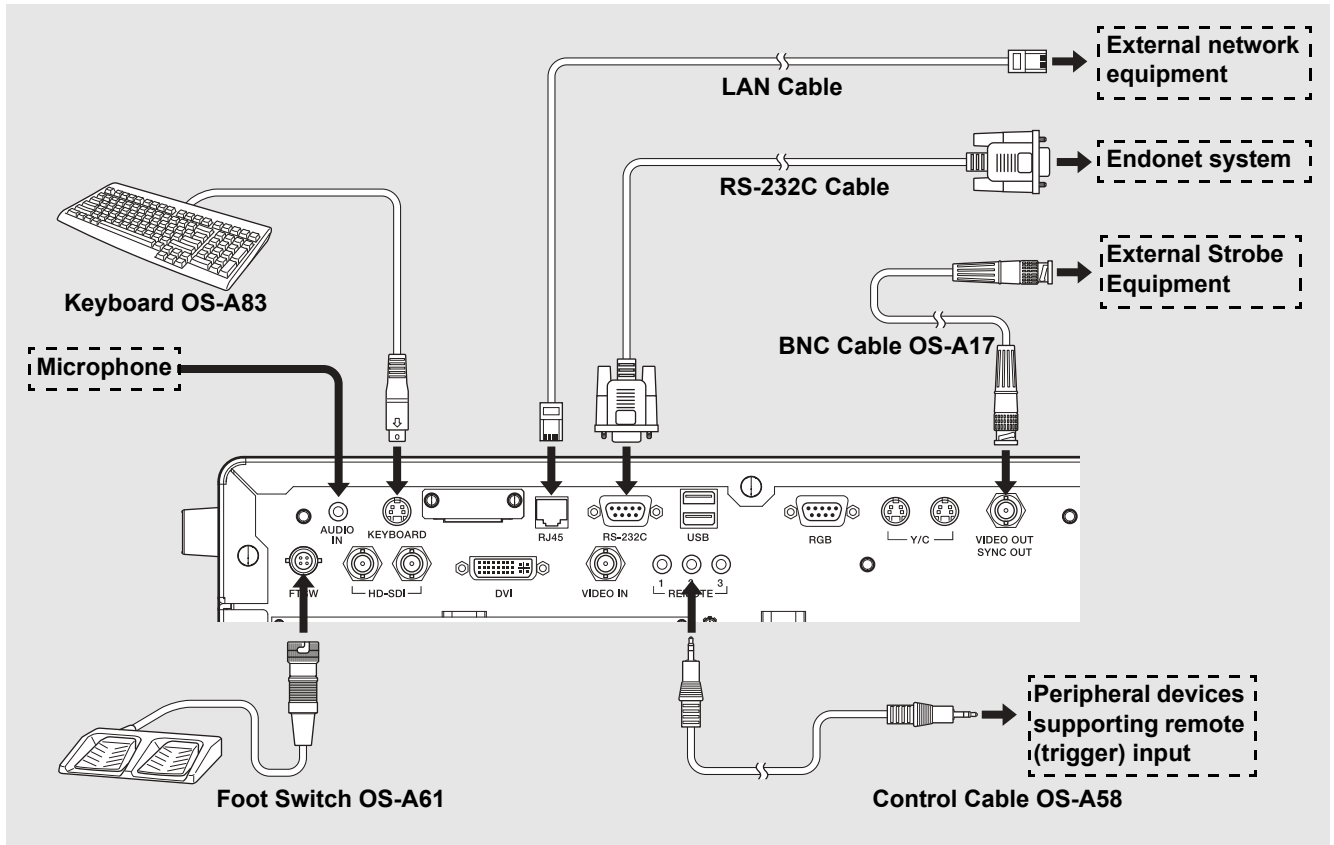

### Connecting a keyboard

Connect the PENTAX Medical keyboard (OS-A83) to the KEYBOARD connector.

### Connecting foot switches

Connect the PENTAX foot switches (OS-A61) to the FTSW connector.

### Connecting a peripheral devices supporting remote (trigger) input

When you want to use a peripheral device that includes support for remote (trigger) input, use a control cable (OS-A58) to connect the REMOTE connector to the remote connector on the peripheral device. For details on a peripheral device, refer to the IFU for the peripheral device.

### Connecting an external strobe device

Connect the VIDEO OUT/SYNC OUT connector to the signal connector on an external strobe device recommended by PENTAX Medical. For details on connecting a compatible device, refer to the IFU for the compatible device.

### Connecting a microphone

If you want to record video images with audio, connect a microphone to the AUDIO IN connector. Use a microphone (with the following specifications) recommended by PENTAX Medical.

Type: Stereo mini-plug (three pins)

Support for plug-in-power

Microphone characteristics: Sensitivity of -40 to -50 dB(0dB = 1V/1Pa, 1kHz)

### Connecting a computer with an RS-232C connector

Use an RS-232C cable (2.0m) to connect the RS-232C connector to the connector on the computer with Endonet installed. For details on connecting an Endonet equipment, refer to the Instructions for Use for the equipment.

### Connecting a computer with Endoimage2 installed

Connect one end of a LAN cable (5.0m) to the RJ45 port of a computer with Endoimage2 installed and connect the other end to the processor. For details on connecting compatible devices, refer to IFU for each compatible device.

### Connecting a compatible device recommended by PENTAX Medical

Connect the RJ45 connector and a compatible device recommended by PENTAX Medical. For details on connecting a compatible device, refer to the IFU for the compatible device.

### CAUTION

- When the processor is connected to an existing network environment through the RJ45 connector, it is necessary to use a router equipped with security functions between the RJ45 connector of the processor and network.
- Do not use a router to connect to other than the processor and the existing network.
- For details on the specification of the router, contact your PENTAX Medical service facility.
- This equipment is a Class B Medical Equipment (specified CISPR 11) and is intended for hospitals, ambulatory surgery centers, and medical clinics.
- Use the connection cable of length specified below:  
HD-SDI cable (2.0 m), DVI-A cable (2.0 m), Composite video cable (1.5 m), Y/C video cable (1.5 m), Control Cable (1.5 m), RS-232C cable (2.0 m), Audio cable (1.5 m), and Keyboard cable (1.65 m)
- Refer to [Peripheral] Tab(P.71) for a connection setup of the peripheral devices. Also refer to [Network setup](P.78) for a setup of the network connected with RJ45 terminal.
- This processor transmits an observation image, patient information, etc. to Endoimage2, and receives a still image capture command. To endoPRO, it transmits an observation image and receives patient information, a still picture capture command, etc..

### PENTAX Medical Policy on Antivirus Software

Connecting the processor to a network may result in the processor being exposed to computer viruses and security vulnerabilities. If the processor is connected to a security-compromised network or virus-infected computers and USB flash drives, this could cause the processor to be vulnerable to computer virus infection. For these reasons, you should consult with the IT coordinators in your hospital or clinic before connecting the processor to a network or USB flash drives via the LAN port or USB port. It is the responsibility of the customer to establish a secure network connection and ensure appropriate virus protection software is regularly updated and the network is configured with security. Due to the increasing major antivirus solutions and licensing issues, it is not possible for PENTAX Medical to predict and prepare appropriate antivirus solutions for each customer. Therefore, PENTAX Medical customers typically have to install virus protection software at each medical facility according to the policies of the facility.

# Connecting a Video Endoscope

Connect an endoscope to the processor. Connect the water bottle assembly and suction unit to the endoscope before use. For details on an endoscope, refer to the IFU for the endoscope.

- 1 Check to ensure the endoscope locking lever is open.
- 2 Insert the endoscope firmly into connector ① of the processor. Close the endoscope locking lever in the direction of ② until it clicks into position. (Refer to Figure 3.1.)

## NOTE

- After connecting the endoscope to the processor, make sure that the endoscope is firmly secured and that the endoscope locking lever is in the LOCK position.
- On rare occasions, noise may be temporarily displayed on endoscopic images immediately after the start-up video processor or endoscope connection.

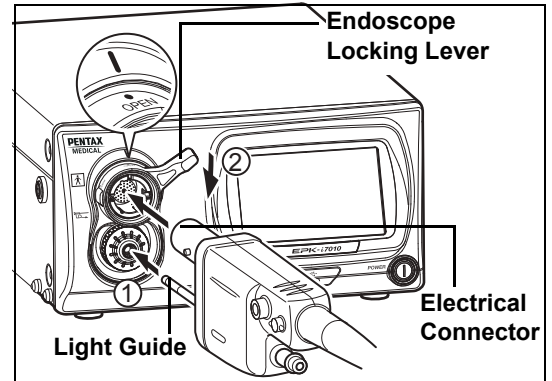

Figure 3.1

- 3 Fill the bottle approximately 2/3 full ( to the "200" marking on the bottle scale) with sterile water, and then screw the cap onto the bottle and securely tighten it.

## WARNING

Check whether there are any defects such as cracks on the water bottle assembly exterior. If there is a defect on the water bottle assembly, do not use it.

## NOTE

Do not overtighten the water bottle cap.

- 4 Align the A/W DRAIN lever with the A/W (air/water supply) position. (Refer to Figure 3.2.)
- 5 Insert the air pipe of the water bottle assembly into the water bottle socket of the processor until it clicks into position.

## NOTE

Do not use excessive force when pushing the water bottle towards the processor. Rough handling may cause water to leak from the bottle onto/into the video processor.

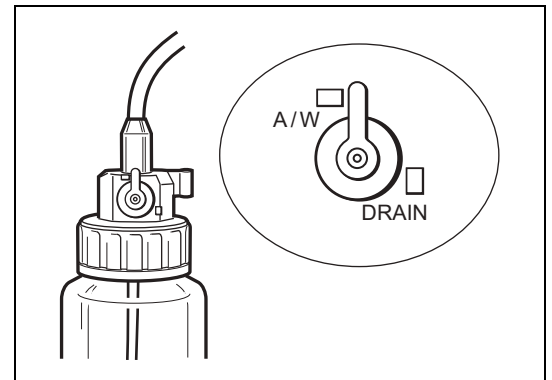

Figure 3.2

- Insert the air/water connector into the holder on the water bottle cap until the endoscope is connected. (Refer to Figure 3.3.)

## NOTE

- Remove the water bottle assembly before moving the processor to a place other than the usual place of use.
- Remove the water bottle assembly before packing the processor for transportation.

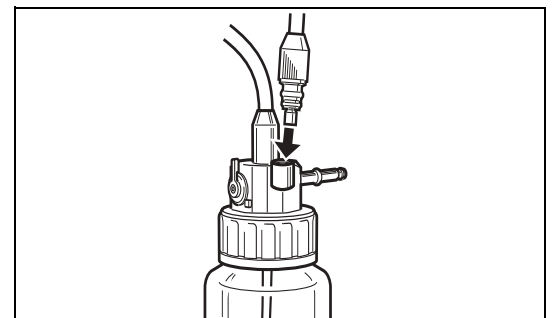

Figure 3.3

- 6 Connect the air/water connector to the air/water socket on the PVE connector of the endoscope. (Refer to Figure 3.4.)
- 7 Connect the suction tube of the suction unit to the suction nipple on the PVE connector of the endoscope.

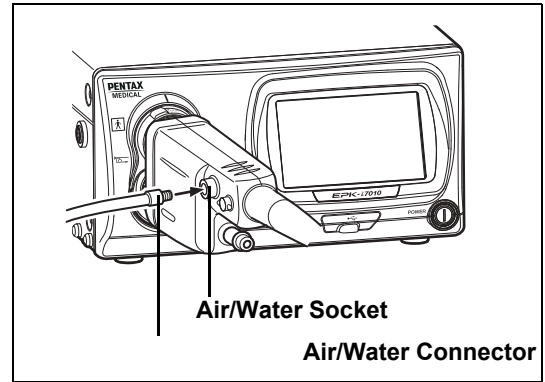

Figure 3.4

## ■ When Using an Endoscopic Electrosurgery Device

### ! WARNING

When performing endoscopic electrosurgery, use the PENTAX Medical condenser earth cable OL-Z4 as shown below to reduce noise appearing on the screen.

- 1 Connect the condenser earth cable OL-Z4 to the potential equalization terminal on the processor. (Refer to Figure 3.5.)

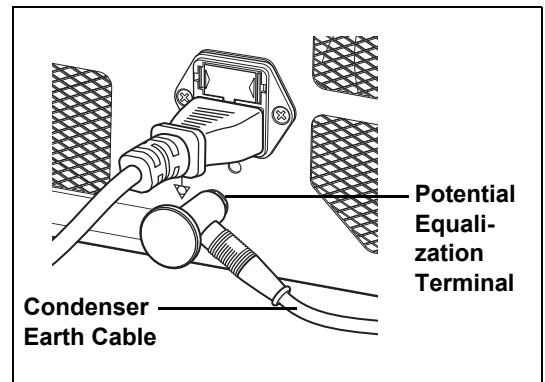

Figure 3.5

- 2 Connect the other end of condenser earth cable to the feedback terminal on the PVE connector of the endoscope. (Refer to Figure 3.6.)

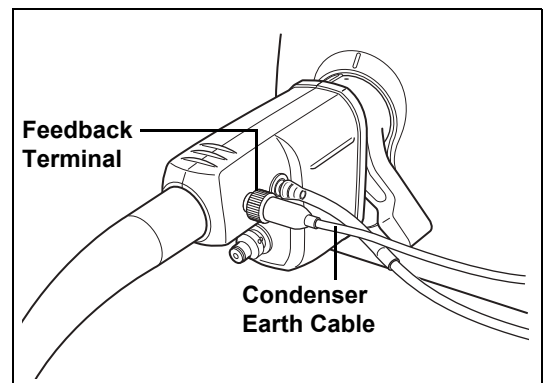

Figure 3.6

### NOTE

- Some of the 90i series endoscopes are necessary to update the scope's software. If a 90i series endoscope with outdated software is connected to this video processor, the error message is displayed on the monitor. In this case, contact your local PENTAX Medical service facility to have them inspect the endoscope and ask them to update the endoscope's software.
- Depending on the endoscope model that is being used, there is a possibility that slight oscillating noise may be visible in the top and bottom sides of the endoscopic image.

# 4 Pre-use Inspections

To ensure the equipment is in good working condition for use with patients, check that the endoscope, processor, and accessories are clean and operate properly before use. Also, provide spare equipment in case use of the equipment must be stopped as result of a malfunction or other unforeseen problem.

Be sure to perform the following inspection steps before using the processor. If you discover any abnormality, stop using the processor immediately and contact a PENTAX Medical service facility.

Check the following before you begin the inspection.

- The processor is turned off.
- The processor is installed on a stable and level surface.
- The water bottle assembly is prepared properly and connected correctly.
- The power cord is connected properly.
- The endoscope is connected properly.
- The keyboard is connected properly.
- The USB flash memory or other storage media is connected properly.

Before saving any images, check that

- (a) the format for the data to be saved to the USB flash memory is the desired format, and
- (b) the USB flash memory or similar is selected as the storage location.

 "Select drive (Still image)" (P.60), "Select drive (Video image)" (P.63)

## WARNING

Be sure to perform the following inspections before you use the processor. In the event that any function or device in the video endoscope system does not work properly, do not perform the endoscopic examination. Contact a PENTAX Medical service facility before using the equipment.

4

## Power-On and Lamp Inspection

**1 Turn on the monitor and peripheral devices.**

**2 Press the  power switch to turn on the processor, and check that the  LED illuminates.**

- The touch panel turns on.
- Check that the LIFE indicator (lamp life indicator) on the touch panel is lit green.
- If pressing  does not turn on the processor, check the fuses.

 "Replacing the Fuses" (P.84)

## CAUTION

• The lamp life is 500 hours. Check the LIFE indicator (lamp life indicator) on the touch panel before using the processor. Replace the lamp cartridge if one red circle on the LIFE indicator is lit red and a message prompting you to replace the lamp is displayed on the monitor. The lamp life may not be as long as 500 hours depending on the method of use and operating environment.

 "Replacing the Lamp" (P.82)

• If the touch panel does not lit up after more than one and a half minutes from the system startup, restart the system.

**3 Press  on the touch panel.**

-  illuminates green.

**4 Check that the main lamp of the processor illuminates, and the distal end of the endoscope emits light.**

## WARNING

- Do not look directly at the light emitted from the distal end of the endoscope. Doing so can cause eye injury.
- Do not open the lamp housing cover to avoid electric shock.

## NOTE

- If the lamp fails to illuminate, stop the inspection and contact a PENTAX Medical service facility.
- If a PENTAX Medical video endoscope or video module that is not compatible with the processor is connected, endoscopic images will not be displayed.
- The auxiliary lamp is for the purpose of ensuring that you can see what you are doing while removing the endoscope in the event of the main lamp fails during a procedure. If this occurs, release the angulation of the endoscope, remove the endoscope from the patient's body cavity, and stop the examination. Do not perform a procedure using the auxiliary lamp.

## On-screen Image Check

- 1 Check the image displayed on the monitor.

### **! WARNING**

Check the live image is properly output on the monitor in the right direction.

## Automatic Brightness Control Inspection

Check the video images from the endoscope on the monitor while the lamp is lit.

- 1 **Exercise the endoscope's automatic iris. Bring the tip of the endoscope within 1 cm of the palm of your hand and move it to about 5 cm away from your palm. Watch the image displayed on the monitor to ensure the brightness at both distances is similar. Lift the distal end of the endoscope close to the room lights, and check that the light being emitted from the distal end of the endoscope lowers significantly (dependent on the ambient light levels in the room). Return the distal end of the endoscope to a point on your palm and ensure that the light is being emitted from the distal end of the endoscope. (Refer to Figure 4.1.)**

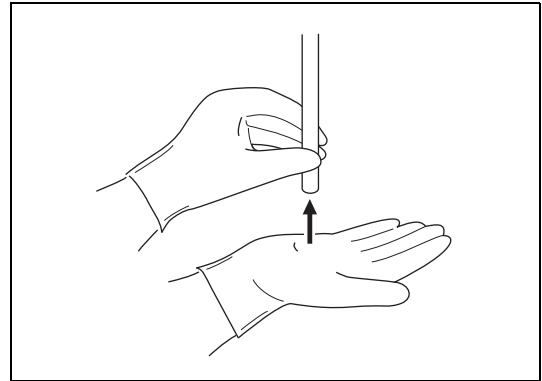

Figure 4.1

4

### **! CAUTION**

- Wear rubber gloves when performing the inspection.
- If items are brought up close to the distal end of the endoscope and left there for a long time, it could cause heat to be generated by the light being emitted from the distal end of the endoscope.
- If dark-colored gloves are brought close to the distal end of the endoscope, it may cause heat to be generated, which may result in a burn injury.

### **NOTE**

- It may take more than 10 seconds for the endoscopic image to appear on the monitor.
- If the endoscopic image does not appear on the monitor, turn the power off and then on again.

## Endoscope Control Button

- 1 **Press each button on the control body of the endoscope and check that a confirmation tone sounds. (Refer to Figure 4.2.)**
  - For details on each of the buttons on the control body of the endoscope, refer to the IFU for the endoscope.

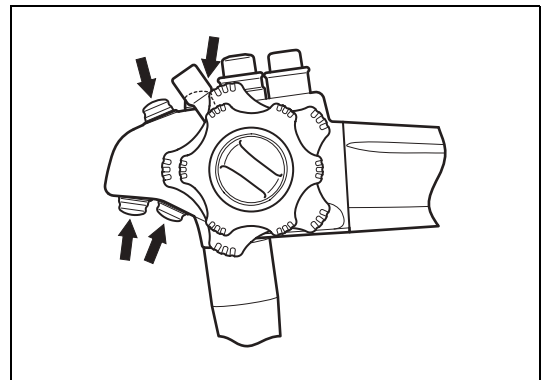

Figure 4.2

## Exposure and Measurement Inspection

1 Press **EXPOSURE CONTROL** on the touch panel, and select **[MANUAL]**.

- The selected item illuminates green. Each press switches the item between **[AUTO]** and **[MANUAL]**.

2 Press **▲▼** of **[BRIGHTNESS]** and check that the level of the indicator changes.

3 Press **EXPOSURE CONTROL**, and select **[AUTO]**.

- The selected item illuminates green. Each press switches the item between **[AUTO]** and **[MANUAL]**.
- Selection is not possible when an endoscope is not connected.

4 Press **MODE**, and select **[AVERAGE]** or **[PEAK]**.

- The selected item illuminates green. Each press switches the item between **[AVERAGE]** and **[PEAK]**.
- Selection is not possible when an endoscope is not connected.



## Color Adjustment

1 Adjust the white balance before adjusting the color balance.

☞ "White Balance Button" (P.27)

2 Press **COLOR BALANCE** on the touch panel.

- The color balance adjustment screen appears.

3 Press **▲▼** of **[BLUE]** or **[RED]** and check the level value. Gently place your hand around the distal end of the endoscope, and check the changes in the image of your hand on the monitor.



## Suction Inspection

1 Place the distal end of the endoscope in a basin of sterile water, and press the suction control valve. (Refer to Figure 4.3.)

- The sterile water should be rapidly aspirated into the suction system.

### NOTE

Be sure to use freshly distilled or sterilized water.

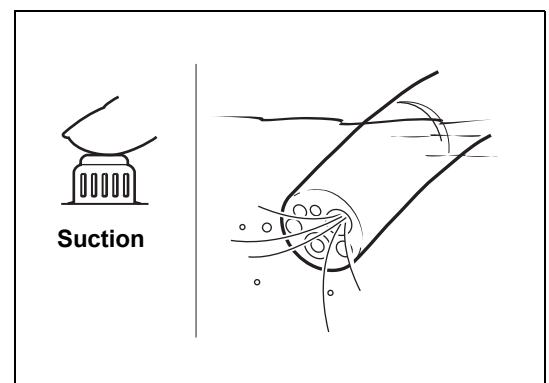

Figure 4.3

# Air/Water Supply Inspection

- 1 Set the A/W DRAIN lever to A/W position. (Refer to Figure 4.4)  
Insert the air pipe of the water bottle assembly into the water bottle socket of the video processor and press until the water bottle assembly 'clicks' into position.

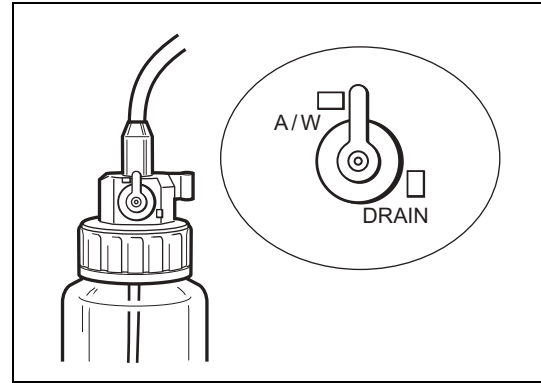





Figure 4.4

- 2 Press  (ON/OFF) on the touch panel so that  illuminates green and the operating sound of the air pump can be heard.
- 3 Press  of [AIR FLOW] to select the strength level.
- 4 Air/water is supplied through the endoscope. If you insert the distal end of the endoscope into water and gently cover the air hole on the air/water feeding valve, air will come out of the distal end of the endoscope. You can confirm the air supply by checking whether air bubbles are generated. (Refer to Figure 4.5.)



4

## NOTE

Be sure to use freshly distilled or sterilized water.

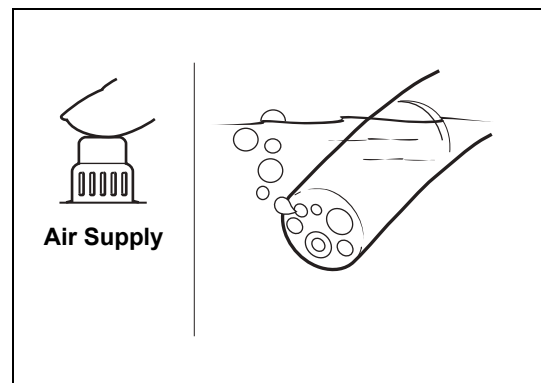

Figure 4.5

- 5 Fully press the air/water feeding valve and check that water comes out of the distal end of the endoscope. (Refer to Figure 4.6.)

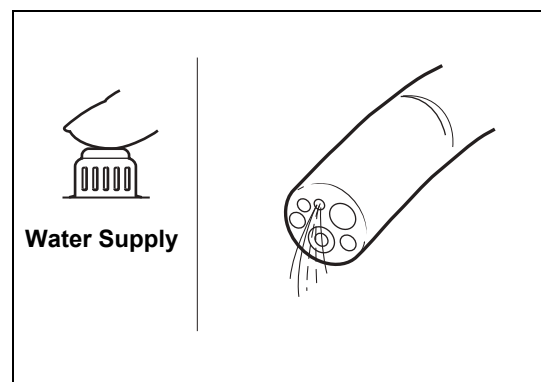

Figure 4.6

## NOTE

For details about air and water delivery, refer to the Instructions for Use for the endoscope.

## CAUTION

If all of the inspection items are working properly, then the endoscopic examination can be performed. If there is a problem with any of the functions, do not perform the endoscopic examination. Contact a PENTAX Medical service facility.

# 5 Operating Procedure

## Turning On/Off the Processor

### 1 Press **Ⓢ** on the front of the processor. (Refer to Figure 5.1.)

- The processor turns on, the touch panel illuminates, and the screen for normal mode appears on the monitor.
- **☞** "Normal Screen" (P.23)
- The patient information and user information displayed immediately prior to turning off the processor last time appear on the monitor.

### 2 Press **Ⓢ** again to turn off the processor.

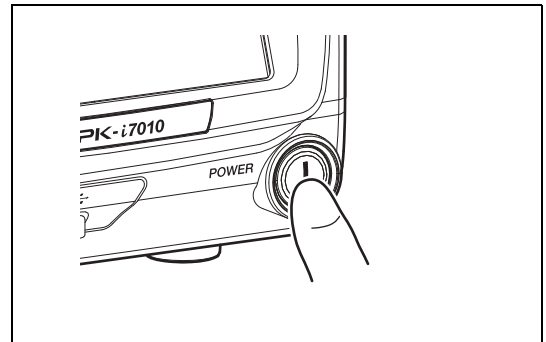

Figure 5.1

### ⚠ CAUTION

- The processor can be shut down the power supply by turning off a power switch.
- After the processor has been turned off, wait at least 30 seconds before turning it back on again. A fuse may be blown if you turn the power on and off repeatedly within a short period of time. **☞** "Replacing the Fuses" (P.84)
- Do not use a sharp object such as the tip of a pen to press buttons on the touch panel.
- On rare occasions, the processor may not start up when it is turned on. If this happens, turn the processor off and then on again.
- Do not use the end of the light guide of the endoscope to operate buttons or switches.
- Data may not be saved correctly to an external device if power is turned off to the processor while the data is being transferred.

### NOTE

On rare occasions, noise may be temporarily displayed on endoscopic images immediately after the start-up video processor or endoscope connection.

5

## Monitor Screens

### Normal Screen

The normal screen shown below appears on the monitor when you turn on the processor.

#### HD Monitor Display

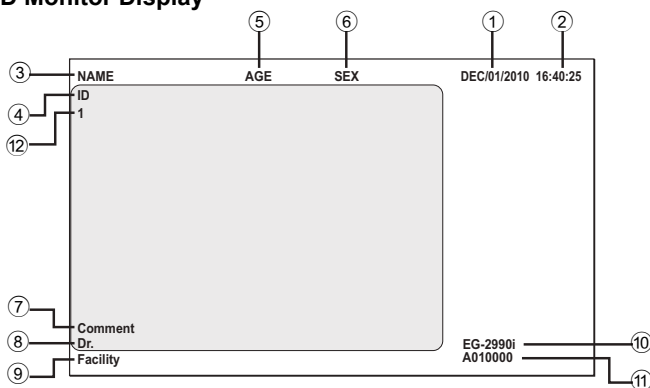

- ① Date
- ② Time (Hours/Minutes/Seconds)
- ③ Patient's Name (Up to 24 Characters)
- ④ ID (Up to 12 Characters)
- ⑤ Age (Up to 3 Characters)
- ⑥ Sex (1 Character)

#### SD Monitor Display

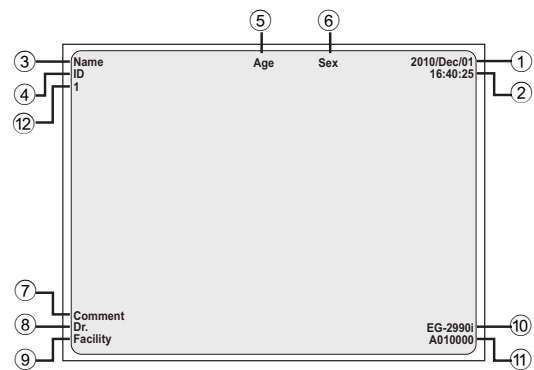

- ⑦ Comment (Up to 40 Characters)
- ⑧ Doctor's Name (Up to 24 Characters)
- ⑨ Facility (Up to 16 Characters)
- ⑩ Endoscope Name
- ⑪ Endoscope Serial No.
- ⑫ Film counter

## NOTE

- You can change the display for the HD monitor and the SD monitor in [Display setting]. "Display setting" (P.66)
- Depending on the setting of the monitor screen, endoscopic image or text information might spill out of the screen. Adjust the display position by performing overscan/underscan adjustment or vertical/horizontal adjustment and make sure that the image as well as text is correctly displayed on the screen.
- Displayed/undisplayed of each item can be set up by [Character display]. "Settings in the [User data edit No.\*] Screen" (P.78)

## Freeze Screen P-in-P Mode Screen

When the freeze function is executed, the monitor display is split into a main screen and sub screen, and still images are displayed in the main screen and endoscope video images are displayed in the sub screen.

When images are input from an external device, you can continue to display the endoscope video images in the main screen and display the images input from the external device in the sub screen. (P-in-P mode)

### HD Monitor Display



### SD Monitor Display



## CAUTION

Be sure to check that the endoscopic images on the monitor are not static and that the images are displayed with the correct orientation each time before attempting to use the equipment or after changing the image mode from freeze screen to normal screen or twin mode screen.

## NOTE

If you set the [Sub screen position] to [Upper Right] on an SD monitor, [Date] and [Time] will be hidden.

## Twin Mode Screen

This screen displays two endoscope video images together. It enables you to confirm an image for which image processing has been performed and an unprocessed image at the same time.

### HD Monitor Display



### SD Monitor Display



## Touch Panel Operation

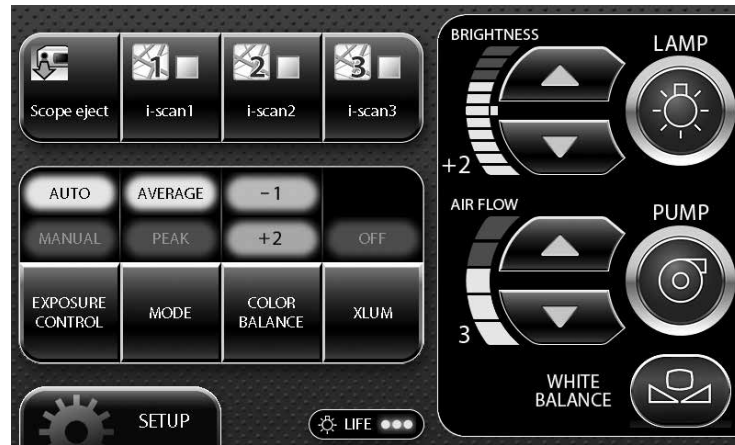



### CAUTION

- Do not use a sharp object such as the tip of a pen to press the buttons on the touch panel.
- Do not use the end of the light guide of the endoscope to operate the touch panel.



## Lamp Button



### 1 Press on the touch panel.

-  illuminates green. The processor's main lamp illuminates, and the distal end of the endoscope connected to the processor emits light.
- If the lamp does not illuminate, the auxiliary lamp illuminates and  flashes green.

### CAUTION

- To protect your eyes, avoid looking directly at the light emitted from the endoscope and/or processor.
- The lamp life used by the processor is 500 hours. Prior to use, check the lamp life indicator on the touch panel and confirm that it is lit green or yellow. After 500 hours of use, the indicator will turn red and image quality will deteriorate. Excessive use of the lamp beyond its rated 500 hours (approaching a thousand hours of use or more) could cause the lamp to explode resulting in damage to the video processor. The lamp life may not be as long as 500 hours depending on the method of use and operating environment.  
 "Replacing the Lamp" (P.82)

### NOTE



- If the main lamp does not illuminate even if you press , check the lamp life indicator on the touch panel. Replace the lamp if the indicator is red ( "Replacing the Lamp" (P.82)). If the indicator is green or yellow, the lamp system or lamp cartridge is broken.  
 "Troubleshooting" (P.86)
- The lamp of the processor should be turned off except during pre-use inspection and clinical use.
- The auxiliary lamp is for the purpose of ensuring that you can see what you are doing while removing the endoscope in the event of the main lamp failing during a procedure. Release the angulation of the endoscope, remove the endoscope from the patient's body cavity, and stop the examination. Do not perform a procedure using the auxiliary lamp.
- If the auxiliary lamp is lit, all image processing is disabled.



## Brightness Setting Buttons

You can manually adjust the brightness of images appearing on the monitor.

### 1 Press or of [BRIGHTNESS].

- Each press of  increases the brightness by one step and each press of  decreases the brightness by one step.
- When you adjust the brightness, the level is indicated by the indicator and the value is displayed on the monitor. Note that the standard value is [0] when you make adjustments.





### NOTE

The brightness setting is stored in memory even after you turn off the processor.



## Pump Button

### 1 Press on the touch panel.

-  illuminates green, and the air/water pump operates. Press the button again to stop operation.
- Press  or  of [AIR FLOW] to set the strength of the pump air flow.  
 "Pump Level Setting Buttons" (P.27)

### NOTE

When pump button becomes inoperable, stop the procedure. Release the finger tip from the air/water feeding valve of the endoscope to stop feeding of the air and water into the patient's body. Then, carefully withdraw the endoscope from the patient.



## Pump Level Setting Buttons

Set the strength of the air and water supply of the pump.

### 1 Press or of [AIR FLOW].

- When you set the pump level, the level is indicated by the indicator and the value is displayed on the monitor.

### CAUTION

- Regardless of pump level setting selected, avoid delivering too much air to minimize the potential for perforation or other medical complications.
- Monitor the patient continuously, and ensure that an air embolism does not occur due to excessive air supply.

### NOTE

- If the objective lens is difficult to clean, the level of the pump setting on the processor can be temporarily raised but simultaneously press the air/water feeding valve and suction control valve on the endoscope while the level is raised to minimize the potential of perforation. After removing the dirt from the lens, return the pump setting to a normal level.
- When the pump level setting is [1] to [3], the setting is stored in memory even after you turn off the processor. When the setting is [4] or [5], the setting is automatically changed to [3] when you turn off the processor.



## White Balance Button

Adjust the white balance. If the message “Check white balance.” appears when the processor is turned on or an endoscope is connected to the processor, adjust the white balance. You can also adjust it whenever you want.

5

### 1 Connect the endoscope to the processor, and turn on the processor.

### 2 Set the exposure control mode to [AUTO].

### 3 Press on the touch panel to emit light from the distal end of the endoscope.

### 4 Insert the distal end of the endoscope into the supplied white balance adjuster. Move the adjuster so that the circle at the bottom can be viewed completely on the monitor screen, and verify that the inside of the adjuster can be seen clearly. (Refer to Figure 5.2.)

### CAUTION

- Be careful not to hit the distal end of the endoscope against the bottom of the white balance adjuster.
- Be sure to use the PENTAX Medical white balance adjuster OS-A43H when adjusting the white balance. Do not attempt to adjust the white balance under any other condition.

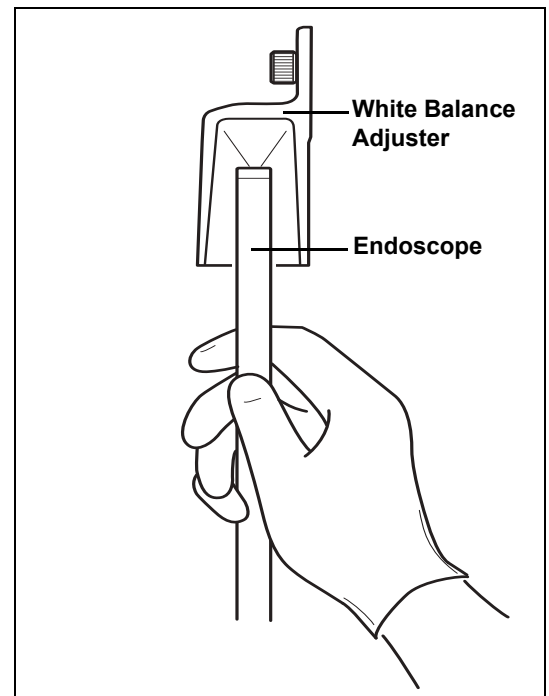



Figure 5.2

**5 Hold the distal end of the endoscope in place and press  on the touch panel for at least 2 seconds.**

- The white balance is adjusted. After the white balance is set, the message “White balance OK!” appears on the monitor for about 5 seconds.
- If adjustment of the white balance fails, the message “White balance failed! Please retry.” appears on the monitor. Adjust the white balance again.

**! CAUTION**

Be sure to press  and adjust white balance before the procedure.

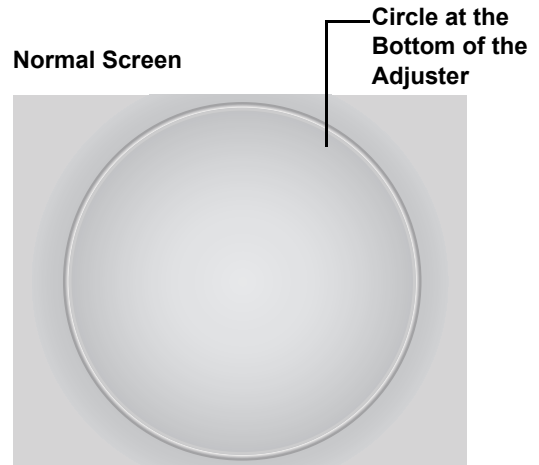

**EXPOSURE CONTROL**



## Exposure Control Button

You can select from two exposure control modes for adjusting the brightness of images appearing on the monitor.

[AUTO]: The brightness set with the brightness setting buttons is automatically adjusted so that it is uniform. Selection is possible when an endoscope is connected.

[MANUAL]: The brightness set with the brightness setting buttons is applied without any automatic adjustments.

**1 Press  on the touch panel and select a setting.**

- Each press switches the item between [AUTO] and [MANUAL].
- The selected item illuminates green.
- When changing the brightness, press  or  of [BRIGHTNESS] to set the level.

**MODE**

## Mode Button

**1 When the exposure control method is set [AUTO], select the light measuring method from [AVERAGE] and [PEAK]. The indicator of the selected method illuminates.**

[AVERAGE]: Adjust the [BRIGHTNESS] level in relation to the average value of the brightness of the video signal.

[PEAK]: Adjust the [BRIGHTNESS] level in relation to the maximum value of the brightness of the screen.

**NOTE**

The light measuring method setting is stored in memory even after you turn off the processor.



**COLOR BALANCE**



## Color Balance Button

You can manually adjust the color tones of images appearing on the monitor.

**1 Press  on the touch panel.**

- The color balance adjustment screen appears.

**2 Press   of [BLUE] or [RED].**

- Each press of  or  changes the color tone.
- When you adjust a color tone, the level is indicated by the indicator and the value is displayed on the monitor. Note that the standard value is [0] when you make adjustments.

**NOTE**

The color balance setting is stored in memory even after you turn off the processor.

## XLUM ON/OFF Button

Use this button when you want to know the position of the distal end of the endoscope from outside the body. When this is set to on, the light intensity of the endoscope is set to maximum and you can confirm the position of the distal end of the endoscope from outside the body.

### 1 Press on the touch panel.

- When this is turned on, [ON] of the button illuminates green and the [BRIGHTNESS] indicator indicates the Maximum value.
- Press the button again to turn it off.

### CAUTION

- Do not use the XLUM ON function during routine use.
- When XLUM is used, Brightness cannot be adjusted.
- XLUM is the function that enables the physician to locate the distal end of the endoscope within the patient's body by intensifying the light emitted by the endoscope to its maximum level. However, the effectiveness of XLUM function can be limited by such factors as patient's body size and so on.

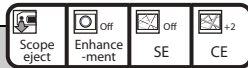

## Customize Buttons

Pressing a customize button activates the function assigned to it. Depending on the registered function, you may be able to change, for example, the setting value by just pressing the button repeatedly or you may be able to display the setting screen for that function by just pressing the button once.

You can change the functions set for the customize buttons in [Customize button settings] on the [Customize] tab of the Setup menu.

 "Customize button settings" (P.44)

### 1 Press the desired customize button.

- The setting value changes or the screen for setting the function appears.



## Setup Button

Pressing the Setup button displays the menu for configuring the settings of each of [i-scan], [Image], [Customize], [System], and [Peripheral].

### 1 Press on the touch panel.

- The Setup menu appears.  
 "Setup Menu Operations" (P.35)

## i-scan

**This video processor includes three, optional preprogrammed modes of i-scan.**

i-scan is an optional digital, post-processing imaging enhancement technology, which is intended to be used as an adjunct to traditional white light endoscopy.

i-scan 1, 2, and 3 are preprogrammed default settings. Only one default setting can be activated at a time. The user is able to either choose the default settings or change the volumetric options of the settings for customizability.

The i-scan modes 1, 2 and 3 can be accessed by using a pre-programmed button on the endoscope, by using a pre-programmed foot switch or by pressing a keyboard button.

**Surface Enhancement (SE), Contrast Enhancement (CE) and Tone Enhancement (TE) are software based image enhancement functions that work in combination to produce the enhancements of i-scan 1, 2 and 3.**

### ■ Surface Enhancement (SE)

The software based SE mode allows for enhancement of detailed patterns and micro-unevenness (texture) of the surface structures of the image.

### ■ Contrast Enhancement (CE)

The software based CE mode allows for enhancement of micro-unevenness (texture) by identifying locally dark areas in the images and further enhancing them with a slight blue tone.

#### NOTE

- If [Enhancement], [SE], or [CE] is used, noise may become visible in images on the monitor screen.
- [Enhancement], [CE], [SE] settings are stored in memory even if the processor is turned off.

5

### ■ Tone Enhancement (TE)

The software based TE mode allows for the adjustment of color contrast in the image to enhance contrast between mucosa and blood vessels. Each TE setting displays a unique combination of red, green and blue contrast.

#### ! WARNING

- If any newly identified irregularities in the endoscopic image are observed during any of the image enhancement observational modes, immediately return to the normal white light observation mode.
- Do not rely on the image enhancement observational modes alone for primary detection of lesions or for decisions regarding any potential diagnostic or therapeutic intervention.

#### ! CAUTION

The tone and the brightness of the endoscopic image of the i-scan observation are different from the white light observation. Please use the i-scan observation after a thorough white light examination and reviewing the property of each mode. i-scan observation is an adjunct to white light endoscopy, and is not a substitute for either a thorough traditional examination or for histopathological results.

## i-scan Setting

No.	Setting Item	Setting Value	Explanation
1	Enhancement (Enh)	Off, +1, +2, +3, +4, +5, +6, +1/a1, +2/a2, +3/a3, +4/a4, +5/a5, +6/a6	Enhances the sharpness of edges and emphasizes the mucosal structures (the enhancement level is increased with the setting value).
2	Surface Enhancement (SE)	Off, +1, +2, +3, +4, +5, +6	Enhances detailed patterns and micro-unevenness (texture) of the surface structures of the image.
3	Contrast Enhancement (CE)	Off, +1, +2, +3, +4, +5, +6	Enhances micro-unevenness (texture) by identifying locally dark areas in the images and further enhancing them with a slight blue tone.
4	Brightness (B)	-5, -4, -3, -2, -1, 0, +1, +2, +3, +4, +5	Allows for adjustment of brightness of image (a larger value increases brightness).
5	Color Balance	-5, -4, -3, -2, -1, 0, +1, +2, +3, +4, +5	Allows for adjustment of red and blue tone (a larger value increases red or blue color intensity).
6	Tone Enhancement (TE)	Off, p, v, b, e, g, c	Allows for adjustment of color contrast in image to enhance contrast between mucosa and blood vessels. Each TE setting displays a unique combination of red, green and blue contrast.
7	Light Measuring Method (LMM)	Ave, Peak	Allows for adjustment of brightness level with respect to an averaging of the brightness of the video signal or with respect to the peak brightness of the screen.
8	Noise Reduction (NR)	Off, Low, Medium, High	Allows for correction of noise appearing by image processing.

## Optical Enhancement (OE)

This video processor is equipped with two optical filters placed inside Xenon lamp light path to provide optical enhancement (OE), which combines the band limited light and the digital processing.

PENTAX OE technology has two modes, OE Mode1, 2.

OE Mode1 uses a spectral filter that transmits band limited green and blue light and is intended to provide the user with enhanced image of blood vessels and fine structure of mucosa.

OE Mode2 uses a different spectral filter that transmits band limited red, green and blue light and is intended to provide the user with enhanced image of blood vessels and fine structure of mucosa in an image closer to white light image.

### NOTE

OE mode cannot be processed simultaneously with [SE], [CE], [TE].

### WARNING

- If any newly identified irregularities in the endoscopic image are observed during any of the image enhancement observational modes, immediately return to the normal white light observation mode.
- Do not rely on the image enhancement observational modes alone for primary detection of lesions or for decisions regarding any potential diagnostic or therapeutic intervention.

### Optical Enhancement (OE) setting

Setting Item	Setting Value	Explanation
OE (Optical Enhancement)	Off, Mode1, Mode2	Inserts one of two optical filters corresponding to Mode1 and Mode2 into the illumination light path to provide a band-limited spectrum. The band-limited spectrum enhances blood vessels and fine structure of mucosa.
Enhancement (Enh)	Off, +1, +2, +3, +4, +5, +6, +1/a1, +2/a2, +3/a3, +4/a4, +5/a5, +6/a6	Enhances the sharpness of edges and emphasizes the mucosal structures (the enhancement level is increased with the setting value).
Brightness (B)	-5, -4, -3, -2, -1, 0, +1, +2, +3, +4, +5	Allows for adjustment of brightness of image (a larger value increases brightness).
Ave / Peak (Light Measuring Method)	Average, Peak	Allows for adjustment of brightness level with respect to an averaging of the brightness of the video signal or with respect to the peak brightness of the screen.
Red / Blue (Color Balance)	-5, -4, -3, -2, -1, 0, +1, +2, +3, +4, +5	Allows for adjustment of red and blue tone (a larger value increases red or blue color intensity).
Noise Reduction (NR)	Off, Low, Medium, High	Allows for correction of noise appearing by image processing.

# Image Processing Settings

## CAUTION

Be sure to check that the endoscopic images on the monitor are not static and that the images are displayed with the correct orientation each time after changes have been made to image processing settings.

## ■ Using SE

### 1 Press the [SE] key on the keyboard / customize button on the touch panel or configure setting on [i-scan] Tab.

- Each press changes the level of SE.  
 "Function Keys" (P.73), "Customize button settings" (P.44), "[i-scan] Tab" (P.35)

## CAUTION

SE is an observation mode that employs software image enhancement of regional concavity and convexity after the image has been collected by the endoscope.  
All mucosal areas are to be viewed using traditional white light. SE should not be used as a substitute for a thorough traditional white light examination of the mucosa.

## ■ Using CE

### 1 Press the [CE] key on the keyboard / customize button on the touch panel or configure setting on [i-scan] Tab.

- Each press changes the level of CE.  
 "Function Keys" (P.73), "Customize button settings" (P.44), "[i-scan] Tab" (P.35)

## NOTE

- If [Enhance level], [SE], or [CE] is set to high level, noise may become visible in images on the monitor screen.
- [Enhance level], [CE], [SE] settings are stored in memory even if the processor is turned off.
- K series with CE: Equivalent effectiveness to i series with CE mode.

## ■ Using TE

### 1 Press the [TE] key on the keyboard / customize button on the touch panel or configure setting on [i-scan] Tab.

- Each press changes the mode of TE.
- Select from [p], [v], [b], [e], [g], [c], and [off].  
 "Function Keys" (P.73), "Customize button settings" (P.44), "[i-scan] Tab" (P.35)

## NOTE

K series with TE [e], [g], [c]: Equivalent effectiveness to i series with TE [e], [g], [c] mode.

## ■ Using OE

OE modes can be activated during i-scan or white light observations.

### Switching from White light image to OE image:

- 1 If i-scan functions are activated: Press [i-scan1], [i-scan2], [i-scan3] key on the keyboard, or customize button on the touch panel, or configure setting on [i-scan] Tab.**
  - Select OFF of i-scan1, 2 or 3.  
☞ "Function Keys" (P.73), "Customize button settings" (P.44), "[i-scan] Tab" (P.35)
- 2 Press the [OE] key on the keyboard / customize button on the touch panel or configure setting on [i-scan] Tab.**
  - Each press changes the mode of OE.
  - Select from [Mode1], [Mode2] and [off].  
☞ "Function Keys" (P.73), "Customize button settings" (P.44), "[i-scan] Tab" (P.35)

### Switching from i-scan1, i-scan2, or i-scan3 image to OE image:

- 1 Press the [OE] key on the keyboard / customize button on the touch panel or configure setting on [i-scan] Tab with i-scan1, 2 or 3 function are been activating.**
  - Each press changes the mode of OE.
  - Select from [Mode1], [Mode2] and [off].  
☞ "Function Keys" (P.73), "Customize button settings" (P.44), "[i-scan] Tab" (P.35)

#### NOTE

- 70K and 80K series endoscopes are not compatible with OE, therefore OE function cannot be used.
- 90K, K10 and J10 series endoscopes are not compatible with Twin mode viewing in OE mode image observation.
- Some of 90K series endoscope require software update to be used with OE. Please contact your local PENTAX Medical service facility.

## ■ Using Enhancement

Configure the edge enhancement setting.



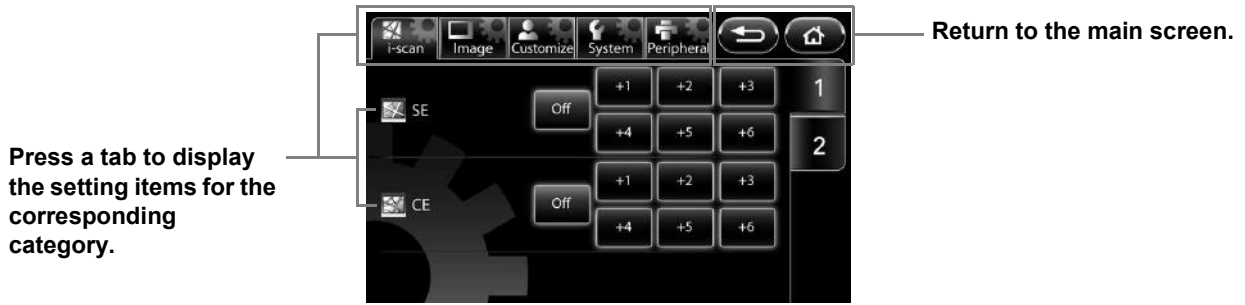

- 1 Press the [Enhance level] key on the keyboard / customize button on the touch panel.**
  - Each press changes the intensity of enhancement.  
☞ "Function Keys" (P.73), "Customize button settings" (P.44)

# Setup Menu Operations

Pressing  on the touch panel displays the Setup menu.



The Setup menu contains the following categories.

- i-scan** Configure settings for image processing related to i-scan mode.  
 "[i-scan] Tab" (P.35)
- Image** Configure settings for image processing performed on endoscopic images, and settings related to twin mode.  
 "[Image] Tab" (P.39)
- Customize** Configure settings for functions assigned to customize buttons, endoscope buttons, and foot switches, settings related to monitor display, and other settings.  
 "[Customize] Tab" (P.44)
- System** Configure settings related to saving endoscopic images, and settings related to the processor unit. Be sure to check the setting options before using the processor for the first time.  
 "[System] Tab" (P.58)
- Peripheral** Configure settings related to the peripheral device.  
 "[Peripheral] Tab" (P.71)

## [i-scan] Tab

Pressing the [i-scan] tab displays the following screen. The screen has two pages.

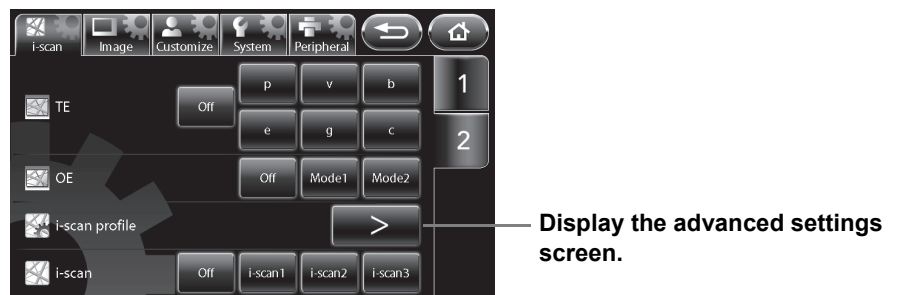
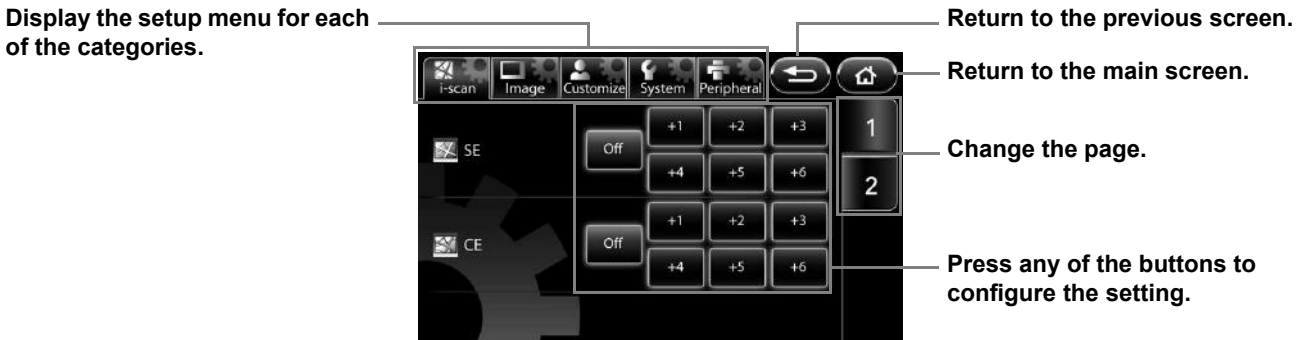

## SE

Set the level for SE (surface enhancement).

### 1 Press [Off] or one of the six levels.

- A higher numerical value sets a higher level.

## CE

Set the level for CE (contrast enhancement).

### 1 Press [Off] or one of the six levels.

- A higher numerical value sets a higher level.

#### NOTE

- If [SE] or [CE] is used, noise may become visible in images on the monitor screen.
- The [SE] and [CE] settings are stored in memory even after you turn off the processor.

## TE

Set the mode for TE (tone enhancement).

### 1 Select [Off], [p], [v], [b], [e], [g], or [c].

#### CAUTION

Be sure to check that the endoscopic images on the monitor are not static and that the images are displayed with the correct orientation each time after changes have been made to [SE], [CE], and [TE].

## OE

Set the mode for OE (optical enhancement).

### 1 Select [Off], [Mode1], or [Mode2].

- It cannot be processed simultaneously with [SE] [CE] [TE].
- If an endoscope is not connected to the processor, the message "Connect endoscope." appears.

#### NOTE

- [OE] setting remains even when an endoscope is taken out and inserted by [Scope eject] with a processor's main body turned on.
- When changing the mode of OE, an image may be disturbed until its completion.

## i-scan profile

Set the functions of [i-scan1], [i-scan2], and [i-scan3].

### 1 Press [>].

- The [i-scan profile] screen appears.
- The setting value in the main screen and other screens is displayed for each item.

### 2 Select [i-scan1], [i-scan2], or [i-scan3].

- If one of the i-scan modes is already selected, the currently enabled button will be lit.

### 3 Press the parameter box for which you want to change the setting.

- When a parameter box is selected, it turns blue and the buttons for changing the selected parameter appear at the bottom of the screen.

### 4 Change the setting with the buttons at the bottom of the screen.

- [SE] [CE] [TE] and [OE] cannot be processed simultaneously.

### 5 Press [Save].

- The changes are saved.
- If [Load] was pressed when the setting values were changed, the saved setting values are loaded.

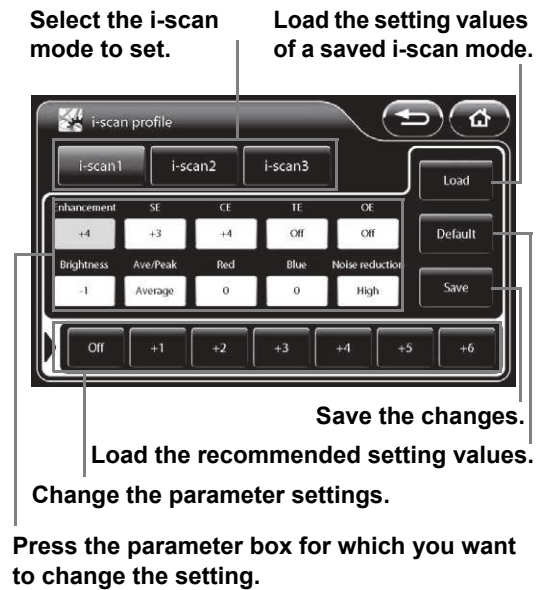

5

### List for assignable i-scan setting

Setting Item	Setting Value
Enhancement (Enh)	Off, +1, +2, +3, +4, +5, +6, +1/a1, +2/a2, +3/a3, +4/a4, +5/a5, +6/a6
SE (Surface Enhancement)	Off, +1, +2, +3, +4, +5, +6
CE (Contrast Enhancement)	Off, +1, +2, +3, +4, +5, +6
TE (Tone Enhancement)	Off, p, v, b, e, g, c
OE (Optical Enhancement)	Off, Mode1, Mode2
Brightness (B)	-5, -4, -3, -2, -1, 0, +1, +2, +3, +4, +5
Ave / Peak (Light Measuring Method)	Average, Peak
Red / Blue (Color Balance)	-5, -4, -3, -2, -1, 0, +1, +2, +3, +4, +5
Noise Reduction (NR)	Off, Low, Medium, High

#### NOTE

- With [Brightness] and [Ave/Peak], [No change] can be selected in addition to the normal levels. [No change] enables the level for when the [i-scan] setting is [Off] to be used.
- If you attempt to perform a keyboard operation other than pressing the [Lamp] or [Pump] key, endoscope button operation, or foot switch operation in the [i-scan profile] screen, the message "Close profile menu." appears on the monitor and the operation cannot be performed.

## ■ i-scan1-3

Select the i-scan mode.

### 1 Select [Off], [i-scan1], [i-scan2], or [i-scan3].

- The selected button illuminates, and the settings registered in [i-scan profile] are loaded.
- If one of the i-scan modes is already selected, the currently enabled button will be lit.
- If an endoscope is not connected to the processor, the message “Connect endoscope.” appears.

#### NOTE

- Configure each setting of [i-scan1], [i-scan2], and [i-scan3] in [i-scan profile].
- The [i-scan1-3] settings are retained even if the endoscope is removed and inserted using [Scope eject] while the processor is on.

## [Image] Tab

Pressing the [Image] tab displays the following screen. The screen has three pages.

Display the setup menu for each of the categories.

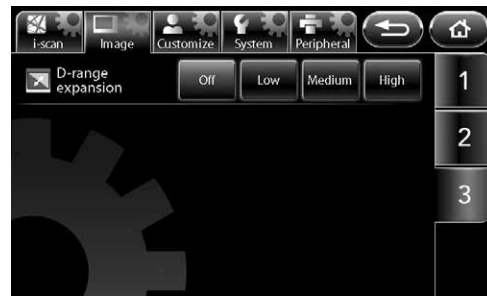
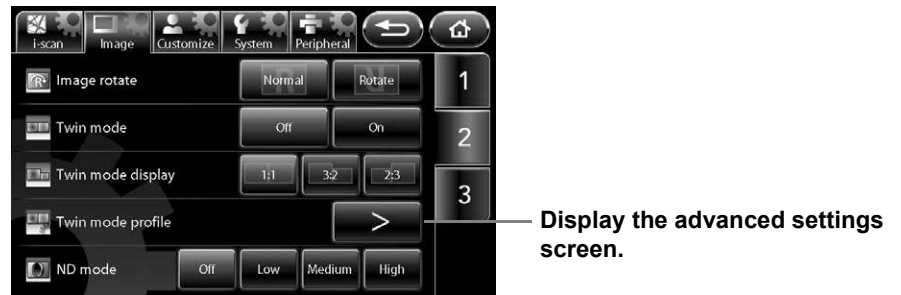
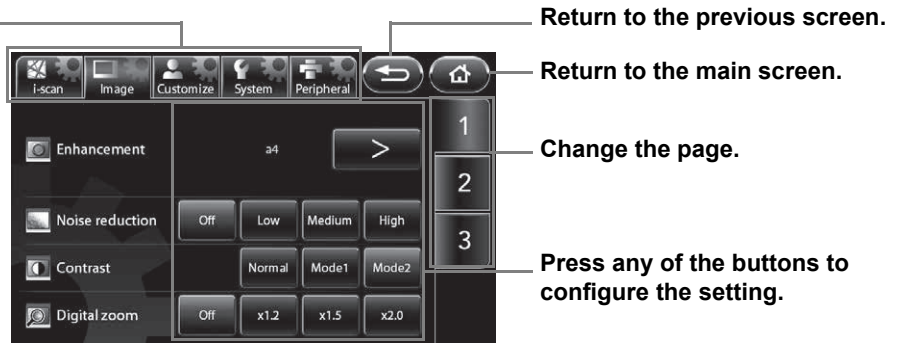

5

## ■ Enhancement

Set the level for edge enhancement/structure enhancement display.

### 1 Press [>].

- The [Enhancement] screen appears.

When [Scope enhancement] on the [Customize] tab is set to [Enable] (Only 70K series)

### 2 Select [Off], [Low], [Medium], or [High].

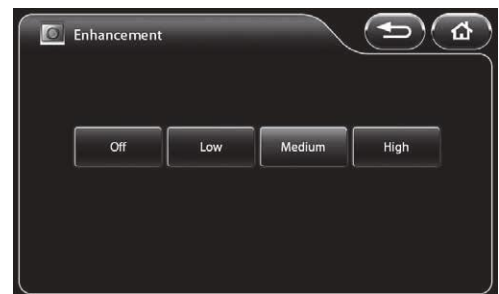

When [Scope enhancement] on the [Customize] tab is set to [Disable]

### 3 Press [Off] or one of two types × six levels.

- A higher numerical value sets a higher level for edge enhancement / structure enhancement display.

[+1 to +6] Edge enhancement mode

[+1/a1 to +6/a6] Edge enhancement / Structure enhancement mode : allows for enhancing the mucous membrane structure and contour.

When connecting the 70K, 80K, 90K, K10 and J10 series endoscope, the edge enhancement mode [+1 to +6] is effective, and when the i series endoscope is connected, the structure enhancement mode [a1 to a6] becomes effective.

Structure enhancement mode and [SE] cannot be processed simultaneously.



#### ! CAUTION

Be sure to check that the endoscopic images on the monitor are not static and that the images are displayed with the correct orientation each time after changes have been made to [Enhancement].

## Noise reduction

Set the level for noise reduction.

### 1 Select [Off], [Low], [Medium], or [High].

#### ! CAUTION

Be sure to check that the endoscopic images on the monitor are not static and that the images are displayed with the correct orientation each time after changes have been made to [Noise reduction].

#### NOTE

If [SE], [CE], or [Enhancement] is used, noise may become visible in the image on the monitor screen.

## Contrast

Select the mode for contrast processing.

### 1 Select [Normal], [Mode1], or [Mode2].

#### ! CAUTION

Be sure to check that the endoscopic images on the monitor are not static and that the images are displayed with the correct orientation each time after changes have been made to [Contrast].

#### NOTE

The [Enhancement], [Noise reduction], and [Contrast] settings are stored in memory even after you turn off the processor.

## Digital zoom

Set the magnification ratio of endoscopic images.

### 1 Select [Off], [x1.2], [x1.5], or [x2.0].

#### NOTE

As the optical or electronic expanded observation display has a narrow view, please secure a view enough when performing an operation.

## Image rotate

Set the display orientation of the endoscopic image.

### 1 Press [Normal] or [Rotate].

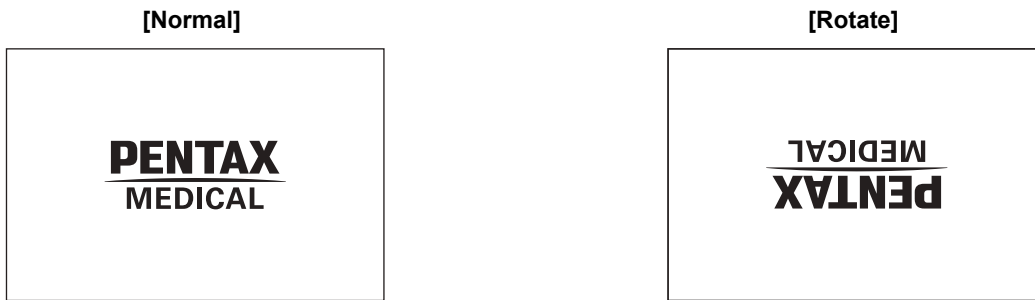

## Twin mode

Set or cancel twin mode.

"Twin Mode Screen" (P.24)

### 1 Press [Off] or [On].

- If an endoscope is not connected to the processor, the message "Connect endoscope." appears.

#### NOTE

- If [SE] or other image processing is performed in twin mode, the processing is only reflected on the image on the right side of the screen. The image processing parameters are inherited by the normal screen when twin mode is cancelled.
- When the Twin mode setup is made after freezing, an image processing is not reflected in the left side screen. In the case where the USB capture is performed as is, an image-processing parametric information is added to the still picture even if not checking [Add image processing parameter information.]of [Option (Still image)]. And the image-processing parametric information of the left side screen displays "-". Image processing of the left side screen will become effective after freezing release.
- 90K, K10 and J10 series endoscopes do not correspond to the Twin mode of white light and OE.
- (When executed an image-processing)In case that the display is too dark to obtain a proper observation result, we recommend you to return to a normal observation display or change one display into white light.

## Twin mode display

Set the sizes of the image on the left side of the screen and on the right side of the screen in twin mode.

### 1 Select [1:1], [3:2], or [2:3].

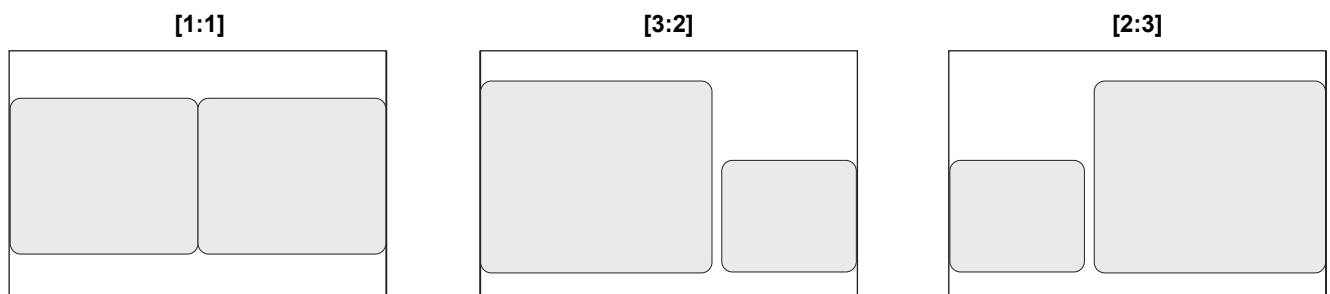

#### NOTE

The [Twin mode display] setting is stored in memory even after you turn off the processor.

## Twin mode profile

Set the image processing for twin mode.

### 1 Press [>].

- The [Twin mode profile] screen appears.
- The setting value in the main screen and the other screens is displayed for each item.

### 2 Select [Off] or [On] for [Profile setting].

[Off]: The [Twin mode profile] screen is not displayed in twin mode. Image processing parameters other than [Enhancement] are not reflected on the left side of the screen.

[On]: The [Twin mode profile] screen is always displayed on the left side of screen in twin mode. "TM profile" is displayed in the upper left of the left side of the screen.

### 3 Press the parameter box for which you want to change the setting.

- When a parameter box is selected, it turns blue and buttons for changing the selected parameter appear at the bottom of the screen.

### 4 Change the setting with the buttons at the bottom of the screen.

- If the parameter box does not turn blue, the buttons will not function properly.

### 5 Press [Save].

- The changes are saved.
- If [Load] was pressed when the setting values were changed, the saved setting values are loaded.

Set whether to display the [Twin mode profile] screen.

Load the saved twin mode setting values.

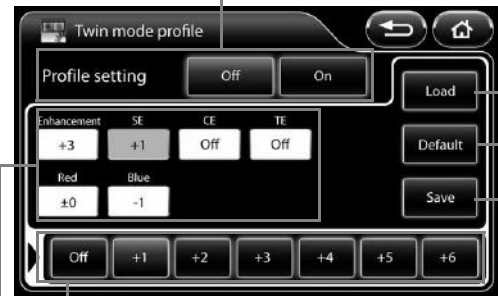

Save the changes.

Load the recommended setting values.

Change the setting of the parameter.

Press the parameter box for which you want to change the setting.

#### NOTE

- If you attempt to perform a keyboard operation other than pressing the [Lamp] or [Pump] key, endoscope button operation, or foot switch operation in the [Twin mode profile] screen, the message "Close profile menu." appears on the monitor and the operation cannot be performed.
- When the Twin mode setup is made after freezing, an image processing is not reflected in the left side screen. In the case where the USB capture is performed as is, an image-processing parametric information is added to the still picture even if not checking [Add image processing parameter information.]of [Option (Still image)]. And the image-processing parametric information of the left side screen displays "-". Image processing of the left side screen will become effective after freezing release.

## ■ ND mode

Set the level for ND mode.

### 1 Select [Off], [Low], [Medium], or [High].

#### ⚠ CAUTION

- If an option other than [Off] is set, a normal screen will not be displayed on the monitor when a PDT or other strong light is not utilized.
- When [Low], [Medium], or [High] is set, the current user cannot be changed.  "Operations in the [User list preset] Tab" (P.77)
- When the setting screen is displayed by pressing the [Menu] key, [ND mode] operation is not possible.
- If [ND mode] is set to an option other than [Off], [i-scan1], [i-scan2], and [i-scan3] cannot be used.
- When the [ND mode] is set to anything other than [Off], the settings for [Shutter mode], [OE] will be canceled.
- Depending on the endoscope model being used, the time it takes to resume from the ND mode varies. It takes maximum of 10 seconds.
- There are certain models among 90K series endoscopes that cannot utilize ND mode. In order to use the ND mode, it is necessary to update the integrated software of the endoscope. Contact your local PENTAX Medical service facility to arrange the software update and inspection of the endoscope.

## ■ D-range expansion

Select the mode for D-range expansion processing.

### 1 Select [Off], [Low], [Medium], or [High].

#### NOTE

The [D-range expansion] settings are stored in memory even after you turn off the processor.

## [Customize] Tab

Pressing the [Customize] tab displays the following screen. The screen has four pages.

Display the setup menu for each of the categories.

Return to the previous screen.

Return to the main screen.

Change the page.

Display the advanced settings screen.

Press any of the buttons to configure the setting.

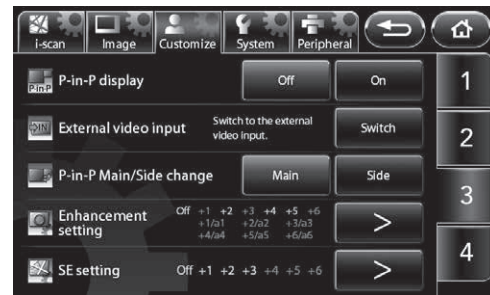
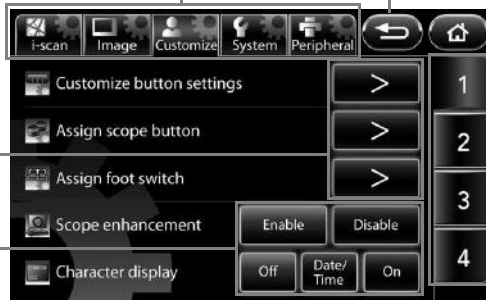

5

## Customize button settings

Set the functions for the customize buttons (four buttons at the top of the main screen).

- 1 Press [>].
  - The [Customize button settings] screen appears.
- 2 Press the customize button for which you want to set the function.
  - The selected customize button illuminates blue.

The function assigned to each customize button is displayed.



### 3 Press the button of the function to set.

- You can press ◀▶ to display additional functions.
- The name of the assigned function is displayed below the customize button.

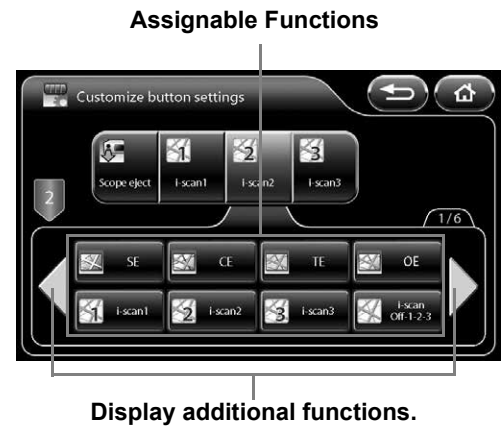

The following functions can be assigned.

Function Name	Function Description	Reference Page
SE	Switch the SE level to a level available in [SE setting]. It cannot be processed simultaneously with [OE] or the structure enhancement mode [a1 to a6].	P.55
CE	Switch the CE level to a level available in [CE setting]. It cannot be processed simultaneously with [OE].	P.56
TE	Switch the TE mode to a mode available in [TE setting]. It cannot be processed simultaneously with [OE].	P.56
OE*	Switch the OE mode to a mode available in [OE setting]. It cannot be processed simultaneously with [SE] [CE] [TE].	P.56
i-scan1*	Use the settings of [i-scan1]. When the function is configured, a check mark is displayed in the check box of the corresponding button.	P.37
i-scan2*	Use the settings of [i-scan2]. When the function is configured, a check mark is displayed in the check box of the corresponding button.	P.37
i-scan3*	Use the settings of [i-scan3]. When the function is configured, a check mark is displayed in the check box of the corresponding button.	P.37
i-scan Off-1-2-3*	Switch the i-scan mode between [Off], [i-scan1], [i-scan2], and [i-scan3].	P.38
i-scan profile	Open the i-scan profile menu.	P.37
Remote1*	Output a signal from the REMOTE1 connector on the back of the processor.	—
Remote2*	Output a signal from the REMOTE2 connector on the back of the processor.	—
Remote3*	Output a signal from the REMOTE3 connector on the back of the processor.	—
Freeze*	Switch between video mode and freeze mode.	—

Function Name	Function Description	Reference Page
USB capture*	Save a still image to Image Recording Media in accordance with the setting of [File storage setting (Still image)].	P.60
USB printer*	Send a still image to the connected USB printer.	P.71
Video Rec/Stop*	Start and stop recording video. The video files are saved to Image Recording Media in accordance with the setting of [File storage setting (Video image)].	P.62
Enhancement*	Switch the edge enhancement/structure enhancement level available in [Enhancement setting].	P.39
Noise reduction	Switch the level for noise reduction between [Off], [Low], [Medium], and [High].	P.40
Contrast	Switch the mode for contrast processing between [Normal], [Mode1], and [Mode2].	P.40
Twin mode*	Set or cancel twin mode.	P.41
Twin mode display	Switch the size of the images on the left and right sides of the screen in twin mode between [1:1], [3:2], and [2:3].	P.41
Digital zoom*	Switch the magnification ratio for the endoscopic image in accordance with the setting of [Digital zoom setting].	P.54
Image rotate	Switch the display orientation for the endoscopic image between [Normal] and [Rotate].	P.41
ND mode*	Switch the level for ND mode between [Off], [Low], [Medium], and [High].	P.43
Film counter reset	Reset the film counter to 1.	P.68
Optical zoom speed	Switch the zoom speed for an optical zoom endoscope between [Low], [Medium], and [High].	P.54
P-in-P display	Switch P-in-P mode display between [Off] and [On].	P.54
External video input	Display images input from an external device on the touch panel.	P.54
P-in-P Main/Side change	Switch between the endoscopic image and external input video screens in P-in-P mode.	P.55
Scope eject*	Press and hold the button to remove the endoscope while the processor is on.	P.66
Image size	Switch the display size of the endoscopic image between [Full] and [Medium].	P.66

Function Name	Function Description	Reference Page
Stopwatch	Start or stop the stopwatch. Press and hold the button to reset the stopwatch.	P.66
System information	Display the [System information] screen.	P.68
Shutter mode*	Switch the shutter mode for the endoscope between [Off] and [On] (K series endoscope) or between [Off], [Low], [Medium], and [High] (i series endoscope).	P.52
Copy*	Capture a still image and output it to the Endonet system or endoPRO.	—
Video*	Start/stop recording video to the Endonet system or endoPRO.	—
PC capture*	Output the image to PC via Endoimage2.	—
D-range expansion	Switch the level for D-range expansion between [Off], [Low], [Medium], and [High].	P.43
Manual brightness level	Set the brightness adjustment level by endoscope type while [MANUAL] is set for [EXPOSURE CONTROL].	P.67
iDoc button	Send the current settings for i-Doc management to endoPRO.	—
Cecum marker	Send a command for the Cecum marker to endoPRO.	—

\*: The button does not function when an endoscope is not connected to the processor.

## Assign scope buttons

Set the functions for the endoscope buttons.

### 1 Press [>].

- The [Assign scope buttons] screen appears.

The function assigned to each endoscope button is displayed.



### 2 Select the endoscope buttons ([1], [2], [3], or [4]) for which you want to assign a function.

- The selected endoscope button illuminates blue.

### 3 Press the button of the function you wish to configure.

- You can press ◀▶ to display additional functions.
- The name of the assigned function is displayed below the endoscope button.

Assignable Functions



Display additional functions.

- Pressing [Peripheral] displays the [Peripheral] screen. On this screen, each external output can be switched on or off. Press the button of the function to output so that the button illuminates blue. Simultaneous output of multiple functions is possible.
- Pressing the button again switches off the output.



The following functions can be assigned.

Function Name	Function Description	Reference Page
No operation	A function is not assigned to the button.	—
Freeze	Switch between video mode and freeze mode.	—

Function Name		Function Description	Reference Page
Peripheral	Remote1	Output a signal from the REMOTE1 connector on the back of the processor.	—
	Remote2	Output a signal from the REMOTE2 connector on the back of the processor.	—
	Remote3	Output a signal from the REMOTE3 connector on the back of the processor.	—
	Copy	Capture a still image and output it to the Endonet system, or endoPRO. This cannot be configured simultaneously with [USB memory], [USB printer], [Endoimage2], and [Video].	—
	USB memory	Save a still image to Image Recording Media in accordance with the setting of [File storage setting (Still image)]. This cannot be configured simultaneously with [Copy], [USB printer], [Endoimage2], and [Video].	P.60
	USB printer	Send a still image to the connected USB printer. This cannot be configured simultaneously with [Copy], [USB memory], [Endoimage2], and [Video].	P.71
	Endoimage2	Output the image to a PC via Endoimage2. This cannot be configured simultaneously with [Copy], [USB memory], [USB printer], and [Video].	—
	Video	Start/stop recording video to the Endonet system or endoPRO. This cannot be configured simultaneously with [Copy], [USB memory], [USB printer], and [Endoimage2].	—
Video Rec/Stop		Start and stop recording video. The video files are saved to Image Recording Media in accordance with the setting of [File storage setting (Video image)].	P.62
Auto/Manual		Switch between [AUTO] and [MANUAL] for exposure control.	P.28
Average/Peak		Switch between [AVERAGE] and [PEAK] for the light measuring mode.	P.28
Enhancement		Switch the edge enhancement/structure enhancement level to a level available in [Enhancement setting].	P.39
Noise reduction		Switch the level for noise reduction between [Off], [Low], [Medium], and [High].	P.40
SE		Switch the SE level to a level available in [SE setting]. It cannot be processed simultaneously with [OE] or the structure enhancement mode [a1 to a6].	P.55
CE		Switch the CE level to a level available in [CE setting]. It cannot be processed simultaneously with [OE].	P.56

Function Name	Function Description	Reference Page
TE	Switch the TE mode to a mode available in [TE setting]. It cannot be processed simultaneously with [OE].	P.56
OE	Switch the OE mode to a mode available in [OE setting]. It cannot be processed simultaneously with [SE] [CE] [TE].	P.56
i-scan1	Use the settings of [i-scan1].	P.37
i-scan2	Use the settings of [i-scan2].	P.37
i-scan3	Use the settings of [i-scan3].	P.37
i-scan Off-1-2-3	Switch the i-scan mode between [Off], [i-scan1], [i-scan2], and [i-scan3].	P.38
Digital zoom	Switch the magnification ratio for the endoscopic image in accordance with the setting of [Digital zoom setting].	P.54
Stopwatch	Start or stop the stopwatch.	P.66
Stopwatch reset	Reset the stopwatch.	P.66
ND mode	Switch the level for ND mode between [Off], [Low], [Medium], and [High].	P.43
P-in-P Main/Side change	Switch between the endoscopic image and external input video screens in P-in-P mode.	P.55
Optical zoom (T)	Enlarge the display of the endoscopic image for an optical zoom endoscope.	—
Optical zoom (W)	Reduce the display of the endoscopic image for an optical zoom endoscope.	—
Twin mode	Set or cancel twin mode.	P.41
Twin mode display	Switch the size of the images on the left and right sides of the screen in twin mode between [1:1], [3:2], and [2:3].	P.41
Shutter mode	Switch the shutter mode for the endoscope between [Off] and [On] (K series endoscope) or between [Off], [Low], [Medium], and [High] (i series endoscope).	P.52
D-range expansion	Switch the level for D-range expansion between [Off], [Low], [Medium], and [High].	P.43
iDoc button	Send the current settings for i-Doc management to endoPRO.	—
Cecum marker	Send a command for the Cecum marker to endoPRO.	—

## Assign foot switch

Set the functions for the foot switches.

- 1 Press [>].
  - The [Assign foot switch] screen appears.
- 2 Select the foot switch for which you want to set a function from [L] and [R].
  - The selected foot switch button illuminates blue.

The function assigned to each foot switch is displayed.



- 3 Press the button of the function you wish to configure.

- You can press ◀▶ to display additional functions.
- The name of the assigned function is displayed below the foot switch.
- The functions that can be assigned are the same as "Assign scope buttons" (P.48).

Assignable Functions

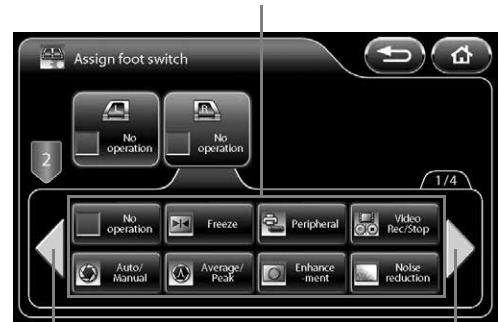

Display additional functions.

5

## Scope enhancement

Set whether or not to enable enhancement processing in the endoscope.

[Enable] Enable endoscope enhancement processing in the endoscope. Enhancement processing in the processor is disabled.

[Disable] Disable endoscope enhancement processing in the endoscope. Enhancement processing in the processor is enabled.

- 1 Press [Enable] or [Disable].

### CAUTION

When a 90i/i10/90K/K10/J10 series endoscope is connected, only enhancement processing in the processor is used, regardless of the setting of [Scope enhancement].

### NOTE

For use in combination with a different model color video processor, we recommend setting [Enable]. When an endoscope that was used with this set to [Disable] is connected to a different model color video processor, the [Enhancement] setting will be set to [Off].

## ■ Character display

Set character display for the monitor.

[Off] All characters are not displayed.

[Date/Time] Only the date and time are displayed.

[On] The information set to [ON] in [Character display] of the keyboard menu is displayed.

### 1 Select [Off], [Date/Time], or [On].

## ■ Shutter setting

Configure the shutter speed settings of the endoscope.

### 1 Press [>].

- The [Shutter setting] screen appears.

### 2 Configure the settings of [K series scope] or [i series scope].

#### ● K series scope

Set whether or not to automatically change the shutter speed of a K series endoscope when capturing normal images and close-up images.

“K series” consists of 70K, 80K, 90K, K10 and J10 series.

[Off] The shutter speed is not changed. Select [Off] when using an external light source.

[On] The shutter speed is changed. When capturing close-up images, this enables clear images to be obtained if sufficient amount of light is emitted from the lamp.

### 1 Press [Off] or [On].

#### ● i series scope

Set whether or not to automatically change the shutter speed of an i series endoscope when capturing normal images and close-up images.

[Off] The shutter speed is not changed. Select [Off] when using an external light source.

[Low] The shutter speed is changed in low speed mode. Select [Low] if limited amount of light is emitted from the lamp when capturing close-up images.

[Medium] The shutter speed is changed in medium speed mode. When capturing close-up images, this enables clear images to be obtained if sufficient amount of light is emitted from the lamp.

[High] The shutter speed is changed in high speed mode. When capturing close-up images, this enables the clearest images to be obtained if sufficient amount of light is emitted from the lamp.

### 1 Select [Off], [Low], [Medium], or [High].

#### NOTE

When turned off the lamp, the shutter speed is not changed.



Press any of the buttons to configure the setting.

## ■ Sub screen setting

Configure the settings for the sub screen displayed when, for example, the freeze function is executed.

### 1 Press [>].

- The [Sub screen setting] screen appears.

### 2 Configure the [Sub screen delay], [Sub screen position], and [Sub screen position (ERCP)] settings.

#### ● Sub screen delay

Set the display of the sub screen to be delayed.

[Off] The sub screen is displayed immediately after the freeze function is executed.

[On] The sub screen is displayed shortly after the freeze function is executed.

### 1 Press [Off] or [On].

#### ● Sub screen position

Set the position to display the sub screen.

[Upper Left] Display the sub screen on the upper left of the monitor.

[Upper Right] Display the sub screen on the upper right of the monitor.

### 1 Press [Upper left] or [Upper right].

#### ● Sub screen position (ERCP)

When using a side viewing endoscope (ED series), set the position to display the sub screen.

[Upper Left] Display the sub screen on the upper left of the monitor.

[Upper Right] Display the sub screen on the upper right of the monitor.

### 1 Press [Upper left] or [Upper right].

#### NOTE

The [Sub screen position] and [Sub screen position (ERCP)] settings are enabled only on SD monitor displays.

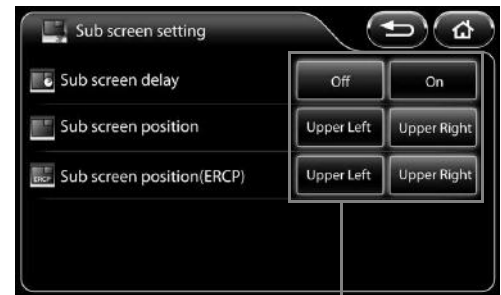

Press any of the buttons to configure the setting.

## Digital zoom setting

Configure the zoom settings for when [Digital zoom] is assigned to a customize button on the touch panel, endoscope button, or foot switch, and when zoom operations are performed with the keyboard.

### 1 Press [>].

- The [Digital zoom setting] screen appears.

### 2 Select [Off - x1.2], [Off - x1.5], [Off - x2.0], [Off - x1.2 - x1.5], [Off - x1.5 - x2.0], [Off - x1.2 - x2.0], or [Off - x1.2 - x1.5 - x2.0] to set the zoom ratio.

### 3 Select [↗↘] or [↖↙] to set the up/down order of the zoom.



When the zoom ratio has reached the maximum, pressing the customize button will return the zoom ratio to actual size.



When the zoom ratio has reached the maximum, pressing the customize button will incrementally reduce the zoom ratio until it returns to the actual size.

An animation is played at the set zoom ratio and up/down order.

Indicates the set zoom ratio and up/down order.

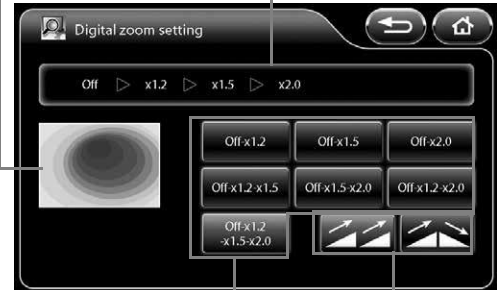

Set the up/down order of the zoom.

Set the zoom ratio.

## Optical zoom speed

You can adjust the zoom speed of an optical zoom endoscope.

### 1 Select [Low], [Medium], or [High].

#### NOTE

As the optical or electronic expanded observation display has a narrow view, please secure a view enough when performing an operation.

## Film counter type

Set the display format of the film counter.

### 1 Select [1-99], [1/2], [1/4], [1/8], or [1/16].

- If [1/2], [1/4], [1/8], or [1/16] is selected, the counter is reset to 1 when the number in the numerator becomes equal to the number in the denominator.

## P-in-P Display

Configure the display settings for P-in-P mode.

[Off] The images input from an external device are not displayed on the monitor.

[On] The images input from an external device are displayed on the monitor.

### 1 Press [Off] or [On].

## External video input

Display images input from an external device on the touch panel. Only images that are input from an external device to the VIDEO IN connector can be displayed.

### 1 Press [Switch].

- The images input from an external device are displayed on the touch panel. Touching the touch panel displays the previous screen.

## ■ P-in-P Main/Side change

Switch between the endoscopic image and external input video screens in P-in-P mode.

- [Main] The images input from an external device are displayed on the main screen of the monitor. The endoscopic images from the endoscope are displayed in the sub screen.
- [Side] The endoscopic images from the endoscope are displayed on the main screen of the monitor. The images input from an external device are displayed in the sub screen.

### 1 Press [Main] or [Side].

#### ! CAUTION

Confirm that the message "Main:External video" is displayed on the monitor while [Side] is selected.

#### NOTE

During the twin mode, the setting for [P-in-P Main/Side change] is fixed to [Main].

## ■ Enhancement setting

Specify the edge enhancement/structure enhancement display levels that can be switched using a customize button on the touch panel, endoscope button, foot switch, or keyboard.

### 1 Press [>].

- The [Enhancement setting] screen appears.
- The level that is currently specified is indicated by green characters at the top of the screen.

### 2 Press the buttons of the levels you want to use.

- The selected level buttons illuminate blue.
- Pressing a button again cancels the selection.

### 3 Press [OK].

- If you switch to another screen without pressing the [OK] button, the settings will not be applied.

The level that is currently specified is indicated by green characters.



Select the levels you want to use.

Confirm the selection.

## ■ SE setting

Specify the SE display levels that can be switched using a customize button on the touch panel, endoscope button, foot switch, or keyboard.

### 1 Press [>].

- The [SE setting] screen appears.
- The level that is currently specified is indicated by green characters at the top of the screen.

### 2 Press the buttons of the levels you want to use.

- The selected level buttons illuminate blue.
- Pressing a button again cancels the selection.

### 3 Press [OK].

- If you switch to another screen without pressing the [OK] button, the settings will not be applied.

The level that is currently specified is indicated by green characters.



Select the levels you want to use.

Confirm the selection.

## ■ CE setting

Specify the CE display levels that can be switched using a customize button on the touch panel, endoscope button, foot switch, or keyboard.

### 1 Press [>].

- The [CE setting] screen appears.
- The level that is currently specified is indicated by green characters at the top of the screen.

### 2 Press the buttons of the levels you want to use.

- The selected level buttons illuminate blue.
- Pressing a button again cancels the selection.

### 3 Press [OK].

- If you switch to another screen without pressing the [OK] button, the settings will not be applied.

The level that is currently specified is indicated by green characters.



Select the levels you want to use.

Confirm the selection.

## ■ TE setting

Specify the TE display modes that can be switched using a customize button on the touch panel, endoscope button, foot switch, or keyboard.

### 1 Press [>].

- The [TE setting] screen appears.
- The mode that is currently specified is indicated by green characters at the top of the screen.

### 2 Press the buttons of the modes you want to use.

- The selected mode buttons illuminate blue.
- Pressing a button again cancels the selection.

### 3 Press [OK].

- If you switch to another screen without pressing the [OK] button, the settings will not be applied.

The mode that is currently specified is indicated by green characters.



Select the modes you want to use.

Confirm the selection.

## ■ OE setting

Specify the OE modes that can be switched using a customize button on the touch panel, endoscope button, foot switch, or keyboard.

### 1 Press [>]

- The [OE setting] screen appears.
- The mode that is currently specified is indicated by green characters at the top of the screen.

### 2 Press the buttons of the modes you want to use.

- The selected mode buttons illuminate blue.
- Pressing a button again cancels the selection.

### 3 Press [OK].

- If you switch to another screen without pressing the [OK] button, the settings will not be applied.

The mode that is currently specified is indicated by green characters.

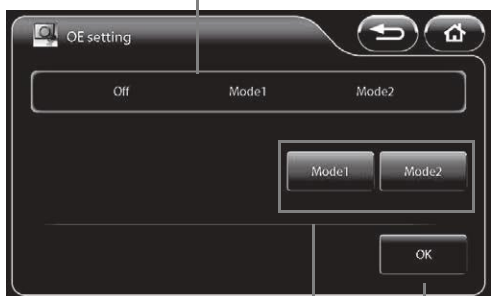

Select the modes you want to use.

Confirm the selection.

## ■ i-scan setting

Specify the i-scan modes that can be switched using a customize button on the touch panel, endoscope button, foot switch, or keyboard.

### 1 Press [>].

- The [i-scan setting] screen appears.
- The mode that is currently specified is indicated by green characters at the top of the screen.

### 2 Press the buttons of the modes you want to use.

- The selected mode buttons illuminate blue.
- Pressing a button again cancels the selection.

### 3 Press [OK].

- If you switch to another screen without pressing [OK], the settings will not be applied.

The mode that is currently specified is indicated by green characters.

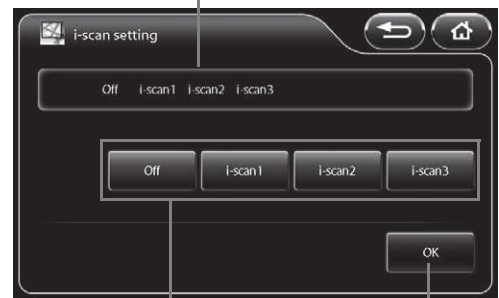

Select the modes you want to use.

Confirm the selection.

## ■ Freeze scan

Set whether or not to use the freeze scan function.

[Off]: The image is displayed as is when the freeze function is executed.

[Short][Middle][Long]:

The image with the least blur is selected automatically from the images up to a few seconds before the freeze function was executed.

The amount of time for image selection increases in the following order:[Short],[Middle], and [Long].

### 1 Press [Off],[Short],[Middle] or [Long].

#### NOTE

When you use the freeze scan function, wait for the endoscopic image on the LCD monitor to show the effect of desired image processing before capturing the image.

## [System] Tab

Pressing the [System] tab displays the following screen. The screen has four pages.

Display the setup menu for each of the categories.

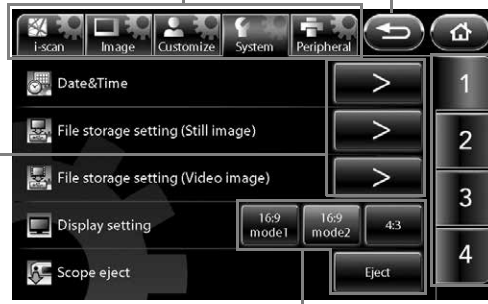

Return to the previous screen.

Return to the main screen.

Change the page.

Display the advanced settings screen.

Press any of the buttons to configure the setting.

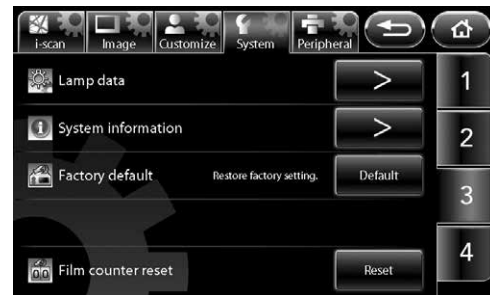

5

## Date & Time

Set the date and time to be displayed on the monitor.

- 1 **Press [>]**
  - The [Date & Time] screen appears.
- 2 **Set the time zone setting.**
  - When pressing [>] in the [Time zone setting], the [Time zone setting] will be displayed. "Time zone setting" (P.59)
- 3 **Press the box of the item for which you want to change the setting from the year, month, day, hour, minute, and second items.**
  - The selected box turns blue, and ▲▼ appear above and below the box.
- 4 **Press ▲▼ to change the setting.**
- 5 **Repeat steps 3 and 4 to set all of the items you want to change.**
  - If you press [Date style], you can change the display format of the date. Each press of the button switches the order between "year/month/day," "month/day/year," and "day/month/year".
- 6 **Press [OK].**
  - If you switch to another screen without pressing the [OK] button, the settings will not be applied.

Press the box of the item for which you want to change the setting.

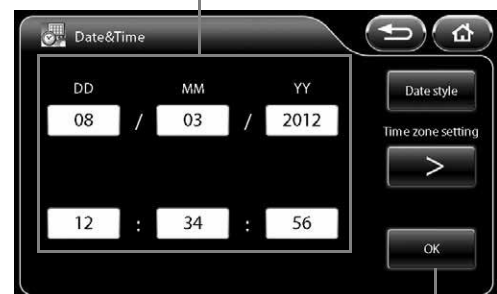

Confirm the settings.

## ● Time zone setting

Set the time zone setting.

### 1 Press [➤] of [Time zone setting] in the [Date & Time] screen.

- The [Time zone setting] screen appears.

### 2 ▲▼ to change the setting.

- Adding a check mark in the [Daylight saving time] check box adds 1 hour to the current time. Please add a check mark into the [Daylight saving time] check box manually during Daylight saving time period.

Press a check box to add or clear a check mark.

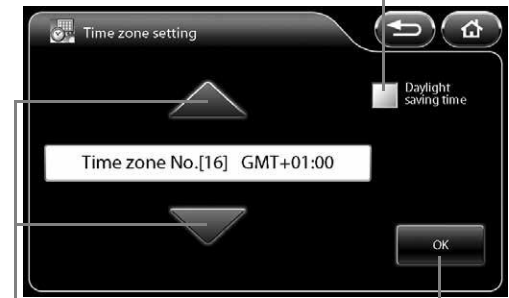

Change the setting.

Confirm the settings.

The time zone can be selected from the followings.

Time zone No.[01]	(GMT -12:00)	IDL (west side)
Time zone No.[02]	(GMT -11:00)	UTC-11
Time zone No.[03]	(GMT -10:00)	Hawaii
Time zone No.[04]	(GMT -09:00)	Alaska
Time zone No.[05]	(GMT -08:00)	PST (in the United States and Canada)
Time zone No.[06]	(GMT -07:00)	Arizona, Chihuahua, MST (in the United States and Canada)
Time zone No.[07]	(GMT -06:00)	Guadalajara, Mexico City, Monterrey, Saskatchewan, Central America, CST (in the United States and Canada)
Time zone No.[08]	(GMT -05:00)	Eastern Indiana, Bogota, Lima, Quito, EST(in the United States and Canada)
Time zone No.[09]	(GMT -04:30)	Caracas
Time zone No.[10]	(GMT -04:00)	Asuncion, Cuiaba, Santiago, AST (in Canada)
Time zone No.[11]	(GMT -03:30)	Newfoundland
Time zone No.[12]	(GMT -03:00)	Greenland, Salvador, Buenos Aires, Brasilia, Montevideo
Time zone No.[13]	(GMT -02:00)	UTC-2, Central Atlantic Ocean
Time zone No.[14]	(GMT -01:00)	Azores, Cape Verde
Time zone No.[15]	(GMT)	UTC, GMT, Dublin, Edinburgh, Lisbon, London, Monrovia, Reykjavik
Time zone No.[16]	(GMT +01:00)	Amsterdam, Berlin, Bern, Rome, Stockholm, Sarajevo, Windhoek, Warsaw, Zagreb, Brussels, Paris, Copenhagen, Madrid, Belgrade, Budapest, Ljubljana, West and Central Africa
Time zone No.[17]	(GMT +02:00)	Athens, Bucharest, Amman, Istanbul, Jerusalem, Cairo, Helsinki, Kiev, Sofia, Riga, Tallin
Time zone No.[18]	(GMT +03:00)	Kuwait, Riyadh, Nairobi, Baghdad, Kaliningrad, Minsk
Time zone No.[19]	(GMT +03:30)	Tehran
Time zone No.[20]	(GMT +04:00)	Abu Dhabi, Muscat, Yerevan, Caucasus Standard Time, Moscow, Baku, Saint Petersburg
Time zone No.[21]	(GMT +04:30)	Kabul
Time zone No.[22]	(GMT +05:00)	Islamabad, Karachi, Tashkent
Time zone No.[23]	(GMT +05:30)	Sri Jayewardenepura Kotte
Time zone No.[24]	(GMT +05:45)	Kathmandu
Time zone No.[25]	(GMT +06:00)	Astana, Ekaterinburg, Dhaka
Time zone No.[26]	(GMT +06:30)	Yangon
Time zone No.[27]	(GMT +07:00)	Novosibirsk, Bangkok, Hanoi, Jakarta
Time zone No.[28]	(GMT +08:00)	Ulan Bator, Kuala Lumpur, Singapore, Krasnoyarsk, Perth, Taipei, Beijing, Chongqing, Hong Kong, Urumqi
Time zone No.[29]	(GMT +09:00)	Irkutsk, Seoul, Osaka, Sapporo, Tokyo
Time zone No.[30]	(GMT +09:30)	Darwin
Time zone No.[31]	(GMT +10:00)	Canberra, Melbourne, Sydney, Guam, Port Moresby

Time zone No.[32]	(GMT +11:00)	Vladivostok, Solomon Islands, New Caledonia
Time zone No.[33]	(GMT +12:00)	Auckland, Wellington, Fiji, UTC+12
Time zone No.[34]	(GMT +13:00)	Samoa, Nuku'alofa

### 3 Press [OK].

- If you switch to another screen without pressing the [OK] button, the settings will not be applied.
- Make sure to set the date correctly.

## File storage settings (Still image)

Set the method to save still images.

### 1 Press [>].

- The [File storage settings (Still image)] screen appears.

### 2 Configure the settings of [Select drive], [Folder and file name], [Disk space warning], and [Option].

Display the advanced settings screen.



## Select drive (Still image)

Set the "Image Recording Media" (P.91) as the destination for saving still images.

### 1 Press [>] of [Select drive] in the [File storage settings (Still image)] screen.

- The [Select drive (Still image)] screen appears. The Image Recording Media currently connected and the total size and free space of each Image Recording Media is indicated on the screen.
- If you connect Image Recording Media after displaying the [Select drive (Still image)] screen, press [Refresh] to perform recognition of the Image Recording Media.

### 2 Press the button of the Image Recording Media to use as the save destination.

- The selected Image Recording Media button illuminates blue.

Icon indicating that the Image Recording Media is selected as the save destination for video images.

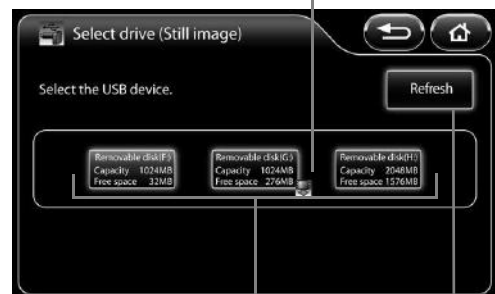

Indicates the Image Recording Media currently connected and the total size and free space of each Image Recording Media.

Perform Image Recording Media recognition again.

### NOTE

- Only one Image Recording Media can be set to save images at one time.
- Up to three Image Recording Media can be connected at one time. However, do not connect Image Recording Media via a USB hub.
- After replacing Image Recording Media, make sure you recheck that the [Select drive] setting is configured properly.
- High capacity Image Recording Media tends to take longer to be recognized by the system. Wait till the system recognizes the external module before start operating.

## ● Folder and file name (Still image)

Set the names of the folders and files generated in the PENTAX folder of the "Image Recording Media" (P.91) when still images are saved.

### 1 Press [➤] of [Folder and file name] in the [File storage settings (Still image)] screen.

- The [Folder and file name (Still image)] screen appears.

### 2 Select [Name], [ID], or [Date] of [Current folder] to set the name.

### 3 Press [Name] or [ID] of [File name] to switch it on or off.

- Each press of a button switches the name on or off.
- In addition to [Name] or [ID], a consecutive number is automatically added to a file name. A four-digit number is added when either [Name] or [ID] is on, and an eight-digit number when both of them are off.

The current folder and file name settings are displayed in a folder tree.

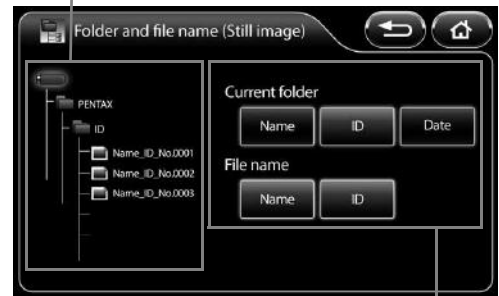

Set the folder and file names.

## ● Disk space warning (Still image)

Set the threshold for displaying the "Image Recording Media" (P.91) free space warning message.

### 1 Press [➤] of [Disk space warning] in the [File storage settings (Still image)] screen.

- The [Disk space warning (Still image)] screen appears.

### 2 Set the threshold value for displaying a warning message by pressing the number buttons.

- You can set a value within the range of 10 to 65,535.
- Pressing [Clear] resets the value to 0.

### 3 Press [OK].

- If you switch to another screen without pressing the [OK] button, the settings will not be applied.
- If the free space of the Image Recording Media reaches the set value, the message "Check memory space (Still image)." appears on the monitor.

Set the value for which to display a warning message.

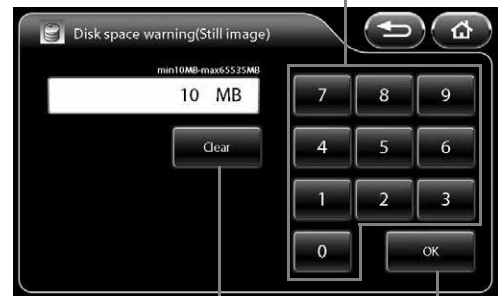

Reset the setting value.

Confirm the setting.

## ● Option (Still image)

Set options related to saving still images.

### 1 Press [➤] of [Option] in the [File storage settings (Still image)] screen.

- The [Option (Still image)] screen appears.

### 2 Set each of the items.

- [File format]  
Select the setting for the format and compression rate for saving files from [BMP], [JPEG High quality], and [JPEG Standard quality].
- [Add external.] check box  
Add a check mark to save endoscopic images and external input images as one file while external input images are displayed in P-in-P mode.
- [Add patient information.] check box  
Add a check mark to save the patient's name, ID, and other patient information together with still images.
- [Add image processing parameter information.] check box  
Add a check mark to save the SE, CE, and other image processing parameter information together with still images.

Press any of the buttons to configure the setting.

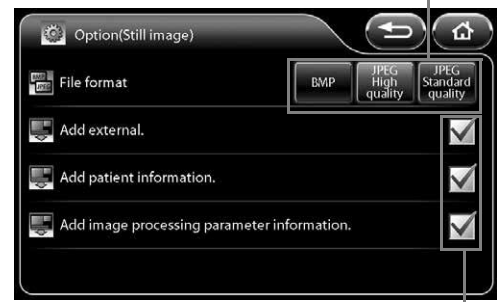

Press a check box to add or clear a check mark.

#### NOTE

- Since lossy compression is used for JPEG images, it may result in the loss of details in images.
- Please make sure to check the JPEG image quality prior to use if it is stored in JPEG format.
- When the setting allows for simultaneous saving of endoscopic image and the external input image in a single file, the file containing both image (endoscopic image and external input image) will be saved in peripheral device also. (The peripheral device must be specified under "Add external." menu)
- While still image data remains in the processor during the process of capturing to a USB printer or saving to Image Recording Media, a white "○" is displayed on the bottom right of the monitor. Do not disconnect the USB printer or Image Recording Media or turn off the processor until the "○" disappears.
- Please try not to execute the next capture until the "○" disappears.
- When trying to capture an image while system is processing the image at the same time, wait for the endoscopic image on the LCD monitor to be switched before proceeding to capture the next image.
- When the Twin mode setup is made after freezing, an image processing is not reflected in the left side screen. In the case where the USB capture is performed as is, an image-processing parametric information is added to the still picture even if not checking [Add image processing parameter information.]of [Option (Still image)]. And the image-processing parametric information of the left side screen displays "-". Image processing of the left side screen will become effective after freezing release.

## ■ File storage settings (Video image)

Set the method to save video images.

### 1 Press [➤].

- The [File storage setting (Video image)] screen appears.

### 2 Configure the settings of [Select drive], [Folder and file name], [Disk space warning], and [Option].

Display the advanced settings screen.

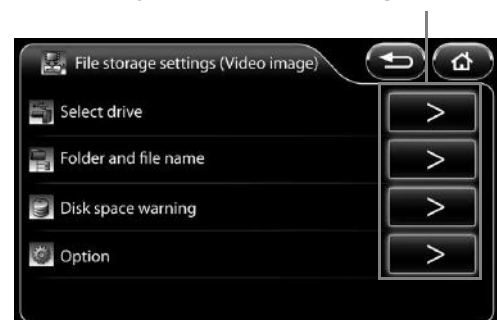

## ● Select drive (Video image)

Set the "Image Recording Media" (P.91) as the destination to save video images.

### 1 Press [➤] of [Select drive] in the [File storage settings (Video image)] screen.

- The [Select drive (Video image)] screen appears. The Image Recording Media currently connected and the total size and free space of each Image Recording Media is indicated on the screen.
- If you connect Image Recording Media after displaying the [Select drive (Video image)] screen, press [Refresh] to perform recognition of the Image Recording Media.

### 2 Press the button of the Image Recording Media to use as the save destination.

- The selected Image Recording Media button illuminates blue.

Icon indicating that the Image Recording Media is selected as the save destination for still images.

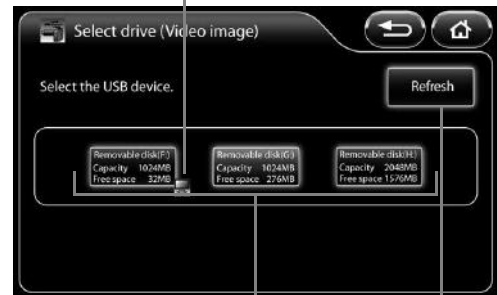

Indicates the Image Recording Media currently connected and the total size and free space of each Image Recording Media.

Perform Image Recording Media recognition again.

## NOTE

- Only one Image Recording Media can be set to save images at one time.
- Up to three Image Recording Media can be connected at one time. However, do not connect Image Recording Media via a USB hub.
- After replacing Image Recording Media, make sure you recheck that the [Select drive] setting is configured properly.
- High capacity Image Recording Media tends to take longer to be recognized by the system. Wait till the system recognizes the external module before start operating.

5

## ● Folder and file name (Video image)

Set the names of the folders and files generated in the PENTAX folder of the "Image Recording Media" (P.91) when video images are saved.

### 1 Press [➤] of [Folder and file name] in the [File storage settings (Video image)] screen.

- The [Folder and file name (Video image)] screen appears.

### 2 Select [Name], [ID], or [Date] of [Current folder] to set the name.

### 3 Press [Name] or [ID] of [File name] to switch it on or off.

- Each press of a button switches the name on or off.
- In addition to [Name] or [ID], a consecutive number is automatically added to a file name. A four-digit number is added when either [Name] or [ID] is on, and an eight-digit number when both of them are off.

The current folder and file name settings are displayed in a folder tree.

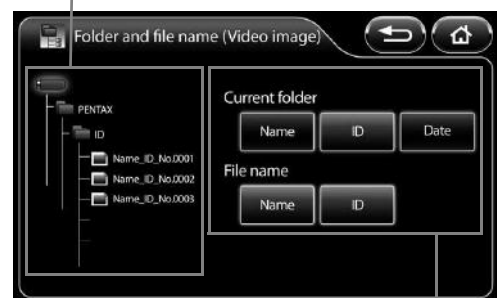

Set the folder and file names.

## ● Disk space warning (Video image)

Set the threshold for displaying the "Image Recording Media" (P.91) free space warning message.

### 1 Press [➤] of [Disk space warning] in the [File storage setting (Video image)] screen.

- The [Disk space warning (Video image)] screen appears.

### 2 Set the threshold value for displaying a warning message by pressing number buttons.

- You can set a value within the range of 100 to 65,535.
- Pressing [Clear] resets the value to 0.

### 3 Press [OK].

- If you switch to another screen without pressing the [OK] button, the settings will not be applied.
- If the free space of the Image Recording Media reaches the set value, the message "Check memory space (Video image)." appears on the monitor.

Set the value for which to display a warning message.

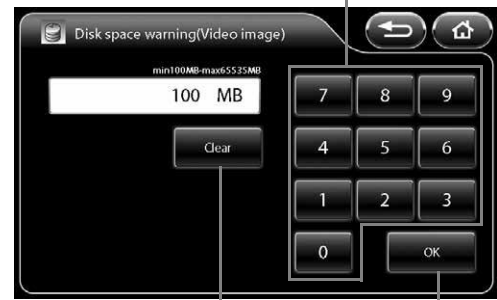

Reset the setting value.

Confirm the setting.

## ● Option (Video image)

Set options related to saving video images.

### 1 Press [➤] of [Option] in the [File storage settings (Video image)] screen.

- The [Option (Video image)] screen appears.

### 2 Set each of the items.

- [Compressibility]  
Select the setting for the compression rate for saving files from [Best quality], [High quality], and [Standard quality].
- [Add character display.] check box  
Add a check mark to save the character information together with the video images.

Press any of the buttons to configure the setting.



Press a check box to add or clear a check mark.

## NOTE

- "○ Rec" or the recording time is displayed on the monitor during the recording of video images. If the Image Recording Media is removed and inserted or the processor is turned off while "○ Rec" is displayed, the video images may not be played normally or other problems may occur.
- The maximum recording time varies depending on the setting of [Compressibility]. The maximum recording time is displayed in parenthesis on the monitor during recording.  
The maximum recording times for each [Compressibility] setting are as follows:  
[Best quality]: 15 minutes / [High quality]: 30 minutes / [Standard quality]: 50 minutes
- Minimum of 2 GB or more of availability is required in a Image Recording Media to record videos in each compression rate for maximum time period.
- The video images are automatically saved to Image Recording Media at the point in time that the maximum recording time is reached.
- Do not remove the Image Recording Media or turn off the processor during the message "Now saving." when displayed on the monitor after stopping the video image recording.
- Once the recording is started, do not stop recording at least for 10 seconds. If the recording is terminated without recording certain amount of time, abnormal values may be displayed on the computer monitor. When the video recording time is short, the length of video recording time indicated in Windows 7 might differ from the actual recorded time.

## ● Operation checked Software

- 1 The video images (MPEG-2 TS format) generated by this video processor are checked their operation with the following software in “Operation check list”. But this check only guarantees against its performance in our testing environment (PC) but not for your usage environment.

Test environment	
Item	Contents
CPU	Core2 Quad @2.66GHz
Memory	4GB
OS	Windows 7 Ultimate 32bit
Monitor	1920 x 1200 resolution

- 2 For some software, the operation check is done after installing Service Pack.
- 3 As for the device drivers like Graphics Card, etc., replay and edit in the latest condition.
- 4 As to the each operation method of software, contact to the customer service of each software manufacturer.
- 5 In following “Operation check list”, “○” means that check has been done, and “-” means inoperative.
- 6 “○” of “Sound replay” means the sound replayable case during the movie replay.
- 7 “○” is marked in case that all processes like loading, trimming, saving and format conversion are possible against the movie files (MPEG-2 TS type) generated by this product or in the case replayable the edited movie/audio file by each software.

5

Operation check list					
Name of software	Version Edition	Manufacturer	Operation check		
			Movie replay	Sound replay	Edit
Windows Media Player	11	Microsoft Corp.	○	-	-
PowerDVD	Ver.11, 12 Ultra	CyberLink Corp.	○	○	-
Adobe Premiere	Ver.10 Elements	Adobe System Inc.	○	○	○

### ! CAUTION

Don't make a diagnosis based on the digital file of still image or video image generated by this video processor.

### NOTE

- The usage of the monitor of this video processor's system configuration example is recommendable when replaying the still images and video images generated by this video processor by PC. If not, please be in mind that its reproduction characteristic may be inadequate and its color reproducibility and gradation may be variable.
- Use DVI-D output for outputting from PC when replaying the still images and video images. Or its color reproducibility and gradation may become inadequate.
- On rare occasions, the seek bar or the seek time does not be displayed appropriately.

## ■ Display setting

Set the display format of the monitor.

- [16:9 mode1] Setting for HD monitor display (The character information is displayed on the right side of the endoscopic image.)(The DVI-D signal is output from the DVI connector.)
- [16:9 mode2] Setting for HD monitor display (The character information is displayed at the top and bottom of the endoscopic image.)(The DVI-D signal is output from the DVI connector.)
- [4:3] Setting for SD monitor display(The VGA signal is output from the DVI connector.)

### 1 Select [16:9 mode1], [16:9 mode2], or [4:3].

#### NOTE

If [4:3] is selected, images cannot be output from the HD-SDI connector.

## ■ Scope eject

Use this button when you want to remove and insert an endoscope while the processor is on.

### 1 Press and hold [Eject] for 2 seconds or longer.

- The message “OK to eject.” appears on the touch panel and the monitor.
- If an endoscope is not connected, the button will not function.

### 2 Remove the endoscope from the processor.

#### NOTE

- Reconnect the endoscope when you want to use it again.
- If the “Eject” button does not change from blue to black even when the endoscope is reconnected, please try reconnecting the endoscope.

## ■ Stopwatch

Use the stopwatch function.

### 1 Press [Start].

- The stopwatch “S 00:00:00” indication is displayed below the time indication on the monitor.
- To pause the stopwatch, press [Stop]. To cancel the pause, press [Restart].
- Pressing [Reset] resets the counter to “00:00:00.” Pressing [Reset] when the counter is “00:00:00” ends the stopwatch function.

## ■ Image size

Change the display size of endoscopic images.

- [Full] Set the display size of the endoscopic image to normal size.
- [Medium] Set the display size of the endoscopic image to smaller than normal size.

### 1 Press [Full] or [Medium].

#### NOTE

- In twin mode, the display size does not change even if you change the [Image size] setting. The [Image size] setting will be applied when you set [Twin mode] to [Off].
- During analog output(exclude VGA output) of the endoscopic image, the image is always displayed in [Full] size even if the [Image size] setting is changed.

## ■ Sync out

Set the output from the VIDEO OUT/SYNC OUT connector to a synchronous signal for an external strobe device.

- [Off] Video signals are output.
- [On] Synchronous signals for a strobe device are output.

### 1 Press [Off] or [On].

## ■ Freeze release

Set the method for freeze release.

- [Off] The frozen image is maintained even after the still image is saved. Release the frozen image manually.
- [On] Freeze is released automatically when the still image is saved.

1 Press [Off] or [On].

## ■ Manual brightness level

Set the brightness adjustment level by endoscope type for when the exposure control method is set to [MANUAL].

- [Normal] Use this mode for the observation with normal brightness adjustment level.
- [Boost] Use this mode for the observation with higher brightness adjustment level. This mode is intended for the use with an otolaryngology endoscope with small diameter.

1 Press [Normal] or [Boost].

### ⚠ CAUTION

- Use [Normal] mode at first for any observation.
- If the [Boost] mode is used when a gastrointestinal endoscope with large diameter is connected, do not perform observation for a long time with brightness level +4 or higher. Failure to do so could result in a burn injury.

### NOTE

If an electronic endoscope is connected, [Boost] cannot be selected.

## ■ Lamp data

Confirm the lamp usage time, configure the lamp ignition method setting, etc.

1 Press [>].

- The [Lamp data] screen appears.

2 Configure the [Lamp ignition] setting or reset the lamp life counter with [Lamp life reset].

### ● Lamp ignition

Set the lamp ignition method.

- [Manual] The lamp can be turned on manually from the touch panel or keyboard.
- [Power on] The lamp turns on automatically when the processor is turned on.

1 Press [Manual] or [Power on].

### ● Lamp life reset

Reset the lamp life counter.

1 Press [Reset].

- The confirmation screen appears.

2 Press [Yes].

- The lamp life counter is reset to "00:00:00."
- Pressing [No] returns to the previous screen without resetting the lamp life counter.

The lamp life counter is displayed.

The number of times the lamp life counter has been reset is displayed.

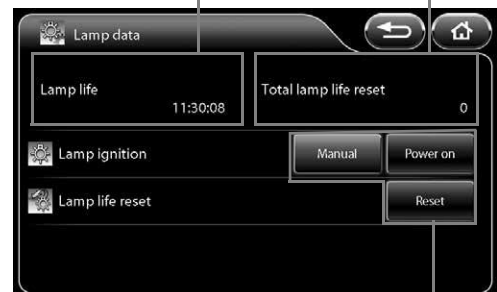

Press any of the buttons to configure the setting.

## System information

Displays the system information of the processor.

### 1 Press [>].

- The [System information] screen appears.
- The "Serial No." "Software Ver." "System life" "Lamp life" "Scope name" "Scope serial No." "Scope software Ver." and "Scope connection count" information appear on the screen.

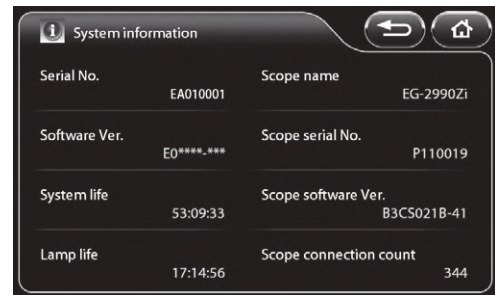

## Factory default

Reset all settings to their default values.

### 1 Press [Default].

- The confirmation screen appears.

### 2 Press [Yes].

- Pressing [No] returns to the previous screen without resetting the settings.

## Film counter reset

Reset the film counter.

### 1 Press [Reset].

- The film counter indication on the monitor is reset to "1."

## Procedure history

Save the patient's name, recording date and time, and other procedure history to "Image Recording Media" (P.91).

### 1 Press [Output].

- The [Procedure history] screen appears. The Image Recording Media currently connected and the total size and free space of each Image Recording Media is indicated on the screen.
- If you connect Image Recording Media after displaying the screen, press [Refresh] to perform recognition of the Image Recording Media.

### 2 Press the button of the Image Recording Media to be used as the save to destination.

### 3 Press [Output].

- The procedure history is saved to Image Recording Media.

Indicates the Image Recording Media currently connected and the total size and free space of each Image Recording Media.

Perform Image Recording Media recognition again.



Output the procedure history.

### NOTE

- The procedure history for up to 1,000 procedures is saved to a file in CSV format.
- If the procedure history is saved properly, the message "Procedure history saved." appears on the monitor. If it is not saved properly, the message "Copy failed." appears on the monitor.

## ■ Configuration copy

Copy the system configuration data of the processor to "Image Recording Media" (P.91).

### 1 Press [Output].

- The [Configuration copy] screen appears. The Image Recording Media currently connected and the total size and free space of each Image Recording Media is indicated on the screen.
- If you connect Image Recording Media after displaying the screen, press [Refresh] to perform recognition of the Image Recording Media.

### 2 Press the button of the Image Recording Media to be used as the copy to destination.

### 3 Press [Output].

- The system configuration data is copied to Image Recording Media.

Indicates the Image Recording Media currently connected and the total size and free space of each Image Recording Media.

Perform Image Recording Media recognition again.

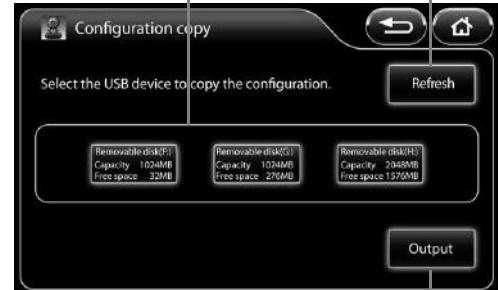

Copy the system configuration.

#### NOTE

If the configuration data is copied properly, the message "Configuration saved." appears on the monitor. If it is not copied properly, the message "Copy failed." appears on the monitor.

5

## ■ Configuration load

Load the system configuration data saved in "Image Recording Media" (P.91) to the processor.

### 1 Press [Load].

- [Configuration load] screen appears. The Image Recording Media currently connected and the total size and free space of each Image Recording Media is indicated on the screen.
- If you connect Image Recording Media after displaying the screen, press [Refresh] to perform recognition of the Image Recording Media.

### 2 Press the buttons of the Image Recording Media with the system configuration data to load.

### 3 Press [Load].

- The system configuration data is loaded to the processor.

Indicates the Image Recording Media currently connected and the total size and free space of each Image Recording Media.

Perform Image Recording Media recognition again.

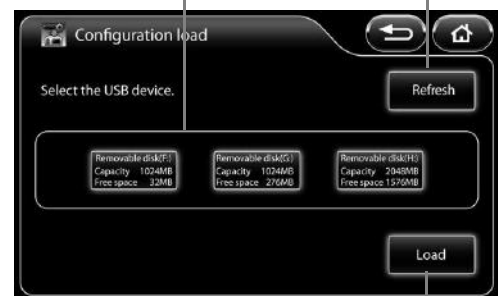

Load the system configuration data.

#### NOTE

- The system configuration data is loaded from the file "EPK-i7010ConfigurationDataEx.dat" in Image Recording Media.  
The following files cannot be read.  
"EPK-i7000ConfigurationData.dat", "EPK-i7010ConfigurationData.dat"
- The files saved other model's system settings cannot be read.
- If there is no data to load in Image Recording Media, the message "No data." appears.
- Configuration load is not available while the endoscope is being connected.

## Language

Change the display language of the touch panel menus.

### 1 Press [>].

- The [Language] screen appears.

### 2 Select [English], [Français], [Deutsch], [Español], [Italiano], [Magyar], [Polski], [Русский], or [中文].

- [English] The menus are displayed in English.
- [Français] The menus are displayed in French.
- [Deutsch] The menus are displayed in German.
- [Español] The menus are displayed in Spanish.
- [Italiano] The menus are displayed in Italian.
- [Magyar] The menus are displayed in Hungarian.
- [Polski] The menus are displayed in Polish.
- [Русский] The menus are displayed in Russian.
- [中文] The menus are displayed in Chinese.  
(Only products for China display Chinese.)

The language that is currently specified is indicated by green characters.



#### NOTE

In case that any incomprehensible language is displayed, user(s) should refer to the English IFU to manipulate.

## Input method

Set the input method of the keyboard.

[Alphabet input] Input English alphabet letters.

[French input] Input French alphabet letters.

[German input] Input German alphabet letters.

### 1 Select [Alphabet input], [French input], or [German input].

## [Peripheral] Tab

Pressing the [Peripheral] tab displays the following screen. The screen has one page.

Display the setup menu for each of the categories.

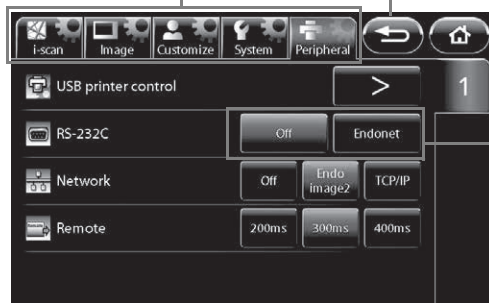

Return to the previous screen.

Return to the main screen.

Press any of the buttons to configure the setting.

## ■ USB printer control

Capture and output endoscopic images to the USB printer or print captured images.

### 1 Press [>].

- The [USB printer control] screen appears.

### 2 Select [1-up], [2-up], or [4-up] to set [Multi picture mode].

- The set split method is displayed in a preview.

### 3 Press [Capture].

- The endoscopic images are captured and output to the USB printer. "○" is displayed on the monitor during the capture.
- The boxes in the preview display illuminate blue. When [2-up] or [4-up] is set for [Multi picture mode], the boxes for the number of captured images illuminate blue in numerical order, and the box number in which the next image will be captured flashes.

### 4 Press [Print].

- The captured endoscopic images are printed.
- An animation indicates the print progress.

Split method preview display

Press any of the buttons to configure the setting.

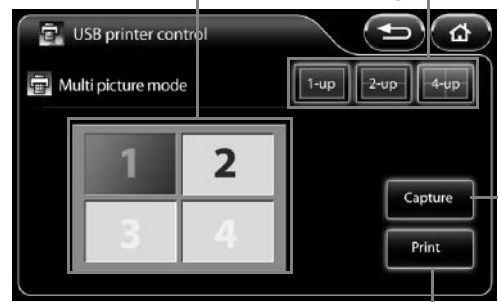

Print a captured image.

Capture an endoscopic image.

5

## ⚠ CAUTION

- Do not connect more than one USB printer or connect a printer via a USB hub.
- A white "○" is displayed on the monitor until printing has finished. Do not turn the processor off while "○" is displayed.

## NOTE

If a USB printer is not connected, [USB printer control] is not available.

## ■ RS-232C

Set the device connected to the RS-232C connector.

### 1 Press [Off] or [Endonet].

## ■ Network

Set the network connected to via the RJ45 connector.

### 1 Press [Off] or [Endoimage2].

## ■ Remote

Set the active period for output from the REMOTE connector.

### 1 Select [200ms], [300ms], or [400ms].

# Keyboard Operations

## ! WARNING

Do not use the keyboard as well as the keyboard menu while the message “Network/File system loading” is being displayed on the bottom right corner of the monitor screen.

## ! CAUTION

For the EPK-i7010 processor, use the following PENTAX Medical keyboard OS-A83.

## Key Assignment

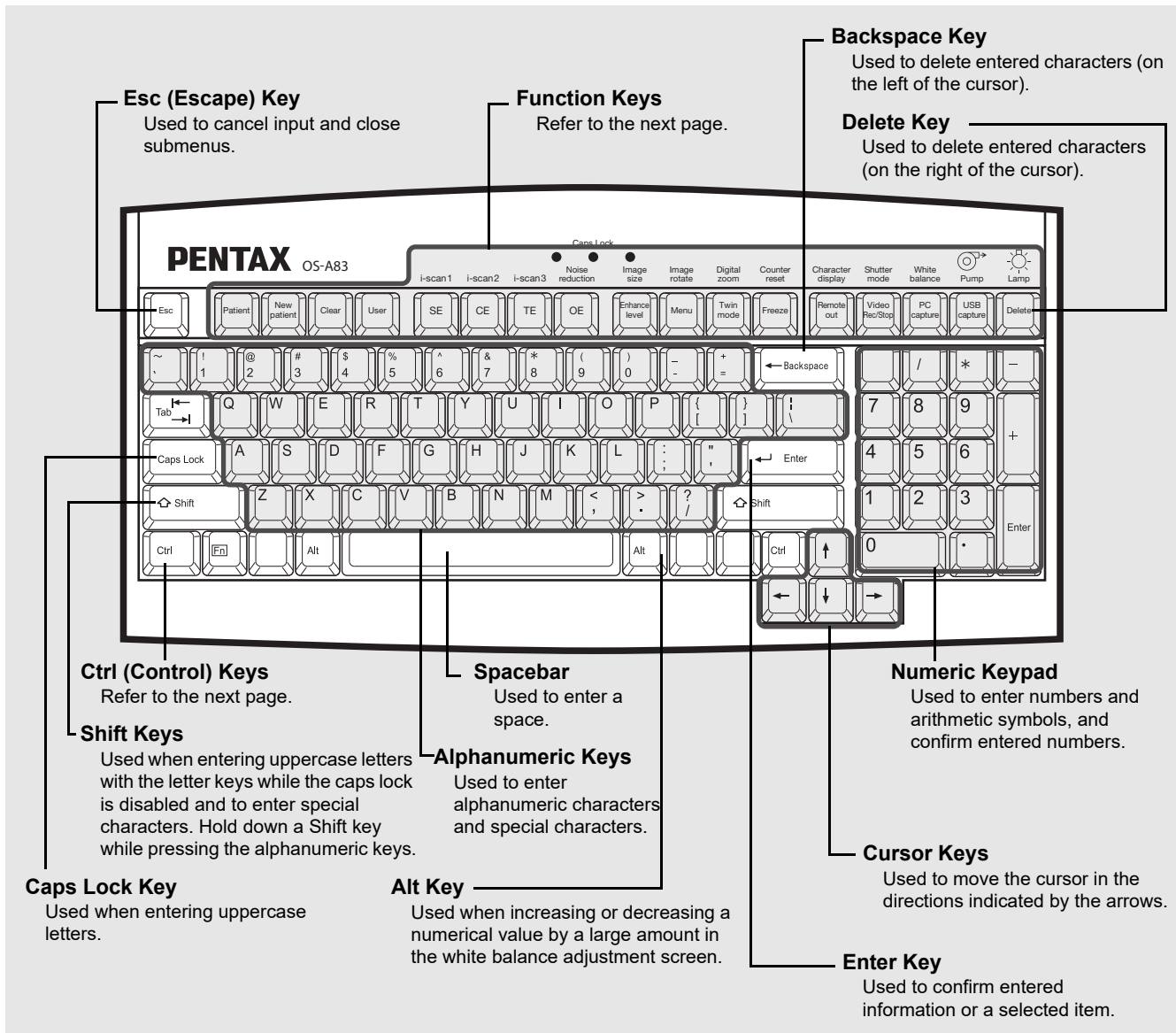

5

## ! CAUTION



















The cursor does not appear when typing the text. In case you need to correct the text, delete the text and re-type it again.











## NOTE

- Do not use a sharp object such as the tip of a pen to press the keys on the keyboard.
- Do not use the end of the light guide of the endoscope to press keys.
- Only the keyboard designed specifically for use with the processor can be used (OS-A83).
- The above illustration may not be true to the real keyboard.

## Function Keys

The following list shows the functions assigned to the function keys of the keyboard designed specifically for use with the processor.

Function Keys	Key Name	Function Outline
	[Patient]	Display the patient list.
	[New patient]	Register new patient data.
	[Clear]	Clear patient data or user data.
	[User]	Display the user list.
	[SE]	Switch the SE level to a level available in [SE setting]. (It cannot be processed simultaneously with [OE] or the structure enhancement mode [a1 to a6].)
	[CE]	Switch the CE level to a level available in [CE setting]. (It cannot be processed simultaneously with [OE].)
	[TE]	Switch the TE mode to a mode available in [TE setting]. (It cannot be processed simultaneously with [OE].)
	[OE]	Switch the OE mode to a mode available in [OE setting]. (It cannot be processed simultaneously with [SE] [CE] [TE].)
	[Enhance level]	Switch the edge enhancement/structure enhancement level to a level available in [Enhancement setting].
	[Menu]	Display the Setup screen.
	[Twin mode]	Switch twin mode on or off.
	[Freeze]	Switch between still image mode and video mode.
	[Remote out]	Output a signal from the REMOTE connector.
	[Video Rec/Stop]	Start/stop recording video.
	[PC capture]	Output the image to a PC via Endoimage2.
	[USB capture]	Output images to Image Recording Media.
	[i-scan1]	Switch the [i-scan1] i-scan mode on or off.
	[i-scan2]	Switch the [i-scan2] i-scan mode on or off.

Function Keys	Key Name	Function Outline
Keyboard OS-A83		
	[i-scan3]	Switch the [i-scan3] i-scan mode on or off.
	[Noise reduction]	Change the noise reduction level.
	[Image size]	Change the endoscopic image display size.
	[Image rotate]	Change the endoscopic image display orientation.
	[Digital zoom]	Change the endoscopic image display magnification.
	[Counter reset]	Reset the film counter.
	[Character display]	Change the character display on the monitor.
	[Shutter mode]	Change the shutter mode.
	[White balance]	Display the [White balance] screen.
	[Pump]	Display the [Pump] screen.
	[Lamp]	Display the [Lamp] screen.

**! CAUTION**

Do not press multiple keys in combinations not described above.

## Operations in the Keyboard Menu Screen

Pressing the [Patient], [User], [Menu], [White balance], [Pump], or [Lamp] key displays the keyboard menu screen on the monitor.

The keyboard menu screen consists of the [Patient list preset], [User list preset], and [Setup] tabs.

**1 Press the [←] or [→] key to select a tab.**

**2 Press the [↑] or [↓] key to select an item and press the [→] key.**

- Some settings require pressing the [←] or [→] key repeatedly to change the value and some settings require advanced settings to be configured in a sub screen.

**3 Press the [Enter] or [Esc] key.**

- Pressing the [Enter] key returns to the normal screen where any changes to the settings are reflected.
- Pressing the [Esc] key returns to the normal screen where any changes to the settings are not reflected.



5

## Operations in the [Patient list preset] Tab

### Registering New and Editing Existing Patient Data

Display the patient list. Then, register new patient data or edit registered patient data. You can register the following patient data items: [Name], [ID], [Age], [Sex], and [Comment].

**1 Press the [←] or [→] key in the keyboard menu screen to select the [Patient list preset] tab.**

- The [Patient list preset] screen (registration numbers 1 to 10) appears.

**2 Press the [↑] or [↓] key to select a patient. To register a new patient, select a number with no patient registered. To edit existing patient data, select the corresponding patient.**

- To change the page of the patient list, press the [↑] or [↓] key to align the cursor with [Page \*/\*] and then press [←] or [→].
- To delete the selected patient data, press the [Backspace] or [Delete] key. Also, to delete all patient data, press the [Clear] key. Pressing each key displays the deletion confirmation message. Select [Yes] or [No] and press the [Enter] key. If you select [Yes], the patient data is deleted from the patient list.

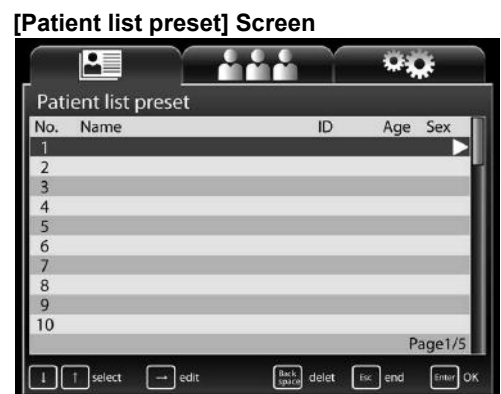

### 3 Press the [→] key.

- The [Patient data edit No.\*] screen for a new patient or the selected patient appears.
- Follow the procedure below to enter or change data in the [Patient data edit No.\*] screen. Be sure to enter a name in the [Name] field.
  - ① Press the [↑] or [↓] key to select an item.
  - ② Press the alphanumeric keys to enter or change data.  
Press the [Backspace] key in the [Patient data edit No.\*] screen to delete one character on the left of the cursor. Press the [Delete] key to delete one character on the right of the cursor.
  - ③ Press the [Enter] or [Esc] key to return to the [Patient list preset] screen.

[Patient data edit No.\*] Screen



Pressing the [Enter] key reflects any data entered and changes made and pressing the [Esc] key discards any data entered and changes made.

Pressing the [Esc] key after changing data displays the change cancellation confirmation message. Select [Yes] to return to the [Patient list preset] screen. Select [No] to return to the [Patient data edit No.\*] screen.

### 4 To enter or change data for another patient, press the [↑] or [↓] key to select a patient and repeat Step 3.

### 5 Press the [Enter] or [Esc] key.

- Press the [Enter] key to return to the normal screen where the information of the patient selected in the [Patient list preset] screen is displayed.
- Press the [Esc] key to return to the normal screen displayed prior to the [Patient list preset] screen.

#### CAUTION

- If the capture function is enabled, do not use any special symbols such as the ones below.  
Examples of symbols not to use: / . \* ? " < > : \ |

## Deleting Patient Data

Press the [Backspace] or [Delete] key while the [Patient list preset] is displayed to delete the data for that patient.

### 1 Press the [Backspace] or [Delete] key.

- A confirmation message for deleting the data appears.
- Select [Yes] to delete the displayed patient data. Select [No] to keep the registered data.

### 2 Press the [←] or [→] key to select [Yes] or [No] and press the [Enter] key.

- The [Patient list preset] screen reappears.
- Press the [Esc] key to return to the [Patient list preset] screen without deleting patient data.

[Patient list preset] Screen



## Operations in the [User list preset] Tab

### ■ Registering New and Editing Existing User Data

Display the user preset list. Then, register new user data or edit registered user data. You can register the following user data items: [User name], [Character display], [Assign scope buttons & foot SW], [Picture data], and [Picture data initialize].

#### 1 Press the [←] or [→] key in the keyboard menu screen to select the [User list preset] tab.

- The [User list preset] screen (registration numbers 1 to 10) appears.

[User list preset] Screen



#### 2 Press the [↑] or [↓] key to select a user. To register a new user, select [New] or a number with no user registered. To edit existing user data, select the corresponding user.

- To change the page of the user list, press the [↑] or [↓] key to align the cursor with [Page \*/\*] and then press [←] or [→].
- To delete the selected user data, Press the [Backspace] or [Delete] key. Pressing each key display the deletion confirmation message. Select [Yes] or [No] and press the [Enter] key. If you select [Yes], the selected user data is deleted from the user list.
- To delete all user data, press the [Clear] key. Pressing the key displays the deletion confirmation message. Select [Yes] or [No] and press the [Enter] key. The deletion confirmation message appears again. If you select [Yes] again, all user data is deleted from the user list.

#### 3 Press the [→] key.

- The [User data edit No.\*] screen appears.
- Follow the procedure below to enter or change data in the [User data edit No.\*] screen.
  - ① Press the [↑] or [↓] key to select an item.
  - ② Press the [→] key. The corresponding setup screen appears.
  - ③ Press the alphanumeric keys to enter or change data. Press the [↑], [↓], [←], and [→] keys to select items and configure the settings.
  - ④ Press the [Enter] or [Esc] key. The [User list preset] screen reappears.

Pressing the [Enter] key reflects any data entered and changes made and pressing the [Esc] key discards any data entered and changes made.

[User data edit No.\*] Screen



#### 4 To enter or change other data, press the [↑] or [↓] key to select a user and repeat Step 3.

#### 5 Press the [Enter] or [Esc] key.

- The normal screen reappears.
- Press the [Enter] key to return to the normal screen where the information of the user selected in the [User list preset] screen is displayed.
- Press the [Esc] key to return to the normal screen displayed prior to the [User list preset] screen.

## Settings in the [User data edit No.\*] Screen

You can configure the following settings for the user selected in the [User list preset] screen.

### [User name]

Enter the name of the user.

During user input, press the [Backspace] key to delete one character on the left of the cursor. Press the [Delete] key to delete one character on the right of the cursor.

### [Character display]

Set the items to display on the monitor. Select [On] for each of the [Patient name], [ID], [Age], [Sex], [User name], [Facility name], [Comment], [Date], and [Film counter] items you want to display, and [Off] for each of the items you do not want to display.

### [Assign scope buttons & foot SW]

Assign a function to each endoscope buttons 1, 2, 3 and 4 and foot switches L and R.

 "Assign scope buttons" (P.48)

 "Assign foot switch" (P.51)

### [Picture data]

Configure the image processing settings for endoscopic images.

- [SE] Select [Off] or one of six levels for the SE (surface enhancement) display setting.
- [CE] Select [Off] or one of six levels for the CE (contrast enhancement) display setting.
- [Enhancement] Select [Off] or one of two types × six levels for the edge enhancement/structure enhancement display setting.
- [Average/Peak] Select [Average] or [Peak] for the light measuring method.
- [Noise reduction] Select [Off], [Low], [Medium], or [High] for the noise reduction level.
- [Sub screen setting]
  - [Sub screen delay] Set the display of the sub screen to be delayed when the freeze function is executed.
    - [Off] The sub screen is displayed immediately after the freeze function is executed.
    - [On] The sub screen is displayed shortly after the freeze function is executed.
  - [Sub screen position] Select [Upper Right] or [Upper Left] for the position of the sub screen displayed on the monitor when using an endoscope (except when using a side viewing endoscope).
  - [Sub screen position (ERCP)] Select [Upper Right] or [Upper Left] for the position of the sub screen displayed on the monitor when using a side viewing endoscope (ED series).
- [Manual brightness level] Select one of 11 levels for the brightness setting when exposure control is set to [MANUAL].
- [Auto brightness level] Select one of 11 levels for the brightness setting when exposure control is set to [AUTO].

### [Picture data initialize]

Restore the endoscopic image settings to their initial values. Select [Yes] and then press the [Enter] key in the confirmation screen that appears. Select [No] or press the [Esc] key to return to the [User data edit No.\*] screen without initializing the settings.

## Settings in the [Setup] Tab

Configure the settings related to the processor unit and peripheral devices.

### [Facility name]

Enter the hospital name.

### [Save new patient data]

Set the registration method for registering patient information with the [New patient] key.

- [List+Temporary] The information is saved to the patient list.
- [Temporary] The registered information is only reflected in the monitor screen as temporary data.

### [Network setup]

Configure the settings for the network to connect to via the RJ45 connector. The items that can be set in [Network setup] vary depending on the setting of [Network] in the [Peripheral] tab on the touch panel.

- [Endoimage2 setup] (when [Network] is set to [Endoimage2])
  - [Processor setup]
  - [DHCP mode]

### [Setup] Screen



Select [Enable] or [Disable]. If you select [Enable], the settings for [IP address], [Subnet mask], and [Default gateway] become invalid.

[IP address] / [Subnet mask] / [Default gateway]

Follow the procedure below to enter or change settings.

- ① Press the [←] or [→] key to select an item when entering the four items separated by “.”
- ② Press the alphanumeric keys or the keys on the numeric keypad to enter or change the numbers. Each press of the [Backspace] key deletes one character on the left of the cursor. Each press of the [Delete] key deletes one character on the right of the cursor.

[Password]

Press the alphanumeric keys to enter a password. Only alphanumeric characters can be used (a to z, A to Z, and 0 to 9) and up to 12 characters can be entered. The password is case sensitive. Leave the field blank if you do not wish to set a password.

[Authorization]

Configure the network settings for the connection destination. Use the numeric keypad to configure of the [Connect ID] settings. Use alphanumeric keys to enter the Connect ID. The number of characters that can be used for the connect ID is between 6 and 12. Alphabet use in the connect ID is case sensitive.

- [iPro setup] (when [Network] is set to [TCP/IP])

[Processor setup]

[DHCP mode]

Select [Enable] or [Disable]. If you select [Enable], the settings for [IP address], [Subnet mask], and [Default gateway] become invalid.

[IP address] / [Subnet mask] / [Default gateway]

Follow the procedure below to enter or change settings.

- ① Press the [←] or [→] key to select an item when entering the four items separated by “.”
- ② Press the alphanumeric keys or the keys on the numeric keypad to enter or change the numbers. Each press of the [Backspace] key deletes one character on the left of the cursor. Each press of the [Delete] key deletes one character on the right of the cursor.

[Password]

Press the alphanumeric keys to enter a password. Only alphanumeric characters can be used (a to z, A to Z, and 0 to 9) and up to 12 characters can be entered. The password is case sensitive. Leave the field blank if you do not wish to set a password.

[iGate setup]

[iGate address] / [Gateway port] / [Active port] / [Maintenance port]

Follow the procedure below to enter or change settings.

- ① Press the [←] or [→] key to select an item when entering the four items separated by “.”
- ② Press the alphanumeric keys or the keys on the numeric keypad to enter or change the numbers. Each press of the [Backspace] key deletes one character on the left of the cursor. Each press of the [Delete] key deletes one character on the right of the cursor.

### CAUTION

- Do not operate the processor when there is an IP address conflict.
- Once an IP address conflict occurs, set the correct IP address, and turn the processor off and then on again.

### [Lamp]

Turn the lamp on or off.

- [On] Turn on the lamp.
- [Off] Turn off the lamp.

### [Pump]

Set the pump level or operate/stop the pump.

- [Pump level] Press [←] or [→] key to set the pump to one of five levels.
- [On] Operate the pump.
- [Off] Turn off the pump.

### [White balance]

Set the white balance of the endoscope.

- [White balance] Adjust the white balance of the connected endoscope.
- [R gain] Display the red gain value of the endoscope (K series only). Press the [←] or [→] key to adjust the value. Pressing the [Alt] key and [←] or [→] key simultaneously increases or decreases the value in increments of 10.
- [B gain] Display the blue gain value of the endoscope (K series only). Press the [←] or [→] key to adjust the value. Pressing the [Alt] key and [←] or [→] key simultaneously increases or decreases the value in increments of 10.
- [Reload] Restore the state before the white balance was adjusted.(K series only)

# 6 Maintenance

## After Use

Follow the procedure below after use.

### ! CAUTION

Make sure no water spills on the processor when you are performing the after care procedure. In particular, getting the connector parts and ventilation grids wet may cause a malfunction.

### 1 Turn off the peripheral devices.

### ! CAUTION

Turning off the processor prior to turning off any connected peripheral devices may cause the peripheral devices to malfunction.

### NOTE

When turning off the peripherals of the processor, follow the instructions in the IFU for each peripheral device.

- 2 Press **Ⓞ** to turn off the processor.
- 3 Disconnect the power plug, endoscope, and water bottle assembly. (Refer to Figure 6.1.)

### NOTE

Always turn OFF the processor BEFORE disconnecting an endoscope.

### ! WARNING

Recommend irrigation devices that are reprocessed after every patient use or recommend disposable irrigation devices.

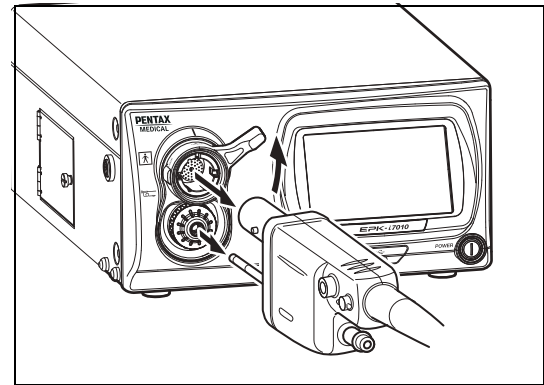

Figure 6.1

### 4 Wipe the surfaces of the processor with a gauze dampened with 70-90% ethyl or isopropyl alcohol.

- The procedure below should be followed to decontaminate the surface of this video processor that is suspected of being contaminated.
- ① Wipe the surface with gauze lightly dampened with a detergent (neutral pH, low foaming, with or without enzymes, mild/compatible with PENTAX Medical product, etc.)
  - ② Wipe the same areas with gauze lightly dampened with clean water (to remove residual detergent).
  - ③ Wipe the processor with dry gauze or lint-free cloth to remove remaining water/fluids.
  - ④ Wipe all of the surfaces with gauze dampened with 70-90% ethyl or isopropyl alcohol.

### NOTE

- Do not allow liquid to splash onto/into the processor. In particular, make absolutely sure that the connector interfaces and air intake vents do not get wet. Do not use harsh chemicals, cleaning agents, or the like when wiping the front panel of the processor because doing so may result in a malfunction of the processor. Be sure to use ethanol for disinfection when wiping the surfaces.
- Do not use spray-type medical agents such as rubbing alcohol directly to the video processor. Medical agents might enter the video processor through the air intake vents, etc. and may result in property-damage.

## CAUTION

- If the processor is turned off prior to turning off any connected peripheral devices, it may result in malfunction of the peripheral devices.
- Make sure that no water spills on the processor when you perform the aftercare procedure. In particular, getting water into the connector parts and air intake vents may result in malfunction in the processor.

### **Observe the following points when storing the processor.**

- Be sure to turn off the processor and disconnect the power plug prior to storage.
- Do not store the processor in a location with high temperature and humidity or a location where the processor could get wet or be exposed to direct sunlight.
- Store the processor in a location where dust does not enter inside the processor. Wipe off any dust on the processor. Excessive amount of dust accumulation inside the processor may result in malfunction in the processor, smoke or fire from the processor.
- Be careful not to drop the processor or subject it to an excessive mechanical shock. The processor may become unsafe to use or damaged. If the processor is subjected to an excessive mechanical shock, stop using it and contact your PENTAX Medical service facility.

## Cleaning and Storage of the Water Bottle Assembly

When washing, disinfecting, and sterilizing the water bottle assembly, be sure to follow the instructions in the IFU for OS-H5.

## Storage

### **Observe the following points on storage**

- Be sure to turn off the processor and disconnect the power plug prior to storage.
- Do not store the processor in a very hot and humid location, or where it is likely to be exposed to water or direct sunlight.

## WARNING

- Store the processor in a location where dust will not enter inside the unit. Wipe off any dust on the processor. Furthermore, when storing the processor for a long term, take precautions to reduce dust build up within the processor. Excessive amount of dust accumulation inside the unit may cause the processor to malfunction, emit smoke, or catch fire.
- Do NOT store the unit in direct sunlight or where temperature and humidity are high or where it can be exposed to liquids.

## CAUTION

Be careful not to drop the processor or subject it to an excessive mechanical shock. The processor may become unsafe to use or damaged. If the processor is subjected to an excessive mechanical shock, stop using it and contact our service personnel.

# Replacing the Lamp

Check the LIFE indicator (lamp life indicator) on the touch panel before using the processor. Follow the procedure below to replace the lamp cartridge (OL-X29) if one circle on the LIFE indicator illuminates red and a message prompting you to replace the lamp appears on the monitor.

## ! CAUTION

- The lamp life is 500 hours.
- When the total usage time of the lamp becomes 500 hours or longer, one of the circles on the LIFE indicator illuminates red and the message "Please replace the lamp." appears on the monitor.
- The lamp life may not be as long as 500 hours depending on the frequency of use.
- Please confirm lighting when you replace the lamp cartridge.  "Power-On and Lamp Inspection" (P.19)
- Replacement lamp should not be stored over an extended period of time.

## ■ Removing the Lamp Cartridge

- 1 Press  to turn off the processor and disconnect the plug from the power outlet.
- 2 Turn the screw on the lamp protective cover counterclockwise, open the cover, and check the lamp cartridge. (Refer to Figure 6.2.)

## ! CAUTION

Immediately after use, the metal lamp protective cover and the lamp bulb may be hot. To avoid burns, do not touch these parts immediately after use.

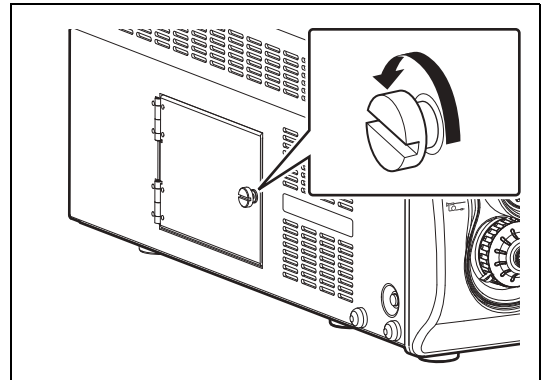

Figure 6.2

- 3 Turn the two screws at the top of the lamp cartridge counterclockwise until the fixed lamp cartridge loosens. (Refer to Figure 6.3.)
- 4 Pull the lamp cartridge out towards you while making sure it does not bang against the lamp cartridge housing.
- 5 Follow local regulations for discarding the old lamp. If unsure of appropriate procedures for lamp disposal, return the lamp cartridge/module to PENTAX Medical after packing it appropriately to avoid any damage during shipping.

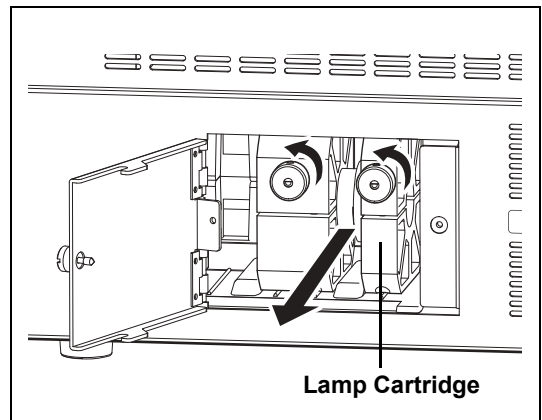

Figure 6.3

## ! WARNING

When the lamp needs to be replaced, we strongly recommend replacing both the lamp and lamp cartridge as a set. Use the PENTAX replacement lamp cartridge OL-X29, which has been developed to ensure optimal brightness and safety. Using a lamp not authorized by PENTAX Medical may result in excessive brightness and/or heat, and it is not known what kind of adverse effect that may have on the patients.

## ! CAUTION

- To avoid electric shock, do not touch both parts on the processor and the patient at the same time when performing this operation.
- During these procedures, always wear rubber gloves.

## ■ Installing a Lamp Cartridge

### ⚠ CAUTION

When performing the following procedure, always wear rubber gloves to prevent oil from your hands from getting on the glass surfaces. Do not directly touch the glass surfaces of the new lamp with your fingers.

- 1 **Hold the lamp cartridge so that the two screws on the lamp cartridge are at the front and fully insert it into the housing while keeping it straight. (Refer to Figure 6.4.)**
- 2 **Turn the screws of the lamp cartridge clockwise to secure the lamp cartridge into place.**
- 3 **Close the lamp protective cover and turn the screw on the right side of the cover clockwise.**

### ⚠ CAUTION

Be sure to turn screw ① on the lamp cartridge first to secure the lamp cartridge in place.

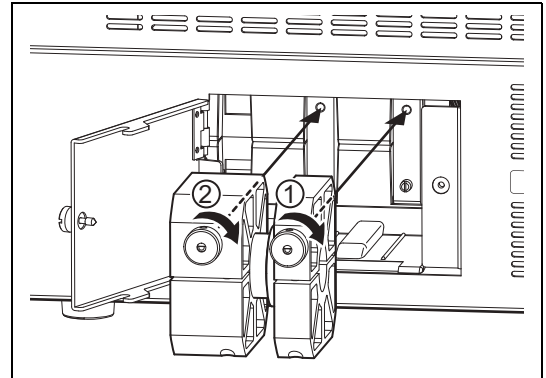





Figure 6.4

## ■ Resetting the Lamp Life Indicator

After replacing the lamp cartridge, reset the lamp life indicator on the front panel of the processor.

- 1 **Plug the power cord into the power outlet and turn on the processor.**
- 2 **Press  on the touch panel.**
  - The setup screen appears.
- 3 **Press the [System] tab at the top of the screen.**
  - The system setup screen appears.
- 4 **Press the page [3] tab on the right side of the screen.**
- 5 **Press [ > ] of [Lamp data].**
  - The [Lamp data] screen appears.
- 6 **Press [Reset] of [Lamp life reset].**
  - The [Lamp life reset] confirmation screen appears.
- 7 **Press [Yes].**
- 8 **Press the  power switch to turn off the processor and then press  again to turn the processor back on. Confirm that the lamp life indicator illuminates green.**

## Replacing the Fuses

If the power does not come on when you press the power switch, turn off the power switch and then check the following.

- The power cord is securely plugged in.
- The power breaker is activated. When activated, turn on the power switch.

If the power still fails to come on, follow the procedure below to replace the fuses.

### NOTE

A flat blade screwdriver is required to replace the fuses.

- 1 **Unplug the power cord.**
- 2 **Insert a screwdriver into the notch on either or both sides of the fuse box immediately above the power inlet socket. (Refer to Figure 6.5.)**
- 3 **Move the inserted screwdriver slightly in the inward direction.**
- 4 **When the fuse box pops out a little, pull it out by hand.**
- 5 **Inspect the fuses, and remove and replace any fuse that has blown with a supplied spare fuse. (Refer to Figure 6.6.)**

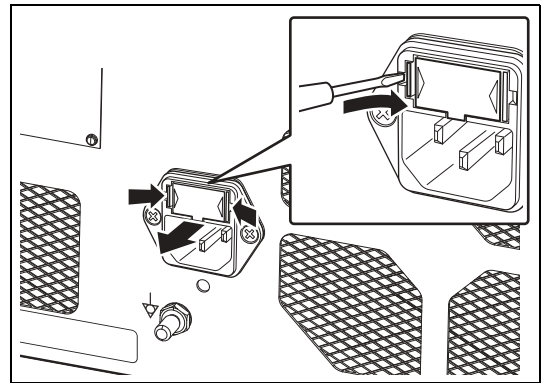

Figure 6.5

### ! WARNING

- Always replace a fuse with a supplied spare fuse (Ø5 x 20, T3.15AH, 250V).
- Never bypass a fuse.
- If the supplied spare fuse specified on the rating plate on the rear panel is not available, contact your local PENTAX Medical service facility.
- To avoid electric shock, do not touch both parts on the processor and the patient at the same time when performing this operation.

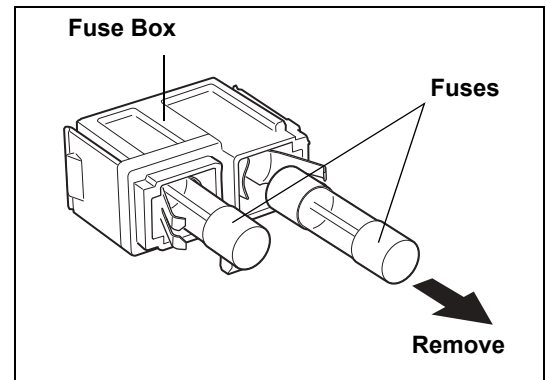

Figure 6.6

- 6 **Reinsert the fuse box, and push it with a finger until it clicks into place.**
- 7 **Connect the power cord, press the Ⓞ power switch on the processor to turn on the power, and check that the LED of Ⓞ illuminates.**

### NOTE

If the processor cannot be turned on even after the fuses have been replaced with new ones, immediately turn off the power, disconnect the power cord, and contact a PENTAX Medical service facility.

The service life of this product is six years.

Follow the instruction given in the IFU on care after use, maintenance, and usage of this product. If the processor is maintained and used improperly, it could shorten the service life of a product. Some consumable components of this product have the service life of less than six years. Contact your nearest PENTAX Medical service facility every three years for inspection and maintenance of all consumable components except lamp and fuse. Replacement of consumable components may be necessary. If the product is kept being used without periodic maintenance, it might cause a problem in switching between modes from Exposure control mode to Observation mode.

# Repair

## CAUTION

When the abnormalities of the processor are not improved after it is performed the maintenance according to the Instructions for Use or exchanged a lamp or a fuse, please be sure to request repair to your local PENTAX Medical service facility.

When returning any instrument for repair to PENTAX Medical, please be aware of the following points. Check with your local PENTAX Medical distributor for more details.

- (1) All equipment requiring repair should be shipped in a carrying box with appropriate packing together with details on the instrument damage or problem.
- (2) Write down the repair order number and your contact name, phone number, and shipping address on a piece of paper and include it in the package.

## WARNING

- Be sure to submit the instrument to a PENTAX Medical service facility for repairs. Note that PENTAX Medical is in no way liable for any injuries to patients or users, damage or malfunction of the processor, and inadequate disinfection or sterilization as a result of repairs being undertaken by an unauthorized personnel or agency. It must be recognized that PENTAX Medical does not evaluate non-PENTAX Medical parts, components, materials and/or servicing methods. Therefore, questions regarding material compatibility and/or functionality of PENTAX Medical instruments built with the unauthorized, untested and unapproved items, materials, repair/assembly methods must be referred to the third party service organization and/or device remanufacturer. It is unknown to PENTAX Medical if serviced or remanufactured instruments (performed by unauthorized PENTAX Medical entities) which still bear a PENTAX Medical label are within PENTAX Medical device specifications and/or if unauthorized activities have significantly changed the instrument's performance, intended use, safety and/or effectiveness. Ultimately, owners of these medical devices are responsible for selecting an appropriate service facility or vendor whose activities render an instrument to the same expectations and quality of a finished device supplied by the endoscope OEM.
- Be sure to delete any user and patient data from the processor before shipping in order to prevent the disclosure of personal information.
- Technical information related to repairs is listed in the service manual.
- For details about repairs, contact your local PENTAX Medical service facility.

# 7 Troubleshooting

Symptom	Possible Cause	Possible Solution	Reference Page
Cannot turn on the processor.	The power cord is not connected properly.	Securely connect the power cord to the power input socket and isolation transformer.	P.11
	A fuse has blown.	Replace the fuse.	P.84
	Lamp protective cover is not closed.	Close the lamp protective cover and turn the screw knob on the cover clockwise	—
The lamp does not illuminate.	The lamp life is over the limit.	Replace the lamp cartridge if the lamp life indicator on the touch panel is lit red and a message prompting you to replace the lamp is displayed on the monitor.	P.82
No image appears on the monitor.	The monitor settings are not configured properly.	Turn on the monitor.	P.23
		Set the proper video input signal.	P.12
		Reset the adjustment values for the monitor.	*1
	A cable is not connected properly.	Connect all cables properly.	P.12
	The endoscope is not connected properly.	Align the endoscope locking lever to the LOCK position.	P.17
	The lamp is not lit.	Press  on the touch panel to turn on the lamp.	P.26
	The endoscope is not compatible with the processor.	Contact a PENTAX Medical service facility.	—
	Abnormality in the connectors.	Contact a PENTAX Medical service facility.	—
	The monitor is connected to VIDEO OUT/SYNC OUT connector, and [Sync out] is set to [On].	Set [Sync out] to [Off].	P.66
Images are dark.	The lamp is not lit.	Press  on the touch panel to turn on the lamp.	P.26
Text cannot be typed to screen.	The keyboard is not connected properly.	Connect the keyboard to the processor properly.	P.15
The peripheral devices cannot be operated.	The peripheral devices are not connected properly.	Connect the peripheral devices to the processor properly.	P.12 -16
A long beep tone sounds and the [Copy] and [Video] functions do not work.	The settings of the customize buttons, endoscope buttons, or foot switches are not configured properly, or the peripheral devices are not connected properly.	<ol style="list-style-type: none"> <li>① Change the settings of the [Copy] and [Video] functions in the [Customize button settings], [Assign scope buttons], and [Assign foot switch] screens. If the device that is the output destination is not connected or turned off, cancel the settings.</li> <li>② Connect the cables of the peripheral devices properly and then turn on the peripheral devices.</li> </ol>	P.44 P.48 P.51  P.15
The endoscopic image stopped being displayed on the LCD monitor. Or observation is difficult due to insufficient illumination.	Power outage or there may be a damage in equipment such as lamp, processor, or LCD monitor.	Release the endoscope locking lever and the endoscope's distal tip should be straightened to its neutral position. Then, carefully withdraw the endoscope from the patient.	*2
Software version cannot be displayed correctly.	Attempting to display software version or failed to display software version.	Exit the software version display menu, and enter another menu. Then, reenter the software version display menu. Or, restart the processor.	P.68

Symptom	Possible Cause	Possible Solution	Reference Page
The endoscope buttons do not work.	Cannot communicate properly with the endoscope.	Press [Scope eject] button and remove the endoscope from the processor by aligning the endoscope locking lever to the OPEN position, and then connect the endoscope again. If the function is still not available, release the endoscope locking lever and the endoscope's distal tip should be straightened to its neutral position. Then, carefully withdraw the endoscope from the patient.	P.66
Cannot release freeze.	System malfunction caused by static generation.	Release the endoscope locking lever and the endoscope's distal tip should be straightened to its neutral position. Then, carefully withdraw the endoscope from the patient.	—
The time stamp of the saved still image file/video image file does not match the time when the image was captured.	This processor's "Time zone setting (P.59)" or "Date & Time (P.58)" differs from PC settings.	Set up this processor's "Time zone setting (P.59)" and "Date & Time (P.58)" to become the same as PC settings.	P.58 P.59
		When replayed the still image file/the video image file captured by PC having been set a different "Date & Time" or "Time zone setting", the time stamp on the still image file/video image file may be different from the date and time captured. Therefore, confirm the date and time displayed on the PC monitor.	—
Seek bar or seek time of video image file is not displayed appropriately by reproduction software.	As time property of video image file can't be read out appropriately by reproduction software.	Use other reproduction software to replay.	P.65
Image processing is not reflected in the left side screen after the Twin mode setup.	Setup of Twin mode was made after freezing.	Release freezing and check Twin mode being set, then execute freezing again.	P.41
It cannot be copied from Endonet during a "VCU ready." display.	RS-232C cable is not connected.	Connect RS-232C cable correctly and try to copy again.	—
Image is deteriorated when the saved recording file is played with PC.	This is generated originating in a compression codec processing while setting up the compression ratio Best quality.	Use setting it up with the compression rate for High quality or Standard quality.	P.64
"No Signal" is displayed in a still image.	Checked [Add external.] box of [Option (Still image)] while a still image was captured in a state of no inputting an external input image in P-in-P mode.	Capture a still image again after check that an external input image is inputted correctly. Or when an external input is not used, cancel P-in-P mode and capture a still image again.	—

\*1: For details, refer to the Instructions for Use for the monitor.

\*2: For details, refer to the Instructions for Use for the endoscope.

#### NOTE

- If there is no response even if you press any key on the keyboard, turn off the processor and contact a PENTAX Medical service facility.
- If the problem persists even after taking the measures described in the corresponding solutions above, contact a PENTAX Medical service facility.

## ■ Error Messages

When an error message is displayed on the monitor, try the following solutions. If there is a problem that cannot be resolved with the following solutions, contact your PENTAX Medical service facility.

Message Displayed on Monitor	Meaning	Solution	Reference Page
Please be prepared to replace the lamp soon.	It is almost time to replace the lamp.	Prepare to replace the lamp.	P.82
Please replace the lamp.	It is time to replace the lamp cartridge.	Replace the lamp.	P.82
Scope is not connected.	An endoscope is not connected.	Connect an endoscope.	P.17
The scope is not supported.	The endoscope is not compatible to this processor.	Connect a compatible endoscope.	P.91
Please contact your PENTAX service facility.	90i series endoscope with outdated software is connected to this video processor.	Contact a PENTAX Medical service facility.	—
Check scope connection(No**).	There is a problem communicating with the endoscope.	Reconnect the endoscope.	P.17
White balance failed! Please retry.	The white balance is abnormal.	Set the white balance again.	P.27
Change exposure control to Auto.	Set the Exposure control to [MANUAL] and adjusted the white balance of the i series endoscope.	Change the method of Exposure control to Auto.	—
Change OE mode to Off.	OE is set up except "Off" and the white balance was performed.	Set up OE "Off" and perform white balance.	—
Check USB memory.	Image Recording Media is not connected or there is insufficient space.	Connect Image Recording Media with sufficient space to the processor.	P.14
Capture failed.	Saving of the still image failed.	Try saving the still image again. If problem is not resolved after the above procedure, contact a PENTAX Medical service facility.	—
Check memory space(Still image).	Available space in the Image Recording Media for saving still images has become as low as the value set for the disk space warning.	Connect Image Recording Media with sufficient space to the processor.	P.14
Check memory space(Video image).	Available space in the Image Recording Media for saving video images has become as low as the value set for the disk space warning.	Connect Image Recording Media with sufficient space to the processor.	P.14
Check video printer.	USB printer is not connected.	Connect USB printer to the processor.	P.14
No response from VCU.	Communication with Endonet is abnormal.	Connect Endonet properly.	—
No VCU connection.	No Endonet is connected.	Connect Endonet properly.	—
AUX lamp ON. Check main lamp.	The auxiliary lamp is lit.	Check main lamp.	P.26
Lamp cooler fan stopped. Please contact your PENTAX service facility.	There is a problem with lamp cooler fan rotation.	Contact a PENTAX Medical service facility.	—
Close profile menu.	The [i-scan profile] or [Twin mode profile] screen is open.	Close the [i-scan profile] or [Twin mode profile] screen.	P.37, P.42
Retry - C function. Freeze release - F function or Frz-key on KBD.	Capturing an endoscope still image failed.	<ul style="list-style-type: none"> <li>To try capturing again: Press the Copy button.</li> <li>To cancel capturing: Press the Freeze button.</li> <li>When the error message does not disappear even if the copy button and the freeze button are pressed, please try reconnecting the endoscope.</li> </ul>	—

Message Displayed on Monitor	Meaning	Solution	Reference Page
System error. Please restart the processor(No**-**).	There was a problem with the system startup.	Restart the processor. When the same message is displayed repeatedly, contact a PENTAX Medical service facility.	P.23
System error. Please contact your PENTAX service facility(No**-**).	There was a problem with the system startup.	Contact a PENTAX Medical service facility.	—
AUX lamp ON. Please contact your PENTAX service facility.	Either the lamp was turned on when an illumination function error occurred, or an illumination function error occurred when turning on the lamp.	Contact a PENTAX Medical service facility.	—
Copy failed.	Copying the procedure history or system configuration to Image Recording Media failed.	Try copying the data again.	—
Data transfer failed.	Failed to transfer data to peripheral devices.	Retry to transfer data after confirming network connection.	—
PC:Not ready.	Capture is done while unconnected to Endoimage2.	Confirm the connection with a PC activating Endoimage2.	—
PC:HDD alert.	There is no sufficient space at PC in which installed Endoimage2.	Connect the processor to a PC with sufficient memory.	—
PC:HDD warning.	The amount of memory in PC installed Endoimage2 decreased to the alert level of insufficient space.	Connect the processor to a PC with sufficient memory.	—
PC:Transfer error.	Failed to transfer data to Endoimage2.	Contact a PENTAX Medical service facility.	—
IP CONFLICT	Setting value of IP address conflicts.	Set the IP address not to conflict and reboot the processor.	—
Video rec error.	Failed to save a movie.	Confirm the correct connection with an image record media or reboot the processor. If problem is not resolved after the above procedure, contact a PENTAX Medical service facility.	—
		When image processing level is set up highly, an error may occur to the compression codec technology. In that case, use setting it up with the compression ratio for High quality or Standard quality.	P.64
No data.	There is no data file to load in an image record media in spite of [Configuration load].	Confirm the existing file to load in an image record media.	—
Changing OE mode failed! Please retry.	When OE was changed into Mode1 or Mode2, the mode change failed.	Perform the mode change again.	—
Changing OE mode Off failed! Check scope connection.(No.**)	Because of the abnormalities occurred in communication with an endoscope when changed OE into Off, the mode change of OE failed.	Reconnect the endoscope.	—
Out of internal memory space.	It has reached the continuous-capture ceiling of the memory capacity.	Try capture again after a while.	—

## Other Messages

Message Displayed on Monitor	Meaning	Reference Page
Now printing.	USB printer is printing now.	—
Now saving.	Saving to Image Recording Media.	—
Connect to VCU.	Connected to Endonet.	—
VCU ready.	Ready to communicate with Endonet.	—
Connected to Net	Connected to the network.	—
Capture OK.	Successfully captured the endoscope still image.	—
Check white balance.	Adjust the white balance.	P.27
White balance OK!	Successfully adjusted the white balance.	P.27
Not available.	The auxiliary lamp is lit. (Some functions such as image processing cannot be used.)	—
Procedure history saved.	Saving of the procedure history is complete.	P.68
Configuration saved.	Saving of system configuration is complete.	P.69
Network/File system loading...	<p>Loading the network and file systems required to save the endoscopic still images.</p> <p> <b>WARNING</b></p> <p>Do not use the keyboard as well as the keyboard menu while this message is being displayed on the monitor screen.</p>	—
Data transfer OK.	Successfully data transferred to peripheral devices.	—
Waiting for the mode change.	Light control function is switching.	—
PC:Ready.	Ready to start transporting to Endoimage2.	—
PC:Capture OK.	Successfully captured endoscope static image to Endoimage2.	—
PC:Buffer full.	File is being saved to Endoimage2.	—
PC:Command from PC.	Capture required from Endoimage2.	—
OK to eject.	Possible to eject the endoscope.	—
This scope is not supported OE.	The connected K series endoscope is non-OE-compliant.	—
Main:External video	The images input from an external device are displayed on the main screen of the monitor.	P.54

# 8 Specifications

Model Name	EPK-i7010		
Power Requirements	Voltage	230 VAC	
	Frequency	50 - 60 Hz	
	Input current	2.4 A	
	Voltage fluctuation	±10%	
Mode of Operation	Continuous Operation		
Operating Environment	Ambient temperature	10 - 40°C	
	Relative humidity	30 - 85%	
	Air pressure	700 - 1060 hPa	
Storage and Transport Environment	Ambient temperature	-20 - 60°C	
	Relative humidity	0 - 85%	
	Air pressure	700 - 1060 hPa	
Illumination	Lamp	Xenon lamp (300 W) Model: OL-X29	
	Color temperature	6,000 K	
	Brightness control	Selection: Automatic/Manual	
	Auxiliary lamp	3W White LED	
Endoscope Compatibility	Colonoscope Family Gastroscope Family Duodenoscope Family Bronchoscope Family Naso-Pharyngo-Laryngoscope Family	K series video endoscopes, i series video endoscopes, PENTAX Fiberscopes (via video module) ("K series" consists of 70K, 80K, 90K, K10 and J10 series. "i series" consists of 90i and i10 series.)	
Video Module Compatibility	PENTAX video module PVK-1070, PVK-1070Z		
Air Supply Function	Air pump system	DC diaphragm	
	Air supply pressure (at flow rate of 0)	45 - 70 kPa (6.5 - 10.2 PSI)	
	Air supply rate (at inlet of water bottle assembly)	Level 1: 2.0 - 2.8 L/min Level 2: 2.9 - 3.4 L/min Level 3: 3.5 - 4.0 L/min Level 4: 4.1 - 4.5 L/min Level 5: 4.6 - 7.2 L/min	
	Water Supply Function	Water bottle assembly	
Brightness Control System	Auto	Selection: Average/Peak ±5 step adjustment	
	Manual	±5 step adjustment	
Color System	Color correction	Red/Blue ±5 step adjustment	
Freeze Function	Live video images displayed while freeze mode activated.		
Cooling	Forced air cooling		
Video Signals	Digital output	HD-SDI	2 sets
		DVI	1 set (combined with VGA)
	Analog output	RGB	1 set
		Y/C	2 sets
		VIDEO OUT	1 set (combined with SYNC OUT)
		VGA	1 set (combined with DVI)
Analog input	VIDEO IN	1 set	
Synchronous Signal	SYNC OUT	1 set (combined with VIDEO OUT)	
Voice Signal	Microphone	1 set	
Control Signals	RS-232C	1 set	
	RJ45	1 set	
	Remote	3 sets	
	Keyboard	1 set	
	Foot switches	1 set	
Image Recording Media	USB flash memory, external hard disk drive		
Classification as Electro Medical Equipment	Type of protection against electric shock	Class I equipment, 3 prong plug	
	Degree of protection against electric shock	Type BF (Body Floating), using insulated endoscope. Use on a heart is prohibited.	
	Degree of explosion proofing	Do not use in potentially flammable surroundings.* * The processor is not suitable for use in a mixture of air and flammable anesthetic gas or a mixture of oxygen/nitrous oxide and flammable anesthetic gas.	
Compliance	Designed in accordance with	IEC 60601-1:2005+A1:2012 IEC 60601-2-18:2009	
Size (Excluding Protrusions)	400 mm (W) × 205 mm (H) × 520 mm (D)		
Weight	21.5 kg		
Electro Magnetic Compatibility	IEC 60601-1-2:2007		
IP Classification	IPX0		

This product conforms to IEC60601-1-2: 2007: Medical electrical equipment, EMC standard.

## Guidance and manufacturer's declaration-electromagnetic emissions

This product is intended for use in the electromagnetic environment specified below. The customer or the user of this product should assure that it is used in such an environment.

Emissions test	Compliance	Electromagnetic environment-guidance
RF emissions CISPR 11	Group 1	This product uses RF energy only for its internal function. Therefore, its RF emissions are very low and are not likely to cause any interference in nearby electronic equipment.
RF emissions CISPR 11	Class B	This product is suitable for use in all establishments, including domestic establishments and those directly connected to the public low-voltage power supply network that supplies buildings used for domestic purposes.
Harmonic emissions IEC 61000-3-2	Class A	
Voltage fluctuations/ flicker emissions IEC 61000-3-3	Complies	

## Guidance and manufacturer's declaration-electromagnetic immunity

This product is intended for use in the electromagnetic environment specified below. The customer or the user of this product should assure that it is used in such an environment.

Immunity test	IEC 60601 test level	Compliance level	Electromagnetic environment - guidance
Electrostatic discharge (ESD) IEC 61000-4-2	±6 kV contact ±8 kV air	±6 kV contact ±8 kV air	Floors should be wood, concrete or ceramic tile. If floors are covered with synthetic material, the relative humidity should be at least 30 %.
Electrical fast transient/burst IEC 61000-4-4	±2 kV for power supply lines ±1 kV for input/output lines	±2 kV for power supply lines ±1 kV for input/output lines	Mains power quality should be that of a typical commercial or hospital environment.
Surge IEC 61000-4-5	±1 kV differential mode ±2 kV common mode	±1 kV differential mode ±2 kV common mode	Mains power quality should be that of a typical commercial or hospital environment.
Voltage dips, short interruptions and voltage variations on power supply input lines IEC 61000-4-11	5 % $U_T$ (>95 % dip in $U_T$ ) for 0.5 cycle  40 % $U_T$ (60 % dip in $U_T$ ) for 5 cycles  70 % $U_T$ (30 % dip in $U_T$ ) for 25 cycles  <5 % $U_T$ (>95 % dip in $U_T$ ) for 5 sec	<5 % $U_T$ (>95 % dip in $U_T$ ) for 0.5 cycle  40 % $U_T$ (60 % dip in $U_T$ ) for 5 cycles  70 % $U_T$ (30 % dip in $U_T$ ) for 25 cycles  <5 % $U_T$ (>95 % dip in $U_T$ ) for 5 sec	Mains power quality should be that of a typical commercial or hospital environment. If the user of this product requires continued operation during power mains interruptions, it is recommended that this product be powered from an uninterruptible power supply or a battery.
Power frequency (50/60 Hz) magnetic field IEC 61000-4-8	3 A/m	3 A/m	It is recommended that this product be used apart from other devices operated with large current.
<b>Note:</b> $U_T$ is the a.c. mains voltage prior to application of the test level.			
Conducted RF IEC 61000-4-6	3 Vrms 150 kHz to 80 MHz	3 Vrms	The recommended separation distance: $d = 1.2 \sqrt{P}$
Radiated RF IEC 61000-4-3	3 V/m 80 MHz to 2.5 GHz	3 V/m	The recommended separation distance: $d = 1.2 \sqrt{P}$ 80 MHz to 800 MHz $d = 2.3 \sqrt{P}$ 800 MHz to 2.5 GHz
<ul style="list-style-type: none"> <li>● <math>P</math> is the maximum output power rating of the transmitter in watts (W) according to the transmitter manufacturer.</li> <li><math>d</math> is the recommended separation distance in metres (m).</li> </ul>			

**Note:**

- At 80 MHz and 800 MHz, the higher frequency range applies.
- These guidelines may not apply in all situations. Electromagnetic propagation is affected by absorption and reflection from structures, objects and people.
- Interference may occur in the vicinity of equipment marked with the following symbol:



- Field strengths from fixed RF transmitters, as determined by an electromagnetic site survey,<sup>a)</sup> should be less than the compliance level in each frequency range.<sup>b)</sup>
  - a) Field strengths from fixed transmitters, such as base stations for radio (cellular/cordless) telephones and land mobile radios, amateur radio, AM and FM radio broadcast and TV broadcast cannot be predicted theoretically with accuracy. To assess the electromagnetic environment due to fixed RF transmitters, an electromagnetic site survey should be considered. If the measured field strength in the location in which this product is used exceeds the applicable RF compliance level above, this product should be observed to verify normal operation. If abnormal performance is observed, additional measures may be necessary, such as re-orienting or relocating this product.
  - b) Over the frequency range 150 kHz to 80 MHz, field strengths should be less than 3 V/m.

## Recommended separation distances between portable and mobile RF communications equipment and this product

This product is intended for use in the electromagnetic environment in which radiated RF disturbances are controlled. The customer or the user of this product can help prevent electromagnetic interference by maintaining a minimum distance between portable and mobile RF communications equipment (transmitters) and this product as recommended below, according to the maximum output power of the communications equipment.

Rated maximum output power of transmitter (W)	Separation distance according to frequency of transmitter (m)		
	150 kHz to 80 MHz $d = 1.2 \sqrt{P}$	80 MHz to 800 MHz $d = 1.2 \sqrt{P}$	800 MHz to 2.5 GHz $d = 2.3 \sqrt{P}$
0.01	0.12	0.12	0.23
0.1	0.38	0.38	0.73
1	1.2	1.2	2.3
10	3.8	3.8	7.3
100	12	12	23

For transmitters rated at a maximum output power not listed above, the recommended separation distance  $d$  in metres (m) can be estimated using equation applicable to the frequency of the transmitter, where  $P$  is the maximum output power rating of the transmitter in watts (W) according to the transmitter manufacturer.

**Note:**

- At 80 MHz and 800 MHz, the higher frequency range applies.
- These guidelines may not apply in all situations. Electromagnetic propagation is affected by absorption and reflection from structures, objects and people

**Contacts**

**Manufacturer**



**HOYA Corporation**  
6-10-1 Nishi-shinjuku,  
Shinjuku-ku, Tokyo  
160-0023 Japan

**Distributors**

**PENTAX Europe GmbH**   
Julius-Vosseler-Straße 104  
22527 Hamburg, Germany  
Tel: +49 40 561 92-0  
Fax: +49 40 560 42 13

**PENTAX Medical**  
**A Division of PENTAX of America, Inc.**  
3 Paragon Drive  
Montvale, NJ 07645-1782  
USA  
Tel: +1 201 571 2300  
Toll Free: +1 800 431 5880  
Fax: +1 201 391 4189

**PENTAX Medical Shanghai Co., Ltd.**  
Room 701, 291 Fumin Road, Shanghai  
200031 P. R. China  
Tel: +86 21 6170 1555  
Fax: +86 21 6170 1655

**PENTAX Medical Singapore Pte. Ltd.**  
438A Alexandra Road, #08-06  
Alexandra Technopark, 119967 Singapore  
Tel: +65 6507 9266  
Fax: +65 6271 1691  
Customer Service Toll Free:  
400 619 6570 (within China)  
1800 2005 968 (within India)  
1300 PENTAX (within Australia)

81240



2018.07 6217001 P227 R03

LCPM 02/2018/09/35011802

Specifications are subject to change without notice and without any obligation on the part of the manufacturer.