



# SD PLUS

User and Service Manual

Document Number: MH3x.ENG

Version: 1.11

(**SD PLUS** Firmware from Version 2015.04  
SystemPlus EVOLUTION Software from Version 1.04.0185)

Date: 02/01/2018

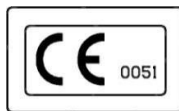

via Giotto 2 – I-31021 - Mogliano Veneto (TV)  
tel. +39-041-5937000  
fax. +39-041-5937011  
E-Mail [micromed@micromed.eu](mailto:micromed@micromed.eu)



# CONTENTS

<b>OVERVIEW .....</b>	<b>4</b>
<b>PRECAUTIONS.....</b>	<b>5</b>
<b>PATIENT SAFETY.....</b>	<b>5</b>
<b>UNIT CARE .....</b>	<b>7</b>
<b>SD PLUS DESCRIPTION .....</b>	<b>8</b>
<b>MAIN TECHNICAL CHARACTERISTICS .....</b>	<b>8</b>
<b>ACCESSORIES .....</b>	<b>9</b>
Electrodes .....	9
Cables for connection to the PC interface .....	9
Oximeter Nonin (optional) .....	9
Inductive belts (optional) .....	10
<b>OTHER RELATED PRODUCTS .....</b>	<b>10</b>
Software .....	10
PC and interfaces.....	10
<b>DEVICE DESCRIPTION .....</b>	<b>11</b>
<b>USER INTERFACE.....</b>	<b>13</b>
<b>SYMBOLS .....</b>	<b>15</b>
<b>CONNECTIONS.....</b>	<b>15</b>
Connection with the PC.....	15
Connection with the oximeter and the sensors.....	15
Connection to the patient .....	16
<b>USE OF THE SD PLUS AMPLIFIER .....</b>	<b>17</b>
<b>SETUP PHASE.....</b>	<b>17</b>
<b>START OF THE RECORDING.....</b>	<b>17</b>
<b>CONTROL OF INPUTS IMPEDANCE.....</b>	<b>18</b>
<b>USE OF MARKER .....</b>	<b>19</b>
<b>STOP OF THE RECORDING.....</b>	<b>19</b>
<b>SERVICE AND TECHNICAL INFORMATIONS .....</b>	<b>20</b>
<b>CONNECTIONS SAFETY.....</b>	<b>20</b>
Long distance cable connection .....	21

<b>DEVICE CONNECTORS .....</b>	<b>22</b>
Oximeter port (OXY) .....	22
Data transfer connector .....	22
Pre-wired electrode cap connector .....	23
Trigger RCA connector .....	24
Inductive belts connectors.....	24
<b>FIRMWARE MAINTENANCE AND UPDATING .....</b>	<b>25</b>
Enabled features.....	25
<b>FUNCTIONAL CONTROLS .....</b>	<b>26</b>
<b>CHECK OF DEVICE STATUS .....</b>	<b>26</b>
<b>GENERAL FUNCTIONAL CONTROLS.....</b>	<b>26</b>
CMRR test - EEG channels .....	26
CMRR test – polygraphic channels .....	27
Background noise test – EEG channels .....	27
Background noise test – polygraphic channels .....	27
Correct amplification test- EEG channels .....	28
Correct amplification test - polygraphic channels .....	28
Large bandwidth EP channels test .....	28
Impedance check .....	28
Automatic Test Software .....	28
<b>TECHNICAL SPECIFICATIONS.....</b>	<b>29</b>
<b>Channels characteristics.....</b>	<b>29</b>
<b>Electrical characteristics.....</b>	<b>30</b>
<b>Mechanical characteristics .....</b>	<b>30</b>
<b>Environmental conditions.....</b>	<b>30</b>
<b>Electromagnetic environment .....</b>	<b>31</b>
Precautions against ESD.....	32
<b>CONFORMITY DECLARATION .....</b>	<b>33</b>

# OVERVIEW

**SD PLUS** is a transportable acquisition system for bioelectric signals to be transferred to the acquisition, visualization and reporting Micromed software.

It is intended to be used in the diagnosis of neurological diseases characterized by episodic alteration of EEG parameters or evoked potentials. It can be used even in the physiotherapeutic and pneumologic fields for the study of electromyographic activity and breathing or other parameters coming from transducers directly applied on the patient, for example the oximeter.

Analog signals coming from the inputs are amplified, converted in digital form, formatted by a programmable logic device and transferred to the microcontroller. From this data is stored in a RAM memory and transmitted to the PC. The PC is used by the software SystemPlus EVOLUTION to manage the storage and display of data transmitted.

**SD PLUS** is available in two versions: **SD PLUS RESEARCH** (48 channels) and **SD PLUS FLEXI** (38 channels). The first one has 40 EEG common reference channels, the second one 32. Some of these channels, respectively 16 and 8, are electronically switchable between the common reference and the bipolar one (differential). In turn **SD PLUS FLEXI** provide some variants with reduced number of channels, called **HIGH RATE** and **CLINIC**.

Moreover the devices have: two bipolar channels that can also be used for high frequency PE, 3 channels for data coming from the oximeter connected to the appropriate input (SpO<sub>2</sub>, plethysmogram, Heart Rate) and one channel for the marker. In the **RESEARCH** version, there are also 2 channels for inductive bands (Thor, Abdo).

The device is enclosed in a plastic case and has a total weight of only 390 g.

On the front of the device the LCD display allows the visualization of specific information. Below the display, the user interface also provide three buttons: **CHECK**, **START** and **MARKER**.

**SD PLUS** is endowed of touch-proof plugs for patient connection, through standard EEG electrodes; and of dedicated connectors for oximeter and inductive bands connections. Each plug is equipped with a LED, indicating the quality of the electrical connection to the patient.

Communication with the PC is made with the **BQ USB EXPRESS** or **BQ PCI EXPRESS LTM** interface connected to the PC, that also provides power to the device. This allows you to connect the device using a single cable, optimizing handling. Communication lines with the interface and power line are electrically isolated, ensuring maximum safety for the patient.



Figure 1 : SD Plus device

# PRECAUTIONS



**The following manual describes the use of the SD PLUS recorder and the set-up procedures.**

**Only qualified personnel (doctors or neurophysiologic technicians) can use the present product for the performance of neurophysiologic exams (EEG, EP, polygraphy.)**

It is intended to be used in the diagnosis of neurological diseases characterized by episodic alteration of EEG parameters or evoked potentials. It can be used even for the study of electromyographic activity and breathing or other parameters coming from transducers directly applied on the patient, for example the oximeter.

The device is not intended to monitor the central nervous system functionality in conditions where a warning on the change of patient condition is essential (e.g. OR and ICU automatic monitoring **without the presence of the physician**), since it is not endowed with proper alarms that substitute continuous medical surveillance. The use of SD PLUS must always be carried out under the supervision of a physician or a qualified technician.

## PATIENT SAFETY

Avoid spilling any liquids on the system components and if this happens DO NOT USE THE SYSTEM FOR ANY REASON and contact your zone representative immediately for necessary assistance.

The patient must be connected to the device through surface or needle EEG electrodes, compliant with 93/42/EEC Directive and ISO 10993 standard on biocompatibility.

Device management and electrodes application for signals acquisition must be always performed by authorized qualified technicians or doctors.

In connecting the electrodes, take care to their hindrance, in order to not get entangled during movement impairing the fixing of the electrodes or being dangerous for the patient.

Check channels impedance with the dedicated function before connecting the device to the patient.

Attention is due during the connection and disconnection of cables and accessories

Always check the correct functioning of the channels via the impedance check feature before connecting the device to the patient (see [Impedance check](#) on page 28).

Use only Micromed approved accessories: in particular, only the specific oximeter model can be used. The devices possibly connected to channels inputs must be transducers compliant with EN 60601-1, not amplified or battery-powered and having maximum output signal amplitude lower than  $\pm 4.5V$ . The use of accessories, interfaces and cables different than those specified by the manufacturer, may result in increased electromagnetic emissions and it may cause an improper operation.

The device has some connection and communication doors with the oximeter (specifically adapted for this device) and with other sensors. The communication and, therefore, the possibility to acquire or send signals depends on the functionality of both devices. It is thus recommended to carefully check the functionality of the oximeter and of the sensors before starting signals acquisition.

The connectors of the auxiliary inputs (oximeter and respiratory efforts belts) should be treated with care. Pulling the cable instead of the connector is less effective, could damage the insulation integrity.

Do not expose the recording inputs to very high signals. In particular be careful during the connection of the cables for the connection to the patient, the PC and the auxiliary devices (oximeter and transducers): the inputs are very sensitive to electric-static discharges.

Be careful that conductive parts of the electrode, when connected to system and not to the patient, do not get in touch with conductive surfaces, even if these surfaces are provided of the earth protection connection.

The connection of multiple medical electric devices to the same patient can cause possible summation of leakage currents that should be carefully evaluated.

The contemporary connection of a patient with the acquisition system and with a surgical unit at high frequency can burn the contact points of the acquisition electrodes and cause possible damage to the device. To reduce the hazards of burns in the event of a defect in the HF surgical neutral electrode connection, the electrodes should not be placed between or in proximity of the surgical site and the return electrode of the electrosurgical unit.

The use of the **SD PLUS** in the immediate surroundings (1m) of a unit for therapy with short waves or microwaves could produce errors in the acquired data.

The application of high potential difference to the electrodes input can cause damage to the amplification system.

The device is not defibrillation proof and damage to the equipment and the patient could occur as a result of the use of a defibrillator on a patient connected to the **SD PLUS**. The acquisition electrodes must not be located between defibrillator pads.

The device is not suitable for use with MRI equipment.

Apart from the above referenced cases, the simultaneous use of other patient-connected equipment is safe.

The device requires particular attention for the EMC environment and must be installed and operated in compliance with the EMC information, given in the *Environmental conditions* section (page 30)

Portable and mobile radio communication devices must not be used closer than 30 cm from the device parts, also from cables specified in ACCESSORIES section.

The use of these devices near other medical devices should be avoided (respect the recommended distances in the paragraph ELECTROMAGNETIC COMPATIBILITY of technical manual).

The device is not suitable for use in presence of flammable anaesthetic mixtures with air, oxygen or nitrous oxide.

Use only Micromed approved cables for the interconnection of the various components of the system, in order to preserve the electrical isolation and the operative characteristics.

In order to maintain the electrical safety characteristics, during direct acquisition and data transfer, the **SD PLUS** amplifier must be exclusively connected, through interface, to a PC compliant with the standards IEC 60950 and placed outside the patient area, or to a Micromed acquisition system endowed of isolation transformer.

The **SD PLUS** amplifier is built with rugged materials, but it is an electronic device and it is not indestructible: pay attention to avoid rough crash. In case this was to happen, before re-using the device, check the functionality in particular, the integrity of the cover and the fixing of the connectors. In presence of not normal behaviour DO NOT OPEN the device to verify or repair damages but immediately contact your zone representative for the necessary assistance.

## UNIT CARE

Inspect the container, the accessories and the recording cables to verify the presence of eventual damage caused by transport. Such problems should be verified and reported to your Micromed zone representative before using the unit.

Before cleaning the system make sure that it is turned off. Do not use abrasives or solvents of any type.

Clean the device using a "humid" cloth (not wet) on the external part of the cover. Clean the connection cables with a humid cloth. Substitute electrodes even after any application whenever needed for hygienic reasons.

In case the unit falls from heights inferior to 1m make sure of the regular functionality of the device, by means of the impedance CHECK test and the calibrating resistors, before using on patient. For drops from superior heights, Micromed personnel must control the device.

Do not open the cover of the system or expose it to abnormal conditions (high temperatures or excessive humidity)

Avoid spilling any materials, in particular liquids, on the system components and if this were to happen do not use the system for any reason and contact your zone representative for necessary assistance.

Do not repair or substitute autonomously any parts of the units. For any problems please refer to qualified personnel. In case of potentially dangerous events, have the head box checked even if it seems to work well.

Contact your zone representative to organize a periodic maintenance check (at least every two years).

Do not dismiss the device together with common waste. Verify the local rules for the electronic equipment waste dismissal.

Micromed S.p.A. reserves the right to modify products, specifications or manuals whenever deemed necessary without prior notice.

Micromed S.p.A. declines every responsibility regarding the security, reliability and services if the device is mishandled or however repaired by non-authorized personnel. For all modifications regarding cables and accessories please contact Micromed in order to guarantee the device compatibility.

# SD PLUS DESCRIPTION

## MAIN TECHNICAL CHARACTERISTICS

- Two basic versions:

### SD PLUS RESEARCH

- 40 Common Reference channels (ch. 1 – 40). 16 of these could be switched in Bipolar Reference (ch. 25-40)
- 02 Bipolar channels, that could be used also for high frequency PE acquisition (Ch. EP1, EP2)
- 02 Inductive belts channels (Thor, Abdo)
- 03 Oximeter channels (SpO<sub>2</sub>, Pletismogramma, Heart Rate)
- 01 Marker channel

### SD PLUS FLEXI

- 32<sup>1</sup> Common Reference channels (ch. 1 – 32). 8 of these could be switched in Bipolar Reference (ch. 25-32)
- 02 Bipolar channels, that could be used also for high frequency PE acquisition (Ch. EP1, EP2)
- 03 Oximeter channels (SpO<sub>2</sub>, Pletismogramma, Heart Rate)
- 01 Marker channel
- EEG channels:
  - Sampling frequency variable from 256Hz to 16 kHz per channel
  - Maximum bandwidth DC-F, with F dependent on sampling frequency  $F_s$  ( $0.27 \cdot F_s$ );
  - Full-scale range: from  $\pm 3.2\text{mV}$  to  $\pm 1638.4\text{mV}$ ;
  - ADC 24 bit (resolution capability to 67nV)
- EP channels:
  - Sampling frequency variable from 256 Hz to 128 kHz per channel
  - Maximum bandwidth 0.11 Hz-12.8 KHz; the upper band limit decreases to  $0.31 \cdot F_s$  when the sampling frequency get below 64 kHz
  - Full-scale range: from  $\pm 0.8 \text{ mV}$  to  $\pm 51.2 \text{ mV}$ ;
  - ADC 24 bit (resolution capability to 0.095nV)
- Amplification and filtering set by software
- Touchproof connectors compliant with DIN 42802 for electrodes and D-Sub 25-pin connector for pre-wired headphones.
- Impedance control on each input viewable via LED
- 1 serial port for **BSP OXY** oximeter (3 channels: Pletismogram, SaO<sub>2</sub>, HR, requires no external power supply)
- Internal microcontroller



- Graphic display for displaying information and alerts<sup>1</sup>
- Power supply from the PC via the interface; insulation up to 2500V<sub>AC</sub> through magnetic couplers on communication lines and to 3 kV<sub>DC</sub> via DC / DC converter on power lines, for patient safety
- Small size and lightweight for maximum handleability

**SD Plus Flexi** presents two variants with reduced performances, named **SD Plus Flexi Highrate** and **SD Plus Flexi Clinic**. These two amplifiers present exactly the same features of **SD Plus Flexi** amplifier (listed above), except for the following limitations:

#### **SD Plus Flexi HighRate**

- 29 acquisition channels (freely selectable from the acquisition software setup screen, between the 38 channels of the **Flexi** version)

#### **SD Plus Flexi Clinic**

- 29 acquisition channels (freely selectable from the acquisition software setup screen, between the 38 channels of the **Flexi** version)
- variable sampling rate from 256 Hz to 1 KHz per channel

The Micromed SystemPlus EVOLUTION software allows the user to display and store in the PC the data acquired by **SD PLUS**. The software allows the following visualization and analysis items:

- Reading, editing and storage of the tracks in the hard disk or optical disc
- Review of bipolar or common-reference montages
- Re-montage of common-reference signals
- Modification of the gain, filter, and time base of the viewed signals
- Notch filter activation
- Possibility of data analysis

## **ACCESSORIES**

### **Electrodes**

With the device standard EEG surface electrodes or needle electrodes with DIN 42 802 touch-proof jacks can be used. Only electrodes compliant with ISO10993-1 standard on biocompatibility and approved according 93/42/EEC Directive must be used.

### **Cables for connection to the PC interface**

The device can be connected to the interface only by using the specific **HBC EXPRESS** cable (5m). A cable terminal **TERM EXPRESS** (30cm) with a quick detach connector is also available. For information on the connection modes, see *Connection with the PC* on page 15. Do not use other connections to the PC. It must stay outside the patient area (1.5 m).

### **Oximeter Nonin (optional)**

The device serial port is usually used to connect an oximeter. The device supports the **BSP OXY** device, based on Nonin XPOD oximeter. It can be connected to the 3-pin connector.

<sup>1</sup> It is possible to obtain some derived versions, limited via software in channel number or in performance

### ***Inductive belts (optional)***

For recording of breathing effort, S.L.P. SleepSense® 9002 inductive bands and specific interface cables must be used. Input connectors are designed to accept this model of inductive belts. Contact Micromed for information on other model compatibility.

When **SD PLUS** amplifier is used for recording parameters associated with respiratory effort, it should not be intended as an apnea monitor, because the device is not equipped with warning mechanisms. The signal detected by the inductive belts shall be intended only as information for the completion and integration of the EEG pattern.

## **OTHER RELATED PRODUCTS**

### ***Software***

The device can be used as a data source for the Micromed SystemPlus EVOLUTION acquisition and review software. The SW interface module with the recorder manages both the acquisition of data in real time and the reading of the data contained in the memory support. The acquired data will be then saved in the standard Micromed EEG format and displayed during the direct review via the review functions included in the software.

**SD PLUS** device is supported from SystemPlus EVOLUTION version 1.04.0135. Additional functions will be progressively added in new versions.

### ***PC and interfaces***

**BQ USB EXPRESS** or **BQ PCI EXPRESS** interfaces must be used.

The PC must be compliant with the IEC 60950 standard and the overall system configuration must comply with IEC 60601-1-1. This can be achieved simply by not introducing the PC in the patient area. Alternatively, the device can be connected to a Micromed acquisition system, already configured for the usage in a patient area (that is, it uses a separation transformer for the PC and all connected devices and it is separated from network connections by proper isolators).

The PC must support the SystemPlus EVOLUTION software release supplied.

**DEVICE DESCRIPTION**

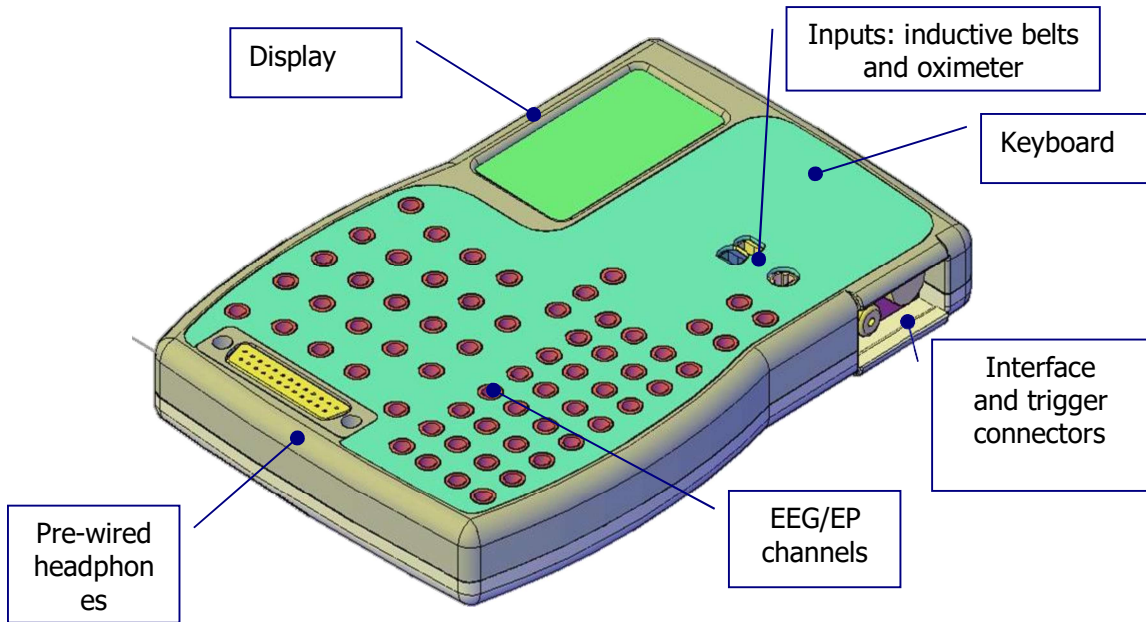

**Figure 2: Main parts of the device**

In Figure 2 ( above ) is shown the position of the main components of the device, while below is reported the location of the connectors and the description of their functions. For more information on the characteristics of the connectors, see chapter *Mechanical characteristics* on page 30

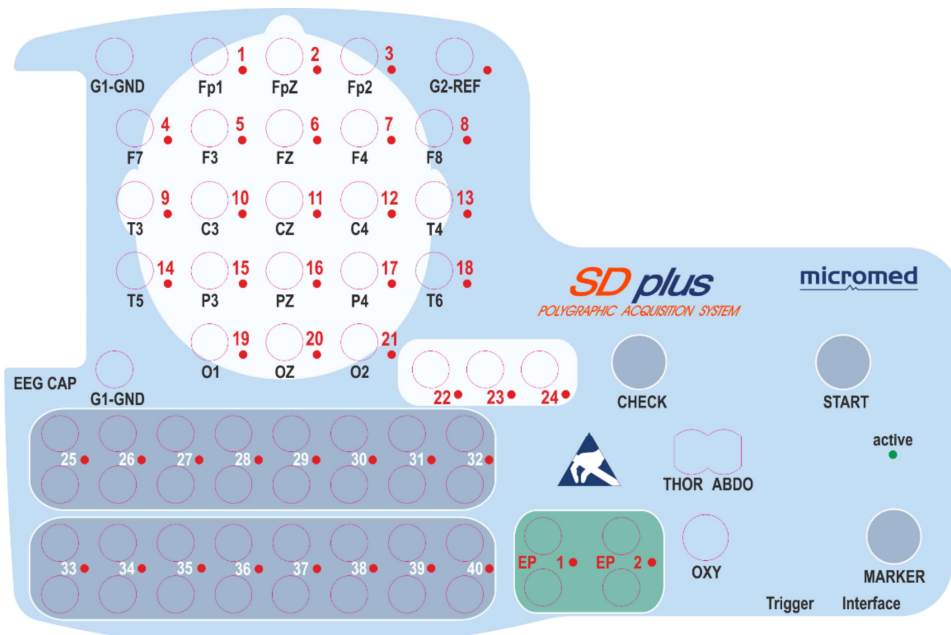

**Figure 3: Arrangement of input connectors and controls**

Label	Connector	Description
<b>(CH)1...21</b>	Red touch-proof plugs (TP)	EEG common reference inputs ("unipolar" – acquired with respect to G2-REF) and labeled according to the 10-20 standard
<b>(CH)22...24</b>	Red TP plugs	Additional EEG common reference inputs ("unipolar" – acquired with respect to G2-REF)
<b>(CH)25...40</b>	Pair of red (+) / black(-) TP plug	EEG inputs configurable by SW as common reference inputs (acquired with respect to G2-REF) or as differential inputs (acquired with respect to the negative input – black plug) <sup>2</sup>
<b>G2-REF</b>	white TP plug	Common reference for unipolar channels (it is connected to the negative inputs of 1 to 24 channels and of 25 to 40 channels, configured by SW as differential channels)
<b>G1-GND</b>	Green TP plugs	Ground reference of differential acquisition channels (centered with respect to full scale)
<b>EP1-EP2</b>	Pair of red (+)/black(-) TP plug	Differential inputs high-frequency sampled for electromyography and evoked potentials acquisitions
<b>EEG CAP</b>	D-Sub 25-pin connector	Pre-wired headphones connection, as an alternative to TP plugs
<b>THOR/ABDO</b>	Blue/yellow key-shaped connector	Inputs for inductive bands connection for measuring respiratory effort <sup>3</sup> . The connectors are coloured in accordance with those of the bands, for easier identification of the signal.
<b>OXY</b>	3-pin connector	Input for <b>BSP OXY</b> oximeter connection
<b>Interface</b>	Black 4-pin connector	Connection of the <b>HBC EXPRESS</b> cable or <b>TERM EXPRESS</b> cable for connection to the acquisition interface
<b>Trigger</b>	RCA connector	Connection of triggers from other equipment that are acquired and transmitted to the PC with EEG signal. Triggers setting is done in SystemPlus EVOLUTION software.

Table 1 : Description of the connectors

<sup>2</sup> In **SD PLUS FLEXI**, **SD PLUS FLEXI HIGHRATE** and **SD PLUS FLEXI CLINIC** models channels 33 to 40 are not present.

<sup>3</sup> In **SD PLUS FLEXI**, **SD PLUS FLEXI HIGHRATE** and **SD PLUS FLEXI CLINIC** models these channels are not present.



## USER INTERFACE



The device is equipped with 3 buttons, through which the operator can obtain information on its status and note observations at specific points of the track. A detailed description of these three buttons is shown in the table below.

Button	Description
<b>CHECK</b>	Pressed during the recording, inserts a marker on the track (the message "Note CHECK" will display on the screen). If pressed for a few seconds, it allows to displayed two information screens.
<b>MARKER</b>	Pressed during the recording, inserts a marker on the track. If pressed for a few seconds, it allows to displayed two information screens.
<b>START</b>	Pressed during the recording, inserts a marker on the track (the message "Note NOTE" will display on the screen). If pressed for a few seconds, it allows to displayed two information screens.

Table 2 – Description of the commands

The display provides the user with various information about the status of the device.

	<p>At the beginning of the acquisition appears the timer. After about one second, the screen turns off to avoid artifacts on the acquired signal.</p>
	<p>When the operator activates check function from the software (symbol <math>\Omega</math>), the display shows a map of the channels activated for acquisition. Every channel is indicated in the map with a small rectangle whose size is proportional to the measured impedance. On the right side of the display is shown the legend that associates to every rectangle an impedance value (&lt;5k, &lt;10k<math>\Omega</math>, &lt;20k<math>\Omega</math>, &lt;30k<math>\Omega</math>, &lt;40k<math>\Omega</math>). If the impedance exceeds the set limit of 15 k<math>\Omega</math>, the LED near the entry flashes.</p>
	<p>Pressing a button (<b>MARKER</b>, <b>CHECK</b> or <b>START</b>) for about 5 seconds the first information screen will appear. It shows, from top to bottom: device name, device model, EEG channel number, EP channel number, auxiliary channels number. Below, it is shown the number of channels that you can actually use in relation to the specific amplifier model ("all channels" for the <b>RESEARCH</b> and the <b>FLEXI</b> one, "29 channels" for the <b>CLINIC</b> and the <b>HIGHRATE</b> one). Below are finally shown the device serial number and the hardware key associated with the specific model (i.e.: for the <b>RESEARCH</b> model the key is 460AAE), accompanied by four digits that identify the amplifier last date of testing.</p>

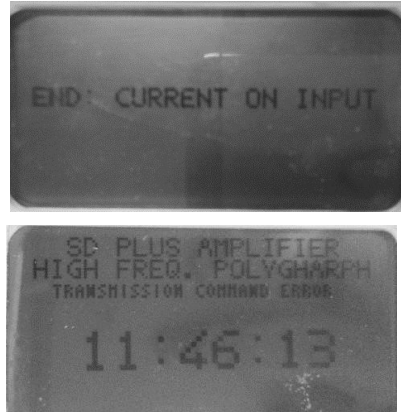
	<p>Pressing <b>CHECK</b> button for about 5 seconds, simultaneously with the acquisition start, an information screen showing the serial number of the device, the hardware key and the firmware version will appear.</p>
	<p>If the DC component of the input signal is too wide compared to gain set or to channel dynamics (i.e. if its amplitude is greater than or equal to 1.2 V peak-peak), the acquisition channel saturates and loses the ability to adequately perform the acquisition. In this case the display shows a warning message, consisting of a map (similar to the impedance-check map), where the position of the electrodes is indicated with a dash ( ). Saturated channels can be highlighted in two different ways. The indicator ■s used if channel saturation is measured downstream of the amplifier and is therefore avoidable by reducing the gain of the channel in the setup options of the software. The indicator ■ is used if saturation occurs upstream of the amplifier and therefore could be eliminated only by the reduction of the DC component of the signal.</p>
	<p>If a current greater than 100 <math>\mu</math>A is measured on the inputs of the amplifier, the device beeps and the display shows the two screens in the figure, one after the other. The amplifier interrupts the power supply from the part connected to the patient. Then the software shows the message "Headbox Restart" and tries to restart the device. The last operation can only happen if the fault condition has been resolved. If the fault condition persists, contact technical assistance.</p>

**Table 3 – Information on the display**

Additional information on the status of the device is provided by LEDs.

LED	Colour	Meaning
Next to channel number	red	Impedance measured on the acquisition channel is higher than threshold set, or the channel is saturated. Acquisition on the channel may be low quality. For more information, see chapter <i>CONTROL OF INPUTS IMPEDANCE</i> on page 18
<b>ACTIVE</b> , on the right side of the keyboard	green	Lights while the device is acquiring data

**Table 4 : Description of indicator lights**

## SYMBOLS



Degree of protection from electrical direct or indirect contact: class II equipment



Degree of protection from electrical direct or indirect contact: type BF equipment



Information: "Follow instructions for use"



2012/19/EU Directive (Waste of electrical and electronic equipment): at the end of its use life the device must be disposed separately from domestic waste to allow components recycling.



ESD warning symbol: The pins of the connectors marked with this symbol should not be touched with fingers or metallic tools, unless proper precautions have been taken. Read the information in chapter *Precautions against ESD* on page 32



Manufacturing date (year): device expected lifetime is 10 years; maintenance is due every two years



CE marking according to Directive 93/42/EEC - Notified Body IMQ

## CONNECTIONS

### Connection with the PC

The connection to the PC is achieved via cable link towards the interface, which, in turn, is connected to the PC through the cable integrated into it (**BQ EXPRESS USB**) or inserted into the PC itself (**BQ PCI EXPRESS**).

The cable is an electric link transferring power supply and control signals to the device and the acquired data to the PC. The cable must be connected to the interface 4-pin connector on the device and to the 5-pin connector on the interface.

All the connectors have a specific insertion direction: take care not to force the insertion because it could lead to damage to the connectors and consequent inability to transmit data.

The cable is an electric link and care should be taken that the isolation is maintained, especially in the placement of the PC, in respect to the patient. See chapter *CONNECTIONS SAFETY* on page 20 for instructions and examples of allowed connections.

### Connection with the oximeter and the sensors

The device is designed to accept on the inputs signals from the patient or from sensors compliant with the IEC 60601-1 safety standard and with input specifications of the channel. To guarantee the device isolation and patient safety, connect only passive or battery powered devices. For the connection, refer to specifications description in chapter *Channels characteristics* on page 29 and to the connected device manufacturer instructions.

The oximeter connection (**OXY**) is designed to be connected to the **BSP OXY** oximeter. Read carefully the warnings and instructions attached to the oximeter before the use.

The induction bands connection is intended for the use of a specific model of bands (see [ACCESSORIES](#) section on page 9). Read carefully the warnings and instructions attached to the bands before the use.

### **Connection to the patient**

The patient is connected to the device via electrodes with cables with touch-proof (DIN 42802) connectors.

For the channels configurable as common reference or differential, both positive (red sockets) and negative (black sockets) inputs are available.

The black sockets are physically connected to the amplifier negative input only if the channel is set as differential in the "Connect" screen of the SystemPlus EVOLUTION software (see [SETUP PHASE](#) on page 17 and the SystemPlus EVOLUTION on-line help)

For the common reference channels the negative input of the amplifier is connected to the signal coming from the socket labelled **G2-REF**, which act as common reference, while the signal on the black socket is not acquired.

The input labelled **G1-GND** is connected to the internal voltage reference of the acquisition channels (GND or patient ground).

See also the warnings given in the chapter [PATIENT SAFETY](#) on page 5.

Read carefully the relevant section on page 17



# USE OF THE SD PLUS AMPLIFIER

## SETUP PHASE

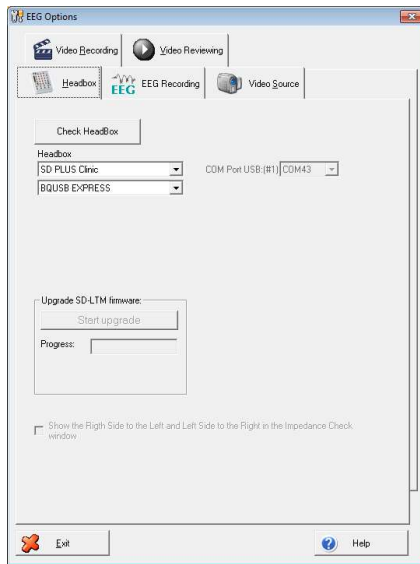

**Figure 4 –Headbox setting n  
SystemPlus EVOLUTION software**

- Set SystemPlus EVOLUTION software for the acquisition from **SD PLUS**: in the setup screen of the amplifier, set the **SD PLUS** model and the interface model used. If you set up a wrong model, you cannot proceed with the acquisition, and it will be presented an error message.
- Connect the interface communications cable to the dedicated connector on the bottom of the device.
- The device will turn on automatically when you start the acquisition.

## START OF THE RECORDING

- From SystemPlus EVOLUTION, create a new EEG exam
- Set the desired connection to the device in the dedicated SystemPlus EVOLUTION screen, accessible from the Modify→Connection menu (Connect screen).  
All the acquisition settings are available from this window, according to the amplifier set in the headbox setup screen: the channels to be activated, the labels to be assigned to the channels, the acquisition reference (common or differential), the possibility of using the additional channels of the oximeter, of the bands of breath and of evoked potentials, the HW parameters of the channel (full scale and filters). Some predefined connections, corresponding to the standard methods of EEG acquiring, are already present.



An incorrect setting of the device characteristics in the Connect can bring to obtain information that could be interpreted wrongly. Before each acquisition, verify that the parameters set via software are consistent with what you desire to achieve.

- Connect the electrodes to the patient.



During the operation of patient connection, carefully check that electrodes are connected to correct inputs and that channels are correctly labelled in the settings of the software. An incorrect connection or identification may lead to misinterpretation or loss of data

- Check the quality of the connection using the dedicated impedance-check function
- Start the acquisition by SystemPlus EVOLUTION.

## CONTROL OF INPUTS IMPEDANCE

To get a good signal even in adverse environmental conditions, caused by high electromagnetic pollution, it is necessary to use short or shielded electrodes cables. The device should be kept away from electromagnetic sources: mobile and cordless phones, some PCs, and displays, emit strong pulsed electromagnetic fields that appear as background noise on the trace.

The EEG electrodes are probably cup-shaped or put in a pre-wired headphones. Make sure of the correct application of the electrodes to reduce the possibility that they can detach during the acquisition.

To improve the impedance contact between the electrodes and the skin, is generally used a gel for EEG recording. In long recordings, the user should make sure that the gel used has a drying time compatible with the recording time: the recording quality could be seriously compromised by using an inappropriate gel

Most of polygraphy sensors, instead, has special ways of application, then it is recommended to follow the instructions supplied with them.

To obtain a good acquisition, the most critical factor is the correct application of all the EEG electrodes, with a low impedance value on the patient and a correct positioning of the common reference electrode G2.

The impedance should be kept as low as possible and should be balanced, or similar in value, among the electrodes, to ensure the best quality of the signal. A good connection should have impedance lower than 5 K $\Omega$ .

Impedances values of the electrodes may be checked using the appropriate function. Activating check function via software (icon  $\Omega$ ), the LEDs next to the inputs with impedance that exceeds the threshold value will light. At the same time these channels will be highlighted on the display (see chapter [USER INTERFACE](#) to page 13). The connections of these channels need an intervention in order to reduce their impedance.

The improvement of the contact between the skin and the electrode can be achieved by the removal of obstacles (such as hair), by the addition of other conductive gel, being careful not to cause a short circuit between nearby electrodes, or by the gentle abrasion of the surface layer of the scalp. In this last case is suggested the replacement or the sterilization of the electrodes, after their use.

The impedance measured values are shown on the PC screen, in a specific window of SystemPlus EVOLUTION.



This function allows also checking whether the acquisition channels work properly, since the signal internally generated to check the impedance is processed like the acquired signal. If the impedance of a channel not connected to the patient is low or null, or on the contrary the impedance remains high even if the electrode is put in contact with reference electrode (G2 or the negative input for the differential channel), **do not use the recorder and have it checked by Micromed technical assistance.**

---

---

## USE OF MARKER

---

During the recording, pressing a button (**MARKER**, **CHECK** or **START**) will allow to insert a note at that specific moment of acquisition. The device will beep and the display will show a message indicating the acceptance of the note. These notes can be seen only when you visualize the track in SystemPlus EVOLUTION. Notes can be used to report events or peculiar conditions. A special feature of the software allows you to attach a description to the note associated to the event.

---

## STOP OF THE RECORDING

---

The acquisition can be interrupted by SystemPlus EVOLUTION, disabling the **RUN / STOP** (▶) button in the Acquisition toolbar.

At the end of the exam retest electrodes impedance to verify the maintenance of the connection quality during the entire acquisition.

# SERVICE AND TECHNICAL INFORMATION

## CONNECTIONS SAFETY

The connection to the PC is achieved via cable towards the interface, which, in turn, is connected to the PC through the cable integrated into it (**BQ EXPRESS USB**) or inserted into the PC itself (**BQ PCI EXPRESS**).

The cable is an electrical connection that leads to the amplifier power supply and control signals and transfers the acquired data to the PC. It should be connected to the 4-pin connector on the device and to the 5-pin connector on the interface.

**SD PLUS** supply lines are isolated and are connected to the interface, which gives another degree of isolation from the PC. The cables and devices before the interface (including the PC) cannot enter the patient area because it could not be compliant with the requirements for the enclosure leakage current. If the PC must enter the patient area, it must be part of a Micromed acquisition system configured with the specific isolation transformer.

If you need a longer connection, follow instructions in chapter *Long distance cable connection* on page 21, and see Figure 9 - Long distance connection diagrams

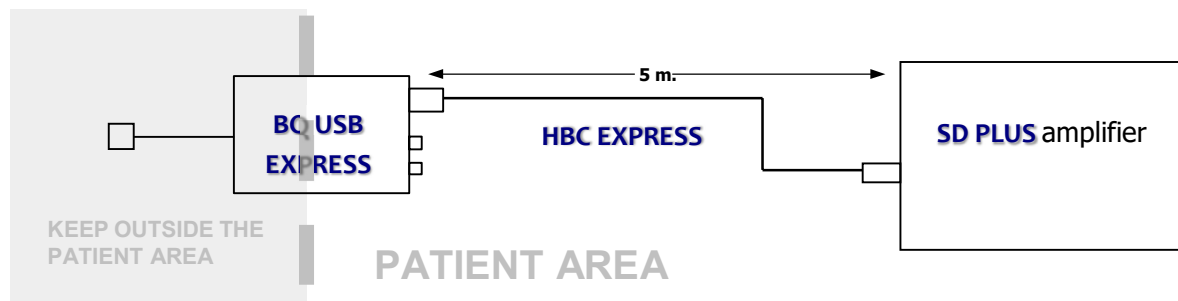

Figure 5 - BQ USB EXPRESS connection

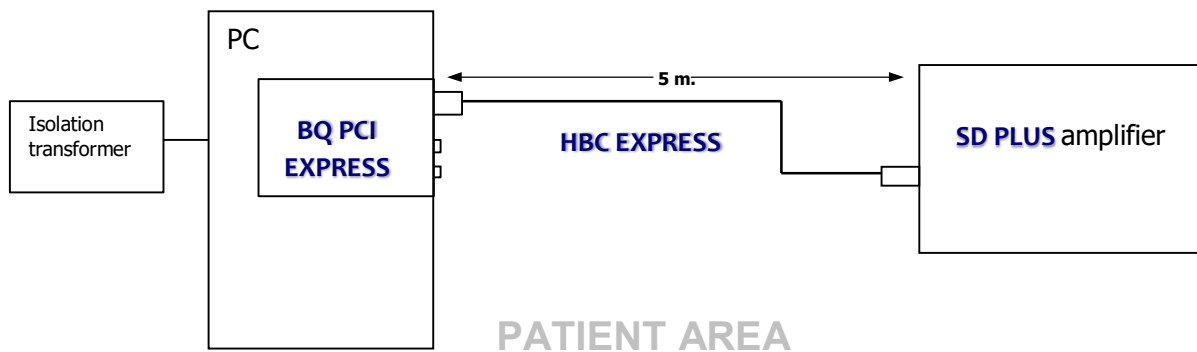

Figure 6 – BQ PCI EXPRESS connection in patient area

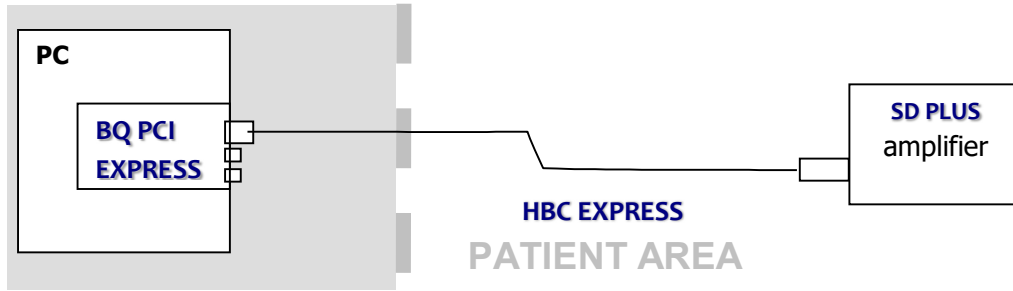

Figure 7 - BQ PCI EXPRESS and PC connection out of patient area

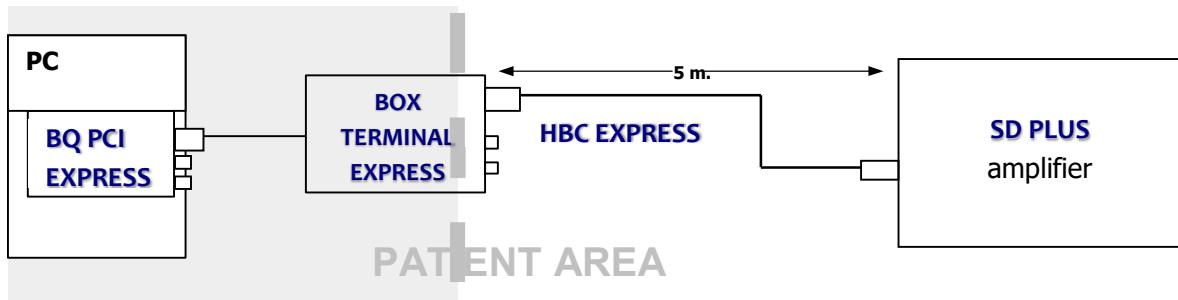

Figure 8 – Connection to a remote PC via BOX TERMINAL EXPRESS

**Long distance cable connection**

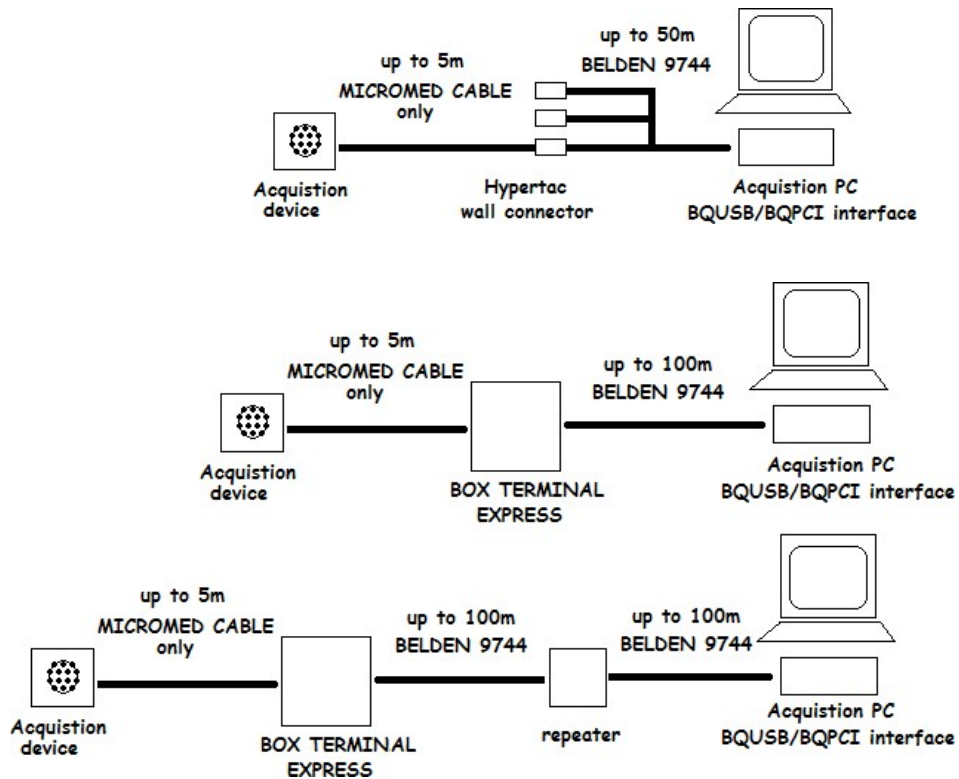

Figure 9 - Long distance connection diagrams

When the distance between acquisition PC and Acquisition amplifier is longer than 5 m special connection must be set up as shown in the figure above:

- Using a single **SD PLUS** amplifier the connection can be implemented with a BELDEN 9744 cable with length up to 50 m placed in a dedicated conduit, ended with a single or multiple connector, and with an **HBC EXPRESS** 5 m cable to connect the amplifier;
- With respect to distances up to 100 m the connection must be implemented with a BELDEN 9744 cable with length up to 100 m, placed in a dedicated conduit, with a **BOX TERMINAL EXPRESS**, and with a 5 m **HBC EXPRESS** cable for amplifier connection.
- With respect to distances up to 200 m the connection must be implemented with a 100 m long BELDEN 9744 cable, a repeater, another 100 m long BELDEN 9744 cable, with a **BOX TERMINAL EXPRESS** and with a 5 m **HBC EXPRESS** cable for amplifier connection.

These connections should be established by the Micromed Technical Assistance or by its authorized distributors.

## DEVICE CONNECTORS

All connectors are described viewed from the outside.

### Oximeter port (OXY)

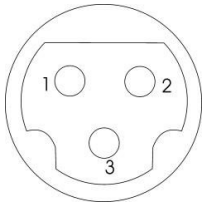

Oximeter connector		
Pin 1	DATA	Oximeter data
Pin 2	VCC	Oximeter supply
Pin 3	GND	Ground

### Data transfer connector

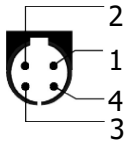

Interface connector		
Pin 1	RX	Data transfer line
Pin 2	TX	Data transfer line
Pin 3	GND	Negative reference / link cable shield
Pin 4	Vcc	Power supply (+5V)

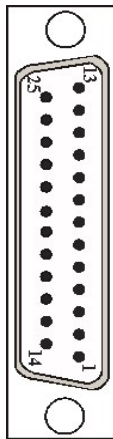
**Pre-wired electrode cap connector**

25 pin D-Sub connector		
pin	electrode	channel
1	G1	-
2	G2	-
3	OZ	20
4	O2	21
5	T6	18
6	PZ	16
7	T5	14
8	C4	12
9	C3	10
10	F8	8
11	FZ	6
12	F7	4
13	FP1	1
14	G1	-
15	G2	-
16	FPZ	2
17	O1	19
18	P4	17
19	P3	15
20	T4	13
21	CZ	11
22	T3	9
23	F4	7
24	F3	5
25	FP2	3

### Trigger RCA connector

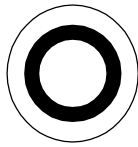

Trigger connector		
RCA central	Trigger +	Trigger signal
RCA housing	Trigger -	Trigger signal

### Inductive belts connectors

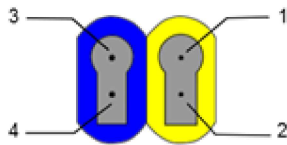

THOR/ABDO Inductive belts connector	
Pin 1	Abdominal inductive belts connection pins
Pin 2	
Pin 3	Thoracic inductive belts connection pins
Pin 4	



## FIRMWARE MAINTENANCE AND UPDATING

The microcontroller and the programmable logic chip inside the amplifier can be reprogrammed directly by the user via SystemPlus EVOLUTION.

In the setup screen of the device (see *SETUP PHASE* on page 17) there is a button that allows the reprogramming of the SD Plus firmware, through the connection cable with the interface. The file used for the updating (SDPlus.dat) is included in the software installation.

A progress bar shows the status of the copy of the firmware in the device, after which it starts the actual update. On the display appear a counter that shows the number of blocks of data missing to finish the update. Completed the update, the display shows a message on the outcome of the operation: if successfully completed, it will lead to the automatic restart of the device with the new program, if failed, the device must be reprogrammed.

### Enabled features

The firmware of each of the four SD Plus models available is associated with a hardware key (visible on the first screen of the device display, as shown in the *USER INTERFACE* section on page 13 ) that identifies the characteristics of the amplifier and the features enabled in it. Specifically, these keys consist of a six-character alphanumeric code:

- The first two digits represent the total number of channels physically on the device, except for the two EP channels (46 on the model Research, 36 on the Flexi model and on its two variants)
- The third digit indicates the presence (1) or absence (0) of the Bluetooth module (Bluetooth is not present in any of these models)
- The fourth symbol is a letter, and, together with the first two digits of the code, identifies the model of the device (46A = Research, 36A = Flexi , 36B = HighRate, 36D = Clinic)
- The fifth symbol is a letter, that indicates whether the device is marketed as a Micromed product (A), or if it is traded by a third party (C).
- The last symbol is a letter (E) which defines the presence of the two channels EP

Overall, therefore, the four keys associated with the four models are:

46OAAE	<b>SD Plus Research</b>
36OAAE	<b>SD Plus Flexi</b>
36OBAE	<b>SD Plus Flexi HighRate</b>
36ODAE	<b>SD Plus Flexi Clinic</b>

**Table 5: SD Plus hardware keys**

# FUNCTIONAL CONTROLS

## CHECK OF DEVICE STATUS

The characteristics of the **SD PLUS** amplifier can be controlled by performing specific tests, using laboratory instrumentation and the acquisition program. It is also available a suite, called **MICROMED DEVICE TEST**, containing a specific program called **SD PLUS TEST**, that automates the control procedure and the drawing up of the test report.

## GENERAL FUNCTIONAL CONTROLS

With respect to the controls described below, it is advisable to adopt connectors with 10 k $\Omega$  resistors, to be plug on the amplifier inputs. Moreover, it is necessary to use a function generator with some voltage divider to generate proper signals to be sent to the amplifier.

**It is necessary to have a function generator with external trigger and that allows the regulation of the signal cycles number.**

For all of the tests listed below, the external trigger of the signal generator must be connected to the red RCA socket, located on the connection interface between the PC and the amplifier, or on the hollow punch of the interface card. It should be set a number of cycles equal to five in the signal produced by the generator.

Voltage divider with 1:1000 ratio must be adopted.

Measures have to be realized using SystemPlus EVOLUTION software.

MICROMED can provide a kit of accessories that allow you to perform all the connections required in the following tests.

### CMRR test - EEG channels

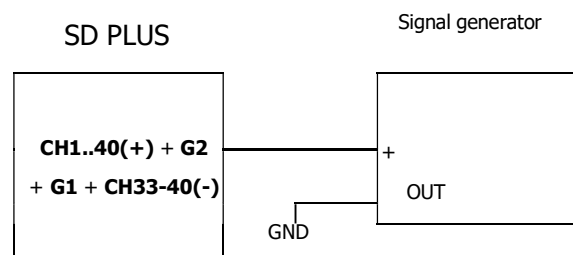

**Figure 10 - Connection diagram for CMRR test**

The CMRR test is performed putting a balanced sinusoidal signal (verify that the offset of the device is zero), frequency 50 Hz, amplitude 1.6 V, to all EEG channels, including the G2 (negative input of common reference channels) and G1 (internal voltage reference). Set the EEG acquisition program mode ALL CHANNELS and set the sampling frequency to 512 Hz.

Set up filters for maximum bandwidth HP: 0Hz-LP: 1000 Hz capture window: 50  $\mu$ V / cm

Disable the notch filter and run the acquisition.

From this information it is possible to calculate the CMRR in dB using the formula

$$CMRR = 20 \log \left( \frac{1,6}{V} \right)$$

where  $V$  is the peak-to-peak signal amplitude of each channel.

For EEG channels, this parameter must be greater than or equal to 100 dB.

The correspondence between some CMRR value and the measured amplitude are shown below.

$\mu\text{VPP}$	CMRR (@ $V_{IN}=1.6\text{V}$ )	$\mu\text{VPP}$	CMRR (@ $V_{IN}=1.6\text{V}$ )	$\mu\text{VPP}$	CMRR (@ $V_{IN}=1.6\text{V}$ )
<b>0.1</b>	144	<b>2</b>	118	<b>12</b>	102
<b>0.2</b>	138	<b>3</b>	114	<b>13</b>	101
<b>0.3</b>	134.5	<b>4</b>	112	<b>14</b>	101
<b>0.4</b>	132	<b>5</b>	110	<b>15</b>	100
<b>0.5</b>	130	<b>6</b>	108	<b>16</b>	100
<b>0.6</b>	128.5	<b>7</b>	107	<b>17</b>	99
<b>0.7</b>	127	<b>8</b>	106	<b>18</b>	98
<b>0.8</b>	126	<b>9</b>	104	<b>19</b>	98
<b>0.9</b>	125	<b>10</b>	104	<b>20</b>	98
<b>1</b>	124	<b>11</b>	103	<b>21</b>	97

**Table 6 – Correspondence between CMRR and measured voltage**

### **CMRR test – polygraphic channels**

The verification of the CMRR is performed by sending a balanced sinusoidal signal, frequency 50Hz and amplitude 1.6V, to all the 11 polygraphic channels. Set the EEG acquisition program mode C21P and set the frequency of the 11 polygraphic channels to 1024Hz.

Set up filters for maximum bandwidth.

Deduce signal amplitude by video.

From this information it's possible to calculate the CMRR in dB, using the formula and values in Table 6.

For polygraphic channels, this parameter must be greater than or equal to 110 dB.

### **Background noise test – EEG channels**

Short all the 21 EEG inputs and G2 to G1.

Set the sampling frequency to 256 Hz and predispose filters for the bandwidth 0.3-70 Hz. Run an acquisition and verify that the background noise is lower than 1.8  $\mu\text{VPP}$  (0.27  $\mu\text{V}_{r.m.s.}$ ).

### **Background noise test – polygraphic channels**

Short all the inputs (positive and negative) of the 11 polygraphic channels to G1.

Set the sampling frequency to 256 Hz and predispose filters for the bandwidth 0.3-70 Hz). Verify that the background noise is lower than 1.8  $\mu\text{VPP}$  (0.27  $\mu\text{V}_{r.m.s.}$ ).

### Correct amplification test- EEG channels

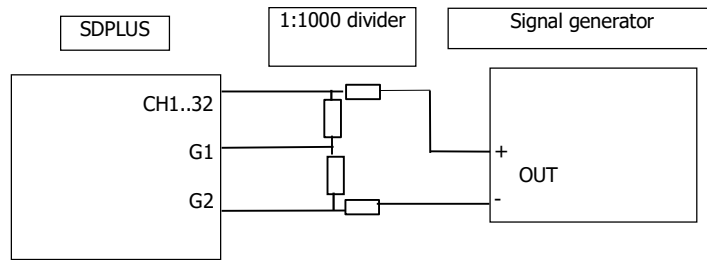

Figure 11 - Connection scheme for the amplification tests

Set the signal generator to supply a square wave  $5 V_{pp}$ , frequency 10 Hz. Use a balanced voltage divider to send the generated signal attenuated 1.000 times (a  $5000 \mu V_{pp}$  signal at 1 Hz must be obtained) to the polygraphic inputs of the amplifier. Connect the positive output of the divider to the positive inputs of the amplifiers (channels from 1 to 24), the negative output of the divider to G2 and the ground to G1.

In the BQ software, set a program that shows all the EEG channels with reference to G2. In this program, the filters must be set for the widest bandwidth: 1024 Hz. Set the "all channel" acquisition modality and the acquisition window to  $6400 \mu V$ . Verify the viewed amplitude is  $5000 \pm 500 \mu V$ .

### Correct amplification test - polygraphic channels

Set the signal generator to supply a the square wave  $5 V_{pp}$ , frequency 10 Hz. Use a balanced voltage divider to send the generated signal attenuated 1000 times (obtaining a signal of  $5000 \mu V_{pp}$  at 10 Hz) to the polygraphic inputs of the amplifier. Connect the positive output of the voltage divider to the positive inputs of the amplifier (channels 25 - 40), the negative output of voltage divider to the negative inputs of the amplifier and the ground to G1 socket. In the acquisition software, set a program that shows all the polygraphic channels. In this program, the filters must be set for the widest bandwidth. Set the sampling frequency to 128 Hz. Set the acquisition mode to "All channel" and the acquisition window to  $6400 \mu V$ . Verify that the displayed amplitude is  $5000 \pm 500 \mu V$ .

### Large bandwidth EP channels test

Set the function generator to supply a sinusoidal wave  $5 V_{pp}$ , frequency 10 Hz. Use a balanced voltage divider to send to EP1 and EP2 inputs the generated signal attenuated 1000 times. Verify that the displayed amplitude is  $5000 \pm 500 \mu V$ .

### Impedance check

Connect  $10 k\Omega$  resistors between the inputs of the 40 EEG/EP channels and ground (G1). Verify that the reading is correct via the impedance check program. Perform in the same way the control of EP1 and EP2 inputs.

### Automatic Test Software

Upon request, the Automatic test software for the **SD PLUS** family amplifier is available.

The program allows the user to perform test on background noise and correct amplification, the input impedance measure and the functional control of the internal switches for the change of filters and acquisition windows. Moreover, in order to speed up tests, appropriate connectors to be connected to the inputs of the amplifiers could be supplied. The program requires the use of a function generator.

# TECHNICAL SPECIFICATIONS

Manufacturer:	Micromed S.p.A. via Giotto 2 - 31021 - Mogliano Veneto (TV) – Italia tel. 041-5937000 fax. 041-5937011 E-Mail <a href="mailto:micromed@micromed.eu">micromed@micromed.eu</a>
Devices:	<b>SD PLUS</b> series amplifier (Models: <b>SD PLUS RESEARCH</b> , <b>SD PLUS FLEXI</b> , <b>SD PLUS FLEXI HIGH RATE</b> , <b>SD PLUS FLEXI CLINIC</b> )
Classification:	class II, type BF, according to EN 60601-1. To guarantee the requisites of this type of classification, the device must be used with a PC connected to the mains via an isolation or separation transformer compliant with IEC60742 or IEC60989 and EN 60601-1 or with battery powered laptop computers. This device is intended for continuous operation. Ordinary protection from liquid penetration. The device is not suitable for use in presence of flammable anesthetic mixtures with air, oxygen or nitrous oxide.

## Channels characteristics

**Channel number:** 48

N.	Channel	Maximum full scale voltage (mV)	f <sub>c</sub> low. (Hz)	f <sub>c</sub> upp. (Hz)
1-40	EEG	±3.2, ±25.6, ±204.8, ±1638.4	DC, 0.15	0.27*f <sub>samp</sub>
41-42	EMG/EP	±0.8, ±3.2, ±51.2	0.11, 0.15, 2.2, 8.9	0.31*f <sub>samp</sub>
N.	Channel	Description		
43-44	PNG	Thorax/Abdominal Belt		
45-47	OXY	XPOD Nonin		
48	MKR	±50µV 1Hz		

<b>EEG amplifiers:</b>	All channels are differential amplification lines; those from 1 to 24 have the inverting input in common (called G2), while the other 16 have the possibility to select the inverting input connected to the G2 or their corresponding inverting plug (black)
<b>Noise:</b>	0.27 µV r.m.s.
<b>Input impedance:</b>	1 GΩ at Amplifier
<b>CMRR:</b>	≥100 dB for EEG channels and ≥110 dB for polygraphic channels
<b>Sampling frequency</b>	sampling frequency up to 16KHz per channel on the first 40 channels, 128KHz on 41-42 channels. Channels 43-48 are auxiliary channels for specific uses.

<b>A/D Conversion</b>	24 bit, a converter for each channel
<b>Impedance check:</b>	Automatic

### **Electrical characteristics**

<b>Power supply:</b>	5 VDC, from the Micromed <b>BQPCI EXPRESS</b> o <b>BQUSB EXPRESS</b> interfaces.
<b>Internal voltage:</b>	±2.5 V
<b>Power consumption:</b>	600 mW
<b>Data transmission</b>	Digital (dedicated differential protocol RS485)
<b>Communication lines isolation:</b>	2500VDC, with optocouplers compliant with UL1577 standard on the communication lines
<b>Power supply isolation:</b>	3000VDC with DC/DC converter

### **Mechanical characteristics**

<b>Size and weight:</b>	19 x 13 x 2.5 cm (height); 390 g; plastic case
<b>Connections</b>	Touch Proof (DIN 42802) inputs; 25 pin D-Sub connector for pre-wired headphones 1 3 pin plastic connector PUTP3 for the oximeter 2 bipolar PUTP2 connectors for inductive belts 1 4 pin Hypertac male connector for data connection 1 RCA connector for IN/OUT triggers

### **Environmental conditions**

<b>Operative:</b>	temperature 10-40°C humidity 0-90% pressure 70-105kPa
<b>Storage and transport:</b>	temperature (-20)/60°C humidity 0-95% not condensing pressure 50-105kPa

## Electromagnetic environment

The SD PLUS acquisition amplifier is suitable for use in the specified electromagnetic environment. The purchaser or user of the SD PLUS should assure that it is used in an electromagnetic environment as described below:

Emission Test	compliance	Electromagnetic environment
Radiated and conducted RF emissions CISPR 11	class B	The <b>SD PLUS</b> device is suitable for use in all establishments other than domestic and/or those directly connected to the low voltage power supply network.
Radiated and conducted RF emissions CISPR 11	group I	This <b>SD PLUS</b> device uses RF energy only for its internal function. Therefore, the RF emission is very low and not likely to cause any interference in nearby electronic equipment
Harmonic emission IEC 61000-3-2	Not applicable	The <b>SD PLUS</b> device is suitable for use in all establishments other than domestic and/or those directly connected to the low voltage power supply network.
Voltage fluctuation /flicker emission IEC 61000-3-3	Not applicable	The <b>SD PLUS</b> device is suitable for use in all establishments other than domestic and/or those directly connected to the low voltage power supply network.

Immunity test	EN 60601-1-2 Test level	Compliance level	Electromagnetic environment requirements
electrostatic discharge (ESD) EN 61000-4-2	8 kV contact 2/4/8/15 kV air	Not applicable	Floors should be wood, concrete or ceramic tile. If floors are covered with synthetic material, the relative humidity should be at least 30%.
radiated RF EN 61000-4-3	3V/m 80 MHz to 2.7 GHz	EN 60601-1-2 Test level	Portable and mobile RF communications equipment should be used no closer to any part of the device, including cables. Minimum distance 30 cm.
conducted RF EN 61000-4-6	3 V 150 kHz -80 MHz		
electrical transient/burst EN 61000-4-4	fast 2 kV for power supply lines  1 kV for input/output lines > 3 m	Not applicable	Mains power quality should be that of a typical commercial or hospital environment.

surge EN 61000-4-5	0.5/1 kV differential mode  0.5/1/2 kV common mode	Not applicable	Mains power quality should be that of a typical commercial or hospital environment.
voltage dips, short interruptions and voltage variations on power supply input lines EN 61000-4-11	0% Un for 0.5 cycle 0 % Un for 1 cycle 70 % Un for 25 cycles 0 % Un for 5 s	Not applicable	Mains power quality should be that of a typical commercial or hospital environment. If continuous use is required also during mains voltage interruption it is advisable to power the acquisition system with an UPS (Uninterruptible Power Supply) or use battery supply.
Power frequency (50/60Hz)magnetic field EN61000-4-8	30A/m	EN 60601-1-2 Test level	Power frequency magnetic fields should be at levels characteristic of a typical location in a typical commercial or hospital environment

### Precautions against ESD



The contacts of connectors identified with the ESD warning symbol should not be touched with fingers or metal utensils without the appropriate precautionary procedures.

In particular:

- before touching the connectors, ground electrostatic charges by touching an extended metal object;
- Avoid the formation of electrostatic charges, maintaining a certain degree of moisture in the room (e.g. Air conditioning, humidification) and preventing their accumulation (conductive floors, use of non-synthetic clothing material).

The lack of these precautions could lead to electrostatic discharge which could damage electronic components connected to the inputs and hinder the acquisition or compromise the quality of acquired signals.

All the persons who may get in touch with the unit (including the patient and / or their guardians), should be made aware of these precautions, and should be introduced to the physics of the phenomenon and to the ways to prevent it.



# CONFORMITY DECLARATION

Micromed S.p.A., Via Giotto, 2, I-31021 Mogliano Veneto (TV)

Registered in Treviso n. TV03906850262, VAT number IT03906850262

declares that

the product **SD PLUS**

complies with the following Directives of the European Community (including all the applicable modifications):

Ref. n°	Title :	device classification	Conformity evaluation procedure
<b>93/42/EEC</b>	Council Directive 93/42/EEC of 14 June 1993 concerning medical devices Notes: integrated with changes introduced by Directives 98/79/EC, 2000/70/EC, 2001/104/EC, 2007/47/EC and by reg.1882/2003	Class IIb	Annex II <sup>4</sup>
<b>2011/65/UE</b>	Directive 2011/65/EU on the restriction of the use of certain hazardous substances in electrical and electronic equipment (recast)	--	--

And that all the harmonized standards listed in the following have been applied

Harmonized standard	Title :
<b>EN 60601-1:2006 + AC:2010</b>	Medical electrical equipment - Part 1: General requirements for safety
<b>EN 60601-1-2:200</b>	Medical electrical equipment – Part 1: General requirements for basic safety and essential performance. Collateral Standard: electromagnetic disturbances. - Requirements and tests
<b>EN 60601-1-6:2010</b>	Medical electrical equipment – Part1: General requirements for basic safety and essential performance - Collateral standard: Usability
<b>EN 60601-2-26:2015</b>	Medical electrical equipment - Part 2: Particular requirements for the safety of electroencephalographs
<b>EN 62366:2008</b>	Medical devices - Part 1: Application of usability engineering to medical devices
<b>EN 62304:2006-07</b>	Medical device software – Software life cycle processes
<b>EN ISO 14971:2012</b>	Medical devices - Application of risk management to medical devices

<sup>4</sup> The products are designed and manufactured within the Micromed Quality System, compliant with EN ISO 9001 and EN ISO 13485 standards (certificate n.9120.MIC3 and 9124.MIC4 issued by CSQ) and approved by IMQ Notified Body number 0051. Each change to the products will be performed within the Quality System and according to the previously written Requirements. All the corrective actions suggested from the experience and the use of the devices in the post-production phase will be undertaken. All the Quality Records referred to the products will be kept at least 5 years after the manufacture of the last product