

BIOBASE

**Laboratory Refrigerator
BPR-5V650
User Manual**

BIOBASE GROUP

Version 2021.06

Preface

Thank you for choosing and using the products of our company. For your safety , convenient use and reasonable maintenance of this product, please read the instructions carefully before use and keep them for reference. The user shall be responsible for any damage to the instrument caused by the user's failure to comply with the requirements of this manual, or for any injury caused by the user's failure to comply with the requirements of the "Safety Tips".

Please follow the Safety tips:

1. Use protective equipment (including clothes, gloves, goggles, etc.) correctly;
2. Keep good hygiene and strictly follow product instructions;
3. Everyone is responsible for his own safety.
4. Patients are not allowed to directly touch, use or affect the products or the stored items in the products;
5. The product has not been sterilized;
6. The product is only used for storage and shall not be used in combination with other materials, organizations or technologies during use;
7. The product shall not be used for measurement or analysis;
8. The product's life is not equal to the storage life;
9. Some models need to add consumables regularly, such as printing paper and test tubes;
10. This product is not an explosion-proof equipment;
11. This product is not a quick-freezing equipment, this is only used to maintain temperature.

Due to the rapid update of our products, if the functions described in this manual are different from those of the products you purchased, please refer to the physical functions.

Content

Chapter 1. Cautions

- ❖ Please follow the notes and regulations in this manual to avoid possible injury to the user and any other person.
- ❖ "Warning" and "Prohibition" are indicated as follows:



The contents with the "warning" mark are related to the product safety and the personal safety of users, and must be operated strictly according to the warning content.



Any content bearing the "Do Not" sign must be absolutely prohibited, otherwise it may cause damage to the refrigerator or endanger the personal safety of the user.

- ❖ Please read this manual carefully when using this machine for the first time.
- ❖ This product can only be operated by trained and authorized personnel.
- ❖ Equipment maintenance can only be completed by our or its authorized agent.
- ❖ If the operator encounters any situation not mentioned in this manual, please contact our or the agent authorized by our to ask for the correct handling method.
- ❖ Please use the accessories provided by our . If the user wants to use other accessories,our will not be responsible for the adverse consequences. However, users can apply to our to verify whether the accessories meet the requirements of our .
- ❖ The product must be inspected and maintained at specified intervals.
- ❖ The refrigerator is strictly prohibited to store living creatures or other items that are strictly temperature-dependent and not suitable for constant temperature storage.
- ❖ The refrigerator will naturally dissipate heat through the rear surface (condenser) or the cooling fan to achieve the purpose of refrigeration. In order to ensure the normal operation of the machine and ventilation and heat dissipation, the back and sides of the box shall be at least 30 cm away from the wall, and the air inlet and outlet shall not be obstructed by obstacles.
- ❖ The production date is shown in the bar code. The first and second digits of the bar code represent the year, the third and fourth digits represent the batch number, the fifth, sixth, seventh and eighth digits represent the number of products, the ninth and tenth digits represent the month of product production, and the other digits represent the product model.
- ❖ Service life: 10 years; See batch number for production date.
- ❖ The temperature in the cabinet will rise when power failure. If it cannot be repaired within a short period of time, please take out the storage items and transfer them to other places that meet the temperature requirements of the storage items for storage, so as to avoid damaging the storage items.
- ❖ Equipment may not have SMS alarm and remote alarm functions, must arrange staff on duty 24 hours a day and 24 hours a day uninterrupted patrol, otherwise it may happen equipment malfunction alarm cannot be found, which can lead to store items due to over temperature metamorphism.
- ❖ User can adjust the temperature of the product according to their own needs in the allowed national standard range
- ❖ If the thermostat have keyboard lock function, lock the keyboard after the adjustment to avoid errors caused by incorrect operation set temperature which might leading to store items metamorphism.

BIOBASE

- ❖ Do not try to enter the secondary Settings menu in using, otherwise it may affect the normal work of the product, and even cause the damage of the product.
- ❖ If the product service time longer than the product life, this product needs to increase the frequency of maintenance, inspection records, needs to contact professional and technical engineer from manufacturer to do regular check.
- ❖ User should comply with product specifications and product itself with hints of labeling and warning labels for the operation, or may be dangerous or cause performance degradation.
- ❖ Product does not exist, liquid chemicals, waste emissions.
- ❖ Products does not involve the stored goods storage life.
- ❖ Product does not involve extending and (or) use for a long time effect.
- ❖ This product is a disposable product, no need do sterile processing.
- ❖ Put on the gloves to avoid touching the sharp edges or corners and injured during repairing.
- ❖ Unplug the power plug,when stop using for a long time. In case the aging of the power cord leads to electric shock, leakage or fire.
- ❖ Check the Settings after a power outage or shut off the power to restart the device. Changes to Settings may damage saved items.
- ❖ If equipment operation is not normal, please unplug the power plug. If the operation continues under abnormal conditions, it may cause electric shock or fire.
- ❖ Before this equipment for any repair or maintenance, be sure to disconnect the equipment power supply, to prevent electric shock or injuries.
- ❖ Ensure no suction of drug or suspended solids inside and around the equipment when maintenance.
- ❖ Only qualified technicians could install the equipment. Installation by unqualified personnel may result in electric shock or fire.
- ❖ Make sure this equipment is firmly installed on solid ground. If the ground is not secure or improperly placed, equipment may tip over or cause injury if the ground is not smooth.
- ❖ Please use earthed power socket to prevent electric shock. If the socket is not grounded, the grounding wire must be installed by a qualified engineer.

❗ Equipment may not have SMS alarm and remote alarm functions, must arrange staff on duty 24 hours a day and 24 hours a day uninterrupted patrol, otherwise it may happen equipment malfunction alarm cannot be found, which can lead to store items due to over temperature metamorphism.

❗ User can adjust the temperature of the product according to their own needs in the allowed national standard range

❗ If the thermostat have keyboard lock function, lock the keyboard after the adjustment to avoid errors caused by incorrect operation set temperature which might leading to store items metamorphism.

❗ Do not try to enter the secondary Settings menu in using, otherwise it may affect the normal work of the product, and even cause the damage of the product.

- ❗ If the product service time longer than the product life, this product needs to increase the frequency of maintenance, inspection records, needs to contact professional and technical engineer from manufacturer to do regular check.
- ❗ User should comply with product specifications and product itself with hints of labeling and warning labels for the operation, or may be dangerous or cause performance degradation.
- ❗ Product does not exist, liquid chemicals, waste emissions.
- ❗ Products does not involve the stored goods storage life.
- ❗ Product does not involve extending and (or) use for a long time effect.
- ❗ This product is a disposable product, no need do sterile processing.
- ❗ Put on the gloves to avoid touching the sharp edges or corners and injured during repairing.
- ❗ Unplug the power plug,when stop using for a long time. In case the aging of the power cord leads to electric shock, leakage or fire.
- ❗ Check the Settings after a power outage or shut off the power to restart the device. Changes to Settings may damage saved items.
- ❗ If equipment operation is not normal, please unplug the power plug. If the operation continues under abnormal conditions, it may cause electric shock or fire.
- ❗ Before this equipment for any repair or maintenance, be sure to disconnect the equipment power supply, to prevent electric shock or injuries.
- ❗ Ensure no suction of drug or suspended solids inside and around the equipment when maintenance.
- ❗ Only qualified technicians could install the equipment. Installation by unqualified personnel may result in electric shock or fire.
- ❗ Make sure this equipment is firmly installed on solid ground. If the ground is not secure or improperly placed, equipment may tip over or cause injury if the ground is not smooth.
- ❗ Please use earthed power socket to prevent electric shock. If the socket is not grounded, the grounding wire must be installed by a qualified engineer.
- ⊘ Patients shall not use or control this product.
- ⊘ Patients do not touch or approach the product in any way.

BIOBASE

- ⊘ Do not directly contact, store any biological material with this product.
- ⊘ No inspection, measurement or analysis by this product.
- ⊘ No stirring, crushing processing by this product.
- ⊘ Please don't use this product with other materials, components, technologies and medical equipment, neither contact with the medical apparatus and instruments. Products don't have the function of the treatment or therapy.
- ⊘ Product doesn't have the function to improve the state or the activity of storage items.
- ⊘ This is not a fast freeze Product, only used to store organs, materials or goods which have temperature requirements with the requirements of stored items with packaging or containers.
- ⊘ This is not a product with disinfection and sterilization function or absolute sealing, no vacuum or negative pressure inside. No isolation function of radiation, toxic, radioactive, infectious items shall be stored.
- ⊘ No pulling, tight, processing, trample, extrusion, damage nor distortion the power cord, to avoid the leakage damage and even fire caused by the loosen power cord.
- ⊘ No any obstacles stuck in door seals to cause frost or ice which would lead to performance degradation.
- ⊘ Do not put power cord directly to the ground, to avoid leakage accidents.
- ⊘ Do not touch the compressor room or top of freezer to avoid any electric shock risk.
- ⊘ Do not storage too wet items or it may cause heavy ice or frost on evaporator to affect the performance of refrigeration
- ⊘ Do not storage too hot items or it may cause high temperature inside cabinet to damage other items inside.
- ⊘ It is strictly prohibit any one enter into this product, especially children. If the device is left unused in an unsupervised area for a long period of time, make sure that the device is not accessible to children and the box is not completely closed.
- ⊘ Do not use wet hand contact with any electrical parts such as power plug or switch, otherwise may cause electric shock.
- ⊘ Don't put the containers of liquid or heavy objects on the equipment.

BIOBASE

- ⊘ If the item drops, it can cause injury, and the outflow of liquid can reduce the degree of insulation and cause leakage or electric shock.
- ⊘ Do not be preserved in this box of each surface drilling, otherwise will seriously affect the performance of refrigeration preservation.
- ⊘ Do not use of the equipment in open air. When the product is wet by rain, it may cause electrical leakage or electric shock.
- ⊘ This equipment must not be placed in wet places or vulnerable to splash water. Otherwise, it will cause leakage or electric shock accidents due to reduced insulation degree.
- ⊘ Do not be store
inflammable, explosive or volatile hazardous goods, also cannot be used near
flammable
spray, otherwise may cause fire or explosion.
- ⊘ Do not be store acid, alkali and so on easy to corrosion items. Otherwise, it may damage the internal components or electrical parts of the equipment.
- ⊘ Do not insert the metal objects such as nails or wire any orifice and clearance of the equipment or any outlet for internal air circulation, otherwise you will get an electric shock caused by the above objects come into contact with moving parts or injured.
- ⊘ Do not pull the liquid on the product shell or inside, otherwise may damage the electrical insulation and cause failure.
- ⊘ Do not be removed, repaired or modified equipment by unprofessional workers. If any of the above operations are carried out by unauthorized person, there is a risk of fire or injury due to improper operation.
- ⊘ Don't climb on the device or items on the equipment, otherwise it will caused by equipment overturned personnel injury or equipment damage.
- ⊘ Equipment scrap disposal should be performed by the appropriate person. Be sure to remove the door to prevent children from entering the box.
- ⊘ If the device and its associated packaging materials and parts are scrapped, please ask the relevant departments and person, the equipment and its associated packaging materials and product has no toxic and harmful substances, won't cause pollution to the environment.
- ⊘ Do not put plastic package accessible to children.

⊘ Please use product in safety area when store moderately, harmful or radioactive substances. Improper use may cause harm to human health or the environment.



:It is used to warn the user that there may be a danger of pinching hands in the gap of product door when opening and closing



:It is used to warn the users that electrical components and connecting wire terminals in the cabin may be in danger of electric shock



:Used to warn users that products should stay away from fire sources



:Used to warn users that the product fan may be in danger of hurting hands when taking items.



: To remind user to put sensor inside box to avoid inaccuracy display.



: To warning not put items over this line to affect inside temperature



: To warning not put items over this line to affect inside temperature

Chapter 2. Preparation and attention before use

- ❖ Transport: the refrigerator should be uplifted from the bottom and carried and put down lightly. The inclined plane should be no larger than 45 degrees.
- ❖ After installation, keep the device standing for 12 hours at least to return the compressor oil.
- ❖ After installation and first use testing, please adjust the castors to fix the device.
- ❖ Do not hold the door or the lining port as stressed member.
- ❖ Dismantle all package components (including protection foam in the refrigerator body).
- ❖ Please check accessories and data according to the packing list.
- ❖ Please clean the product before use.

Operating environment requirements:

- a. For indoor use only;
- b. The mounting surface must be fixed, horizontal and incombustible and be able to bear weight during the operation of the Refrigerator;
- c. To be placed away from direct glare of sunshine and heat and the environmental temperature should be not higher than 32°C. Humidity: lower than 80%.
- d. Space of above 30cm is required to be left around the Refrigerator for ventilation and heat dissipation;
- e. Not allowed to be placed in the environment under 0°C ;
- f. Not allowed to be placed at places with heavy moisture or easy-splashing water.
- g. On flat ground, the medical Refrigerator or can be directly pushed to move.
- h. Ambient non corrosive, flammable, explosive gas, liquid or dust.
- i. The surrounding environment must be kept well ventilated.

❗ Notes: please note that do not let the power line be damaged by trundles when pushing the refrigerator.

❗ Notes: be sure to take off the packaging pedestal on the bottom of the refrigerator.

❗ Notes: Do not put goods into the refrigerator which is just plugged in. Let the empty body run for a while (about 12 hours) and then put the goods to be refrigerated into the refrigerator.

Safety precautions:

- The power supply should be equipped with low-voltage air breaker and leakage protection device during usage.
- Please use the special power supply indicated on the nameplate of the equipment. If the voltage is lower than 198V or higher than 242V, it is necessary to install appropriate automatic voltage regulator to cooperate with the use. If the power cord needs to be extended, the cross-sectional area of the extension cord shall not be less than 2.5mm² and the length shall not be longer than 3m. The use of any voltage or frequency power supply other than those indicated on the nameplate may cause damage to electrical components or fire.
- The key should be kept properly to avoid accidents when children open the door after getting it.
- Do not connect the zero wire (N end) on the socket with the grounding wire (E end), otherwise it will cause the shell of the refrigerator to be charged and electric shock will occur.

- The power cord should not be tied, pressed under heavy objects, or close to heat sources such as compressors.
- Do not open and close the door too fast, which may lead to increased difficulty in opening the door and loose door closure.
- The open times of doors should not be frequent in use. The interval between door's open should be more than half an hour to avoid frost in the evaporator and the inner wall of the box.
- Please immediately disconnect the power supply in case of electrical faults such as leakage or short circuit during use.
- One power socket shall be used independently for each refrigerator, and the current of the power socket shall be no less than 10A, and the power socket shall be reliably grounded.

Attention in Use:

- Open the box for no more than 1 minute at a time, and wipe the ice water on the door seal before closing to ensure good sealing effect.
- When there are more items, please store them in batches, each batch shall not exceed one third of the box volume. After the first batch of items is put in, put the second batch after the displayed temperature is stable to ensure that the temperature in the box is stable.
- During the use of the refrigerator, if the items are opened for too long, the external hot air will enter the box and cause the high temperature alarm. This is a normal phenomenon. Please pay attention to minimize the time and times of opening and closing the door.
- In order to extend the service life of the refrigerator and reduce energy consumption, on the premise of ensuring the safety of the storage items, it is suggested to refer to the warm reminder for the temperature setting of the refrigerator.
- If the refrigerator does not cool after 2 to 3 hours of power on, please unplug the power and contact the customer service as soon as possible.
- The refrigerator is suitable for storing items, and should not be used as a quick freezing box. It cannot be forced to freeze a large number of hot items or large volume liquid items quickly, which will cause the compressor to not stop for a long time, and the temperature will not drop, and it is easy to burn the compressor.
- In case of alarm fault or other fault, please refer to the instruction manual and remove the fault according to the prompts on the display board. If the fault cannot be removed by yourself, please do not disassemble without authorization. Please contact after-sales maintenance personnel to help eliminate the fault in time.
- Clean the condenser dust every three months to ensure the normal operation of the equipment.
- Do not open the electric control box if you are not the maintenance personnel of our company.

Chapter 3. Instructions for use

3.1 First use

Use the installation

1. Remove the packing materials and bags.

Remove all transport packing materials and bags.

2. Check random attachments

Please check the contents in the box according to the packing list. If there is any discrepancy, please contact the after-sales service in time.

3. Placing conditions

A 30 cm gap should be left around the refrigerator to facilitate ventilation and heat dissipation.

4. Fixed refrigerator

The brake of the universal wheel of the product is locked. If the product has adjusting feet, turn the adjusting feet clockwise to support it on the ground. Make sure the save box is not moved when in use.

5. Fixed backup limit support

The backup support in the product attachment is fixed on the box body through the screw hole reserved in the backup refrigerator (as shown in the figure).

Ground warning:

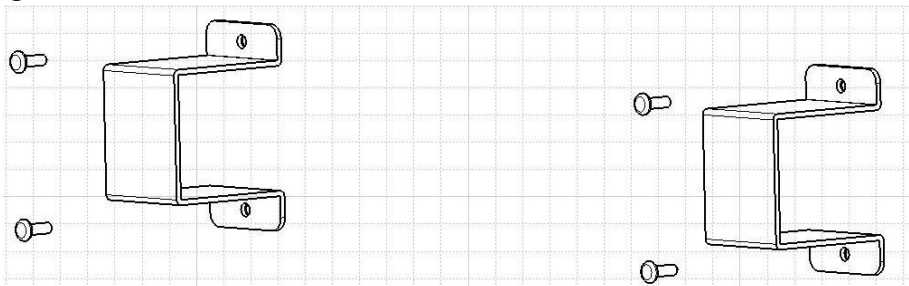

An electrical outlet with a grounding wire should be used. If the power socket is not grounded, the grounding wire must be installed by a qualified engineer.

Do not use gas pipe, water supply pipe, telephone line or lightning rod to ground the equipment, to prevent electric shock.

Adjusting:

Please Follow the steps when you use the equipment for the first time:

1) Connect the power cord to the dedicated socket as described above.

2) After power on, turn on the power switch (for BPR-5V650, press the power button for 5 seconds on the temperature control panel, and for BPR-5V650, turn on the power switch on the back of the box). At this time, the temperature controller displays the temperature in the box.

3) Press the mute button to stop the beep if you hear the alarm.

4) Set the required temperature of the refrigerator: no items should be put into the empty box. Observe the normal operation of the refrigerator for more than 24 hours.

5) After confirming the normal performance of the refrigerator, you can store the items in the refrigerator.

Do Nots:

- Do not use any mechanical tools or other means of defrosting that are not approved by the manufacturer.
- Do not damage the refrigeration circuit.
- Do not use electrical appliances inside the refrigerator.

Operation after power outage

The refrigerator has the function of memory for the set value. When the power is cut off and the power is called again, the equipment will continue to run according to the set parameters before the last power is cut off.

Note:

- ❖ The container has been cleaned when leaving the factory, but it is still recommended to wipe the container with warm water and a small amount of neutral detergent, and then wipe it with clean water and dry it (electrical parts cannot be cleaned and can only be wiped with a dry cloth).
- ❖ The parameters of the temperature controller of the refrigerator have been set when leaving the factory, and the power will be switched on. After 3 minutes, the compressor will start. After 30 minutes, the temperature in the refrigerator drops, indicating that the refrigeration system works normally and the test machine is over.
- ❖ For the first use, it is recommended to put the items to be stored in the box after the temperature in the box drops to the operating temperature. If you store too many items, it is recommended to store them in three batches. Wait for the temperature in the box after the previous storage to drop to the set temperature, and then store again. Excessive storage at one time may cause the refrigerator to fall below the set temperature for a long time, causing damage to the goods.
- ❖ In order to save electricity, the number and time of opening doors should be minimized.

3.2 Product structure

BPR-5V656

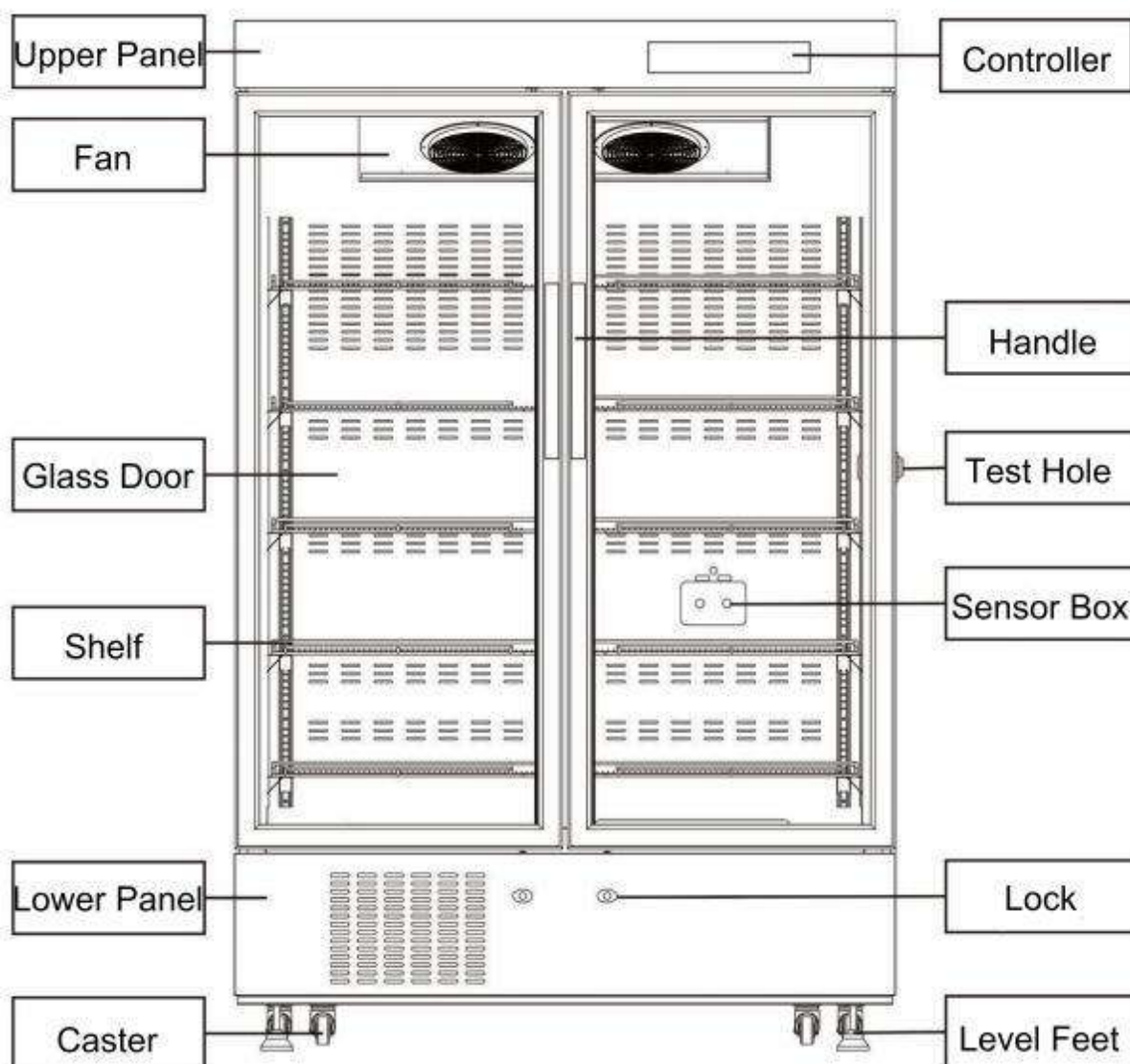

3.3 Temperature Adjusting

3.3.1 Button Function

Controller would display the inner cabinet temperature, the controller panel would display as below:

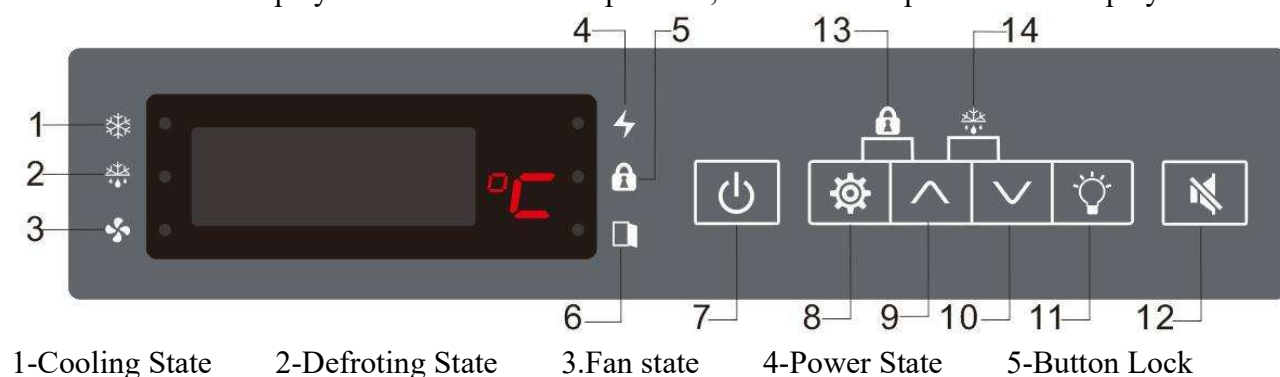





6-Door State 7-Power on/off 8.-Set 9-Set up 10-Set down 11-Light switch
 12-Mute 13-KeyBoard lock (Combined Button) 14-Defrost Key(Combined button)

Do not change the set temperature randomly during normal use. The product will not work when Press the power button for 10 seconds which will turn off the product's power supply. Press the power button for 10 seconds again and the product will continue to work normally. Press the keyboard lock key for 10s to lock the key. At this point, the keyboard lock indicator lights up and all keys become invalid. Press the keyboard lock for 10s again to unlock the key. You can press the mute button to cancel the alarm sound, but the alarm indicator light and the alarm code will be displayed until the alarm state is canceled. If there is any special need for adjustment, please call the after-sale service or be adjusted by professional maintenance personnel. If the set temperature is adjusted at randomly, it may cause the alarm of high temperature (AH) or low temperature (AL) of the product.

3.3.2 Paramether Settings





The refrigerator would display the current inner temperature after power on, please follow the steps to change set temperature, for example change the set temperature from 5°C to 6°C :

Serial No.	Keys Operation	Display
1		Current inner temperature
2	Press the key Set  for 3 seconds	Displays the initial set data is 5°C and twinkles.
3	Press the key Up-regulation 	Value increases
4	Press the key Down-regulation 	Value increases
5		Value is 6°C
6	Press the key Set  for 3 seconds	To preserve the setting and display inner current temperature

Note: Please do not change the setting by yourself, contact after sale service engineer and dealer if you do have needs to change it.

3.3.3 Setting for Temperature Checking

Press to check the highest and lowest temperature and the occurred times, press over 5 s to display current temperature. Checking steps as following:

NO.	Key operation	Display
1		Current inner temperature
2	Press 	Display highest temperature in records
3	Press again 	Display HT data HD20
4	Press again 	Display HT hour HH09
5	Press again 	Display HT minute HE30
6	Press again 	Display lowest temperature in records

7	Press again	Display LT data LD20
8	Press again	Display LT hour LH14
9	Press again	Display LT minute LE25
10	Press again	Display highest temperature in records

Note: Press for 5 seconds could delete the high and low temperature data in records, to check the high and low temperature at display with 00, time display code +00, such as HD00. Current temperature record interval is every 10 minutes, factory setting to clean the high/low temperature records at 17:35 every time.

3.3.4 Time Setting and Checking

Press to check time, follow the steps to check:

No.	Key operation	Display
1		Display cabinet temperature
2	Press	Year Y_17
3	Press again	Month N_03
4	Press again	Date D_15
5	Press again	Minute E_20
6	Press again	Second S_21

Note: Press over 5s could adjust the current time. Press for 5s, it would flash and display Y_17, you could press or to set current year, press then it would display N_03, then press or to change the current month, repeat above steps to finish all time setting, press to preserve time setting

3.3.5 Alarm Code

Alarm code	Describe	Alarm code	Describe
AH	Cabinet high temperature alarm	AS1S	Control probe 1 shorted
AL	Cabinet low temperature alarm	AS1B	Control probe 1 broken circuit
ADO	Door ajar alarm	AD1S	Defrosting _probe display broken circuit
AUF	Power failure alarm	AD1B	Defrosting _probe display broken circuit

- ❖ Back up battery would support the controller to work after power failure happens. The “AUF” and current temp would flash interval after stop for 1 minute, and repeat. Even the controller could display inner temperature when power failure happens, please take measures to avoid lost.
- ❖ Advice: Please power off when the temperature sensor is suspected to be broken, check the contact is loosen or not first, then contact after sale service engineer to deal with it.

- ❖ **!**Reminder: Please wait for 1 minute to operate when controller shows parameter code, till the current temperature shows again , to avoid malfunction caused by control parameter changes.
- ❖ In case of power failure or other faults, the refrigerator would stop work, and the temperature will rise. If the power couldn't be back in a short time, please take out the stored items and transfer to other refrigerator for storage, so as to avoid damage and loss of the stored items.
- ❖ Before placing the articles in the refrigerator, it should be confirmed in advance whether they are suitable for the temperature conditions you set for storage, so as to avoid damage and loss caused by the unsuitable temperature of the equipment.
- ❖ Due to refrigeration inertia, the refrigerator can not keep a constant temperature, the temperature in the box and the set temperature has a certain up and down deviation, with the use of the environment and the set temperature is different, this is a normal phenomenon.

Chapter 4. Daily Maintenance

In daily maintenance, in order to prevent electric shock or personnel injuries, be sure to cut off the power before repairing or maintaining the equipment and do not inhale drugs or particulate matters surrounding the equipment when maintaining the equipment. It is necessary to dry wet gloves to protect your hands. Otherwise, your hands may be cut by edges or corners of the refrigerator body.

4.1 Clean of Refrigerator

- Please clean the refrigerator once a month. Regular cleaning could maintain new outlook of refrigerator .
- Use dry cloth to wipe off the dust on the housing, or the inner chamber and all accessories of the Refrigerator. If the Refrigerator is very dirty, it is advised to use neutral detergent for cleaning;
- After cleaning, use cloth which has been soaked in clean water to wipe off the detergent;
- Do not pour water on the housing or in the preserve room of the Refrigerator. Otherwise, the electrical insulation may be damaged.
- During the rainy season, defrost may be easily condensed on the surface of the glass door of the refrigerator. In serious condition, water may drip. Please use dry cloth to wipe it dry in due time. Normal use will not be affected.

4.2 Defrost

The Refrigerator belongs to air cooling frost-less refrigerator which needs no defrosting. In summer with high environment humidity, condensation may appear on the frame of the Refrigerator. This is normal. It is advised to wipe it dry with dry cloth.

4.3 Care and Maintenance

- No heavy things are allowed to be placed on the door or the header of the Refrigerator to avoid deformation of the door body or the header caused by the press.
- The Refrigerator should be cleaned and maintained every once in a while.
- Use warm wet soft cloth to wipe the inner and outer surfaces of the Refrigerator.
- When serious dirt appears, use neutral detergent for washing tableware to wipe and then use cleaned soft cloth to wipe out the water spots.
- Keep the refrigerator running continuously when you power it on.

Chapter 5. Troubleshooting

Some abnormal conditions of the Refrigerator are caused by misuse. Please check with the following table before asking for maintenance.

Problems	Reasons and solving measures
Laboratory refrigerator does not work	If the power socket has electricity? If the power socket is plugged or loosened? If the power fuse is disconnected? If the supply voltage is too low or too high?
Compressor breaks down	If the temperature setting is right?
Temperature goes on decreasing after reaching to the set data	If the temperature setting is right?
Temperature can't reach the set data	If the fan stops running? If the door is not closed tight or opened too frequently? If too many goods are put in at one time and if the air channel is blocked? If the environmental temperature is too high?
Too much noise	If the refrigerator body is stayed on the flat ground? If the refrigerator body touches the wall? If the refrigerator immediately enters operating status after being started?

If you cannot confirm the fault reason or debug, please contact the after sale service center and tell them your name, address, phone number, refrigerator model, purchase time, fault phenomenon, etc. Professional engineer will offer warmhearted service to you.

Chapter 6. Main Performance Data

6.1 Product Structure and made up

It is made up with cabinet, door, cooling system, control system and spare parts.

6.2 Main Technical Data

Model	Climate type	Inner temp(°C)	Capacity (L)	Voltage (V~)	Frequency (Hz)	Exterior size(W*D*H)mm
BPR-5V650	SN/N	2~8	656	220	50	1220*642*1885

6.3 Electrical schematic diagram

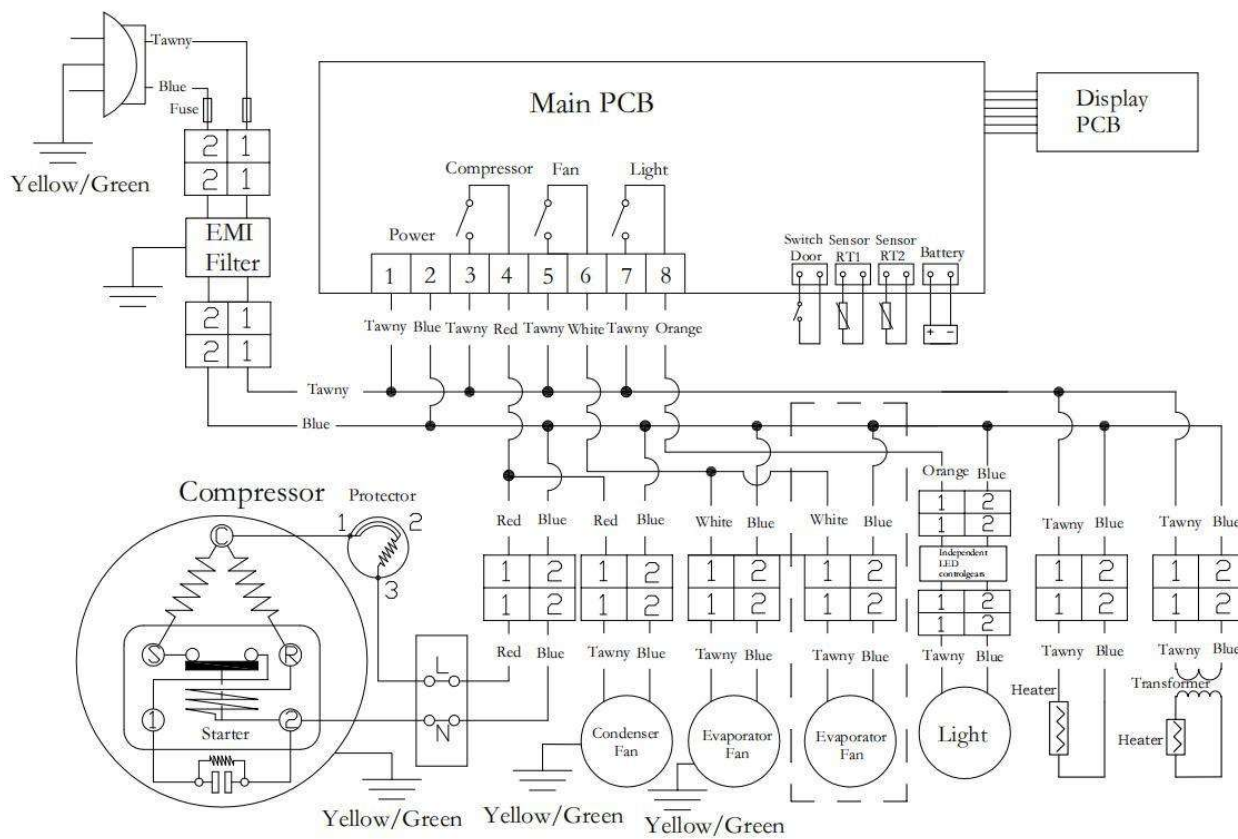

Chapter 7. Packing List

Model	User manual	Keys	Shelves	Shelf support	Limitation
BPR-5V650	1	2	10	40	2

BIOBASE BIODUSTRY (Shandong) Co., Ltd.

ADDRESS: Biobase Biodustry Park, Crossing of East Jingshi Road and Mingbu Road, Mingshui Economic Development Zone, Zhangqiu, Jinan, Shandong, China

Tel: +86-531-81307661

Inquiry: export@biobase.com

Complaints: customer_support@biobase.cc

After-sales service: service_sd@biobase.cc; service_ivd@biobase.cc

Web: www.biobase.cc/www.meihuatrade.com/www.biobase.com

