

Premium Solution with Super-High Speed AC1750 for Elite Performance

WAP1750

3 x 3 AC Dual-Band Wall-Mount PoE Access Point



The WAP1750 is a premium wireless solution designed for SMBs which demand elite network performance. The product features the latest 3 x 3 IEEE 802.11ac

technology for concurrent dual-band wireless speeds up to 1750Mbps. A wall-mounted design and industrial-grade build quality combined with user-friendly operation and an extensive feature set, make an ideal high-performance dual-band solution for demanding day-to-day enterprise operations.

For businesses that demand security, flexibility and speed – the Edimax Pro series has a wide range of potential applications from office environments to schools, campuses, hotels and hospitals. Multiple SSIDs can be configured for different departments or user groups and a built-in RADIUS server provides additional verification with a scalable AP array architecture for central management of multiple access points. High-density capacity for up to 100 simultaneous clients ideal for BYOD workplaces or other environments with a high volume of clients and wireless devices, and fast roaming allows for seamless transitions between multiple access points. Power over Ethernet support (PoE) and an intuitive web-based management interface provide deployment flexibility and extensive management options for company MIS departments and network administrators. An optional security cover also prevents physical theft or tampering, along with a rogue AP detection function to safeguard your network from unauthorized access.

When performance and security are critical for your business, you need products that are engineered for your industry. The Edimax Pro series is designed to help your business and provide the connectivity that you rely on every day, with safety and effectiveness guaranteed, and the WAP1750 offers the highest level of wireless performance on the market today.

KEY FEATURES

- 802.11AC Dual-Band High Speed:** IEEE 802.11ac concurrent dual-band with 1750Mbps wireless speed.
- High Performance Wi-Fi:** Band steering balances channel utilization, enabling high capacity environment.
- Easy Installation:** Wall-mount design with easy installation kit.
- Designed for High Density Usage:** Supports up to a hundred users simultaneously, ideal for crowded environments and BYOD (Bring Your Own Device) workplaces.
- Multiple SSIDs for Security Management:** Supports up to 32 SSIDs (16 x 2.4GHz & 16 x 5GHz) ideal for multiple departments, user groups, customers or guests.
- 802.11r/k Fast Roaming:** Roams smoothly between APs without lag or interruption, ensuring top performance for video and voice streaming applications.
- Wide Coverage & High Sensitivity:** Adjustable RF output power and high receiver sensitivity for wide coverage across large spaces.
- Seamless Mobility:** 1.5x greater coverage than typical APs for blanket coverage to ensure seamless connectivity for Wi-Fi devices across enterprise environments.
- Power over Ethernet:** Supports IEEE 802.3at PoE and IEEE 802.3af PSE out as well as included power adapter.
- Built-In RADIUS Server:** With management for up to 256 user accounts.
- Business Environments:** Advanced choice for high-performance applications. Suitable for a wide range of commercial applications such as offices, hotels, meeting rooms, schools, campuses, resorts, retail and others.
- Central Management:** Edimax Pro Network Management Suite (NMS) and SKYMANAGE PC for easy and Intuitive web-based central management. AP built-in with NMS supports AP array architecture.
- Optional Security Cover:** Prevents theft and tampering.

Wide Coverage & Multiple SSIDs

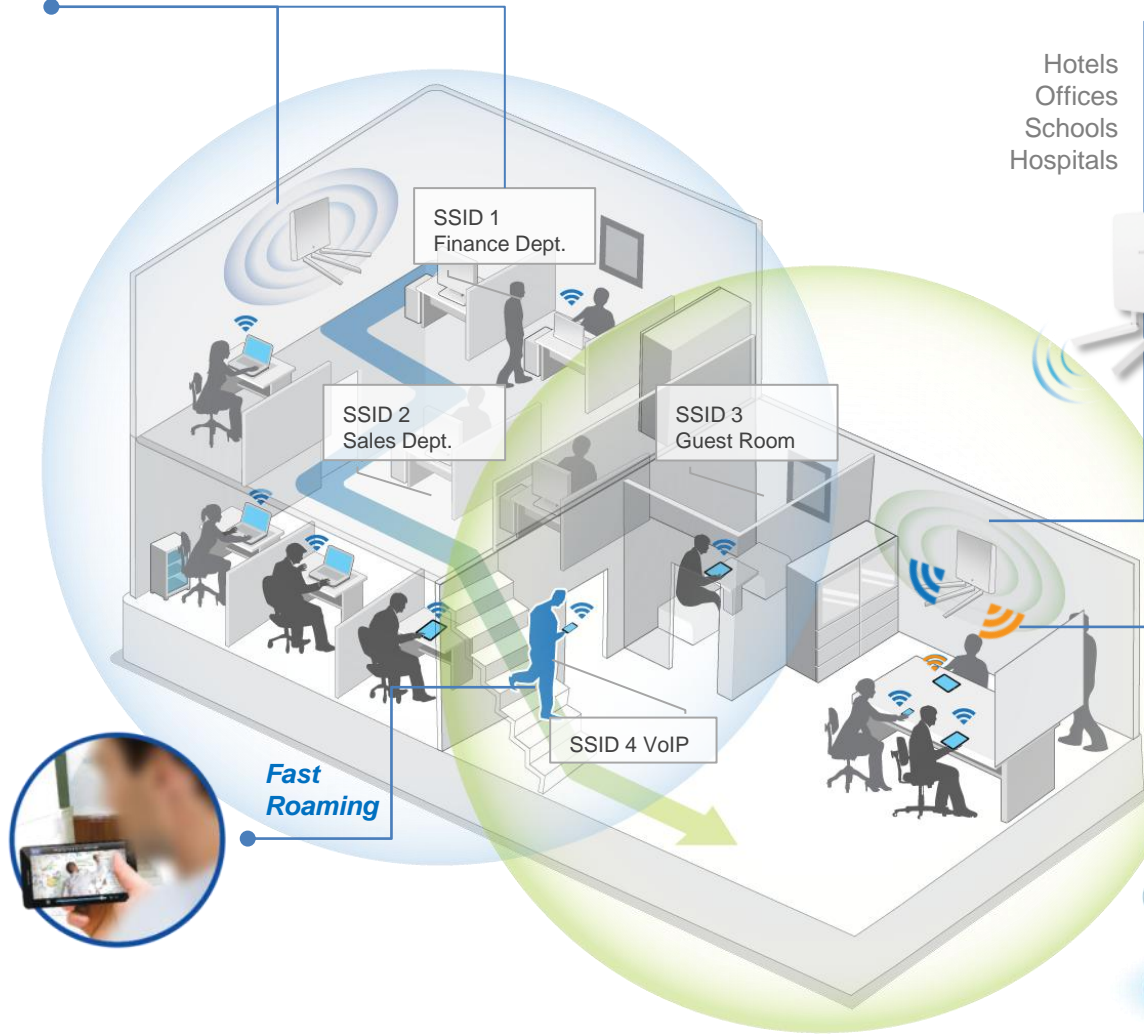

BYOD Solution & High Density Networking

Hotels
Offices
Schools
Hospitals

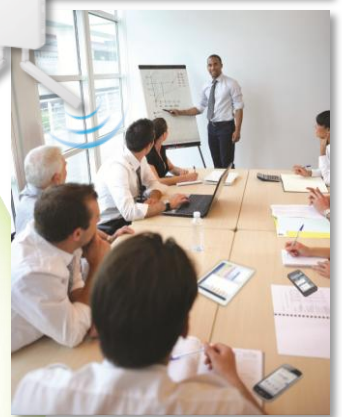

Concurrent Dual-Band

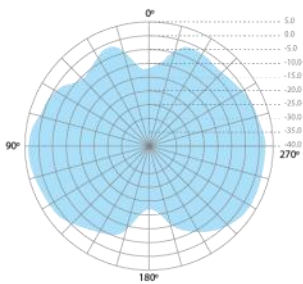

2.4GHz
2D Radiation Pattern @ Vertical

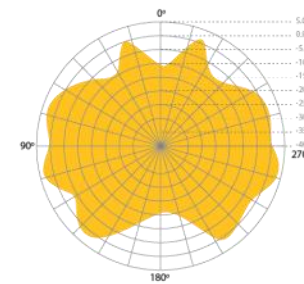

5GHz
2D Radiation Pattern @ Vertical

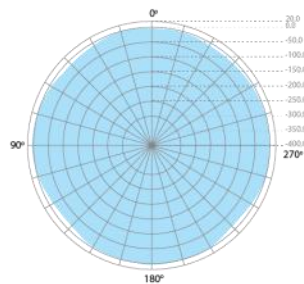

2.4GHz
2D Radiation Pattern @ Horizontal

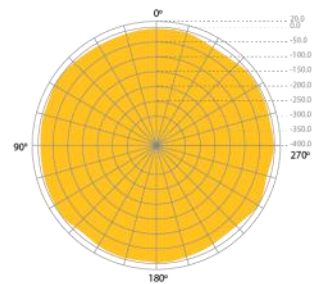

5GHz
2D Radiation Pattern @ Horizontal

Central Network Management: NMS & SKYPMANAGE PC

Work with Edimax Pro NMS (Network Management Suite) * and SKYMANAGE PC* web-based wireless network management software. Company MIS administrators can plan and manage Edimax Pro access points' powerful functionality according to their office space using an easy, remote web-based interface which includes a dashboard, map view, traffic statistics and wireless client list for network-wide remote administration. RADIUS settings, WLAN group settings, access control, guest network settings and firmware upgrades can all be managed centrally from a single location to reduce network downtime, aid troubleshooting and optimize network performance. Graphical zone plans with Google Maps integration and setup wizards are also available for expanding and managing large networks with multiple access points, with custom floor plans, visual overviews and easy drag-and-drop icons for quick access to key performance and monitoring information.

*NMS is built-in with Edimax Pro CAP, WAP series & OAP1750 access point. For SKYMANAGE PC, please contact Edimax authorized distributors or SIs to download the software.

3 x 3 AC Dual-Band Wall-Mount PoE Access Point

SPECIFICATIONS

Hardware	
LAN Interface	Giga x 2
PoE	802.3at (in) / 802.3af (out)
Antenna	Type: 3 x External / Gain: 2dBi (2.4GHz), 2dBi (5GHz)
Power	DC: 12V / 4A 802.3at (PoE Injector Optional)
Dimensions (L x W x H)	18.3 x 18.3 x 3.6 cm
Weight	560g
Power Consumption (Full Loading)	15W (Exclude PoE-Out)
Mounting	Wall / Desktop
Console	RJ45
WPS/Reset	Y
LED Indicator	1. Power LED 2. Diag LED
Environmental Conditions	Use PoE Switch: Operating Temperature: 0°C (32°F) to 50°C (122°F) Storage Temperature: -20°C (-4°F) to 60°C (140°F) Use Power Adapter: Operating Temperature: 0°C (32°F) to 40°C (104°F) Storage Temperature: -20°C (-4°F) to 60°C (140°F) Operating Humidity: 90% or Less Storage Humidity: 90% or Less
Power Saving	802.3az
Internal Buzzer	Y
Security Cover	Y (Optional)
Others	Kensington Security Slot & Wall Mount Holes
Wireless	
Standard	802.11 a/b/g/n/ac Concurrent Dual-Band
No. of Radios	2
Receiver Sensitivity	≤ -94.5dBm
Certification	CE/FCC
802.11 r/k	Y
Fast Roaming	Y
Band Steering	Y
Number of SSIDs	16 (2.4GHz) + 16 (5GHz)
Performance	
Maximum Data Speed	450 + 1300Mbps
Concurrent Clients	Up to 50 Per Radio
Security	
Encryption	WEP / WPA / WPA2
Wireless L2 Isolation	Y
Station Isolation	Y
IEEE 802.1x Authenticator	Y
EAP Authentication	PEAP
Hidden SSID	Y
MAC Address Filter	Y
Wireless STA	Y
Rogue AP Detection (w/ NMS)	Y
Software	
Wireless Mode	AP / WDS AP / WDS Bridge
802.1q VLAN	Y (VID = 1-4095)
Spanning Tree	RSTP
QoS	WMM (802.11e) Max Associated Station No.
Pass-Through	IPv6 and VPN (PPTP, L2TP/IPsec)
DSCP (802.1p)	Y
Multicast Rate up to 54Mbps	Y

RF Specifications							
Frequency Band	<ul style="list-style-type: none"> Radio I : 802.11b/g/n 2.412~2.484(GHz) Radio II : 802.11a/n/ac 5.18~5.24(GHz), 5.745~5.825(GHz) (The supported frequency band is restricted by local regulations.)						
Operation Channels	<ul style="list-style-type: none"> 2.4GHz : US/Canada 1-11 / Europe 1-13 / Japan 1-14 5GHz : Country dependent for the following ranges: US/Canada: Band 1:36, 40, 44, 48; 5.180~5.240(GHz) Band 2: 52, 56, 60, 64;5.260~5.320(GHz) Band 3: 100, 104, 108, 112, 116, 120, 124, 128, 132, 136, 140;5.500~5.700(GHz) Band 4:149, 153, 157, 161, 165; 5.745~5.825(GHz) Europe: Band 1:36, 40, 44, 48; 5.180~5.240(GHz) Band 2: 52, 56, 60, 64;5.260~5.320(GHz) Band 3: 100, 104, 108, 112, 116, 120, 124, 128, 132, 136, 140; 5.500~5.700(GHz)						
Transmit Power (CE: 20dBm or lower, FCC:23dBm or lower)	<table border="0"> <tr> <td>802.11b 23dBm @1Mbps 23dBm @2Mbps 23dBm @5.5Mbps 23dBm @11Mbps</td> <td>802.11a 22dBm @6Mbps 22dBm @9Mbps 22dBm @12Mbps 22dBm @18Mbps 22dBm @24Mbps 21dBm @36Mbps 19dBm @48Mbps 18dBm @54Mbps</td> </tr> <tr> <td>802.11g 23dBm @6Mbps 23dBm @9Mbps 23dBm @12Mbps 23dBm @18Mbps 23dBm @24Mbps 22dBm @36Mbps 20dBm @48Mbps 19dBm @54Mbps</td> <td>802.11an(5G) 27.5dBm @MCS0/8/16 26.5dBm @MCS1/9/17 26.5dBm @MCS2/10/18 26.5dBm @MCS3/11/19 25.5dBm @MCS4/12/20 24.5dBm @MCS5/13/21 23.5dBm @MCS6/14/22 22.5dBm @MCS7/15/23</td> </tr> </table>	802.11b 23dBm @1Mbps 23dBm @2Mbps 23dBm @5.5Mbps 23dBm @11Mbps	802.11a 22dBm @6Mbps 22dBm @9Mbps 22dBm @12Mbps 22dBm @18Mbps 22dBm @24Mbps 21dBm @36Mbps 19dBm @48Mbps 18dBm @54Mbps	802.11g 23dBm @6Mbps 23dBm @9Mbps 23dBm @12Mbps 23dBm @18Mbps 23dBm @24Mbps 22dBm @36Mbps 20dBm @48Mbps 19dBm @54Mbps	802.11an(5G) 27.5dBm @MCS0/8/16 26.5dBm @MCS1/9/17 26.5dBm @MCS2/10/18 26.5dBm @MCS3/11/19 25.5dBm @MCS4/12/20 24.5dBm @MCS5/13/21 23.5dBm @MCS6/14/22 22.5dBm @MCS7/15/23		
802.11b 23dBm @1Mbps 23dBm @2Mbps 23dBm @5.5Mbps 23dBm @11Mbps	802.11a 22dBm @6Mbps 22dBm @9Mbps 22dBm @12Mbps 22dBm @18Mbps 22dBm @24Mbps 21dBm @36Mbps 19dBm @48Mbps 18dBm @54Mbps						
802.11g 23dBm @6Mbps 23dBm @9Mbps 23dBm @12Mbps 23dBm @18Mbps 23dBm @24Mbps 22dBm @36Mbps 20dBm @48Mbps 19dBm @54Mbps	802.11an(5G) 27.5dBm @MCS0/8/16 26.5dBm @MCS1/9/17 26.5dBm @MCS2/10/18 26.5dBm @MCS3/11/19 25.5dBm @MCS4/12/20 24.5dBm @MCS5/13/21 23.5dBm @MCS6/14/22 22.5dBm @MCS7/15/23						
Receiver Sensitivity	<table border="0"> <tr> <td>802.11b ≤-93dBm @1Mbps ≤-90dBm @11Mbps</td> <td>802.11a ≤-90dBm @6Mbps ≤-72dBm @54Mbps</td> </tr> <tr> <td>802.11g ≤-90dBm @6Mbps ≤-74dBm @54Mbps</td> <td>802.11an(5G) ≤-94.5dBm @MCS0 ≤-70.5dBm @MCS7 ≤-90dBm @MCS8 ≤-66dBm @MCS15 ≤-90dBm @MCS16 ≤-66dBm @MCS23</td> </tr> <tr> <td>802.11gn (2.4G) ≤-94.5dBm @MCS0 ≤-76.5dBm @MCS7 ≤-90dBm @MCS8 ≤-72dBm @MCS15 ≤-90dBm @MCS16 ≤-72dBm @MCS23</td> <td>802.11ac ≤-90.5dBm @MCS0 ≤-60.5dBm @MCS9</td> </tr> </table>	802.11b ≤-93dBm @1Mbps ≤-90dBm @11Mbps	802.11a ≤-90dBm @6Mbps ≤-72dBm @54Mbps	802.11g ≤-90dBm @6Mbps ≤-74dBm @54Mbps	802.11an(5G) ≤-94.5dBm @MCS0 ≤-70.5dBm @MCS7 ≤-90dBm @MCS8 ≤-66dBm @MCS15 ≤-90dBm @MCS16 ≤-66dBm @MCS23	802.11gn (2.4G) ≤-94.5dBm @MCS0 ≤-76.5dBm @MCS7 ≤-90dBm @MCS8 ≤-72dBm @MCS15 ≤-90dBm @MCS16 ≤-72dBm @MCS23	802.11ac ≤-90.5dBm @MCS0 ≤-60.5dBm @MCS9
802.11b ≤-93dBm @1Mbps ≤-90dBm @11Mbps	802.11a ≤-90dBm @6Mbps ≤-72dBm @54Mbps						
802.11g ≤-90dBm @6Mbps ≤-74dBm @54Mbps	802.11an(5G) ≤-94.5dBm @MCS0 ≤-70.5dBm @MCS7 ≤-90dBm @MCS8 ≤-66dBm @MCS15 ≤-90dBm @MCS16 ≤-66dBm @MCS23						
802.11gn (2.4G) ≤-94.5dBm @MCS0 ≤-76.5dBm @MCS7 ≤-90dBm @MCS8 ≤-72dBm @MCS15 ≤-90dBm @MCS16 ≤-72dBm @MCS23	802.11ac ≤-90.5dBm @MCS0 ≤-60.5dBm @MCS9						
Management							
Deployment	Standalone: AP mode Master AP mode: Can manage 16 Edimax Pro APs with NMS Managed AP mode: Be managed by AP Controller (APC500), Edimax Pro Master AP with NMS or SKYMANAGE PC Software						
Configuration	HTTP/HTTPS SNMP v1, v2c, v3 CLI (Telnet, SSH)						
RADIUS Server	Built-In						
Auto-Channel	Y						
Private MIB	Y						
Package Contents							
Access Point	AC1750 Wall Mount PoE Access Point						
Antenna	Detachable Antenna x 3						
Mounting Bracket	Wall Mount Bracket & Magnetic Template Kit						
Power Adapter	12V / 4A Power Adapter						
Cable	Ethernet Cable						
CD / Quick Installation Guide	CD (User Manual & Multi-Language Quick Installation Guide) / Printed English Quick Installation Guide						
Accessories							
Optional	GP-101IT IEEE802.3at PoE Injector						
Optional	SC1000 Security Cover						

3 x 3 AC Dual-Band Wall-Mount PoE Access Point

Easy Installation Kit

Wall mount with bracket and magnetic template.

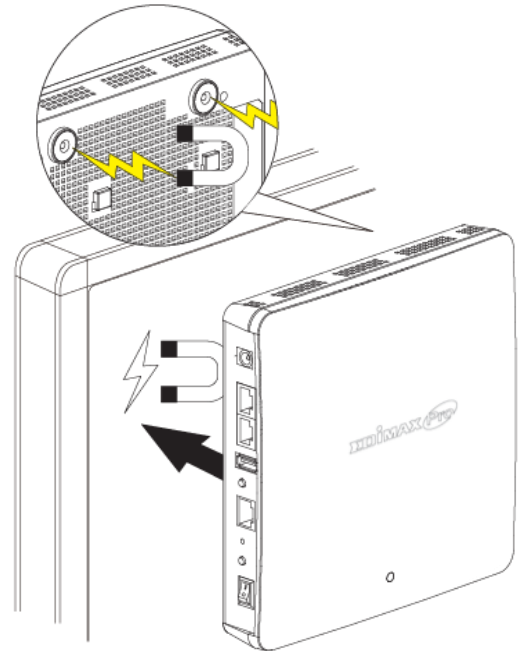
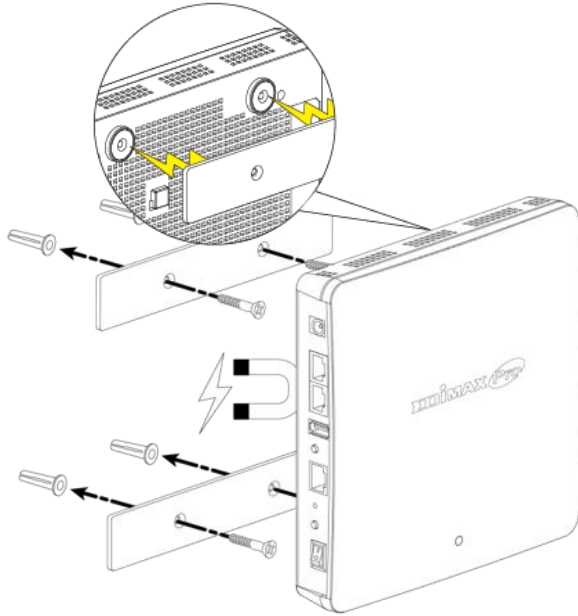

Optional Accessory: Security Cover (SC1000)

Security Cover for Edimax Pro WAP Series Access Point	
Dimensions (L x W x H)	252.25 x 199 x 28.59 mm
Weight (g)	445g
Environment Condition	Operating Temperature: 0°C (32°F) to 50°C (122°F) Operating Humidity: 90% or Less
Package Content	Security Cover / Mounting Bracket / Screws / Ejector Key / Key / QIG

Network security is a critical concern for any modern business and begins with the hardware itself. Edimax Pro access points can be tampered with a robust security cover and lock, preventing the access point from being tampered with or removed and restricting access to authorized persons only.

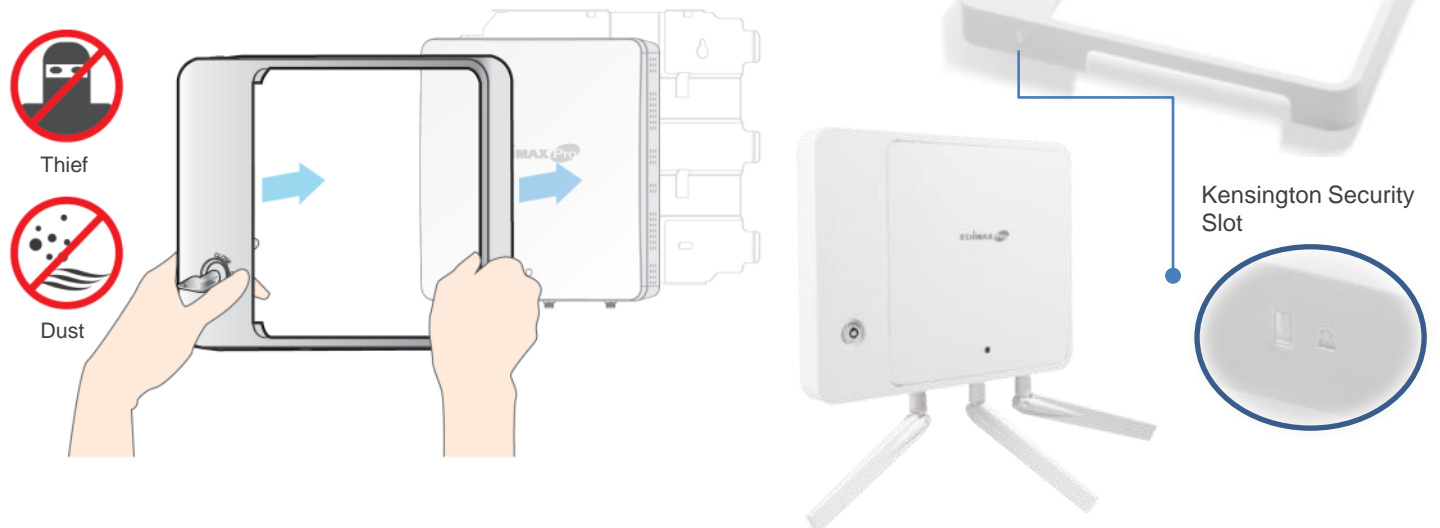

Maximum performance, actual data rates, and coverage will vary depending on network conditions and environmental factors. Product specifications and design are subject to change without notice. Copyright © 2017 Edimax Technology Co. Ltd. All rights reserved. www.edimax.com