

HyBase V8 Classic

Operating table

Versatility beyond Expectation



With increasingly complex surgical procedures, today's surgical environment requires a table that instantly adapts to all the versatility to provide the highest level of care.

- An extreme load capacity of up to 460 kg.
- All positions are permitted up to overall load of 250 kg.
- The longitudinal shift up to 350mm for free to access to C-arm.
- 600mm lowest table position for neurosurgery, while 1,050 mm highest table position for orthopedics.
- 12 electric movements, such as table top up/down, slope and tilt, adapting to various surgical needs.
- Bluetooth hand control for unobstructed control in operating rooms.
- Independent manual override system for dual safety.
- Triple-layer decomposition pad to redistribute the patient's weight.



Flexibility for multiple disciplines

Meeting the needs of different surgical positions

Modular Design

The modular design of the tabletop is tailored for various surgical discipline needs, which can also lower the cost for hospitals as they only need to buy the specific module, instead of a new table, for an additional surgical type.



Surgical Disciplines



Flexibility for multiple disciplines

Cater to increasing endoscopic surgeries

Higher Imaging Quality

With the development of minimally invasive surgery (MIS), requirement for better images during procedures arises. HyBase V8 Classic allows clear and high-quality images that are crucial for today's MIS, cardiothoracic, orthopedic, and neurosurgical procedures.

Huge Imaging Access



(Optional) Carbon fiber operating plate provides extreme imaging space.

The carbon fiber tabletop ensures good radiolucent imaging. With a wide imaging access and better radiolucency, HyBase V8 Classic is an optimal solution for cardiovascular surgery.

Bidirectional longitudinal shift



Head-end shift: 160 mm
Foot-end shift: 190 mm

Built-in body elevator



Built-in body elevator (120 mm) for kidney surgery.

Carbon fiber tabletop



Radiolucent carbon fiber tabletop provides better imaging.

Optimal Stability

With a load capacity of up to 460 kg, the table is designed to accommodate the highest safety and stability. All positions are permitted up to overall load of 250 kg.



Electric brake provides higher stability.

Better Exposure to Operating Field

With gas spring assisted, HyStirrup allows simultaneous adjustment for abduction and lithotomy while reducing pressure under the popliteal fossa.



Smart backlit keypad makes operating table status and function keys visible in the dark.



Lithotomy position with HyStirrup-3 leg support.



IPX5 protection against water jets from any direction.

Safety for various positions

Enhance patient safety

Manual Override System

Manual Override System allows table articulation movements and release the brake in the event of primary control or power/battery malfunction, through an independent hydraulic circuit. Manual operations of all basic electro-hydraulic functions can be actuated by using a foot pump combined with the knob next to it.



Multi-layer Decompression Pad

Mindray's HyBase V series operating table introduces a new decompression mattress. The multi-layer composite mattress technology fully considers the body shape of the human and can be applied to patients with BMI between 17-35. Especially for heavy patients, the buffer layer can greatly reduce the contact between the body and the support layer, improve the support performance and further balance the pressure.

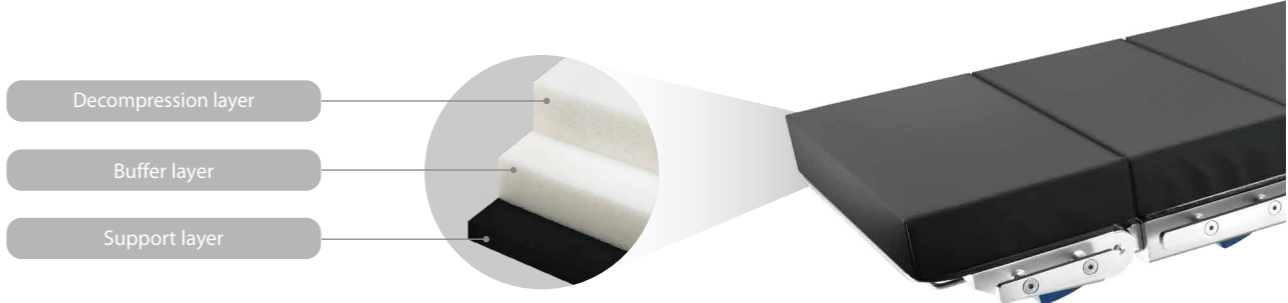

Compared with current mainstream products, our mattress has a more than 10% optimizing decompression effect, which can better disperse the pressure and reduce the risk of pressure ulcer.

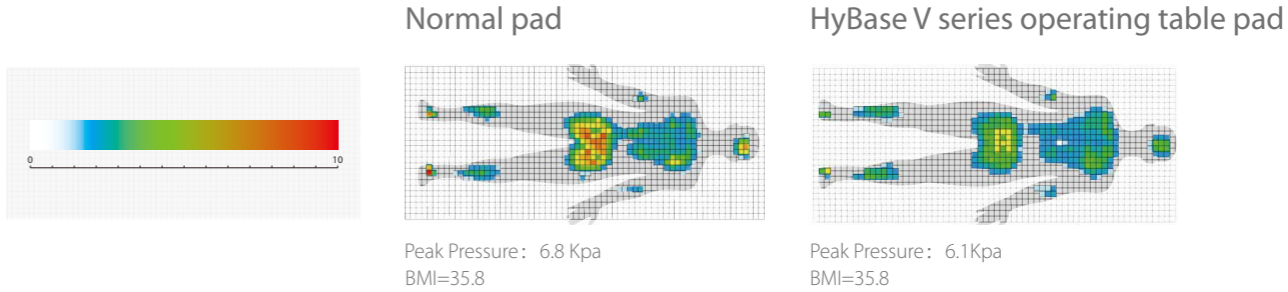

Color-coded Indication Technology

During the tilt or slope adjustment, a color-coded indicator appears on the screen to show the angle and issue a timely warning when it comes to excessive Trendelenburg and reverse Trendelenburg positions.



Step 1: Rotate the function icon to the position indicated by the arrow.



Step 2: Adjust the operating table by stepping on the foot pump.

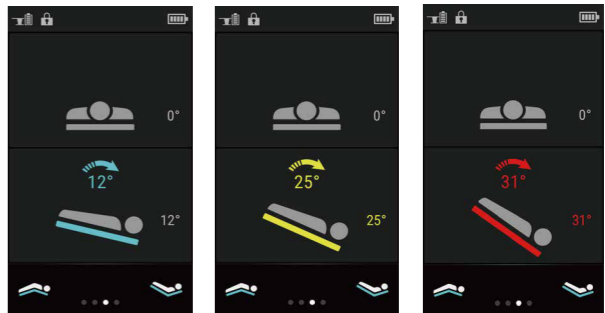

Efficiency in every step

Improve efficiency in the operating room

Intuitive icons with reasonable layouts



Corded/wireless hand control



Override panel (Backup control panel)

Easy to Adjust



Featherweight head plate to lighten your work.



Gas-spring assisted leg plates with foldable design.

Easy to Use

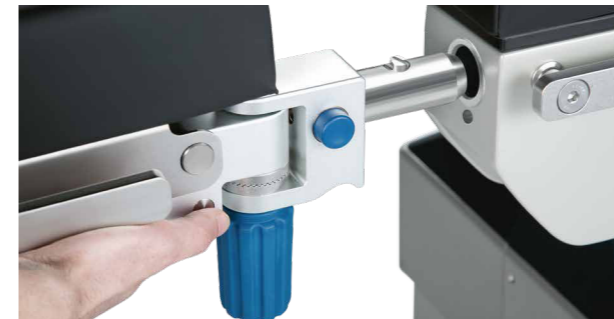

With the One-button design, it's convenient to remove or install the head and leg plates.



Four double-swivel castors make it easier to move the table toward any directions.

Easy to Clean



Bellows-free design.



Flat stainless-steel base cover.

HyBase V8 Classic

Operating table

Flexibility for multiple disciplines, the modular design of the tabletop is tailored for various surgical discipline needs.

Safety for various positions, meeting the requirements for increasing patients safety.

Efficiency in every step, four double-swivel castors make it easier to move the table in any direction.

- An extreme load capacity of up to 460kg.
- All positions are permitted up to overall load of 250kg.
- The longitudinal shift up to 350mm for free to access to C-arm.
- 600mm lowest table position for neurosurgery, while 1,050mm highest table position for orthopedics.
- 12 electric movements, such as table top up/down, slope and tilt, adapting to various surgical needs.
- Bluetooth hand control for unobstructed control in operating rooms.
- Independent manual override system for dual safety.
- Triple-layer decompression pad to redistribute the patient's weight.

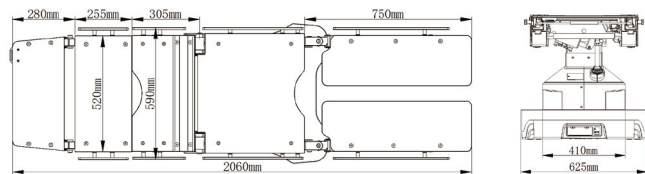

Dimensions

Length (Main unit)		Base cover	
Height without padding	600-1050mm	Base thickness	140mm
		Length	1100mm

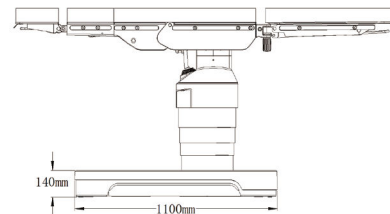
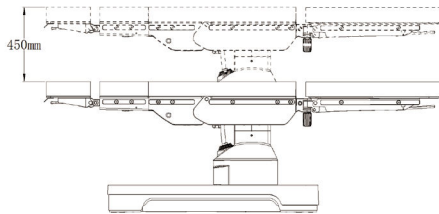

Head plate		Back plate	
Head plate up	Max. 45°	Back plate up	Max. 80°
Head plate down	Max. 90°	Back plate down	Max. 40°

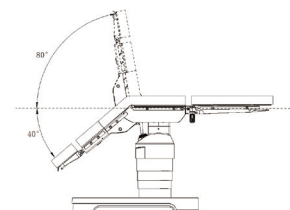
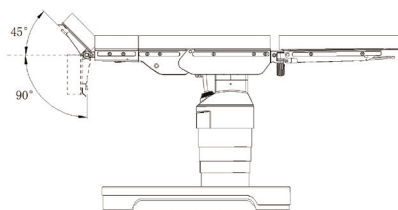

Trendelenburg Position		Lateral tilt	
Trendelenburg	Max. 36°	Left tilt	Max. 26°
Reverse Trendelenburg	Max. 36°	Right tilt	Max. 26°

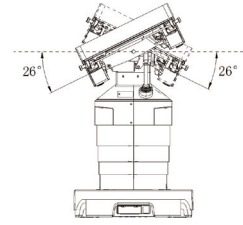
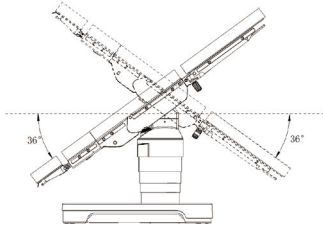

Leg plate		Manual body elevator(optional)	
Leg plate up	Max. 20°	Body elevator up	Max.120mm
Leg plate down	Max. 90°	Body elevator width	86mm

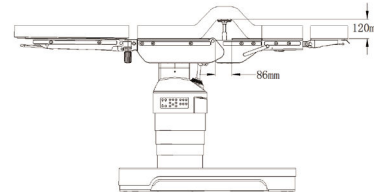
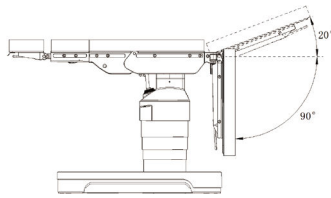

Longitudinal slide(optional)		Four double-swivel/universal castors	
Longitudinal shift toward head end	Max. 160mm	Diameter	75mm
Longitudinal shift toward foot end	Max. 190mm		
Maximum longitudinal shift	350mm		

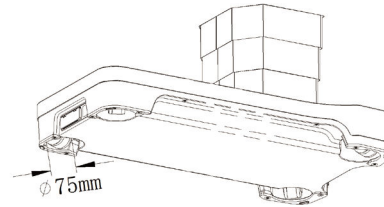
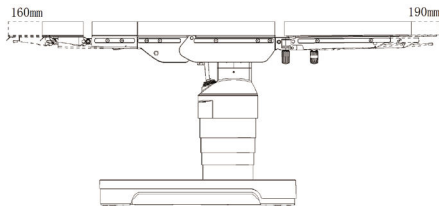

Flex Position		Reflex Position	
Flex Position	220°	Reflex Position	110°
Reverse Trendelenburg	20°	Trendelenburg	30°
Back plate down	40°	Back plate up	70°

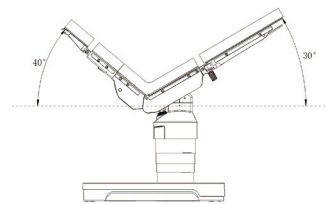
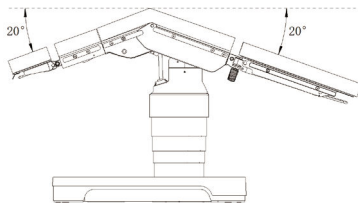

www.mindray.com

P/N:ENG-HyBase V8 Classic-210285X2P-20220430
 ©2022 Shenzhen Mindray Bio-Medical Electronics Co.,Ltd. All rights reserved.

mindray
 healthcare within reach

HyBase V8 Classic

Operating Table

Operator's Manual



© Copyright 2021-2022 Nanjing Mindray Bio-Medical Electronics Co., Ltd. All rights reserved.

Release time: 2022-12.

Revision:3.0

Intellectual Property Statement

NANJING MINDRAY BIO-MEDICAL ELECTRONICS CO., LTD. (hereinafter called Mindray) owns the intellectual property rights to this product and this manual. This manual may refer to information protected by copyrights or patents and does not convey any license under the patent rights of Mindray nor the rights of others.

Mindray intends to maintain the contents of this manual as confidential information. Disclosure of the information in this manual in any manner whatsoever without the written permission of Mindray is strictly forbidden.

Release, amendment, reproduction, distribution, rental, adaptation, translation of this manual in any manner whatsoever without the written permission of Mindray is strictly forbidden.

mindray,  **MINDRAY**, are the registered trademarks or trademarks owned by Mindray in China and other countries. All other trademarks that appear in this manual are used only for editorial purposes without the intention of improperly using them. They are the property of their respective owners.

Responsibility on the Manufacturer Party

Contents of this manual are subject to changes without prior notice.

All information contained in this manual is believed to be correct. Mindray shall not be liable for errors contained herein nor for incidental or consequential damages in connection with the furnishing, performance, or use of this manual.

Mindray is responsible for the effects on safety, reliability and performance of this product, only if:

- all installation operations, expansions, changes, modifications and repairs of this product are conducted by Mindray authorized personnel;
- the electrical installation of the relevant room complies with the applicable national and local requirements;
- the product is used in accordance with the instructions for use.

WARNING

- **This equipment must be operated by skilled/trained clinical professionals.**
 - **It is important for the hospital or organization that employs this equipment to carry out a reasonable service/maintenance plan. Neglect of this may result in machine breakdown or personal injury.**
-
-

Warranty

THIS WARRANTY IS EXCLUSIVE AND IS IN LIEU OF ALL OTHER WARRANTIES, EXPRESSED OR IMPLIED, INCLUDING WARRANTIES OF MERCHANTABILITY OR FITNESS FOR ANY PARTICULAR PURPOSE.

Exemptions

Mindray's obligation or liability under this warranty does not include any transportation or other charges or liability for direct, indirect or consequential damages or delay resulting from the improper use or application of the product or the use of parts or accessories not approved by Mindray or repairs by people other than Mindray authorized personnel.

This warranty shall not extend to

- Malfunction or damage caused by improper use or man-made failure.
- Malfunction or damage caused by unstable or out-of-range power input.
- Malfunction or damage caused by force majeure such as fire and earthquake.
- Malfunction or damage caused by improper operation or repair by unqualified or unauthorized service people.
- Malfunction of the instrument or part whose serial number is not legible enough.
- Others not caused by instrument or part itself.

Notification of Adverse Events

As a health care provider, you may report the occurrence of certain events to NANJING MINDRAY BIO-MEDICAL ELECTRONICS CO., LTD., and possibly to the competent authority of the member state in which the user and / or patient is established.

These events include device-related death and serious injury or illness. In addition, as part of our Quality Assurance Program, NANJING MINDRAY BIO-MEDICAL ELECTRONICS CO., LTD. requests to be notified of device failures or malfunctions. This information is required to ensure that NANJING MINDRAY BIO-MEDICAL ELECTRONICS CO., LTD. provides only the highest quality products.

Company Contact

Manufacturer: Nanjing Mindray Bio-Medical Electronics Co., Ltd.
Address: 666# Middle Zhengfang Road, Jiangning, 211111 Nanjing, Jiangsu, P.R.China
Website: www.mindray.com
E-mail Address: service@mindray.com
Tel: +86 755 81888998
Fax: +86 755 26582680

EC-Representative: Shanghai International Holding Corp. GmbH (Europe)
Address: Eiffestrasse 80, 20537 Hamburg, Germany
Tel: 0049-40-2513175
Fax: 0049-40-255726

Preface

Manual Purpose

This manual contains the instructions necessary to operate the product safely and in accordance with its function and intended use. Observance of this manual is a prerequisite for proper product performance and correct operation and ensures patient and operator safety.

This manual is based on the maximum configuration and therefore some contents may not apply to your product. If you have any question, please contact us.

This manual is an integral part of the product. It should always be kept close to the equipment so that it can be obtained conveniently when needed.

Intended Audience

This manual is geared for clinical professionals who are expected to perform daily operations of the product, maintain and troubleshoot the product and learn how to use the product.

Illustrations

All illustrations in this manual serve as examples only. They may not necessarily reflect the setup or data displayed on your equipment.

Conventions

- ***Italic text*** is used in this manual to quote the referenced chapters or sections.
- **Bold text** is used to indicate the screen texts.
- → is used to indicate operational procedures.

This page intentionally left blank.

Contents

1 Safety	1 - 1
1.1 Safety Information	1 - 1
1.1.1 Warning	1 - 1
1.1.2 Caution	1 - 5
1.1.3 Note	1 - 6
1.2 Equipment Symbols	1 - 7
1.3 Warning Label	1 - 9
2 Equipment Introduction	2 - 1
2.1 Intended Use	2 - 1
2.1.1 Intended Purpose	2 - 1
2.1.2 Intended Users	2 - 1
2.1.3 Intended Patient Population	2 - 1
2.1.4 Intended Medical Conditions	2 - 1
2.1.5 Contraindications	2 - 1
2.1.6 Side-effects	2 - 1
2.2 Main Components	2 - 2
2.2.1 Main Unit	2 - 2
2.2.2 Control Unit	2 - 3
2.3 Definition	2 - 3
2.3.1 Slope/Tilt/Longitudinal Shift	2 - 3
2.3.2 0 Position	2 - 4
2.3.3 Zero Longitudinal Shift	2 - 4
2.3.4 Adjustable Part	2 - 4
2.3.5 Overall Load	2 - 4
2.3.6 Normal/ Reverse Patient Orientation	2 - 4
2.4 Prompt Tone	2 - 6
2.5 Abbreviations	2 - 6
3 Daily Operations	3 - 1
3.1 Connecting Potential Equalization Pin	3 - 1
3.2 Connecting to Mains Power	3 - 2
3.2.1 Power Button	3 - 2
3.2.2 Charging Batteries	3 - 3
3.2.3 Indicator on the Base	3 - 5
3.3 Hand Control	3 - 7
3.3.1 Connecting /Disconnecting Corded Hand Control	3 - 8
3.3.2 Attaching Hand Control	3 - 9
3.3.3 Button Operations	3 - 10
3.3.4 Screen Control	3 - 11
3.3.5 Functions	3 - 19
3.3.6 Wireless Hand Control	3 - 26

3.3.7 User Settings	3 - 30
3.4 Override Panel	3 - 45
3.4.1 Functions	3 - 46
3.5 Foot Pump (optional)	3 - 48
3.6 Body Elevator with Hand Crank (optional)	3 - 50
3.7 Remote Control Interface (optional)	3 - 50
3.8 Manual Brake Release	3 - 50
3.9 Foot Switch	3 - 51
3.10 Table-top Modules	3 - 51
3.10.1 Head Plate	3 - 52
3.10.2 Upper Back Plate	3 - 53
3.10.3 Leg Plate	3 - 54
3.10.4 Pad	3 - 56
3.11 Equipment Preparation	3 - 58
4 Table Top Configuration	4 - 1
4.1 General	4 - 1
4.2 With an Overall Load between 250kg and 460kg	4 - 1
4.3 With an Overall Load between 155kg and 250kg	4 - 3
4.4 With an Overall Load Less Than 155kg	4 - 5
5 Cleaning and Disinfection	5 - 1
5.1 Safety Information	5 - 1
5.2 Cleaning	5 - 2
5.2.1 Preparation before Cleaning	5 - 2
5.2.2 Cleaning Procedure	5 - 2
5.3 Disinfection	5 - 3
5.3.1 Recommended Disinfectants	5 - 3
5.3.2 Disinfection Procedure	5 - 5
5.4 Pad Cleaning and Disinfection	5 - 5
5.4.1 Cleaning Procedure	5 - 6
5.4.2 Disinfection Procedure	5 - 6
6 Maintenance	6 - 1
6.1 Maintenance Safety Information	6 - 1
6.2 Maintenance Schedule	6 - 2
6.3 Testing Methods and Procedures	6 - 2
6.3.1 Visual Inspection	6 - 2
6.3.2 Switch-on Test	6 - 3
6.3.3 Battery Maintenance	6 - 3
6.4 Disposal	6 - 5
7 Troubleshooting	7 - 1

7.1 Common Error	7 - 1
A Product Specifications	A - 1
A.1 Safety Specifications	A - 1
A.1.1 Product Classification	A - 1
A.1.2 Environmental Specifications	A - 2
A.2 Power Supply Specifications	A - 2
A.2.1 AC Power	A - 2
A.2.2 Fuse	A - 2
A.2.3 Operating Table Batteries	A - 2
A.3 Wireless Specifications	A - 3
A.3.1 Bluetooth	A - 3
A.3.2 Mobile Charging Station	A - 3
A.4 Load	A - 4
A.5 Performance Specifications	A - 5
A.6 Accessories and Parts List	A - 12
A.7 Electronic Interface	A - 14
B EMC	B - 1
C Declaration of Conformity	C - 1

This page intentionally left blank.

1 Safety

1.1 Safety Information

WARNING

- Indicates a potential hazard or unsafe practice that, if not avoided, could result in death or serious injury.
-
-

CAUTION

- Indicates a potential hazard or unsafe practice that, if not avoided, could result in minor personal injury or product/property damage.
-

NOTE

- Provides application tips or other useful information to ensure that you get the most from your product.
-

1.1.1 Warning

WARNING

- The equipment is to be used for its intended purposes only. Do not use it for other purposes.
- The equipment is to be installed by personnel authorized by Mindray only.
- The equipment is to be operated by trained personnel only.
- Before using the equipment, be sure to read and fully understand this manual.
- Keep this manual in the vicinity of the equipment so that it can be obtained conveniently when needed.
- Ensure the ground is flat and level before installing the operating table.
- Route, wrap and secure the cables to avoid inadvertent disconnection, stumbling and entanglement.
- Loosely laid cables may cause stumbling. Fix the cables reliably when laying them.

- **The overall load of this operating table is 460kg in normal patient orientation. Be sure to take those conditions into consideration when using the operating table.**
- **The overall load of this operating table is 250kg in reverse patient orientation. Be sure to take those conditions into consideration when using the operating table.**
- **If accessories are used, ensure the weights of the accessories installed on the operating table and of the patient add up no more than 460kg in normal patient orientation or 250kg in reverse patient orientation.**
- **The overall load of this operating table is 460kg (250kg in reverse patient orientation). However, in case of certain special conditions, the load capacity is further limited. Be sure to take those conditions into consideration when using the operating table. If you have any questions, contact the customer service department authorized by Mindray or your local distributor.**
- **Transferring the patient inappropriately may tip over the operating table. Be sure to transfer the patient from either side of the operating table. Do not transfer the patient from either the head or the foot end.**
- **Be sure to transfer or position the patient under medical staff's direction.**
- **Before positioning the patient, ensure the patient's body width is no greater than the width of the table top. Neglect of this may cause personal injury. Positioning the patient improperly may tip over the operating table. Be sure to place the patient in the right direction. Do not place the patient's trunk on the leg plate.**
- **When placing the patient, ensure the patient's center of gravity is as close to the column as possible. Otherwise, the operating table may tip over.**
- **Improper positioning may damage the patient, especially in case of excessive tilted or sloped position. Ensure the patient is properly positioned and check if the position deviates at any moment when using the operating table.**
- **Ensure the patient is properly positioned and keep a close eye on the patient during the whole surgery to avoid damaging the patient's respiratory system, nervous system or circulating system.**
- **Before positioning the patient, ensure the castors are properly locked.**
- **Do not use such devices as cell phones, radio equipment and MR equipment around the operating table.**
- **The operating table cannot be used in the presence of a flammable anesthetic mixture with air or with oxygen or with nitrous oxide.**
- **To avoid explosion hazard, do not use the equipment in the presence of oxygen-rich atmospheres, flammable anesthetics, or other flammable agents.**
- **Use and store the equipment within the specified temperature, humidity, and altitude ranges.**

- **Before putting the equipment into operation, the user must verify that the equipment, connecting cables and accessories are in correct working order and operating condition.**
- **If the integrity of the external protective conductor in the installation or its arrangement is in doubt, run the operating table from its internal batteries.**
- **Do not touch the patient and live parts simultaneously. Otherwise, patient injury may occur.**
- **To avoid infection, be sure to cover the table-top pad with a sterile surgical drape before using the operating table.**
- **Do not use wet surgical drapes on the operating table.**
- **Each time before using the operating table, be sure to select the proper function keys according to the patient orientation. Otherwise, personal injury may occur.**
- **Be sure to secure the patient before moving or adjusting the operating table when a patient lying on the operating table.**
- **When lowering the table top, ensure that there are neither the operator's feet nor any objects on the base (underneath the column). Otherwise, the operator may be pinched or the equipment may be damaged.**
- **Before lowering the table top, ensure that there are neither the operator's feet nor any objects underneath the column.**
- **Before locking the operating table, ensure that there are neither the operator's feet nor any objects underneath the base. Otherwise, personal injury may occur.**
- **Before unlocking the castors, grasp the operating table to avoid unexpected movement.**
- **Before moving the mobile operating table, ensure that the operating table is not bent and the longitudinal shift is cancelled.**
- **The speed of table-top movement can change depending on the patient's weight. Closely watch the table top during adjustment.**
- **If the patient weight exceeds 250kg, do not slope the table top by more than 15° and do not tilt the table top to the left or right by more than 5°. Do not adjust the back plate up by more than 70° and down more than 10°. Otherwise, the patient may slip off the table and cause injury.**
- **Ensure the patient is properly secured especially in case of excessive tilted or sloped position when adjusting the operating table or patient position. Otherwise, personal injury or device damage may occur.**
- **If the longitudinal shift is operated when using an x-ray, be sure to restore the operating table to 0 position before the surgery.**
- **Be sure to observe the joints when adjusting the head plate, back plate and leg plate. Otherwise, the patient or medical staff may be pinched.**

- **Be sure to observe the positions of the operating table, accessories, patient and other objects when adjusting or moving the operating table to avoid personal injury or device damage resulting from collision.**
- **When using such medical devices as electrosurgical units, defibrillators or defibrillator monitors, be sure to keep the patient from touching the metallic parts of the operating table or of the accessories. Moreover, ensure the patient is not lying on a wet surgical drape or a conductive pad. Otherwise, the patient may be burned.**
- **Devices connected to the equipment must meet the requirements of the applicable IEC standards (e.g. IEC 60950 safety standards for information technology equipment and IEC 60601-1 safety standards for medical electrical equipment). The system configuration must meet the requirements of the IEC 60601-1 medical electrical systems standard. Any personnel who connect devices to the equipment's signal input/output port are responsible for providing evidence that the safety certification of the devices has been performed in accordance to the IEC 60601-1. If you have any questions, please contact Mindray.**
- **Make sure the electrical installation of building complies with the requirements of IEC 60364-7-710.**
- **Be sure to operate the equipment as instructed in this manual. Warranty does not cover damage caused by non-compliance.**
- **Device service or maintenance should be completed by the authorized personnel only. Warranty does not cover damage caused by unapproved service or maintenance.**
- **The operating table can function safely and effectively only if it is maintained properly and regularly. Be sure to maintain the operating table as instructed in this manual.**
- **Be sure to only use accessories made by Mindray on the operating table. Accessories produced by other manufacturers must not be used as they may cause personal injury. If accessories of other manufacturers must be used, their use should be expressly permitted by Mindray.**
- **Before using accessories, be sure to read the operator's manual thoroughly.**
- **Be sure to use the pad provided by Mindray only. Otherwise, personal injury or device damage may occur.**
- **Disconnect the operating table from the mains power before opening the housing.**
- **No modification of this device is allowed.**
- **Do not use agents containing alcohol where high-frequency equipment is being used. Neglect of this may cause fire hazard.**
- **There may be a risk of infection if the operating table is under the complicated and changeable medical conditions. Follow the hospital**

requirements and refer to “Cleaning and Disinfection” chapter to clean/ disinfect the operating table.

- The software was developed in compliance with IEC 62304. The possibility of hazards arising from software errors is minimized.
 - The equipment software copyright is solely owned by Mindray. No organization or individual shall resort to modifying, copying, or exchanging it or to any other infringement on it in any form or by any means without due permission.
 - At the end of its service life, the equipment, as well as its accessories, must be disposed of in compliance with the local regulations. If you have any questions concerning disposal of the equipment, please contact Mindray.
 - For disposal of parts and accessories, unless otherwise specified, follow local regulations regarding disposal of hospital waste.
 - Inspect and replace the battery at regular service intervals. If you have any questions, please contact Mindray.
 - Dispose of the package material as per the applicable waste control regulations. Keep it out of children’s reach.
-
-

1.1.2 Caution

CAUTION

- Exercise caution when transporting or moving the equipment. Do not damage it during transportation or movement.
- Always install or carry the equipment or accessories properly to avoid damage caused by drop, impact, strong vibration or other mechanical force.
- Before moving the operating table, ensure the path is clear. Do not damage the castors or other parts.
- When moving the operating table, ensure there is not any object on the table top.
- When moving the operating table, be sure to use both hands to adjust/ control the movement. Keep the operating table from colliding with other things.
- If the table top has descended to a low position, exercise caution when adjusting the table top. Keep the table top from colliding with the base or the ground.
- If the head/leg plate has been positioned downward, exercise caution when adjusting the table top. Keep the head/leg plate from colliding with the base or the ground.
- When sloping the table top or adjusting the leg plate, ensure they do not collide with the column or the base.

- **Do not put any object on the operating table base. Neglect of this may cause equipment damage.**
 - **When adjusting the table top, ensure the cord of the corded hand control is not jammed by the joints.**
 - **Be sure to lock the operating table and adjust the table top to 0 position when it is not in use.**
 - **When adjusting the operating table, ensure the suspended parts (such as leg plates, arm boards) do not collide with other things inside the operating room.**
 - **When adjusting the operating table, ensure the accessories or the surgical drapes are not jammed by the joints. Otherwise, equipment damage may occur.**
 - **Check the screws for components and parts regularly to prevent them falling off.**
 - **Be sure to use spare parts supplied by Mindray only.**
 - **Connector pins with an ESD warning symbol should not be touched and no connections should be made between these connectors without implementing ESD protective measures. Such precautionary procedures may include antistatic clothing and shoes, the touch of a ground stud before and during connecting the pins or the use of electrically isolating and anti-static gloves. All staff involved in the above shall receive instruction in these ESD precautionary procedures.**
-



















1.1.3 Note















NOTE

- **Contents of this manual are based on the full configuration of the operating table. Some of them may not apply to your operating table. Use your operating table according to the actual configuration. If you have any questions, contact the customer service department authorized by Mindray or your local distributor.**
-

1.2 Equipment Symbols

Some symbols may not appear on your equipment.

Symbol	Description	Symbol	Description
 (Blue)	Refer to instruction manual/booklet		Caution
	Unique Device Identification		Class II equipment
	Protective earth (ground)		Equipotentiality
IPX5	Protection against water jets	IPX8	Protection against the effects of continuous immersion in water
	Body elevator		On/Off
 (Red)	No sitting		Serial number
	Catalogue number		Alternating current
	Direct current		Anti-static
	Date of manufacture		Manufacturer
	This way up		Keep dry

Symbol	Description	Symbol	Description
	Fragile, handle with care		Stacking limit by number
	Stacking limit by mass		Temperature limit
	Humidity limitation		Atmospheric pressure limitation
	Recovery/recyclable		Non-ionizing electromagnetic radiation
	Type B applied part		Separate collection for electrical and electronic equipment
	This product is provided with a CE marking in accordance with the regulations stated in Regulation(EU) 2017/745 concerning Medical Devices.		Medical Device
	Unified circulation mark indicates that products marked them passed all specified in the technical regulations of the Customs Union of the procedure for the assessment (confirmation) of conformity and complies with the requirements applicable to all the products technical regulations of the Customs Union.		Authorized representative in the European Community
 (Yellow)	General warning sign		

1.3 Warning Label

- Warning label for longitudinal shift: The label is located above the column cover. With an overall load of more than 250kg, do not operate the longitudinal shift.

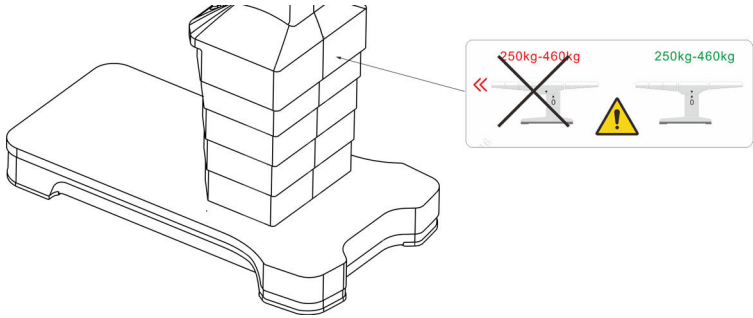

This page intentionally left blank.

2 Equipment Introduction

2.1 Intended Use

2.1.1 Intended Purpose

The operating table is intended to support and position patients immediately before, during and after surgical procedures, as well as for examination and treatment.

2.1.2 Intended Users

The operating table may only be operated by medically trained staff.

2.1.3 Intended Patient Population

The operating table is intended for patients who are in surgical, examination and treatment procedures.

2.1.4 Intended Medical Conditions

The operating table is used in healthcare facility environment.

2.1.5 Contraindications

None.

2.1.6 Side-effects

According to the conclusion of clinical evaluation and residual risk evaluation, for the intended patients, there are no known side effects that can occur during or after the use of the medical device. And there is no need for the operator to make extra preparations. Thus, no residual risk associated with using the medical device should be disclosed.

WARNING

- **Contents of this manual are based on the full configuration of the operating table. Some of them can not apply to your operating table. Use your operating table according to the actual configuration. If you have any questions, contact the customer service department authorized by Mindray or your local distributor.**
 - **The operating table is to be operated by trained personnel only. Non-authorized or untrained personnel cannot operate the operating table.**
-
-

2.2 Main Components

The operating table consists of the main unit (including the table top, column, base, hydraulic system, electric system), pad and control unit, and has optional head plate, leg plate and upper back plate.

2.2.1 Main Unit

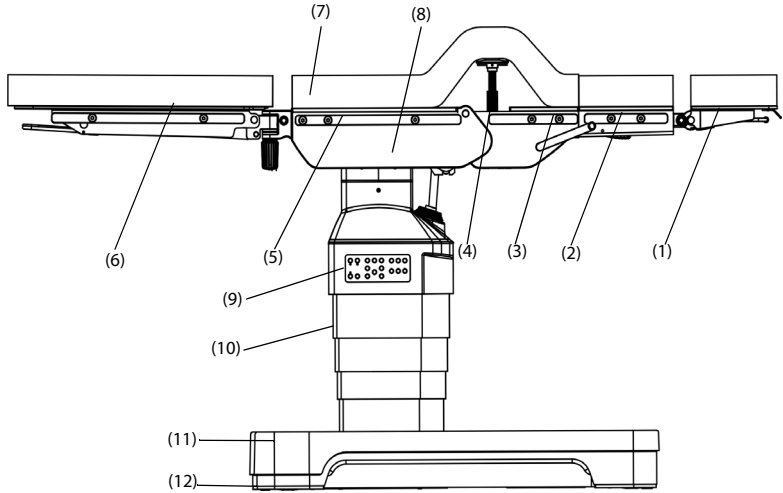

- | | | |
|------------------------------|----------------------|----------------------|
| (1) Head plate | (2) Upper back plate | (3) Lower back plate |
| (4) Body elevator (optional) | (5) Seat plate | (6) Leg plate |
| (7) Pad | (8) Beam | (9) Override panel |
| (10) Column | (11) Base | (12) Base support |

2.2.2 Control Unit

(1)Corded hand control



(2)Wireless hand control

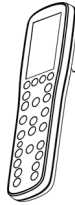

(3)Foot switch

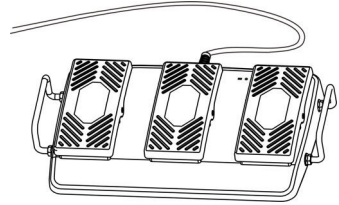

2.3 Definition

2.3.1 Slope/Tilt/Longitudinal Shift

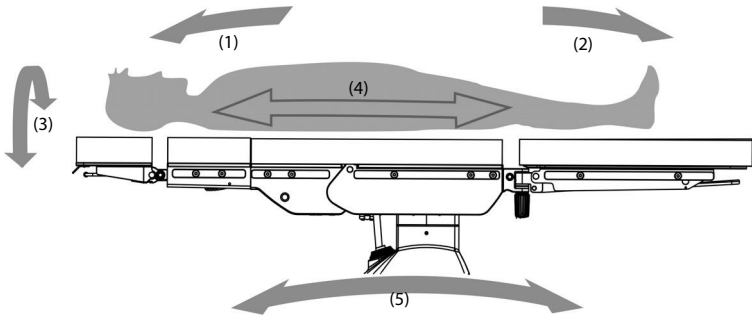

(1)Trendelenburg

(2)Reverse Trendelenburg

(3)Tilt

(4)Longitudinal shift

(5)Slope

2.3.2 0 Position

0 position: the table top is horizontal and does not have any longitudinal shift.

2.3.3 Zero Longitudinal Shift

The longitudinal shift distance of the table top is zero.

2.3.4 Adjustable Part

Adjustable parts of the product, including release lever, release handle, grip of the release bracket and so on, are indicated in blue which are easy for users to recognize.

2.3.5 Overall Load

The “overall load” results from putting together patient weight and accessory weight. The “overall load” is the load which can be placed on the table top. Restrictions might result from the components or accessories for which other overall loads may be applicable, or from special patient positions.

2.3.6 Normal/Reverse Patient Orientation

The patient orientation (normal or reverse) depends on the position of the patient on the table top with regard to the operating table base (1).

WARNING

- **Incorrect patient orientation may cause adjustment of the operating table in a direction that is not intended. Check if the patient orientation is correct prior to making any adjustments.**
 - **The patient orientation is indicated in the status bar on the screen of the hand control. See 3.3.5.13 Status Indicator.**
-
-

2.3.6.1 Normal Patient Orientation

The upper part of the patient's body is located above the operating table base (1).

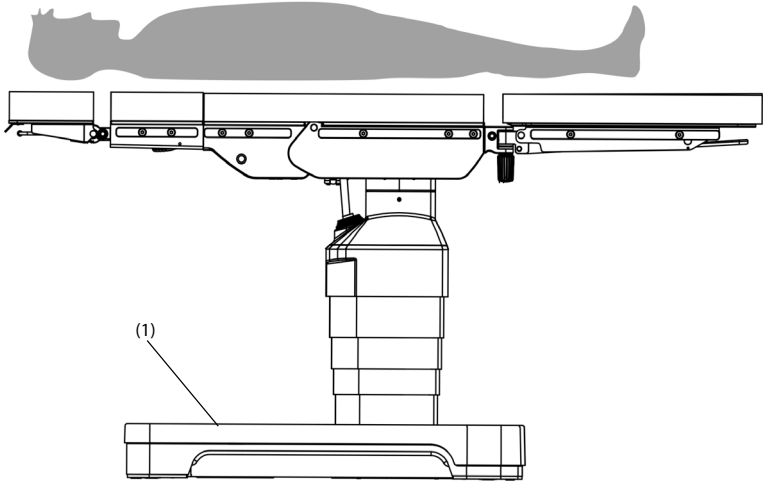

2.3.6.2 Reverse Patient Orientation

The patient's legs are located above the operating table base (1).

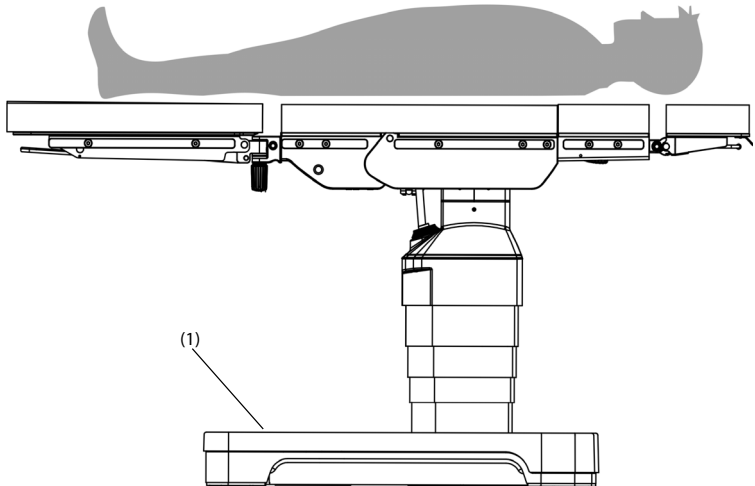

2.4 Prompt Tone

Acoustic signal of the operating table is for prompt, detailed types and cases are listed below:

Prompt Tone	Acoustic Signal Type	Case
Normal prompt tone	Beep once	e.g. desired movement completed, normal operation
Arrival confirmation tone	Beep twice	e.g. final position reached, wireless hand control successfully connected
Risk prompt tone	Beep intermittently and slowly	e.g. workable button pressed under unlocking
Collision prompt tone	Beep intermittently and quickly	e.g. impending collision
Use-prohibited tone	Beep continuously	e.g. movement prohibited or limited
Timing tone	Beep five times	e.g. The wireless hand control is being connected after Trendelenburg button on the override panel has been pressed.

2.5 Abbreviations

Abbreviations	In full
AC	Alternating current
DC	Direct current
EMC	Electromagnetic compatibility
EU	European Union
Info.	Information
RF	Radio frequency
UPS	Uninterrupted power supply

3 Daily Operations

3.1 Connecting Potential Equalization Pin

WARNING

- **When using the operating table together with other devices, connect their potential equalization pins together to eliminate the potential difference between them. Otherwise, personal injury or device damage may occur.**
-
-

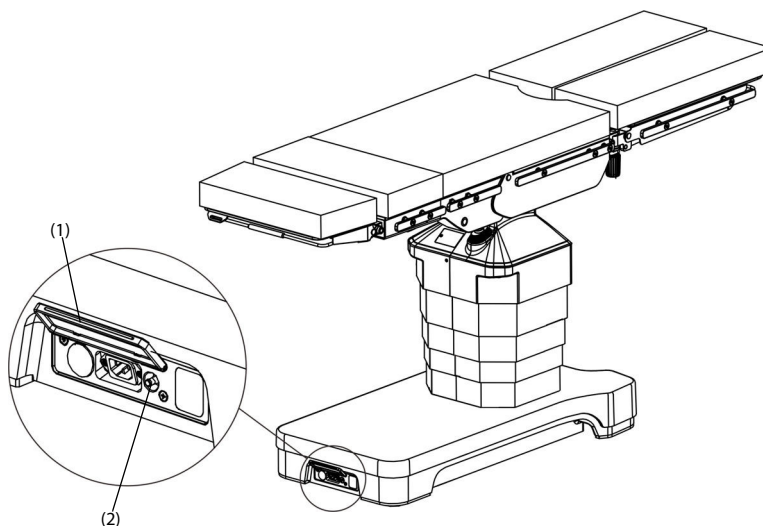

To connect the potential equalization pin:

1. Open the waterproof cover (1) on the base.
2. Connect one end of the equipotential cable to the potential equalization pin (2) of the operating table.
3. Connect the other end of the equipotential cable to the potential equalization pin of another device.

NOTE

- Disconnect the equipotential cable before moving the operating table.
-

3.2 Connecting to Mains Power

3.2.1 Power Button

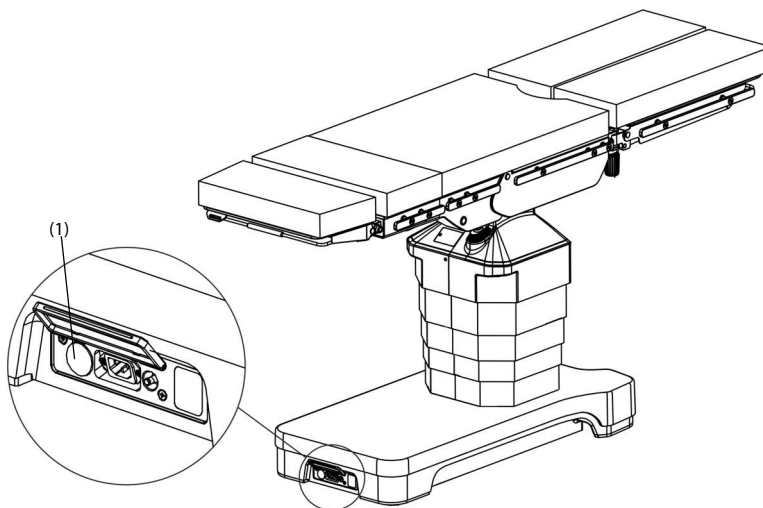

Press the power button (1) to control the power-on or power-off of the operating table.

WARNING

- Press the power button to power off the operating table in case of an emergency.
-

CAUTION

- Power off the operating table by pressing the power button if the operating table is not to be used for a long time (e.g. for weekend or holidays). Otherwise, battery damage may occur.
-

3.2.2 Charging Batteries

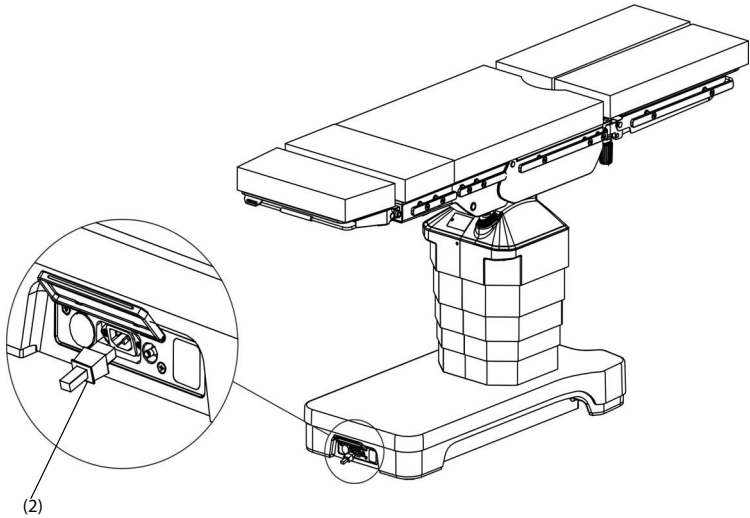

To keep good performance, fully or nearly fully discharged batteries should be charged as soon as possible. The operating table is charged automatically once connected to AC power.

For new batteries, it takes about 10 hours to fully charge them. Fully charged rechargeable batteries are sufficient for about one week of operating table operation.

WARNING

- **Check if the power cord has any sign of wear or damage before use. Damaged cord must be replaced immediately.**
- **Always use the accompanying power cord delivered with the operating table.**
- **Before connecting the equipment to AC power, check whether the voltage and frequency ratings are the same as those indicated on the AC adapter and manual.**
- **Do not touch the power connector with the wet hand. Eliminate the liquid residue inside of or at the surroundings of the AC power connector of the equipment and power cord connectors. Otherwise, personal injury or equipment damage may occur.**
- **If the integrity of the external protective conductor in the installation or its arrangement is in doubt, run the operating table from its internal batteries.**

- **To avoid the risk of electric shock, the operating table must only be connected to mains power with protective earth.**
-
-

NOTE

- **The operating table is disconnected from the mains power by means of detaching the plug. Do not locate the operating table in a place where it is difficult to operate the mains plug.**
 - **It is recommended that the operating table be run from its internal batteries.**
 - **In order to prevent the charging of batteries during surgeries, it is recommended the rechargeable batteries be charged after surgeries and on a daily basis. On principle, deep discharge of the rechargeable batteries should be avoided.**
 - **Ensure the battery capacity is sufficient if the operating table is powered by internal batteries. Charge the batteries if necessary.**
 - **If the batteries cannot work normally, contact the customer service department authorized by Mindray or your local distributor.**
 - **If the run time of the fully charged batteries is noticeably shortened, contact the customer service department authorized by Mindray or your local distributor.**
 - **The battery must only be installed and replaced by service personnel trained and authorized by Mindray. Installation or replacement by untrained personnel may cause personal injury (e.g. batteries overheated, ignited or exploded). Batteries are recommended to be replaced every three years under normal use.**
 - **Disconnect the power cord before moving the operating table.**
-

Follow the steps below to connect the power cord:

1. Open the waterproof cover.
2. Connect the power cord to the power connector (2) of the operating table.
3. Connect the power cord to the mains power outlet.

Follow the steps below to detach the power cord:

1. Detach the power cord from the mains power outlet.
2. Detach the power cord from the power connector of the operating table.

3.2.3 Indicator on the Base

AC indicator (1) and battery indicator (2) are located on the base. Indicator status is shown below:

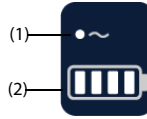

Indicator	Status	Description
AC indicator	Green	The operating table is connected to mains power.
Battery indicator (not connected to AC)	Four battery bars are green.	The battery capacity of the operating table is no less than 90%.
	Three battery bars are green.	The battery capacity of the operating table is no less than 70% and less than 90%.
	Two battery bars are green.	The battery capacity of the operating table is no less than 35% and less than 70%.
	One battery bar is red.	The battery capacity of the operating table is less than 35%.

Indicator	Status	Description
Battery indicator (connected to AC)	All battery bars cyclically change.	The batteries of the operating table are being charged and the charging capacity is less than 35%.
	The first battery bar is green and other three bars cyclically change.	The batteries of the operating table are being charged and the charging capacity is no less than 35% and less than 70%.
	The first two battery bars are green and other two bars cyclically change.	The batteries of the operating table are being charged and the charging capacity is no less than 70% and less than 90%.
	The first three battery bars are green and the fourth bar flashes.	The batteries of the operating table are being charged and the charging capacity is no less than 90% and less than 100%.
	Four battery bars are green.	The batteries of the operating table are fully charged.
Battery indicator	The second battery bar is red and flashes.	The operating table has an error, contact the customer service department authorized by Mindray.
	The third battery bar is red and flashes.	
	The fourth battery bar is red and flashes.	

NOTE

- **Once the operating table is powered on by pressing the power button and not connected to mains power, the battery indicator will show current capacity and go out after 20 seconds.**

3.3 Hand Control

Operate the corded hand control and wireless hand control in the same way.

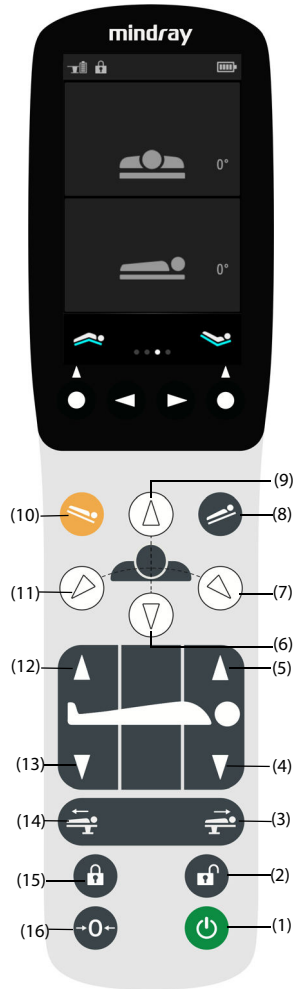

(1)Standby

(2)Unlock

(3)Longitudinal shift toward head end

(4)Back plate down

(5)Back plate up

(6)Table top down

(7)Tilt to right

(8)Reverse Trendelenburg

(9) Table top up

(10)Trendelenburg

(11)Tilt to left

(12)Leg plate up (Reverse patient orientation)

(13)Leg plate down (Reverse patient orientation)

(14)Longitudinal shift toward foot end

(15)Lock

(16)0 position

WARNING

- **Ensure the operating table is in view of users when the wireless hand control is used. Otherwise, personal injury may occur.**
-
-

NOTE

- **When adjusting the operating table, ensure the cord of the corded hand control is not jammed by joints.**
 - **Switch off the control unit after all the adjustments are completed to avoid misoperation.**
 - **Ensure all functions are normal before each use.**
 - **If different functions are triggered on the same control unit, the motion of the operating table except the switch-off will be stopped immediately.**
 - **Do not perform adjustments with two control units at the same time. If functions are triggered by multiple control units, then all motions except the switch-off of the operating table will be stopped immediately and will resume only after none of the control units has been activated. If the override panel is triggered, it takes priority over other control units.**
-

3.3.1 Connecting /Disconnecting Corded Hand Control

The sockets for connecting the corded hand control are located on both sides of the column.

- To connect the corded hand control: insert the plug into the socket with the red mark (1) on the corded hand control cable aligned with that (2) on the operating table socket. Ensure the plug is properly seated.
- To disconnect the corded hand control: grasp the front end of the corded hand control cable and pull it out straight down.

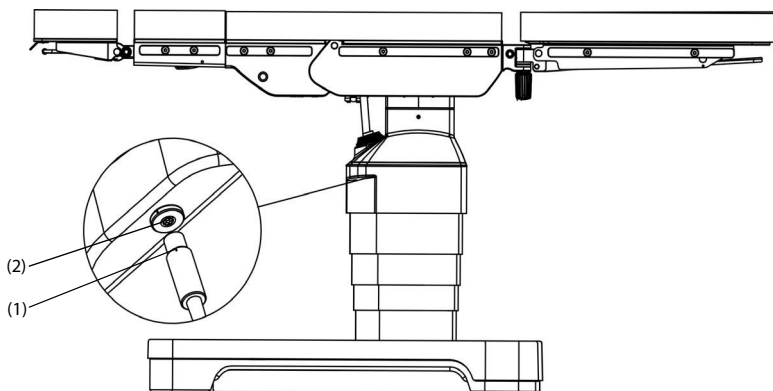

3.3.2 Attaching Hand Control

CAUTION

- The hand control which is attached to the side rail may slip off the side rail or catch the cable during table top adjustment. Take the hand control out of the side rail during the adjustment.
-

Attach the bracket (1) to the side rail (2).

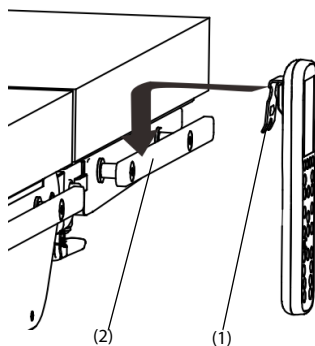



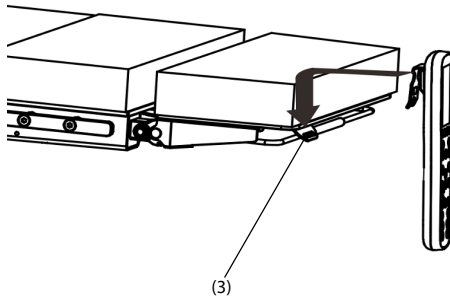









The hand control can be attached onto the lug (3) of the head plate if equipped.







3.3.3 Button Operations

After the operating table is switched on, press and hold the button until the desired position is reached and then release the button.

3.3.3.1 Button Symbol

Symbol	Description	Symbol	Description
	Standby		One-button to 0 position
	Unlock		Lock
	Longitudinal shift toward head end		Longitudinal shift toward foot end
	The circled means back plate up.		The circled means back plate down.
	The circled means leg plate up.		The circled means leg plate down.
	Tilt to right		Tilt to left

Symbol	Description	Symbol	Description
	Table top up		Table top down
	Reverse Trendelenburg		Trendelenburg

3.3.4 Screen Control

The screen will show movement part, direction and value when the control unit is used to adjust the table top movements. Screen interface can be operated by control buttons below.

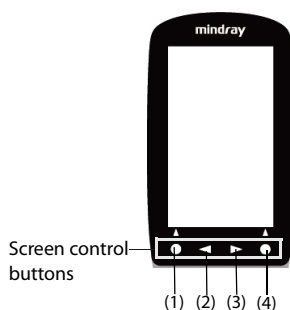





(1)Select/Confirm



























(2)Select

(3)Select

(4)Select/Confirm

3.3.4.1 Interface Symbol

Symbol	Description	Symbol	Description
	Operating table locked		Operating table unlocked
	Battery of wireless hand control		Operating table batteries

Symbol	Description	Symbol	Description
	0° tilt		Tilt to left
	Tilt to right		0° slope
	Trendelenburg position		Reverse Trendelenburg position
	Zero longitudinal shift		Longitudinal shift toward head end
	Longitudinal shift toward foot end		0° back plate angle
	Back plate up		Back plate down
	Select		Select
	Back		Flex position
	Reflex position		Normal patient orientation
	Reverse patient orientation		Save
	Select/Confirm		Delete
	User Settings		General warning sign
	Disconnected with operating table		Connected with operating table

3.3.4.2 Main Interface-Flex Position/Reflex Position

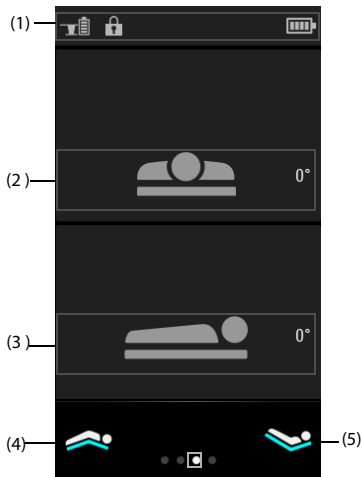

(1)Status bar

(2)Tilt

(3)Slope

(4)Flex position

(5)Reflex position

Once the hand control is switched on, it enters the main interface and displays the following from the top down:

- Status bar: displaying the locked status of the operating table, battery status of both the operating table and wireless hand control, operating table name. See **3.3.5.13 Status Indicator**.
- Parameter area: displaying real-time status including tilt angle, slope angle.
- Function selection area: main interface displays flex position and reflex position which can be accomplished by pressing and holding the button  below.

3.3.4.3 Normal/Reverse Patient Orientation



(1)Normal patient orientation

(2)Reverse patient orientation

- Enter the selection interface of normal or reverse patient orientation by pressing the selective button (< or >) → press and hold the button ● below the screen for two seconds to reach the normal or reverse patient orientation.

3.3.4.4 Quick Save/Call Memory Position

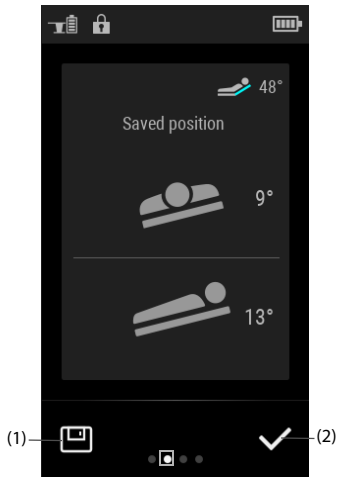

(1)Save

(2)Select/Confirm

- Enter the selection interface of quick saving current operating table position or calling last memory position by pressing the selective button (< or >) → press the button  below the screen to save the current position or call the last memory position.

NOTE

- **Before calling a memory position, store the patient position with the hand control.**

3.3.4.5 User Settings



(1)User settings

- Enter the user settings interface (1) by pressing the selective button (< or >).
→ press the button ● to enter detailed user settings.
- You can call/save memory position, check parameters of operating table, set the screen brightness, select the language of the hand control, name the operating table, operate the bluetooth connection, enable the smart backlit keypad, set switch-on mode and foot switch function, check the operating table battery and software information and restore factory settings. Please see **3.3.7 User Settings** for details.

3.3.4.6 Prompt Message

The operating table has not only prompt tone, but prompt message on the screen. See details below:

- Common prompt message: indicated in white

Prompt message of normal use, e.g. position reached, normal or reverse patient orientation set, operating table locked or unlocked, operating table connected, position saved, battery status of operating table and wireless hand control.



- Low-risk prompt message: indicated in yellow

Noticeable prompt message, e.g. final position reached, operating table disconnected, low battery, locking error, collision risk.

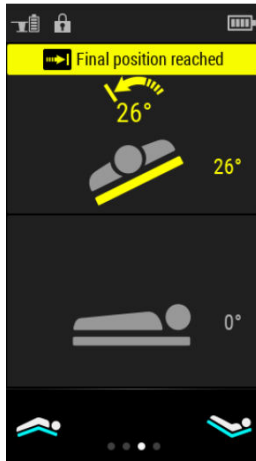

- High-risk prompt message: indicated in red
Especially noticeable prompt message, e.g. excessive sloped angle.

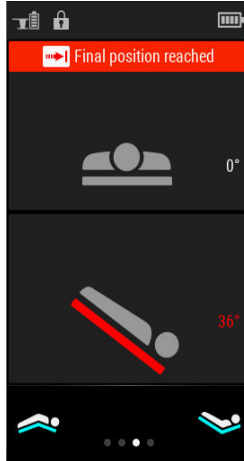

- Error indication
 - ◆ If the following prompt message appears, contact the customer service department authorized by Mindray or your local distributor.

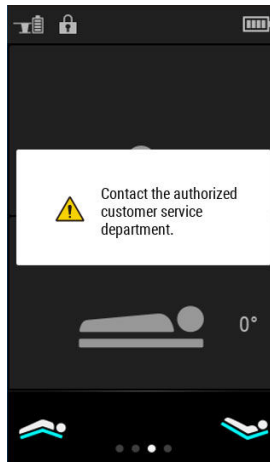



- ◆ If the symbol  appears on the status bar, some error has occurred. Contact the customer service department authorized by Mindray or your local distributor.

3.3.5 Functions

3.3.5.1 Switch-on

- Press the standby button  to enter the switch-on status.
- Press any button to switch on the operating table if it is configured with such a function.

3.3.5.2 Unlock /Lock

1. Lock: press and hold the lock button  for two seconds. It takes about six seconds to lock the operating table.
2. Unlock: press and hold the unlock button  for two seconds. It takes about six seconds to unlock the operating table.
3. A progress bar will appear on the screen during the process of unlocking or locking. A prompt message will also appear once unlocking or lock is accomplished.

Lock the castors:

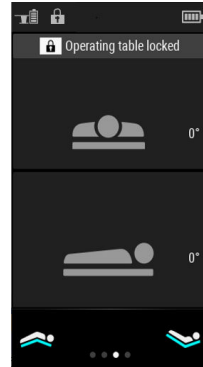
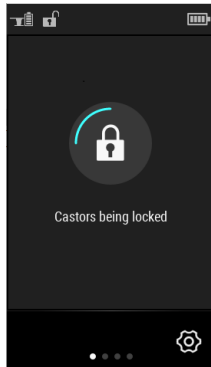

Unlock the castors:

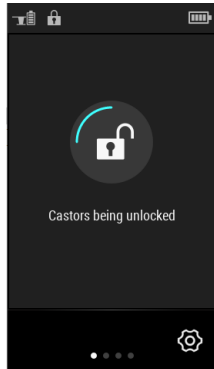

WARNING

- Before locking the operating table, ensure that there are neither the operator's feet nor any objects underneath the base. Otherwise, personal injury or equipment damage may occur.
 - The adjustment of table top up, tilt or longitudinal shift is restricted after the operating table castors are unlocked.
-
-

NOTE

- A prompt message as [Long press 2s] will appear on the screen if you do not unlock or lock the operating table within specified time.
-

Unlock:

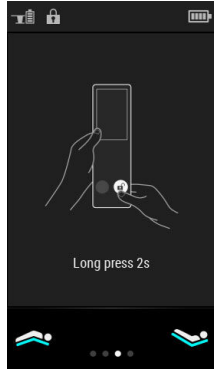

Lock:

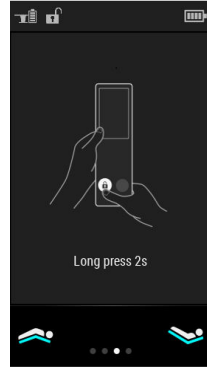



NOTE

- Interruption of locking or unlocking procedure or sudden power-off may cause both locking and unlocking indicators flashing after the operating table is switched on again. Press the lock or unlock button to continue the operation.

3.3.5.3 One-button to 0 position

Press and hold 0 position button  to adjust the operating table to 0 position.

3.3.5.4 Longitudinal Shift

1. Longitudinal shift toward foot end: press and hold the button .
2. Longitudinal shift toward head end: press and hold the button .

3.3.5.5 Table Top Up/Down

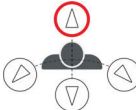

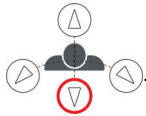
1. Table top up: press and hold the button .

2. Table top down: press and hold the button .

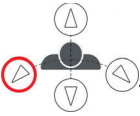
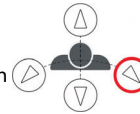
3.3.5.6 Tilt

1. Tilt to left: press and hold the button .
2. Tilt to right: press and hold the button .

3.3.5.7 Slope



1. Trendelenburg position: press and hold the button .
2. Reverse Trendelenburg position: press and hold the button .

WARNING

- **Ensure the patient is properly secured in case of sloped position when adjusting the operating table. Otherwise, personal injury or device damage may occur.**
-
-

3.3.5.8 Leg Plate Up/Down

In the reverse patient orientation, the leg plate can be adjusted up or down.

1. Leg plate up: press and hold the button .
2. Leg plate down: press and hold the button .

3.3.5.9 Back Plate Up/Down

1. Back plate up: press and hold the button



2. Back plate down: press and hold the button



3.3.5.10 Smart Backlit Keypad

If the smart backlit keypad is enabled, buttons on the hand control are divided by backlit keypad. Identify the available functions by backlit buttons. See the details below:

- If a certain movement reaches its final position, its button backlight will go off.
- Under the unlocked status, function of the backlit button is enabled while function of the button without backlight is disabled.

3.3.5.11 Color-coded Indication

During the tilt or slope adjustment, a color-coded indication will respectively appear on the screen if the angle of the single movement is no less than 15° or 30°.

≥ 15°, <30°:

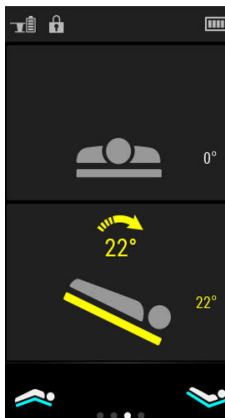

≥ 30°:

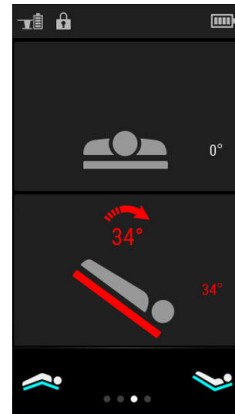

NOTE

- **The default yellow-coded and red-coded values are 15° and 30° respectively. If you need to change the setting, see 3.3.7.8 More Settings.**

3.3.5.12 Switch-off







Press the standby button  to enter the standby status or it will enter the standby status automatically when the hand control is idle for more than 20 seconds.











NOTE



- **The default automatic switch-off time for the hand control is 20 seconds. If you need to change the time setting, contact the customer service department authorized by Mindray or your local distributor.**

3.3.5.13 Status Indicator

Observe the battery status of the wireless hand control or operating table, locking/unlocking status, normal/reverse patient orientation in the status bar.

Indicator	Status	Description
Battery indicator of the wireless hand control		Red. The battery capacity of the wireless hand control is no more than 10%, which indicates the wireless hand control needs to be charged immediately.
		Red. The battery capacity of the wireless hand control is in the range of approximately 10%-25%. The screen will prompt low battery message.
		Grey. The battery capacity of the wireless hand control is in the range of approximately 25%-50%.
		Grey. The battery capacity of the wireless hand control is in the range of approximately 50%-75%.
		Grey. The battery capacity of the wireless hand control is in the range of approximately 75%-100%.
		Battery bars cyclically change in green during charging, which will stop if the battery is fully charged.

Indicator	Status	Description
Operating table battery indicator		Red. The battery capacity of the operating table is less than 35%. The screen will prompt low battery message.
		Grey. The battery capacity of the operating table is no less than 35% and less than 70%.
		Grey. The battery capacity of the operating table is no less than 70% and less than 90%.
		Grey. The battery capacity of the operating table is no less than 90%.
Operating table battery indicator		All battery bars are green and cyclically change. The batteries of the operating table are being charged and the charging capacity is less than 35%.
		The first battery bar is green and other three bars cyclically change. The batteries of the operating table are being charged and the charging capacity is no less than 35% and less than 70%.
		The first two battery bars are green and other two bars cyclically change. The batteries of the operating table are being charged and the charging capacity is no less than 70% and less than 90%.
		The first three battery bars are green and the fourth bar flashes. The batteries of the operating table are being charged and the charging capacity is no less than 90% and less than 100%.
		Green. The batteries of the operating table are fully charged.
	Operating table locking indicator	

Indicator	Status	Description
Operating table unlocking indicator		The operating table is unlocked.
Normal patient orientation indicator		The operating table is set to normal patient orientation.
Reverse patient orientation indicator		The operating table is set to reverse patient orientation.

3.3.6 Wireless Hand Control

3.3.6.1 Bluetooth Connection of Wireless Hand Control

- If the wireless hand control switched on is not connected to the operating table, follow the steps on the screen to continue the connection. Once the wireless hand control is connected, the screen shows the message **[Connected]**.

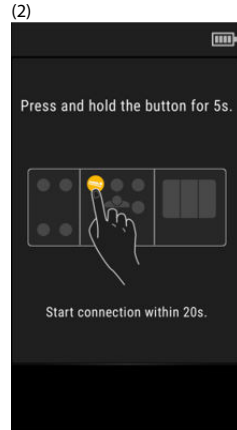
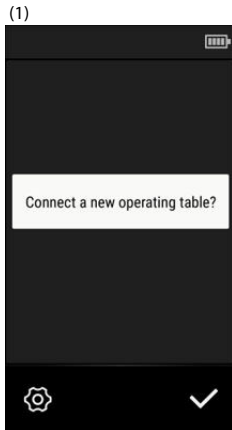

(3)

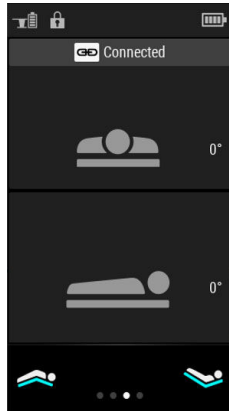

- The connection may fail and a prompt message below will appear. Repeat the connection procedure until it succeeds.

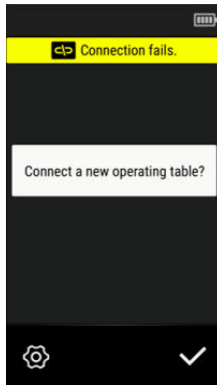

- The connection may disconnect after a successful connection. Repeat the connection procedure until it succeeds.

3.3.6.2 Charging Wireless Hand Control

Observe the current battery capacity of the wireless hand control by the battery indicator in the status bar. See details in **3.3.5.13 Status Indicator**. Follow the steps below to charge the battery if it is low. It takes about 10 hours to fully charge an automatically switched-off wireless hand control.

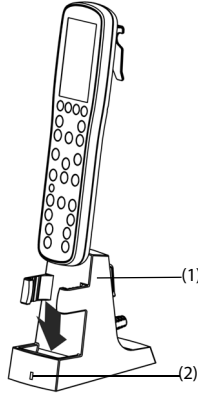

(1) Mobile charging station

(2) Indicator of mobile charging station

1. Connect the mobile charging station to the mains power.
2. Switch off the wireless hand control and insert it into the mobile charging station (1) and the wireless hand control is automatically charged. Observe the charging status by the indicator (2):

Indicator	Status	Description
Indicator of mobile charging station	Red	As soon as the mobile charging station is connected to AC power, it is dangerous to let the metal get close.
	Green	The wireless hand control is being charged.

The run-time of the battery depends on the equipment operation. The fully charged wireless hand control is sufficient for four hours of continuous operation under normal use.



NOTE

- **In order to avoid empty battery of the wireless hand control during the surgery, we recommend you store the wireless hand control in the mobile charging station when it is not in use.**
- **Be sure to use the mobile charging station to charge the wireless hand control.**
- **Ensure the wireless hand control is reliably placed into the mobile charging station, which means the indicator of mobile charging station is green.**

- **Do not place the objects such as metal to the charging area.**
 - **Do not use the wireless hand control during charging to adjust the operating table.**
 - **Ensure the battery power is sufficient if the wireless hand control is to be used. Charge the battery if necessary.**
 - **Use the battery in the wireless hand control at least once every month to extend battery life. Charge the battery before its capacity is depleted.**
 - **Inspect and replace the battery at regular service intervals. Life expectancy of a battery depends on how frequent and how long it is used. For a properly maintained and stored lithium-ion battery, its life expectancy is approximately three years. More aggressive usage will shorten the life expectancy. Replacing the lithium-ion battery every three years is recommended.**
 - **In case of a battery failure, contact Mindray service personnel for battery replacement.**
-

3.3.7 User Settings

3.3.7.1 Calling Memory Position



Select [**Call Memory Position**] via the selective button (◀ or ▶) → press the button  below the symbol  to enter the interface → select the desired position → press and hold the button  → the operating table is to be adjusted until the desired memory position is reached.





NOTE

-
- **If the patient orientation of the selected memory position does not match that of the current operating table, adjust it to the right patient orientation before calling memory position.**
-





3.3.7.2 Saving Memory Position

Select **[Save Memory Position]** via the selective button (◀ or ▶) → press the button  below the symbol  to enter the desired interface.

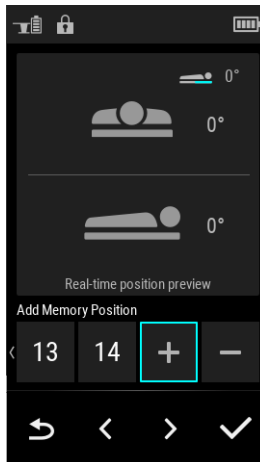





- ◆ Add a memory position: select the button  via the selective button (◀ or ▶) → press the button  below the symbol  to save the position. 30 memory positions can be saved at most.

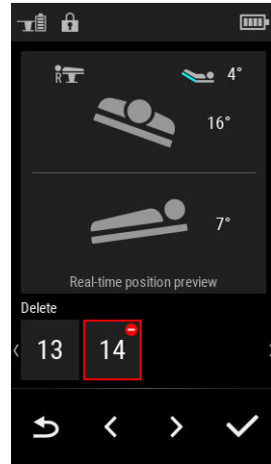
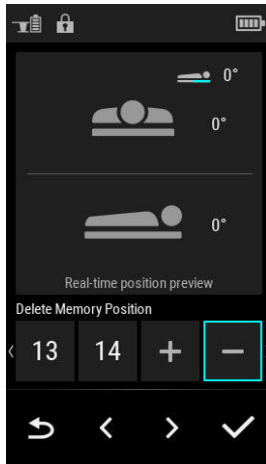

- ◆ Delete a memory position: select the button  via the selective button ( or ) → press the button  below the symbol  to delete the position.



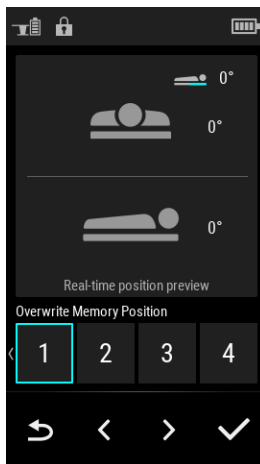

- ◆ Overwrite a memory position: select the position to be overwritten via the selective button ( or ) → press the button  below the symbol  to overwrite it.



NOTE

- **The status bar will display the corresponding icon if the memory position is saved under the reverse patient orientation.**
-

3.3.7.3 Checking Parameters of Operating Table

Select **[Operating Table Parameters]** via the selective button (**<** or **>**) → press the button  below the symbol  → check the parameters.

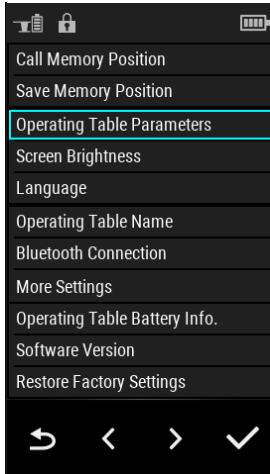



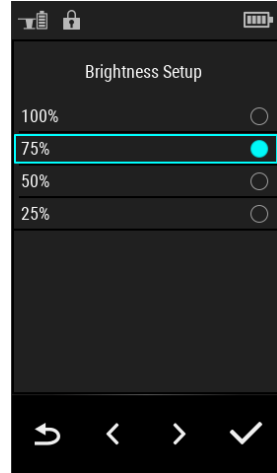
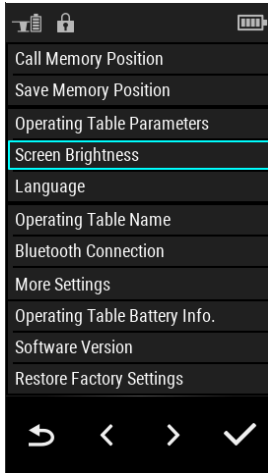

3.3.7.4 Selecting Screen Brightness

Select **[Screen Brightness]** via the selective button (**<** or **>**) → press the button **○** below the symbol **✓** → select one of the four levels: 25%, 50%, 75%, 100%.



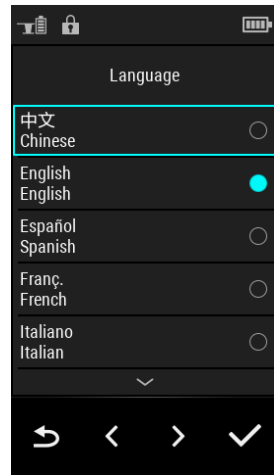
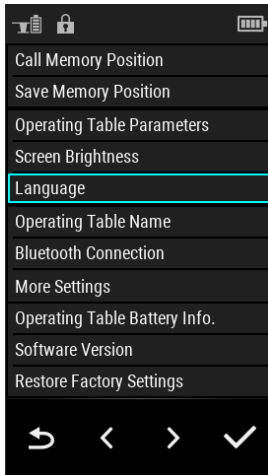

3.3.7.5 Selecting Language

Select **[Language]** via the selective button ( or )→press the button  below the symbol  to enter the language selection interface→select the desired language.



3.3.7.6 Naming Operating Name

Select **[Operating Table Name]** via the selective button (◀ or ▶) → press the button  below the symbol  to enter the name interface.

The name of the operating table can have four characters at most. Save the name by pressing **[Save]** and it will show on the status bar.

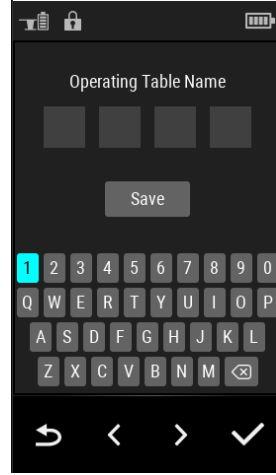
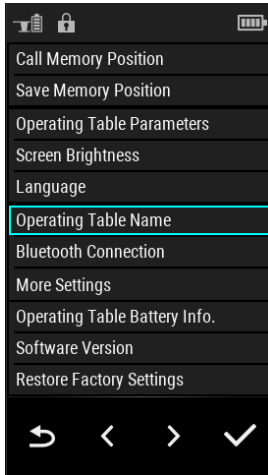

3.3.7.7 Bluetooth Connection

Select **[Bluetooth Connection]** via the selective button (**<** or **>**)→press the button **○** below the symbol **✓** to enter the bluetooth connection interface →confirm whether to be connected to a new operating table→ connect it by following the steps in **3.3.6.1 Bluetooth Connection of Wireless Hand Control** after confirmation.

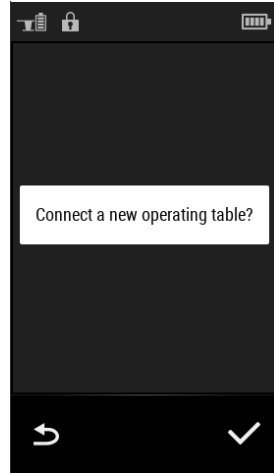
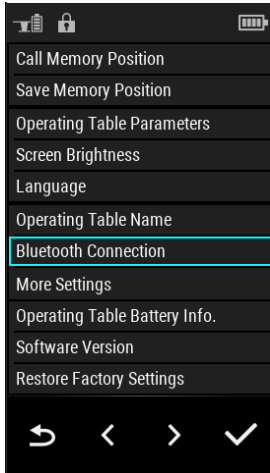

3.3.7.8 More Settings

Select [**More Settings**] via the selective button (◀ or ▶)→press the button below the symbol to enter the interface to enable or disable the smart backlit keypad, set switch-on mode and foot switch function.

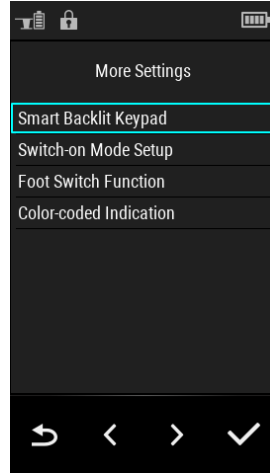
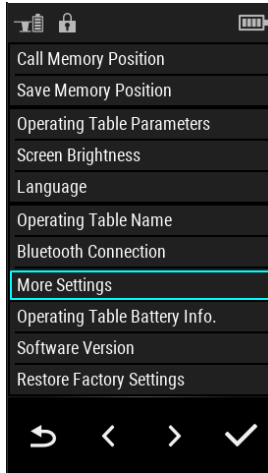

■ Smart Backlit Keypad

Enter [**Smart Backlit Keypad**] via the selective button (◀ or ▶)→press [**Enabled**] or [**Disabled**]→press the button below the symbol .

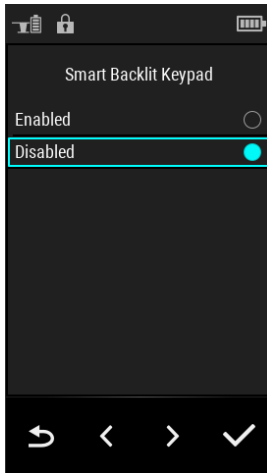

■ Switch-on Mode

Enter [**Switch-on Mode**] via the selective button (◀ or ▶)→select [**Any button**] or [**Standby button**]→press the button  below the symbol .

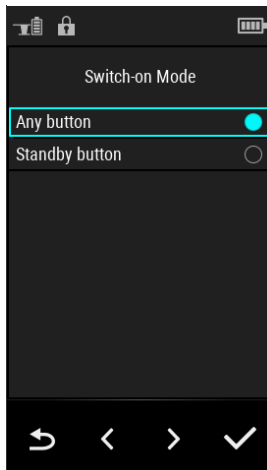

■ Foot Switch Function

See the operator's manual of foot switch for details.

■ Color-coded Indication

Enter [**Color-coded Indication**] via the selective button (< or >).

1. Select [**Enabled**] or [**Disabled**] to enable or disable the function.
2. Once enabled, press [**Parameter Setting**] to access the indication value setting.

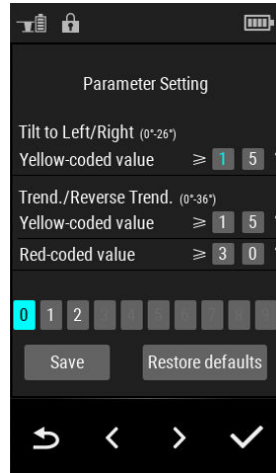
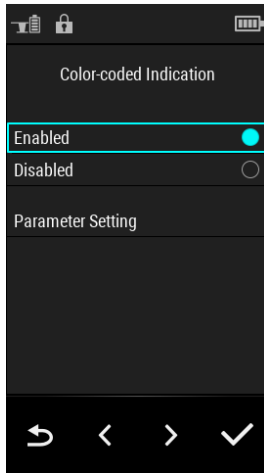

3.3.7.9 Operating Table Battery Information

Select **[Operating Table Battery Info.]** via the selective button (**<** or **>**)→press the button **○** below the symbol **✓** to check the battery status: **[Healthy]** or **[Replacement recommended]**.

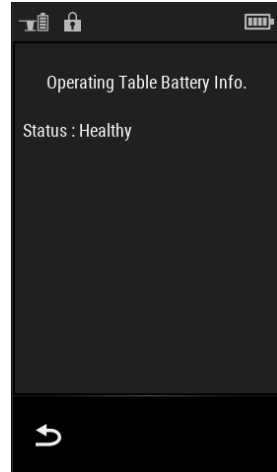

NOTE

- **When the screen shows the message [Replacement recommended], contact the customer service department authorized by Mindray or your local distributor.**



3.3.7.10 Software Version

Select **[Software Version]** via the selective button (**<** or **>**)→press the button

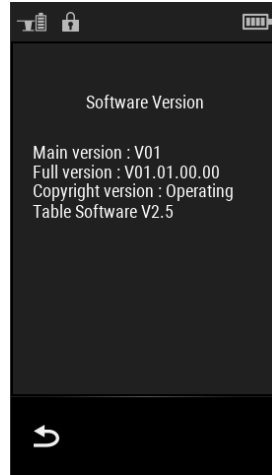
○ below the symbol **✓** to check the software information.



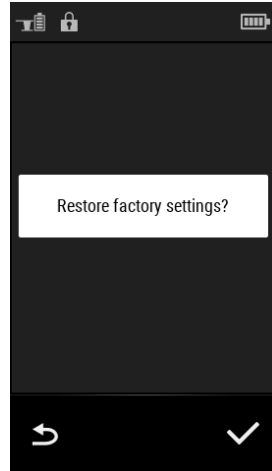

3.3.7.11 Restore Factory Settings

Select **[Restore Factory Settings]** via the selective button (◀ or ▶) → press the button  below the symbol  → the screen prompts the message **[Restore factory settings?]**. Restore factory setting after the confirmation.



3.4 Override Panel

The override panel is located on the column, of which the buttons are the same as those of the hand control except the switch-on button .

After the operating table is switched on, press and hold the switch-on button  and the desired adjustment button at the same time and do not release them until the desired position is reached. Detailed buttons are shown below:

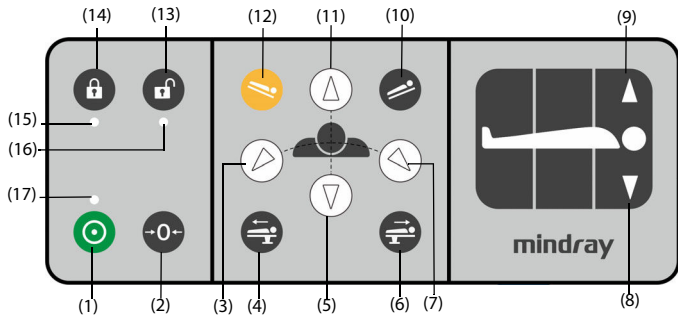

- | | | |
|--|--------------------------|--|
| (1) Switch-on | (2) 0 position | (3) Tilt to left |
| (4) Longitudinal shift toward foot end | (5) Table top down | (6) Longitudinal shift toward head end |
| (7) Tilt to right | (8) Back plate down | (9) Back plate up |
| (10) Reverse Trendelenburg | (11) Table top up | (12) Trendelenburg |
| (13) Unlock | (14) Lock | (15) Locking indicator |
| (16) Unlocking indicator | (17) Switch-on indicator | |

NOTE

- **The override panel is for emergency operation.**
- **The normal/reverse patient orientation is not effective when the override panel is used. If the table top is set to reverse patient orientation, the button operation is the same as that of normal patient orientation. Watch every button adjustment.**
- **Do not perform adjustments with two control units at the same time. If functions are triggered by multiple control units, then all motions except the**





switch-off of the operating table will be stopped immediately and will resume only after none of the control units has been activated. If the override panel is triggered, it takes priority over other control units.

3.4.1 Functions

3.4.1.1 Switch-on

Press the button  to switch on the operating table.



3.4.1.2 Lock/Unlock

1. Lock: press and hold the  and  buttons for two seconds. It takes about six seconds to lock the operating table.
2. Unlock: press and hold the  and  buttons for two seconds. It takes about six seconds to unlock the operating table.





WARNING

- **Before locking the operating table, ensure that there are neither the operator's feet nor any objects underneath the base. Otherwise, personal injury or equipment damage may occur.**
 - **The adjustment of table top up, tilt or longitudinal shift is restricted after the operating table is unlocked.**
-

3.4.1.3 One-button to 0 position

Press and hold both  and  buttons to restore the operating table to 0 position.

3.4.1.4 Longitudinal Shift

1. Longitudinal shift toward head end: press and hold  and  buttons.
2. Longitudinal shift toward foot end: press and hold  and  buttons.

3.4.1.5 Table Top Up/Down

1. Table top up: press and hold  and  and  buttons.

2. Table top down: press and hold  and  and  buttons.

WARNING



- **During the table top down process, there is a risk of crushing and shearing to the feet or objects placed on the base. Before lowering the table top, ensure that there are neither the operator's feet nor any objects underneath the column.**
-
-



3.4.1.6 Tilt

1. Tilt to left: press and hold  and  and  buttons.

2. Tilt to right: press and hold  and  and  buttons.

3.4.1.7 Slope

1. Trendelenburg: press and hold  and  buttons.

2. Reverse Trendelenburg: press and hold  and  buttons.

WARNING

- **Ensure the patient is properly secured in case of sloped position when adjusting the operating table. Otherwise, personal injury or device damage may occur.**
-
-

3.4.1.8 Back Plate Up/Down

1. Back plate up: press and hold  and  buttons (9).

2. Back plate down: press and hold  and  buttons (8).

3.4.1.9 Indicator on Override Panel

Indicators on the override panel are described below:

Indicator	Status	Description
Switch-on indicator	Green	The operating table is switched on.
Locking indicator	Green and flashing	Locking in progress
	Green	Locked
Unlocking indicator	Red and flashing	Unlocking in progress
	Red	Unlocked
Locking indicator and unlocking indicator	Locking indicator (green) and unlocking indicator (red) flash at the same time.	The operating table is under the intermediate status of locking and unlocking.

3.5 Foot Pump (optional)

Foot pump can be used to adjust the table-top movements. The function can be realized by the pedal (1) and knob (2) at the base. 12 movements at most can be accomplished by the foot pump.

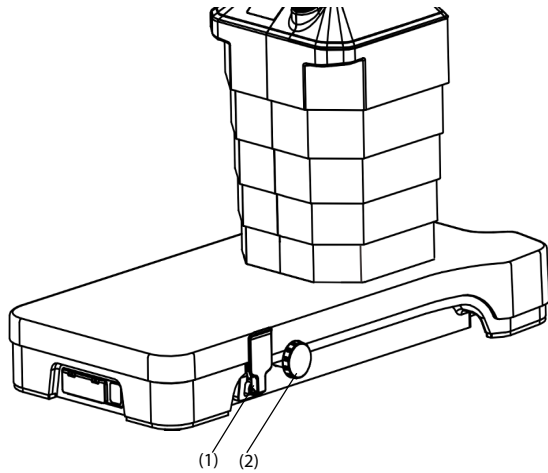

To use the foot pump,

1. Turn the knob until the arrow above is aligned with the desired movement label.
2. Step the pedal repeatedly until the desired function has been reached.

NOTE

- **When using the foot pump to lock the castors, step the pedal and do not release your foot until the locking is finished. It takes about six seconds to fully lock the operating table.**
-

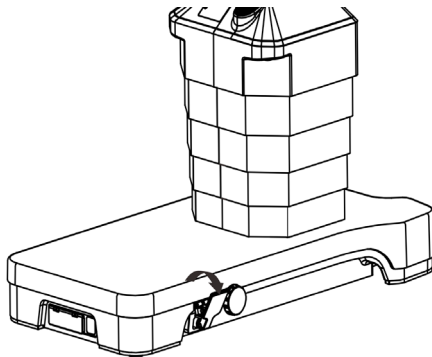

3.6 Body Elevator with Hand Crank (optional)

To use the body elevator with the hand crank:

1. Install the hand crank (1) onto either side of the hole on the operating table.
2. Raise or lower the body elevator by rotating the hand crank.

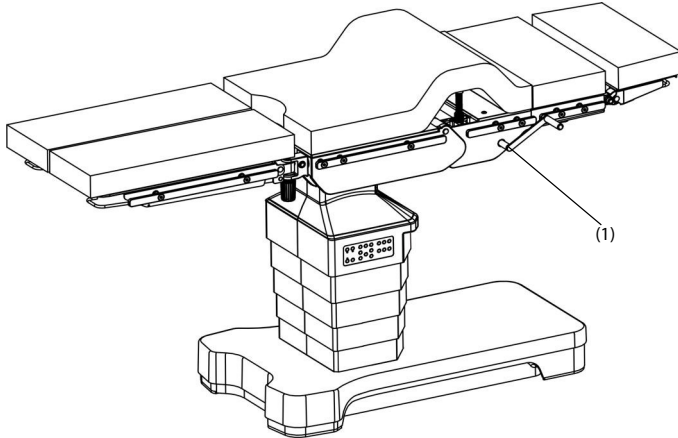

3.7 Remote Control Interface (optional)

The operating table can provide a remote control interface to realize the remote control function. See the communication protocol for details.

3.8 Manual Brake Release

In case of the control unit and override panel failure, execute the manual brake release.

1. Loosen two screws (2) fixing the base cover on both sides. Lift the base cover (1).
2. Insert the proper Allen key into two adjustment holes (3) of one castor and turn it clockwise until it can no longer be turned. Then insert the Allen key into two adjustment holes that are in a diagonal castor and then turn it clockwise. Finally adjust the holes of other two castors until the operating table is unlocked.

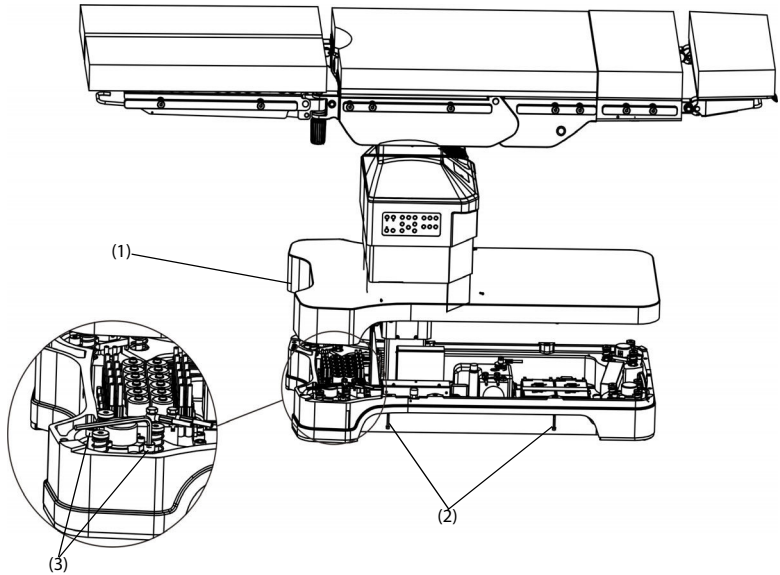

NOTE

- **Keep the screws fixing the base cover for reinstallation use.**
-

3. Reinstall the base cover after the operating table is unlocked.

3.9 Foot Switch

Connect or disconnect the foot switch in the same way as the corded hand control. See **3.3.1 Connecting /Disconnecting Corded Hand Control**. For more details, see the operator's manual of foot switch for details.

3.10 Table-top Modules

WARNING

- **When removing/installing the head plate, upper back plate or leg plate, be sure to grasp it with both hands. Otherwise, it may fall and cause personal injury and/or property damage.**
- **When using the head plate, upper back plate or leg plate, be sure to cover it with a sterile surgical drape to avoid infection.**

- **Be sure to use the pad delivered with head plate, upper back plate or leg plate. Otherwise, patient injury may occur during the table top movement.**
-

3.10.1 Head Plate

3.10.1.1 Installation

1. Hold the head plate (1) with both hands. Insert both joints (2) fully into the mounting points (3) until a click is heard.
2. Slightly pull the head plate and check if it is reliably installed.

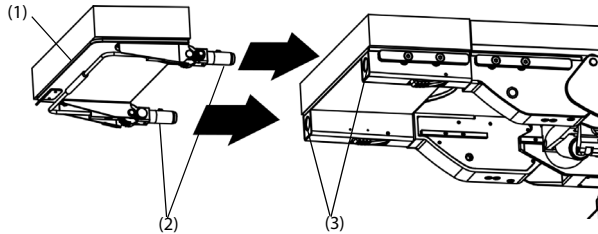

3.10.1.2 Removal

1. Hold the head plate with both hands and press the release buttons (4) on both front ends.
2. Pull the head plate out slowly without tilting.

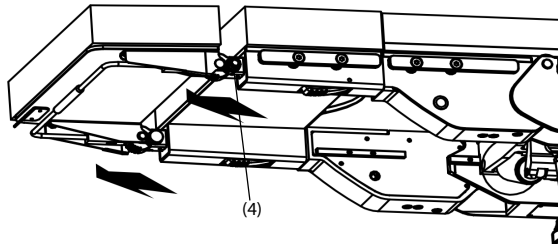

3.10.1.3 Angle Adjustment

1. Hold the head plate with one hand and pull the grip (5) in the middle of the release bracket with the other hand. Raise or lower the head plate to the desired position.
2. Release the bracket.
3. Pull the head plate to check whether it has been adjusted properly.

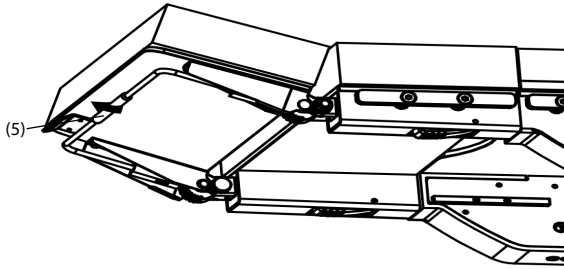

WARNING

- **When lowering the head plate, be sure to adjust it slowly and carefully. Ensure the head plate keeps stable during the adjustment to avoid patient injury.**
-
-

NOTE

- **Do not install such devices as arm boards, anesthesia frames and infusion holders on the head plate. Otherwise, the head plate may move unexpectedly and cause personal injury or equipment damage.**
-
-

3.10.2 Upper Back Plate

3.10.2.1 Installation

1. Hold the upper back plate (1) with both hands. Insert both joints (2) fully into the mounting points (3) until a click is heard.
2. Slightly pull the upper back plate and check if it is reliably installed.

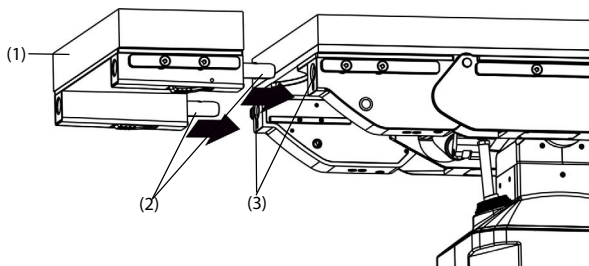

3.10.2.2 Removal

1. Hold the upper back plate with both hands and press the release levers (4) on both front ends.
2. Pull the upper back plate out slowly without tilting.

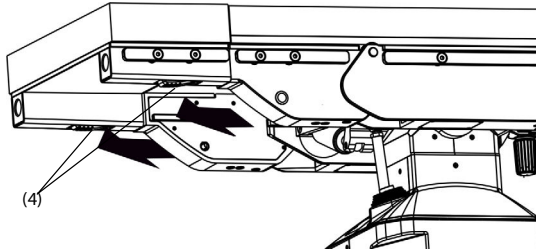

3.10.3 Leg Plate

3.10.3.1 Installation

1. Hold the leg plate (1) with both hands. Insert the joint (2) fully into the mounting point (3) until a click is heard.
2. Slightly pull the leg plate and check if it is reliably installed.

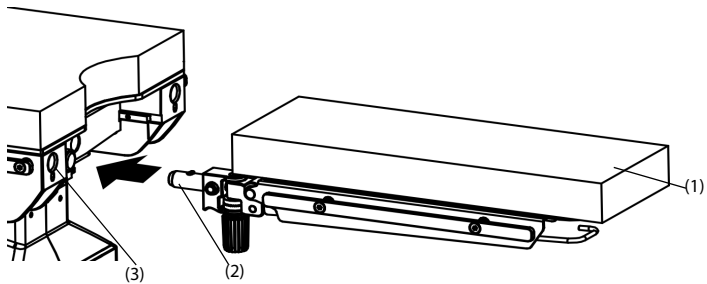

3.10.3.2 Removal

1. Hold the leg plate with both hands and press the release button (4).
2. Pull the leg plate out slowly without tilting.

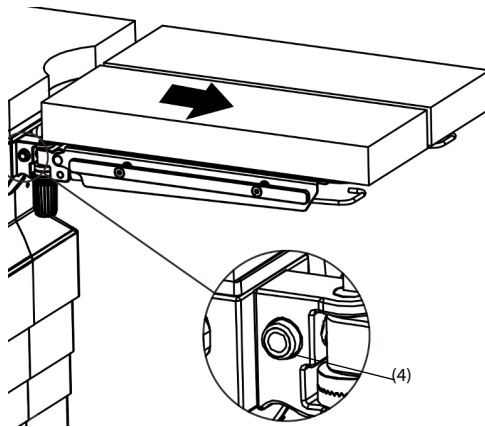

3.10.3.3 Adjustment

■ To adjust the leg plate up/down:

1. Hold the leg plate and press the release bracket (5) upward.
2. Raise or lower the leg plate to the desired position.
3. Release the leg plate and the release bracket (5).

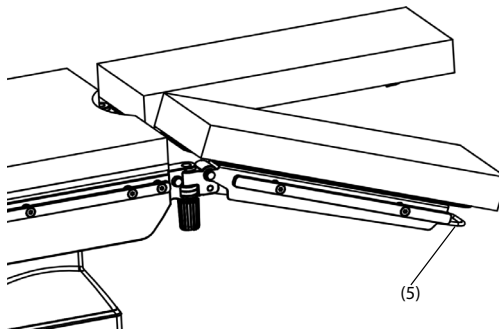

■ To abduct the leg plate:

1. Loosen the handle screw (6).
2. Abduct the leg plate to the desired position.

3. Tighten the handle screw (6).

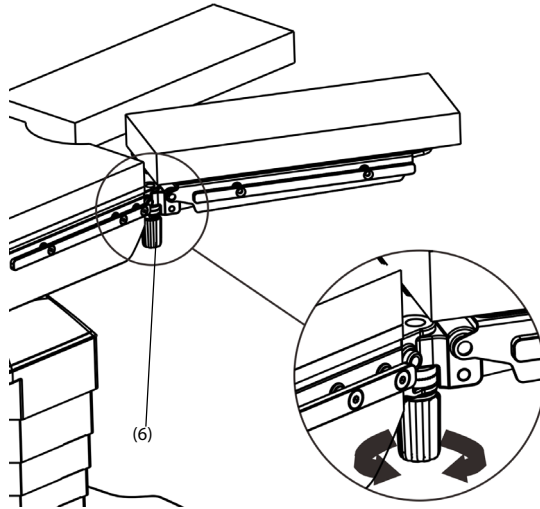

3.10.4 Pad

WARNING

- Each time before using the pad, check it carefully. Damaged pad must be replaced immediately.
 - Do not use the worn or damaged pad. Liquid can penetrate damaged pad and cause hygienic problems.
 - The patient may slip off the operating table if the pad is not secured properly to the surface.
-
-

CAUTION

- Ensure the Velcro strap is not damaged or wet before installing the pad. Otherwise, the pad cannot be reliably installed.
 - Ensure the pad is affixed flat and reliably. Otherwise, personal damage may occur.
 - Do not place sharp objects on the pad. Otherwise, the pad may be damaged.
-
-

NOTE

- Pad should be stored lying flat and horizontal.

- **When removing the pad, be sure to grasp it with both hands.**
-

3.10.4.1 Installation

1. Ensure the pad is fully aligned with the table top.
2. Check if the pad is affixed flat and reliably.

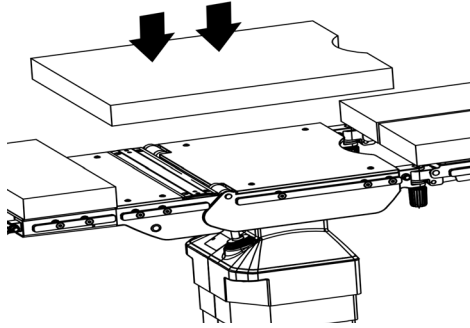

3.10.4.2 Removal

When removing the pad, be sure to grasp it with both hands.

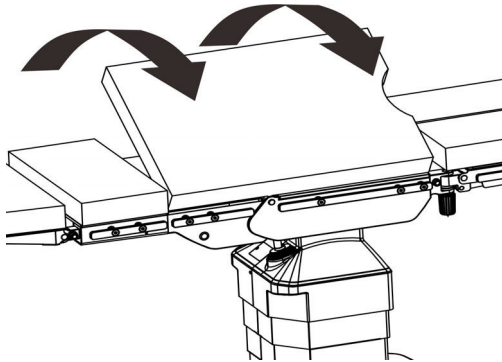

3.11 Equipment Preparation

Check the following items before use:

- The operating table is placed on a smooth ground.
- When running on mains power, ensure the equipment is connected to AC power outlet with protective earth.
- When running on battery power, ensure the battery capacity is sufficient.
- The operating table is locked.

WARNING

- **Before using the equipment, the user must verify that the equipment, connecting cables and accessories are in correct working order and operating condition.**
 - **Do not use the operating table if it is damaged or cannot work properly. Contact service personnel or Mindray.**
-
-

4 Table Top Configuration

4.1 General

The operating table can be used together with different modular table tops and accessories, which makes different positioned patients suitable for different surgeries.

The table top is radiolucent and enables the intraoperative use of x-ray equipment.

WARNING

- **Be sure to select the proper patient orientation and accessories according to patient weight and overall load.**
-
-

NOTE

- **Position patients preferably in normal patient orientation on the table top.**
-
-

4.2 With an Overall Load between 250kg and 460kg

With an overall load of more than 250kg, the operating table should be used with the following restrictions:

1. Lock the castors.
2. Position the patient to the normal patient orientation.
3. Do not operate the longitudinal shift.
4. Trendelenburg/reverse Trendelenburg: $\leq 15^\circ$
5. Tilt to left/right: $\leq 5^\circ$
6. Back plate up: $\leq 70^\circ$
7. Back plate down: $\leq 10^\circ$

Accessories used together with the table top are shown below:

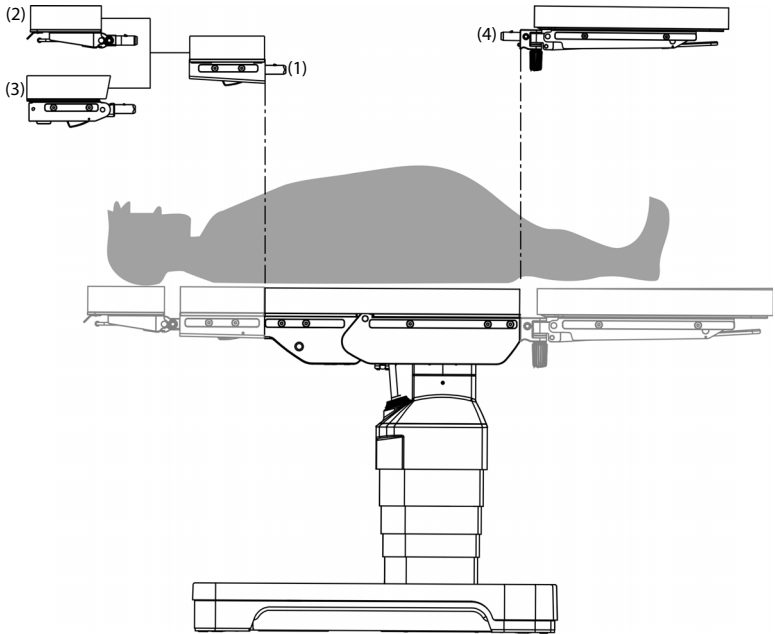

(1)Upper back plate

(2)Head plate

(3)2-joint head plate

(4)Leg plate

4.3 With an Overall Load between 155kg and 250kg

With an overall load of more than 155kg and no more than 250kg, the operating table should be used with the following restrictions:

1. Lock the castors.

Accessories used together with the table top are shown below:

- Normal patient orientation

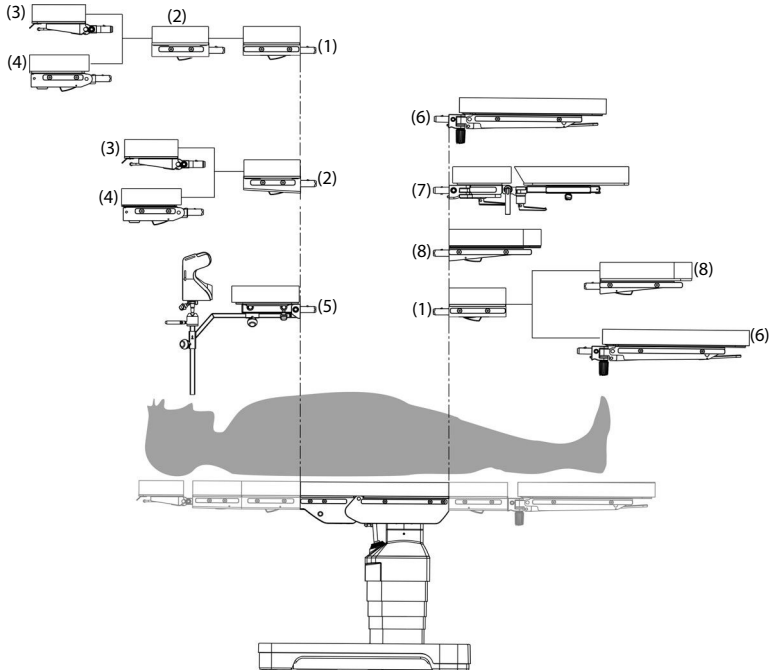

- | | | |
|------------------------|---------------------------------------|----------------|
| (1) Extension plate | (2) Upper back plate | (3) Head plate |
| (4) 2-joint head plate | (5) Back plate for shoulder operation | (6) Leg plate |
| (7) 4-part leg plate | (8) One-section leg plate | |

■ Reverse patient orientation

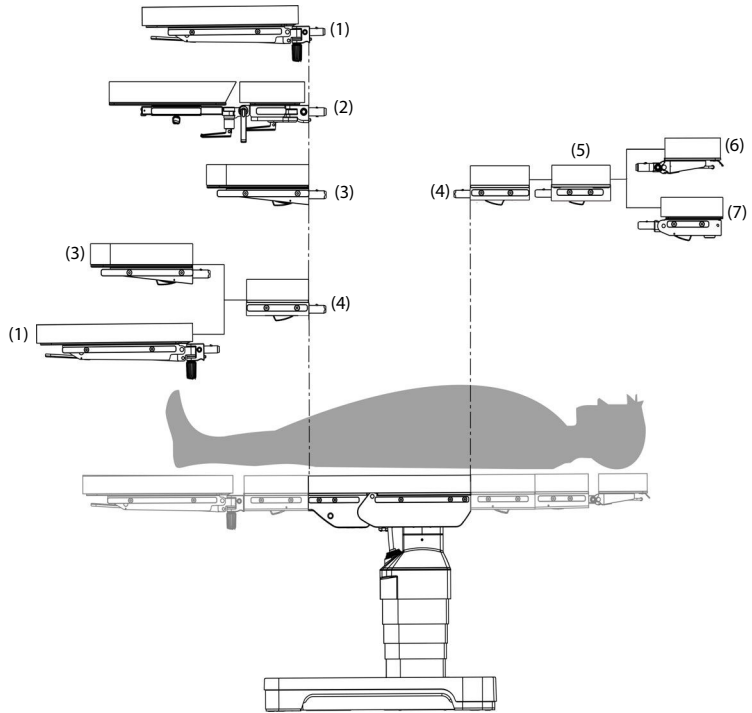

(1) Leg plate

(2) 4-part leg plate

(3) One-section leg plate

(4) Extension plate

(5) Upper back plate

(6) Head plate

(7) 2-joint head plate

4.4 With an Overall Load Less Than 155kg

With an overall load of less than 155kg, the table top should be used with the following accessories when castors are locked:

- Normal patient orientation

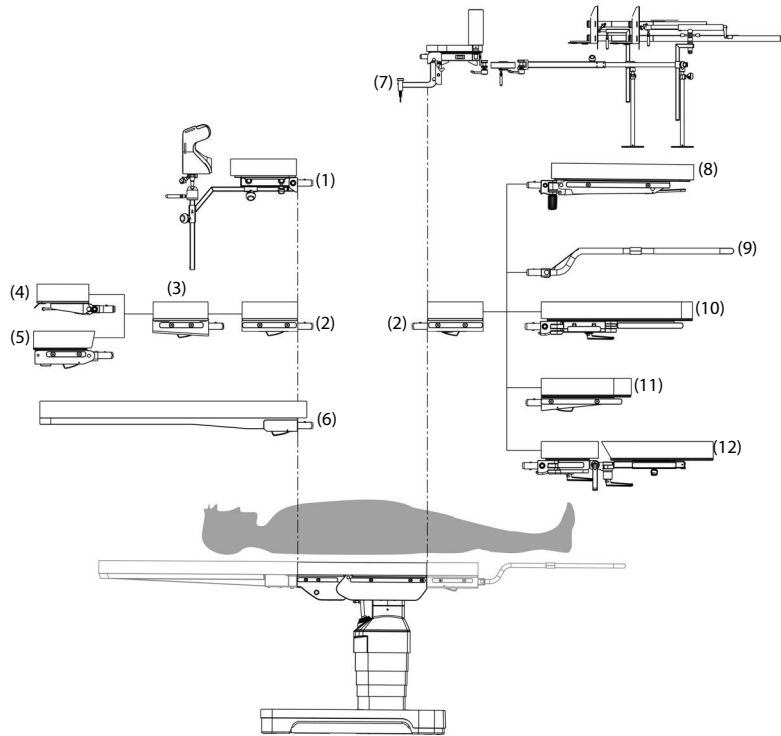

(1) Back plate for shoulder operation

(2) Extension plate

(3) Upper back plate

(4) Head plate

(5) 2-joint head plate

(6) Carbon fiber cardiac operating plate

(7) Orthopedic extension device

(8) Leg plate

(9) Transfer board device

(10) 2-joint leg plate

(11) One-section leg plate

(12) 4-part leg plate

■ Reverse patient orientation

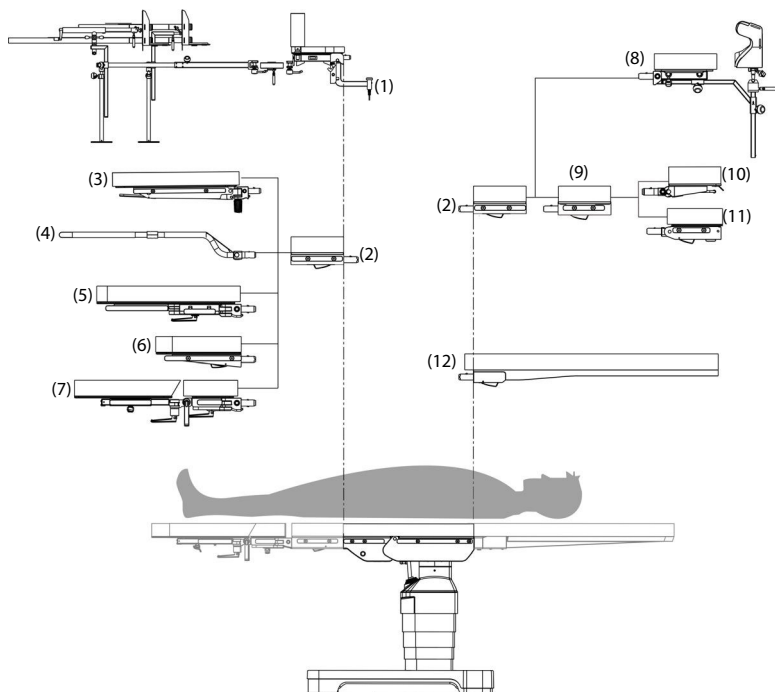

(1) Orthopedic extension device

(2) Extension plate

(3) Leg plate

(4) Transfer board

(5) 2-joint leg plate

(6) One-section leg plate

(7) 4-part leg plate

(8) Back plate for shoulder operation

(9) Upper back plate

(10) Head plate

(11) 2-joint head plate

(12) Carbon fiber cardiac operating plate

5 Cleaning and Disinfection

5.1 Safety Information

The product must be cleaned and disinfected after every use.

WARNING

- **Use only Mindray approved cleaners and disinfectants and methods listed in this chapter to clean or disinfect your equipment. Warranty does not cover damage caused by unapproved substances or methods.**
 - **Do not mix disinfecting solutions as hazardous gases may be generated.**
 - **We make no claims regarding the efficacy of the listed chemicals or methods as a means for controlling infection. For the method to control infection, consult your hospital's infection control officer or epidemiologist.**
 - **Agents containing alcohol can form explosive vapor mixtures and ignite where high-frequency equipment is being used. Do not use the cleaners or disinfectants containing alcohol where high-frequency surgical equipment may be used.**
 - **Always wear gloves for cleaning and disinfection. Neglect of this may cause infection.**
 - **Be sure to disconnect the power supply before cleaning and disinfection.**
 - **Do not put hands into the gaps when cleaning /or disinfecting the table top. Otherwise, you may be pinched.**
 - **The responsible hospital or institution shall carry out all cleaning and disinfection procedures specified in this chapter.**
-
-

CAUTION

- **Do not clean/disinfect the operating table mechanically.**
 - **Never immerse any part of the equipment or accessories in liquids.**
 - **Particles of grime may become encapsulated and lead to the product not reaching the desired germ-reduction after disinfection. Before disinfection, the product must be cleaned thoroughly of contamination and encapsulated particles of grime and then be dried.**
-
-

- **Any contact of cleaners or disinfectants with connectors may cause corrosion.**
 - **Do not pour or spray any liquid directly on the equipment or accessories or permit fluid to seep into live parts inside the equipment.**
 - **If you spill liquid on the equipment or accessories, disconnect the power supply, dry the equipment and contact your service personnel.**
 - **Improper cleaning/disinfection can damage the operating table. Do not spray the cleaning agent/disinfectant directly into the joints or gaps. Do not use high pressure to clean/disinfect components.**
 - **Never use abrasive materials (such as steel wool or silver polish), or strong solvent (such as acetone or acetone-based cleaners) for cleaning.**
 - **Do not use polish or steel cleaner to clean or disinfect stainless steel surfaces.**
 - **Dilute and use the cleaners or disinfectants according to the manufacturer's instructions.**
-

NOTE

- **Be sure to follow the related national hygiene and disinfection regulations to carry out cleaning and disinfection procedures.**
 - **Check the equipment or accessories after cleaning and disinfection. Stop the use if there is any sign of wear or damage.**
-

5.2 Cleaning

5.2.1 Preparation before Cleaning

1. Adjust the operating table to 0 position.
2. Lift the table top to the highest position.
3. Switch off the operating table and disconnect the power cord.

5.2.2 Cleaning Procedure

1. Use a piece of lint-free clean cloth to wipe off the dust gently and thoroughly.
2. Use a piece of lint-free cloth moistened with cleaner (clean water or soap solution) to wipe the surface.
3. Use a piece of disposable lint-free cloth moistened with water to clean the surface.
4. Use a piece of dry lint-free cloth to wipe the surface dry.

NOTE

- Use proper amount of the cleaner to clean the operating table, and remove any excessive agent by the dry cloth.
- Be sure to disinfect the equipment after cleaning.

5.3 Disinfection

5.3.1 Recommended Disinfectants

Disinfect the equipment as required in your hospital's service schedule. Cleaning the equipment before disinfection is recommended. Always dilute and use disinfectants according to the manufacturer's instructions. The following table lists approved disinfectants:

Product name	Product type	Manufacturer
Alpet® D2 Surface Sanitizing Wipes	Wipes	BEST SANITIZERS INC™.
CIDEX® OPA	Liquid	Gilag GmbH International Advanced Sterilization products
Clorox Dispatch® Hospital Cleaner Disinfectant Towels with Bleach	Wipes	Clorox professional products company
Clorox Healthcare® Bleach Germicidal Wipes	Wipes	Clorox professional products company
Metrex CaviCide1™	Liquid, spray	METERX® RESEARCH
Metrex CaviWipes™	Wipes	METERX® RESEARCH
PDI Sani-Cloth® AF3 Germicidal Disposable Wipe	Wipes	PDI Inc.
PDI Sani-Cloth® HB Germicidal Disposable Wipe	Wipes	PDI Inc.
PDI Sani-Cloth® Plus Germicidal Disposable Cloth	Wipes	PDI Inc.
PDI Super Sani-Cloth® Germicidal Disposable Wipe	Wipes	PDI Inc.
Virex® II 256 (1:256)	Liquid	Diversey Inc

Product name	Product type	Manufacturer
Rely+On™ Virkon® High Level surface Disinfectant, 1%	Powder	Antec International Ltd
Clinell® Universal Wipes	Wipes	GAMA Healthcare Ltd
Clinell® Sporidical Wipes	Wipes	GAMA Healthcare Ltd
Tristel Duo™	Liquid, foam	Tristel solutions Limited
Tristel Jet	Liquid, spray	Tristel solutions Limited
Surfanios Premium, 0.25%	Liquid	ANIOS LABORATORIES
Surfa 'safe	Liquid, spray	ANIOS LABORATORIES
Aniosurf ND premium, 0.25%	Liquid	ANIOS LABORATORIES
mikrozid® Sensensitive Wipes	Wipes	Schülke & Mayr GmbH
mikrozid® AF Wipes	Wipes	Schülke & Mayr GmbH
Terralin® Liquid	Liquid	Schülke & Mayr GmbH
JIAN ZHI SU Disinfectant Tablets	Tablet	Beijing ChangJiangMai Medical Science Technology Co. Ltd
JIAN ZHI SU Surface Disinfectant Spray	Liquid, spray	Beijing ChangJiangMai Medical Science Technology Co. Ltd
DIAN'ERKANG Surface Disinfectant	Liquid	Shanghai Likang Disinfectant Hi-Tech Co., Ltd
DIAN'ERKANG Surface Wipes	Wipes	Shanghai Likang Disinfectant Hi-Tech Co., Ltd
DIAN'ERKANG Disinfectant Spray	Liquid, spray	Shanghai Likang Disinfectant Hi-Tech Co., Ltd
Glutaraldehyde, 2%	Liquid	/
Ethanol, 70%	Liquid	/
Isopropanol, 70%	Liquid	/

Product name	Product type	Manufacturer
Hydrogen peroxide, 3%	Liquid	/
1-Propanol, 50%	Liquid	/
Domiphen, 2000mg/L	Liquid	/

5.3.2 Disinfection Procedure

1. Use a piece of lint-free cloth moistened with disinfectant to wipe the surface.
2. Use a piece of disposable lint-free cloth moistened with water to clean the surface.
3. Use a piece of dry lint-free cloth to wipe the surface dry.

CAUTION

- **Do not disinfect the equipment by fumigation methods. Otherwise, the equipment may be damaged.**
 - **Do not use the disinfectants containing chlorine or compounds which can release chlorine to disinfect the metal parts. Long-term use of these disinfectants may corrode the metal parts, hence compromising safety and effectiveness of the device. It is recommended that metal parts be disinfected by 2% alkaline glutaraldehyde.**
-

5.4 Pad Cleaning and Disinfection

WARNING

- **Do not use the worn or damaged pad. Liquid can penetrate damaged pad and cause hygienic problems.**
-

CAUTION

- **Be sure to replace damaged pad immediately.**
 - **Moisture may cause damage to pad.**
 - **Do not use the disinfectant containing chlorine or compounds which can release chlorine.**
 - **The adhesive force of the Velcro strap may be compromised due to contamination. It is recommended a plastic soft brush or a plastic comb be used to remove the contamination.**
-

5.4.1 Cleaning Procedure

1. Remove the pad.
2. Use a piece of lint-free cloth moistened with cleaner (clean water or soap solution) to wipe the pad and then dry the surface.

5.4.2 Disinfection Procedure

1. Use a piece of lint-free cloth moistened with disinfectant (as described in **5.3.1 Recommended Disinfectants**) to wipe the surface.
2. Use a piece of disposable lint-free cloth moistened with water to clean the surface.
3. Use a piece of dry lint-free cloth to wipe the surface dry.

NOTE

- **When removing the pad, be sure to grasp it with both hands.**
 - **Pad should be stored lying flat and horizontal.**
 - **Before installing the pad, ensure that the table top, pad and Velcro Strap are dry.**
-

6 Maintenance

Regular maintenance is essential to ensure that the equipment functions properly. This chapter contains information on equipment maintenance method and frequency.

6.1 Maintenance Safety Information

WARNING

- To avoid electric shock, stop using the equipment if you find the housing has signs of damage. Contact the service personnel for help in that case.
 - Failure on the part of the responsible individual hospital or institution using this equipment to implement a recommended maintenance schedule may cause undue equipment failure and possible health hazards.
 - If you have any questions during the inspection, contact the customer service department authorized by Mindray.
 - The device maintenance that requires disassembling shall be performed by the professional service personnel authorized by Mindray. Otherwise, device failure or personal safety accidents may occur.
 - The service personnel must be properly qualified and thoroughly familiar with the operation of the equipment.
-
-

CAUTION

- The equipment and accessories shall not be tested or maintained while in use with a patient.
 - If you discover a problem with any of the equipment, contact your service personnel or Mindray.
-
-

NOTE

- This equipment contains no user serviceable parts. Refer servicing to qualified service personnel.
 - If needed, contact Mindray for circuit diagrams, component part lists, descriptions, calibration instructions, or other information concerning the repair of the equipment.
-
-

6.2 Maintenance Schedule

Follow the maintenance schedule or local regulations to perform maintenance. Be sure to clean and disinfect the equipment before test or maintenance. The following table lists the maintenance and testing schedule:

Test/Maintenance Item		Recommended Frequency
Visual inspection		Every day, before first use.
Switch-on test		Each time the operating table is switched on.
Battery maintenance	Functional test	1. When first installed. 2. When the battery is replaced.
	Performance test	Every three months or when the battery runtime reduced significantly
Hydraulic oil replacement		Every five years recommended

6.3 Testing Methods and Procedures

Except the following maintenance tasks, all other test and maintenance tasks should be performed by Mindray's qualified service personnel only.

- Regular check, including visual inspection and switch-on test
- Battery maintenance

If the operating table needs other test and maintenance, contact the service personnel.

6.3.1 Visual Inspection

Visually inspect the equipment before its first use every day. If you find any signs of equipment or accessory damage, stop using it and contact the service personnel.

Visual inspection items are as follows:

- Environment and power supply specifications are met.
- The equipment surface has not any stain. The override panel and hand control are free from cracks or damages.
- Mechanical parts are not damaged.
- Connectors, plugs and cables are not damaged and kinked.
- Cables are securely connected with the equipment.
- Pads are not damaged and firmly fixed on the table top.
- The operating table has no oil leakage.
- The operating table has no obvious vibration.

6.3.2 Switch-on Test

Check the following items after the operating table is switched on:

- The equipment can be switched on properly.
- The operating table works properly: table up/down, tilt, slope, longitudinal shift, back plate up/down, lock/unlock
- The hand control displays properly.

6.3.3 Battery Maintenance

6.3.3.1 Battery Safety Information

WARNING

- **Use specified batteries only. Use of different batteries may present a risk of fire or explosion.**
 - **Do not crush, drop or puncture the battery. Mechanical abuse may lead to internal damage and internal short circuits. If a battery has been dropped or banged against a hard surface, whether damage is externally visible or not, remove the battery from use and dispose of it properly.**
 - **If the battery shows signs of damage or leakage, replace it immediately.**
 - **The battery must only be installed and replaced by service personnel trained and authorized by Mindray. Installation or replacement by untrained personnel may cause personal injury (e.g. batteries overheated, ignited or exploded).**
 - **Extremely high ambient temperature may cause battery overheat protection, resulting in interruption of power supply.**
 - **Do not open the battery, heat the battery above 60 °C, incinerate battery, or short battery terminals. They may ignite, explode, leak or heat up, causing personal injury.**
-
-

CAUTION

- **Remove the battery if it will not be used for an extended period of time. Contact the customer service personnel authorized by Mindray or local distributor.**
 - **Storing the battery at high temperature for a long period of time will significantly shorten its life expectancy.**
-

NOTE

- **Battery runtime depends on equipment configuration and operation. For example, high brightness of the screen or repeated operation will shorten the battery runtime.**
-

6.3.3.2 Functional Test

The built-in rechargeable lead-acid battery ensures normal use of the operating table without external power supply. Once the external power supply is connected, the battery will be charged automatically. See **3.2.2 Charging Batteries** for details.

The built-in rechargeable lithium-ion battery ensures normal use of the wireless hand control without external power supply. Use the mobile charging station to charge the wireless hand control. See **3.3.6.2 Charging Wireless Hand Control** for details.

6.3.3.3 Optimizing Batteries

Life expectancy of a battery depends on how frequent and how long it is used. The performance of a rechargeable battery deteriorates over time.

It is recommended the battery be optimized every three months. Use the battery with its remaining capacity indicated the last bar before optimization. Optimize the battery as shown below:

- Operating table battery
 1. Switch off the operating table and connect it to AC power.
 2. Charge the battery uninterruptedly until it is fully charged. It takes about 10 hours to fully charge the battery.
 3. Then disconnect it from AC power.

NOTE

- **If the battery is not maintained for a prolonged time, its capacity indication may not be accurate and you may wrongly evaluate the remaining battery runtime. In addition, the battery is subject to regular maintenance. Otherwise, aging may be accelerated and unexpected failure may occur.**
 - **Do not use the operating table during battery optimization.**
 - **Do not interrupt the battery optimization.**
-

- Battery of wireless hand control

It is recommended the battery be optimized every three months if the wireless hand control has not been used for a long period. Optimize the battery as shown below:

1. Connect the mobile charging station to AC power.
2. Switch off the wireless hand control and insert it into the mobile charging station and charge the wireless hand control uninterruptedly until it is fully charged.

3. Disconnect the wireless hand control from the external AC power and switch it on. Use the wireless hand control to adjust the operating table until the battery of the wireless hand control is completely discharged and the wireless hand control automatically shuts down.
4. Recharge the wireless hand control fully if it is to be used. If the wireless hand control is to be stored, place the battery with 40% to 60% charging capacity.

6.3.3.4 Checking Battery Performance

See steps in **6.3.3.3 Optimizing Batteries** to check the battery performance. The runtime of the battery reflects their performance directly. If the runtime of a battery is noticeably shorter than that stated in the specifications, the battery may reach its service life or malfunction. Contact your service personnel.

6.4 Disposal

Dispose of the equipment when its service life is reached.

WARNING

- **At the end of its service life, the equipment, as well as its accessories, must be disposed of in compliance with the local regulations. If you have any questions concerning disposal of the equipment, please contact Mindray.**
 - **For disposal of parts and accessories, unless otherwise specified, follow local regulations regarding disposal of hospital waste.**
 - **Dispose of the package material as per the applicable waste control regulations. Keep it out of children's reach.**
-
-

This page intentionally left blank.

7 Troubleshooting

7.1 Common Error

WARNING

- **The chapter is meant to help you solve common errors only. In case you encounter problems not included in this chapter or following the introduced methods cannot solve the problem, contact the customer service department authorized by Mindray or your local distributor for help. Unauthorized device servicing is not allowed.**
 - **Device servicing is to be performed by personnel authorized by Mindray only. Unauthorized device servicing may cause personal injury and/or property damage.**
 - **Be sure to disconnect the equipment from AC power when device servicing.**
 - **Device servicing should be strictly based on technical data supplied by Mindray. If you are in need of more technical data, contact the customer service department authorized by Mindray or your local distributor.**
-
-

Error	Cause	Solution
Bluetooth connection of the wireless hand control fails.	1. Fail to start the connection within 20 seconds.	1. Press and hold the Trendelenburg button on the override panel and start the bluetooth connection within 20 seconds.
	2. The operating table is powered off.	2. Press the power button on the base to power on the operating table.
	3. The wireless hand control stays far away from the operating table or there are obstacles between the wireless hand control and operating table.	3. The distance between the wireless hand control and the operating table is no more than 3.5 meters, and there are not any obstacles between the wireless hand control and operating table.
	4. The operating table has been connected with another wireless hand control.	4. Reconnect by following steps of the bluetooth connection.
	5. Bluetooth module fails.	5. Contact the customer service department authorized by Mindray or your local distributor.
Unlock fails.	The unlock button has not been pressed for 2 seconds.	Press and hold the unlock button for two seconds. See 3.3.5.2 Unlock /Lock .
	The operating table fails.	Perform the manual brake release. See 3.8 Manual Brake Release .
Locking indicator (green) and unlocking indicator (red) on the override panel flashes at the same time.	The operating table is in the intermediate state of locking and unlocking.	Perform locking or unlocking again.
Battery indicator on the base is red and flashes.	The second battery bar is red and flashes.	Contact the customer service department authorized by Mindray or your local distributor.
	The third battery bar is red and flashes.	
	The fourth battery bar is red and flashes.	

Error	Cause	Solution
The icon  appears on the screen.	The operating table may have any hardware, sensor or motor errors.	Contact the customer service department authorized by Mindray or your local distributor.

This page intentionally left blank.

A Product Specifications

A.1 Safety Specifications

A.1.1 Product Classification

According to the protection against electrical shock	Class I, internal electrical power source. Type B applied part.
According to the protection against harmful ingress of water or particulate matter	Operating table: IPX5 Mobile charging station (except the adapter): IPX5 Foot switch: IPX8
According to the method(s) of sterilization	Non-sterilization.
According to the suitability for use in an oxygen rich environment	The operating table cannot be used in an oxygen rich environment.
According to the mode of operation	Non-continuous operation: 10 minutes on /20 minutes off

WARNING

- **To avoid the risk of electric shock, this equipment must only be connected to a supply mains with protective earth. Before installing it, check and ensure that the protective earth system in the operating room is reliable and safe.**
-
-

A.1.2 Environmental Specifications

Item	Temperature (°C)	Humidity (non-condensing)	Atmospheric pressure (kPa)
Operating condition	5-40	15%-95%	70-106
Storage condition	-40-60	10%-95%	50-106

CAUTION

- **During transportation, ensure that the operating table is well protected from rain, snow or mechanical collision.**
 - **The operating table should be stored in a room that is dry, draughty and without caustic gas.**
-

A.2 Power Supply Specifications

A.2.1 AC Power

AC power	100-240V~ 50/60Hz 4.0-1.6A
----------	----------------------------

A.2.2 Fuse

Fuse	250V T8AH
------	-----------

A.2.3 Operating Table Batteries

Type	Internal batteries
Voltage	12V×2
Runtime	About one week
Charge time	About 10h
Power-off delay	About 10 minutes of continuous operation after the low battery prompt first occurs

A.3 Wireless Specifications

WARNING

- Do not connect non-medical devices to the operating table network.
 - If wireless network signal is poor, there may be a risk of data loss.
 - RF interference may result in wireless network disconnection.
-
-

A.3.1 Bluetooth

Work frequency	2402-2480MHz
Modulation mode	GFSK
Transmission power	<20dBm

A.3.2 Mobile Charging Station

Work frequency	112-205KHz
Modulation mode	AM
Transmission power	<20dBm

A.4 Load

1. Maximum overall load: 460kg
2. With an overall load of more than 250kg, the operating table should be used with the following restrictions:
 - a Lock the castors.
 - b Position the patient to the normal patient orientation.
 - c Do not operate the longitudinal shift.
 - d Trendelenburg/reverse Trendelenburg: $\leq 15^\circ$
 - e Tilt to left/right: $\leq 5^\circ$
 - f Back plate up: $\leq 70^\circ$
 - g Back plate down: $\leq 10^\circ$
3. With an overall load of more than 155kg and no more than 250kg, the operating table should be used with the following restrictions:
 - a Lock the castors.

A.5 Performance Specifications

1. Base thickness: $140\text{mm} \pm 10\text{mm}$

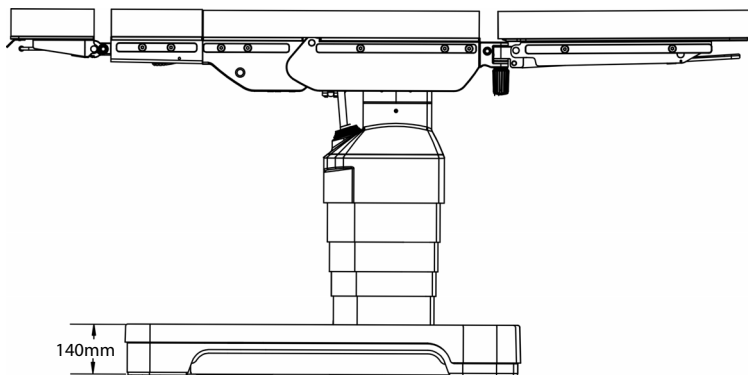

2. Radiolucent distance

- ◆ Maximum radiolucent distance with longitudinal shift toward head end:
 $1007\text{mm} \pm 10\text{mm}$

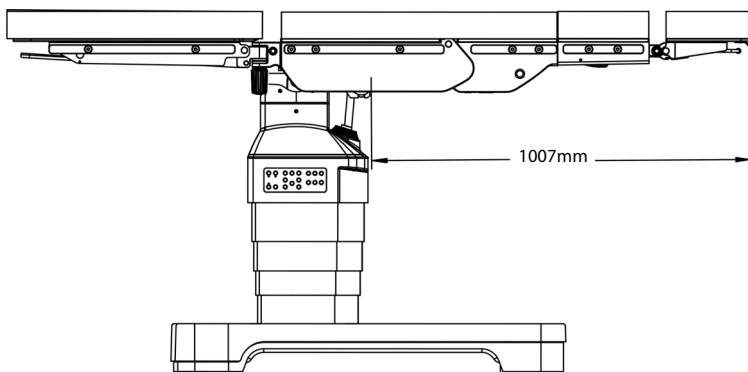

- ◆ Maximum radiolucent distance with longitudinal shift toward foot end:
1013mm±10mm

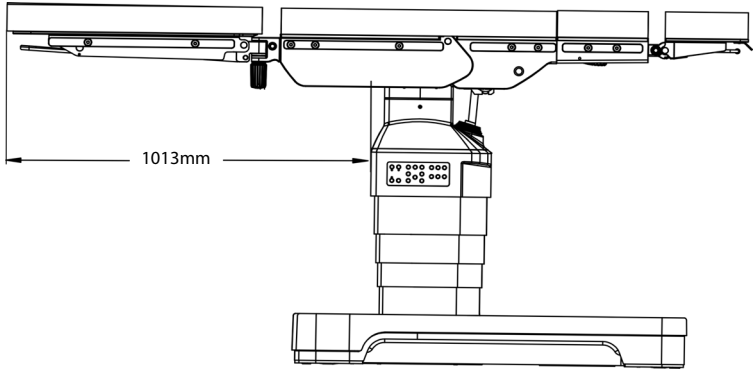

3. Maximum Trendelenburg/reverse Trendelenburg: $36^{\circ} \pm 3^{\circ}$

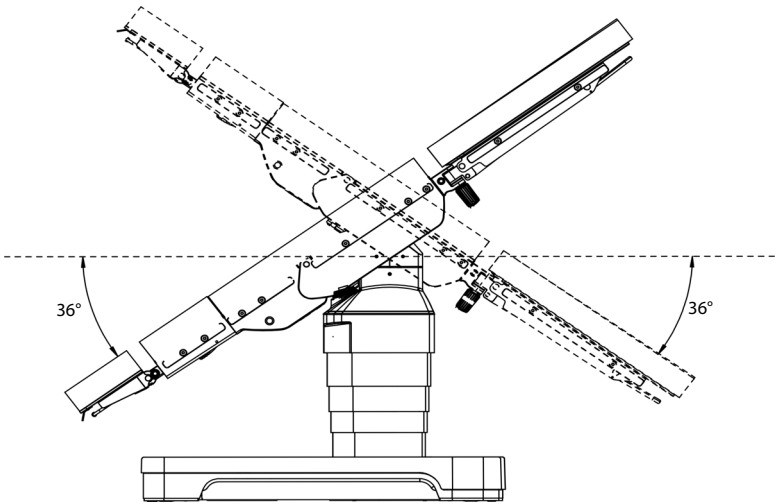

4. Maximum tilt angle: $26^{\circ} \pm 2^{\circ}$

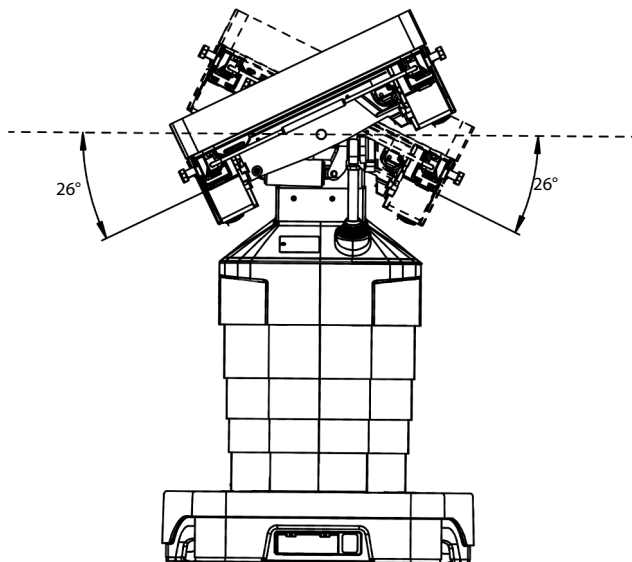

5. Head plate: head plate up: $45^{\circ} \pm 5^{\circ}$, head plate down: $90^{\circ} \pm 5^{\circ}$, detachable

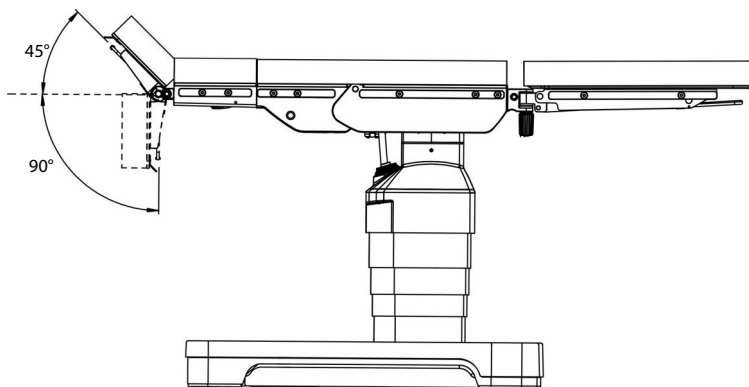

6. Back plate: back plate up: $80^{\circ} \pm 5^{\circ}$, back plate down: $40^{\circ} \pm 5^{\circ}$

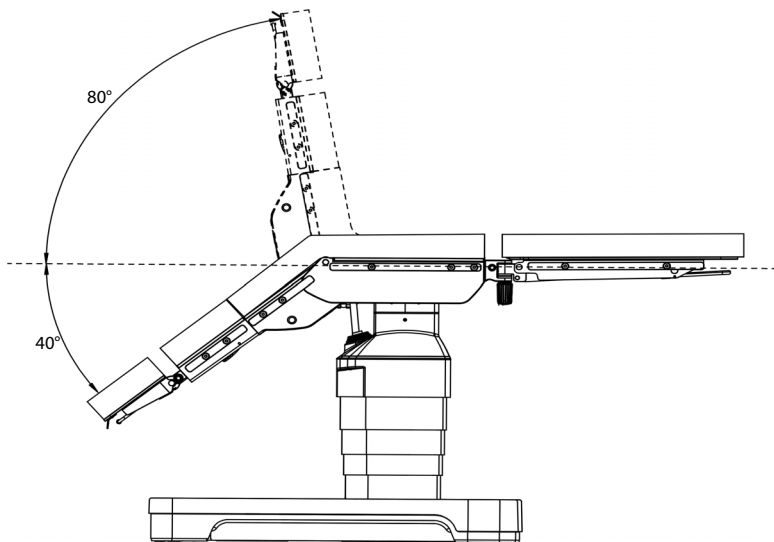

7. Leg plate: leg plate up: $20^{\circ} \pm 5^{\circ}$, leg plate down: $90^{\circ} \pm 5^{\circ}$, detachable

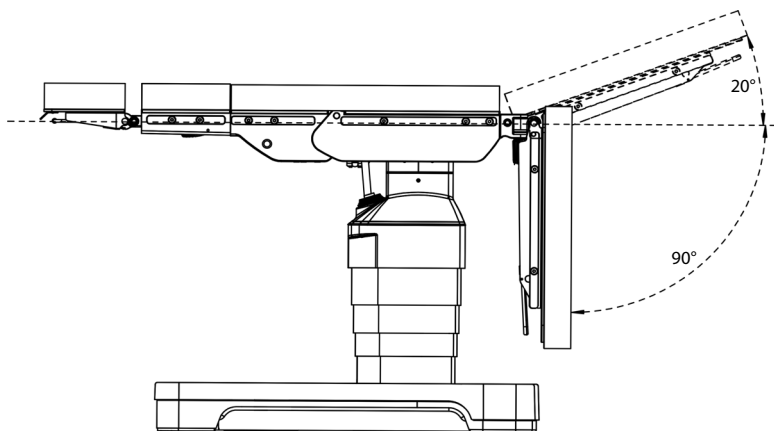

8. Maximum table top lifting height: $450\text{mm}\pm 20\text{mm}$
- ◆ Maximum table top height: $1050\text{mm}\pm 20\text{mm}$
 - ◆ Minimum table top height: $600\text{mm}\pm 50\text{mm}$

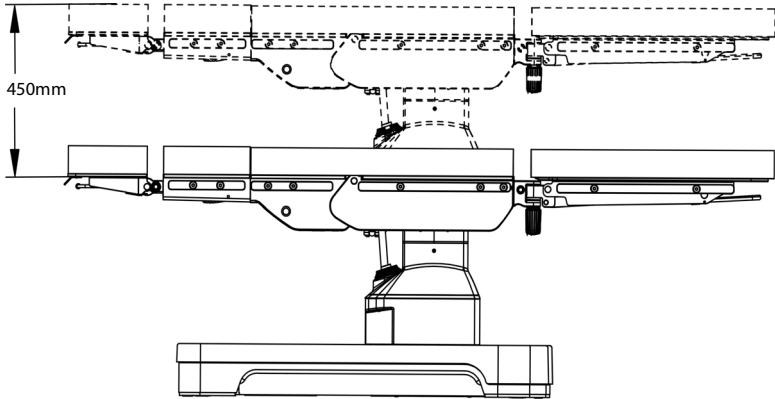

9. Maximum longitudinal shift: $350\text{mm}\pm 10\text{mm}$
- ◆ Longitudinal shift toward head end: $160\text{mm}\pm 10\text{mm}$
 - ◆ Longitudinal shift toward foot end: $190\text{mm}\pm 10\text{mm}$

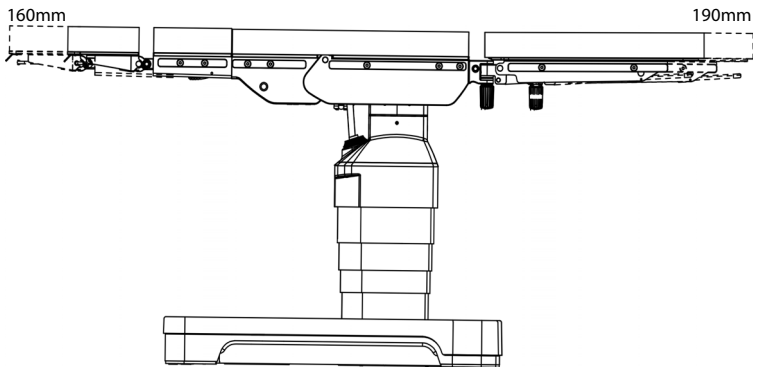

10. Flex position: Reverse Trendelenburg: $20\pm 3^\circ$, back plate down: $40\pm 3^\circ$

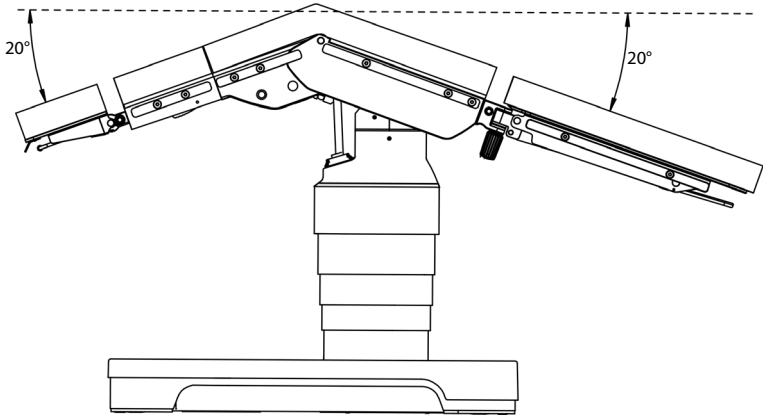

11. Reflex position: Trendelenburg: $30\pm 3^\circ$, back plate up: $70\pm 3^\circ$

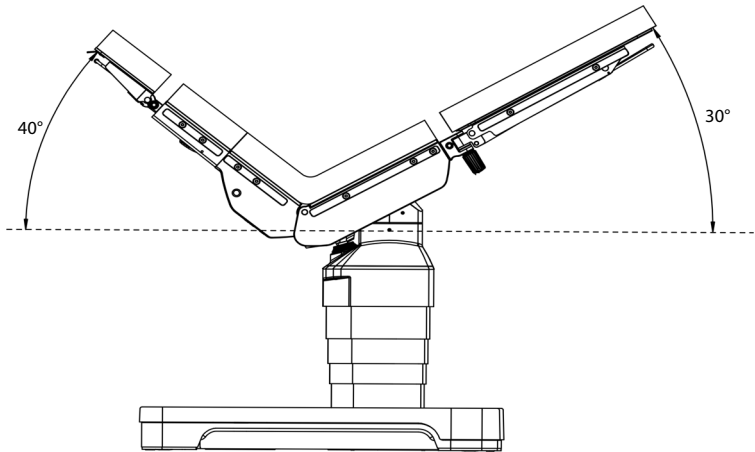

12. Body elevator lifting distance: $120\text{mm}\pm 10\text{mm}$
Body elevator width: $86\text{mm}\pm 10\text{mm}$

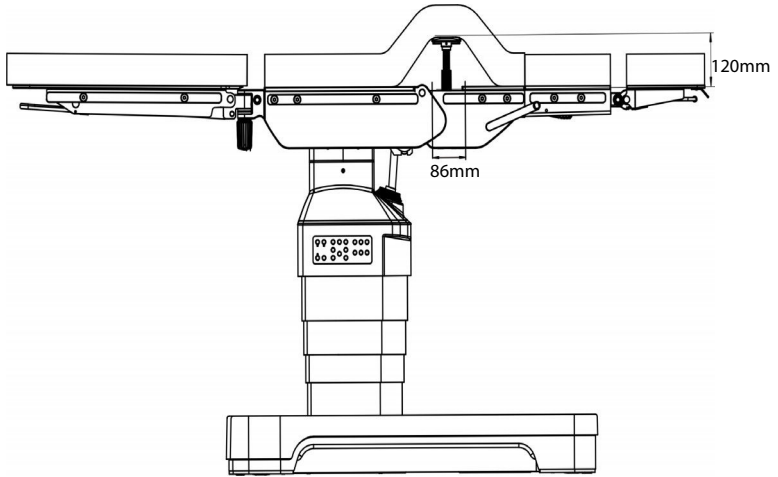

A.6 Accessories and Parts List

Item	Name
1.	Shoulder support
2.	Body support
3.	Suspended arm strap
4.	Leg holder with loops
5.	Arm board
6.	Leg support
7.	Leg holder
8.	Wristlet
9.	Leg restraint cuff
10.	Body strap
11.	Head rest system
12.	Head plate
13.	Table extender
14.	Leg plate
15.	Rectal positioning device
16.	Arm extension device
17.	Foot plate
18.	Leg holder
19.	Stirrup
20.	Meniscus positioning device
21.	Back plate for shoulder operation
22.	Bow frame for spine operation
23.	Orthopaedic extension device
24.	Position pad
25.	Hand grips
26.	Drainage bowl
27.	Side rail extension

Item	Name
28.	Instrument tray
29.	Cassette fixer
30.	Infusion holder
31.	Accessory cart
32.	Anesthesia frame
33.	Clamp
34.	Foot switch
35.	Remote control module

A.7 Electronic Interface

You may see the following electronic interfaces on the operating table. The technical descriptions of the electronic interfaces are as follows:

Electronic Interface	Specification
Corded hand control interface	Used for transmitting control commands and operating table status
	Connected with the corded hand control
	Mindray internal protocol
	Push-pull self-locking connector
Foot switch interface	Used for transmitting control commands and operating table status
	Connected with the foot switch
	Mindray internal protocol
	Push-pull self-locking connector

B EMC

The device meets the requirements of IEC 60601-1-2. The accessories listed in this manual meet the requirements of IEC 60601-1-2 when used with the device.

WARNING

- **Use of accessories, transducers and cables other than those specified or provided by the manufacturer of this device could result in increased electromagnetic emissions or decreased electromagnetic immunity of this device and result in improper operation.**
 - **Use of this device adjacent to or stacked with other device should be avoided because it could result in improper operation. If such use is necessary, this device and the other device should be observed to verify that they are operating normally.**
 - **Portable RF communications equipment (including peripherals such as antenna cables and external antennas) should be used no closer than 30 cm (12 inches) to any part of the HyBase V8 Classic operating table, including cables specified by the manufacturer. Otherwise, degradation of the performance of this device could result.**
 - **The non-ME EQUIPMENT (e.g. ITE) that is a part of an ME SYSTEM may be disrupted by the electromagnetic interference of nearby equipment. It may be necessary to take mitigation measures, such as re-orienting or relocating the non-ME EQUIPMENT or shielding the location.**
 - **This device is intended for use in professional healthcare facility environment only. If it is used in special environment, such as magnetic resonance imaging environment, the equipment/system may be disrupted by the operation of nearby equipment.**
-
-

Guidance and Declaration - Electromagnetic Emissions		
The device is intended for use in the electromagnetic environment specified below. The customer or the user of the device should assure that it is used in such an environment.		
Emission test	Compliance	Electromagnetic environment - guidance
Conducted and radiated RF EMISSIONS CISPR 11	Group 1	The device uses RF energy only for its internal function. Therefore, its RF emissions are very low and are not likely to cause any interference in nearby electronic device.
Conducted and radiated RF EMISSIONS CISPR 11	Class A	The device is suitable for use in all establishments other than domestic and those directly connected to the public low-voltage power supply network that supplies buildings used for domestic purposes.
Harmonic distortion IEC 61000-3-2	Not applicable	
Voltage fluctuations and flicker IEC 61000-3-3	Not applicable	

NOTE

- **The device needs special precautions regarding EMC and needs to be installed and put into service according to the EMC information provided below.**
- **Other devices may affect this device even though they meet the requirements of CISPR.**
- **The EMISSIONS characteristics of this device make it suitable for use in industrial areas and hospitals (CISPR 11 class A). If it is used in a residential environment (for which CISPR 11 class B is normally required) this device might not offer adequate protection to radio-frequency communication services. The user might need to take mitigation measures, such as relocating or re-orienting the device.**
- **If the essential performance is lost or degraded, it may be necessary to take mitigation measures, such as re-orienting or relocating the ME EQUIPMENT or ME SYSTEM or shielding the location or stopping using the device and contact the service personnel.**

If the device is operated within the electromagnetic environment listed in Table Guidance and Declaration —Electromagnetic Immunity, the system will remain safe and provide the following essential performance: the normal operating table movement

realized by electric control of the control unit; supporting a patient without unwanted movement in a single fault condition.

Guidance and Declaration - Electromagnetic Immunity			
The device is intended for use in the electromagnetic environment specified below. The customer or the user of the device should assure that it is used in such an environment.			
Immunity test	IEC 60601 test level	Compliance level	Electromagnetic environment - guidance
Electrostatic discharge (ESD) IEC 61000-4-2	±8 kV contact ±15kV air	±8 kV contact ±15kV air	Floors should be wood, concrete or ceramic tile. If floors are covered with synthetic material, the relative humidity should be at least 30%.
Electrical fast transient/burst IEC 61000-4-4	±2 kV for power supply lines ±1 kV for input/output lines (length greater than 3 m)	±2 kV for power supply lines ±1 kV for input/output lines (length greater than 3 m)	Mains power quality should be that of a typical commercial or hospital environment.
Surge IEC 61000-4-5	±1 kV line(s) to line(s) ±2 kV line(s) to earth	±1 kV line(s) to line(s) ±2 kV line(s) to earth	
Voltage dips and voltage interruptions IEC 61000-4-11	0 % U_T for 0,5 cycle 0 % U_T for 1 cycle and 70 % U_T for 25/30 cycles 0 % U_T for 250/300 cycle	0 % U_T for 0,5 cycle 0 % U_T for 1 cycle and 70 % U_T for 25/30 cycles 0 % U_T for 250/300 cycle	Mains power quality should be that of a typical commercial or hospital environment. If the user of our product requires continued operation during power mains interruptions, it is recommended that our product be powered from an uninterruptible power supply or a battery.
RATED power frequency magnetic fields IEC 61000-4-8	30 A/m 50 Hz / 60 Hz	30 A/m 50 Hz / 60 Hz	Power frequency magnetic fields should be at levels characteristic of a typical location in a typical commercial or hospital environment.
Note: U_T is the A.C. mains voltage prior to application of the test level.			

Guidance and Declaration - Electromagnetic Immunity

The device is intended for use in the specified electromagnetic environment. The customer or the user of the device should assure that it is used in such an environment as described below.

Immunity test	IEC 60601 Test level	Compliance level	Electromagnetic environment - guidance
Conducted disturbances induced by RF fields IEC61000-4-6	3 Vrms 150 kHz to 80 MHz	3 Vrms	Portable and mobile RF communications equipment should be used no closer to any part of the device, including cables, than the recommended separation distance calculated from the equation applicable to the frequency of the transmitter. Recommended separation distance: $d = \left[\frac{3.5}{V} \right] \sqrt{P} \quad 150\text{kHz to } 80 \text{ MHz}$
	6 Vrms in ISM bands ^a between 0,15 MHz and 80 MHz	6 Vrms	
Radiated RF EM fields IEC61000-4-3	3 V/m 80 MHz to 2.7 GHz	3V/m	$d = \left[\frac{3.5}{E} \right] \sqrt{P} \quad 80 \text{ MHz to } 800 \text{ MHz}$
Proximity fields from RF wireless communications equipment IEC61000-4-3	27 V/m 380–390 MHz	27 V/m	$d = \left[\frac{7}{E} \right] \sqrt{P} \quad 800 \text{ MHz to } 2.7 \text{ GHz}$
	28 V/m 430–470 MHz, 800– 960 MHz, 1700–1990 MHz, 2400– 2570 MHz	28 V/m	Where P is the maximum output power rating of the transmitter in watts (W) according to the transmitter manufacturer and d is the recommended separation distance in meters (m). Field strengths from fixed RF transmitters, as determined by an electromagnetic site survey ^b , should be less than the compliance level in each frequency range ^c . Interference may occur in the vicinity of equipment marked with the following symbol: 
	9 V/m 704–787 MHz, 5100– 5800 MHz	9 V/m	

Note 1: At 80 MHz and 800 MHz, the higher frequency range applies.

Note 2: These guidelines may not apply in all situations. Electromagnetic propagation is affected by absorption and reflection from structures, objects and people.

^a The ISM (industrial, scientific, and medical) bands between 150 kHz and 80 MHz are 6.765 MHz to 6.795 MHz; 13.553 MHz to 13.567 MHz; 26.957 MHz to 27.283 MHz; and 40.66 MHz to 40.70 MHz.

^b Field strengths from fixed transmitters, such as base stations for radio (cellular/cordless) telephones and land mobile radios, amateur radio, AM and FM radio broadcast and TV broadcast cannot be predicted theoretically with accuracy. To assess the electromagnetic environment due to fixed RF transmitters, an electromagnetic site survey should be considered. If the measured field strength in the location in which the device is used exceeds the applicable RF compliance level above, the device should be observed to verify normal operation. If abnormal performance is observed, additional measures may be necessary, such as re-orienting or relocating the device.

^c Over the frequency ranges 150 kHz to 80 MHz, field strengths should be less than 3V/m.

Recommended Separation Distances between Portable and Mobile RF, Communications Equipment and This Equipment

The equipment is intended for use in an electromagnetic environment in which radiated RF disturbance are controlled. The customer or the user of the device can help prevent electromagnetic interference by maintaining a minimum distance between portable and mobile RF communications equipment (transmitters) and the device as recommended below, according to the maximum output power of the communication equipment.

Rated Maximum Output power of Transmitter Watts (W)	Separation Distance According to Frequency of Transmitter (m)		
	150 kHz to 80 MHz $d = \left[\frac{3.5}{f} \right] \sqrt{P}$	80 MHz to 800 MHz $d = \left[\frac{3.5}{E} \right] \sqrt{P}$	800 MHz to 2.7 GHz $d = \left[\frac{7}{E} \right] \sqrt{P}$
0.01	0.12	0.12	0.23
0.1	0.38	0.38	0.73
1	1.2	1.2	2.3
10	3.8	3.8	7.3
100	12	12	23

For transmitters at a maximum output power not listed above, the recommended separation distanced in meters (m) can be determined using the equation applicable to the frequency of the transmitter, where P is the maximum output power rating of the transmitter in watts (W) according to the transmitter manufacturer.



Note 1: At 80 MHz and 800 MHz, the higher frequency range applies.

Note 2: These guidelines may not apply in all situations. Electromagnetic propagation is affected by absorption and reflection from structures, objects and people.

Cable:

No.	Description	Length (m)	Shielded or not
1	AC power cord	≤ 5	Not shielded

C Declaration of Conformity

Declaration of Conformity V1.0		
Declaration of Conformity		
Manufacturer:	Nanjing Mindray Bio-Medical Electronics Co., Ltd. 666# Middle Zhengfang Road, Jiangning, 211111 Nanjing, Jiangsu, P.R.China	
EC-Representative:	Shanghai International Holding Corp. GmbH (Europe) Eiffestrasse 80, 20537 Hamburg, Germany (DIMDI No.: DE/0000040627)	
Product Name :	Operating Table	
Model:	HyBase V8、HyBase V80、HyBase V8 Classic、HyBase V80 Classic、HyBase V6、HyBase V60、HyBase V60C、HyBase S6、HyBase S60、HyBase S7、HyBase S70、HyBase S8、 HyBase S80	
Remark:	/	
Object of the declaration: We declare on our sole responsibility that the product mentioned above satisfies the provisions of Directive 2014/53/EU concerning radio equipment. All supporting documentation is retained under the premises of the manufacturer.		
The product complies with following standards and/or other normative documents:		
Standards Applied:	EN 60601-1:2006+A1:2013; EN 60601-1-2:2015; EN 62311:2008; ETSI EN 301 489-1 V2.2.3; ETSI EN 301 489-3 V2.1.1; EN 303 417 V1.1.1; ESTI EN 300 328 V2.2.2; ETSI EN 301 489-17 V3.1.1; EN 300 330 V2.1.1	
Place, Date of Issue:	Nanjing, July 7, 2021	
Signature:		
Name of Authorized Signatory:	Mr. Zhai Pei	
Position Held in Company:	Manager, Technical Regulation	

This page intentionally left blank.

mindray

Accessories for operating tables



www.mindray.com

P/N:ENG-Accessories for operating tables -210285X64P-20220930
©2022 Shenzhen Mindray Bio-Medical Electronics Co.,Ltd. All rights reserved.

mindray
healthcare within reach





mindray
healthcare within reach

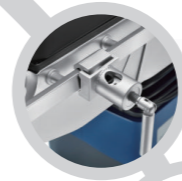

01-12 General Accessories

01



13-21 Head Accessories

13



22-27 Leg Accessories

22



28-30 Back Accessories

28



31-36 Accessories for Gynecology & Urology

31



37-44 Orthopedic Accessories

37



45-46 Accessories for Controlling
and Easier Application

45

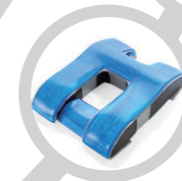

47-50 Comfort Solution Accessories

47

HyBase V8

Electro-Hydraulic Operating Table

With increasingly complex surgical procedures, today's surgical environment requires a table that instantly adapts to all versatility to provide the highest level of care. HyBase V8 comes with an extreme weight capacity of up to 460 kg, delivering the highest safety and stability in any position.

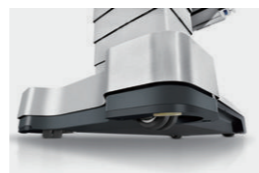

4 swivel castors



E-drive function



Intelligent Collision Protection System

- An extreme load capacity of up to 460 kg
- All positions are permitted up to overall load of 250 kg
- The longitudinal shift up to 350 mm, free access to C-arm
- 595 mm lowest table position for neurosurgery, 1,095 mm highest table position for orthopedics
- Intelligent Collision Protection System to stop the table movement before collision occurs
- Electric movements, such as powered body elevator, powered leg plates and E-drive function, adapting to various surgical needs
- Bluetooth hand control for unobstructed control in operating rooms

HyBase V8 Classic

Electro-Hydraulic Operating Table

HyBase V8 Classic, the sequel of HyBase V family, is a new competitive model of Mindray operating family. It not only inherits the highlights of HyBase V family, but also conveys new function which is able to upgrade the safety in OR. As surgical procedures become increasingly complex, the expanding HyBase V series family with different models has been specifically designed to address various customer needs.



With the One-button design



Independent Manual Override System

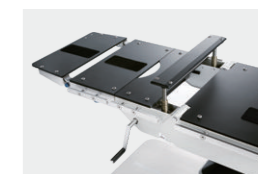

Built-in Body Elevator

- An extreme load capacity of up to 460 kg
- All positions are permitted up to overall load of 250 kg
- The longitudinal shift up to 350 mm for free to access to C-arm
- 600mm lowest table position for neurosurgery, while 1,050 mm highest table position for orthopedics
- 12 electric movements, such as table top up/down, slope and tilt, adapting to various surgical needs
- Bluetooth hand control for unobstructed control in operating rooms
- Independent manual override system for dual safety
- Triple-layer decompression pad to redistribute the patient's weight

HyBase 8300/8500

Electro-Hydraulic Operating Table

Engineered for increasingly complex surgical scenes, HyBase 8300/8500 comes with extreme weight capacity up to 460 kg guaranteeing highest safety and stability in any position. With longitudinal slide up to 480 mm, it is ideally suitable for cardiovascular surgery with C-arm. The modular design tabletop enables it to be tailored for various surgical discipline needs.

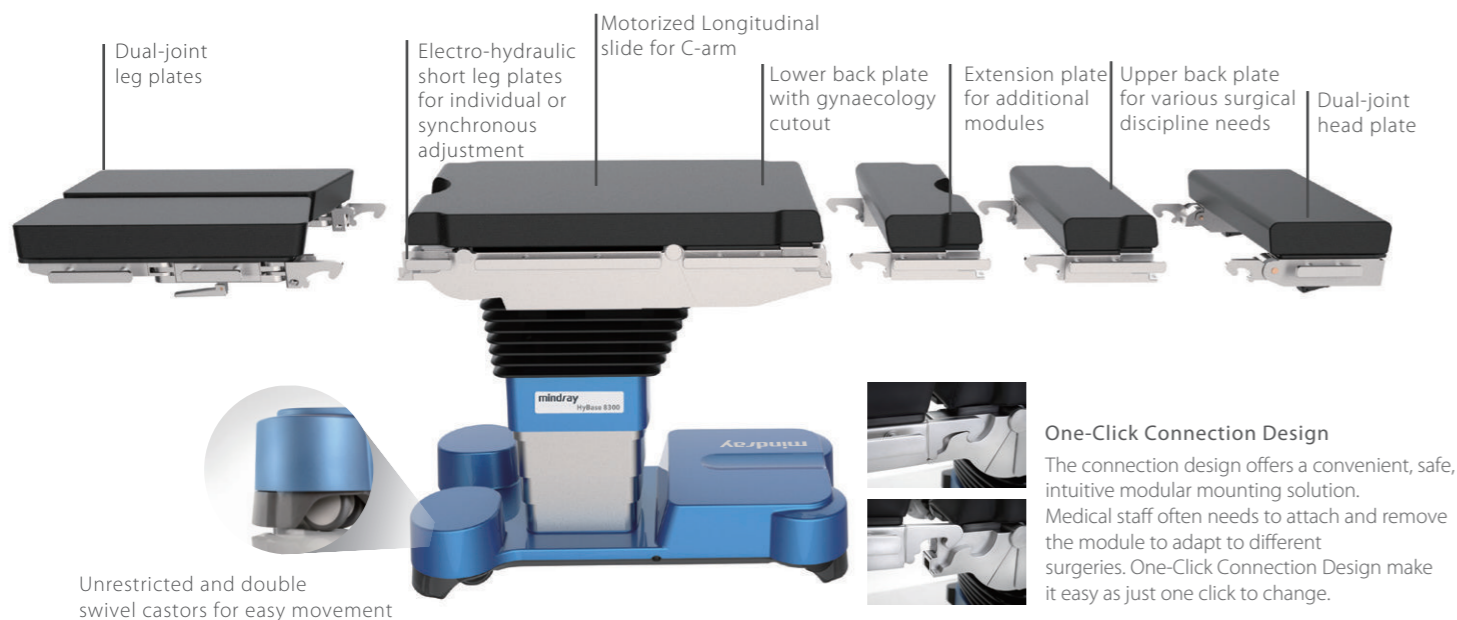

- Longitudinal slide up to 480 mm for free access to C-arm
- Extreme weight load capacity of 460 kg with highest safety and stability
- Modular design tabletop tailored for various surgical discipline needs
- Intelligent anti-collision system to avoid table components collision during movement
- Multi-layer decompression pad with waterproof and seamless design
- 575 mm lowest table position for Neurosurgery
- IR wireless remote control system for free movements in OR

HyBase 6100

Electro-Hydraulic Operating Table

Providing a better clinical use's scenario, HyBase 6100 is designed with a much lower table height of 498 mm specially for neurosurgery and minimally invasive surgery, a more user friendly base cover, as well as a more convenient wireless remote control system. Moreover, with longitudinal slide up to 320 mm, the table is ideally suitable for cardiovascular surgery or spinal surgery with C-arm. All in all, HyBase 6100 maximizes the flexibility of operating table's versatility.



- Longitudinal slide up to 320 mm for free access to C-arm
- Maximum overall load up to 360 kg in normal position
- Multi-layer decompression pad with waterproof and seamless design
- 498 mm lowest table position for Neurosurgery and Minimally Invasive Surgery
- Wireless remote control system
- Foot pump Manual Override System

HyBase 3000

Electro-Hydraulic Operating Table

Proper annotation of "cost-effective". With most acceptable price, gaining the most functional Electro-hydraulic table. No matter what principle surgery was, it can always find a way to meet your requirement.



Foot break provides Maximum safety and easy use.

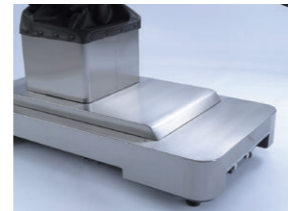

Battery power can support 50-80 operations.
Backup control keys in case of hand control failure.
Optional stainless steel cover.

- Multi-layer decompression pad with waterproof and seamless design
- Longitudinal slide up to 300 mm for free access to C-arm
- Max. overall load up to 230 kg in normal position
- Battery power for 50-80 operations
- Mechanical brake system for optimum stability
- Return to original position with one button
- Flex & Reflex position with one button
- Radiolucent table plate for free C-arm access
- Three control panels including remote panel, backup control & foot switch

UniBase 30

Electro-Hydraulic Operating Table

During the surgery, a good operating table is the cornerstone of success. Engineered for increasingly complex surgical scenes, UniBase 30 needs least effort and time to position the patient in a safe, comfortable and efficient way, providing an economic solution without straining on your hospital's budget.



Versatile & Ergonomic Design

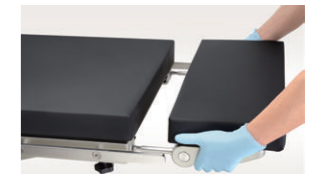

Detachable Head Plate



Adjustable Body Elevator (optional)



Pedal Floor Lock

- Weight capacity of 185 Kg in normal position
- Longitudinal shift (optional) with 300 mm
- Adjustment body elevator (optional) with 120 mm
- Battery power for about one week time
- Mechanical brake system for optimum stability
- Detachable & split leg plate for lithotomy position

General Accessories

The Mindray table accessory portfolio provides optimal patient positioning and ideal working conditions for the medical staff. With robust design, ease-to-use and ergonomic functionality, Mindray offers standard table accessories that meets the requirements of nearly every surgical discipline.



General Accessories



0092-30-102657 A33XX Light quadrate clamp

Accessory Name:

Universal clamp (Light, one-piece, quadrate)

Application:

To attach to the side rail for connecting accessories with the table

Compatible with:

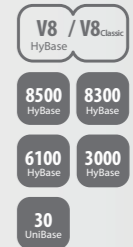

0092-30-102655 A32XX Heavy quadrate clamp

Accessory Name:

Universal clamp (Heavy, one-piece, quadrate)

Application:

To attach to the side rail for connecting accessories with the table

Compatible with:

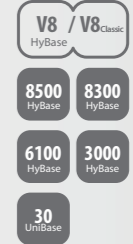

0092-30-102658 A34XX Light radial clamp

Accessory Name:

Universal clamp (Light, one-piece, radial)

Application:

To attach to the side rail for connecting accessories with the table

Compatible with:



General Accessories



0092-30-102656 A35XX Heavy radial clamp

Accessory Name:

Universal clamp (Heavy, one-piece, radial)

Application:

Attach to the side rail for connecting accessories with the table

Compatible with:

- V8 / V8_{Classic}
HyBase
- 8500 HyBase 8300 HyBase
- 6100 HyBase 3000 HyBase
- 30
UniBase

General Accessories



0092-30-102645 A12XX Light anesthesia frame

Accessory Name:

Anesthesia Frame, one piece with quadrate universal clamp

Application:

To hang the anesthesia screen during the surgery

Compatible with:

- V8 / V8_{Classic}
HyBase
- 8500 HyBase 8300 HyBase
- 6100 HyBase 3000 HyBase
- 30
UniBase



115-038243-00 A09XX Strap clamps, a pair

Accessory Name:

Strap clamps, a pair

Application:

To fix the body strap in the intended position on the side rail

Compatible with:

- V8 / V8_{Classic}
HyBase
- 8500 HyBase 8300 HyBase
- 6100 HyBase 3000 HyBase
- 30
UniBase



115-005689-00 A10XX U-Shaped anesthesia frame

Accessory Name:

"U" shape anesthesia frame with clamps

Application:

To hang the anesthesia screen during the surgery

Compatible with:

- V8 / V8_{Classic}
HyBase
- 8500 HyBase 8300 HyBase
- 6100 HyBase 3000 HyBase
- 30
UniBase



0092-30-102643 A60XX Infusion holder

Accessory Name:

Infusion pole with one piece with radial universal clamp

Application:

To hang the infusion bag in the procedure

Compatible with:

- V8 / V8_{Classic}
HyBase
- 8500 HyBase 8300 HyBase
- 6100 HyBase 3000 HyBase
- 30
UniBase



0092-30-102654 A11XX Heavy anesthesia frame

Accessory Name:

Anesthesia frame, "L" shape design with two adjustable tubes, one piece with radial universal clamp

Application:

To hang the anesthesia screen during the surgery

Compatible with:

- V8 / V8_{Classic}
HyBase
- 8500 HyBase 8300 HyBase
- 6100 HyBase 3000 HyBase
- 30
UniBase

General Accessories



115-083097-00 A42XX Light arm board

Accessory Name:

Light arm board with rotation function in horizontal position (with integrated clamp, pad & two pieces of fasten belt for each arm board), a pair

Application:

To support and fasten the arm of the patient to avoid unexpected moving

Compatible with:

- V8 / V8 Classic
HyBase
- 8500 HyBase 8300 HyBase
- 6100 HyBase 3000 HyBase
- 30 UniBase

General Accessories



115-005693-00 A41XX Double arm board

Accessory Name:

Double layer arm support with one piece of heavy radial clamp for lateral position, with the pad

Application:

To support and fasten both of the arms of the patient as a lateral position to avoid unexpected movement

Compatible with:

- V8 / V8 Classic
HyBase
- 8500 HyBase 8300 HyBase
- 6100 HyBase 3000 HyBase
- 30 UniBase



115-083165-00 A43XX Heavy arm board, SFC
115-083164-00 A43XP Heavy arm board, PU

Accessory Name:

Heavy arm board with up & down and rotation function (a heavy radial universal clamp, pad & two pieces of fasten belt for each arm board), a pair(SFC/PU)

Application:

To support and fasten the arm of the patient to avoid unexpected moving

Compatible with:

- A43XX**
- V8 / V8 Classic 8500 8300
HyBase HyBase HyBase
 - 6100 3000 30
HyBase HyBase UniBase
- A43XP**
- V8 / V8 Classic 6100 3000
HyBase HyBase HyBase



0092-30-102648 A36XX Arm board for lateral position

Accessory Name:

Lateral position arm support with one piece of radial universal clamp, with the pad

Application:

To support and fasten the upper arm of the patient in lateral position

Compatible with:

- V8 / V8 Classic
HyBase
- 8500 HyBase 8300 HyBase
- 6100 HyBase 3000 HyBase
- 30 UniBase

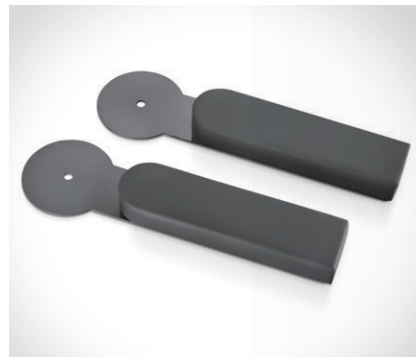

115-030153-00 A38XX Carbon fiber arm board, a pair

Accessory Name:

Carbon fiber arm board, with special foam core pad, a pair

Application:

A carbon fibre arm board which includes a memorised foam pad. This can work with the 1180 cardiac operating plate which provides support for the patient's upper extremities in a supine position

Compatible with:

- V8 / V8 Classic
HyBase
- 8500 HyBase 8300 HyBase



115-083163-00 A37XX Arm posturing device

Accessory Name:

Arm posturing device, a pair
Note: this accessory includes side rail extension(HySRE-2)

Application:

During surgeries, it is used to allow support for patient's arm to effectively protect patient's brachial nerves

Compatible with:

- V8 / V8 Classic
HyBase
- 8500 HyBase 8300 HyBase
- 6100 HyBase 3000 HyBase
- 30 UniBase

General Accessories



115-007051-00 A18XX Suspended arm strap

Accessory Name:

Suspended arm strap, mounted on the anesthesia frame

Application:

Attach to frame for hanging the hand of the patient

Compatible with:

- V8 / V8^{Classic}
HyBase
- 8500 / 8300
HyBase
- 6100 / 3000
HyBase
- 30
UniBase

General Accessories

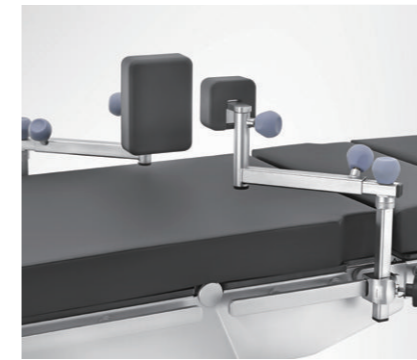

115-083160-00 A17XX Heavy body support

Accessory Name:

Heavy body support (with heavy quadrate universal clamp and the pad), a pair (including large body support and small body support)

Application:

To support the body of the patient for avoiding unexpected movement

Compatible with:

- V8 / V8^{Classic}
HyBase
- 8500 / 8300
HyBase
- 6100 / 3000
HyBase
- 30
UniBase



115-083162-00 A19XX Wristlet

Accessory Name:

Wristlet with a light quadrate clamp, a pair

Application:

Attach to the side rail rail for fastening the hand of the patient

Compatible with:

- V8 / V8^{Classic}
HyBase
- 8500 / 8300
HyBase
- 6100 / 3000
HyBase
- 30
UniBase



0092-30-102650 A16XX Light body support, a pair

Accessory Name:

Two pieces of body support with a pair of quadrate universal clamps and the pad

Application:

To support the body of the patient for avoiding unexpected movement

Compatible with:

- V8 / V8^{Classic}
HyBase
- 8500 / 8300
HyBase
- 6100 / 3000
HyBase
- 30
UniBase



0092-30-102640 A13XX Body strap

Accessory Name:

Body strap, one-piece

Application:

To fasten the body of the patient to the table during the surgery

Compatible with:

- V8 / V8^{Classic}
HyBase
- 8500 / 8300
HyBase
- 6100 / 3000
HyBase
- 30
UniBase



115-083147-00 A15XX Heavy shoulder support

Accessory Name:

Heavy shoulder support (with heavy quadrate universal clamp and pad), a pair

Application:

To support the shoulder of the patient for avoiding unexpected movement

Compatible with:

- V8 / V8^{Classic}
HyBase
- 8500 / 8300
HyBase
- 6100 / 3000
HyBase
- 30
UniBase

General Accessories



0092-30-102649 A14XX Light shoulder support, a pair

Accessory Name:

Shoulder support (left and right, pair with quadrat universal clamps and pad)

Application:

To support the shoulder of the patient for avoiding unexpected movement

Compatible with:

- V8 / V8_{Classic}
HyBase
- 8500 HyBase 8300 HyBase
- 6100 HyBase 3000 HyBase
- 30 UniBase

General Accessories



115-052219-00 HyBF-1 Bow frame for spine operation
115-053656-00 A76XX Foam head block stand of bow frame
115-053654-00 A75XX Pad set for bow frame, a pair

Accessory Name:

Bow frame for spine operation
 Foam head block stand of bow frame
 Pad set for bow frame, a pair

Application:

Bow frame is adjustable for length and width according to different patients
 Foam head block support the head in prone position
 Pad set give a comfortable support for the chest

Compatible with:

- V8 / V8_{Classic}
HyBase
- 8500 HyBase 8300 HyBase
- 6100 HyBase 3000 HyBase
- 30 UniBase

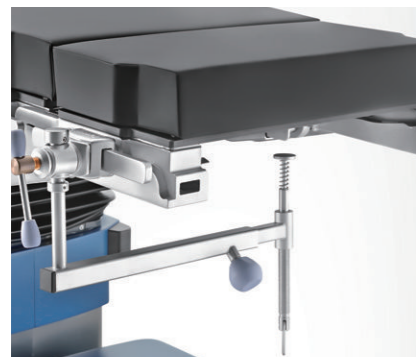

0092-30-102641 A53XX Cassette fixer

Accessory Name:

X-ray Cassette fixer with a light radial clamp (compatible with multi-size)

Application:

To fix the X-ray cassette under the table

Compatible with:

- V8 / V8_{Classic}
HyBase
- 8500 HyBase 8300 HyBase
- 6100 HyBase 3000 HyBase
- 30 UniBase



115-052221-00 A73XX Bow frame cart

Accessory Name:

Bow frame cart, four universal castors

Application:

It is convenient for the bow frame to store and move

Compatible with:

- V8 / V8_{Classic}
HyBase
- 8500 HyBase 8300 HyBase
- 6100 HyBase 3000 HyBase
- 30 UniBase



0092-30-102639 P02XX Pad for intervertebral disc Ops

Accessory Name:

Intervertebral disc operation pad (Memorise foam, one piece)

Application:

To support the body in intervertebral operating position

Compatible with:

- V8 / V8_{Classic}
HyBase
- 8500 HyBase 8300 HyBase
- 6100 HyBase 3000 HyBase
- 30 UniBase

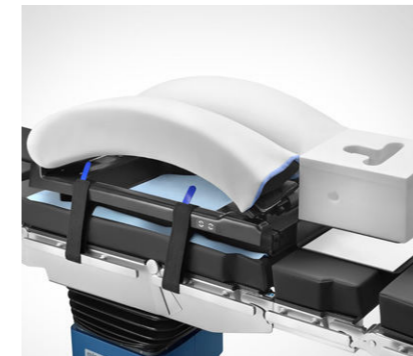

115-052223-00 A74XX Bow frame disposable cover(6 sets)

Accessory Name:

Disposable covers for bow frame(6 pcs)

Application:

To prevent the pad getting dirty during spine operation

Compatible with:

- V8 / V8_{Classic}
HyBase
- 8500 HyBase 8300 HyBase
- 6100 HyBase 3000 HyBase
- 30 UniBase

General Accessories



115-033429-00 A30XX Side rail extension

Accessory Name:

Side rail extension

Application:

Can extend the side rail toward the two ends of the operating table, to provide more space for installation of other accessories, such as leg support and foot plate

Compatible with:

- V8 / V8^{Classic}
HyBase
- 8500 / 8300
HyBase
- 6100 / 3000
HyBase
- 30
UniBase

General Accessories



115-012837-00 A45XX Mayo instrument tray

Accessory Name:

Mayo instrument tray with a light radial clamp

Application:

It is used to place the instruments required during the operation

Compatible with:

- V8 / V8^{Classic}
HyBase
- 8500 / 8300
HyBase
- 6100 / 3000
HyBase
- 30
UniBase



115-039082-00 A31XX Side rail extension (HySRE-2)

Accessory Name:

Side rail extension (HySRE-2), bent type

Application:

Can extend the side rail towards the two sides of the operating table, to provide more space for installation of other accessories

Compatible with:

- V8 / V8^{Classic}
HyBase
- 8500 / 8300
HyBase
- 6100 / 3000
HyBase
- 30
UniBase



115-012839-00 A44XX Instrument tray

Accessory Name:

Instrument tray with a light radial clamp

Application:

It is used to place the instruments required during the operation

Compatible with:

- V8 / V8^{Classic}
HyBase
- 8500 / 8300
HyBase
- 6100 / 3000
HyBase
- 30
UniBase

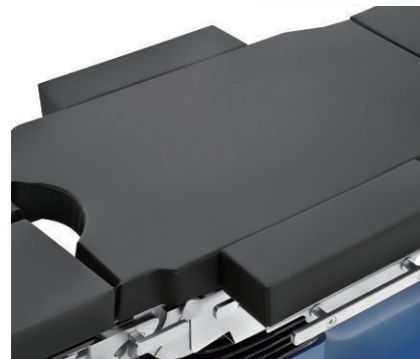

115-030814-00 A54XX Table width extender, a pair

Accessory Name:

Table width extender, to extend the table top, a pair

Application:

During surgeries, it is used to widen the operating table top and provide comfortable lying for larger-sized patients

Compatible with:

- V8 / V8^{Classic}
HyBase
- 8500 / 8300
HyBase
- 6100 / 3000
HyBase
- 30
UniBase

Head, Back and Leg Accessories

Modular design table top is tailored for various surgical discipline needs, which also can low down the cost of the hospital as they only need to buy the specific module for more surgeries not one more table.



Head Accessories



115-028574-00 813XX Head plate
115-028576-00 813CX Head plate, CF

Accessory Name:

Head plate, single-joint, carbon fiber (optional), with special foam core pad

Application:

During surgeries, it is used to provide support to the patient's head

Compatible with:



115-028703-00 801XX 2-joint head plate
115-028705-00 801CX 2-joint head plate, CF

Accessory Name:

Head plate, dual-joint, carbon fiber(optional), with special foam core pad

Application:

During surgeries, it is used to provide support to the patient's head with a double-joint design

Compatible with:



115-052229-00 807XX Back plate for shoulder operation

Accessory Name:

Back plate for shoulder operation, with helmet

Application:

Provide a stable support for the shoulder operation by beach-chair position

Compatible with:



Head Accessories



115-079674-00 A63XX 2-joint head plate
115-079675-00 A63CX 2-joint head plate, CF

Accessory Name:

Head plate, dual-joint, carbon fiber (optional), with special foam core pad

Application:

To support the head of the patient

Compatible with:



Head Accessories

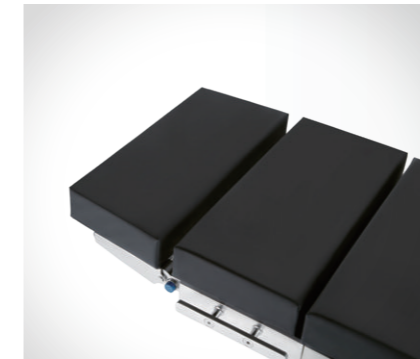

115-085098-00 A84XX Head plate
115-085099-00 A84CX Head plate, CF

Accessory Name:

Head plate, single-joint, with special foam core pad

Application:

Featherweight head plate to lighten your work. The head plate is used to support the patient's head during the surgery

Compatible with:



115-079669-00 A66XX Back plate for shoulder operation

Accessory Name:

Head plate, single-joint, with special foam core pad

Application:

To support the head and back of the patient providing a stable support for shoulder operation

Compatible with:

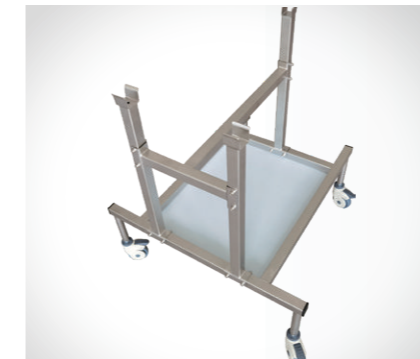

115-081869-00 A05XX Shoulder chair dolly

Accessory Name:

Shoulder chair dolly, a dolly to place the back plate for shoulder operation

Application:

To place the back plate for shoulder operation (115-081868-00)

Compatible with:



115-079720-00 A69XX Head plate
115-079721-00 A69CX Head plate, CF

Accessory Name:

Head plate, single-joint, with special foam core pad

Application:

To support the head of the patient

Compatible with:



115-081868-00 A04XX Back plate for shoulder operation

Not applicable for European and Australian markets

Accessory Name:

Back plate for shoulder operation

Application:

To support the head and back of the patient providing a stable support for shoulder operation

Compatible with:



Head Accessories



0092-30-102642 A48XX Adaptor for head positioning ACCs

Accessory Name:

Neurosurgical head support adapter

Application:

To connect the adjustable horseshoe headrest, headrest system

Compatible with:

V8 / V8 Classic
HyBase

8500 / 8300
HyBase

6100 / 3000
HyBase

Head Accessories



115-034319-00 A47XX Univ. adaptor for head position

Accessory Name:

Neurosurgical head support adapter(Type II)

Application:

To connect the adjustable horseshoe headrest, headrest system

Compatible with:

V8 / V8 Classic
HyBase

8500 / 8300
HyBase

6100 / 3000
HyBase

30
UniBase



115-007045-00 A51XX Ophthalmic operating plate

Accessory Name:

Ophthalmic operating plate
You should select the Neurosurgical head support adapter simultaneously

Application:

To support the head of the patient and support the arm of the surgeon during the surgery

Compatible with:

V8 / V8 Classic
HyBase

8500 / 8300
HyBase

6100 / 3000
HyBase



115-059311-00 A52XX Wrist support

Accessory Name:

Adjustable wrist support with foam, only use with 115-059309-00

Application:

Supporting the wrist stably to reduce the surgeon's fatigue

Compatible with:

V8 / V8 Classic
HyBase

8500 / 8300
HyBase

6100 / 3000
HyBase

30
UniBase



115-059313-00 A46XX Guiding roller for cervix traction

Accessory Name:

Adjustable guiding roller for cervix traction, only use with 115-059309-00

Application:

It is used for the cervical vertebra traction of the spine operation

Compatible with:

V8 / V8 Classic
HyBase

8500 / 8300
HyBase

6100 / 3000
HyBase

30
UniBase



**DJ15-0101-301 Adult horseshoe headrest w.Ext
DJ15-0101-302 Pedia horseshoe headrest w.Ext**

Accessory Name:

Adult horseshoe headrest w.Ext
Pedia horseshoe headrest w.Ext

Application:

A solution for supporting the head more safely and comfortably, used with headrest system

Compatible with:

V8 / V8 Classic
HyBase

8500 / 8300
HyBase

6100 / 3000
HyBase

30
UniBase

Head Accessories



DJ15-0101-001 Aluminum headrest System

Accessory Name:

Aluminum headrest system (Including base unit, swivel adaptor and skull clamp; not including skull pins)

Application:

For supine, prone, lateral positions, please select the adaptor for head position (PN: 0092-30-102642 or 115-034319-00); For sitting positions, please select crossbar adaptor (PN: DJ15-0101-101); only allow to sale with the table together as a package

Compatible with:

- V8 / V8 Classic
HyBase
- 8500 HyBase
- 8300 HyBase
- 6100 HyBase
- 3000 HyBase
- 30 UniBase

Head Accessories

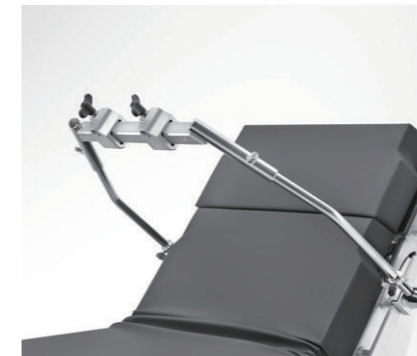

DJ15-0101-101 Crossbar adaptor with clamps

Accessory Name:

Crossbar adaptor with clamps for headrest system in sitting positions

Application:

Only allow to sale with the table together as a package

Compatible with:

- V8 / V8 Classic
HyBase
- 8500 HyBase
- 8300 HyBase
- 6100 HyBase
- 3000 HyBase
- 30 UniBase



DJ15-0101-003 LUCENT radiolucent headrest system

Accessory Name:

Radiolucent headrest system (Including base unit, swivel adaptor, transitional member and skull clamp; not including skull pins)

Application:

Radiolucent for C-arm access, only allow to sale with the table together as a package

Compatible with:

- V8 / V8 Classic
HyBase
- 8500 HyBase
- 8300 HyBase
- 6100 HyBase
- 3000 HyBase
- 30 UniBase



- DJ15-0101-201 Titanium skull pin, adult (3 pcs)
- DJ15-0101-202 Titanium skull pin, pedia (3 pcs)
- DJ15-0101-203 SS skull pins, adult (3 pcs)
- DJ15-0101-204 SS skull pins, pediatric (3 pcs)

Accessory Name:

Titanium skull pin, adult (3 pcs)
Titanium skull pin, pedia (3 pcs)
SS skull pins, adult (3 pcs)
SS skull pins, pediatric (3 pcs)

Application:

Only allow to sale with the table together as a package

Compatible with:

- V8 / V8 Classic
HyBase
- 8500 HyBase
- 8300 HyBase
- 6100 HyBase
- 3000 HyBase
- 30 UniBase

Head Accessories

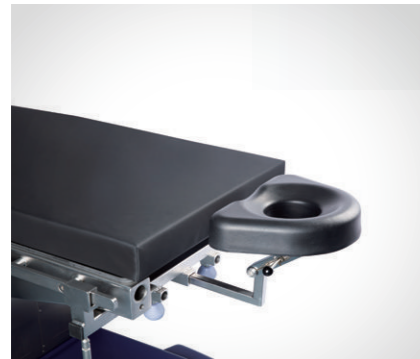

115-075152-00 Reison head rest

Accessory Name:

Head rest, Reison version

Application:

To support the head of the patient

Compatible with:

- V8 / V8 Classic
HyBase
- 8500 HyBase
- 8300 HyBase
- 6100 HyBase
- 3000 HyBase
- 30 UniBase

Leg Accessories



115-028578-00 812XX Leg plate, a pair
115-028580-00 812CX Leg plate, a pair, CF

Accessory Name:

Leg plate, single-joint, carbon fiber (optional), with special foam core pad, a pair

Application:

During surgeries, it is used to provide support to the patient's leg

Compatible with:

- 8500 HyBase
- 8300 HyBase

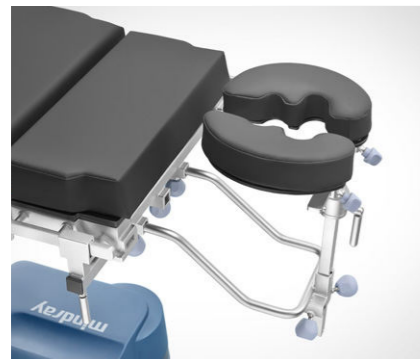

115-059309-00 A50XX Head rest

Accessory Name:

Horseshoe shaped head rest with two installation bars and special foam core pad, height and width adjustable you should select the Neurosurgical head support adapter simultaneously

Application:

A solution for supporting the head safely and comfortably. You should select the adaptor for head position simultaneously

Compatible with:

- V8 / V8 Classic
HyBase
- 8500 HyBase
- 8300 HyBase
- 6100 HyBase
- 3000 HyBase
- 30 UniBase



115-028582-00 804XX 2-joint leg plate, a pair
115-028584-00 804CX 2-joint leg plate, a pair, CF

Accessory Name:

Leg plate, dual-joint abduction, carbon fiber (optional), with special foam core pad, a pair

Application:

To support the legs of the patient during the surgery. A double-joint design, helps doctors get closer to the surgical site

Compatible with:

- 8500 HyBase
- 8300 HyBase



115-012835-00 A49XX Head rest, HyHead-2

Accessory Name:

Adjustable horseshoe shaped head rest with two installation bars you should select the Neurosurgical head support adapter simultaneously

Application:

To support the head of the patient providing a stable support for Neurosurgery operation. You should select the adaptor for head position simultaneously

Compatible with:

- V8 / V8 Classic
HyBase
- 8500 HyBase
- 8300 HyBase
- 6100 HyBase
- 3000 HyBase



115-033426-00 805XX 4-part leg plate
115-038559-00 805CX 4-part leg plate, CF

Accessory Name:

Leg plate, 4 sections, carbon fiber(optional), with special foam core pad, a pair, for HyBase 8300/8500

Application:

Can achieve the abductive function of normal leg plates and horizontal abductive function of 2-joint leg plates; the second joint leg plate can be folded upward and downward, abducted and can extend toward the leg end, and is detachable; include a mattress made of memory foam. It is able to assist in achieving kneeling position, lithotomy position and supine position

Compatible with:

- 8500 HyBase
- 8300 HyBase

Leg Accessories



115-035792-00 811XX One-section leg plate
115-037739-00 811CX One-section leg plate, CF

Accessory Name:

One-section leg plate, carbon fiber (optional), with special foam core pad, for HyBase 8300/8500

Application:

To support the leg with one-section plate during the surgery

Compatible with:



Leg Accessories



115-079672-00 A64XX 2-joint leg plate
115-079673-00 A64CX 2-joint leg plate, CF

Accessory Name:

Leg plate, dual-joint abduction, carbon fiber (optional), with special foam core pad, a pair

Application:

To support the legs of the patient during the surgery. A double-joint design helps doctors get closer to the surgical site

Compatible with:



115-005685-00 A57XX One-section leg Plate, SFC
115-005683-00 A57XP One-section leg Plate, PU

Accessory Name:

One-section leg plate for PU or SFC (Special Form Core) mattress

Application:

To support the leg with one-section plate during the surgery

Compatible with:

A57XX



A57XP



115-079722-00 V02XX Leg plate
115-079723-00 V02CX Leg plate, CF

Accessory Name:

Leg plate, single-joint, carbon fiber (optional), with special foam core pad, a pair

Application:

To support the legs of the patient during the surgery

Compatible with:



115-085100-00 A68XX One-section leg plate
115-085101-00 A68CX One-section leg plate, CF

Accessory Name:

One-section leg plate, carbon fiber (optional), with special foam core pad

Application:

To support the leg with one-section plate during the surgery

Compatible with:



115-085096-00 A85XX Leg plate
115-085097-00 A85CX Leg plate, CF

Accessory Name:

Leg plate, single-joint, carbon fiber (optional), with special foam core pad, a pair

Application:

To support the legs of the patient during the surgery

Compatible with:



Leg Accessories

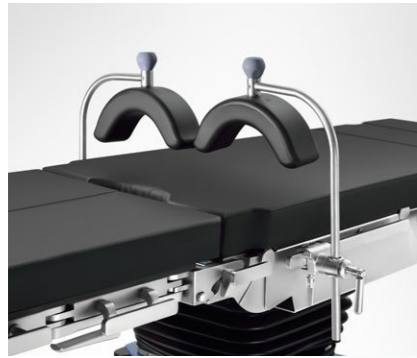

115-012841-00 A22XX Thigh holder, a pair

Accessory Name:

Fixation for femur, a pair, with two radial universal clamps

Application:

To support the femur of the patient during the surgery

Compatible with:

- V8 / V8 Classic
HyBase
- 8500 / 8300
HyBase
- 6100 / 3000
HyBase
- 30
UniBase

Leg Accessories

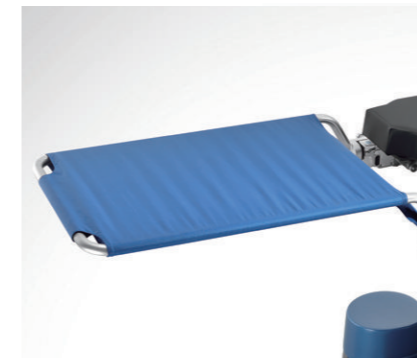

115-033425-00 803XX Transfer board

Accessory Name:

Transfer board, for HyBase 8300/8500

Application:

During surgeries, it is used to temporarily support the patient's lower extremities when positioning the patient or transferring the patient, and to optimize the pre-operation and post-operation workflows at lithotomy position

Compatible with:

- 8500 / 8300
HyBase



115-012843-00 A23XX Shank holder, a pair

Accessory Name:

Fixation for lower leg, a pair, with two radial universal clamps

Application:

To support the lower leg of the patient during the surgery

Compatible with:

- V8 / V8 Classic
HyBase
- 8500 / 8300
HyBase
- 6100 / 3000
HyBase
- 30
UniBase

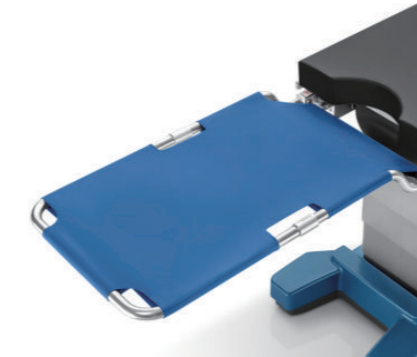

115-052205-00 A03XX Transfer board

Accessory Name:

Transfer board, light plate

Application:

Support the legs temporarily during lithotomy position

Compatible with:

- V8 / V8 Classic
HyBase
- 6100 / 3000
HyBase



115-083146-00 A24XX Foot plate

Accessory Name:

Foot support (with heavy quadrate universal clamp and pad), a pair

Application:

To support the foot of the patient for avoiding unexpected movement

Compatible with:

- V8 / V8 Classic
HyBase
- 8500 / 8300
HyBase
- 6100 / 3000
HyBase
- 30
UniBase

Leg Accessories



115-033430-00 A20XX Leg restraint cuff, thigh, a pair

Accessory Name:
Leg restraint cuff, thigh, a pair

Application:
Used to secure the patient's thigh

Compatible with:



Back Accessories

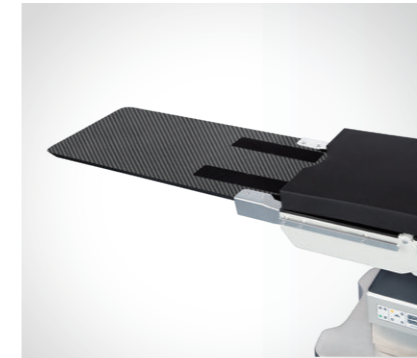

115-084234-00 V01CX Cardiac operating plate, CF

Accessory Name:
Cardiac operating plate, carbon fiber, with special foam core pad, length of 1,180mm

Application:
Cardiac operating plate, can provide 360° X-ray radiolucency, extend the foot end of the table top for 1180mm, allows for cardiovascular surgeries and spine surgeries. Includes a memorised foam pad and stand bars

Compatible with:



115-033431-00 A21XX Leg restraint cuff, shank, a pair

Accessory Name:
Leg restraint cuff, shank, a pair

Application:
Used to secure the patient's shank

Compatible with:

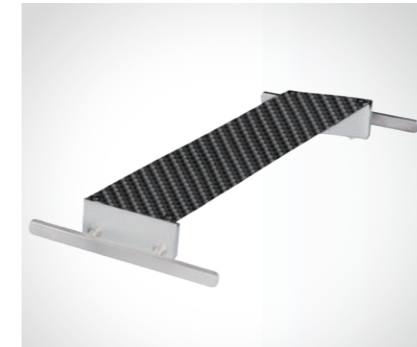
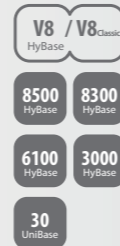

115-030151-00 A81XX Accessory adaptor, CF

Accessory Name:
Accessory adaptor for Cardiac Operating Plate, carbon fibre, with side rails

Application:
Provide an additional side rail for the 1180 cardiac operating plate (EU Standard), can be used to install accessories such as arm boards and shoulder supports.

Compatible with:

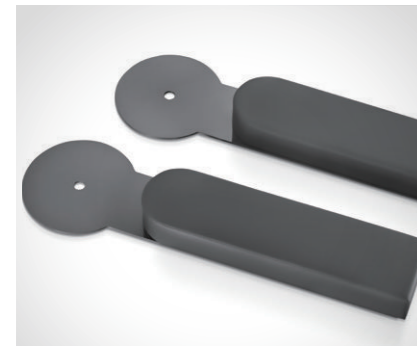

115-030153-00 A38XX Carbon fiber arm board, a pair

Accessory Name:
Carbon fiber arm board, with special foam core pad, a pair

Application:
A carbon fiber arm board which includes a memorised foam pad. This can work with the 1180 cardiac operating plate which provides support for the patient's upper extremities in a supine position

Compatible with:



115-029434-00 806XX CF cardiac operating plate

Accessory Name:
Cardiac operating plate, carbon fiber, with special foam core pad, length of 1,180mm

Application:
Cardiac operating plate, can provide 360° X-ray radiolucency, extend the foot end of the table top for 1180mm, allows for cardiovascular surgeries and spine surgeries. Includes a memorised foam pad and stand bars

Compatible with:



Back Accessories

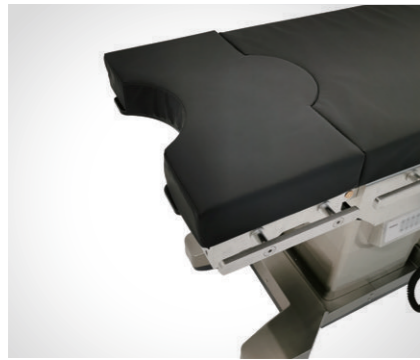

115-072052-00 A06XX Extension plate, w/ MFP, SFC
115-072051-00 A06XP Extension plate, PU

Accessory Name:
 Extension plate, to extend the table top (SFC/PU)

Application:
 To provide more perspective space or more standing space for doctors. Applicable to trauma, spine, gynecology, or urology

Compatible with:



Back Accessories



115-033428-00 802XX Short upper back plate
115-038564-00 802CX Short upper back plate, CF

Accessory Name:
 Short upper back plate, with special foam core pad, for HyBase 8300/8500

Application:
 During surgeries, provide support to the patient's back

Compatible with:

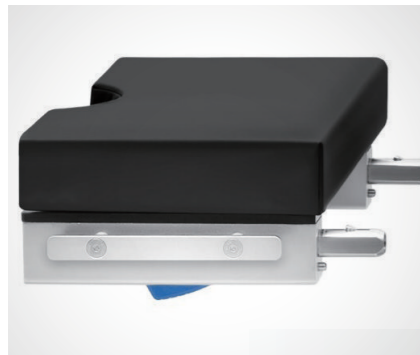

115-079670-00 A67XX Extension plate
115-079671-00 A67CX Extension plate, CF

Accessory Name:
 Extension plate, carbon fiber (optional), with gynaecological cutout, with special foam core pad, length of 250mm

Application:
 To provide more perspective space or more standing space for doctors. Applicable to trauma, spine, gynecology, or urology

Compatible with:

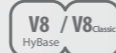

115-029430-00 808XX Extension plate, w/ MFP
115-029432-00 808CX Extension plate, w/ MFP, CF

Accessory Name:
 Extension plate, carbon fiber (optional), with gynaecological cutout, with special foam core pad, length of 250mm

Application:
 With gynecological cutout, can extend the head end or the foot end of the operating table top up to 250mm, to provide more perspective space or more standing space for doctors. Applicable to trauma, spine, gynecology, or urology. Includes an optional memorised foam pad

Compatible with:



115-079729-00 V03XX Upper back plate
115-079730-00 V03CX Upper back plate, CF

Accessory Name:
 Upper back plate, carbon fiber (optional), with special foam core pad
 Note: The upper back plate is compulsory for the head plate

Application:
 To support the back of the patient during surgeries

Compatible with:



115-028586-00 814XX Upper back plate
115-028588-00 814CX Upper back plate, CF

Accessory Name:
 Upper back plate, carbon fiber (optional), with special foam core pad
 Note: The upper back plate is compulsory for the head plate

Application:
 During surgeries, provides support to the patient's back

Compatible with:



Accessories for Gynecology & Urology

For Gynecology and Urology Surgery, Mindray provide a better workflow design and ergonomic working space for the patient positioning. The lightweight transfer board will help a lot after positioning the leg with less efforts to remove it. The leg plate folded design helps avoiding the disassembly of the leg plate. And the u shape design on base cover forms a larger space for surgeons while doing the operations. The cutout of the backplate also enable the patient reverse position for Gynecology and Urology Surgery.



Accessories for Gynecology & Urology



115-062765-00 A62XX Standard stirrups, a pair

Accessory Name:

HyStirrup-III with gas spring assisted, a pair, with radial universal clamp

Application:

To support and fasten the leg of the patient

Compatible with:

- V8 / V8 Classic
HyBase
- 8500 HyBase
- 8300 HyBase
- 6100 HyBase
- 3000 HyBase
- 30 UniBase



115-083145-00 A29XX Heavy leg support

Accessory Name:

Heavy leg support (with heavy radial universal clamp, pad & fasten belt), a pair

Application:

To support and fasten the patient's leg

Compatible with:

- V8 / V8 Classic
HyBase
- 8500 HyBase
- 8300 HyBase
- 6100 HyBase
- 3000 HyBase
- 30 UniBase



0092-30-102647 A28XX Light leg support, a pair

Accessory Name:

A pair of light version leg support, with heavy radial universal clamps, pads & fasten belts

Application:

To support and fasten the patient's leg

Compatible with:

- V8 / V8 Classic
HyBase
- 8500 HyBase
- 8300 HyBase
- 6100 HyBase
- 3000 HyBase
- 30 UniBase

Accessories for Gynecology & Urology



115-062767-00 A61XX Basic stirrups, a pair

Accessory Name:

HyStirrup-II leg support(Stirrup typ, without gas spring assisted), a pair, with heavy radial clamp

Application:

To support and fasten the patient's leg

Compatible with:

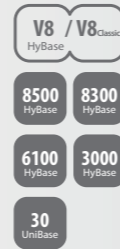

Accessories for Gynecology & Urology

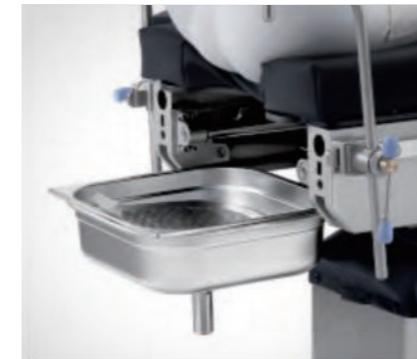

115-013018-00 301XX Drainage bowl

Accessory Name:

Drainage bowl for Gynecology & Urology

Application:

To drain the liquid in lithotomy position

Compatible with:



115-007043-00 A08XX Leg holder with loops, a pair

Accessory Name:

Leg Holders. A pair with loops and radial universal clamps

Application:

To support and fasten the patient's leg

Compatible with:

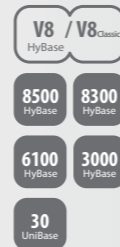

115-034318-00 A25XX Drainage bowl, universal

Accessory Name:

Universal drainage bowl

1. To be fixed on the table side rail, suitable for all table models
2. With a radial clamp

Application:

To drain the liquid in lithotomy position

Compatible with:

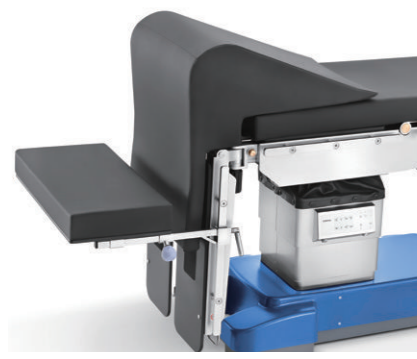
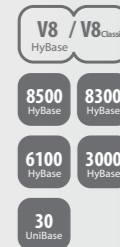

115-007049-00 A02XX Rectal positioning device

Accessory Name:

Rectal positioning device

Application:

To support the coxa and knees of the patient in rectal surgery

Compatible with:

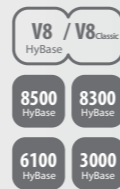

115-005697-00 A70XX Drainage bowl, HyBase 6100

Accessory Name:

Drainage bowl for Gynecology & Urology

Application:

To drain the liquid in lithotomy position

Compatible with:



Accessories for Gynecology & Urology

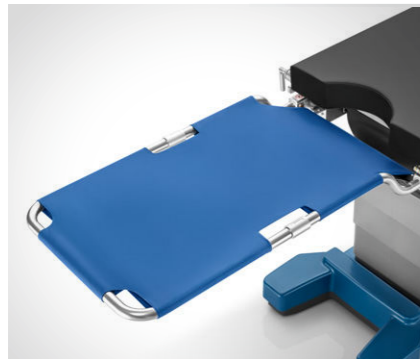

115-052205-00 A03XX Transfer board

Accessory Name:

Transfer board, light leg plate

Application:

During surgeries, it is used to temporarily support the patient's lower extremities when positioning the patient or transferring the patient, and to optimize the pre-operation and post-operation workflows at lithotomy position

Compatible with:

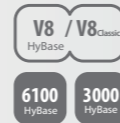

115-075117-00 A58XX Stirrup cart

Accessory Name:

Stirrup cart, a cart to place the stirrup

Application:

To store the stirrup

Compatible with:

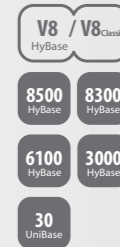

115-033425-00 803XX Transfer board

Accessory Name:

Transfer board, for HyBase 8300/8500

Application:

During surgeries, it is used to temporarily support the patient's lower extremities when positioning the patient or transferring the patient, and to optimize the pre-operation and post-operation workflows at lithotomy position

Compatible with:



115-030812-00 A07XX Hand grips with clamps, a pair

Accessory Name:

Hand grips with two light quadrate clamps, a pair

Application:

They can provide something for the woman giving birth to hold onto during or after the pushing phase on the delivery bed

Compatible with:

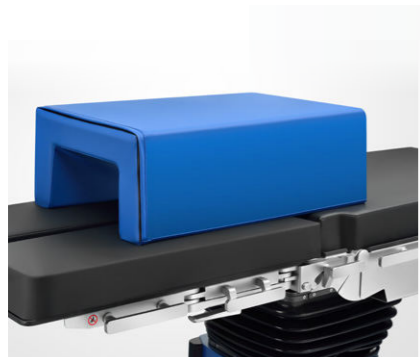
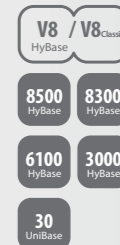

115-047824-00 P22XX Lateral positioner

Accessory Name:

Lateral positioner for the leg

Application:

Support the legs during lateral position

Compatible with:

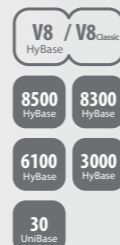

Orthopedic Accessories



115-087232-00 HyExtent-V CF w/cart

Accessory Name:

Orthopedic extension device, carbon fiber, including the cart, adopts more ergonomic traction boots.

Application:

During the orthopedic traction surgery, it is used to pull the femur to meet the need of x-rays; the device is made of highly-transmissible carbon fiber materials to improve image qualities.

Compatible with:

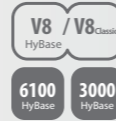

Orthopedic Accessories



115-029436-00 HyExtent-CF w/ cart,basic
115-066779-00 HyExtent-CF w/ cart,comfort

Accessory Name:

Orthopedic extension device, comfort version(optional), carbon fiber, including the cart. Note: Comparing with 115-029436-00, the comfort version adopts more ergonomic traction boots.

Application:

During the orthopedic traction surgery, it is used to pull the femur to meet the need of x-rays; the device is made of highly-transmissible carbon fiber materials to improve image qualities.

Compatible with:



115-087231-00 HyExtent-V w/cart,comfort

Accessory Name:

Orthopedic extension device, stainless steel, including the cart, adopts more ergonomic traction boots.

Application:

To provide leg traction during orthopedic surgery.

Compatible with:

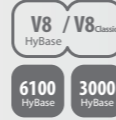

115-033409-00 HyExtent-IV w/ cart, basic
115-066781-00 HyExtent-IV w/ cart,comfort

Accessory Name:

Orthopedic extension device, hook version, stainless steel, including the cart. Orthopedic extension, comfort version with hook connection, stainless steel, including the cart. Note: Comparing with 115-033409-00, the comfort version adopts more ergonomic traction boots.

Application:

To provide leg traction during orthopedic surgery.

Compatible with:



115-087230-00 HyExtent-V w/cart,basic

Accessory Name:

Orthopedic extension device, stainless steel, including the cart.

Application:

To provide leg traction during orthopedic surgery.

Compatible with:



115-033410-00 HyExtent-Uni w/ cart,basic
115-066775-00 HyExtent-Uni w/ cart,comfort

Accessory Name:

Orthopedic extension, comfort version(optional), for UniBase 30, including the cart. Note: Comparing with 115-033410-00, the comfort version adopts more ergonomic traction boots.

Application:

To provide leg traction during orthopedic surgery.

Compatible with:



Orthopedic Accessories



115-087233-00 A86XX Tibia & fibula ASSY for HyExtent-V

Accessory Name:
Tibia & fibula extension assembly

Application:
To provide tibial and fibula traction

Compatible with:



Orthopedic Accessories



115-087236-00 A89XX Unilateral lithotomy position ASSY

Accessory Name:
light version leg support,
with Light radial clamp and Side rail extension

Application:
To support and fasten the patient's leg

Compatible with:



115-087234-00 A87XX Lateral femur ASSY for HyExtent-V

Accessory Name:
Lateral femur extension assembly

Application:
To provide femur traction in lateral position

Compatible with:



115-087237-00 A90XX Leg support for HyExtent-V

Accessory Name:
Leg holder for stainless steel orthopedic extension device

Application:
Support the injured leg during the orthopedic operation

Compatible with:



115-087235-00 A88XX Transfer leg plate for HyExtent-V

Accessory Name:
Transfer leg plate, light leg plate

Application:
During surgeries, it is used to temporarily support the patient's lower extremities when positioning the patient or transferring the patient

Compatible with:



115-087238-00 A91XX Leg support for HyExtent-V CF

Accessory Name:
Leg holder for carbon fiber orthopedic extension device

Application:
Support the injured leg during the orthopedic operation

Compatible with:



Orthopedic Accessories



115-007057-00 A80XX Lateral femur extension assembly

Accessory Name:

Lateral femur extension assembly
Note: need to use with ortho extension

Application:

To provide femur traction in lateral position for HyExtent-IV and HyExtent-Uni

Compatible with:

- 8500 HyBase
- 8300 HyBase
- 30 UniBase



115-007055-00 A77XX Tibia & fibula extension assembly

Accessory Name:

Tibia & fibula extension assembly
Note: need to use with ortho extension

Application:

To provide tibial and fibula traction for HyExtent-IV and HyExtent-Uni

Compatible with:

- 8500 HyBase
- 8300 HyBase
- 30 UniBase

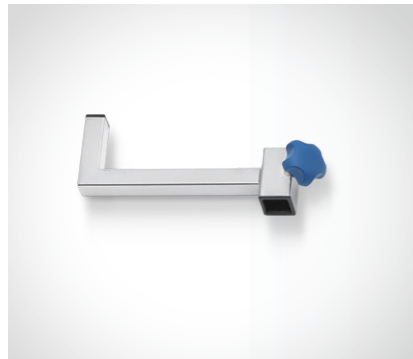

115-087240-00 A92XX L-shaped traction extensions

Accessory Name:

L-shaped traction

Application:

It is used for extending traction distance of the lower extremity for HyExtent-V

Compatible with:

- V8 / V8 Classic HyBase
- 6100 HyBase
- 3000 HyBase

Orthopedic Accessories



Unilateral Lithotomy Position



Unilateral Lithotomy Position



Tibia and Fibula Extension



Lateral Femur Nailing



Lateral Femur Nailing (with Traction Bow)

Orthopedic Accessories



115-047827-00 A72XX Leg holder for Ortho ext. device
115-047828-00 820XX Leg holder for HyExtent-CF
Accessory Name:

Leg holder for stainless steel orthopedic extension device
 Leg holder for carbon fiber orthopedic extension device

Application:

Support the injured leg during the orthopedic operation
 115-047827-00 for HyExtent-IV and HyExtent-Uni
 115-047828-00 for HyExtent-CF

Compatible with:

A72XX:

8500 HyBase 8300 HyBase

30 UniBase

820XX:

8500 HyBase 8300 HyBase



115-011817-00 A79XX Pelvis width extender, a pair
Accessory Name:

Triangle support board, 2 pieces

Application:

It is used to widen the pelvis plate for HyExtent-IV and HyExtent-Uni

Compatible with:

8500 HyBase 8300 HyBase

30 UniBase



115-033422-00 A56XX Upper arm extension device
Accessory Name:

Upper arm extension device with a heavy radial clamp

Application:

During surgeries, it is used to fix and pull patient's forearms; consists of auxillary pillar, elbow joint pillar, palm & finger fixer and tractor

Compatible with:

V8 / V8Classic HyBase

8500 HyBase 8300 HyBase

6100 HyBase 3000 HyBase

30 UniBase

Orthopedic Accessories



115-079669-00 A66XX Back plate for shoulder operation
Accessory Name:

Back plate for shoulder operation, with helmet

Application:

To support the head and back of the patient providing a stable support for Shoulder operation

Compatible with:

V8 / V8Classic HyBase

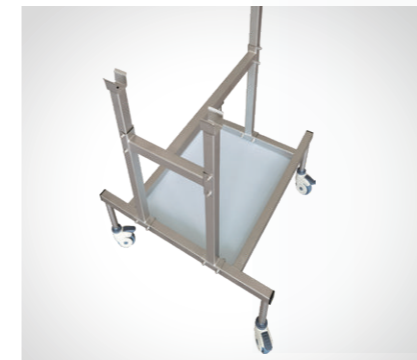

115-081869-00 A05XX Shoulder chair dolly
Accessory Name:

Shoulder chair dolly, a dolly to place the back plate for shoulder operation

Application:

To place the back plate for shoulder operation (115-081868-00)

Compatible with:

6100 HyBase



115-081868-00 A04XX Back plate for shoulder operation
Accessory Name:

Not applicable for European and Australian markets

Back plate for shoulder operation

Application:

To support the head and back of the patient providing a stable support for shoulder operation

Compatible with:

6100 HyBase

Orthopedic Accessories

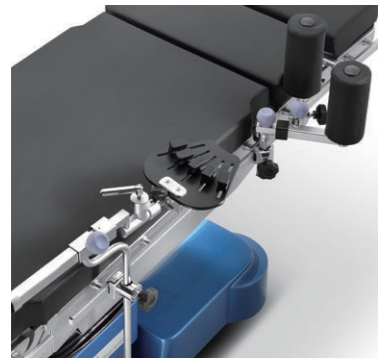

115-033421-00 A55XX Forearm extension device

Accessory Name:

Forearm extension device with clamps
Note: recommend to use with side rail extension (HySRE-2)

Application:

During surgeries, it is used to fix and pull patient's forearms; consists of auxillary pillar, elbow joint pillar, palm & finger fixer and tractor

Compatible with:



Orthopedic Accessories



115-052229-00 807XX Back plate for shoulder operation
115-059315-00 A71XX Body strap for shoulder operation

Accessory Name:

Demountable shoulder support module with helmet to support patient's head
Body strap(optional) used with back plate for shoulder operation

Application:

Provide a stable support for the shoulder operation by beach-chair position

Compatible with:

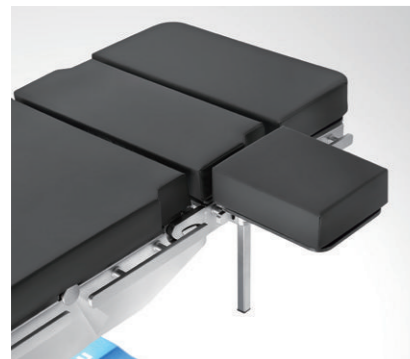
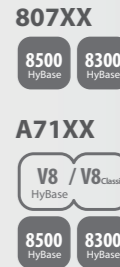

115-033415-00 A39XX Upper arm support

Accessory Name:

Upper arm support with a heavy quadrate clamp

Application:

To support the upper arm of the patient

Compatible with:



115-033413-00 A26XX Arthroscopic leg holder

Accessory Name:

Arthroscopic leg holder with a heavy radial clamp

Application:

To fasten and support the knee of the patient

Compatible with:

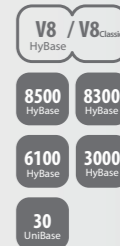

115-007047-00 A40XX Arm operating table

Accessory Name:

Arm operating table

Application:

To support the arm of the patient and the hand of the surgeon

Compatible with:

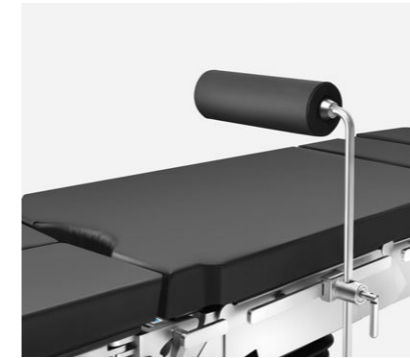
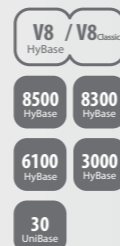

115-033416-00 A27XX Meniscus positioning device

Accessory Name:

Meniscus positioning device with clamp

Application:

To provide support for patient's thigh or foot during knee joint surgeries

Compatible with:

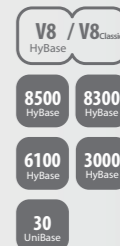

Accessories for Controlling and Easier Application



115-028600-00 818XX Wireless hand control,LCD,w/ shift
115-028598-00 817XX IR hand contro,LCD

Accessory Name:

IR hand control, with LCD, with/without longitudinal slide function, with wireless charger

Application:

Can adjust and control movements of the operating table through the infrared remote control system; with LCD. Wireless charging and easy to clean

Compatible with:



Accessories for Controlling and Easier Application



115-079752-00 V04XX Foot switch

Accessory Name:

Foot switch

Application:

To control the table movement.

Compatible with:



115-028596-00 816XX Corded hand control,LCD,w/ shift
115-028594-00 815XX Corded hand control,LCD

Accessory Name:

Corded hand control, with LCD, with/without longitudinal shift function

Application:

Adjust and control movements of the operating table; with LCD

Compatible with:



0092-30-102644 A59XX Foot switch

Accessory Name:

Foot switch

Application:

To control the table movement

Compatible with:



DJ15-0022-016 V08XX Corded hand control

Accessory Name:

Corded hand control

Application:

Adjust and control movements of the operating table; with LCD

Compatible with:



115-008220-00 A01XX Accessory cart

Accessory Name:

Accessory cart

Application:

To place general accessories for the operating table

Compatible with:



DJ15-0022-015 V07XX Wireless hand control

Accessory Name:

Wireless hand control

Application:

Adjust and control movements of the operating table; with LCD

Compatible with:



115-079748-00 V05XX Assist drive handle

Accessory Name:

Assist drive handle

Application:

To assist in controlling and moving the operating table

Compatible with:



Comfort Solution Accessories



- 115-005872-00 P34LX Head ring 20x7x7
- 115-005873-00 P34MX Head ring 20x7x5
- 115-005877-00 P34SX Head ring 20x7x3
- 115-005874-00 P09LX Paediatric head ring 14x5x3
- 115-005878-00 P09MX Paediatric head ring 14x7x2.5
- 115-005875-00 P09SX Paediatric head ring 10x4x2.5
- 115-005876-00 P32XX Infant head ring 8x3x2



- 115-005885-00 P16LX Horseshoe head ring 20x7x7
- 115-005886-00 P16MX Horseshoe head ring 20x7x5
- 115-005890-00 P16SX Horseshoe head ring 20x7x3
- 115-005887-00 P07LX Paediatric horseshoe head ring 14x5x3
- 115-005888-00 P07SX Paediatric horseshoe head ring 10x4x2.5
- 115-005889-00 P31XX Infant head ring 8x3x2



- 115-005896-00 P29LX Ophthalmic head pad 23x23x4
- 115-005897-00 P29MX Ophthalmic head pad 22x19x6
- 115-038076-00 P29LX Ophthalmic pad, paediatric 15x15x3.5
- 115-005898-00 P30XX Pillow for supine position 24x22x7

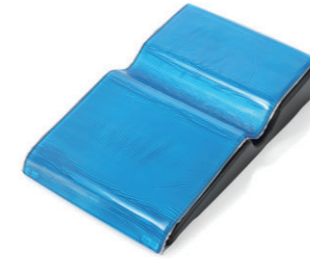

- 115-005910-00 P05XX Lateral positioner 72x46x15

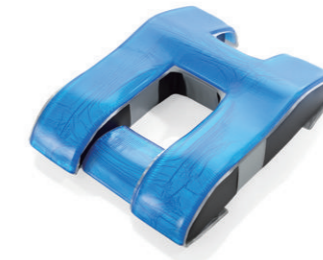

- 115-005788-00 P10XX Pad for intervertebral disc 63x46x15



- 115-038080-00 P33XX Prone position pad, hard inner 60x49x18



- 115-005864-00 P06XX Prone position pillow 28x24x14
- 115-005830-00 P11XX Prone position pillow 25x20x10
- 115-038074-00 P19XX Prone pillow, full support 23x20x11
- 115-038075-00 P08XX Paediatric prone pillow 21x18x11



- 115-005892-00 P25XX Universal supine pad 18x18x8

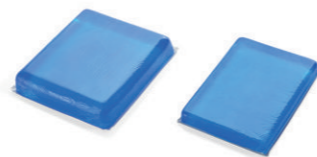

- 115-005900-00 P26LX Universal Head Pad 25x23x6
- 115-005832-00 P26SX Universal Head Pad 25x18x3

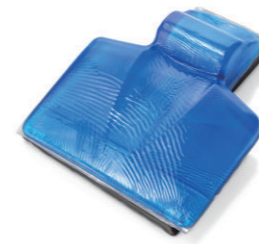

- 115-038077-00 P15XX Struma pad 48x39x9



- 115-005803-00 P35LX Short gel body roll 30x15x7
- 115-005807-00 P35MX Short gel body roll 30x10x7
- 115-005804-00 P35SX Short gel body roll 30x10x4
- 115-038079-00 P04XX Gel body roll, paediatric 20x10x7



- 115-005805-00 P17LX Long gel body roll 50x15x7
- 115-005808-00 P17MX Long gel body roll 50x10x7
- 115-005806-00 P17SX Long gel body roll 50x10x4

Comfort Solution Accessories



- 115-005796-00 P23XX Body strap 60x7x1
- 115-083121-00 P18XX Elbow protection strap 40x15x1.5, a pair
- 115-083122-00 P13XX Ankle protection strap 45x7x1, a pair
- 115-005908-00 P27XX Wrist protector 25x5x1



- 115-005790-00 P28XX Chest-hipbone pad 50x20x7



- 115-005794-00 P14XX Pad for countertraction post 27x20x1.5



- 115-083123-00 P12XX Heel pad 18x10x7, a pair



- 115-038078-00 P01XX Universal hip pad 50x40x1.5



- 115-005826-00 P21XX Table pads, 3 pieces
Head: 23x50x1.5
Torso: 100x50x1.5
Lower limb: 50x50x1.5



- 115-083144-00 P20LX Universal arm board pad 60x16x1, a pair
- 115-083143-00 P20SX Universal arm board pad 40x16x1, a pair



- 115-005811-00 P03LX Arm/leg pad 50x15x4
- 115-005812-00 P03SX Arm/leg pad 40x15x4

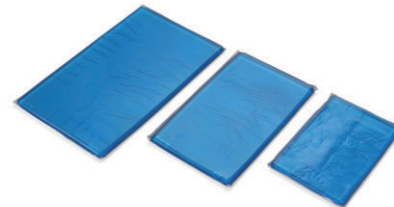

- 115-005820-00 P24LX Universal square pad 50x30x1.5
- 115-005819-00 P24MX Universal square pad 40x24x1.5
- 115-005818-00 P24SX Universal square pad 30x20x1.5



- 115-047824-00 P22XX Lateral positioner
Lateral positioner for the leg, 64x40x22

Comfort Solution Accessories