

# CUBE 30 TOUCH



## USER MANUAL

Rev. 2.3

Automated instrument for ESR determination  
with modified Westergren method

Software version 2.xx.xx

**FOR IN VITRO DIAGNOSTIC USE ONLY**



This page is intentionally left blank.

## CUBE 30 TOUCH models:

This manual is applicable to the following CUBE 30 TOUCH instrument models:

Catalog number	Description
10395	CUBE 30 TOUCH

## CUBE 30 TOUCH Accessories:

Catalog number	Description
10293	Test device NEXT 500 (500 tests)
10294	Test device NEXT 1K (1000 tests)
10296	Test device NEXT 5K (5000 tests)
10297	Test device NEXT 10K (10000 tests)
10403	Thermal paper
20550510	External barcode reader
10435-10436	ESR Control CUBE

## Manual revisions list:

MANUAL revisions	Description of changes
1.0 - 03/2018	Initial revision
1.1 - 07/2018	Description of new functions of settings - Troubleshooting update
1.2 - 01/2019	Addition of Rx symbol; insertion of Intended Use and Performances sections
1.3 - 02/2019	“Capillary blood” phrasing removed from Intended Use, added “semiquantitative” in Intended Use
1.4 - 06/2020	Corrected typing mistake in Chapter 4 (fill volume)
1.5 - 07/2021	Update due to new graphic design. Added section for: <ul style="list-style-type: none"> <li>- fusible replacement;</li> <li>- printer paper roll replacement;</li> <li>- ordinary cleaning.</li> </ul> Update of the warnings section.
2.0 - 03/2022	Update due to new software release 2.01.00
2.1 – 05/2022	Update of the intended purpose
2.2	Update of: <ul style="list-style-type: none"> <li>- list of accessories</li> <li>- technical features (power input)</li> <li>- label layout</li> <li>- installation procedure</li> <li>- sample preparation procedure</li> <li>- quality control paragraph</li> <li>- references</li> </ul>
2.3	Disclaimer added at Paragraph 2.1



*Manufacturer*

**DIESE DIAGNOSTICA SENESE SpA**

Strada dei Laghi 39, 53035 Monteriggioni (SI) Italy

Tel. +39 0577 307109, Fax. + 39 0577 307106

[www.diesse.it](http://www.diesse.it)

**TECHNICAL SUPPORT**

Strada dei Laghi 39, 53035 Monteriggioni (SI) Italy

Tel. +39 0577 307109, Fax. + 39 0577 307106















Numero Verde: 800 606932

e-mail: [technicalsupport@diesse.it](mailto:technicalsupport@diesse.it)

If any serious incident in relation to this device has occurred in the European Union market territory, please report without delay to the manufacturer and competent authority of your Member State.

No page in this manual may be reproduced in any form or by any means, electronic, mechanical or otherwise, for any use whatsoever without prior written permission from DIESE Diagnostica Senese S.p.A.

## Symbols:

Key of graphic symbols	
	Instrument meeting the requirements of the EC Directive 98/79 on in vitro diagnostic medical devices.
	In vitro diagnostic medical device
	Manufacturing date
	Serial number
	Manufacturer
	Instrument that complies with MET standards for the Canadian and US markets
Key of electric and safety symbols	
	Protective conductor
	WEEE: Waste electrical and electronic equipment – Separate Collection is required pursuant to Legislative Decree No. 49 of March 14, 2014 (Italy), on “implementation of Directive 2012/19/EC.”
	Attention: please read this manual carefully and comply with the safety symbols.
	Caution: risk of electrical shock
Key of graphic symbols used in this document	
	WARNING: potential risk of personal injury; all the conditions indicated in the relative text must be read and understood before proceeding.
	CAUTION: potential risk of damage to the instrument; all the conditions indicated in the relative text must be read and understood before proceeding.
	N.B. important information.
	BIOHAZARD: risk of contamination with potentially infected substances.



## LIMITATIONS AND WARNINGS

Before installation and use of the instrument, **for proper and safe use**, it is advisable to **carefully read** the warnings and instructions in this user manual. It is important that this user manual be kept together with the instrument for future reference.

In the event of sale or transfer, make sure that this manual accompanies the instrument to allow new users to be informed about the instrument's functions and the related warnings.



It is recommended to allow only **qualified and skilled laboratory personnel** to use the instrument.



The safety and performance requirements of the instrument can no longer be guaranteed when the instrument is powered using a different cable from the one supplied, compatible with the power supply of the country of installation.



## BIO-CONTAMINATION HAZARDS

	<p>Potentially infected material may be handled. When analyzing patient samples, all precautions must be taken regarding biological risks. The samples do not require preparation. The samples must be disposed of in accordance with laboratory instructions and with local laws.</p> <p>Observe personal and group safety measures required for the operator and appropriate for the work environment. Comply with directives on safety and with applicable laws in force.</p>
	<p>In the case of leakage of biological material, during the working cycle, use 70% isopropyl alcohol to clean external surfaces of the instrument using appropriate personal protective equipment and observe regulations on sanitization.</p>
	<p>All supplied materials must be disposed of in accordance with local laws.</p>

# Content

<b>1</b>	<b>INTRODUCTION</b>	<b>10</b>
1.1	Intended purpose	10
1.2	Presentation of the instrument	10
1.3	Clinical significance of ESR	11
1.4	Normal ESR values (Westergren citrated)	12
1.5	Materials required for use of the instrument	13
1.6	Warnings	13
1.7	Personal protective equipment (PPE)	13
1.8	Ordinary maintenance	13
1.8.1	Cleaning and decontamination procedure	14
<b>2</b>	<b>TECHNICAL DATA</b>	<b>15</b>
2.1	Technical description	15
2.2	External connections of the instrument	16
2.3	Updating software	17
2.4	Technical features	18
2.5	Instrument composition	19
2.6	Unit of measure	19
2.7	Instrument label	19
<b>3</b>	<b>INSTALLATION</b>	<b>21</b>
3.1	Transport and handling	21
3.2	Packaging characteristics	21
3.3	Materials provided	21
3.4	Unpacking the instrument	22
3.5	Environment	23
3.6	Installation procedure	24
3.7	Disposal	24
3.8	Replacement of the fuses	25
3.9	Printer paper replacement procedure	26

4	USE	28
4.1	Sample preparation	28
4.2	Test tube compatibility	28
4.3	Test tube labelling	29
4.4	Home page	31
4.5	START Performing an analysis cycle	33
4.5.1	Inserting the test tubes	35
4.5.2	Starting the analysis cycle	35
4.5.3	Type of tube	39
4.5.4	Inserting a new sample (random access)	42
4.5.5	Results	44
4.5.6	Guided reading of the printed results	45
4.5.7	Interruption of a work session	48
5	Archive	49
5.1	Sample archiving functionality	50
5.1.1	'Export' button	50
5.1.2	Samples selection	53
6	Settings	56
7	QUALITY CONTROL	60
7.1	QC registration procedure	60
7.2	Performing QC analysis	61
7.3	QC archive	62
8	USER MANAGEMENT	67
9	TROUBLESHOOTING	70
9.1	Temperature out of range	71
10	CONNECTION TO HOST COMPUTER	73
11	PERFORMANCES	74
11.1	CUBE 30 TOUCH precision	74
11.2	CUBE 30 TOUCH correlation	75
12	BIBLIOGRAPHY	77

# 1 INTRODUCTION

## 1.1 Intended purpose

The CUBE 30 TOUCH is an automated instrument for the quantitative Erythrocyte Sedimentation Rate (ESR) determination with the modified Westergren method using venous whole blood anticoagulated with K2EDTA or K3EDTA.

ESR is a non-specific parameter of an inflammatory status, used as an aid for the monitoring of the physiological or pathological state of the patient.

The instrument is to be used only by professional laboratory users.

## 1.2 Presentation of the instrument

The CUBE 30 TOUCH (Figure 1) is an instrument designed to measure the erythrocyte sedimentation rate (ESR) of blood samples anticoagulated with EDTA, directly from the EDTA tube in only 20 minutes, modify Westergren method (Ref.13) The instrument can analyze a load of 30 samples at once or on a random access and continual loading basis. By analysing the sample directly from the EDTA blood collection tube, multiple samples or sample transfers are not necessary. With its color touch screen, the user can select various instrument functions, which are described in more detail in the following sections. The analysis is fully automated (mixing and reading) and the results provide excellent correlation to the one-hour Westergren reference method (Ref. 1-10).

The maximum system capacity is 60 results per hour.



*Figure 1 - CUBE 30 TOUCH*

The instrument is designed to have temperature correction always enabled; it relates the results to a temperature of 18°C according to Manley's Nomogram (Figure 2).

However, it is possible to de-select temperature correction according to laboratory needs.

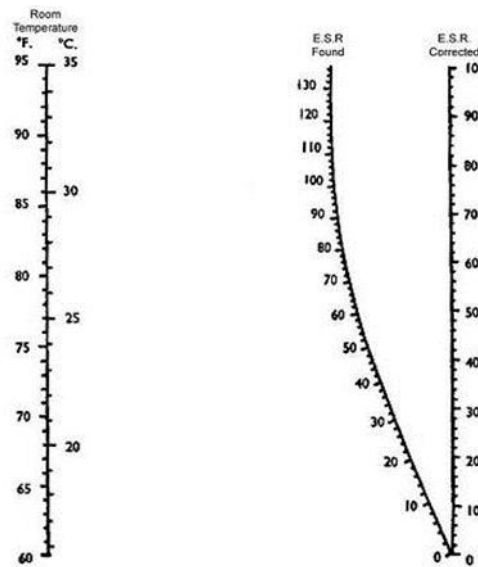

Figure 2 - Manley Nomogram

### 1.3 Clinical significance of ESR

The erythrocyte sedimentation rate test measures the distance travelled by red blood cells over a certain period. In normal conditions, red blood cells tend to move apart reciprocally due to the presence of negative electric charge from the numerous residues of sialic acid present at a membrane glycoprotein level. When the protein composition of plasma changes with the production of “acute phase proteins” at a hepatic level, following an inflammatory process or tissue damage, the bond of these proteins (fibrinogen, immunoglobulins) with the surface of the red blood cells alters the negative charge of the membrane potential (Z) and the red blood cells can bind, forming a rouleaux pattern. These rouleaux cells aggregate to form microspheres of a uniform radius, which start to sediment when their density exceeds that of plasma. The ESR value goes up in all cases where there is an increase in acute phase proteins, in particular fibrinogen (which is considered to account for 70% of the sedimentation phenomenon), and immunoglobulins (which increase in the case of oncological/hematological diseases and acute infections). ESR is therefore a non-specific measurement of an inflammatory state; the rate is high in various pathological conditions such as inflammatory diseases (infections, rheumatic diseases), a relative/absolute increase in globulins (nephrotic syndrome, myeloma), tissue necrosis (myocardial infarction, tumours). ESR is useful for predicting a diagnosis of some diseases, such as polymyalgia rheumatica, temporal arteritis, rheumatoid arthritis, and Hodgkin’s disease, and is useful as an effective marker

for pharmacological treatment in many diseases such as rheumatoid arthritis, vasculitis, collagenosis and septic arthritis. The erythrocyte sedimentation rate is usually higher in women compared to men, increases in pregnancy, and tends to rise with age in both genders (Ref. 25).

#### 1.4 Normal ESR values (Westergren citrated)

With the Westergren reference method, the test is performed on blood diluted in citrate, with 4 parts blood to one part anti-coagulant. The diluted blood is then aspirated inside a special, graduated, 2.5-mm diameter pipette and kept upright. The erythrocyte sedimentation level is recorded after exactly one hour, measuring the distance between the lower side of the plasma meniscus and the meniscus of the sedimented red blood cells.

Guidelines for ESR Reference Values for the Westergren ESR Method\* are as follows:

##### Normal 0-20mm/hr

\* Follow CLSI Procedures for the Erythrocyte Sedimentation Rate Test; Approved Standard. CLSI document H02.

International guidelines identify 3 ranges of ESR: low (ESR <20 mm/hr), medium (20 <ESR <60 mm / hr) and high (ESR > 60 mm/hr) (Ref. 16) regardless of gender and age.

The scientific literature attributes the normal value of ESR for the age of less than 50 years between 1 and 15 mm/hr for men and between 1 and 25 mm /hr for women. For older ages these values increase and they stand in between 1 and 20 mm/hr for men and between 1 and 30 mm/hr for women (Ref. 18). In pathological conditions these values can increase up to values of 100 mm/hr and more.

Reference values should be established locally in accordance with the individual laboratory's accrediting agencies. Refer to CLSI document H02 for age and gender-specific reference values.



A doctor must interpret the clinical significance of an ESR value obtained from abnormal samples, including but not limited to icteric or lipemic samples, samples with anemic conditions, low hemoglobin concentrations, hemolysis, or any other pathological condition which can interfere or impede a clear reading of the sedimentation. ESR testing performed on anomalous samples using manual or automated methods are subject to a high degree of variability. In the CUBE 30 TOUCH, these samples may be undetected, or they may yield varying results; for this reason, a visual inspection of the sample at the conclusion of the test is recommended, to verify the presence of a clear interface between the plasma and sedimented cells.

## 1.5 Materials required for use of the instrument

To use the instrument, materials must come **exclusively** from those manufactured by DIESSE DIAGNOSTICA SENESE S.p.A. (Always read the instructions for use which accompany each product before its use); any other part or accessory used in the instrument may cause damage or incorrect results. The manufacturer therefore declines all responsibility for damages deriving from inappropriate use.

## 1.6 Warnings



While the CUBE 30 TOUCH system provides a high level of safety in handling biological samples, please take all necessary precautions when handling potentially infected material. Waste material at the end of the cycle must be processed in accordance with the local waste requirements.

It's recommended to restart, switch the instrument off and on again, at the end of the working day to avoid problems of overloading the CUBE 30 TOUCH memory.

## 1.7 Personal protective equipment (PPE)

Normal use of the instrument does not require the user to come into contact with a biological sample. In any case, the user must wear personal protective equipment, in compliance with the laws of his country. PPE consist of at least:

- Gloves
- Safety glasses
- Lab coat

## 1.8 Ordinary maintenance



The CUBE 30 TOUCH has been designed and built to require minimal maintenance.

Before any maintenance work:

- Turn off the instrument and disconnect it from the power source.
- Use suitable personal protective equipment during operation.

It is recommended to restart, turning off and on the instrument at the end of the day to avoid memory overload problems of the CUBE 30 TOUCH.

### 1.8.1 Cleaning and decontamination procedure

External cleaning is recommended for safety reasons.

The decontamination procedure must be carried out by the user in the event of biological material leakage, displacement of the instrument or when deemed necessary.



In the event of biological material leakage during the operating cycle, clean the external surfaces of the instrument with personal protective equipment.

#### *Decontamination procedure:*

1. With the instrument turned off, clean the instrument with a disinfectant liquid used in the laboratory and allow it to dry. For the touch screen use a dry microfiber cloth.
2. Leave the instrument turned off for at least 1 hour before starting a new operating cycle or performing any other operation on the instrument.



For assistance with the inside of the instrument not easily accessible to the operator, contact Technical Services.

## 2 TECHNICAL DATA

### 2.1 Technical description

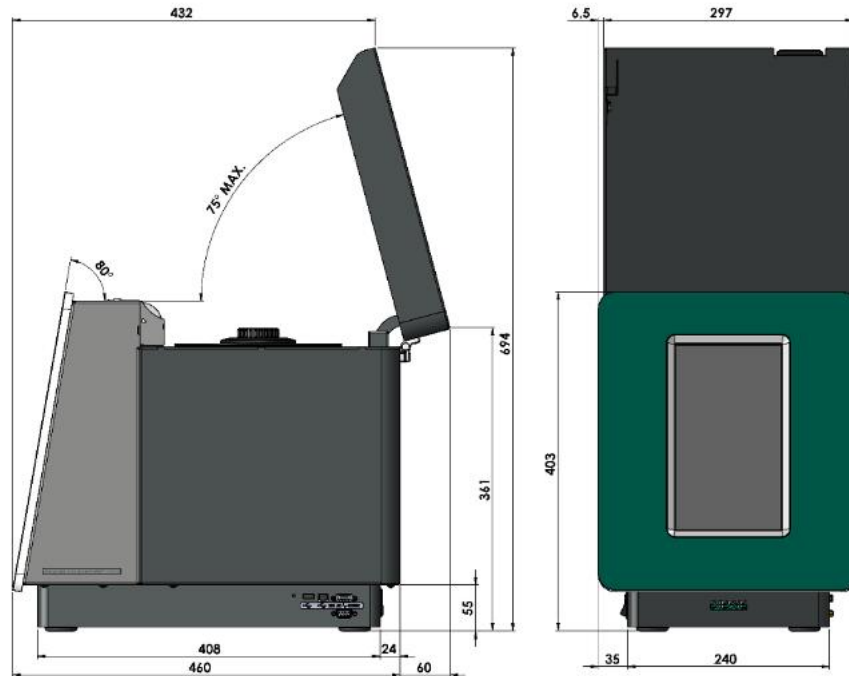

Figure 3 - Instrument Layout

The CUBE 30 TOUCH consists of a single body containing all the operating functions necessary for analyzing the sample.

#### *Test Tube Carousel*

The instrument has 30 positions arranged in two concentric circles of 15 positions each. The test tube carousel is equipped with a plastic adaptor carousel; required for use with EDTA tubes with conventional closure.

#### *Reading unit*

A motor lifts the reading unit, which uses 2 optical sensors to verify the suitability of the sample and detect the level at time zero and at the end of sedimentation.

#### *Sample detection*

Sample detection happens after the cycle has been started, through the optical sensors. The instrument carries out a scan of the test tube inserted in each position, verifying that it contains an adequate volume of blood.

### *Sample identification*

Sample identification is done by an internal barcode reader which reads the barcode when a sample is detected by an optical sensor.

The sample ID code may be manually entered with a virtual keyboard or by using an external barcode reader (accessory).

**The sample must be identified by barcode only. Do not enter any other type of data (e.g. patient's name and surname), in case of manual entry using the virtual keyboard.**

### *Acoustic warning*

The function of the acoustic warning is to alert the operator during various stages of the operating cycle or in the event of errors.

### *Temperature sensor*

This sensor is used to measure the temperature and is fitted in proximity of the test tube carousel. In the event that the temperature is outside the operating range described in paragraph 2.4, the condition is signaled to the user with a message displayed on the screen.

### *Printer*

The analysis results are printed at the end of each operating cycle or working session.

## 2.2 External connections of the instrument

The power connector is on the back of the instrument (Figure 4).



*Figure 4 - Power connector*

The ON/OFF switch is on the left side of the instrument's base (Figure 5).



*Figure 5 - Power button*

There are four connection ports on the right side of the instrument's base.

- Two connectors for a Computer/HOST: one is a Serial RS232 (9pin) type; the other is an USB b-standard type.
- A connector for an external barcode reader (EXT. BC).
- A USB a-standard port for connecting to a USB mass storage device (usable for software updates and exporting files) (Figure 6).



Figure 6 – Connectors for external supports

## 2.3 Updating software

Updating software is a simple, direct procedure:

- Save the new software into a USB mass storage device
- Save the contents of “cube\_30\_touch\_version\_number” folder in a USB memory device

Note: the folder “cube\_30\_touch\_version\_number” depending on the update can contain:

- a. One file: mcfw.bin
- b. Two files: mcfw.bin and System folder which contains the graphic object necessary for the functioning of the instrument.
- c. Three files: mcfw.bin, System folder and Help folder that contains the files necessary to update the instrument help.

The update of the Help is not an automatic procedure, but the user must use the appropriate function present in the Service. Refer to the Service Manual for instructions.

- With the instrument switched off, insert the USB device into the appropriate port (Figure 7)
- Power on the instrument and wait for a few seconds. The instrument will update automatically.



Figure 7 - USB port

The version number is visible on the Service page

## 2.4 Technical features

USE	Internal use
POWER SUPPLY	Europe: 230Vac@50Hz; USA/Canada: 110-120Vac@60Hz Power input: 100VA
DIMENSIONS (mm)	310 x 470 x 403 (l x w x h)
WEIGHT	15 kg
TEMPERATURE	15-35°C (operating) 5-45°C (storage)
RELATIVE HUMIDITY (RH)	20%-80% without condensation
ALTITUDE	up to 2000 meters
NOISE LEVEL	below 80 decibels
POLLUTION LEVEL	2 pollution degrees
MEASUREMENT RANGE	1 - 140 mm/h 1 -90 (for pediatric tube)
CENTRAL UNIT	ARM Cortex-M4 180 MHz Microprocessor
DISPLAY	10.1" vertical, wide
OPTICAL UNIT	2 pairs of optical elements
INTERFACES	USB Host; USB Client; 2x RS232
PROTECTION CLASS	I
SAFETY STANDARDS	EN 61010-1:2010; EN 61010-2-081:2015; EN 61010-2-101:2015
EMC	EN 61326-1:2013; EN 61326-2-6:2013
INSTALLATION CATEGORY	II
PRINTER	Alphanumeric with 57 mm wide thermal paper, 36 characters / line, speed XX mm / sec.

## 2.5 Instrument composition

The instrument is composed of the following materials expressed in percentages:

<i>Material in %</i>	<b>CUBE 30 TOUCH</b>
IRON	60
COPPER	3
ALUMINIUM	10
PLASTIC MATERIALS (PVC, ABS...)	20
SILICON	2
Gold	0.1
Tantalum	0.2
Cadmium	0.2
Others (No Latex)	4.5

## 2.6 Unit of measure

The units of measure are expressed according to the INTERNATIONAL MEASURING SYSTEM as indicated in the technical standard CEI EN ISO 80000-1:2013.

## 2.7 Instrument label

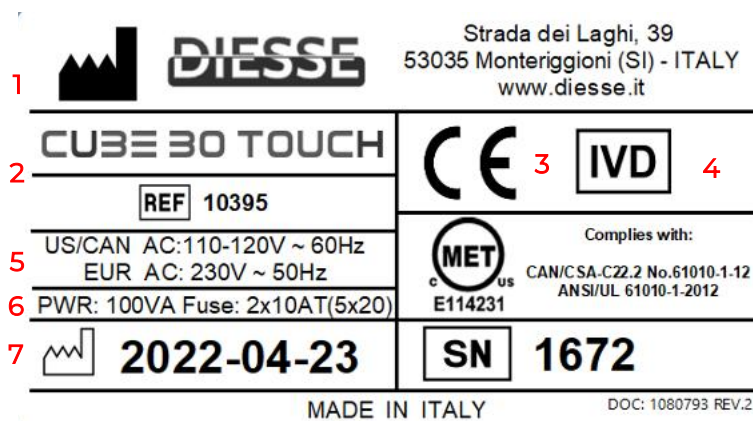

Figure 8 - Instrument label

Legend of the information contained on the label:

1. Information about the manufacturer
2. Name and code of the instrument
3. Certification of Conformity to the CE legislation for the European Union
4. Mark of declaration that the instrument is to be used for in vitro diagnosis only
5. Declaration of the power requirements for the US, Canada and Europe
6. Specification of the maximum power consumed and the characteristics of the protection fuses at the input of the instrument

7. Serial number and production date

# 3 INSTALLATION



The CUBE 30 TOUCH is a precision instrument and must be handled as such. Inappropriate operations may damage the internal optoelectronic components and cause mechanical damage. Follow the instructions in this chapter in order to ensure the safety of the instrument and of the operator.

## 3.1 Transport and handling



The instrument must be transported and handled in its original packaging. Do not let the instrument or packaging become wet or be exposed to a damp environment. If the packaged instrument has been exposed to storage or transit temperatures below 10°C for more than 24 hours, allow the unit to stand at room temperature for one hour prior to installation.

## 3.2 Packaging characteristics

The instrument is packed in:

1. an external cardboard box
2. molded housing in CFC- and HCFC-free, closed-cell polyethylene foam

Box Dimensions	
600x400x520	mm
4.0	Kg

**Save the original packaging including the internal parts.**

## 3.3 Materials provided

The CUBE 30 TOUCH is supplied with the following materials:

- User Manual
- One power cable adherent to IEC International Standards (Female Plug IEC 320 C-13; Male Plug Schuko EEC 7-VII; Rating: 10A / 250V AC).
- One power cable SVT PLUG USA/OUTLET VDE UL 2mt
- Two Delayed 5x20 mm UL fuse blocks 10A
- USB cable
- Plastic Adaptor (A in Figure 9 for use with conventional stopper EDTA tubes)

- Touch screen stylus; “CUBE pen”
- Inspection Certificate
- USB mass storage with multi-lingual manual
- Packing list



*Figure 9 - Kit*

### 3.4 Unpacking the instrument

1. Open the box from the top.



*Figure 10 - Unpack instrument: opening box*

2. Remove the block of polyethylene foam covering the instrument.
3. Remove the accessories stored inside.
4. Remove the instrument from the box.

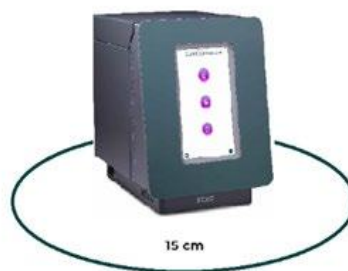

*Figure 11 - Instrument extraction*

5. Remove the protective bag which wraps the instrument.
6. Verify that the packing list and supplied materials match.

### 3.5 Environment

For normal safety requirements and given the type of testing it performs, the instrument must be positioned in a dust-free environment away from heat sources, and free from any exposure to liquids. Position the instrument on a perfectly level bench, not subject to shaking or vibrations. Observe a 15 cm or 6" perimeter around the instrument as a safety precaution, as indicated in the Figure 12. In addition, it is advisable to position the instrument a 1 meter distance from devices that generate electromagnetic waves (e.g. laboratory refrigerators, centrifuges).



*Figure 12 - Instrument placement*

The safety of the instrument and of the operator is not guaranteed if one or more of the following conditions are violated.

- The mains must be compatible with the voltage and current specifications indicated on the metal plate affixed on the rear of the instrument.
- Verify the compatibility of external accessories such as a BC reader or USB devices prior to connecting.

### 3.6 Installation procedure



1. Position the instrument on a solid surface, as described above.

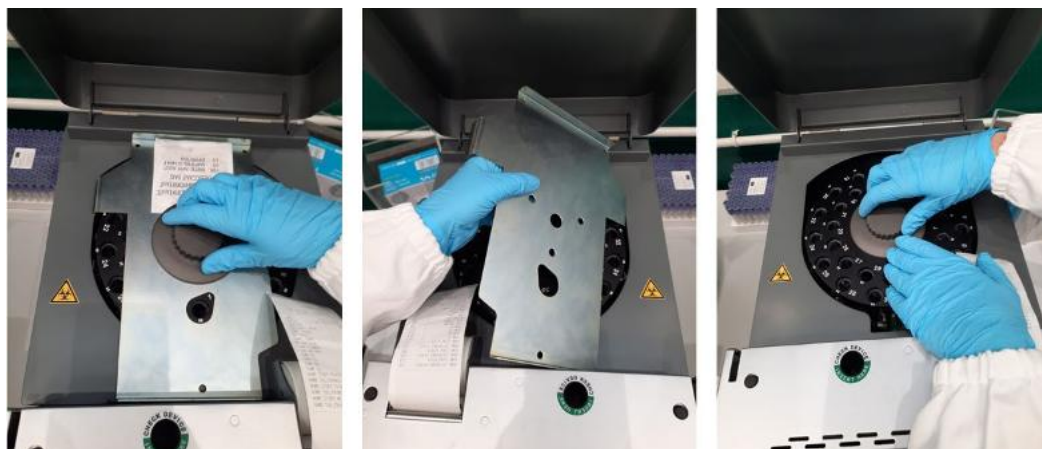

Figure 13 - Instrument installation

2. Verify that the power switch is in the "OFF" position.
3. Open the cover, unscrew the central knob, and remove the stabilizing plate used for transport. Insert the plastic adaptor per ("A" in Figure 9) only when using "Conventional Closure" type tubes (with low height rubber stoppers) and screw the central knob back in place to secure the carousel. QC tubes supplied by Diesse may be run with or without the plastic adaptor.
4. Connect the power supply cable.
5. Optional - Before switching on the instrument, connect the external barcode reader (accessory).



**IN CASE OF FIRE OR GENERAL DANGER, TURN OFF THE INSTRUMENT AND UNPLUG THE POWER CABLE.**

### 3.7 Disposal

The CUBE 30 TOUCH instrument, to be functional, relies on the use of an electrical power source and therefore, in compliance with the EUROPEAN DIRECTIVE 2012/19/CE of July 04, 2012 and later amendments by the European parliament, it is classified as Electrical-Electronic Equipment.

Disposal of the instrument at the end of its life cycle, must be executed in accordance with local waste disposal regulations.

### 3.8 Replacement of the fuses

When replacing the fuses is necessary, proceed as follows:

1. Turn off the instrument and disconnect from the power supply



Figure 14 – Replacement of the fuses: fuses box

2. Use a socket head screwdriver to extract the fuse box.



Figure 15 – Replacement of the fuses: extraction box

3. Replace the damaged fuses with new ones supplied with the instrument.

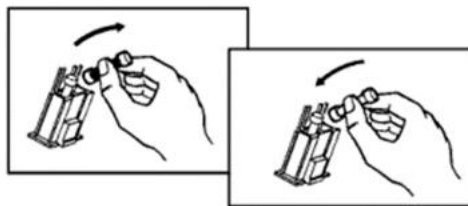

Figure 16 – Replacement of the fuses

4. Replace the fuses box



Figure 17 – Replacement of the fuses: repositioning box

5. Reconnect the instrument to the power supply
6. Turn on the instrument again.

If at the time of turning on the fuses they trip again, contact the Technical Assistance.

### 3.9 Printer paper replacement procedure

The following paragraph describes the correct procedure to replace the paper roll in the thermal printer, on board of CUBE 30 TOUCH instrument.

When red lines appear on the printed receipt, it is time to replace the paper roll.

Before proceeding with the replacement of the paper roll, it's very important to check the correct position of the black bar of the printer, under which the roll paper scrolls, inside the appropriate housing.

If one of the two ends of the black bar is inadvertently moved up from its housing (Figure 19) or if both ends of the black bar are slightly raised from their housing (Figure 18), the roll paper will be blocked and cannot be removed or inserted. Therefore, always remember to check that the black bar is completely lowered in both side housings, as shown in Figure 20.



*Figure 19 - printer paper replacement: pin off axis*



*Figure 18 - Printer paper replacement: roll off axis*



*Figure 20 - Printer paper replacement: correct position*

Once the above check has been carried out, replace the paper roll as described below:

1. Remove the old paper roll from the appropriate housing.
2. Begin the process of inserting the new roll of paper under the black bar of the printer, as shown in Figure 21:
  - a. Insert the end of the paper roll under the black bar;
  - b. Automatic paper feed by the printer;
  - c. Pull the paper for a few centimeters from the position left by the automatic feed.



*Figure 21*

3. Insert the new roll of paper inside the appropriate housing.

The paper roll replacement procedure is complete

**Attention:** once the paper roll replacement procedure has been completed, check that the position of the black bar of the printer inside the appropriate housings has remained the correct one (*Figure 20*). Incorrect position of the black bar (*Figure 19* and *Figure 18*) would in fact compromise the normal functioning of the printing procedure.

## 4 USE

### 4.1 Sample preparation

The following criteria must be met to ensure accurate results:

1. The ESR test is performed within 4 hours of collection with samples at ambient temperature (18-25°C), or on blood samples which have been stored at 2-8°C for a maximum of 24 hours since the time of collection. Refrigerated samples should be restored to ambient room temperature prior to analysis (Ref. 28, 29).
2. The test can be performed if the test tubes contain a volume of blood:
  - from 1 mL to 4 mL for Standard Tube 13x75 mm in EDTA
  - from 1,5 mL to 4mL for Sarstedt S Tube (1,6mL, 1,8mL, 2,6mL, 2,7mL, 3,4mL)
  - 500uL for MAP Microtainer® tube
3. Whether using the CUBE 30 TOUCH system in the batch or random access mode,



be sure to mix the samples before starting the test. The sample must be mixed gently by complete inversion of the tube for a minimum of 8 times, so that any air bubble move along the entire tube from one end to the other. Do not shake, vortex, or agitate the sample vigorously, as this could cause excessive bubbling or hemolysis.

Mixing is important to minimize the risk of potential clotting.



**WARNING:** Ensure the test tube is hermetically sealed.

### 4.2 Test tube compatibility

	TYPE TEST TUBES
<b>"STANDARD" FORMAT</b> Dimensions 13x45mm	VACUETTE™ (GREINER BIO-ONE)
	VACUTAINER® (BD)
	VENOSAFE® (TERUMO)
	VACUTAINER® CONVENTIONAL CLOSURE (BD)
	VACUTEST® (KIMA)
	VACUMED® (FL MEDICAL)
<b>SARSTEDT 1,6mL</b>	SARSTEDT S: MONOVETTE® 1,6mL

SARSTEDT 1,8mL	SARSTEDT S: MONOVETTE® 1,8mL
SARSTEDT 2,6mL	SARSTEDT S: MONOVETTE® 2,6mL
SARSTEDT 2,7mL	SARSTEDT S: MONOVETTE® 2,7mL
SARSTEDT 3,4mL	SARSTEDT S: MONOVETTE® 3,4mL
MAP	BD Microtainer® MAP (Microtube for Automated Process).

### 4.3 Test tube labelling



The CUBE 30 TOUCH's optical sensors can detect blood sample levels in test tubes with a maximum of one secondary label. Excessive thickness and possible wrinkles on secondary labels, may increase the test tube's external diameter, increasing the risk of a tube becoming lodged in the instrument. If the operator notes resistance when inserting a test tube, remove the added label before proceeding. Secondary labels must adhere perfectly to the test tube's surface to avoid possible label fragments accumulating in the instrument, and thus obstructing analysis of the sample. Secondary labels must be placed directly over the tube manufacturer label, leaving at least 5 mm free space for the optical sensors to detect the blood level in the sample tube (Figure 22).

When placing a label on a tube:

- Ensure the label is flattened smooth against the tube.
- Press the label down securely, including all the edges and corners to ensure that no part of the label is loose.
- Leave a label-free space on the back.

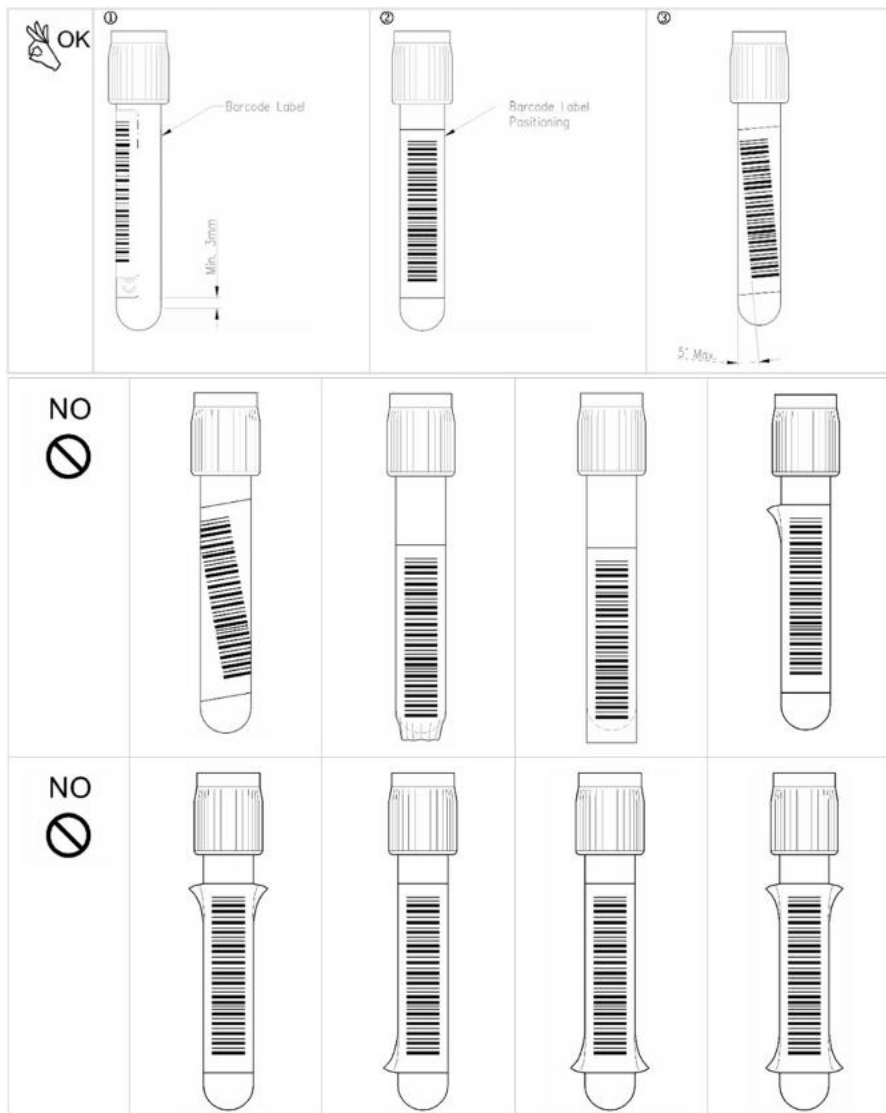

Figure 22

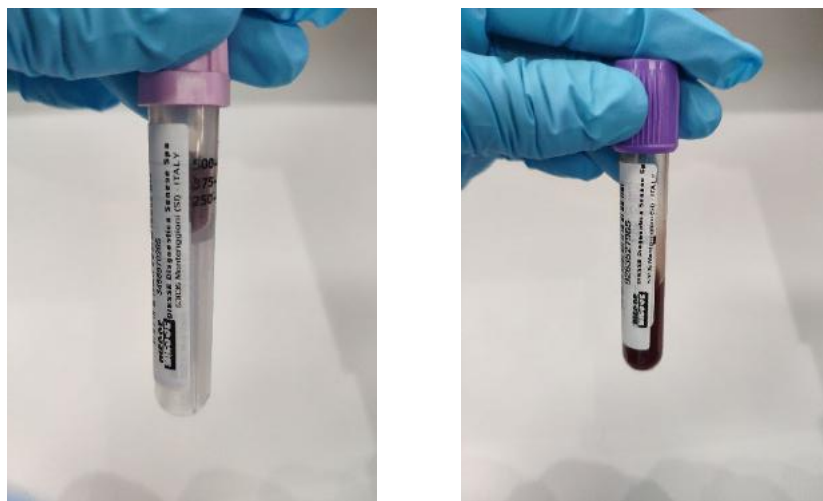



Figure 23 – Labeling test tubes

To ensure barcode readability, tubes must be inserted so that the barcode is positioned toward the mark on the front of each well in the instrument carousel (Figure 24). If a secondary label is not used, the sample should be inserted so the tube manufacturer's label is facing the mark.



Figure 24 Correct insertion of the test tube

 If the host connection is active (see chapter 'CONNECTION TO HOST COMPUTER'), the sample barcodes must have a maximum length of 15 characters.

#### 4.4 Home page

Turn on the CUBE 30 TOUCH with the switch on the left side of the instrument. When the instrument is turned on, the LEDs around the screen will activate. Initially the colors will follow each other, then each color will have its own meaning to help the user to understand the status of the instrument even from a distance.

**Yellow** indicates that an analysis cycle is in progress.

The **green** color indicates that the cycle is complete.

The **red** color is alarm symbol, a problem has been detected.

**White** indicates the standby condition of the instrument.

If the USER LOGIN function is active, an ID will be requested for the selected user (see Chapter 6 USER MANAGEMENT). The user can access the home page directly (HOME) when the USER LOGIN function is not active.

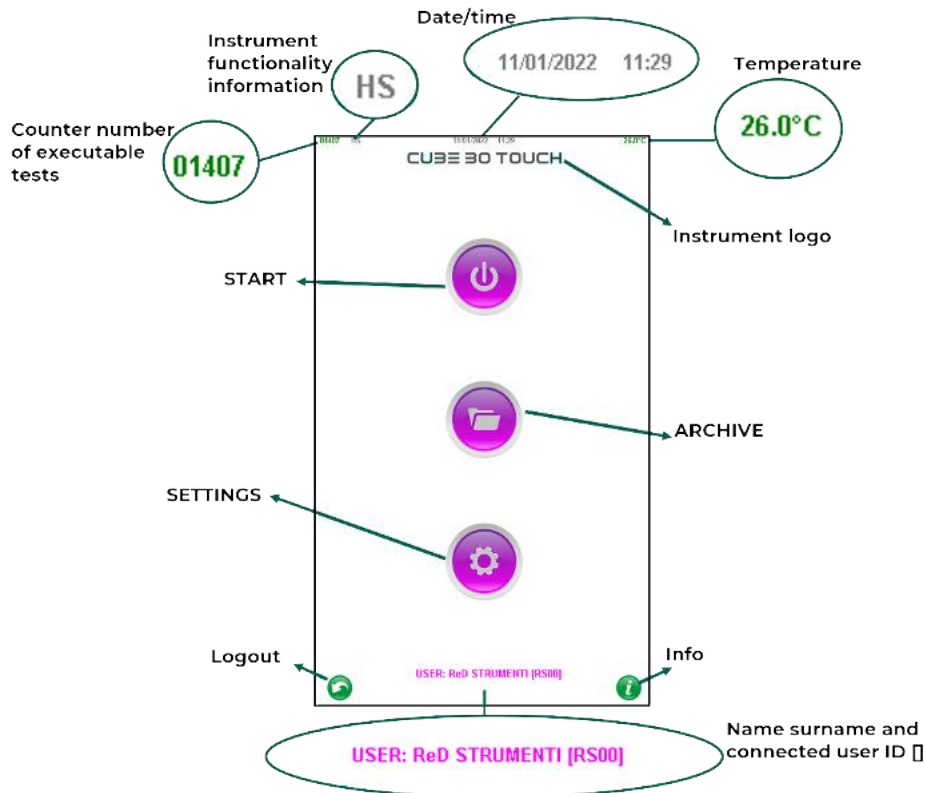

Figure 25 – Home page

The following information is present on the initial screen (Figure 25):

- **Counter number of executable tests:** it decreases for each result. The counter is red for the last 50 tests. To perform other tests the user must recharge the counter with a new Test Device Next (see chapter 6)
- **Instrument functionality information:** if active some settings relating to the working mode of the instrument are displayed:  
H= host, the connection with the host is active  
S= screenshot, the mode for taking screenshots of the instrument is active (Technical Assistance and Specialist mode)  
F= fast, the fast mode is active which allows faster test cycles (Technical Assistance and Specialist mode)
- **Date/Time:** indicates the current date and time
- **Temperature:** indicates the instrument internal temperature in °C or °F. The green color indicates that the temperature correction is active (default setting). Red indicates that the temperature correction is not active.
- **Instrument logo:** presentation of instrument logo identifying the commercial name

- **Info:** is a button that allows the user to display the instrument Help, a short interactive guide on how to use the instrument
- **Name surname and connected user ID []:** when the 'SAFE LOGIN' setting is active, the name, surname and connected user ID are shown. The ID consists of the initial name and surname letter of the logged user. The user with ID '00' is the Administrator; for details see chapter 8.
- **Logout:** button displayed if 'SAFE LOGIN' mode is active; it allows the registered user to log out

The home screen also contains buttons for the 3 main functions:

- **START:** Access the START cycle screen
- **ARCHIVE:** Access archived data
- **SETTING:** Review/edit system some settings

#### 4.5 START Performing an analysis cycle

Click START to enter the analysis mode (Carousel view).

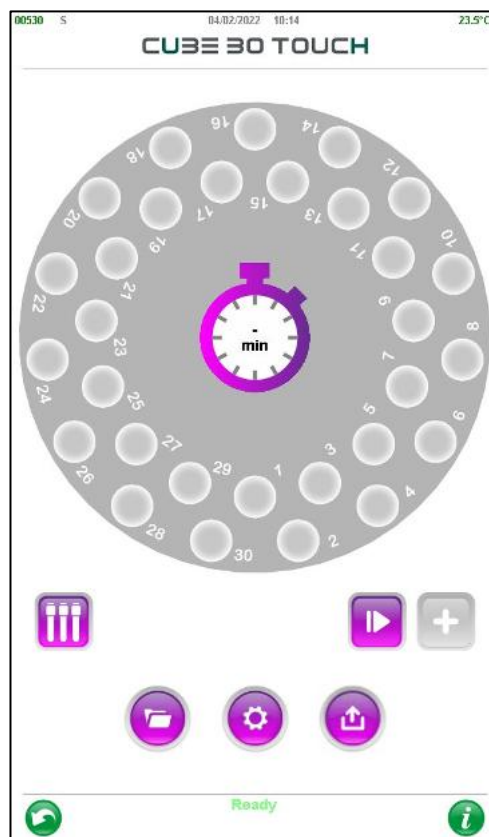

Figure 26 – Plate view

Description of the information and icons:



**Sample plate:** graphical representation of the sample holder plate of the instrument showing the numbers of the sample housings.



**Timer:** The timer in the center of the carousel displays the minutes remaining for all samples started during a cycle in the continuous mode. If samples are inserted in the random-access mode during the cycle, an individual timer will be displayed on the cap of each added sample.



**Start:** Begins the analysis cycle.



**Stop:** Stops the analysis cycle.



**Test tube view:** Allows the user to view all the samples at the same time (Tube view). In this mode, the user can see the blood level and the actual sedimentation level for each test tube.



**Add:** Enables the random-access mode. By pressing this icon, new samples can be inserted when a testing cycle is already in progress. During the scanning phases, reading at time  $t=0$  and during the 2 minutes preceding the reading at  $t=20$  minutes, the button turns grey and cannot be selected: the sample addition function is disabled.



**Export:** button active before and at the end of a work cycle. It allows the selection of two function:

- SEND TO HOST: allows to send the results of the last cycle to the Laboratory host. If the connection to the host is not active, no operation is required to send data.
- PRINT: prints the results of the last cycle. If the instrument is turned on or restarted for the first time, pressing the button requires no action.



**Settings:** selectable button when the instrument is stopped. Enables the 'Settings' screen to be displayed.



**Archive:** selectable button when the instrument is not in cycle. Allows viewing of instrument archives



**BACK:** Allows the user to return to the Home screen. During execution of a work cycle the button is not displayed.



**Information:** An interactive guide regarding the instrument operation.

**Instrument status label:** label at the bottom of the screen:

**Ready:** a work cycle can be started

**WORKING:** the instrument is processing samples

**Cycle n cancelled – Ready:** a session has been cancelled (n indicates the cycle number) and the instrument is ready for a new cycle.

**Cycle n completed – Ready:** the session n has been completed,. The instrument is ready for a new work cycle.

**Working – Temperature warning!:** attention the instrument is working with a temperature outside the established operating limits (15°C-35°C), see paragraph 9.1

#### 4.5.1 Inserting the test tubes

To start a cycle, open the lid and insert the test tubes in the instrument carousel. Orient the sample so that the barcode faces the mark (||) found at each tube position on the carousel (Figure 27).



Figure 27

#### 4.5.2 Starting the analysis cycle

Close the lid, and press PLAY .

The instrument performs a verification on each position to determine the number of samples present, the type of test tubes and barcode reading.

Each position containing a sample is colored in purple (see Figure 28).

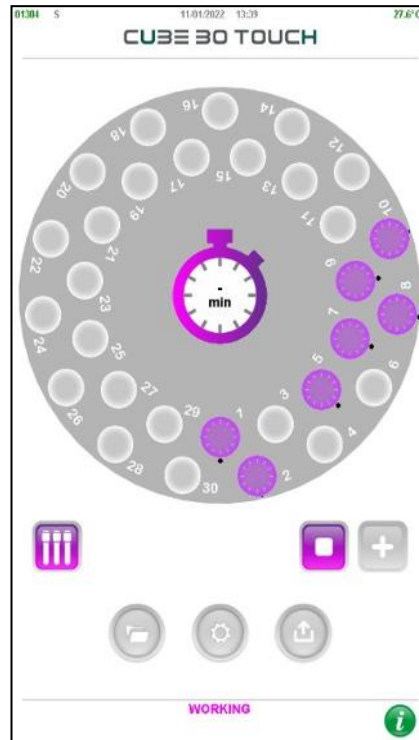

Figure 28 Tubes detected in the sample plate

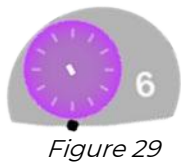

Figure 29

If the barcode reading is not successful, a black dot is shown next to the sample. (Figure 29) At the end of the barcode reading cycle, a window will display the unread positions ( Figure 30).

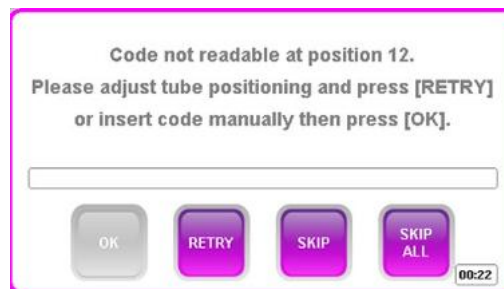

Figure 30 – Barcode not read

The user has the following options to select from:

- Open the lid, reposition the tube correctly in the carousel, press “**RETRY**” to have the barcode read again
- Press the text field and insert the code manually (keyboard will appear on the screen Figure 31) and then press “**OK**” or enter the code using the external barcode reader.



Figure 31 – Barcode insertion

- Do not assign an ID for this sample and move on to the next position by pressing “SKIP”.
- Do not assign an ID for any of the unidentified samples: press “SKIP ALL”

Note: If none of these options are selected within 30 seconds, the “SKIP ALL” choice is enabled, and the cycle progresses automatically.

The instrument then starts the mixing process, and a progress bar displays the time remaining. The carousel will make 20 complete rotations (180°) to fully re-suspend the samples. During this phase a progress bar will display the time remaining until the end of the operation (Figure 32)



Figure 32 – Mixing phase

At the end of the mixing phase, the instrument will perform a scan of each test tube to determine the level of blood at time zero of sedimentation.

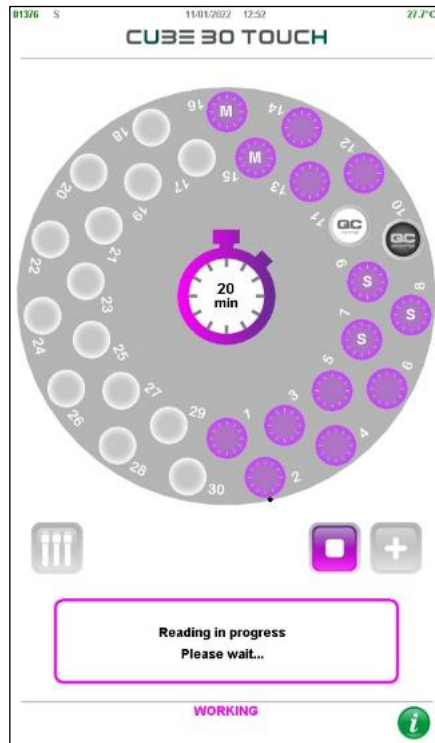



Figure 33 – Time reading  $t=0$

If a volume of blood between 1ml and 1.5ml is detected in Normal type tubes, another lower light scan will immediately follow.

The log file will contain the data for both scans: the scan used to calculate the ESR is the second one with lower light.

A 20-minute countdown begins at this point with the remaining sedimentation timer located in the center of the carousel (Figure 33)

With reference to Figure 33, the two positions of the black and white circle in the samples plate represent two Quality Controls, respectively, Pathological (Abnormal) QC and Normal QC

The user may switch from the “Carousel view” to the “Tube view” (Figure 34) with  button.

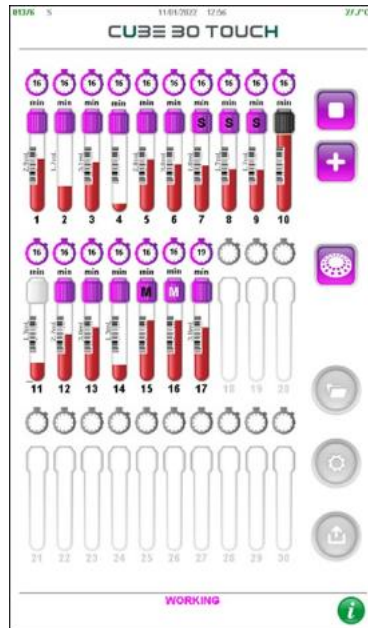

Figure 34 - Tube View

The following information is displayed in the Tube view:

- Number of positions of the carousel
- Label on the tube cap to identify a tube type other than Normal (S for Sarstedt S tube, M for MAP tube and P for Pediatric tube)
- Blood level in the tube
- Presence of the label on the tubes when the instrument reads the barcode, or the user enters it
- Value of the blood volume in each tube (Normal and Sarstedt S tube) if the 'SHOW volume' setting is enabled (see paragraph Setting)
- A timer above each tube indicating the time remaining for the end of the analysis

The color of the black or white cap identifies the presence of a QC control sample; black cap identifies a pathological control. White cap indicates a normal control.



Using the button  it is possible to return to the 'Carousel View'.

### 4.5.3 Type of tube

The type of tube is automatically identified by the instrument, if the 'Default tube type' setting is None.

If the tube identified by the instrument is different from Normal, the initial letter of the type will be displayed in the circle that identifies the sample in the carousel (Figure 35):

S identifies a Sarstedt S type tube (default is Sarstedt type 2,7ml)

M identifies a MAP tube

P identifies a pediatric type of tube

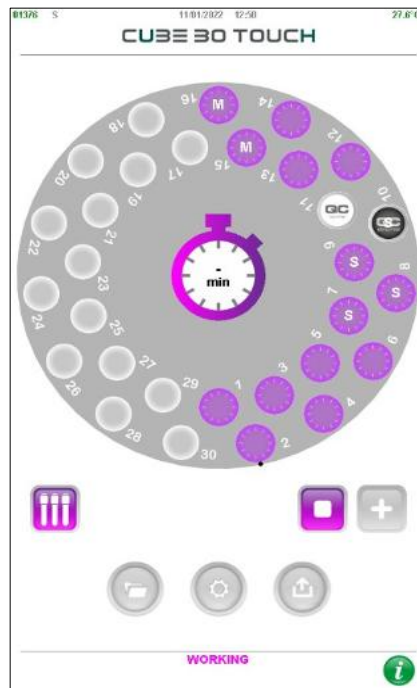

Figure 35 - Types of tubes in the sample plate

The type of the tube can be changed by activating the 'Tube type set pause' setting which allows the user to be able to change the tube type after the plate is scanned. A timed pop-up message (15 seconds) will be displayed on the screen: the user can confirm the types of tube and proceed with the analysis or cancel it to change the tube types (Figure 36).

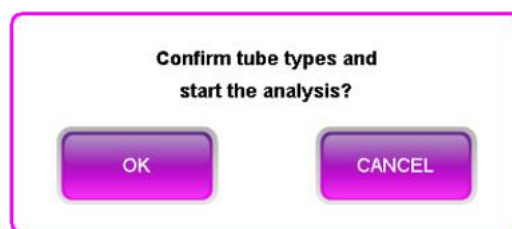

Figure 36 – Message tube type setting

If the user selects 'CANCEL' button, he can modify the type of tube with the following procedure:

- 1) Select the sample position whose type of tube must be changed. The window with the sample details (position, type of tube, sample ID ESR result) is displayed on the screen.

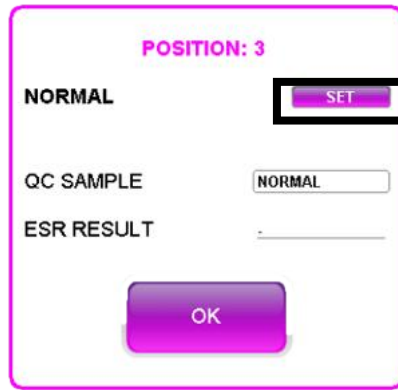

Figure 37 - Sample detail

- 2) Select the 'SET' button (black square in Figure 37)
- 3) Choose the type of tube from the menu or press the 'CANCEL' button (Figure 38)

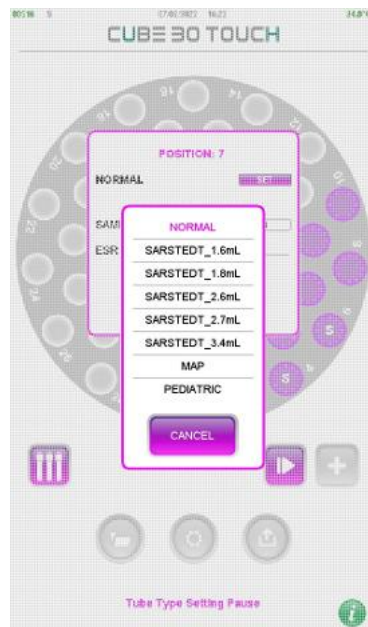

Figure 38 - Menu choice type of tube

- 4) Confirm with the 'OK' button (Figure 37)

The confirmation message appears again on the screen (Figure 36): press the 'OK' button to proceed with the analysis, press the 'CANCEL' button to make a new change. If no selection is made within 15 seconds, the tube types will automatically be confirmed and the instrument will proceed with sample analysis.

The type of tube can also be selected manually during the scanning phase of the plate: by selecting the position of a sample, the window of Figure 37 will be displayed.

The tube type can only be changed at this stage. The sample information window can still be displayed but the 'SET' button cannot be selected.

#### 4.5.4 Inserting a new sample (random access)

During the testing phase, one can insert a new sample by random access at any time.



In this case, it is critical to ensure the sample is carefully and properly mixed prior to inserting. The CUBE 30 TOUCH does not perform mixing for samples which are added in the random-access mode.

Random Access procedure:



1. Press the Add button.
2. A prompt to authorize opening the lid will display (Figure 39)

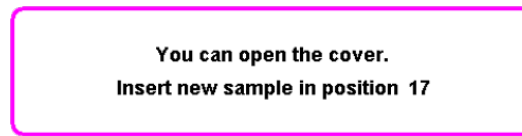

*Figure 39 – Cover open*

3. Open the lid and insert the tube in the position indicated in the prompt which appears on the screen, example:



*Figure 40*

4. Close the lid.

Once the sample has been inserted in the correct position, the instrument reads the barcode and begins processing.

If a sample added, using a Normal tube, has a volume between 1ml and 1.5ml, the first reading scan will be followed by another scan with lower led lights. This reading will be used to determine the ESR.

The remaining test time for this sample will be indicated in an individual timer which corresponds to its position.

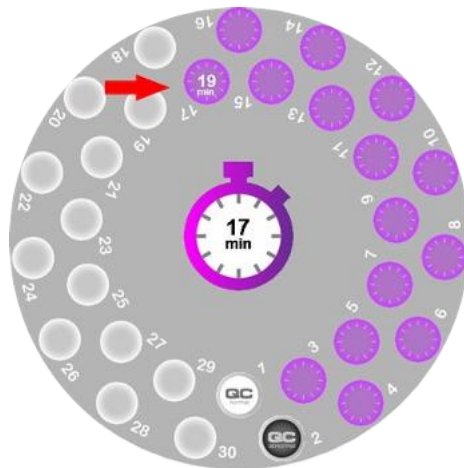

Figure 41 – Added sample sedimentation time

**Note:** if samples are not loaded within 30 seconds of opening the cover, as a safety feature, the entire cycle or working session will be aborted. The bottom of the display will show “Cycle #X completed – Ready” and the instrument will not deduct runs from the counter.

**Important:** The ‘ADD’ button is disabled (gray and not selectable) if the remaining time for reading the sample on board is 2 minutes. Is not possible to add samples with random access but the user has to wait.

At the end of the cycle, the instrument allows the user to recover the barcodes which it was not able to scan previously (three short audible alarm warnings) with the same steps described above.

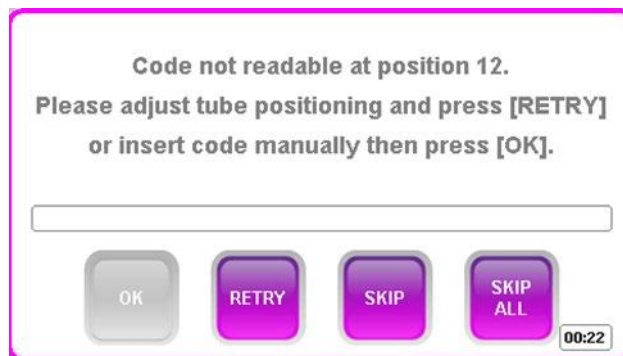

Figure 42 - Barcode insertion at the end of the cycle

A cycle has ended when the message 'Cycle xx complete - Ready' can be read at the bottom of the display. The instrument is ready for a new work session.

## 4.5.5 Results

After the test, the instrument displays the results for each sample in mm/hr, in accordance with the classical Westergren method (W), the default setting. Simultaneously, the instrument provides an automatic printout and sends results to the LIS, if applicable.

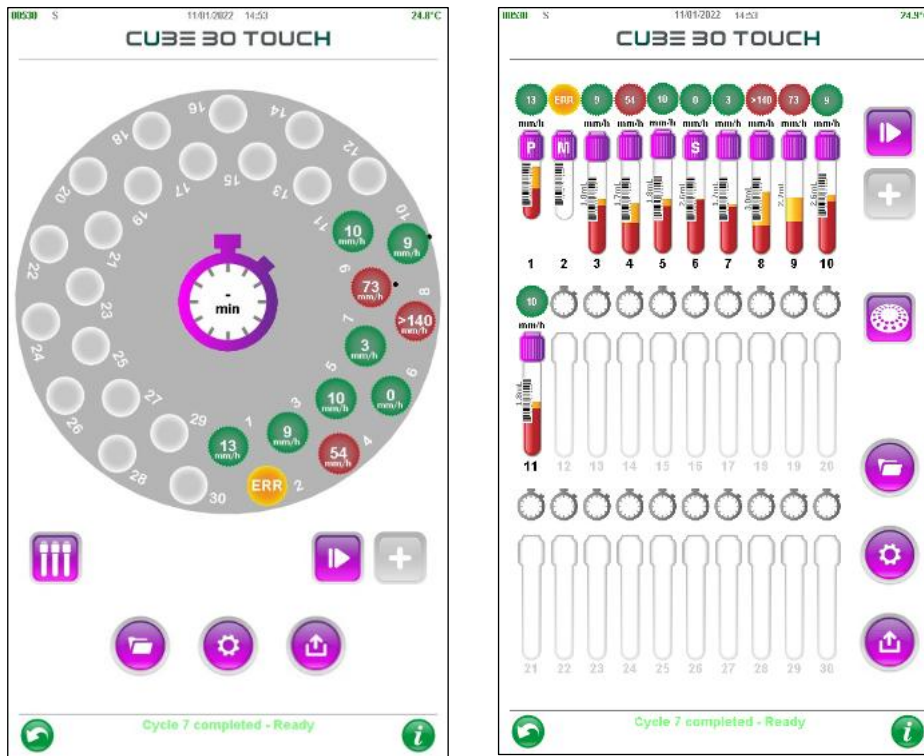

Figure 43 - Results reading



ESR result is within the normal range



ESR result is beyond the established normal range.



In the event of errors, the sample should be orange-colored and marked 'ERR'. Press ERR with your finger to get an indication of the error number (see chapter 7 Troubleshooting). The 'HR' string (Host Rejected) means that the sample was rejected by the host computer because it is not in the list of samples that needed to be processed for the ESR test.

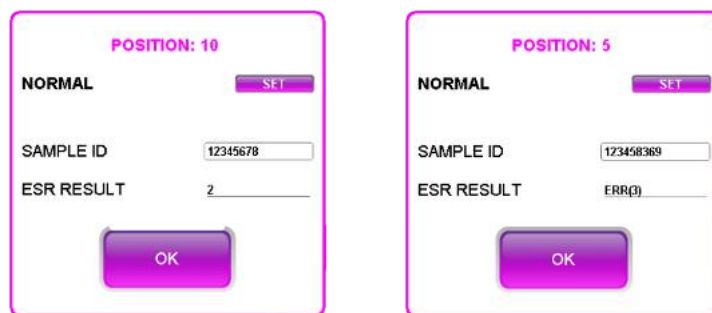

Figure 44 - Sample detail at the end of a cycle

#### 4.5.6 Guided reading of the printed results

If automatic printing (see chapter 6) is enabled, the instrument prints the receipt (Figure 45) with the results at the end of each session.

At the top of the receipt there is the header, the results follow. The information is as follows:

- Name of the manufacturer: Diesse Diagnostica Senese
- Name of the instrument: CUBE 30 TOUCH
- The software release (V 2.01.00),
- The serial number of the instrument (SN 2021-06-1299)
- Two customized header lines, optional (ReD INSTRUMENTS)
- The date in DD / MM / YYYY or MM / DD / YYYY format (11/01/2022) and the time HH / MM / SS (14:28) of execution of the analysis of the first sample
- The number of the day's cycle (9)
- The temperature detected inside the instrument in ° C or ° F (23.1 ° C) and the indication whether the temperature correction is active "ON" or not active "OFF" (ON)
- Logged in user, identified through [ID] ([RS00])
- The position of the sample inside the sample holder plate (POS NUM)
- The sample barcode (ID)
- The ESR value expressed in mm/hr. W if the reference used is Westergren, P for Pachenkov

When a QC control is analyzed, the following lines are printed:

- the position of the control sample inside the sample holder plate (POS NUM)
- the barcode of the control sample
- the ESR value expressed in mm/hr,
- the type of QC analyzed (pathological or normal)
- the name of the QC (DIESSE\_QC in the example)

- the lot number (XXX)
- the expiration date (DD / MM / YY)
- the range of acceptability (MIN / MAX)
- The outcome of the control test (FAIL / PASS)

DIESSE		
Diagnostica senese		
CUBE 30 TOUCH - V 2.01.00		
SN 2021 - 06 - 1999		
ReD STRUMENTI		
Date/Time:	11/01/2022 14:28	
Cycle	9	
Temperature:	23.1°C ON	
User	RSUU	
-----		
POS	ID	W
NUM		(mm/h)
01	20056789.....	5
02	20056790.....	6
03	.....	8
04	10046282..... S	LOW
05	10073422..... S	25
06	39008745..... M	2
07	39007656..... P	7
08	874537246..... §	HIGH
09	00956347..... §	>140
10	683909757.....	ERR
-----		
11	58033028078..	61
QC TYPE:	PATOLOGICO	
NAME:	DIESSE_QC	
LOT N.:	803	
EXP. DATE:	31/07/2023	
RANGE:	MIN: 28	
	MAX: 78	
QC RESULT:	PASS	
-----		
12	47203001014	5
QC TYPE:	NORMALE	
NAME:	DIESSE_QC	
LOT N.:	720	
EXP. DATE:	30/11/2022	
RANGE:	MIN: 1	
	MAX: 14	
QC RESULT:	PASS	
-----		
13+	0300589674.....	35!

Figure 45 - Print receipt

The printout also contains the following information:

“§”: manual insertion of the sample (barcode not read by the instrument) or exclusion of the barcode reading by the user (“SKIP”, “SKIP ALL”), see POS NUM 08 and 09 samples

“+”: sample inserted by the random-access mode (mixing was not performed by the instrument), see sample in position number 13

Figure 46

"..... .." in the ID field, as seen for the sample in POS NUM 03, it indicates the lack of the sample barcode

"S", "M", "P" after the sample barcode indicate that the analyzed sample is in a Sarstedt S, BD Microtainer MAP or pediatric tube, respectively (samples 04, 05, 06, 07)

"ERR" displayed in the ESR value column indicates an error (see TROUBLESHOOTING), see sample 10

"HIGH", "LOW" are error coding strings of respectively high sample (POS NUM 08) and low sample (POS NUM 04)

"> 140" (POS NUM 09), is the string used to indicate ESR values greater than 140 (POS NUM 13).

"!" after the ESR result it indicates that the sample was analyzed with a temperature that does not respect the established limits. For details, see paragraph 9.1

If the samples are printed from the archive (see paragraph 5) the receipt contains the following information:

- Date and time of the analysis of each sample
- Position of each sample
- Sample ID
- HCT value expressed as a percentage (optional)
- ESR result with the reference method

<b>DIESSE</b>	
Diagnostica senese	
CUBE 30 TOUCH - V 2.XX	
SN 2021 - 06 - 1999	
11/01/2022-11:45	POS.23
SAMPLE ID: 030047877.....	
ESR RESULT: 5 mm/h [W]	
-----	
11/01/2022-08:12	POS.1
SAMPLE ID: 11238688.....	
ESR RESULT: 46 mm/h! [W]	
-----	
12/12/2021-13:54	POS.7
SAMPLE ID: 0300441879.....	
HCT:	25%
ESR RESULT: 11 mm/h! [W]	

Figure 47 - Receipt from the archive

For QC samples the printing from the archive does not have any changes.

#### 4.5.7 Interruption of a work session

In the CUBE 30 TOUCH it is possible to interrupt the work cycle at any time by pressing the 'STOP' button. If the interruption is confirmed (Figure 48) the relative red status string "Cycle xx canceled- Ready" is displayed and the analysis is aborted.



*Figure 48 - Message to confirm the stop cycle*

The processed samples are always stored in the archive but the string 'ERR!' will be shown in the ESR column. In the sample detail, the error generated is "ERR (16)!", See chapter 9.

If the cycle is interrupted before reading at time  $t = 0$ , the samples are saved in the archive but not in the log file.

## 5 Archive



The Archive menu can be reached by pressing the button. The analyzed samples are organized in pages and the page number is visible at the bottom left of the screen. The archive contains up to 5000 records; when they are exceeded, the FIFO (First In First Out) strategy is adopted: sample number 5001 is stored and the oldest (sample 1) is eliminated.

Samples may be organized by date or by code (ID), using the appropriate tab (Figure 49)

DATE	IDCODE	CYCLE	POS.	ESR(W) mm/h
31/01/2022-09:20	2002088080	1	[5]	1
31/01/2022-09:20	123458294	1	[6]	5
31/01/2022-09:20	3456967351	1	[7]	2
31/01/2022-09:21	3456967350	1	[8]	3
31/01/2022-09:21	123458282	1	[9]	6
31/01/2022-09:21	123458281	1	[10]	3
31/01/2022-09:26		1	[11]	0
28/01/2022-14:53	2002141080	61	[1]	0
28/01/2022-14:54	123458280	61	[2]	2
28/01/2022-14:54	123458719	61	[3]	3
28/01/2022-14:54	123458291	61	[4]	3
28/01/2022-14:54	2002088080	61	[5]	0
28/01/2022-14:54	123458294	61	[6]	3
28/01/2022-14:54	3456967351	61	[7]	1
28/01/2022-14:54	3456967350	61	[8]	2
28/01/2022-14:54	123458282	61	[9]	3
28/01/2022-14:54	123458281	61	[10]	0
28/01/2022-14:59		61	[11]	0
28/01/2022-14:50	2002141080	60	[1]	ERR!
28/01/2022-14:50	123458280	60	[2]	ERR!

Figure 49 - Sample Archive

Each sample in the archive has associated with it:

- Date and time of the analysis cycle
- ID code
- Cycle number for the day
- Position occupied in the carousel between []
- ESR value (mm/hr). The reference method is displayed in square brackets: W for Westergren, P for Pachenkov.
  - A red ESR value indicates that the result is outside the normal range (20 mm/hr by default)

- The string 'ERR' in red indicates an error: the details of the error can be read by holding down the sample string (as described in the 'Sample selection' paragraph). For error coding, see chapter 9.
- The string "ERR!" indicates that the cycle has been interrupted
- The subscripts present "S", "M", "P" indicate respectively that the type of tube of the sample was a Sarstedt, a Map, a Pediatric
- The apex "H" indicates that the ESR value has been corrected with the HCT hematocrit value

## 5.1 Sample archiving functionality

### 5.1.1 'Export' button

By clicking on the Export icon  the user can:

- Print the list of all the samples in the archive. A message is displayed with the number of samples and request for confirmation as shown below (Figure 50).



*Figure 50 - Print confirmation*

- Filter the data in the archive by sample. By selecting this item, all the barcodes of the samples are visible (Figure 57) and it is possible to search for the sample using the white box of the 'SEARCH' function (red box in Figure 51).

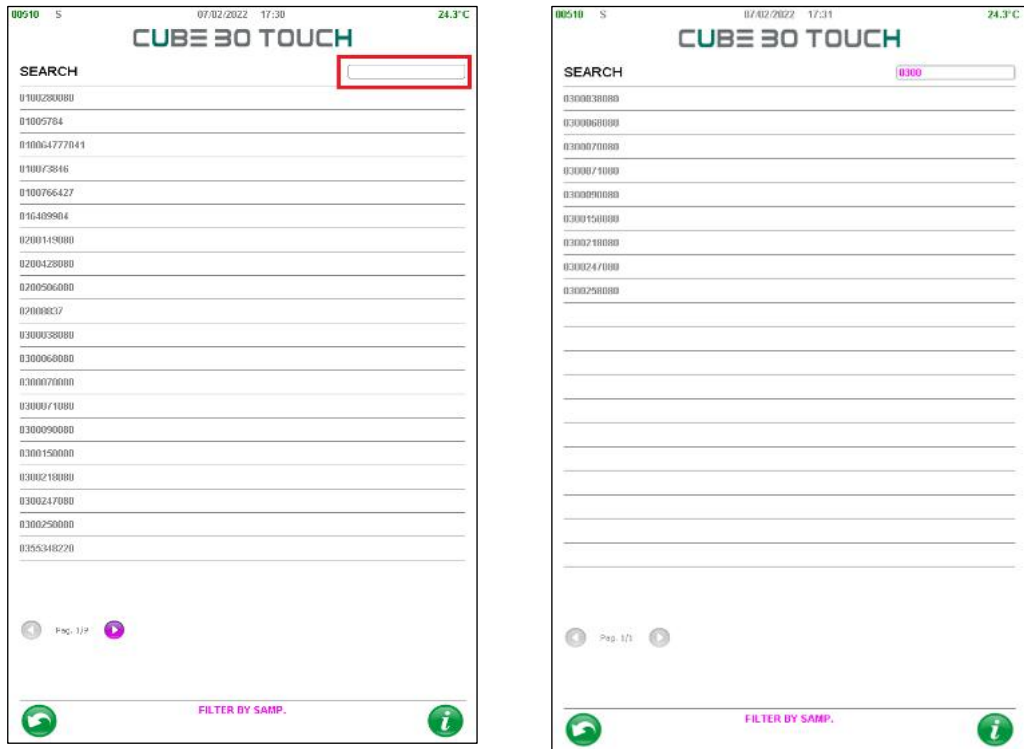

Figure 51 - Filter by sample

The user has to write the barcode or a part of it: by pressing the enter key the samples are filtered and only those containing the code entered in 'SEARCH' are displayed (Figure 52)

If the user selects the barcode of a sample, a new screen opens: it contains all sample processing sorted by decreasing date. By holding down the single line it is possible to view the details of the sample.

00510 S 07/02/2022 17:34 24.3°C

**CUBE 30 TOUCH**

FILTER BY SAMP: 0300247080

DATE		CYCLE	POS.	ESR[W] mm/h
17/11/2021-16:04	0300247080	33	[2]	1
17/11/2021-15:35	0300247080	32	[2]	0
17/11/2021-14:42	0300247080	31	[2]	0
17/11/2021-14:10	0300247080	30	[2]	0
17/11/2021-14:02	0300247080	29	[2]	ERR!
16/11/2021-16:26	0300247080	3	[7]	0

Page 1/1

gc

ARCHIVE

i

Figure 52 - Filtered samples

The following operations can be performed using the 'Export' button :

- Send all samples to the host computer.
  - Print the sample list
  - Filter the samples by date
  - Remove the filter
- Filter by cycle. A pop-up window appears in which it is possible to write the date and the number of the desired cycle (Figure 53)
- If 'OK' button is pressed the samples are filtered and it is possible to view the details of the samples and carry out the operation described above.

**DATE**

SEARCH DATE

CYCLE

Figure 53 - Filter by cycle

- Filter by date: in the pop-up window the user can write the two date extremes in which to search for the samples. The information and operations already described above can be accessible in the filtered archive by date.

## 5.1.2 Samples selection

By pressing on the sample records it is possible to select them: each selected sample will have all the fields in purple. (Figure 54)

DATE	CODE	CYCLE	POS.	ESR[W] mm/h
31/01/2022-09:20	2002088080	1	[5]	1
31/01/2022-09:20	123458294	1	[6]	5
31/01/2022-09:20	3456967351	1	[7]	2
31/01/2022-09:21	3456967350	1	[8]	3
31/01/2022-09:21	123458282	1	[9]	6
31/01/2022-09:21	123458281	1	[10]	3
31/01/2022-09:26		1	[11]	0
28/01/2022-14:53	2002141080	61	[1]	0
28/01/2022-14:54	123458280	61	[2]	2
28/01/2022-14:54	123458719	61	[3]	3
28/01/2022-14:54	123458291	61	[4]	3
28/01/2022-14:54	2002088080	61	[5]	0
28/01/2022-14:54	123458294	61	[6]	3
28/01/2022-14:54	3456967351	61	[7]	1
28/01/2022-14:54	3456967350	61	[8]	2
28/01/2022-14:54	123458282	61	[9]	3
28/01/2022-14:54	123458281	61	[10]	0
28/01/2022-14:59		61	[11]	0
28/01/2022-14:50	2002141080	60	[1]	ERR!
28/01/2022-14:50	123458280	60	[2]	ERR!

Figure 54 - Selection of samples in the archive

With the 'Export' button  it is possible:

- Send the selected samples to host
- Print the results
- Delete the selected samples

By pressing and holding a sample, it is possible to access the information details window (Figure 55)

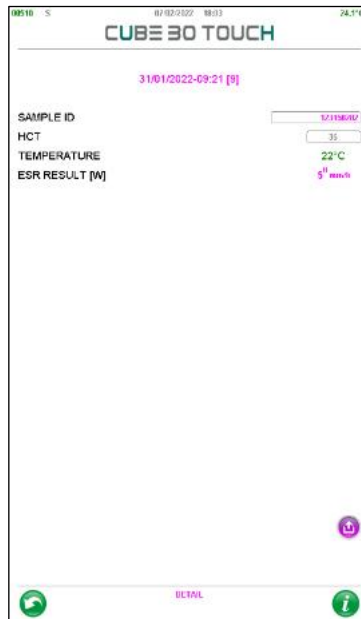

Figure 55 - Sample detail

The visible information is:

- Sample ID, which is the sample barcode, if present. If the barcode is absent, the user can add it by selecting the empty box and manually typing the code through the keyboard displayed on the screen or using the appropriately connected external barcode reader. When the 'BACK' button is pressed, confirmation of the record change is requested.
- HCT, hematocrit value. The CUBE 30 TOUCH instrument corrects the ESR value based on the hematocrit value, when present, according to the Fabry formula (correction limited to values of  $15\% < \text{HCT} < 40\%$ ).

The HCT value can be entered manually, by selecting the white box and typing the value or it is filled automatically when the instrument is connected to the LIS (Laboratory Information System) with the ASTM host protocol, if the HCT sending function is enabled (for details refer to the Service Manual or contact the Technical Assistance).

When the ESR value is correct with the hematocrit value, the letter 'H' is present at the top of the ESR value.

- Temperature, the analysis temperature value is displayed: green if the temperature correction was active, red if the temperature correction was deactivated. If an error occurs, the temperature is not displayed.
- ESR RESULT [W / P], value of the ESR result. The letter in square brackets provides the operator with an indication of the reference method used for the calculation of the ESR. If the reference method is changed, the ESR value is recalculated, and the method used is indicated.

By selecting the 'Export' button , it is possible to print the sample.

The button , in the Archive screen, allows the user to view the QC Archive page in which the results of the quality controls are displayed (see chapter 7)

## 6 Settings

From the setting menu  the user can access various functions described on the following pages:

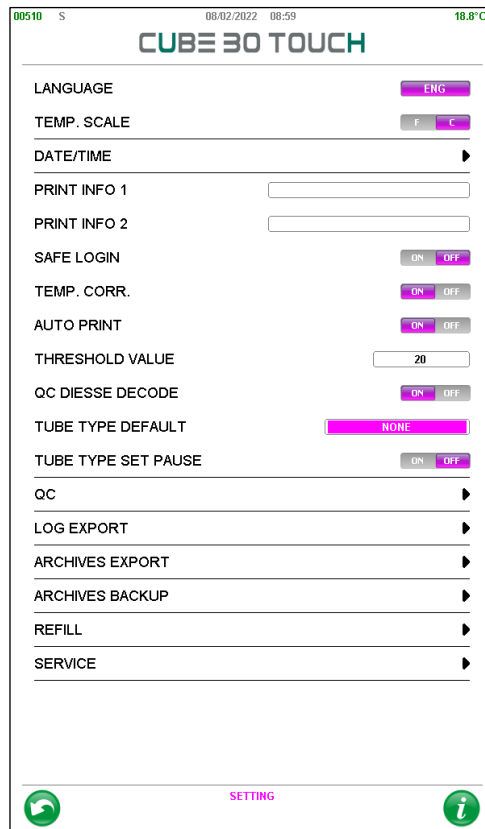

Figure 56 - Setting

- **LANGUAGE:** Select the language. The languages that can be set on the CUBE 30 TOUCH are: ENG (English), ITA (Italian), DT (German), ES (Spanish), FR (French), PT(Portuguese).  
It is not necessary to restart the instrument after changing the language.
- **TEMPERATURE SCALE:** Set the temperature scale in degrees Celsius or Fahrenheit.
- **DATE/TIME:** Set the date and time and format.
- **PRINT INFO 1 e 2:** Print customization, allows you to add up to two lines of information in the print header.
- **SAFE LOGIN:** Enable or disable access with user ID and password (see chapter 6).
- **RESET ALL USERS:** deletes all previously registered users
- **USER MANAGEMENT:** allows the administrator user to manage other users
- **TEMPERATURE CORRECTION:** Enable or disable Temperature Correction.
- **AUTO PRINT:** disable the automatic printing of the results at the end of each cycle

- **THRESHOLD VALUE:** Set a threshold value; when this value is exceeded the instrument will display the result in red to alert the operator that the result is outside of the normal range. The default value is 20 mm/hr.  
The threshold value that can be set from this screen is automatically attributed to all types of tubes; the modification on the single type can be made in the 'Service' , refer to the Service Manual.
- **QC DIESSE DECODE:** Deactivating (OFF) this function, the instrument will NOT recognize (in automatic mode) a DIESSE control by reading only the label applied on the tube. In this case, the QC must first be registered as described in the registration procedure in Chapter 5 to be recognized.
- **DEFAULT TUBE TYPE:** allows the user to choose a default tube type. With this selection, any type of tube inserted will be managed as the type of tube set. The types of test tubes that can be chosen are those compatible with the instrument already presented in paragraph 1.1.  
The default setting is 'NONE': the instrument automatically detects the type of tube inserted.
- **TUBE TYPE SET PAUSE:** enables the message window to confirm or modify the type of test tube detected by the instrument. If the setting is disabled, the type of tube is automatically confirmed, and the cycle is started automatically.
- **QC:** Enter the QC menu to configure quality control settings (See chapter 5).
- **LOG EXPORT:** Export the instrument's Log file to a USB device, in Log.txt.  
Enter the range of dates of interest, press the 'OK' button, insert the USB device into the port (Figure 7), wait for the operation to complete. The exported files follow the following nomenclature: `yyyymmdd.LOG` where "yyyymmdd" represents the date of the working day. If, in the selected date range, there is no work cycle, a file called `xxxx_RDP.txt` is saved (where xxxx are the last 4 digits of the serial number) containing the parameters of the instrument.
- **ARCHIVES EXPORT:** Export the data (SAMP.CSV) or QC(QC.CSV) archive to a USB device, in \*.xls format. For each sample the following information is present: the barcode, date and time of the examination, the position inside the sample plate, the ESR value (ESR), FLAG, temperature and cycle number. The QC file reports: the name, the lot, the expiry date, the minimum and maximum ranges, the type, date and time of the processing, position in the plate and the ESR value.
- **ARCHIVES BACK UP:** Back up or restore the archives. The files are stored in the complex format .arc: `dbsamp.arc`, `dbqc.arc`.

- **REFILL:** allows the user to load a predetermined number of executable tests into memory, using the "Test Device Next" device.

The "Test Device Next" is an electronic device; in fact, the small circuit assembled in it is visible (device on the left in Figure 57) which allows the instrument to have a defined number of executable tests. For each given result, the Test Device Next automatically decreases the number of tests available; in case of sample in error, the test device will not be decreased.



Figure 57 - Test Device Next

To refill the test number, insert the "Test Device Next" tube in the appropriate compartment and follow the instructions that appear on the screen (Figure 58)

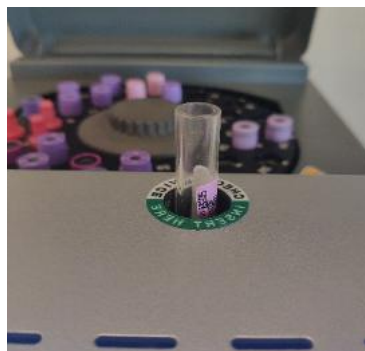
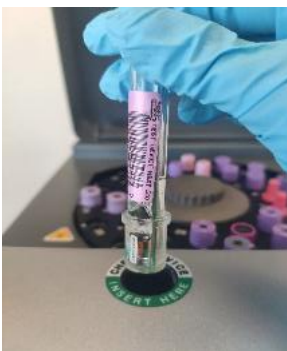

Figure 58 - Refill with Test Device Next

With reference to Figure 57 '5K' represents the number of tests with which the instrument will be reloaded (5K = 5000).

The date on the bottom left represents the date of manufacture of the Test Device, in accordance with the notation yy/mm/dd.

- **SERVICE:** by selecting this item the user can access to the page that allows authentication for the Service Menu. This page contains information on the firmware installed on the instrument on the left: type of firmware, instrument name, firmware

version and release date of the firmware version; on the right the numeric keypad for entering the access code (Figure 59).

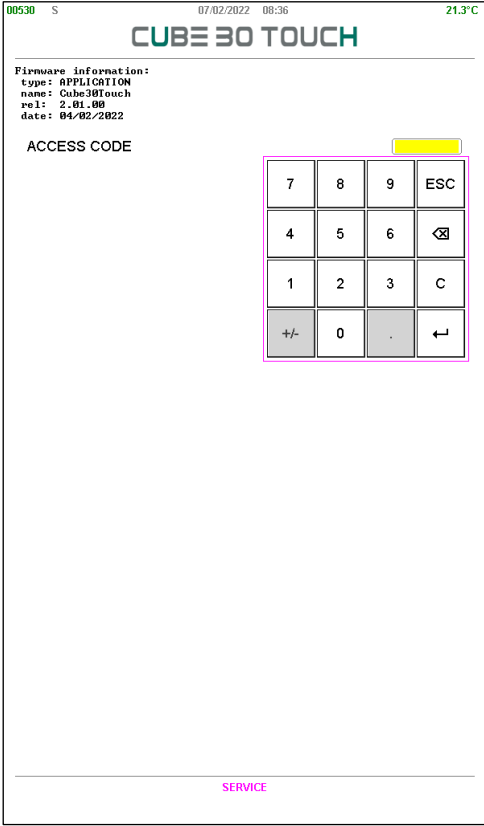

Figure 59 - Service

The service menu is accessible only to personnel authorized by DIESSE Diagnostica Senese S.p.A .; for all the details on access and service functions, refer to the Service Manual.

## 7 QUALITY CONTROL

Quality Control materials supplied by DIESSE Diagnostica Senese S.p.A are reported among the instrument accessories. They are automatically and conveniently identified by the instrument. For this reason, registration of the control material is not necessary. QC vials may be run with or without the plastic adaptor.

In case of use of Quality Control materials not supplied by DIESSE Diagnostica Senese S.p.A, refer to section 7.1 for the registration procedure.

### 7.1 QC registration procedure

To utilize quality control material not supplied by DIESSE Diagnostica Senese S.p.A:

1. Apply dedicated barcode labels
2. Select the item QC from the Settings menu (Figure 56 then Figure 60)
3. Insert the Normal control in position 1 and press the DETECT icon. The instrument detects the code and displays it in the barcode window
4. Manually insert the relative data for name, lot, expiry, and acceptability limits
5. Remove the Normal QC
6. Insert the Abnormal QC in position 1
7. Repeat the same procedure as at point 3

Following this procedure, the instrument will be able to identify the controls automatically from the barcode.

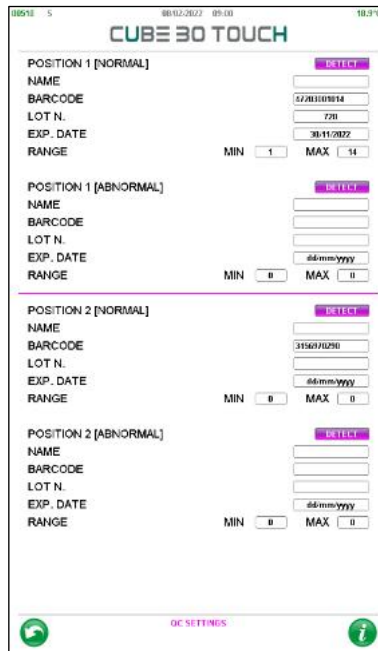

Figure 60 - QC Setting

## 7.2 Performing QC analysis

Control materials are loaded and processed in the same manner as patient samples (See chapter 4). The CUBE 30 TOUCH will recognize the barcoded test tube as a QC sample and display it on the screen as shown in Figure 61:

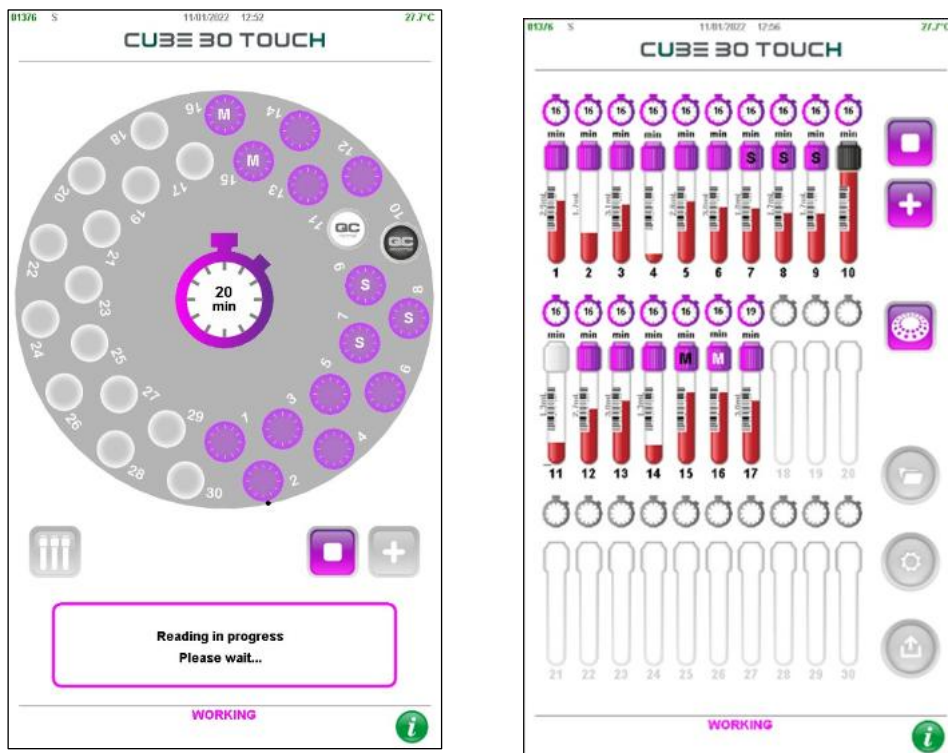

Figure 61 - Qc analysis

- Normal control: white cap
- Abnormal control: black cap



Upon conclusion of the test, if QC results are out of range, an orange circle will be displayed and “QC FAIL” will appear on the printout.

When an expired QC is detected, a timed message is displayed on the screen to allow the user choose to continue with the procedure or cancel the session (Figure 62).



*Figure 62 - QC expired*

If the "NO" button is selected, the analysis is interrupted: the user can open the lid and remove the expired QC and start a new work session.

If the "YES" option is selected or if no selection is made within 5 seconds, the analysis will continue automatically.

### 7.3 QC archive



In the QC archive, it is possible to view the data of the controls over time (Figure 63). In this screen, the following are indicated for each sample: date and time of examination, barcode, position in the sample holder plate, type of control and ESR result (ESR).

00510 S 08/02/2022 09:39 21.8°C

### CUBE 30 TOUCH

DATE	CODE	POS.	ESR mm/h
16/09/2021-15:23	46113001016	[4]	NORM 7
16/09/2021-15:23	46113001016	[5]	NORM 7
16/09/2021-15:23	56113053103	[6]	ABN 55
16/09/2021-15:23	46113001016	[1]	NORM 5
16/09/2021-15:23	46113001016	[2]	NORM 8
16/09/2021-10:23	57123036086	[12]	ABN 50
16/09/2021-10:23	57123036086	[8]	ABN 50
16/09/2021-10:23	57123036086	[9]	ABN 50
16/09/2021-10:23	57123036086	[10]	ABN 53
16/09/2021-10:23	57123036086	[11]	ABN 48
16/09/2021-10:23	47123001015	[3]	NORM 6
16/09/2021-10:23	47123001015	[4]	NORM 8
16/09/2021-10:23	47123001015	[5]	NORM 6
16/09/2021-10:23	47123001015	[6]	NORM 7
16/09/2021-10:23	57123036086	[7]	ABN 50
16/09/2021-10:23	47123001015	[1]	NORM 6
16/09/2021-10:23	47123001015	[2]	NORM 7

QC ARCHIVE

Figure 63 - QC archive

By pressing the Export icon,  it is possible to: print the list of QCs or filter the archive by barcode or by date as already described for the samples (paragraph 5.1.2).

By pressing on the QC records it is possible to select them: each selected QC will have all the fields in purple. After selection, the following operations can be carried out with the 'EXPORT' button  :

- Sending the QC samples to host
- Print the list of QCs, after confirmation
- Printing of the selected QCs
- Permanently delete the selected QCs

By holding down on the string of a QC, the user is able to access its information window (Figure 64 - Qc detail) where the details of the control are shown: type, name, barcode, lot, expiry, limits.

Information on the analysis of the sample is also reported: date, time, cycle number and the result of the ESR analysis.

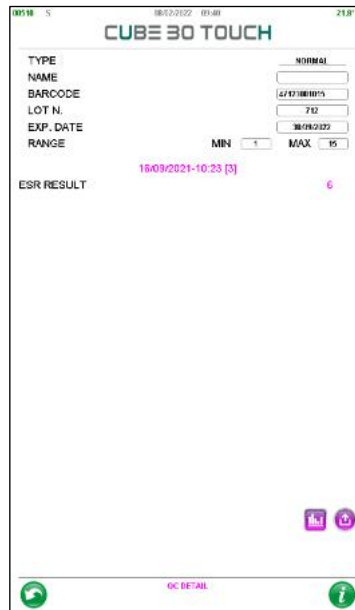



Figure 64 - Qc detail

By selecting the 'Export' button , it is possible to print the QC.

By pressing the 'Graph' button , the user enters the "QC History" page where the QC data are displayed in a Levey-Jennings graph (Figure 65).

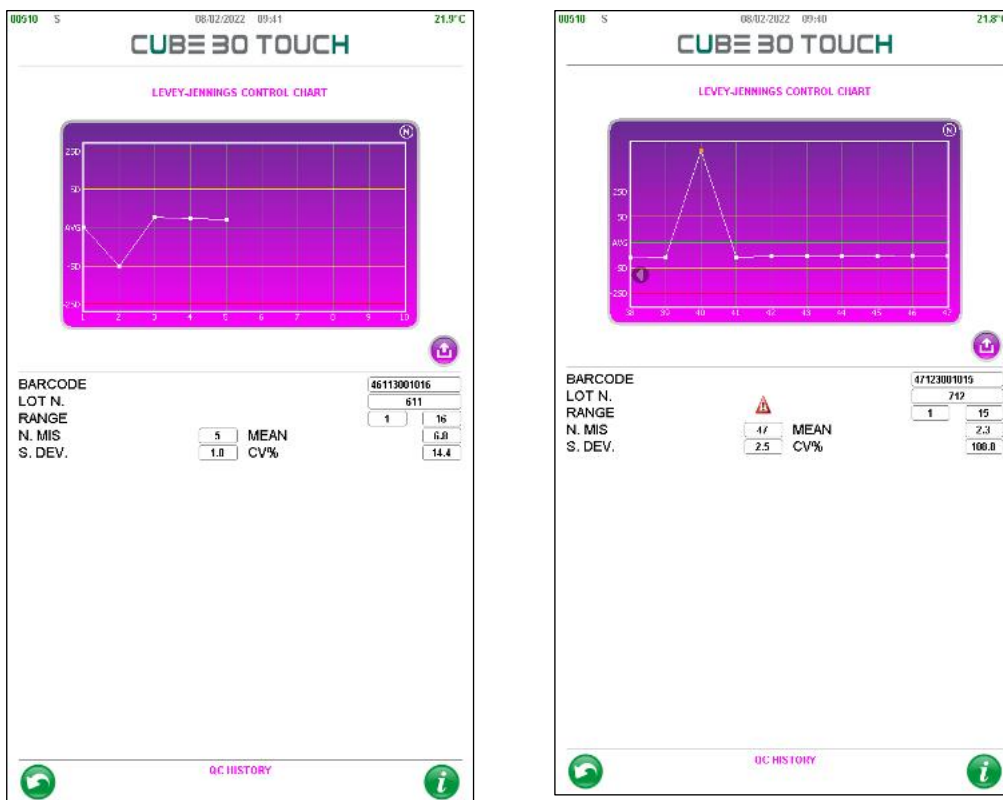

Figure 65 - Qc history

This page shows the details of the QC (barcode, lot and limits), the number of measurements performed, the mean, the standard deviation and the CV%. The Levey-

Jennings graph shows: on the x axis the number of repetitions of the controls, on the y axis the mean value (AVG, green line) and the distance from the mean measured in standard deviations ( $\pm$  SD yellow lines,  $\pm$  2SD red lines). The type of control is indicated at the top right (N for Normal control and A for pathological, abnormal control).

WESTGARD rules are widely established statistical rules which make it possible to identify, on a probability basis, systematic and random errors that can lead to a failure to comply with established objectives of accuracy and precision.

The following Westgard rules are commonly used:

- **1<sub>2s</sub>**: A control value exceeds the mean of two standard deviations.
- **1<sub>3s</sub>**: A control value exceeds the mean of three standard deviations.
- **2<sub>2s</sub>**: Two consecutive values exceed the mean of two standard deviations on the same side of the mean.
- **R<sub>4s</sub>**: The difference between two consecutive values exceeds the four standard deviations.
- **4<sub>1s</sub>**: Four consecutive values exceed the mean of a standard deviation on the same side.
- **10<sub>x</sub>**: Ten consecutive values fall on the same side compared to the mean.

In the event that a rule is not respected, the instrument signals the condition to the user through the danger symbol, which can be viewed in Figure 65, on the right.

By pressing the export button  , it is possible to:

- print QC data: QC details, mean, standard deviation, CV%, date, time and result of each analysis (Figure 66)
- Filter by lot

<b>DIESSE</b>	
Diagnostica senese	
CUBE 30 TOUCH - V 2.01.00	
SN 2021 - 06 - 1999	
ReD STRUMENTI	
-----	
QC TYPE:	PATOLOGICO
NAME:	DIESSE_QC
LOT N.:	803
EXP. DATE:	31/07/2023
RANGE:	MIN: 28
	MAX: 78
QC RESULT:	PASS
-----	
MEAN:	6.8
S. DEV.::	1
CV%:	14.4
-----	
	ESR
	mm/h
-----	
10/01/2022-08:14	7
03/01/2022-08:43	7
30/12/2021-9:02	7
29/12/2021-10:23	5
12/12/2021-14:34	8

Figure 66 - Print of QC history

## 8 USER MANAGEMENT

The instrument allows the user to create and manage access through personalized identification. To start this function just activate the "SAFE LOGIN" from the SETTINGS menu.

The first time it is activated, the user is asked to enter data for the first user, the administrator, who will be able to add or remove up to a maximum of 4 users. To create a user, simply enter name, surname and password (which must **be 6 characters and different from '000000'**) (Figure 67 on the left). After the user has been created, a 4-character ID will be generated as follows: first letter of the name + first letter of the surname (or second letter of the name) + progressive number; in the case of an administrator user, the progressive number is 00. In the example proposed in Figure 67 on the right, the ID of the connected user is RS00 and is always expressed in square brackets.

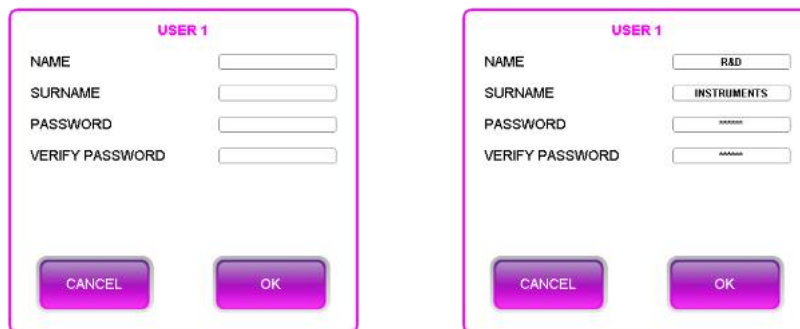

The figure shows two screenshots of the 'USER 1' registration form. The left screenshot shows the registration form with fields for NAME, SURNAME, PASSWORD, and VERIFY PASSWORD. The right screenshot shows the same form with dropdown menus for NAME (R&D) and SURNAME (INSTRUMENTS), and masked password fields. Both screenshots have CANCEL and OK buttons at the bottom.

Figure 67 - User 1 registration

The connected user is always visible on the home page (Figure 25) and the indication can also be read in the print report (Figure 45).

With the registration of the first user, the logout arrow is displayed on the home screen (see Figure 25). After the logout confirmation, the user is directed to the login page; page that will also be presented to the user every time the instrument is switched on (Figure 68). All registered users are displayed on this page.



Figure 68 - Login

For identification, the user must select his username: the screen in Figure 69 will be displayed in which the user can enter its password using the numeric keypad that appears on the screen after pressing the white box; after entering the 6 digits, the user can press the enter key.



Figure 69 - User authentication

To log in, simply press the fingerprint button  :

if the password is correct, the user can have access to the home screen, otherwise the error is notified by the message "Wrong Access Code" (wrong access code) and the login screen is shown again (Figure 68).

In the event that the identified user is the administrator, he will see the complete home screen (Figure 25).

The Settings page (Figure 56), displayed by the Administrator has the additional options:

- **'reset all user'** which allows the deletion of all users and restores the 'safe login = off' default mode;
- **User Management.** By selecting this setting the administrator can add new users (maximum 4 users), can change their password and can delete the added user with the 'Delete' button.

**Note:** The only modifiable information is the password, if you want to change the name or surname, the user should be deleted and recreated

If the logged in user is different from the Administrator (Figure 70), the 'Settings' button will not be displayed on the home screen because he is not allowed to use the functions it contains.

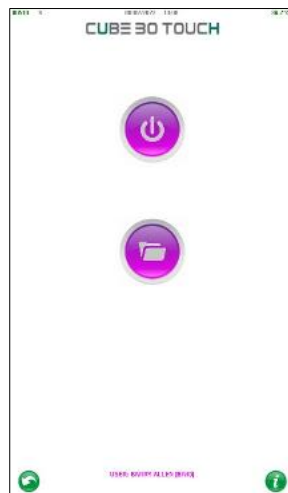

Figure 70 - User home page

## 9 TROUBLESHOOTING

ERROR MESSAGES	CAUSE	REMEDY
Low (Low)	The blood level in the test tube is too low.	If possible, add blood until you reach the required levels.
High (HI)	The blood level inside the test tube is too high.	If possible, remove blood until you reach the required levels.
	Interference from the label.	Try to remove/reposition the label and repeat the test.
Err (2) (3)	The bottom of the test tube was not identified.	Check that the test tube in use is compatible with the instrument and that it has been inserted correctly, as described in chapter 4. Visually inspect the sample for presence of clumps or clots.
Err (6)	The blood level in the test tube was not detected.	
Err (8)	The blood level after the second reading is higher than the initial blood level measured.	
Error Removed tube Err (11)	This appears at the end of the second reading if, during the cycle, the test tube is removed from its position.	Repeat the test for that sample.
Failed control method (13/14)	No confirmation of the control method.	Check for any additional labels and position the tube as described in Chapter 4.
Anomalous test tube Err (15)	This may be due to significant sedimentation with a low volume of blood.	Check for the presence of clumps or clots. Try to repeat the test.
Cycle interrupted Err (16)	The run was aborted before the second sample reading.	Repeat the analysis, making sure not to interrupt the cycle before the analysis is complete.
Exam not available Reloading required	Zero tests remaining.	Follow the instructions for reloading the instrument with a new test device, as described in chapter 4.
USB device not found	The instrument does not recognize the USB device.	Remove and reinsert the device or replace it.

<b>Caution! "N" tests remain</b>	The number of remaining tests is less than 50.	Be sure to reload the device as soon as possible with a new test device
<b>Used TEST DEVICE</b>	The test Device in use is empty.	Obtain a new test device.
<b>FATAL ERROR! MOTOR FAIL! XXXXXX YYYY</b>	An engine error on component xxxxx has occurred (ex. Reader, Plate etc.). The type of error is indicated by yyyy (e.g. Home, step, etc.)	In the message that appears on the screen, press the 'OK' button. Remove all samples from the plate and restart the instrument.  If the problem persists, contact Technical Assistance

## 9.1 Temperature out of range

If the working temperature of the instrument does not respect the 15 °C - 35 °C limits established in the technical characteristics (see paragraph 2.4), the condition is signaled to the operator as soon as the 'Start' button is pressed to start a cycle analysis (Figure 71).

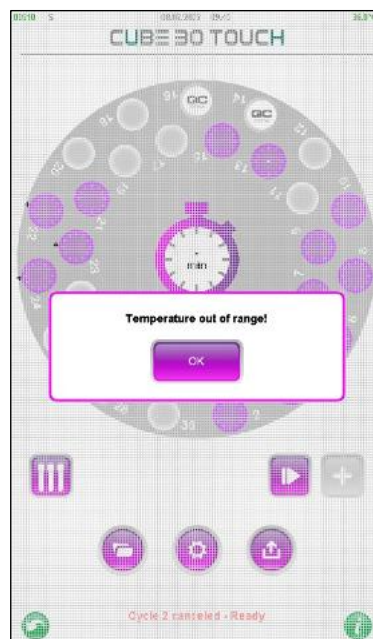

Figure 71 - Temperature out of range

To proceed with the analysis, the operator must confirm, otherwise the instrument does not start processing the samples.

**⚠ ATTENZIONE:** The results of samples processed with temperatures outside the range of 15-35 ° C (operating temperature range) may not comply with the declared performance.

The red message "WORKING - Temperature warning!" Is displayed in the status bar to warn the operator that the instrument is working with a temperature outside the acceptable limit.

In the print report (Figure 47) and in the archive, if the sample is processed with a temperature lower than 15 ° C or higher than 35 ° C, the "!" character follows the ESR result.

The temperature out of range warning is displayed in the status bar, even if the temperature does not respect the limits allowed during a work session. At the end of the analysis, for the samples analyzed in this condition, the ESR value is followed by the "!" in the print report and in the archive.

# 10 CONNECTION TO HOST COMPUTER

Communication between the CUBE 30 TOUCH and an external computer can be established:

1. Using a **USB Connection**:

Connect a standard A-B USB cable between the computer's USB port (type-A rectangular connector) and the CUBE 30 TOUCH's USB port (type-B square connector). The driver (STM32 SW; download from [www.diesse.it](http://www.diesse.it)) for MS Windows will need to be installed to establish communication with the CUBE 30 TOUCH through a virtual COM port on USB.

HOST BY USB  ON  OFF

On the CUBE 30 TOUCH, in the Service menu, the "HOST BY USB" parameter must be set to ON.

2. Using a serial **RS232 COM** port on the PC:

Connect a straight standard serial cable between the PC's RS232 COM port and the instrument's RS232 (9-pin) serial connector.

HOST BY USB  ON  OFF

On the CUBE 30 TOUCH, in the Service menu, the "HOST BY USB" parameter must be set to OFF.

The electric levels of the signals are all the standard RS232C type.

- The default transmission speed is 9600 bit/s
- the data format is 8-bit,
- 1 stop bit and no parity bit.
- The "RS232C" DB9 female connector reflects the following pin-out:

PIN	SIGNAL
3	Rx of data from Host
2	Tx of data towards Host
5	GND

Detailed specifics of the communication protocol are available for consultation on the web site at the following address: [www.diesse.it](http://www.diesse.it). the document of interest is "cube30touch\_specification\_protocol" which can be consulted in the "Software information" section of the CUBE 30 TOUCH instrument.



# 11 PERFORMANCES

## 11.1 CUBE 30 TOUCH precision

Test Protocol: Sixty vials of ESR-Chex Plus control (30 vials of level 1 and 30 vials of level 2) were used in the study. The level 1 vials were inserted in each well of the instrument and tubes were analyzed 3 times over the course of the 7-day open-vial stability of the control. The study was repeated with level 2 vials. The mean, standard deviation and coefficient of variation (CV%) were calculated for intra-assay precision (repeatability and within lab).

Position	ESR Value (mm/h) Level 1, Lot 403			ESR Value (mm/h) Level 2, Lot 403		
	Day 1	Day 5	Day 7	Day 1	Day 5	Day 7
1	1	1	1	47	47	51
2	1	1	6	47	47	49
3	2	1	2	47	47	49
4	1	2	4	49	47	47
5	1	1	1	49	47	49
6	1	1	1	47	47	47
7	2	1	4	47	49	49
8	3	5	1	47	47	49
9	1	2	4	47	49	47
10	4	5	1	49	47	47
11	2	2	2	49	47	47
12	1	1	1	49	47	47
13	2	1	1	49	47	49
14	2	4	3	49	47	47
15	1	2	3	49	47	49
16	3	1	2	49	47	47
17	2	2	1	47	47	49
18	2	1	2	47	45	45
19	2	2	1	49	49	47
20	3	1	4	47	47	49
21	1	1	3	49	49	47
22	1	2	1	47	47	47
23	2	2	3	47	47	49
24	2	1	1	47	47	49
25	1	2	1	49	49	51
26	2	2	2	49	49	51
27	1	1	1	49	49	49
28	1	1	1	47	47	49
29	3	2	2	49	49	51
30	4	4	2	47	47	49

Results:

Acceptance criteria: CV% ≤ 15%

Intra-assay precision (Repeatability):

Means of 30 replicates of each QC blood sample tested on one instrument by a single operator during 1 working day.

	ESR Value (mm/h) Level 1, Lot 403	ESR Value (mm/h) Level 2, Lot 403
Mean	2.0	48.0
SD	1.3	1.3
CV%	—*	2.6%

Intra-assay precision (Within-lab):

Means of 90 replicates of each QC blood sample tested on one instrument by a single operator during 3 working days spanning the open-vial stability of the control.

	ESR Value (mm/h) Level 1, Lot 403	ESR Value (mm/h) Level 2, Lot 403
Mean	2.0	48.0
SD	1.8	1.4
CV%	—*	2.9%

\* When the mean value is close to zero, the coefficient of variation will approach infinity and is sensitive to small changes in the mean. Therefore, CV% is not reported for this value.

All the values obtained during the precision evaluation experiment fell within the expected range and confirmed the precision and repeatability of the CUBE 30 TOUCH instrument.

## 11.2 CUBE 30 TOUCH correlation

Overview: This study was conducted to verify correlation of the automated Diesse CUBE 30 TOUCH system to the Modified Westergren benchmark method. A CUBE 30 TOUCH system was evaluated against the manual Fisherbrand™ Dispette™ 2.

Sample Preparation for Modified Westergren:

Blood samples collected in standard 4.0 mL K2EDTA tubes were inverted six to eight times allowing the air bubble to reach the end of the tube with each inversion. Using a transfer pipet, aliquots of 1.0 mL of blood were added to the fill line of a Dispette 2

reservoir, capped and mixed by manual inversion eight times allowing the air bubble to reach the end of the tube with each inversion. Following manufacturer instructions carefully, the Dispette 2 tubes were grasped at the 180 mm region and inserted through the cap membrane of the filling reservoir. After penetrating the reservoir, the pipet was gently pushed to the bottom of the reservoir and tubes were gently transferred and placed on a level stand at room temperature. ESR levels were recorded in mm/hr at exactly 60 minutes.

#### Sample Preparation for Diesse CUBE 30 TOUCH:

Blood samples collected in standard 13 x 75 mm, 4.0 mL draw volume K2EDTA tubes were inverted six to eight times allowing the air bubble to reach the end of the tube with each inversion. Identification numbers assigned to each donor were entered into the CUBE 30 TOUCH systems. When prompted, the tubes were inserted into a free position in the CUBE 30 TOUCH to initiate testing. Results in mm/hr automatically printed at the conclusion of the 20-minute measurement.

#### Results:

In summary, the data collected indicates the CUBE 30 TOUCH system meets or exceeds a 94% correlation to the Modified Westergren method for 4.0 mL CUBE 30 TOUCH samples.

Method	Correlation	Sample Size
Diesse CUBE 30 TOUCH (4.0 mL) vs. Dispette 2	94.39%	n = 50

## 12 BIBLIOGRAPHY

1. Westergren A.: The Technique of the red cell sedimentation reaction. Am. Rev. Tuberc. 1926; 14: 94-101.
2. Silvestri M.G., Cozza E., Bertoli G., Federzoni C., Marzullo F.: Determinazione Automatica della velocità di Eritrosedimentazione. Assoc. Italiana Patologi Clinici XXXIV Congresso Nazionale 1984, Abstract.
3. De Franchis G., Carraro P., D'Oswaldo A., Di Vito S.N., Paleari C.D.: Valutazione del Sistema Ves-Tec/VES-MATIC. Confronto con il Metodo ICSH. Il Patologo Clinico 1985; 4:120.
4. Jou J.M., Insa M.J., Aymeric M., Vives Corrons J.L.: Evaluación de un Sistema Totalmente Automático para realizar la Velocidad de Sedimentación Globular. Sangre 1988; 33 (6):474-478.
5. Prischl F.C., Schwarzmeier J.D.: Automatisierte Bestimmung der Blutkörperchensenkungsgeschwindigkeit (VES-MATIC): Einsatz im Krankenhaus. Berichte der OGKC 1988; 11:112-114.
6. Vatlet M., Brasseur M., Poplier M. et al.: Evaluation of the DIESSE VES-MATIC for the Automated Determination of the Erythrocyte Sedimentation Rate (ESR). Belgian Hematological Society Meeting 1989, Abstract.
7. Vallespì Solè T.: Valor Actual de la Velocidad de Sedimentación Globular. Lab 2000 1989; 19:5-14.
8. Fernández de Castro M., Fernández Calle P., Vilorio A., Larrocha C., Jimenez M.C.: Valoración de un Sistema Alternativo Totalmente Automático para la Determinación de la Velocidad de Sedimentación Globular. Sangre 1989; 34 (1):4-9.
9. Koepke J.A., Caracappa P., Johnson L.: The Evolution of the Erythrocyte Sedimentation Rate Methodology. Labmedica 1990; Feb-Mar : 22-24.
10. Caswell M., Stuart J.: Assessment of DIESSE VES-MATIC automated system for measuring erythrocyte sedimentation rate. J. Clin. Pathol. 1991; 44: 946-949.
11. Fabry TL.: Mechanism of erythrocyte sedimentation and aggregation. Blood 1987; 70: 1572 – 1576
12. Paulus HE, Brahn E.: Is Erythrocyte Sedimentation Rate the Preferable Measure of the Acute Phase Response in Rheumatoid Arthritis? J Rheumatol 2004; 31: 838 – 840
13. Manley R.W.: The effect of room temperature on erythrocyte sedimentation rate and its correction. J. Clin. Pathol. 1957; 10: 354.

14. ICSH: Recommendation for Measurement of Erythrocyte Sedimentation Rate of Human Blood. *Amer. J. Clin. Pathol.* 1977; 68 (4): 505-507.
15. ICSH: Guidelines on Selection of Laboratory Tests for Monitoring the Acute Phase Response. *J. Clin. Pathol.* 1988; 41: 1203-1212.
16. ICSH recommendations for modified and alternate methods measuring the erythrocyte sedimentation rate. Kratz A., Plebani M., et al. *Int J Lab Hematol.* 2017 Oct.
17. Clinical and Laboratory Standards Institute, H26-A2, Validation, verification, and quality assurance of automated hematology analyzers. Approved Standard - Second Edition.
18. Westgard JO., Basic QC Practices. Training in Statistical Quality Control for Medical Laboratories - Third Edition. 2010
19. Westgard JO, Barry PL, Hunt MR, Groth T. A multi-rule Shewhart chart for quality control in clinical chemistry. *Clin Chem* 1981;27:493-501.
20. Панченков Т.П. Определение оседания эритроцитов при помощи микрокапилляра // *Врачебное дело.* – 1924. – № 16-17. – . 695-697. (Definition of erythrocyte sedimentation using Micrococapillary tube)
21. ICSH review of the measurement of the erythrocyte sedimentation rate; J. M. JOU.; *Int. Jnl. Lab. Hem.* 2011, 33, 125–132.
22. ICSH recommendations for modified and alternate methods measuring the erythrocyte sedimentation rate; A. Kratz; *Int J Lab Hem.* 2017;1–10.
23. Normal Erythrocyte Sedimentation Rate and Age; L. E. Bottiger; *Brit. med. J.* 1967, 2, 85-87
24. Erythrocyte aggregation: Basic aspects and clinical importance; O. K. Baskurt. *Clinical Hemorheology and Microcirculation* 53 (2013) 23–37
25. Normal Erythrocyte Sedimentation Rate and Age; L. E. Bottiger; *Brit. med. J.* 1967, 2, 85-87
26. C. Franzini, R. Mozzi: VES anni 2000. *Biomedica Source Books* (2003):39
27. Pieri M. et All. Evaluation of the Diesse CUBE 30 TOUCH erythrocyte sedimentation method in comparison with Alifax test 1 and the manual Westergren gold standard method. *Scand J Clin Lab Invest* (2021) May;81(3):181-186.
28. ICSH recommendations for measurement of erythrocyte sedimentation rate. International Council for Standardization in Haematology (Expert Panel on Blood Rheology). *J Clin Pathol.* 1993 Mar;46(3):198-203. doi: 10.1136/jcp.46.3.198. Erratum in: *J Clin Pathol* 1993 May;46(5):488. PMID: 8463411; PMCID: PMC501169.

29. Mario Plebani, MD, Elisa Piva, MD, Erythrocyte Sedimentation Rate: Use of Fresh Blood for Quality Control, American Journal of Clinical Pathology, Volume 117, Issue 4, April 2002, Pages 621–626.

