



Product Catalogue

"Disposable Medical Solutions"



TABLE OF CONTENTS

■	About Us	2
■	Mission and Vision	3
■	Birth of Brand and Range of Products	4
■	Why Disposable - A Quality Drape	5
■	Certificates	6
■	Surgical Gowns	7
■	Surgical Drapes	13
■	General Surgery	45
■	Orthopedic Surgery	51
■	Cardiologic Surgery	59
■	Gynecologic Surgery	64
■	Neurologic Surgery	70
■	Ophthalmologic Surgery	74
■	Oncological Surgery	79
■	Urologic Surgery	81
■	ENT Surgery	86
■	Aesthetic Surgery	89
■	Dental Surgery	92
■	Disposable Clothing and Equipment	95

About Us

AKMEDA MEDİKAL, which is active in the disposable medical textile production sector, successfully provides services in this sector.

Our company, which carries out its activities on its factory established on a total area of 2000 m²; 1500 m² closed and 500 m² open area in Ankara Ostim Organized Industrial Zone, has a production capacity of 250.000 Disposable Drape Sets and 1.500.000 Disposable Gowns per year with the product brand of **Medicotex**

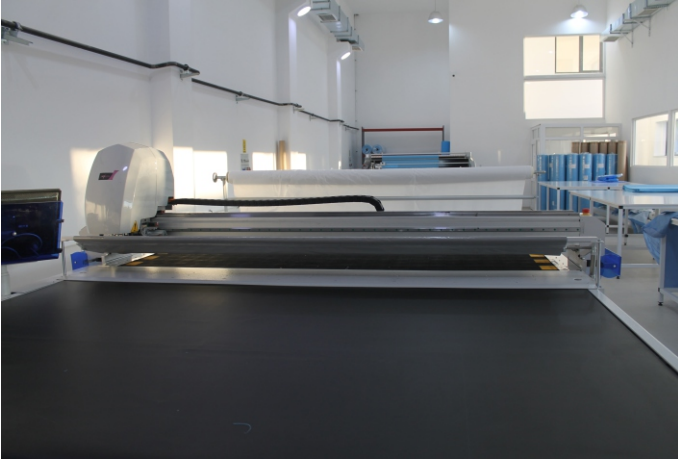

**AKMEDA
MEDİKAL**

Production Line of Our Company

Fully Automatic Fabric Spreading Machine
(Width : 240cm)

Fully Automatic Fabric Cutting Machine
(Width : 240 cm)

Ultrasonic Sewing Machines

Overlock Machines

Conventional Sewing Machines

ETO Sterilization Machines
(15.000 lt. Capacity)

Clean Room
(Compliance with Class 100.000 Standard)

Mission;

To meet the customer demand and expectations at the highest level by continuously improving the product and service quality

To be among the innovative, internationally accepted brands that create value for human health

To make customer satisfaction, belonging and loyalty sustainable

To produce the "first" and the "best" ones in the field of disposable medical textile products by developing new products

To provide product support to its customers during sales and after-sales process



Vision;

Our vision is to make **Medicotex** a world brand by offering the same quality service to all its customers without compromising its health and hygiene policy

by regards human resource as the most valuable asset

by creating its own brand

by increasing its service quality in its field as a reliable and reputable company

by presenting hygienic products to the users

Birth of Our Brand

Our Company, which has started out with the aim of creating a world brand, has created **Medicotex** brand by inspiring from the names of two main sectors in which it is active as a result of the permanent identification studies in this long run.

With a simple name preference, our company wishes to emphasize with a simple expression that it would be a long-running actor and has a full command of the essence of work in the Disposable Surgical Products Field.

At this point, we see that **Medicotex** brand has a voice and also become a determinant brand.

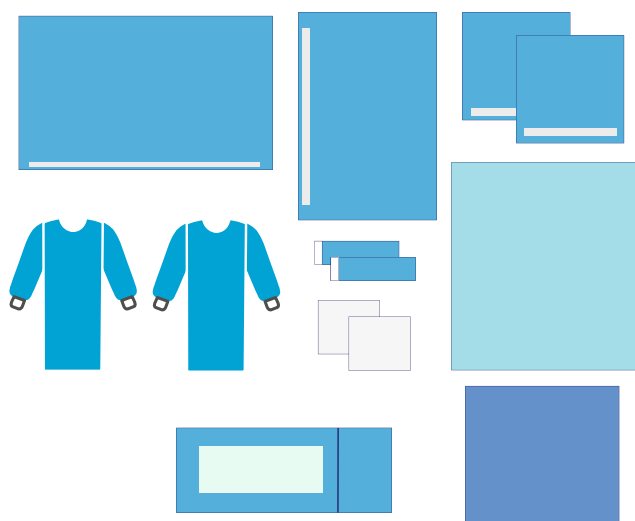

The followings are produced together with **Medicotex**

Disposable Drape Sets
Specific to all Surgical Operations
Sterile & Non-Sterile

Disposable Gowns
Specific to all Surgical Operation Team
Sterile & Non-Sterile

Disposable Laboratory Gowns

Disposable Clothes and Gowns

Disposable Work-Clothing

Disposable Overalls

Disposable Covers for Medical Devices

Human Remains Pouches

Why disposable;

The general objective of the drapes used in the surgical operations is to serve as a barrier against bacteria being a factor in the development of surgical site infections. In this way; the sterile site can maintain its sustainability because the material used is disposable and also minimize the infection risk. Its feature being specific to the operations and person increases extraordinarily the sustainability of the sterile site.

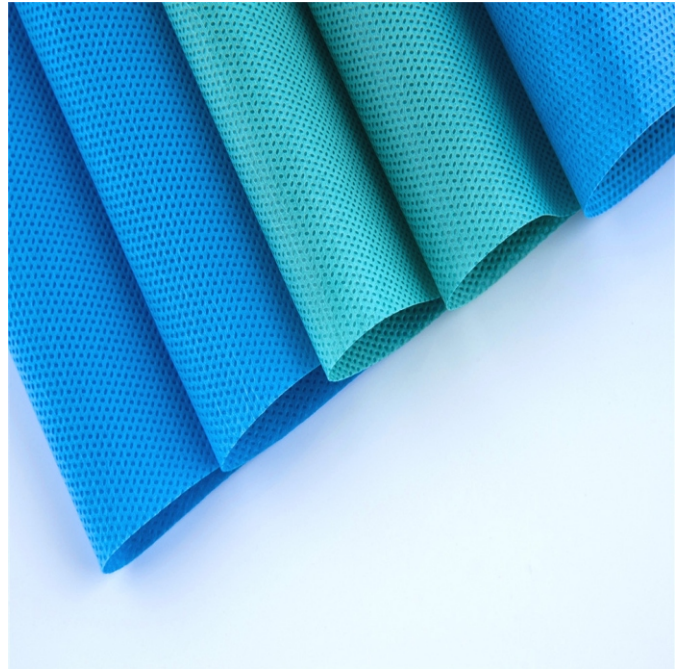

A Quality Drape;

It should be in accordance with the operating room environment and operation dynamics.

It should maintain the pre-set body temperature.

It should have an acceptable resistance to mechanical electrification and ignition.

It should be resistant to wear, to tear and the most importantly to puncture.

It should be resistant to bacterial permeability.

It should be sterilized and also should sustain this status.

It should be antitoxic.

It should be anti-pilling and also should not release dust

It should be fine-porous and ticking in terms of weaving structure.



Surgical Gowns



Surgical Gowns



Standart Surgical Gowns

It can be produced from SMS / SMMMS / Biflex / Spunlace/ Triplex fabrics upon request.
 The sleeves are connected with ultrasonic sewing which provides high quality.
 It is impermeable to liquid and also resistant to wear and tear.
 The cotton rib cuffs are used on the sleeve hems.
 It offers high comfort and comfortable working opportunities.
 It is unreinforced.
 Depending on the sterilization preference, the EO or Gamma Sterilization can be done.
 The products meets EN 13795 Standard and high performance values.

Size	Sterile	Units per Package	Non-Sterile	Units per Package
S	MDC-ONL-0011	40	NS-ONL-011	40
M	MDC-ONL-0012	40	NS-ONL-012	40
L	MDC-ONL-0013	40	NS-ONL-013	40
XL	MDC-ONL-0014	40	NS-ONL-014	40
XXL	MDC-ONL-0015	40	NS-ONL-015	40

Size	Sterile	Units per Package	Non-Sterile	Units per Package
L, Extra Long	MDC-ONL-0064	40	NS-ONL-016	40
XL, Extra Long	MDC-ONL-0065	40	NS-ONL-017	40
XXL, Extra Long	MDC-ONL-0066	40	NS-ONL-018	40

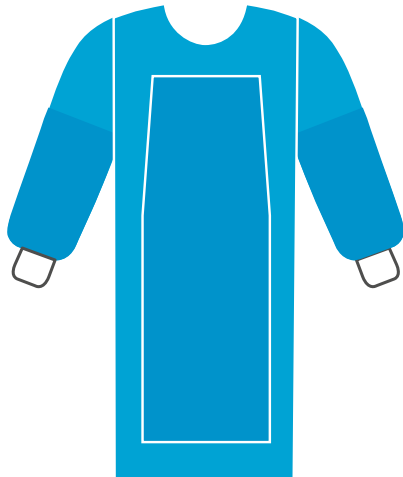

Reinforced Surgical Gowns

It can be produced from SMS / SMMMS / Biflex / Spunlace/ Triplex fabrics upon request.

The sleeves are connected with ultrasonic sewing which provides high quality.

It is impermeable to liquid and also resistant to wear and tear.

The cotton rib cuffs are used on the sleeve hems.

It offers high comfort and comfortable working opportunities.

It sleeves and body parts are reinforced.

Depending on the sterilization preference, the EO or Gamma Sterilization can be done.

The products meets EN 13795 Standard and high performance values.

Size	Sterile	Units per Package	Non-Sterile	Units per Package
S	MDC-ONL-006	40	NS-ONL-019	40
M	MDC-ONL-007	40	NS-ONL-020	40
L	MDC-ONL-008	40	NS-ONL-021	40
XL	MDC-ONL-009	40	NS-ONL-022	40
XXL	MDC-ONL-010	40	NS-ONL-023	40

Size	Sterile	Units per Package	Non-Sterile	Units per Package
L, Extra Long	MDC-ONL-017	40	NS-ONL-024	40
XL, Extra Long	MDC-ONL-018	40	NS-ONL-025	40
XXL, Extra Long	MDC-ONL-019	40	NS-ONL-026	40

Surgical Gowns



Full-Reinforced Surgical Gowns

It can be produced from SMS / SMMMS / Biflex / Spunlace/ Triplex fabrics upon request.
 The sleeves are connected with ultrasonic sewing which provides high quality.
 It is impermeable to liquid and also resistant to wear and tear.
 The cotton rib cuffs are used on the sleeve hems.
 It offers high comfort and comfortable working opportunities.
 It all parts are reinforced.
 Depending on the sterilization preference, the EO or Gamma Sterilization can be done.
 The products meets EN 13795 Standard and high performance values.

Size	Sterile	Units per Package	Non-Sterile	Units per Package
S	MDC-ONL-001	40	NS-ONL-027	40
M	MDC-ONL-002	40	NS-ONL-028	40
L	MDC-ONL-003	40	NS-ONL-029	40
XL	MDC-ONL-004	40	NS-ONL-030	40
XXL	MDC-ONL-005	40	NS-ONL-031	40

Size	Sterile	Units per Package	Non-Sterile	Units per Package
L, Extra Long	MDC-ONL-026	40	NS-ONL-032	40
XL, Extra Long	MDC-ONL-027	40	NS-ONL-033	40
XXL, Extra Long	MDC-ONL-028	40	NS-ONL-034	40



Chemotherapy Gown

It can be produced from SMS / SMMMS / Biflex / Spunlace/ Triplex fabrics upon request.
 The sleeves are connected with ultrasonic sewing which provides high quality.
 It is impermeable to liquid and also resistant to wear and tear.
 The cotton rib cuffs are used on the sleeve hems.
 It offers high comfort and comfortable working opportunities.
 Its sleeves and body parts are reinforced.
 Depending on the sterilization preference, the EO or Gamma Sterilization can be done.
 The products meet EN 13795 Standard and high performance values.

Size	Sterile	Units per Package	Non-Sterile	Units per Package
S	MDC-ONL-0102	40	NS-ONL-035	40
M	MDC-ONL-0103	40	NS-ONL-036	40
L	MDC-ONL-0104	40	NS-ONL-037	40
XL	MDC-ONL-0105	40	NS-ONL-038	40
XXL	MDC-ONL-0106	40	NS-ONL-039	40

Surgical Gowns

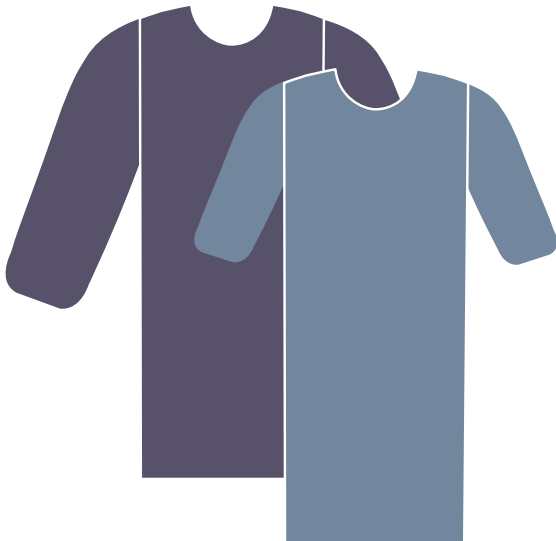

Visitor Gowns

It can be produced from Spunbond Fabric in the range of 35 - 65 gsm upon request. Sleeves are connected to the shoulders with ultrasonic sewing which provides high quality. They can be produced as short and long-sleeved upon request.

Size	Non-Sterile	Units per Package
S	NS-ONL-001	40
M	NS-ONL-002	40
L	NS-ONL-003	40
XL	NS-ONL-004	40
XXL	NS-ONL-005	40

Size	Non-Sterile	Units per Package
S (Short-sleeved)	NS-ONL-006	40
M (Short-sleeved)	NS-ONL-007	40
L (Short-sleeved)	NS-ONL-008	40
XL (Short-sleeved)	NS-ONL-009	40
XXL (Short-sleeved)	NS-ONL-010	40



Surgical Drapes



Back Table Covers

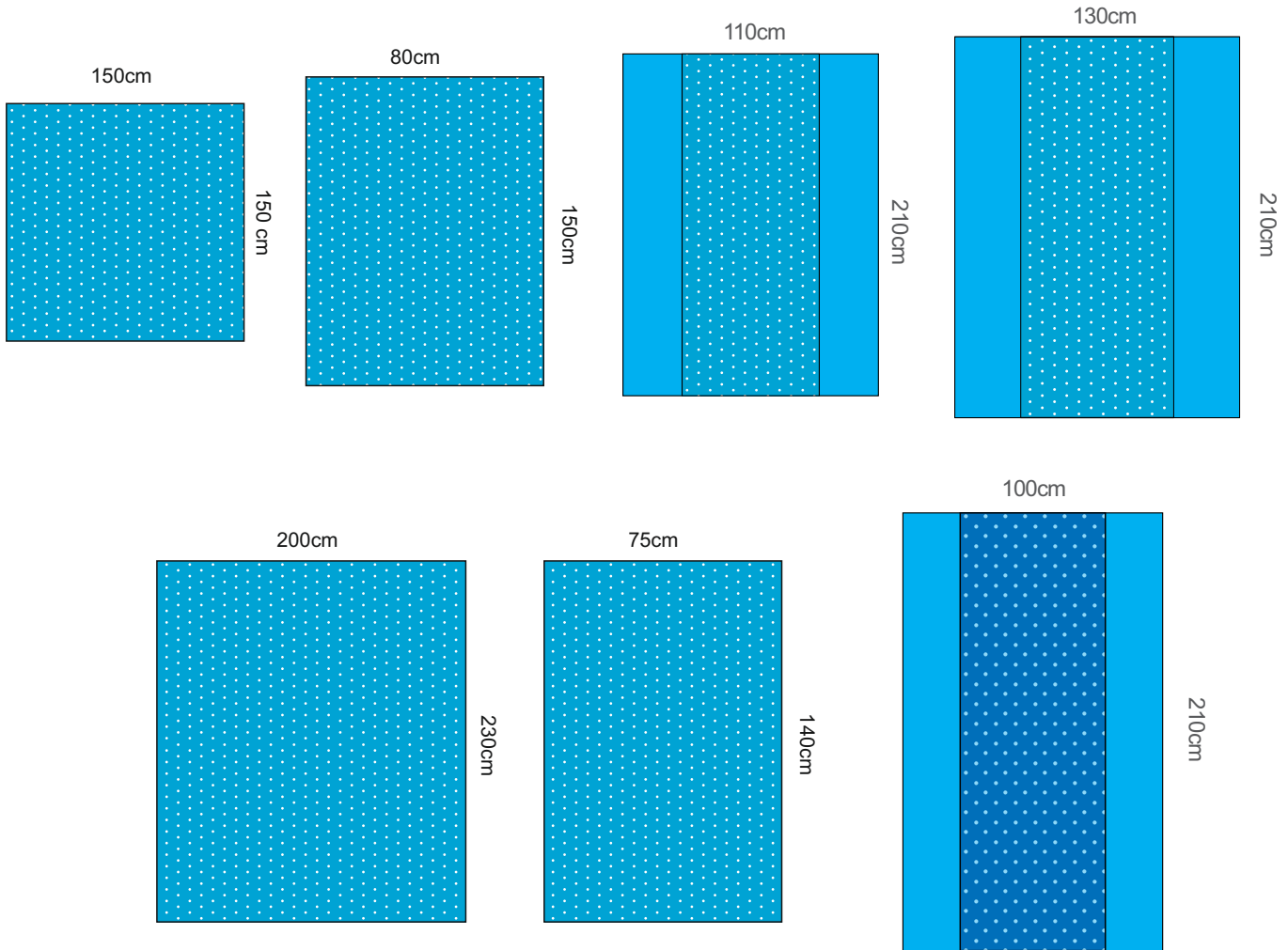

Size	Sterile	Units per Package	Non-Sterile	Units per Package
150 X 150 cm	MDC-ORT-00050	40	NS-ORT-00050	40
80 X 150 cm	MDC-ORT-00030	40	NS-ORT-00030	40
110 X 210 cm	MDC-ORT-00072	40	NS-ORT-02160	40
130 X 210 cm	MDC-ORT-00015	40	NS-ORT-02174	40
200 X 230 cm	MDC-ORT-00030	40	NS-ORT-00072	40
75 X 140 cm	MDC-ORT-00072	40	NS-ORT-00015	40
100 X 210 cm	MDC-ORT-00015	40	NS-ORT-02153	40

Note: The drape sizes are for information purposes. It can be produced in any desired sizes and fabric types.

Mayo Covers

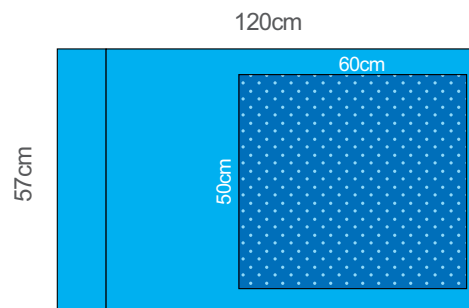
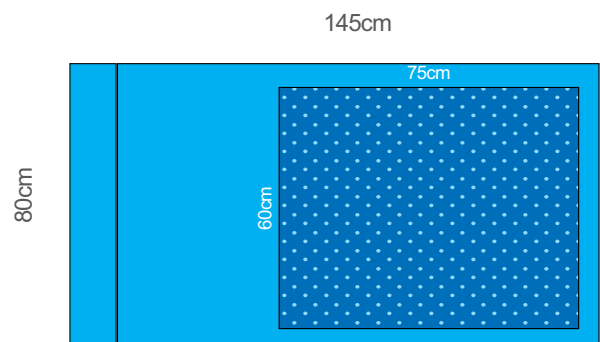
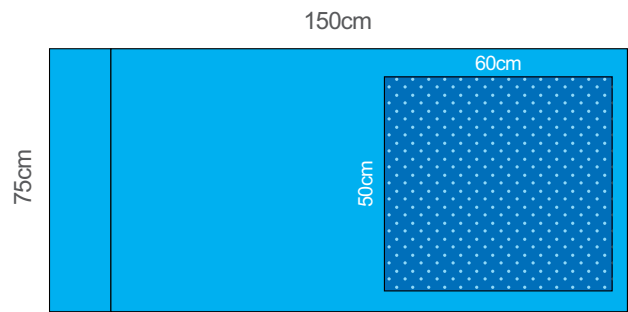
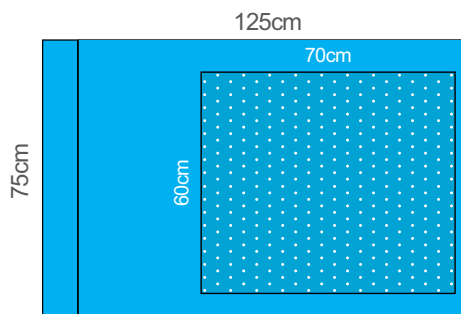
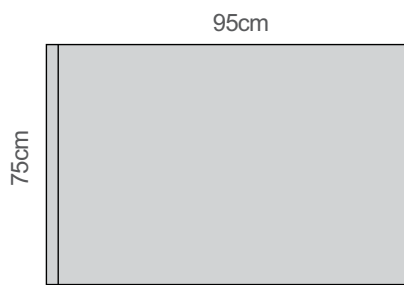
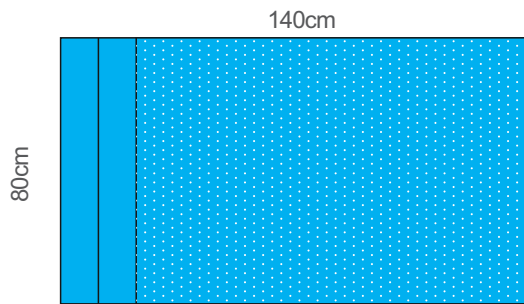
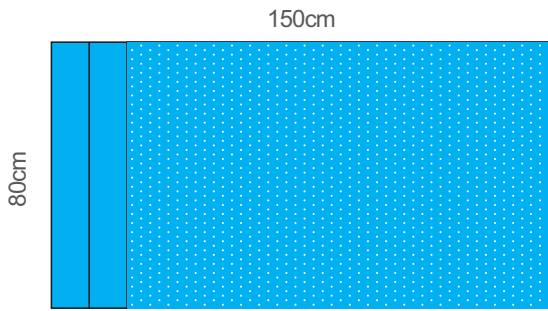

Size	Sterile	Units per Package	Non-Sterile	Units per Package
80 X 150 cm	MDC-ORT-00102	40	NS-ORT-00102	40
80 X 140 cm	MDC-ORT-00100	40	NS-ORT-00100	40
75 X 95 cm	MDC-ORT-00078	40	NS-ORT-00078	40
75 X 125 cm	MDC-ORT-00084	40	NS-ORT-00084	40
75 X 150 cm	MDC-ORT-00089	40	NS-ORT-00089	40
80 X 145 cm	MDC-ORT-00101	40	NS-ORT-00101	40
57 X 120 cm	MDC-ORT-00074	40	NS-ORT-00074	40

Note: The drape sizes are for information purposes. It can be produced in any desired sizes and fabric types.

Basic Drapes

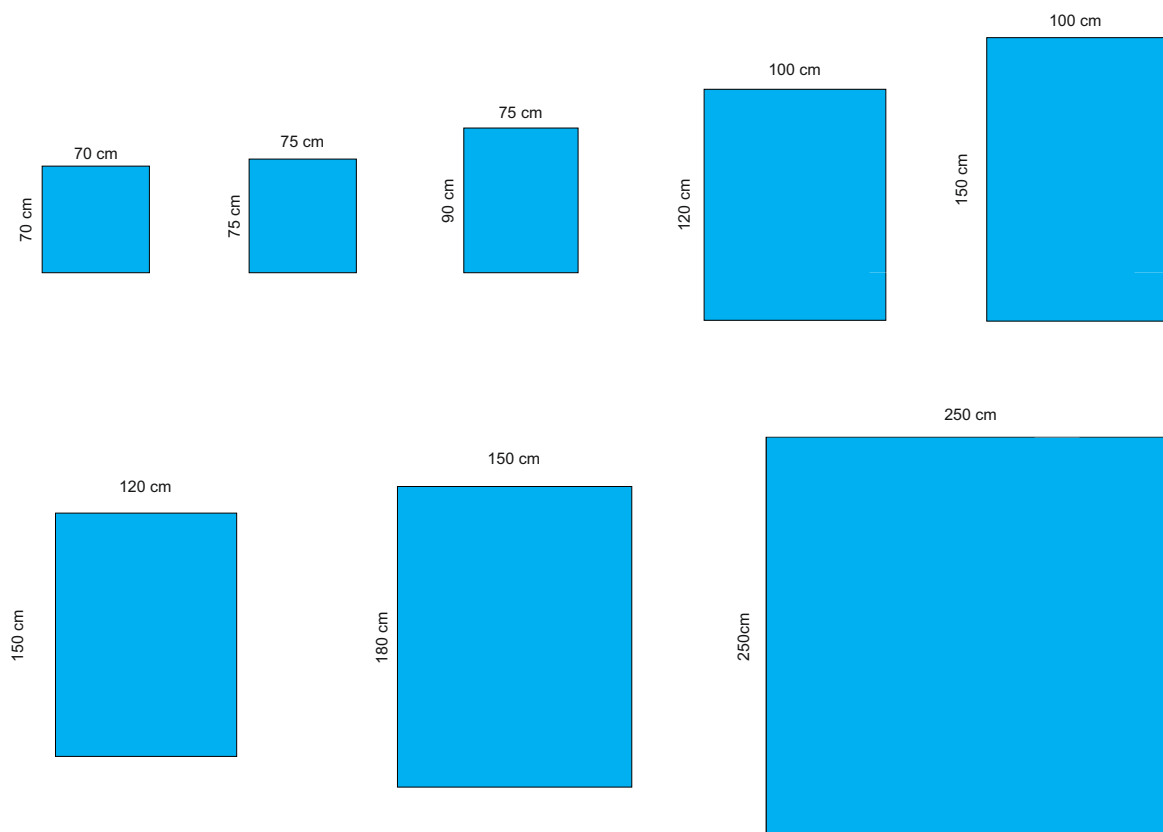

Size	Sterile	Units per Package	Non-Sterile	Units per Package
70 X 70 cm	MDC-ORT-02578	40	NS-ORT-02578	40
75 X 75 cm	MDC-ORT-02615	40	NS-ORT-02615	40
75 X 90 cm	MDC-ORT-02618	40	NS-ORT-02618	40
100 X 120 cm	MDC-ORT-02789	40	NS-ORT-02789	40
100 X 150 cm	MDC-ORT-02795	40	NS-ORT-02795	40
120 X 150 cm	MDC-ORT-02909	40	NS-ORT-02909	40
150 X 180 cm	MDC-ORT-03056	40	NS-ORT-03056	40
250 X 250 cm	MDC-ORT-03297	40	NS-ORT-03297	40

Note: The drape sizes are for information purposes. It can be produced in any desired sizes and fabric types.

Side Drapes

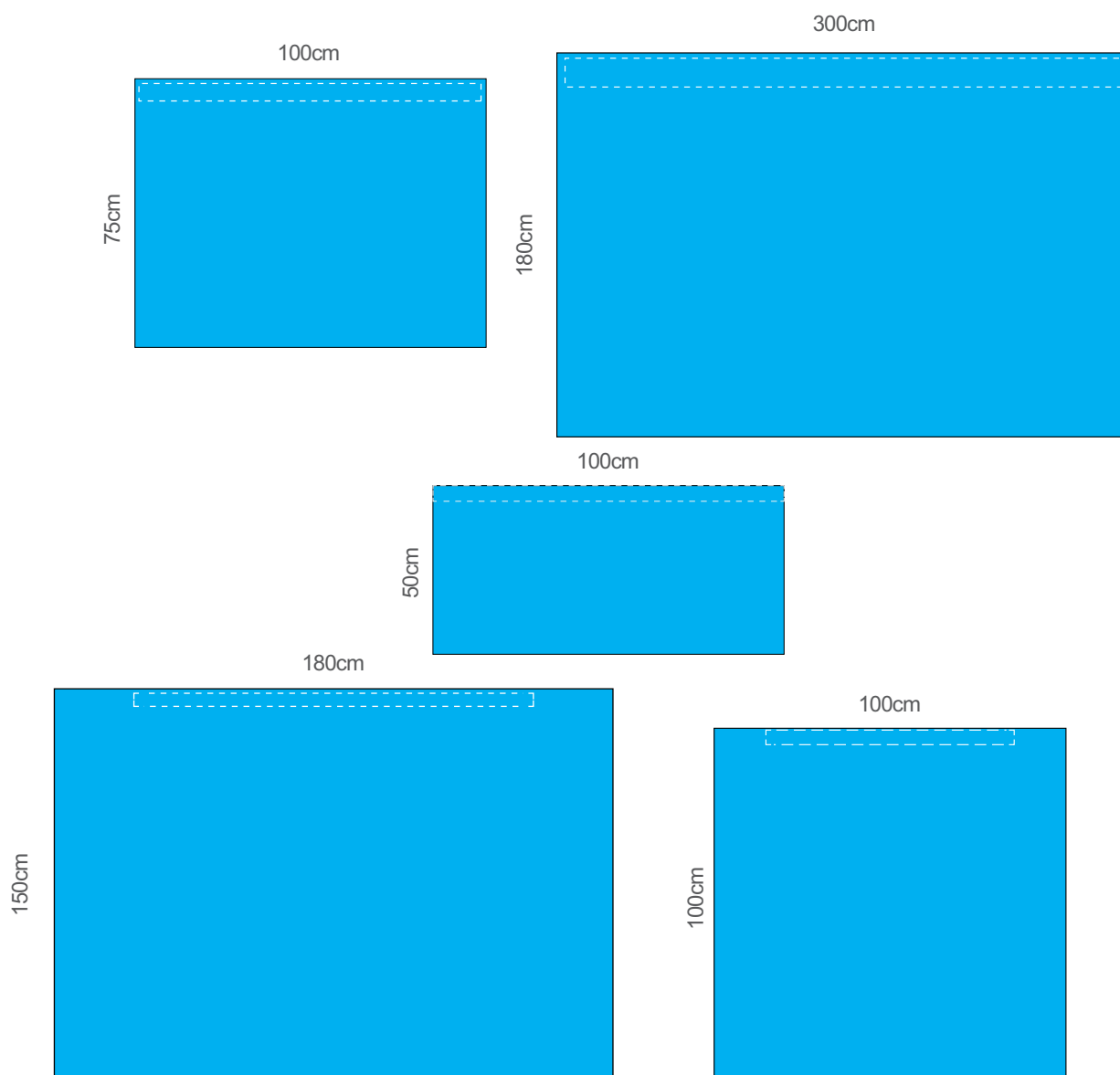

Size	Sterile	Units per Package	Non-Sterile	Units per Package
75 X 100 cm	MDC-ORT-07516	40	NS-ORT-07516	40
180 X 300 cm	MDC-ORT-07534	40	NS-ORT-07534	40
50 X 100 cm	MDC-ORT-07508	40	NS-ORT-07508	40
150 X 180 cm	MDC-ORT-07530	40	NS-ORT-07530	40
100 X 100 cm	MDC-ORT-07527	40	NS-ORT-07527	40

Note: The drape sizes are for information purposes. It can be produced in any desired sizes and fabric types.

Abdominal Drape

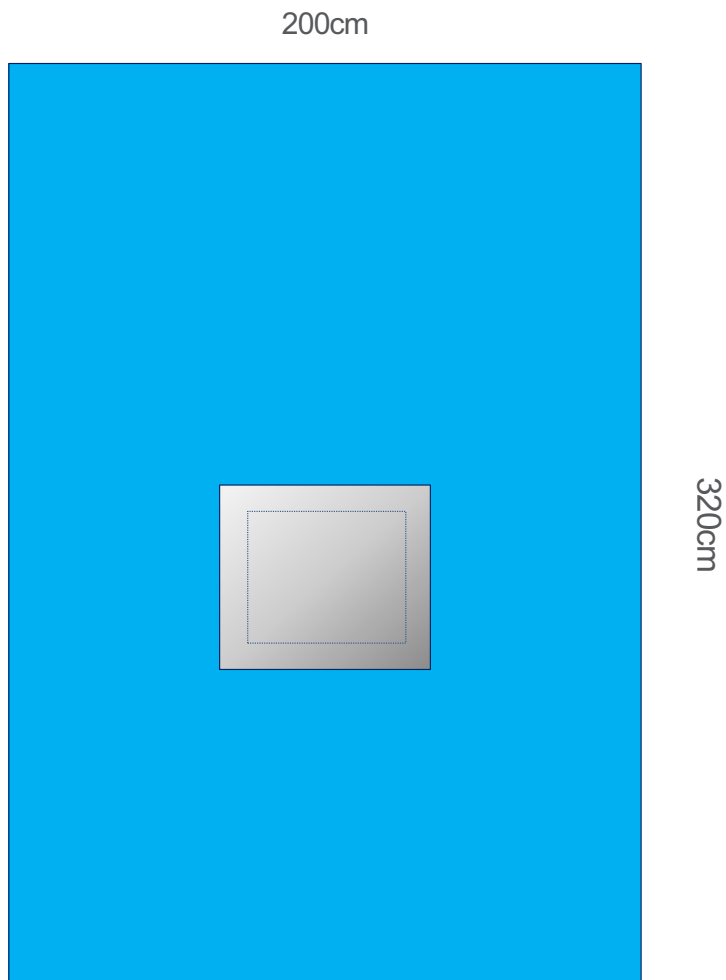

Size	Sterile	Units per Package	Non-Sterile	Units per Package
200 X 320 cm	MDC-ORT-08589	40	NS-ORT-08589	40

Note: The drape sizes are for information purposes. It can be produced in any desired sizes and fabric types.

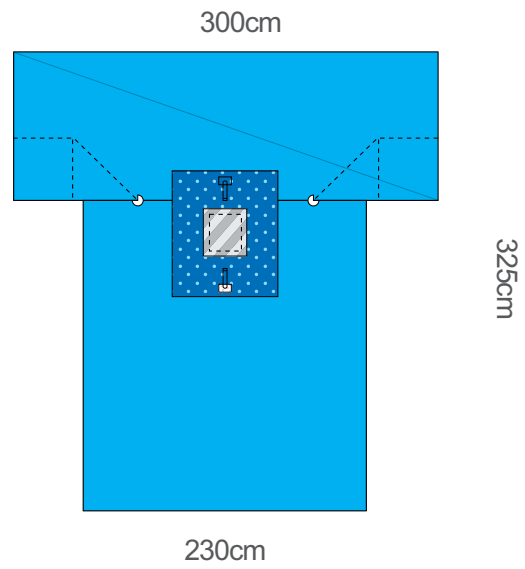
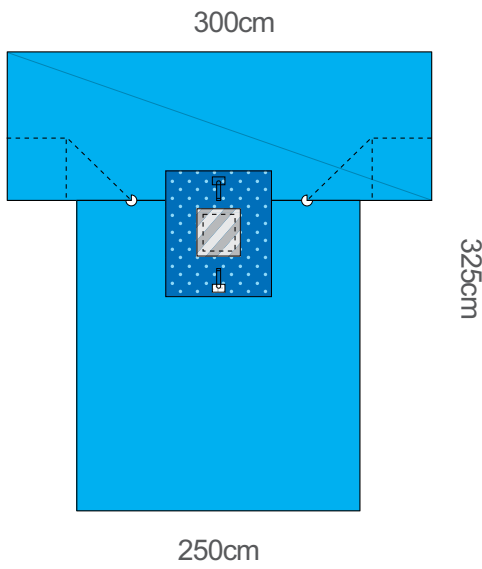

Size	Sterile	Units per Package	Non-Sterile	Units per Package
250 X 325 X 300 cm	MDC-ORT-08590	40	NS-ORT-08590	40
230 X 325 X 300 cm	MDC-ORT-08591	40	NS-ORT-08591	40

Note: The drape sizes are for information purposes. It can be produced in any desired sizes and fabric types.

Laparoscopy Drapes

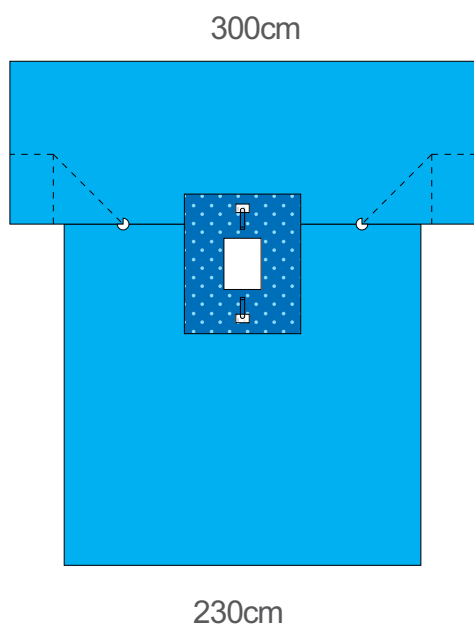

325cm

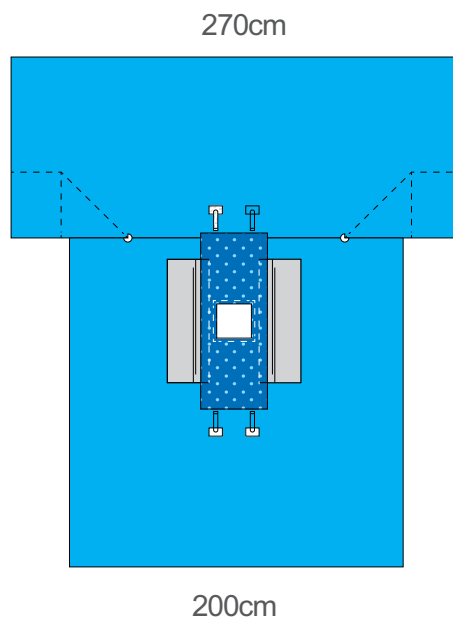

310cm

Size	Sterile	Units per Package	Non-Sterile	Units per Package
230 X 325 X 300 cm	MDC-ORT-08592	40	NS-ORT-08592	40
200 X 310 X 270 cm	MDC-ORT-08593	40	NS-ORT-08593	40

Note: The drape sizes are for information purposes. It can be produced in any desired sizes and fabric types.

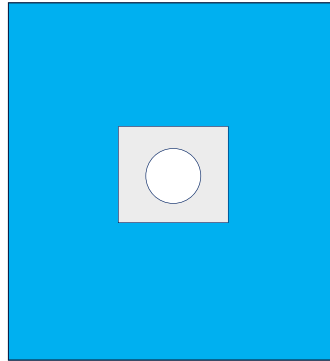

Size	Sterile	Units per Package	Non-Sterile	Units per Package
30 X 30 cm	MDC-ORT-05402	40	NS-ORT-05402	40
40 X 250 cm	MDC-ORT-05533	40	NS-ORT-05533	40
50 X 50 cm	MDC-ORT-05576	40	NS-ORT-05576	40
100 X 100 cm	MDC-ORT-05941	40	NS-ORT-05941	40
100 X 150 cm	MDC-ORT-05951	40	NS-ORT-05951	40
150 X 240 cm	MDC-ORT-06224	40	NS-ORT-06224	40
250 X 250 cm	MDC-ORT-06453	40	NS-ORT-06453	40

Note: The drape sizes are for information purposes. It can be produced in any desired sizes and fabric types.

Fenestrated Drapes

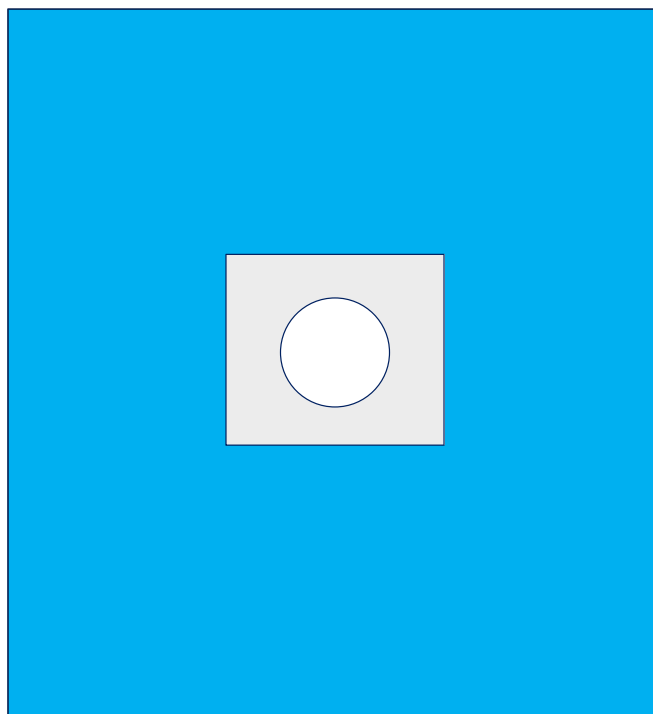

Size	Sterile	Units per Package	Non-Sterile	Units per Package
105 X 175 cm	MDC-ORT-03882	40	NS-ORT-03882	40
115 X 245 cm	MDC-ORT-03953	40	NS-ORT-03953	40
130 X 230 cm	MDC-ORT-04028	40	NS-ORT-04028	40
150 X 235 cm	MDC-ORT-04119	40	NS-ORT-04119	40
170 X 250 cm	MDC-ORT-04196	40	NS-ORT-04196	40
185 X 250 cm	MDC-ORT-04241	40	NS-ORT-04241	40
250 X 250 cm	MDC-ORT-04349	40	NS-ORT-04349	40

Note: The drape sizes are for information purposes. It can be produced in any desired sizes and fabric types.

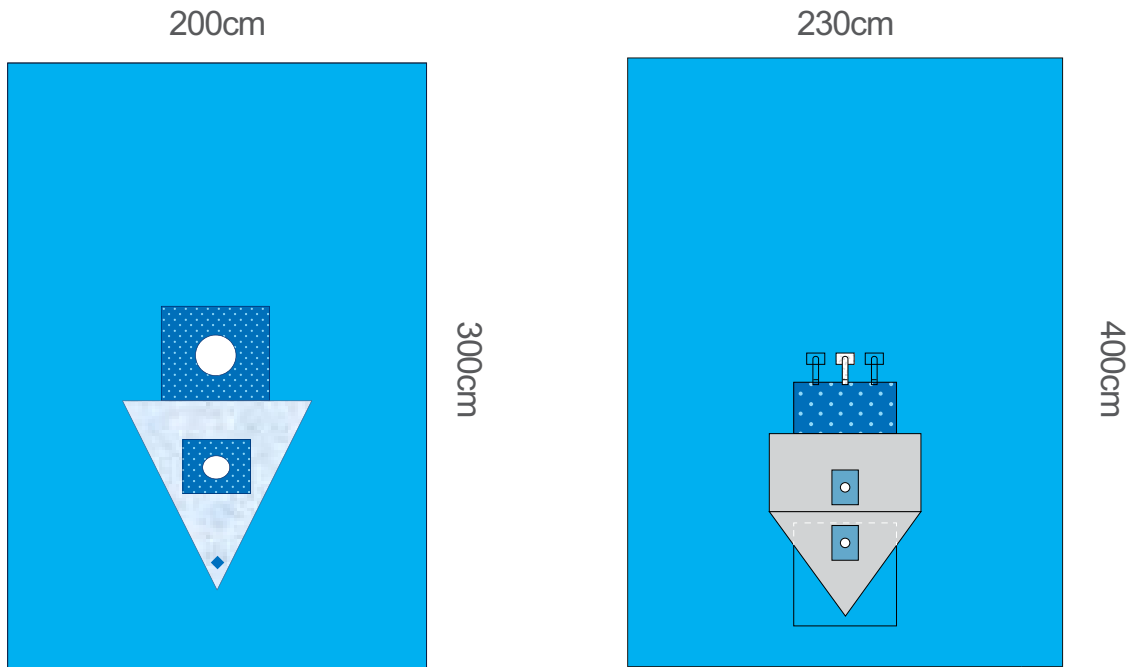

Size	Sterile	Units per Package	Non-Sterile	Units per Package
200 X 300 cm	MDC-ORT-08594	40	NS-ORT-08594	40
230 X 400 cm	MDC-ORT-08595	40	NS-ORT-08595	40

Note: The drape sizes are for information purposes. It can be produced in any desired sizes and fabric types.

Extremity Drapes

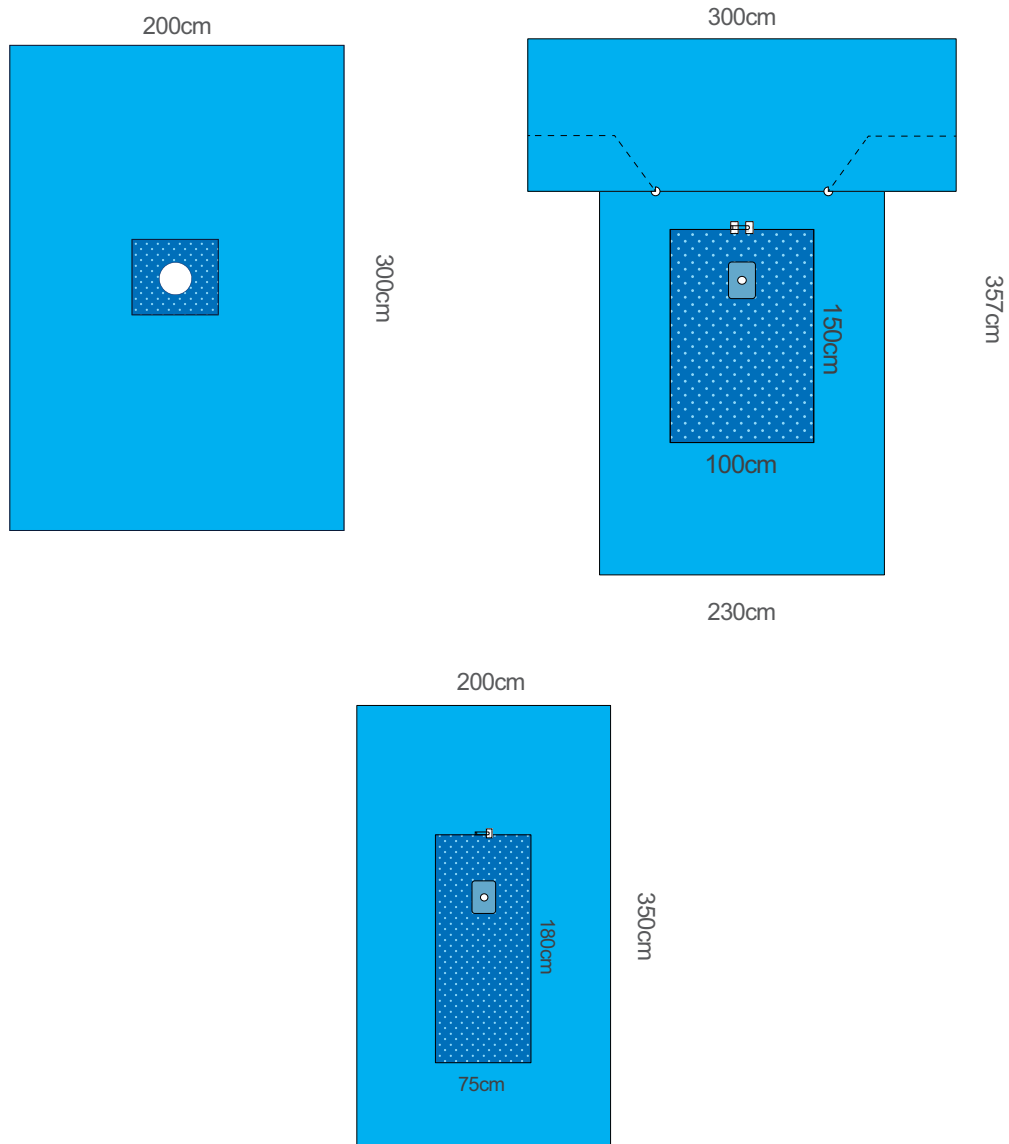

Size	Sterile	Units per Package	Non-Sterile	Units per Package
200 X 300 cm	MDC-ORT-08596	40	NS-ORT-08596	40
200 X 350 cm	MDC-ORT-08597	40	NS-ORT-08597	40
200 X 357 X 300 cm	MDC-ORT-08598	40	NS-ORT-08598	40

Note: The drape sizes are for information purposes. It can be produced in any desired sizes and fabric types.

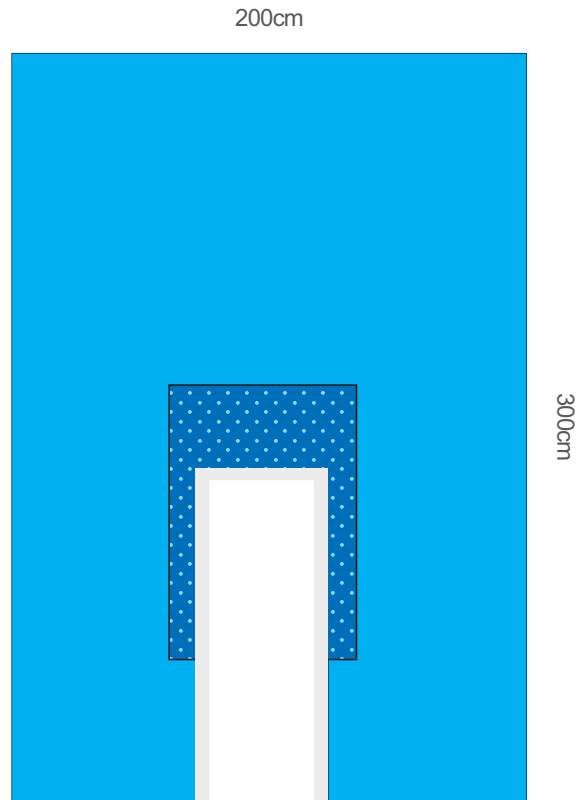

Size	Sterile	Units per Package	Non-Sterile	Units per Package
200 X 300 cm	MDC-ORT-08599	40	NS-ORT-08599	40

Note: The drape sizes are for information purposes. It can be produced in any desired sizes and fabric types.

Hip Drapes

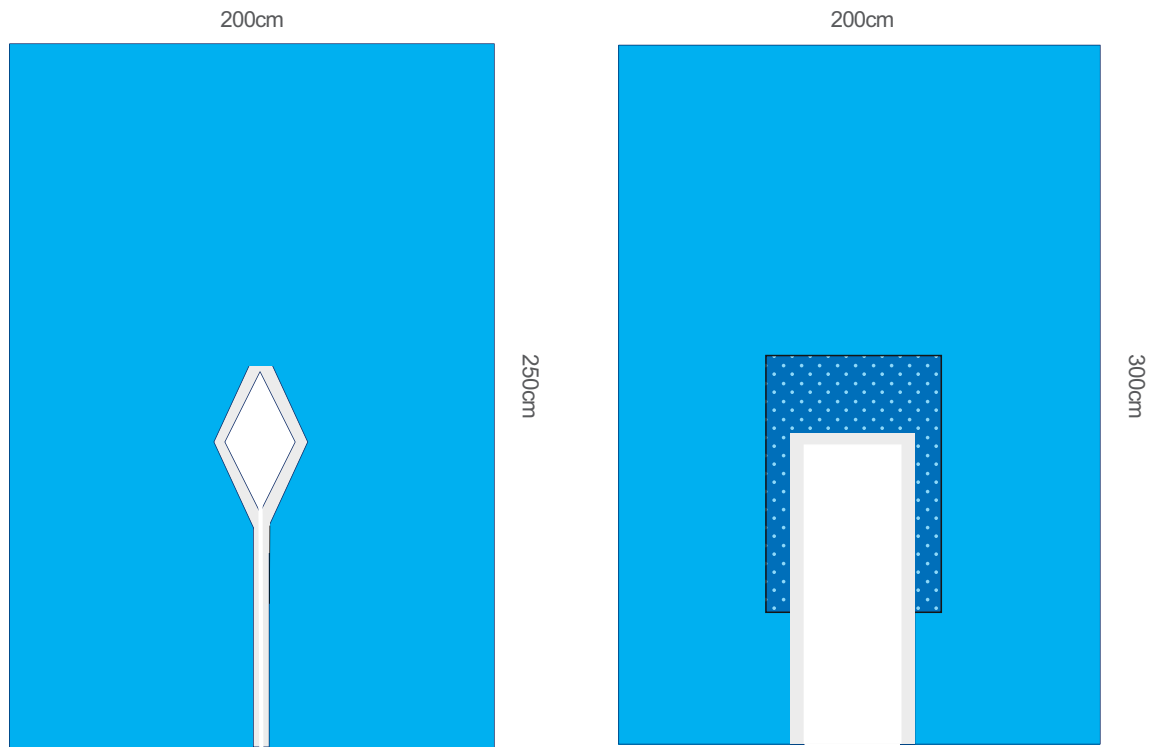

Size	Sterile	Units per Package	Non-Sterile	Units per Package
200 X 250 cm	MDC-ORT-08600	40	NS-ORT-08600	40
200 X 300 cm	MDC-ORT-08601	40	NS-ORT-08601	40

Note: The drape sizes are for information purposes. It can be produced in any desired sizes and fabric types.

Angiography Drapes

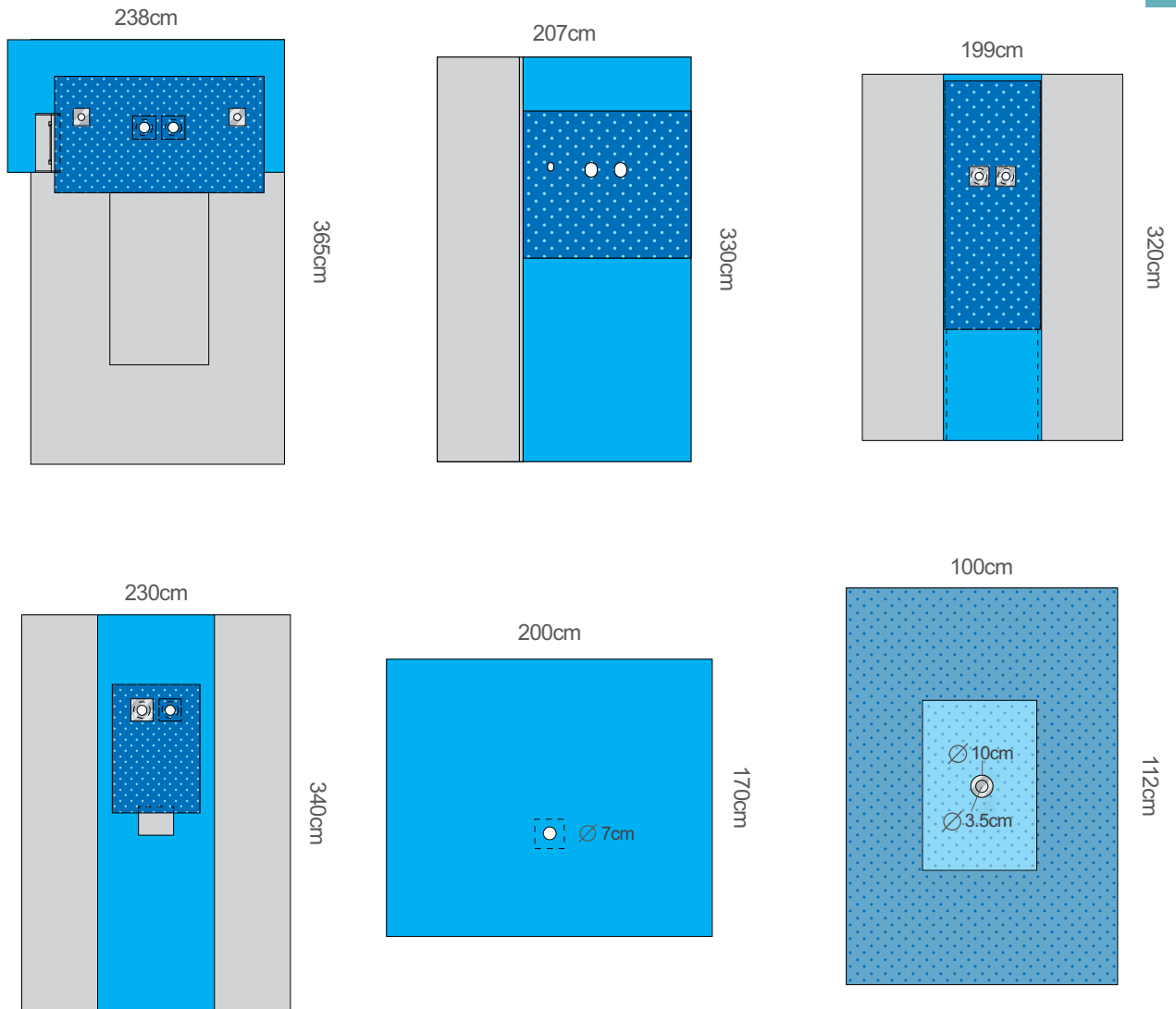

Size	Sterile	Units per Package	Non-Sterile	Units per Package
238 X 365 cm	MDC-ORT-08602	40	NS-ORT-08602	40
207 X 330 cm	MDC-ORT-08603	40	NS-ORT-08603	40
199 X 320 cm	MDC-ORT-08604	40	NS-ORT-08604	40
230 X 340 cm	MDC-ORT-08605	40	NS-ORT-08605	40
170 X 200 cm	MDC-ORT-08606	40	NS-ORT-08606	40
100 X 112 cm	MDC-ORT-08607	40	NS-ORT-08607	40

Note: The drape sizes are for information purposes. It can be produced in any desired sizes and fabric types.

Cardiovascular Drapes

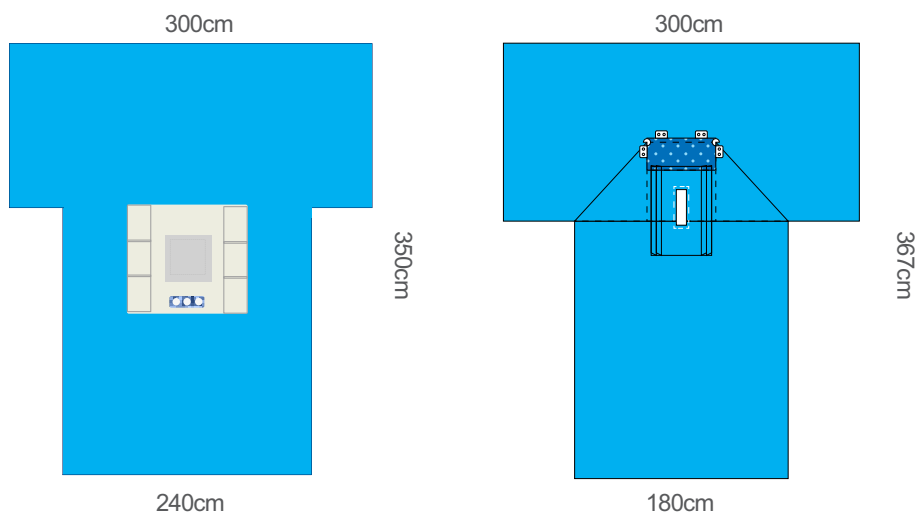

Size	Sterile	Units per Package	Non-Sterile	Units per Package
240 X 350 X 300 cm	MDC-ORT-08608	40	NS-ORT-08608	40
180 X 367 X 300 cm	MDC-ORT-08609	40	NS-ORT-08609	40

Note: The drape sizes are for information purposes. It can be produced in any desired sizes and fabric types.

Perineal U-Shaped Drapes

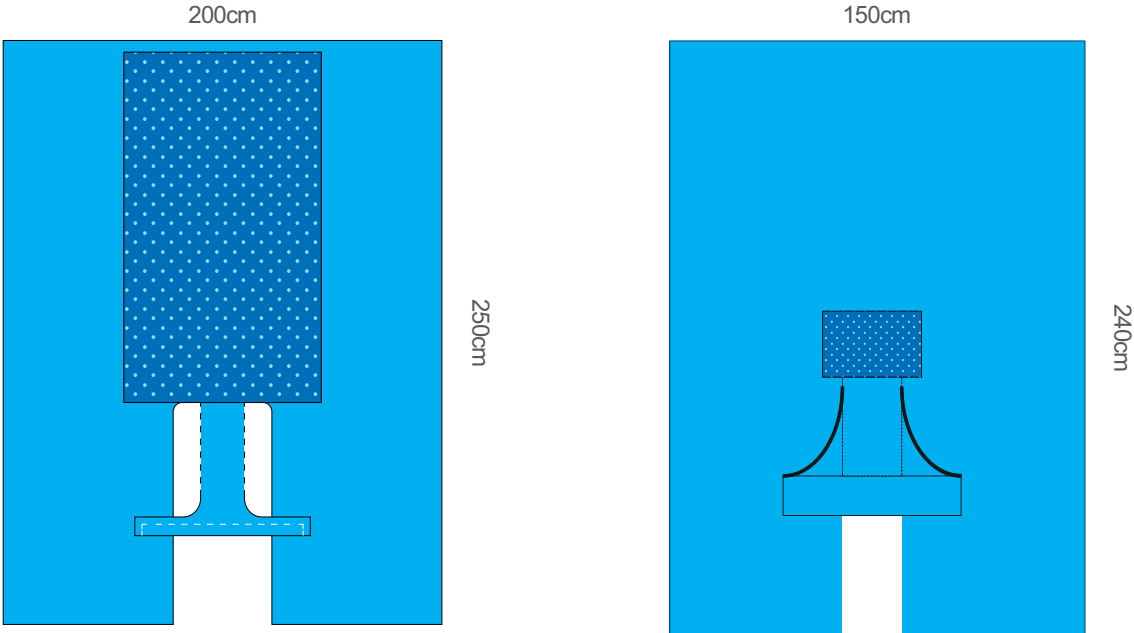

Size	Sterile	Units per Package	Non-Sterile	Units per Package
200 X 250 cm	MDC-ORT-08610	40	NS-ORT-08610	40
150 X 240 cm	MDC-ORT-08611	40	NS-ORT-08611	40

Note: The drape sizes are for information purposes. It can be produced in any desired sizes and fabric types.

Embryo Transfer Drape

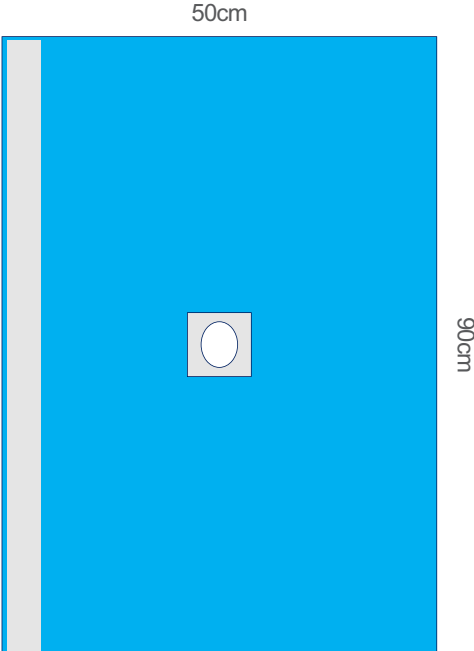

Size	Sterile	Units per Package	Non-Sterile	Units per Package
50 X 90 cm	MDC-ORT-08612	40	NS-ORT-08612	40

Note: The drape sizes are for information purposes. It can be produced in any desired sizes and fabric types.

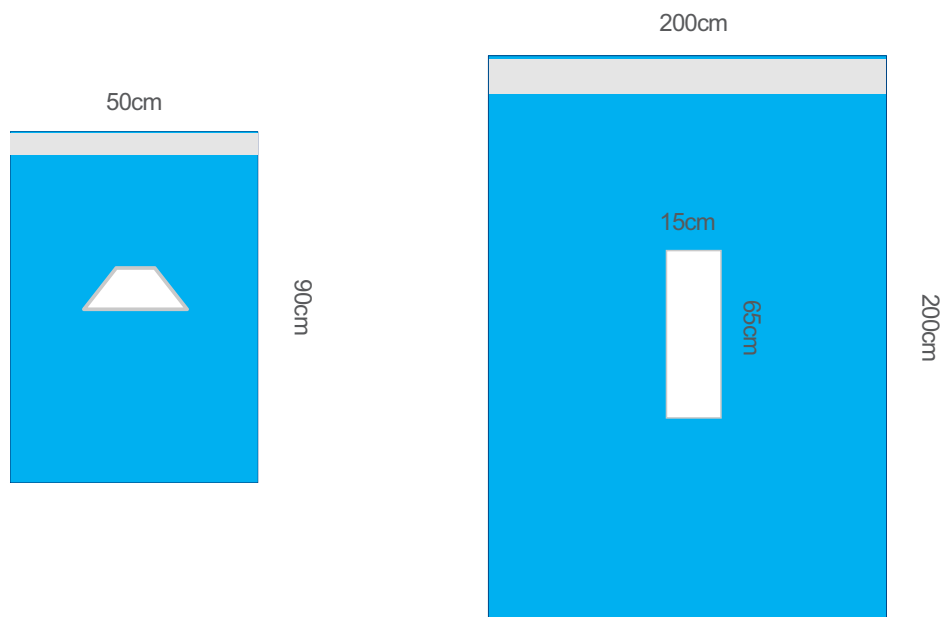

Size	Sterile	Units per Package	Non-Sterile	Units per Package
50 X 90 cm	MDC-ORT-08613	40	NS-ORT-08613	40
200 X 200 cm	MDC-ORT-08614	40	NS-ORT-08614	40

Note: The drape sizes are for information purposes. It can be produced in any desired sizes and fabric types.

Cesarean Drapes

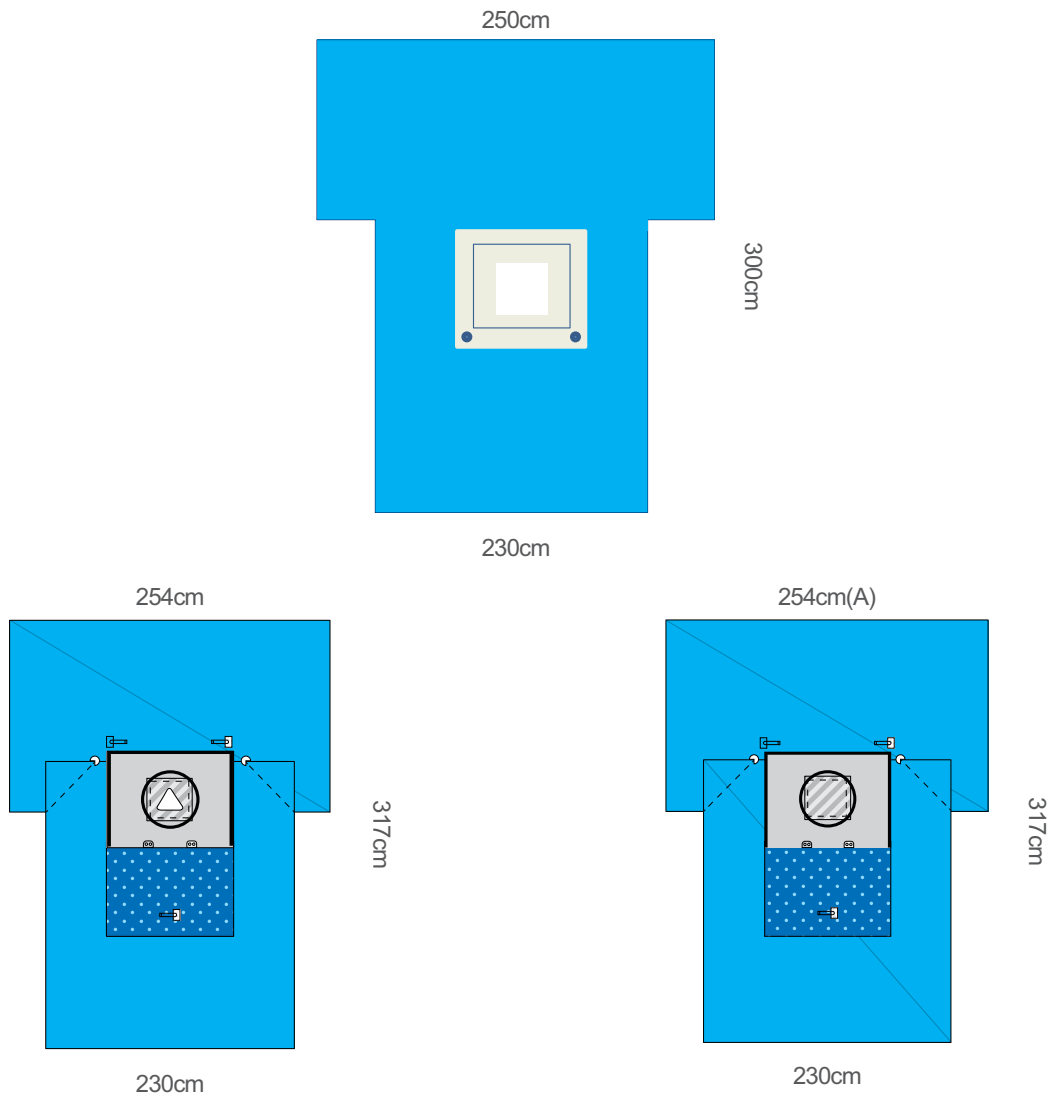

Size	Sterile	Units per Package	Non-Sterile	Units per Package
230 X 300 X 250 cm	MDC-ORT-08615	40	NS-ORT-08615	40
230 X 317 X 254 cm	MDC-ORT-08616	40	NS-ORT-08616	40
230 X 317 X 254 cm(A)	MDC-ORT-08617	40	NS-ORT-08617	40

Note: The drape sizes are for information purposes. It can be produced in any desired sizes and fabric types.

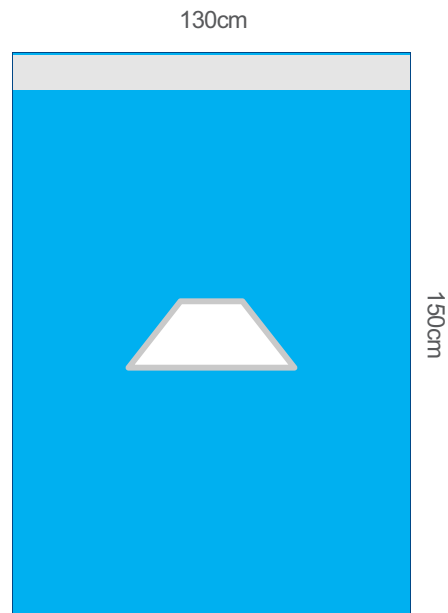

Size	Sterile	Units per Package	Non-Sterile	Units per Package
130 X 150 cm	MDC-ORT-08618	40	NS-ORT-08618	40

Note: The drape sizes are for information purposes. It can be produced in any desired sizes and fabric types.

Craniotomy Drapes

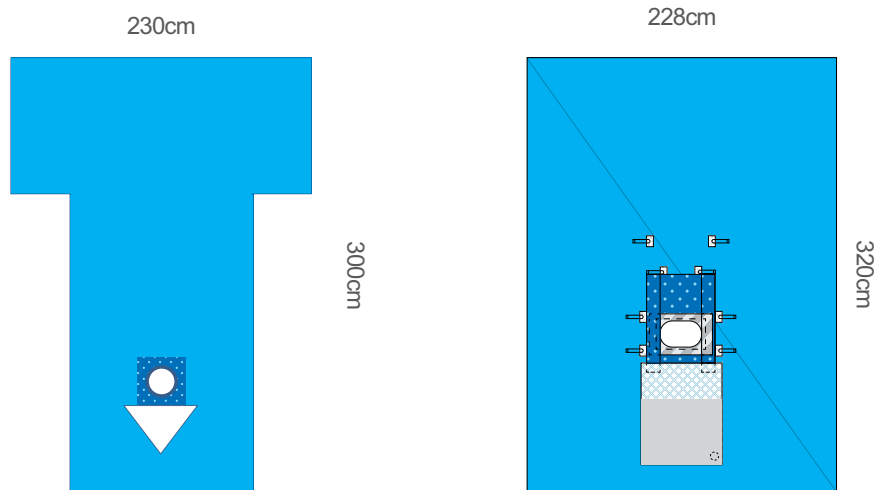

Size	Sterile	Units per Package	Non-Sterile	Units per Package
230 X 300 cm	MDC-ORT-08619	40	NS-ORT-08619	40
228 X 320 cm	MDC-ORT-08620	40	NS-ORT-08620	40

Note: The drape sizes are for information purposes. It can be produced in any desired sizes and fabric types.

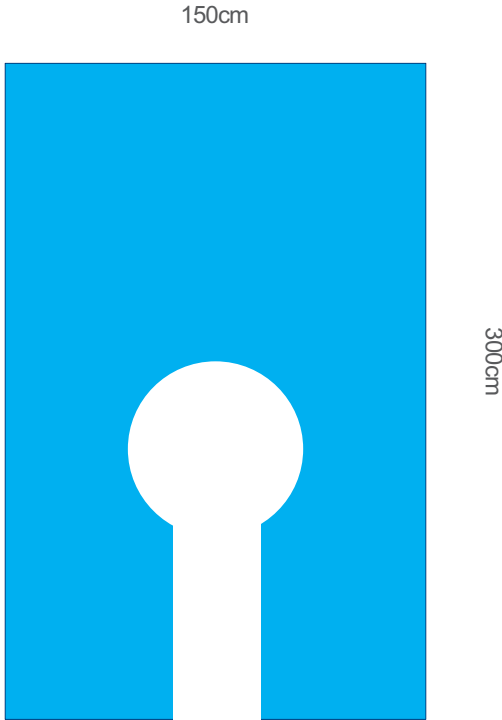

Size	Sterile	Units per Package	Non-Sterile	Units per Package
150 X 300 cm	MDC-ORT-08621	40	NS-ORT-08621	40

Note: The drape sizes are for information purposes. It can be produced in any desired sizes and fabric types.

Spinal Drapes

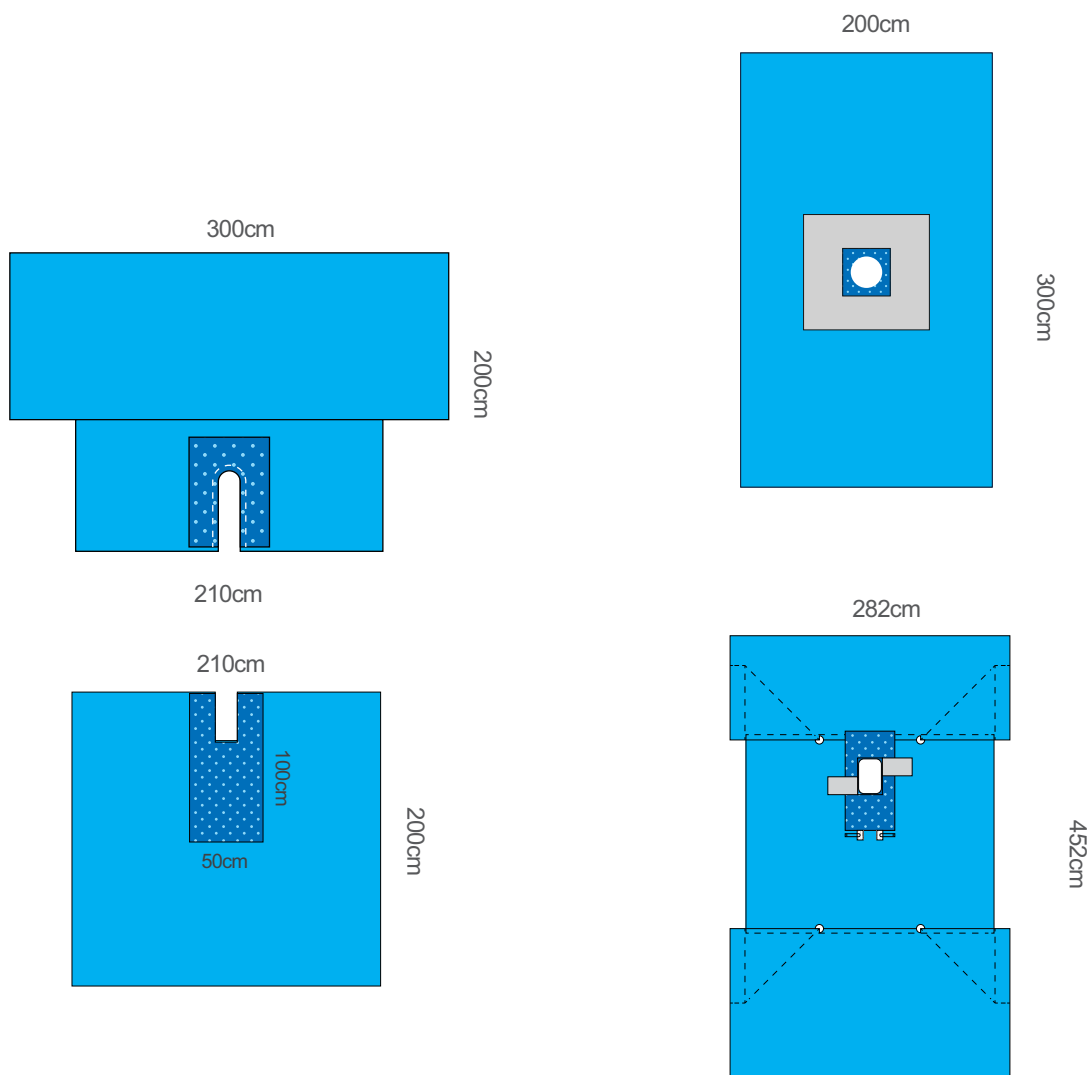

Size	Sterile	Units per Package	Non-Sterile	Units per Package
210 X 200 X 300 cm	MDC-ORT-08622	40	NS-ORT-08622	40
200 X 210 cm	MDC-ORT-08623	40	NS-ORT-08623	40
200 X 300 cm	MDC-ORT-08624	40	NS-ORT-08624	40
282 X 452 cm	MDC-ORT-08625	40	NS-ORT-08625	40

Note: The drape sizes are for information purposes. It can be produced in any desired sizes and fabric types.

Ophthalmic Drapes

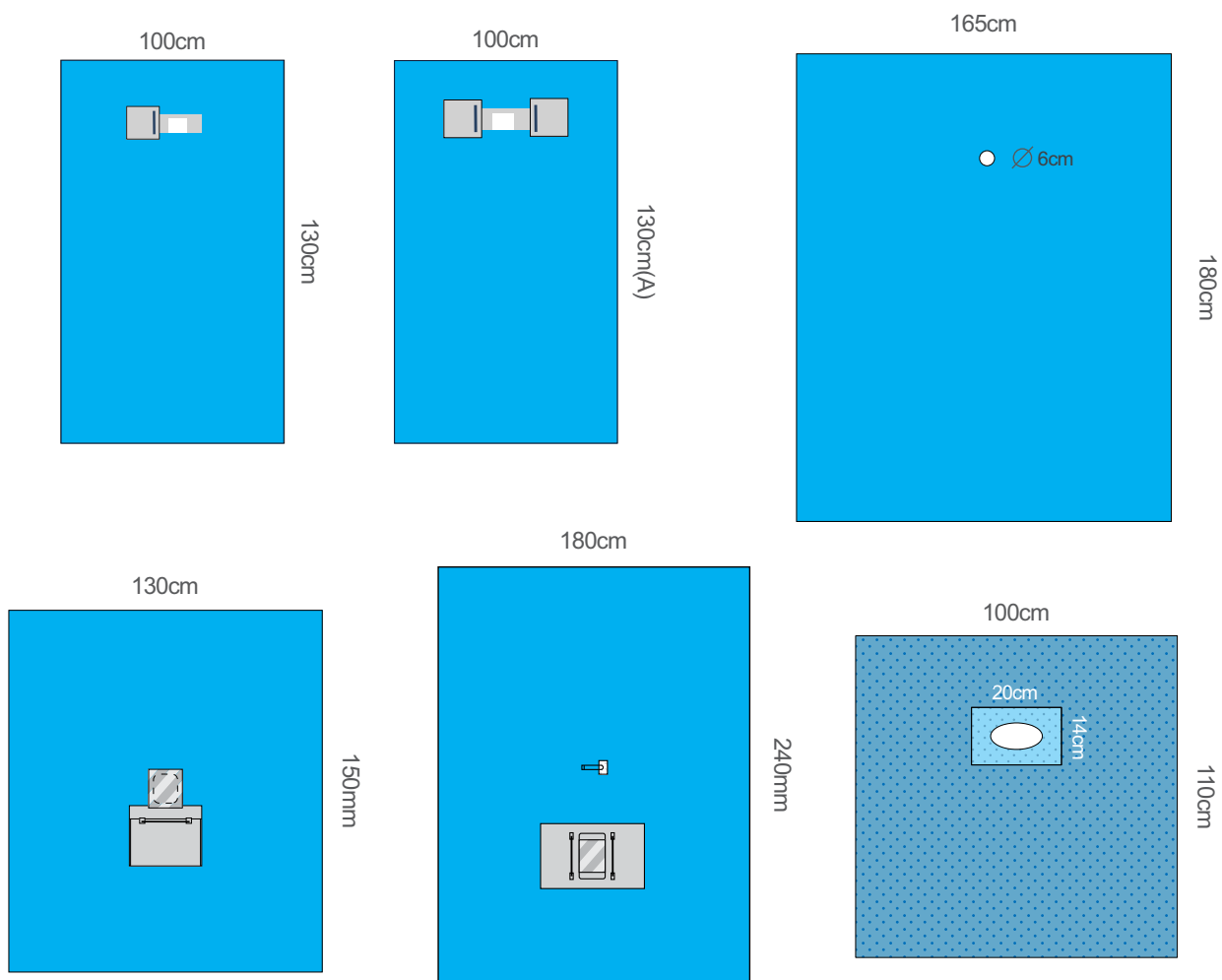

Size	Sterile	Units per Package	Non-Sterile	Units per Package
100 X 130 cm	MDC-ORT-08626	40	NS-ORT-08626	40
100 X 130(A) cm	MDC-ORT-08627	40	NS-ORT-08627	40
165 X 180 cm	MDC-ORT-08628	40	NS-ORT-08628	40
130 X 150 cm	MDC-ORT-08629	40	NS-ORT-08629	40
180 X 240 cm	MDC-ORT-08630	40	NS-ORT-08630	40
100 X 110 cm	MDC-ORT-08631	40	NS-ORT-08631	40

Note: The drape sizes are for information purposes. It can be produced in any desired sizes and fabric types.

Percutaneous Drape

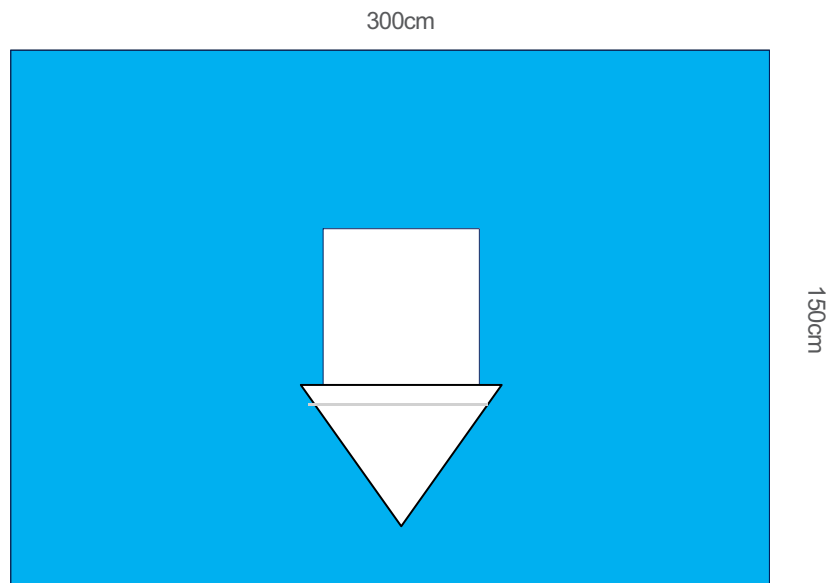

Size	Sterile	Units per Package	Non-Sterile	Units per Package
150 X 300 cm	MDC-ORT-08632	40	NS-ORT-08632	40

Note: The drape sizes are for information purposes. It can be produced in any desired sizes and fabric types.

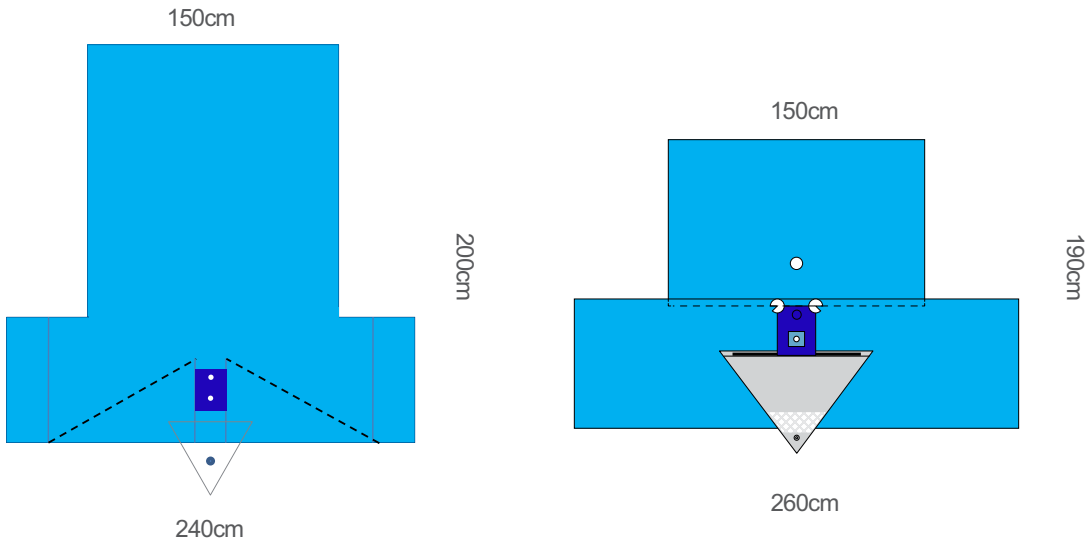

Size	Sterile	Units per Package	Non-Sterile	Units per Package
240 X 200 X 150 cm	MDC-ORT-08633	40	NS-ORT-08633	40
260 X 190 X 150 cm	MDC-ORT-08634	40	NS-ORT-08634	40

Note: The drape sizes are for information purposes. It can be produced in any desired sizes and fabric types.

Cystoscopy Drapes

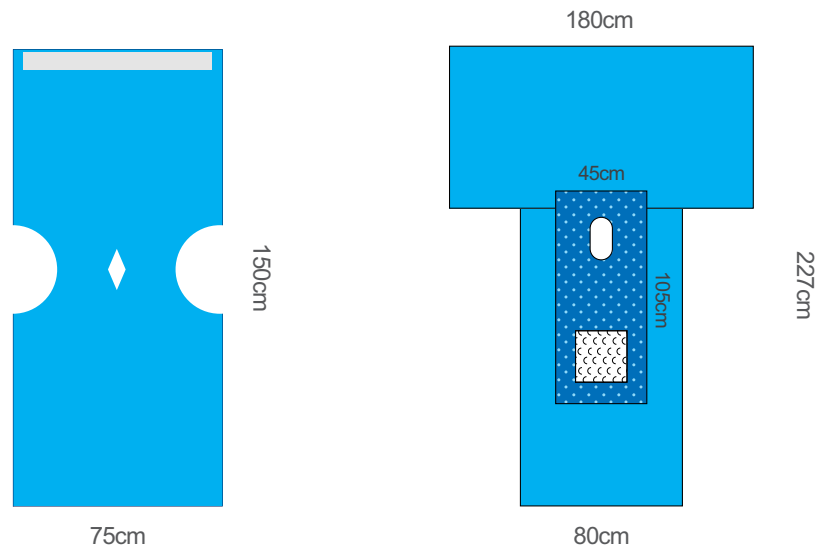

Size	Sterile	Units per Package	Non-Sterile	Units per Package
75 X 150 cm	MDC-ORT-08635	40	NS-ORT-08635	40
80 X 227 X 180 cm	MDC-ORT-08636	40	NS-ORT-08636	40

Note: The drape sizes are for information purposes. It can be produced in any desired sizes and fabric types.

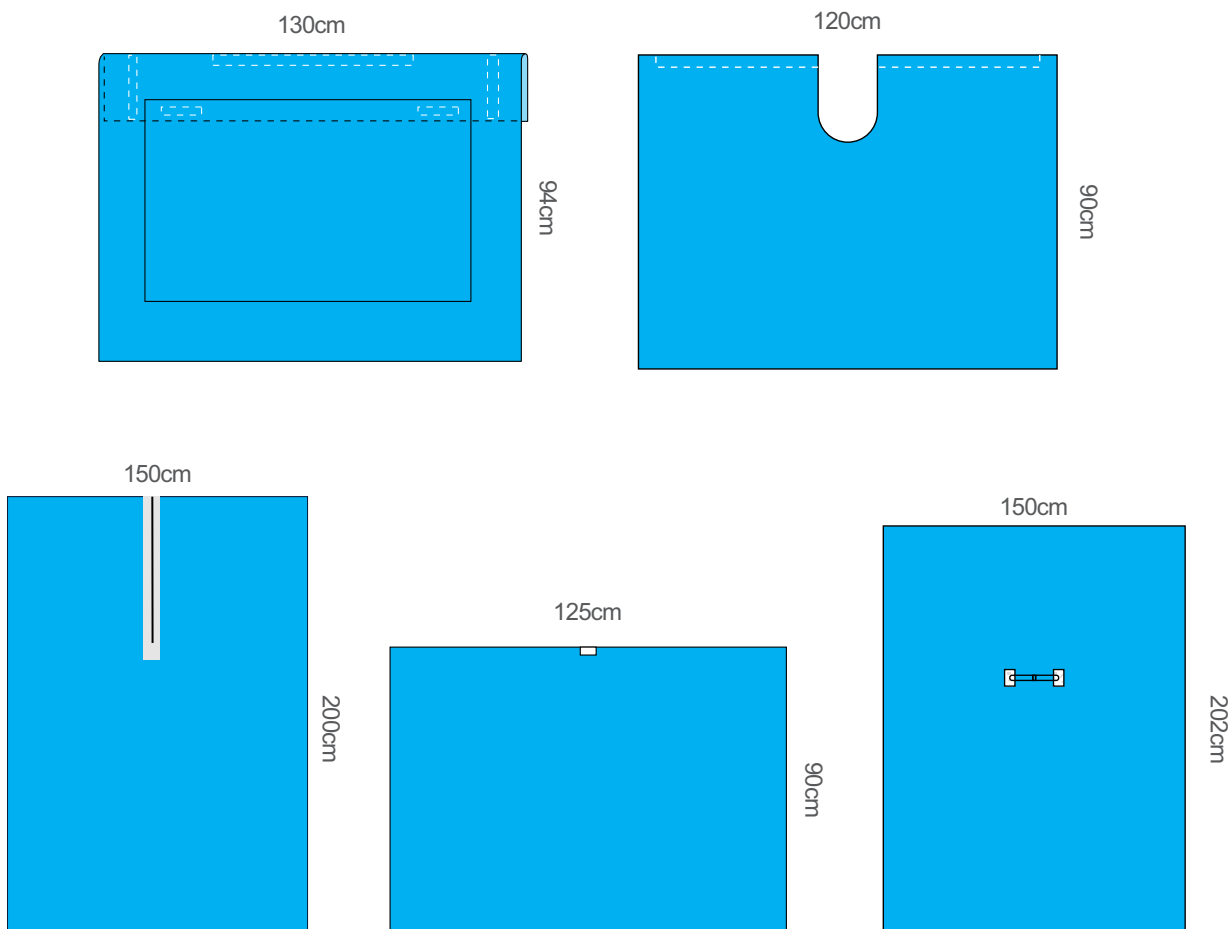

Size	Sterile	Units per Package	Non-Sterile	Units per Package
94 X 130 cm	MDC-ORT-08637	40	NS-ORT-08637	40
90 X 120 cm	MDC-ORT-08638	40	NS-ORT-08638	40
150 X 200 cm	MDC-ORT-08639	40	NS-ORT-08639	40
90 X 125 cm	MDC-ORT-08640	40	NS-ORT-08640	40
150 X 202 cm	MDC-ORT-08641	40	NS-ORT-08641	40

Note: The drape sizes are for information purposes. It can be produced in any desired sizes and fabric types.

Rhinoplasty Drape

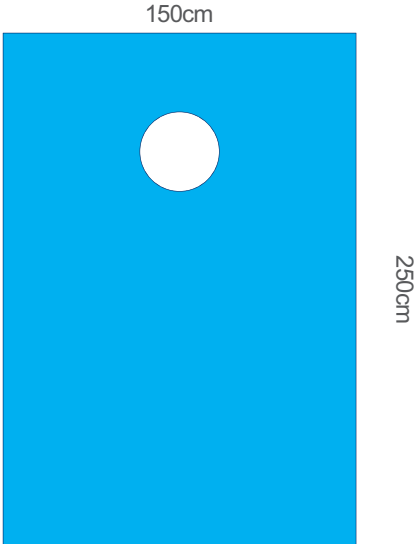

Size	Sterile	Units per Package	Non-Sterile	Units per Package
150 X 250 cm	MDC-ORT-08642	40	NS-ORT-08642	40

Note: The drape sizes are for information purposes. It can be produced in any desired sizes and fabric types.

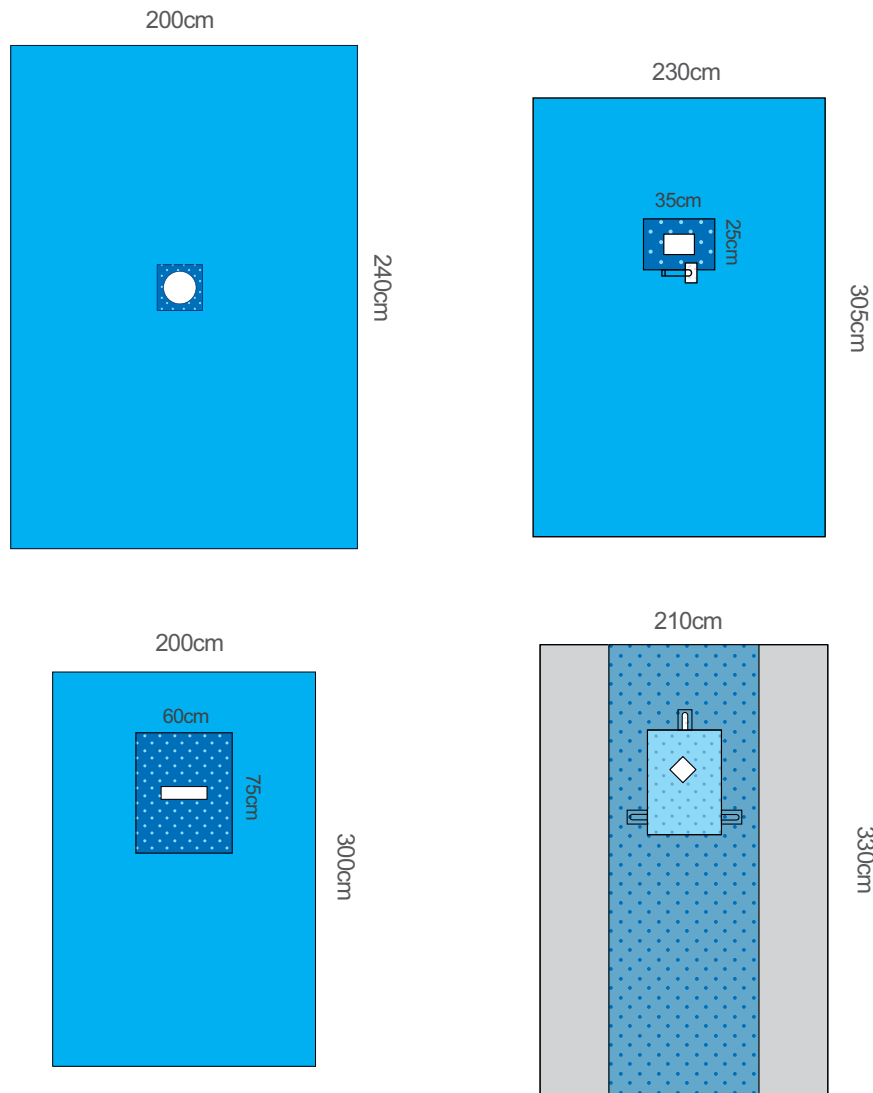

Size	Sterile	Units per Package	Non-Sterile	Units per Package
200 X 240 cm	MDC-ORT-08643	40	NS-ORT-08643	40
230 X 305 cm	MDC-ORT-08644	40	NS-ORT-08644	40
200 X 300 cm	MDC-ORT-08645	40	NS-ORT-08645	40
210 X 330 cm	MDC-ORT-08646	40	NS-ORT-08646	40

Note: The drape sizes are for information purposes. It can be produced in any desired sizes and fabric types.

Dental Drape

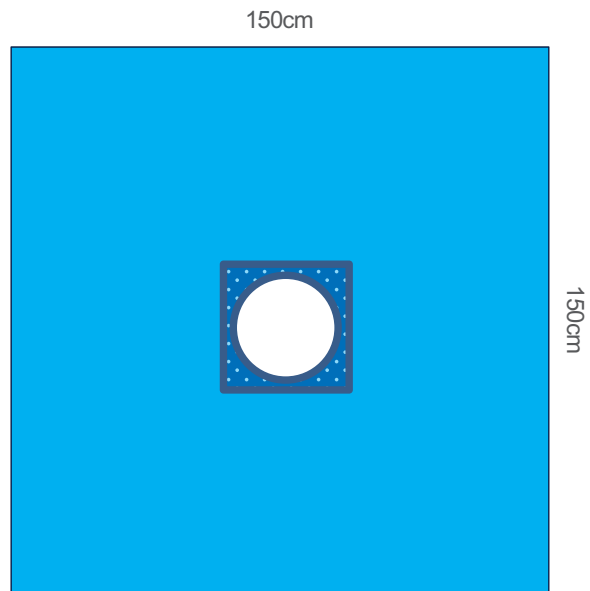

Size	Sterile	Units per Package	Non-Sterile	Units per Package
150 X 150 cm	MDC-ORT-08647	40	NS-ORT-08647	40

Note: The drape sizes are for information purposes. It can be produced in any desired sizes and fabric types.



General Surgery



General Surgery Drape Set

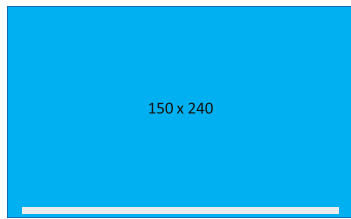

ANESTHESIA DRAPE

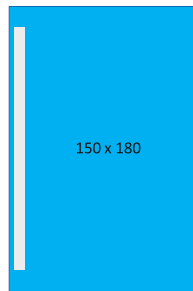

SIDE DRAPE

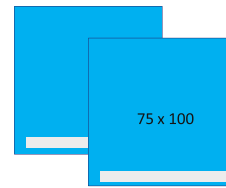

SIDE DRAPE

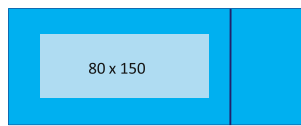

MAYO COVER

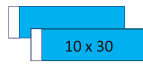

OPTAPE

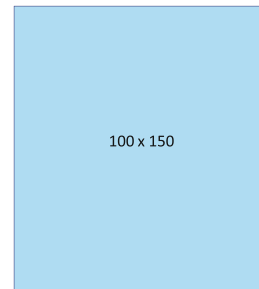

BACK TABLE COVER



STANDARD SURGICAL GOWN

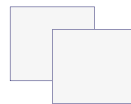

TOWEL

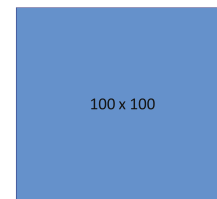

PACK

REF. MDC-ORTS-0205

GENERAL SURGERY DRAPE SET		Sizes	Pieces
	ANESTHESIA DRAPE	150 x 240	1
	SIDE DRAPE	150 x 180	1
	SIDE DRAPE	75 x 100	2
	BACK TABLE COVER	100 x 150	1
	MAYO COVER	80 x 150	1
	OPTAPE	10 x 30	2
	STANDARD SURGICAL GOWN	L	2
	TOWEL	40 x 40	2
	PACK	100 x 100	1

Note: The set contents are for information purposes. The optional production can be done.

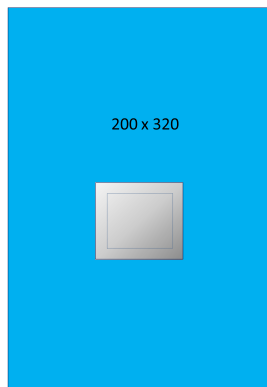

ABDOMINAL DRAPE

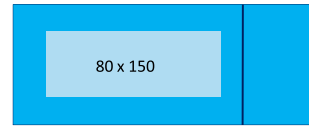

MAYO COVER

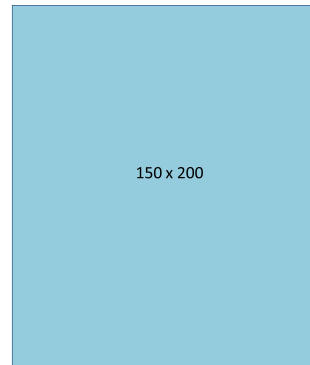

BACK TABLE COVER

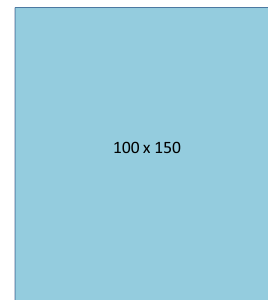

BACK TABLE COVER



STANDARD SURGICAL GOWN



TOWEL

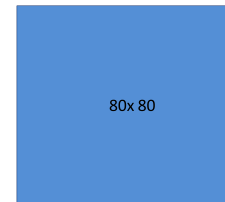

PACK

REF. MDC-ORTS-0345

		Sizes	Pieces
ABDOMINAL DRAPE SET	ABDOMINAL DRAPE	200 x 320	1
	BACK TABLE COVER	100 x 150	1
	BACK TABLE COVER	150 x 200	1
	MAYO COVER	80 x 150	1
	STANDARD SURGICAL GOWN	L	2
	TOWEL	40 x 40	2
	PACK	80 x 80	1

Note: The set contents are for information purposes. The optional production can be done.

Laparotomy Drape Set

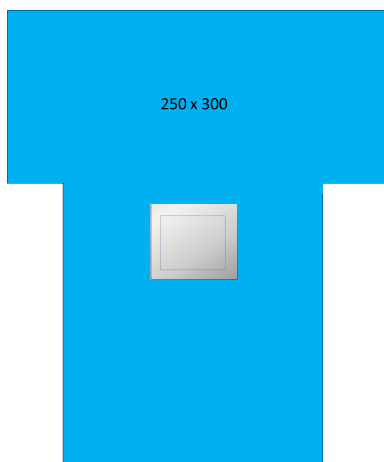

LAPAROTOMY DRAPE

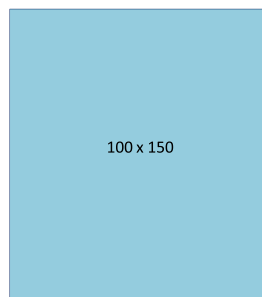

BACK TABLE COVER

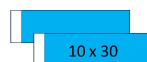

OPTAPE



STANDARD SURGICAL GOWN



TOWEL

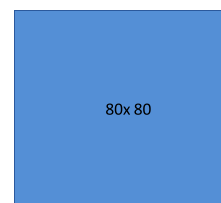

PACK

REF. MDC-ORTS-0881

		Sizes	Pieces
LAPAROTOMY DRAPE SET	LAPAROTOMY DRAPE	250 x 300	1
	BACK TABLE COVER	100 x 150	1
	OPTAPE	10 x 30	2
	STANDARD SURGICAL GOWN	L	2
	TOWEL	40 x 40	2
	PACK	80 x 80	1

Note: The set contents are for information purposes. The optional production can be done.

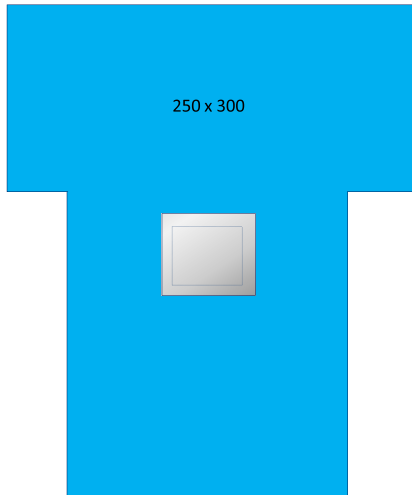

LAPAROSCOPY DRAPE

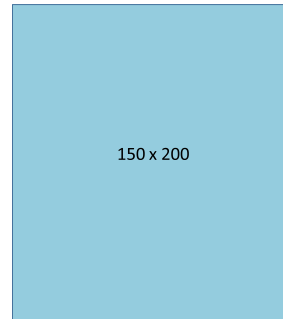

BACK TABLE COVER

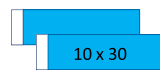

OPTAPE

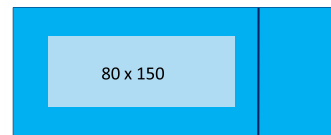

MAYO COVER



STANDARD SURGICAL GOWN

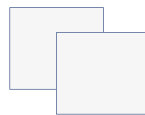

TOWEL

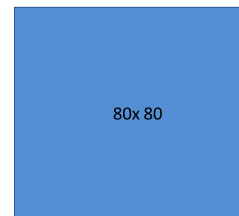

PACK

REF. MDC-ORTS-0001

		Sizes	Pieces
LAPAROSCOPY DRAPE SET	LAPAROSCOPY DRAPE	250 x 300	1
	BACK TABLE COVER	150 x 200	1
	MAYO COVER	80 x 150	1
	OPTAPE	10 x 30	2
	STANDARD SURGICAL GOWN	L	2
	TOWEL	40 x 40	2
	PACK	80 x 80	1

Note: The set contents are for information purposes. The optional production can be done.

Minor Surgery Drape Set

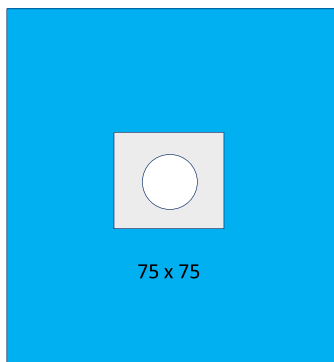

MINOR FENESTRATED DRAPE

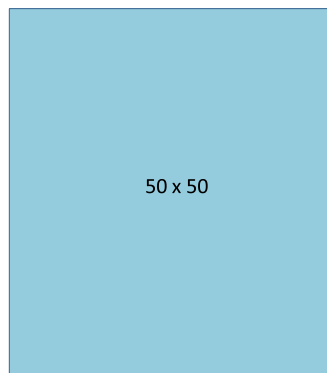

BACK TABLE COVER



STANDARD SURGICAL GOWN

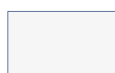

TOWEL

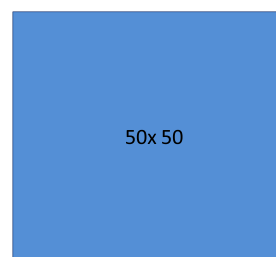

PACK

REF. MDC-ORTS-0193

Sizes

Pieces

MINOR SURGERY DRAPE SET	MINOR FENESTRATED DRAPE	75 x 75	1
	BACK TABLE COVER	50 x 50	1
	STANDARD SURGICAL GOWN	L	1
	TOWEL	20 x 40	1
	PACK	50 x 50	1

Note: The set contents are for information purposes. The optional production can be done.



Orthopedic Surgery



Arthroscopy Drape Set

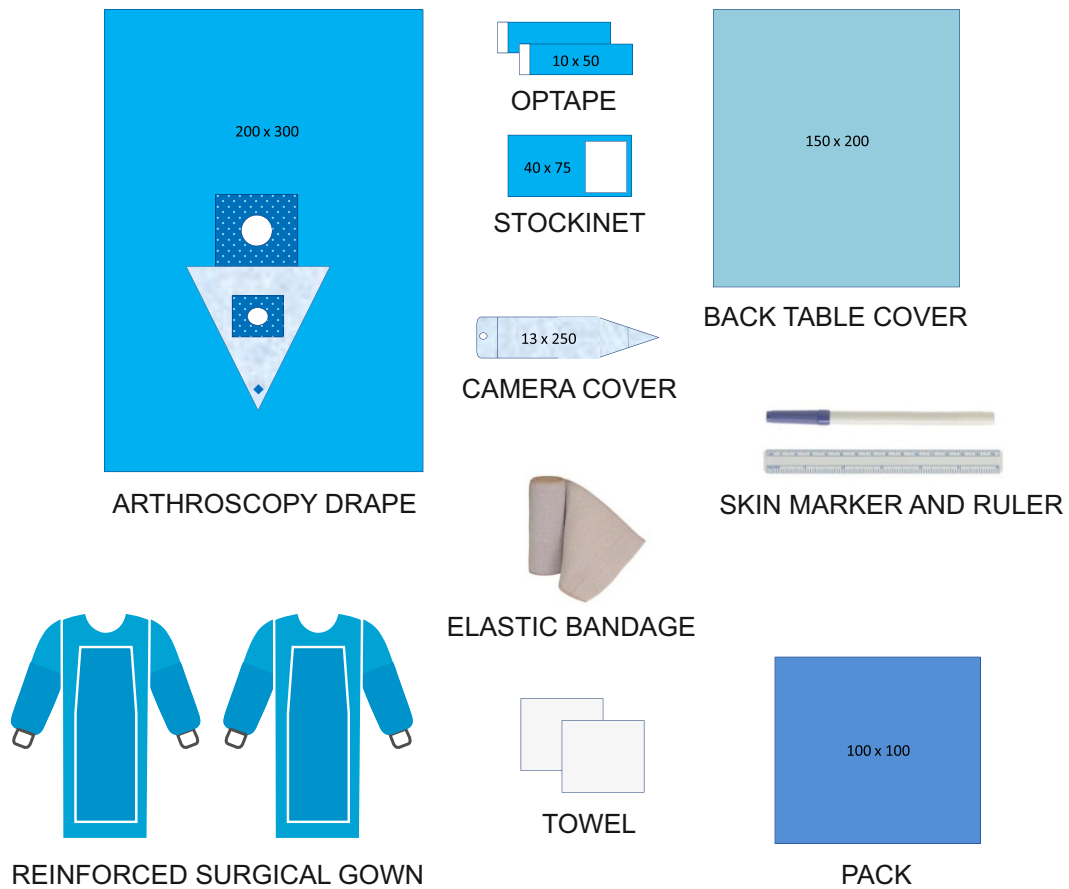

REF. MDC-ORTS-0133

ARTHROSCOPY DRAPE SET

	Sizes	Pieces
ARTHROSCOPY DRAPE	200 x 300	1
BACK TABLE COVER	150 x 200	1
STOCKINET	40 x 75	1
CAMERA COVER	13 x 250	1
SKIN MARKER AND RULER		1
ELASTIC BANDAGE	10 x 200	1
OPTAPE	10 x 50	2
REINFORCED SURGICAL GOWN	L	2
TOWEL	40 x 40	2
PACK	100 x 100	1

Note: The set contents are for information purposes. The optional production can be done.

Extremity Drape Set

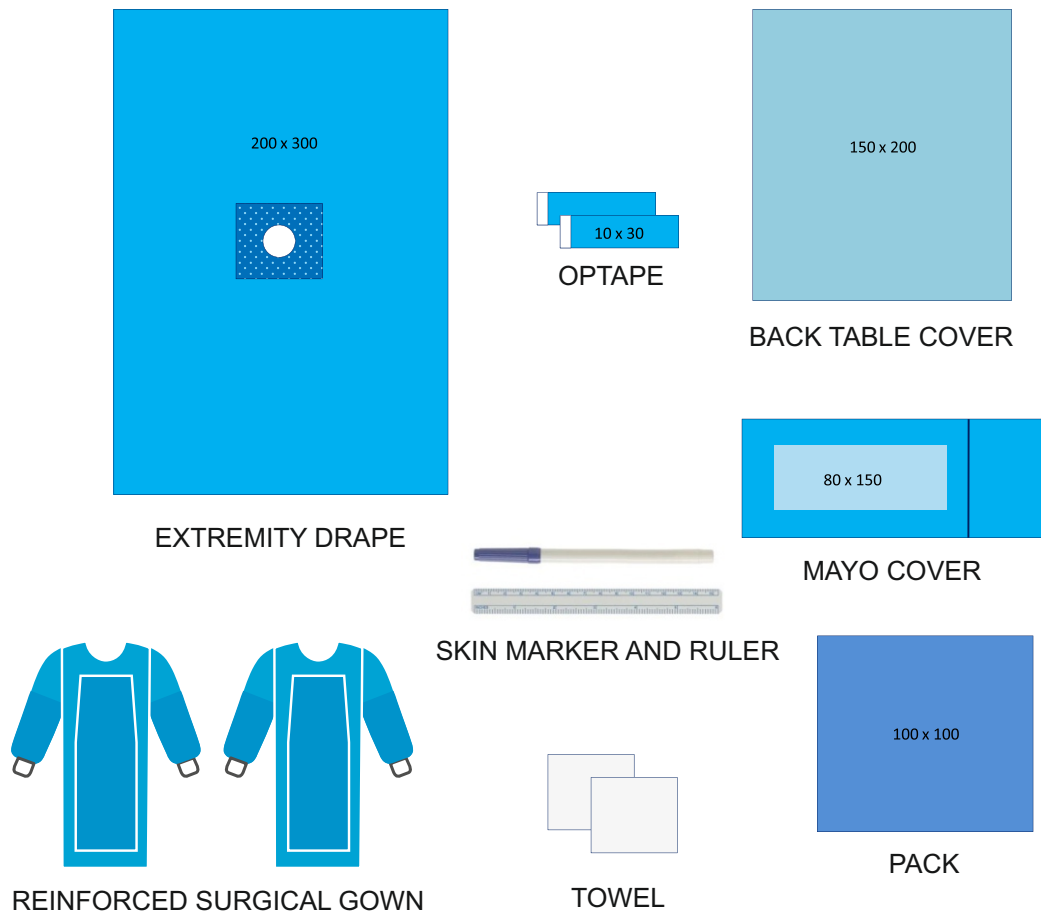

REF. MDC-ORTS-0097

	Sizes	Pieces	
EXTREMITY DRAPE SET	EXTREMITY DRAPE	200 x 300	1
	BACK TABLE COVER	150 x 200	1
	MAYO COVER	80 x 150	1
	OPTAPE	10 x 30	2
	SKIN MARKER AND RULER		1
	REINFORCED SURGICAL GOWN	L	2
	TOWEL	40 x 40	2
	PACK	100 x 100	1

Note: The set contents are for information purposes. The optional production can be done.

Hand Surgery Drape Set

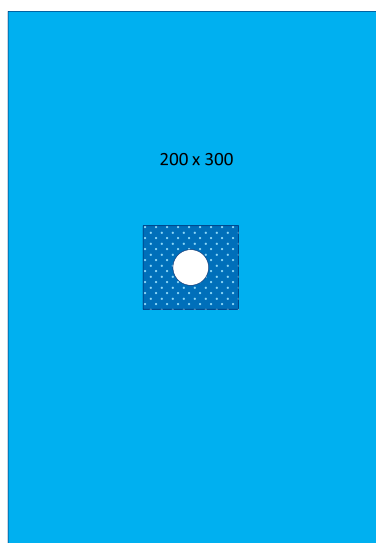

EXTREMITY DRAPE

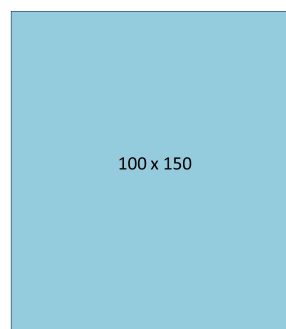

BACK TABLE COVER

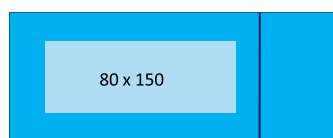

MAYO COVER

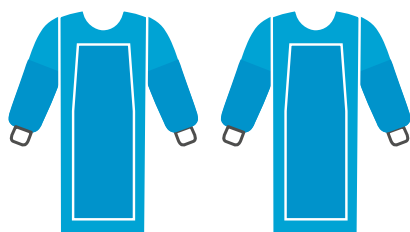

REINFORCED SURGICAL GOWN

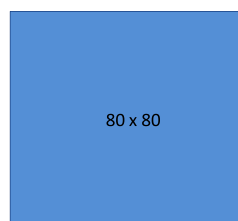

PACK

REF. MDC-ORTS-0177

		Sizes	Pieces
HAND SURGERY DRAPE SET	EXTREMITY DRAPE	200 x 300	1
	BACK TABLE COVER	100 x 150	1
	MAYO COVER	80 x 150	1
	REINFORCED SURGICAL GOWN	L	2
	PACK	80 x 80	1

Note: The set contents are for information purposes. The optional production can be done.

Knee Drape Set

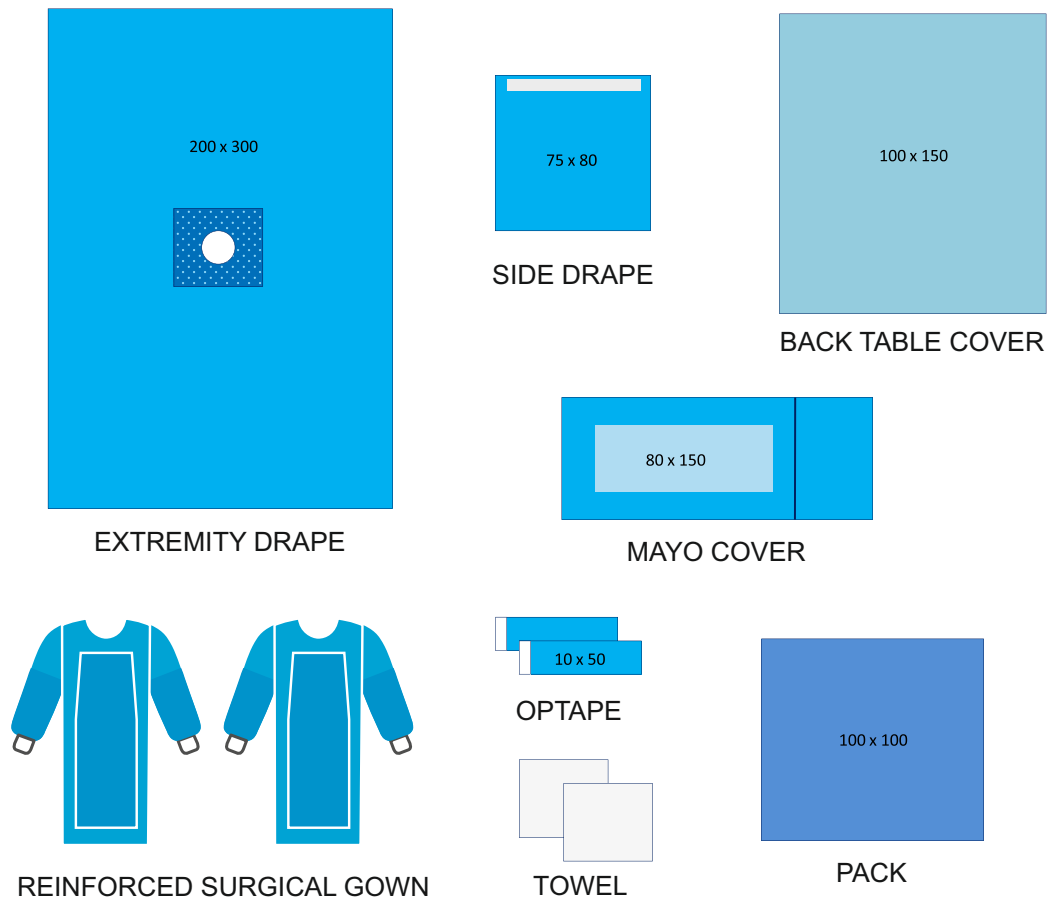

REF. MDC-ORTS-0105

		Sizes	Pieces
KNEE DRAPE SET	EXTREMITY DRAPE	200 x 300	1
	SIDE DRAPE	75 x 80	1
	BACK TABLE COVER	100 x 150	1
	MAYO COVER	80 x 150	1
	OPTAPE	10 x 50	2
	REINFORCED SURGICAL GOWN	L	2
	TOWEL	40 x 40	2
	PACK	100 x 100	1

Note: The set contents are for information purposes. The optional production can be done.

Shoulder Drape Set

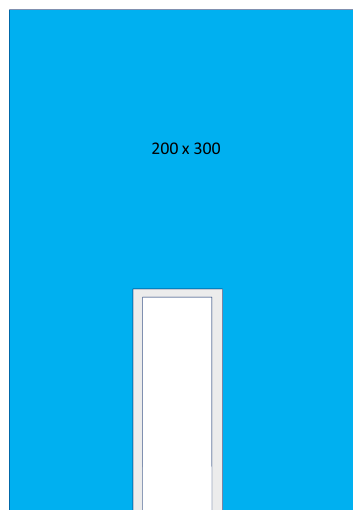

SHOULDER DRAPE

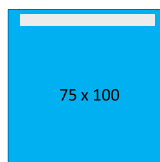

SIDE DRAPE

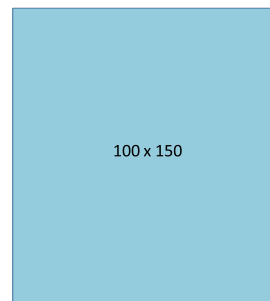

BACK TABLE COVER

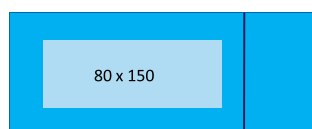

MAYO COVER



STANDARD SURGICAL GOWN

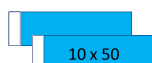

OPTAPE

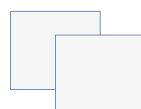

TOWEL

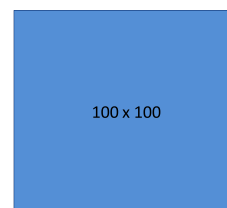

PACK

REF. MDC-ORTS-0882

	Sizes	Pieces	
SHOULDER DRAPE SET	SHOULDER DRAPE	200 x 300	1
	SIDE DRAPE	75 x 100	1
	BACK TABLE COVER	100 x 150	1
	MAYO COVER	80 x 150	1
	OPTAPE	10 x 50	2
	STANDARD SURGICAL GOWN	L	2
	TOWEL	40 x 40	2
	PACK	100 x 100	1

Note: The set contents are for information purposes. The optional production can be done.



REF. MDC-ORTS-0121

		Sizes	Pieces
HIP DRAPE SET	HIP U DRAPE	200 x 250	1
	SIDE ANESTHESIA DRAPE	200 x 300	1
	SIDE LEG DRAPE	150 x 180	1
	BACK TABLE COVER	100 x 150	1
	MAYO COVER	80 x 150	1
	REINFORCED SURGICAL GOWN	L	2
	TOWEL	40 x 40	2
	PACK	100 x 100	1

Note: The set contents are for information purposes. The optional production can be done.

Vertebra Drape Set



REF. MDC-ORTS-0137

	Sizes	Pieces	
VERTEBRA DRAPE SET	ANESTHESIA DRAPE	150 x 200	1
	LEG DRAPE	150 x 180	1
	BACK TABLE COVER	150 x 200	1
	MAYO COVER	80 x 150	1
	SIDE DRAPE	100 x 120	2
	SIDE DRAPE	75 x 100	2
	OPTAPE	10 x 30	2
	SKIN MARKER AND RULER		1
	UNIVERSAL BAG	50 x 60	2
	STANDARD SURGICAL GOWN	L	2
	TOWEL	40 x 40	2
	PACK	100 x 100	1

Note: The set contents are for information purposes. The optional production can be done.



Cardiologic Surgery



Angiography Drape Set

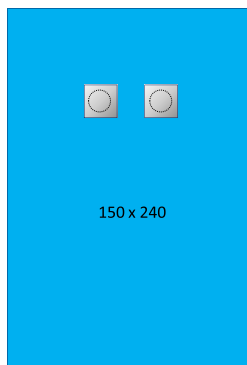

ANGIOGRAPHY DRAPE

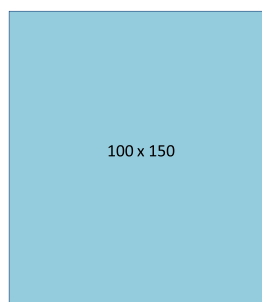

BACK TABLE COVER



SPONGE



FLUOROSCOPY COVER

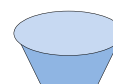

SOLUTION CONTAINER



STANDARD SURGICAL GOWN

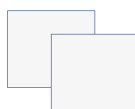

TOWEL

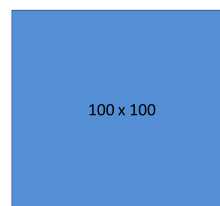

PACK

REF. MDC-ORTS-0053

ANGIOGRAPHY DRAPE SET

	Sizes	Pieces
ANGIOGRAPHY DRAPE	150 x 240	1
BACK TABLE COVER	100 x 150	1
SPONGE	7,5 x 7,5	10
SOLUTION CONTAINER	250 CC	1
FLUOROSCOPY COVER	85 x 85	1
STANDARD SURGICAL GOWN	L	2
TOWEL	40 x 40	2
PACK	100 x 100	1

Note: The set contents are for information purposes. The optional production can be done.

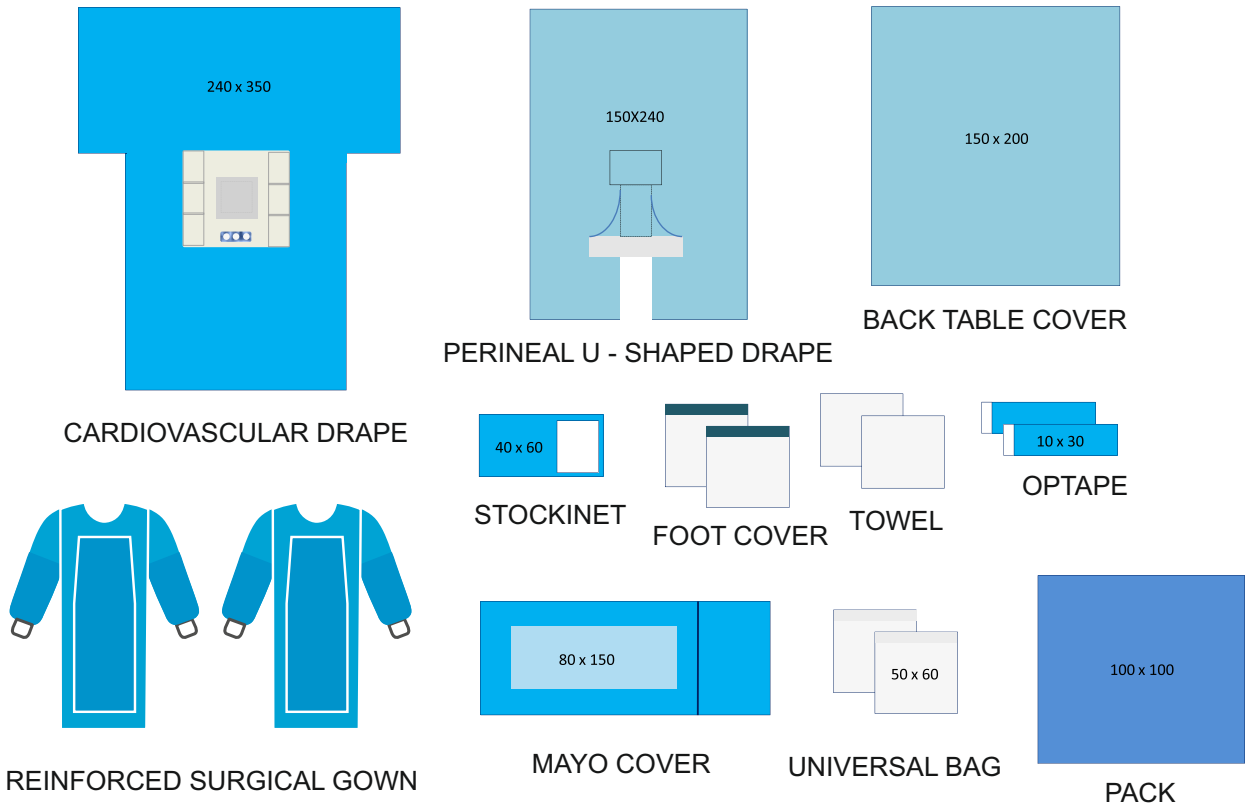

REF: MDC-ORTS-0085

		Sizes	Pieces
BY - PASS DRAPE SET	CARDIOVASCULAR DRAPE	240 x 350	1
	PERINEAL U - SHAPED DRAPE	150 x 240	1
	BACK TABLE COVER	150 x 200	1
	MAYO COVER	80 x 150	1
	STOCKINET	40 x 60	2
	FOOT COVER	STANDARD	2
	OPTAPE	10 x 30	2
	UNIVERSAL BAG	30 x 35	2
	REINFORCED SURGICAL GOWN	L	2
	TOWEL	40 x 40	2
	PACK	100 x 100	1

Note: The set contents are for information purposes. The optional production can be done.

Cardiac Valve Replacement Drape Set

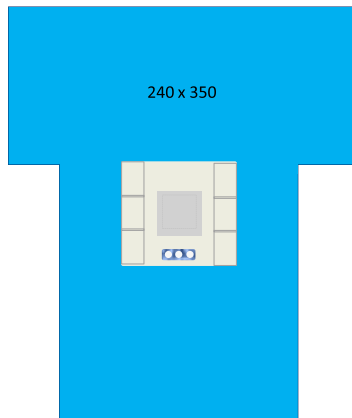

CARDIOVASCULAR DRAPE

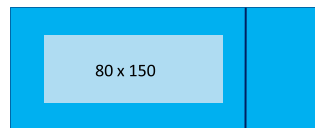

MAYO COVER

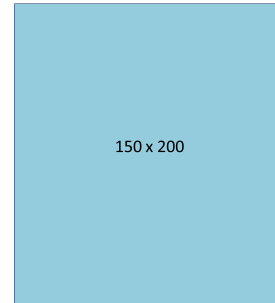

BACK TABLE COVER

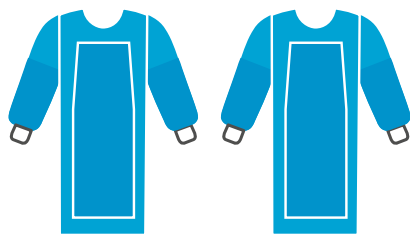

REINFORCED SURGICAL GOWN



TOWEL

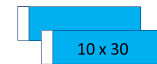

OPTAPE

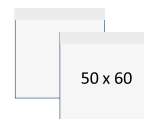

UNIVERSAL BAG

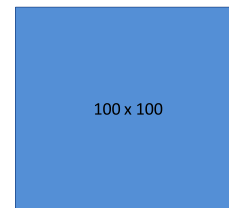

PACK

REF. MDC-ORTS-0069

	Sizes	Pieces
CARDIOVASCULAR DRAPE	240 x 350	1
BACK TABLE COVER	150 x 200	1
MAYO COVER	80 x 150	1
OPTAPE	10 x 30	2
UNIVERSAL BAG	30 x 35	2
REINFORCED SURGICAL GOWN	L	2
TOWEL	40 x 40	2
PACK	100 x 100	1

Note: The set contents are for information purposes. The optional production can be done.

Cardiovascular Drape Set

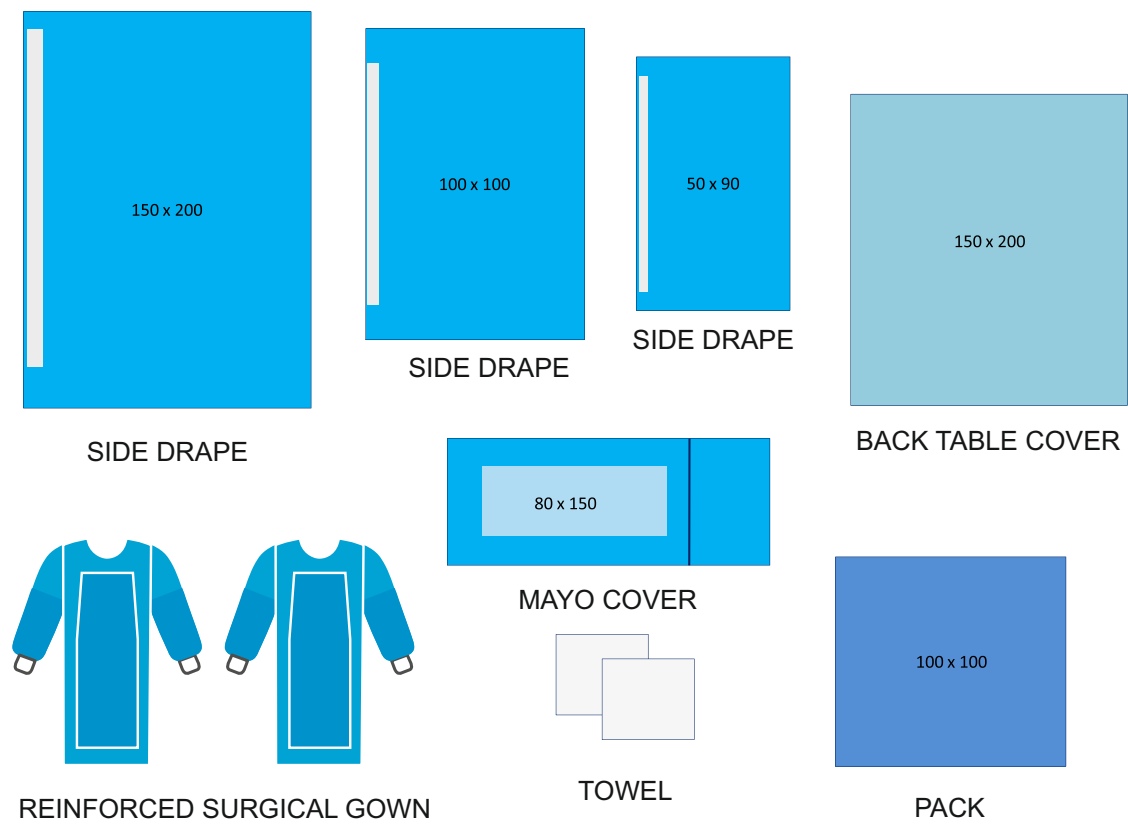

REF. MDC-ORTS-0041

	Sizes	Pieces	
CARDIOVASCULAR DRAPE SET	SIDE DRAPE	50 x 90	1
	SIDE DRAPE	100 x 100	1
	SIDE DRAPE	150 x 200	1
	BACK TABLE COVER	150 x 200	1
	MAYO COVER	80 x 150	1
	REINFORCED SURGICAL GOWN	L	2
	TOWEL	40 x 40	2
	PACK	100 x 100	1

Note: The set contents are for information purposes. The optional production can be done.



Gynecologic Surgery



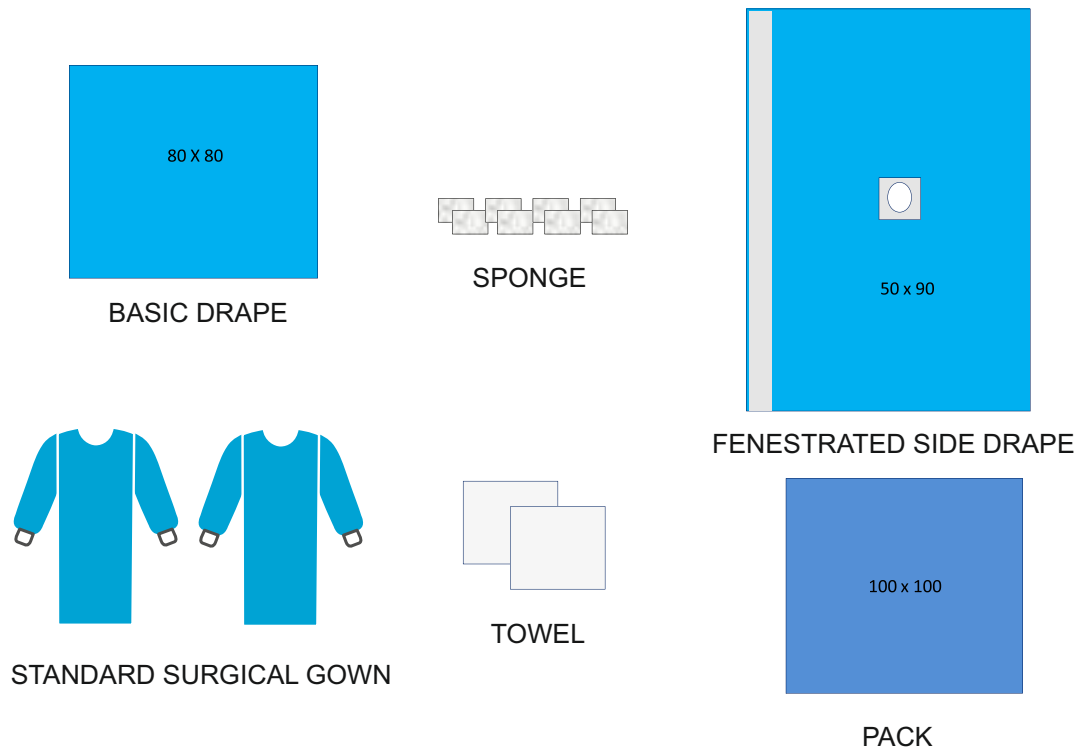

REF. MDC-ORTS-0233

		Sizes	Pieces
E. T. DRAPE SET	FENESTRATED SIDE DRAPE	50 x 90	1
	BASIC DRAPE	80 x 80	1
	SPONGE	7,5 x 7,5	10
	STANDARD SURGICAL GOWN	L	2
	TOWEL	40 x 40	2
	PACK	100 x 100	1

Note: The set contents are for information purposes. The optional production can be done.

I. V. F. Drape Set

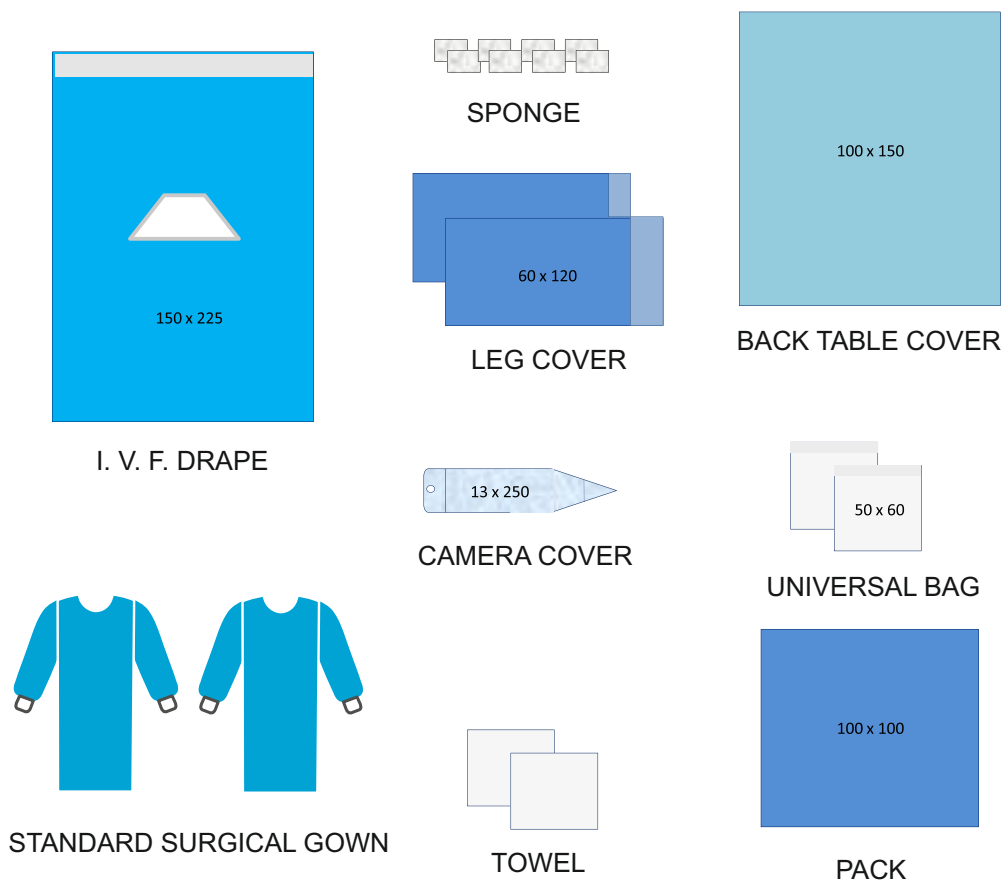

REF. MDC-ORTS-0225

		Sizes	Pieces
I. V. F. DRAPE SET	I. V. F. DRAPE	150 x 225	1
	BACK TABLE COVER	100 x 150	1
	LEG COVER	50 x 120	2
	SPONGE	7,5 x 7,5	10
	CAMERA COVER	13 x 250	1
	UNIVERSAL BAG	50 x 60	1
	STANDARD SURGICAL GOWN	L	2
	TOWEL	40 x 40	2
	PACK	100 x 100	1

Note: The set contents are for information purposes. The optional production can be done.

Maternity Drape Set

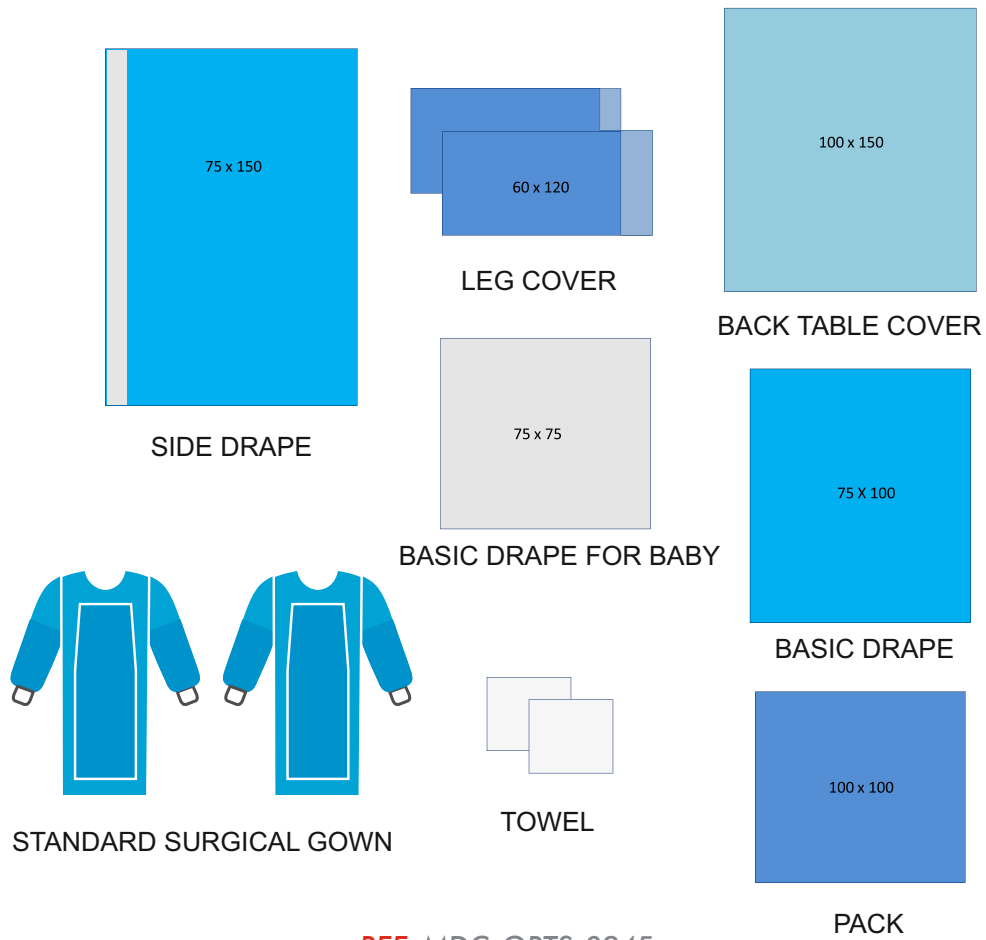

REF. MDC-ORTS-0245

	Sizes	Pieces	
MATERNITY DRAPE SET	SIDE DRAPE	75 x 150	1
	BASIC DRAPE FOR BABY	75 x 75	1
	BACK TABLE COVER	100 x 150	1
	BASIC DRAPE	75 x 100	1
	LEG COVER	60 x 120	2
	STANDARD SURGICAL GOWN	L	2
	TOWEL	40 x 40	2
	PACK	100 x 100	1

Note: The set contents are for information purposes. The optional production can be done.

Cesarean Drape Set

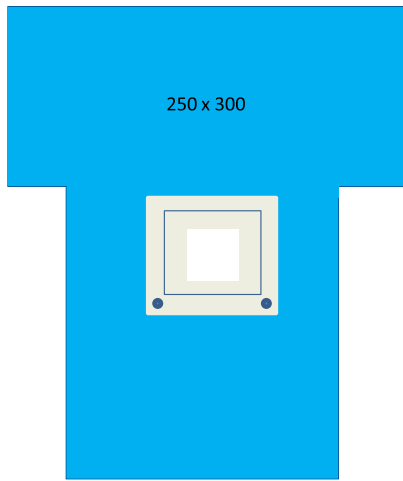

CESAREAN DRAPE

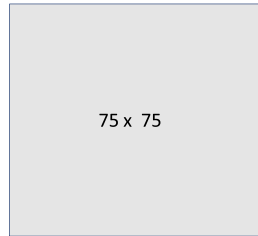

BASIC DRAPE FOR BABY

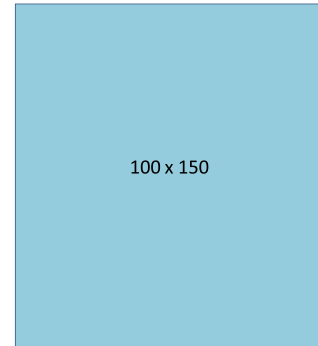

BACK TABLE DRAPE

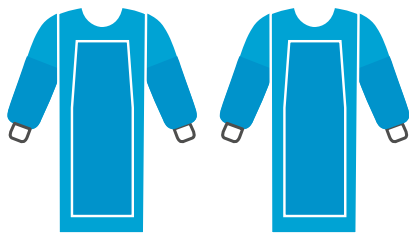

REINFORCED SURGICAL GOWN

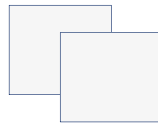

TOWEL

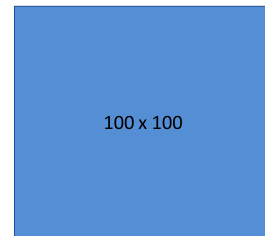

PACK

REF. MDC-ORTS-0241

		Sizes	Pieces
CESAREAN DRAPE SET	CESAREAN DRAPE	250 x 300	1
	BACK TABLE DRAPE	100 x 150	1
	BASIC DRAPE FOR BABY	75 x 75	1
	REINFORCED SURGICAL GOWN	L	2
	TOWEL	40 x 40	2
	PACK	100 x 100	1

Note: The set contents are for information purposes. The optional production can be done.

O. P. U. Drape Set

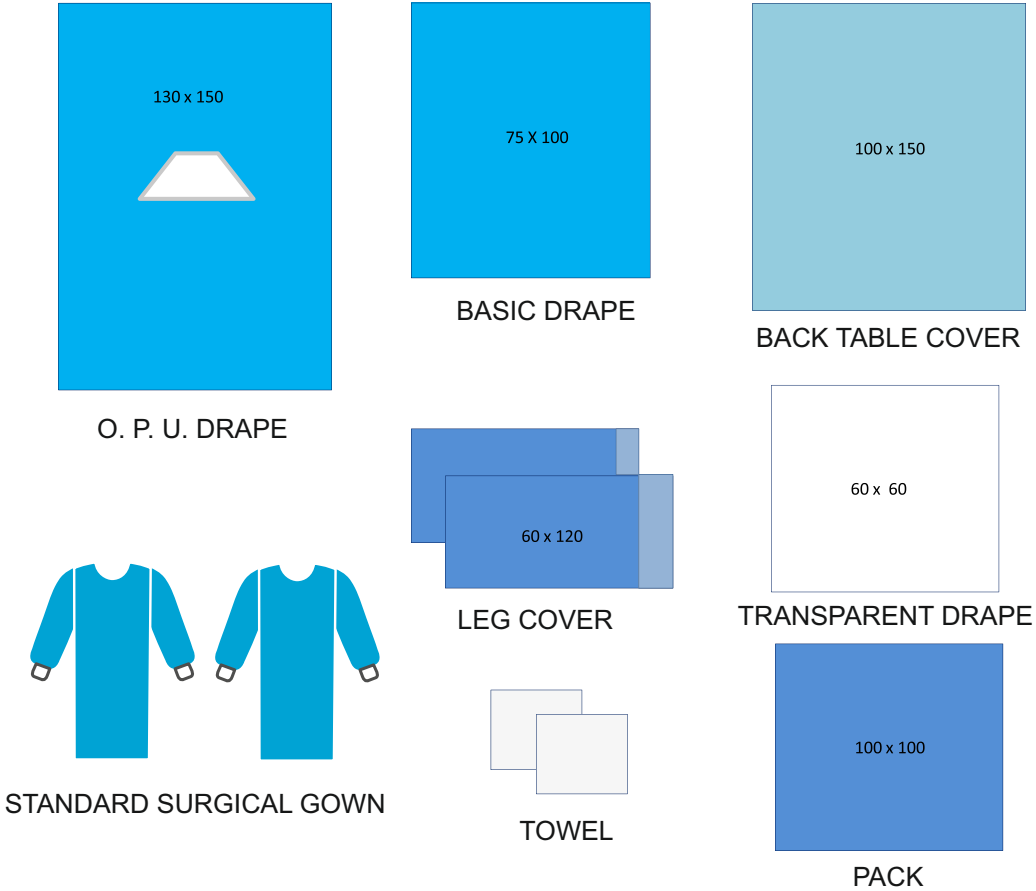

REF. MDC-ORTS-0381

		Sizes	Pieces
O. P. U. DRAPE SET	O. P. U. DRAPE	130 x 150	1
	BASIC DRAPE	75 x 100	1
	TRANSPARENT DRAPE	60 x 60	1
	BACK TABLE COVER	100 x 150	1
	LEG COVER	60 x 115	1
	STANDARD SURGICAL GOWN	L	2
	TOWEL	40 x 40	2
	PACK	100 x 100	1

Note: The set contents are for information purposes. The optional production can be done.



Neurologic Surgery



Craniotomy Drape Set

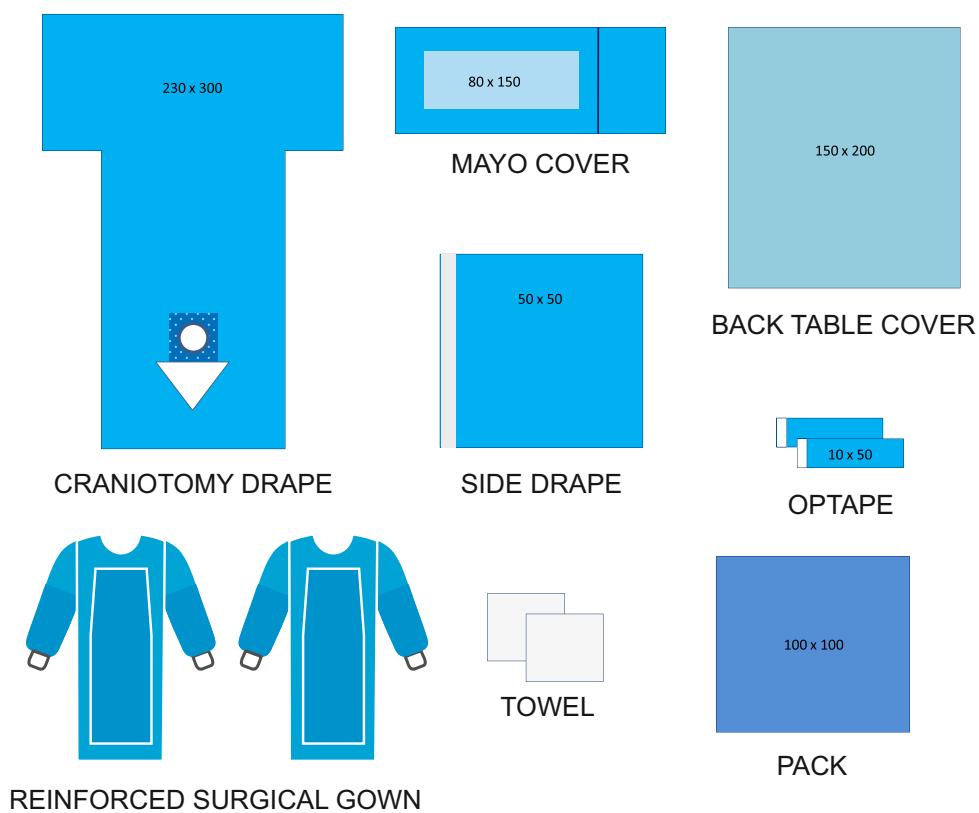

REF. MDC-ORTS-0401

	Sizes	Pieces
CRANIOTOMY DRAPE	230 x 300	1
MAYO COVER	80 x 150	1
OPTAPE	10 x 50	1
SIDE DRAPE	50 x 50	4
BACK TABLE COVER	150 x 200	1
REINFORCED SURGICAL GOWN	L	2
TOWEL	40 x 40	2
PACK	100 x 100	1

Note: The set contents are for information purposes. The optional production can be done.

Shunt Drape Set

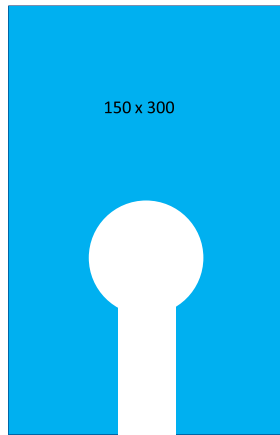

SHUNT DRAPE

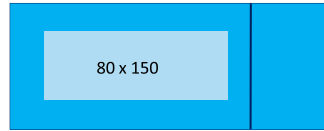

MAYO COVER

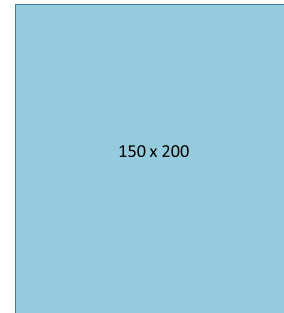

BACK TABLE COVER

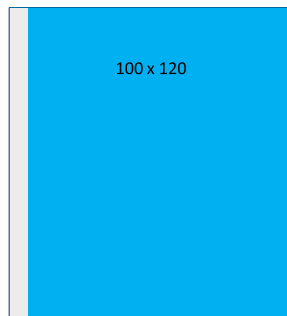

SIDE DRAPE



REINFORCED SURGICAL GOWN

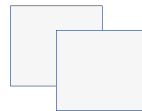

TOWEL

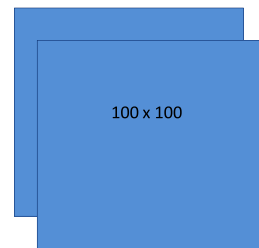

PACK

REF. MDC-ORTS-0013

		Sizes	Pieces
SHUNT DRAPE SET	SHUNT DRAPE	150 x 300	1
	BACK TABLE COVER	150 x 200	1
	MAYO COVER	80 x 160	1
	SIDE DRAPE	100 x 120	2
	REINFORCED SURGICAL GOWN	L	1
	TOWEL	40 x 40	2
	PACK	100 x 100	2

Note: The set contents are for information purposes. The optional production can be done.

Spinal Drape Set

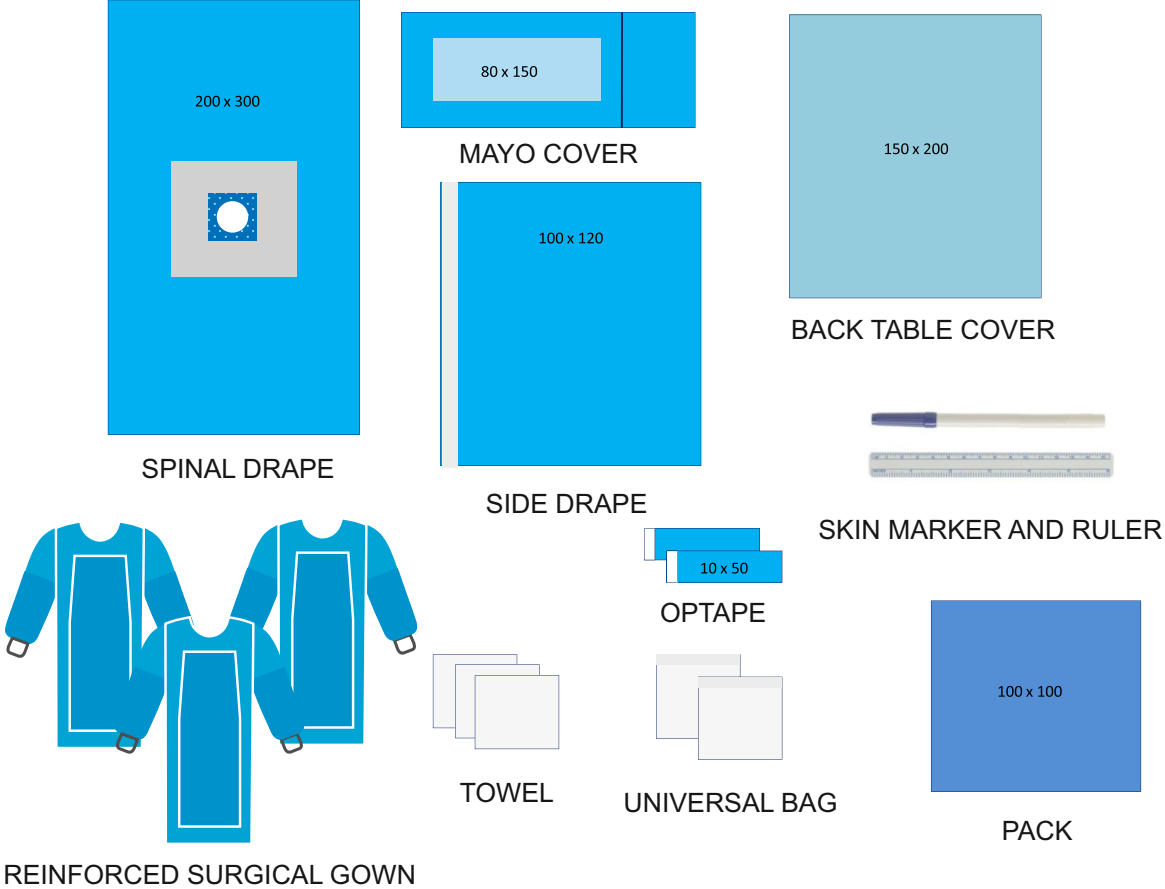

REF. MDC-ORTS-0093

		Sizes	Pieces
SPINAL DRAPE SET	SPINAL DRAPE	200 x 300	1
	BACK TABLE COVER	150 x 200	1
	MAYO COVER	80 x 150	1
	SIDE DRAPE	100 x 120	2
	OPTAPE	10 x 50	2
	SKIN MARKER AND RULER		1
	UNIVERSAL BAG	50 x 60	1
	REINFORCED SURGICAL GOWN	L	3
	TOWEL	40 x 40	3
	PACK	100 x 100	1

Note: The set contents are for information purposes. The optional production can be done.



Ophthalmologic Surgery



Eye Drapes with Single Pouch

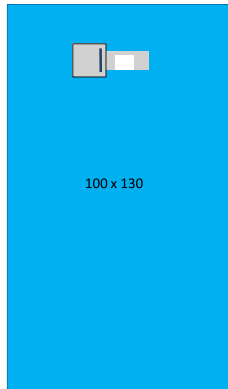

100 x 130

EYE DRAPE

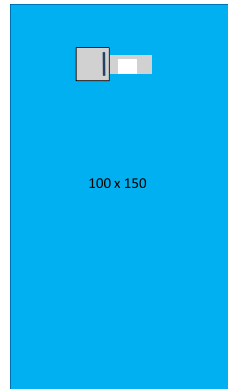

100 x 150

EYE DRAPE

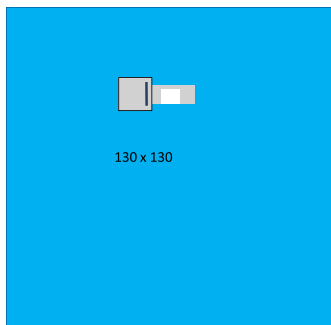

130 x 130

EYE DRAPE

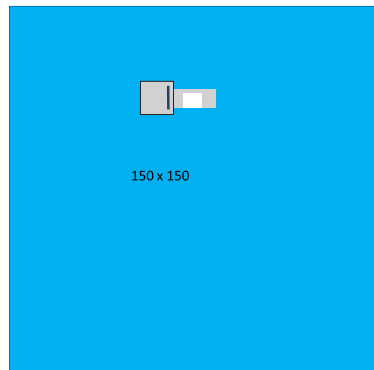

150 x 150

EYE DRAPE

REF. Section of Ophthalmic Drapes

		Sizes	Pieces
EYE DRAPES WITH SINGLE POUCH	EYE DRAPE	100 x 130	1
	EYE DRAPE	100 x 150	1
	EYE DRAPE	130 x 130	1
	EYE DRAPE	150 x 150	1

Note: The set contents are for information purposes. The optional production can be done.

Eye Drapes with Double Pouches

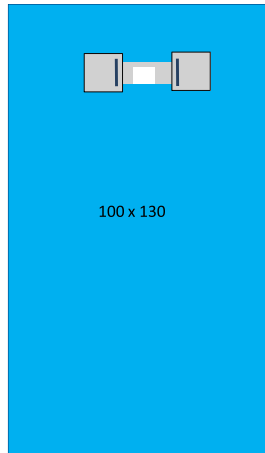

100 x 130

EYE DRAPE

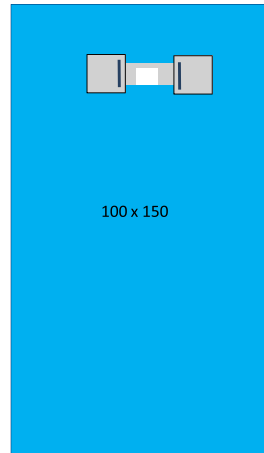

100 x 150

EYE DRAPE

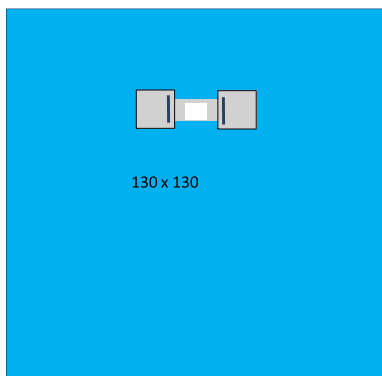

130 x 130

EYE DRAPE

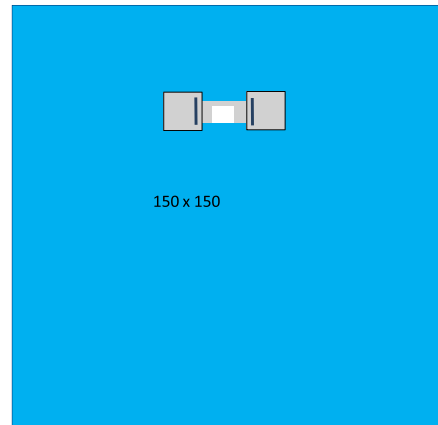

150 x 150

EYE DRAPE

REF. Section of Ophthalmic Drapes

		Sizes	Pieces
EYE DRAPES WITH DOUBLE POUCHES	EYE DRAPE	100 x 130	1
	EYE DRAPE	100 x 150	1
	EYE DRAPE	130 x 130	1
	EYE DRAPE	150 x 150	1

Note: The set contents are for information purposes. The optional production can be done.

Eye Drape Set

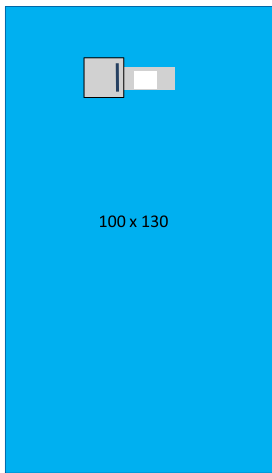

100 x 130

EYE DRAPE WITH SINGLE POUCH

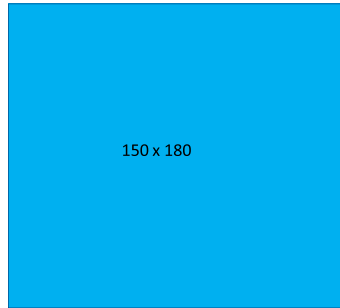

150 x 180

BASIC DRAPE

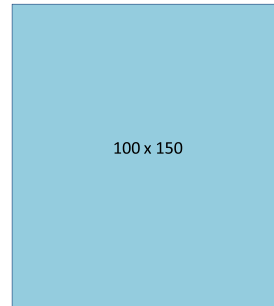

100 x 150

BACK TABLE COVER



STANDARD SURGICAL GOWN



TOWEL

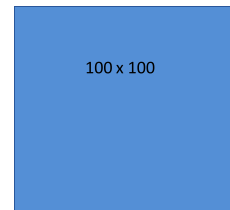

100 x 100

PACK

REF. MDC-ORTS-0265

		Sizes	Pieces
EYE DRAPE SET	EYE DRAPE WITH SINGLE POUCH	100 x 130	1
	BASIC DRAPE	150 x 180	1
	BACK TABLE COVER	100 x 150	1
	STANDARD SURGICAL GOWN	L	2
	TOWEL	40 x 40	2
	PACK	100 x 100	1

Note: The set contents are for information purposes. The optional production can be done.

Laser Eye Drape Set

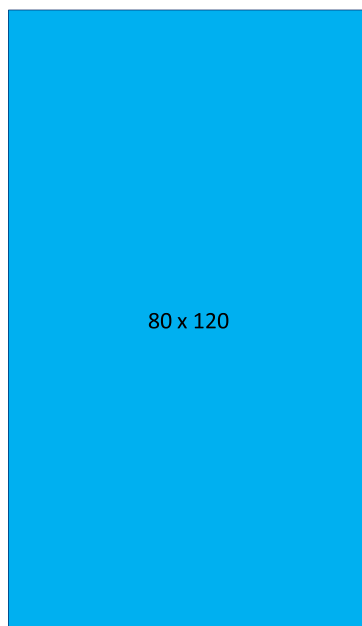

PE-NAYLON

REF. MDC-ORTS-0883

		Sizes	Pieces
LASER EYE DRAPE SET	PE - NAYLON	100 x 130	1

Note: The set contents are for information purposes. The optional production can be done.



Oncological Surgery



Chemotherapy Drape Set

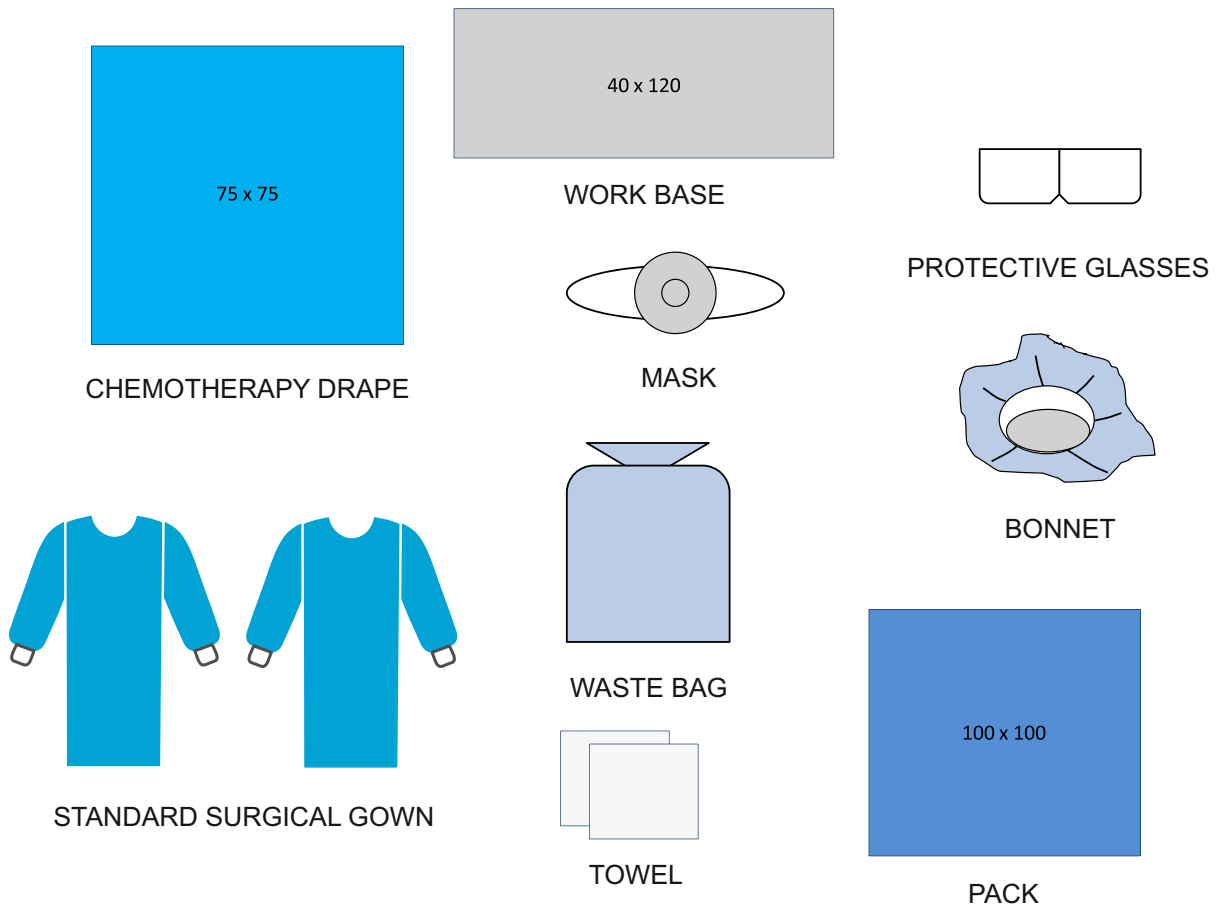

REF. MDC-ORTS-0353

		Sizes	Pieces
CHEMOTHERAPY DRAPE SET	CHEMOTHERAPY DRAPE	75 x 75	1
	WORK BASE	40 x 120	1
	MASK		1
	PROTECTIVE GLASSES	40 x 40	1
	BONNET		1
	CHEMOTHERAPY GLOVES	PAIR	1
	WASTE BAG		1
	STANDARD SURGICAL GOWN	L	2
	TOWEL	40 x 40	2
	PACK	100 x 100	1

Note: The set contents are for information purposes. The optional production can be done.



Urologic Surgery



Percutaneous Drape Set

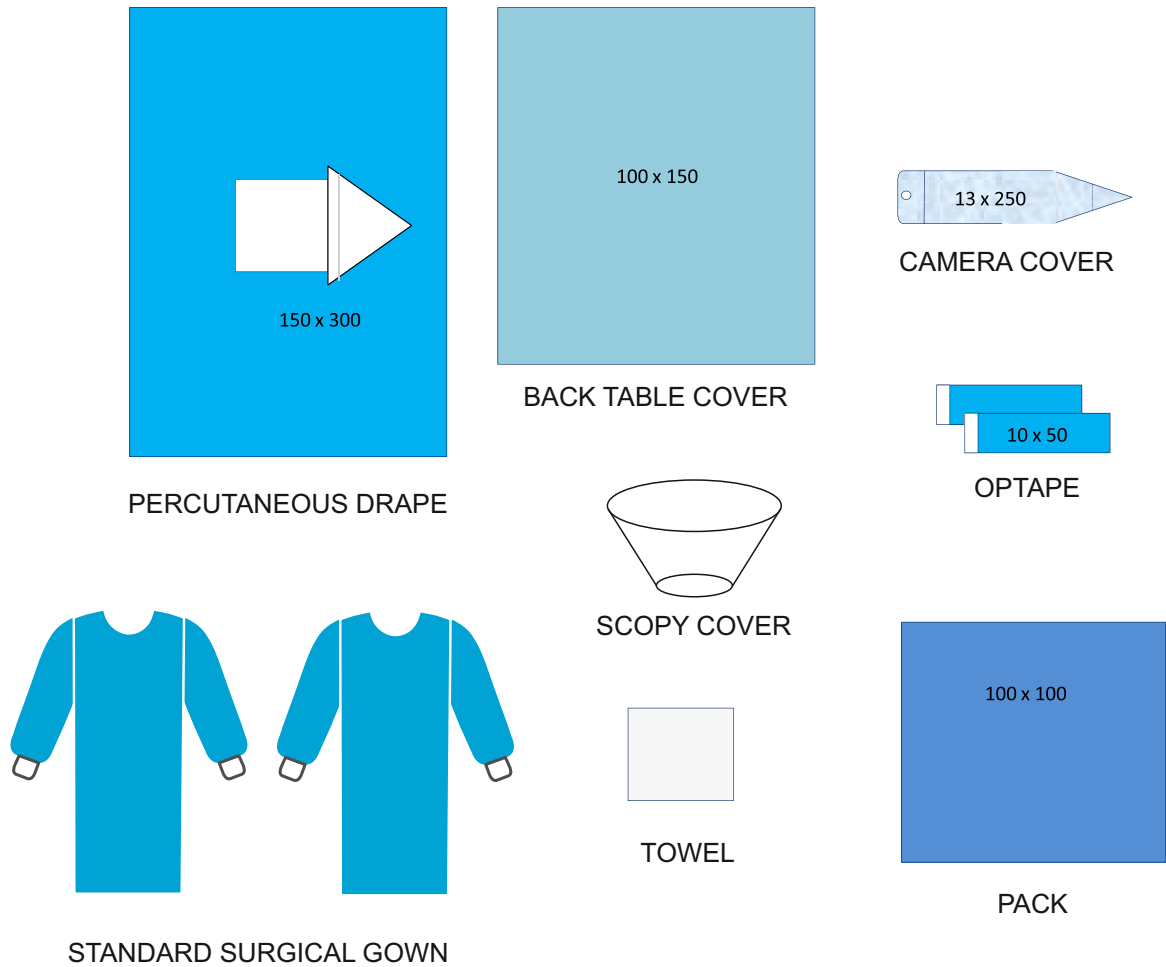

REF. MDC-ORTS-0365

		Sizes	Pieces
PERCUTANEOUS DRAPE SET	PERCUTANEOUS DRAPE	150 x 300	1
	BACK TABLE COVER	100 x 150	1
	OPTAPE	10 x 50	1
	SCOPY COVER	50 x 80	1
	CAMERA COVER	13 x 250	1
	STANDARD SURGICAL GOWN	L	2
	TOWEL	40 x 40	1
	PACK	100 x 100	1

Note: The set contents are for information purposes. The optional production can be done.

T. U. R. Drape Set

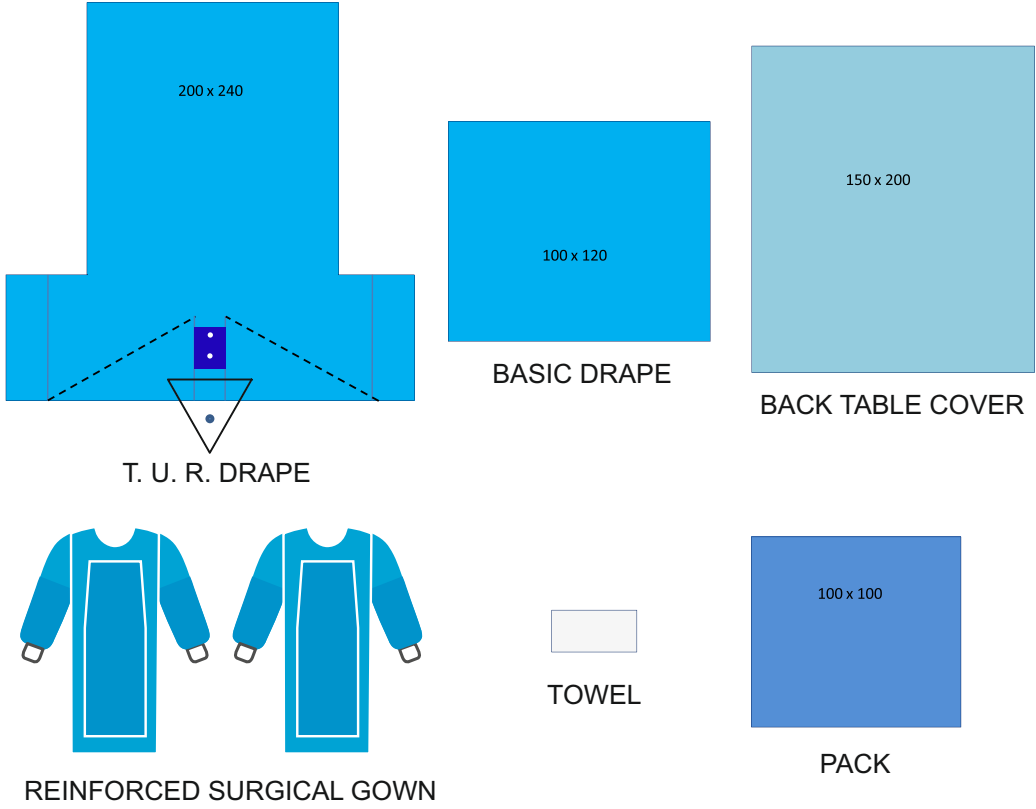

REF. MDC-ORTS-0253

		Sizes	Pieces
T. U. R. DRAPE SET	T. U. R. DRAPE	200 x 240	1
	BASIC DRAPE	100 x 120	1
	BACK TABLE COVER	150 x 200	1
	REINFORCED SURGICAL GOWN	L	2
	TOWEL	40 x 25	1
	PACK	100 x 100	1

Note: The set contents are for information purposes. The optional production can be done.

Cystoscopy Drape Set

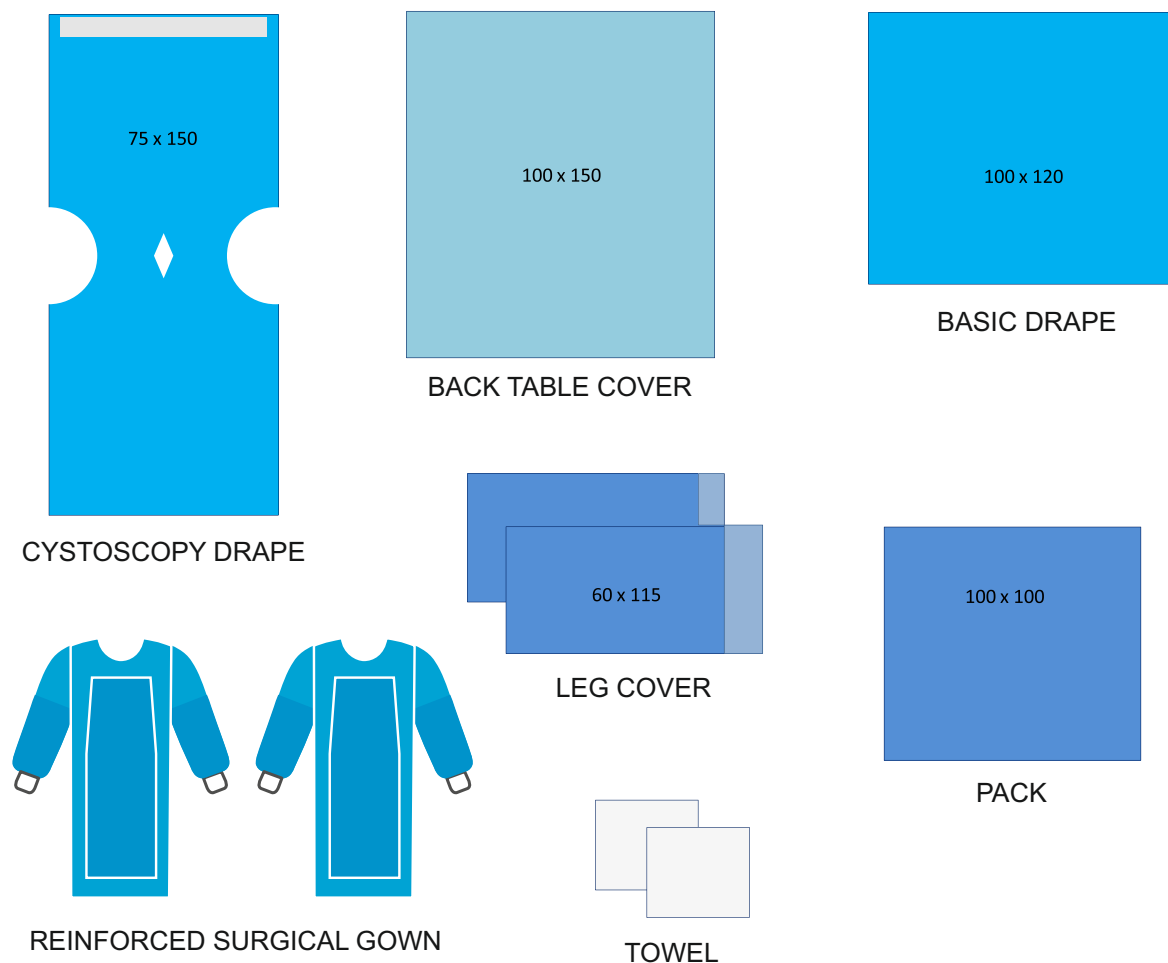

REF. MDC-ORTS-0361

		Sizes	Pieces
CYSTOSCOPY DRAPE SET	CYSTOSCOPY DRAPE	75 x 150	1
	BASIC DRAPE	100 x 120	1
	BACK TABLE COVER	100 x 150	1
	LEG COVER	60 x 115	2
	REINFORCED SURGICAL GOWN	L	2
	TOWEL	40 x 40	1
	PACK	100 x 100	1

Note: The set contents are for information purposes. The optional production can be done.



REF. MDC-ORTS-0369

		Sizes	Pieces
BIOPSY DRAPE SET	ANESTHESIA DRAPE	150 x 300	1
	BACK TABLE COVER	100 x 150	1
	STANDARD SURGICAL GOWN	L	2
	TOWEL	40 x 40	2
	PACK	75 x 75	1

Note: The set contents are for information purposes. The optional production can be done.



ENT Surgery



E. N. T. Drape Set

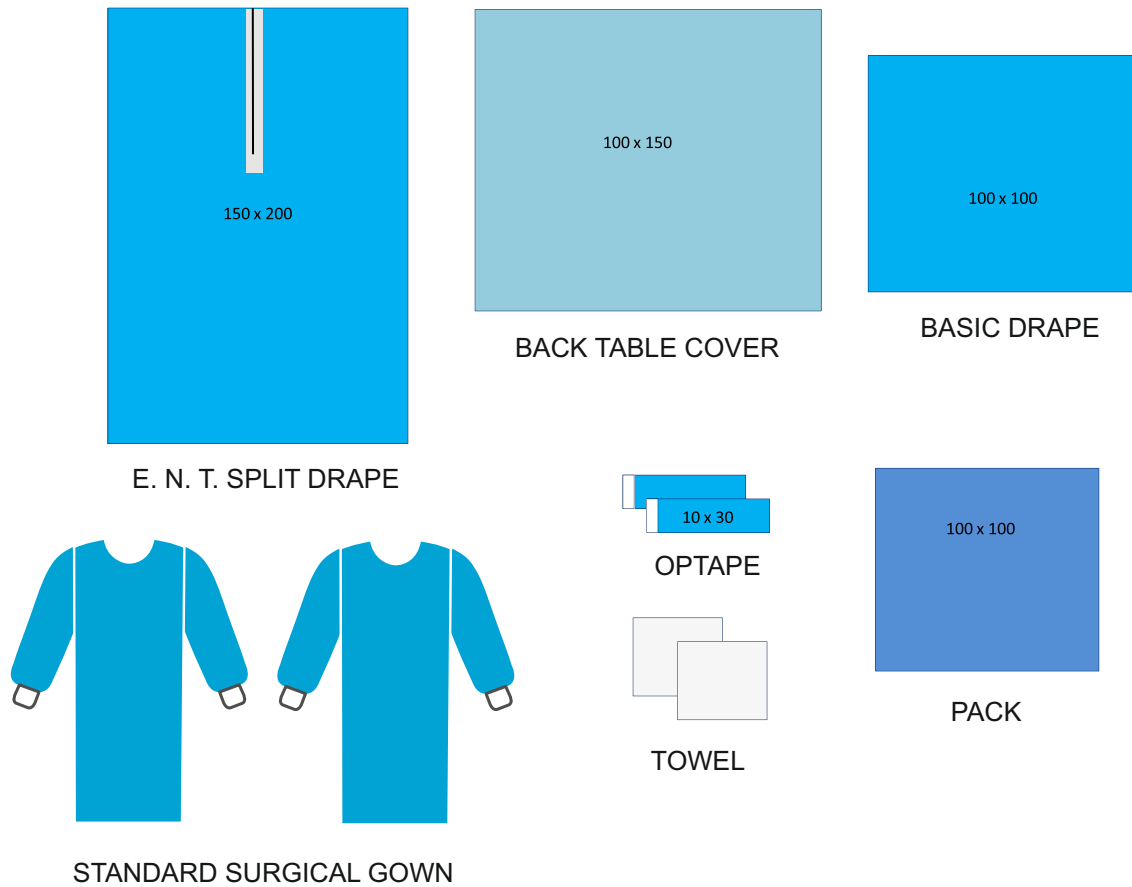

REF. MDC-ORTS-0429

		Sizes	Pieces
E. N. T. DRAPE SET	E. N. T. SPLIT DRAPE	150 x 200	1
	BASIC DRAPE	100 x 100	1
	BACK TABLE COVER	100 x 150	1
	OPTAPE	10 x 30	2
	STANDARD SURGICAL GOWN	L	2
	TOWEL	40 x 40	2
	PACK	100 x 100	1

Note: The set contents are for information purposes. The optional production can be done.

Thyroid Drape Set

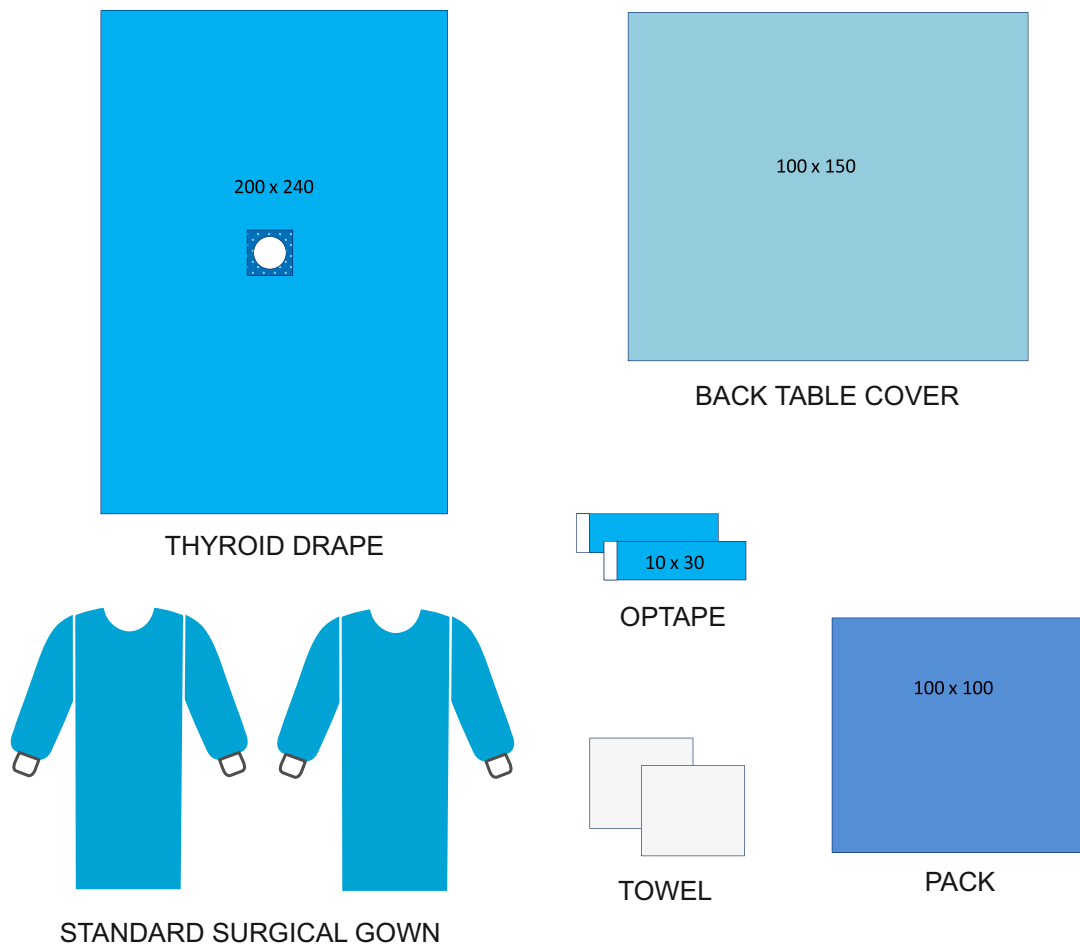

REF. MDC-ORTS-0884

		Sizes	Pieces
THYROID DRAPE SET	THYROID DRAPE	200 x 240	1
	BACK TABLE COVER	100 x 150	1
	OPTAPE	10 x 30	2
	STANDARD SURGICAL GOWN	L	2
	TOWEL	40 x 40	2
	PACK	100 x 100	1

Note: The set contents are for information purposes. The optional production can be done.



Aesthetic Surgery



Rhinoplasty Drape Set

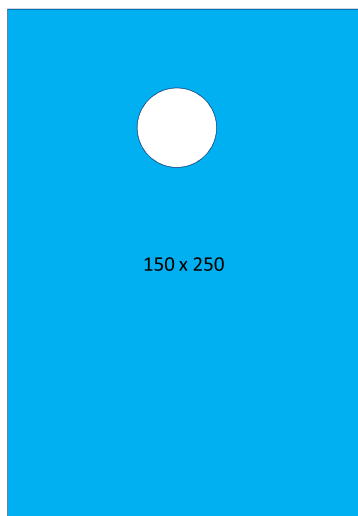

RHINOPLASTY DRAPE

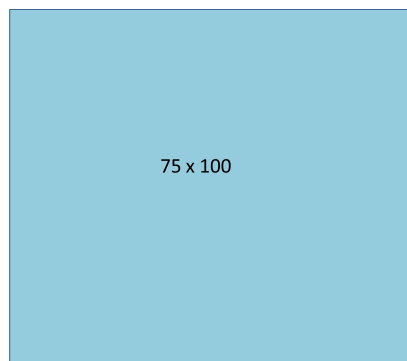

BACK TABLE COVER

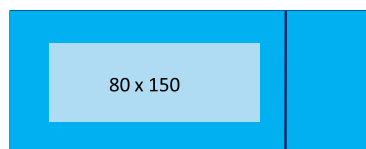

MAYO COVER



STANDARD SURGICAL GOWN



TOWEL

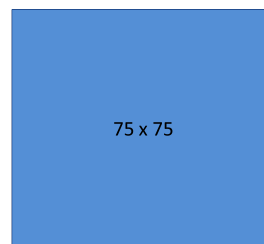

PACK

REF. MDC-ORTS-0885

		Sizes	Pieces
RHINOPLASTY DRAPE SET	RHINOPLASTY DRAPE	150 x 250	1
	MAYO COVER	80 x 150	1
	BACK TABLE COVER	75 x 100	2
	STANDARD SURGICAL GOWN	L	1
	TOWEL	40 x 40	1
	PACK	75 x 75	1

Note: The set contents are for information purposes. The optional production can be done.

Liposculpture Drape Set

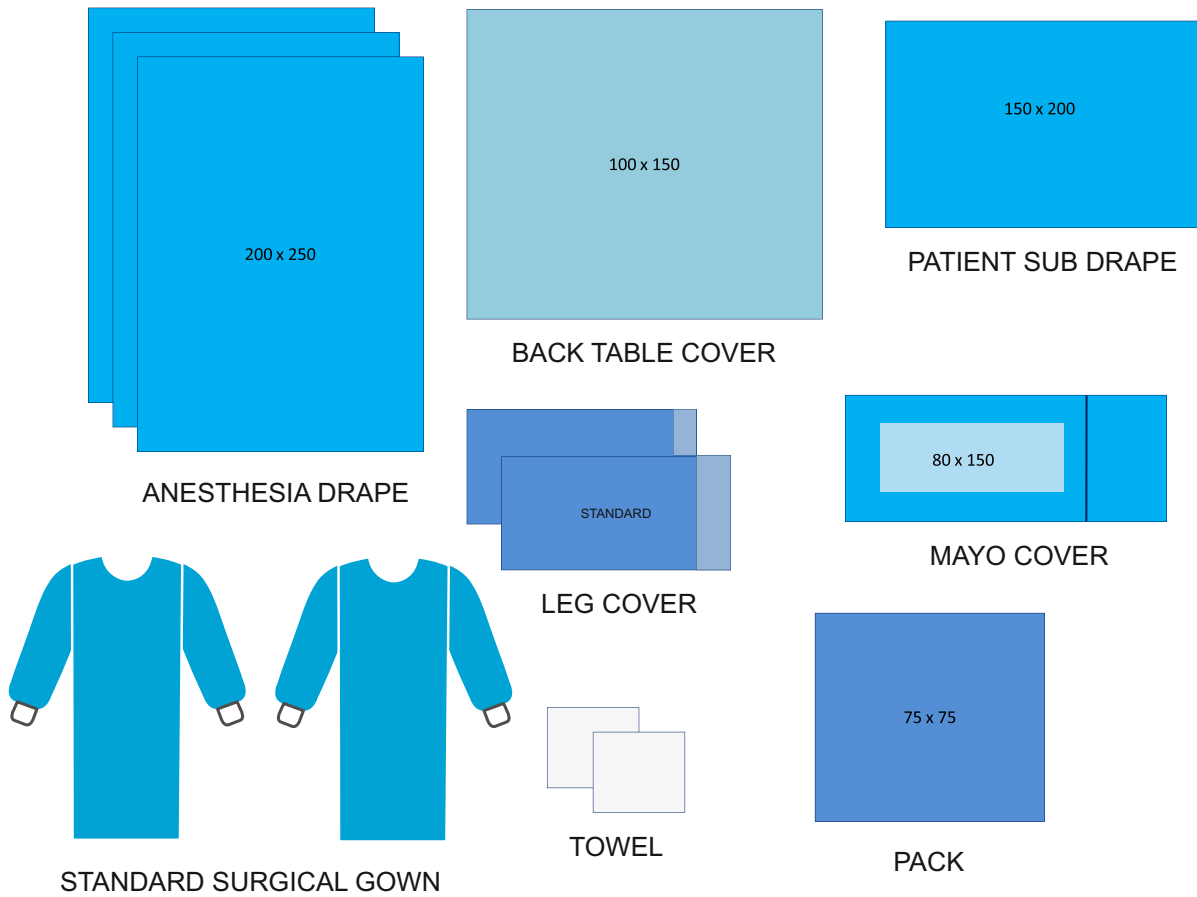

REF: MDC-ORTS-0886

		Sizes	Pieces
LIPOSCULPTURE DRAPE SET	ANESTHESIA DRAPE	200 x 250	3
	PATIENT SUB DRAPE	150 x 200	1
	MAYO COVER	80 x 150	1
	BACK TABLE COVER	100 x 150	1
	LEG COVER	STANDARD	2
	STANDARD SURGICAL GOWN	L	2
	TOWEL	40 x 40	2
	PACK	75 x 75	1

Note: The set contents are for information purposes. The optional production can be done.



Dental Surgery



Dental Drape Set

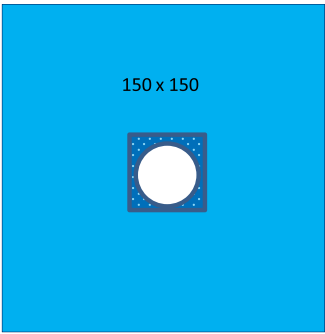

DENTAL DRAPE

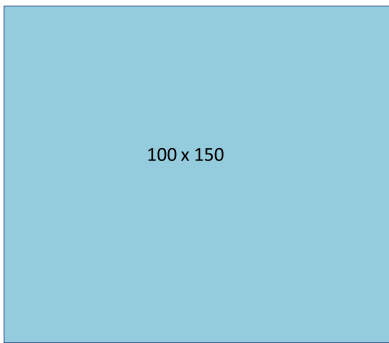

BACK TABLE COVER

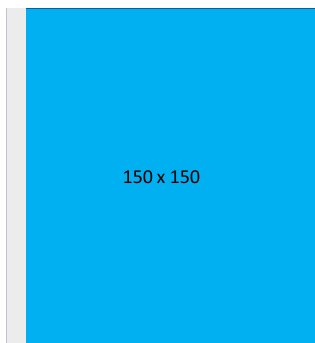

SIDE DRAPE



STANDARD SURGICAL GOWN

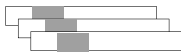

TRANSPARENT HOSE COVER

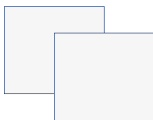

TOWEL

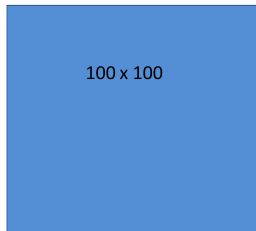

PACK

REF. MDC-ORTS-0281

		Sizes	Pieces
DENTAL DRAPE SET	DENTAL DRAPE	150 x 150	1
	SIDE DRAPE	150 x 150	1
	BACK TABLE COVER	100 x 150	1
	TRANSPARENT HOSE COVER	8 x 200	3
	STANDARD SURGICAL GOWN	L	1
	TOWEL	40 x 40	2
	PACK	100 x 100	1

Note: The set contents are for information purposes. The optional production can be done.

Implant Drape Set

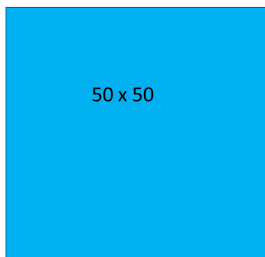
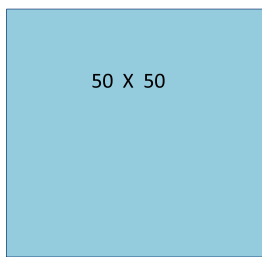
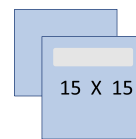

PLATE DRAPE



BACK TABLE COVER



REFLECTOR DRAPE

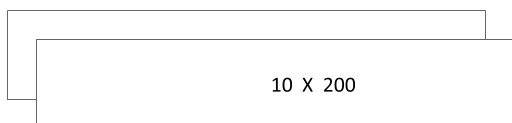

TRANSPARENT DRAPE



SPONGE



STANDARD SURGICAL GOWN



TOWEL

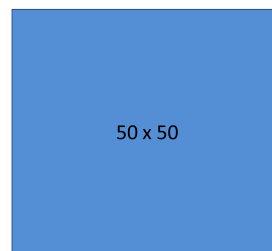

PACK

REF. MDC-ORTS-0285

		Sizes	Pieces
IMPLANT DRAPE SET	PLATE DRAPE	50 x 50	1
	BACK TABLE COVER	50 x 50	1
	SPONGE	7,5 x 7,5	10
	TRANSPARENT DRAPE	10 x 200	2
	REFLECTOR DRAPE	15 x 15	2
	STANDARD SURGICAL GOWN	L	1
	TOWEL	40 x 40	1
	PACK	50 x 50	1

Note: The set contents are for information purposes. The optional production can be done.



Disposable Clothing and Equipment



Disposable Clothing and Equipment



REF. NS-TUL-001



REF. NS-TUL-002



REF. NS-TUL-003



REF. NS-AO-001



REF. NS-KLN-0001



REF. NS-SED-0001



AKMEDA
MEDİKAL

Ostim OSB Mah. 1212 Cadde No: 2

Yenimahalle / ANKARA / TÜRKİYE

Tel: 0312 354 22 22 Fax: 0312 354 22 78

info@akmeda.com

www.akmeda.com