

Stand column: Diameter:89mm Thickness:2mm
 Platform size: 820*820mm

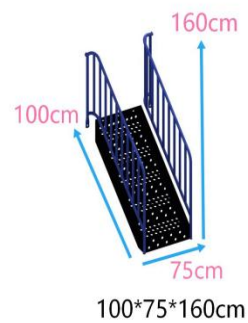

Product List

89mm pipe column	8	pcs
Square platform	3	pcs
Roof	2	pcs
Five-step ladder	2	pcs
One step ladder	1	pcs
Playground panel	3	pcs
92.5cm single slide	1	pcs
92.5cm double slide	1	pcs
120cm slide set	3	pcs
Ingot decoration	1	pcs
Bee decoration	1	pcs
Leaf decoration	1	pcs
Screw accessory bag	1	pcs

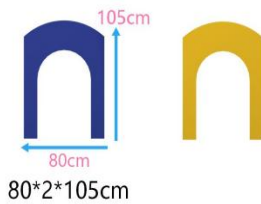
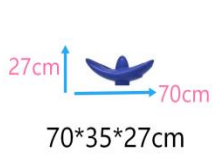
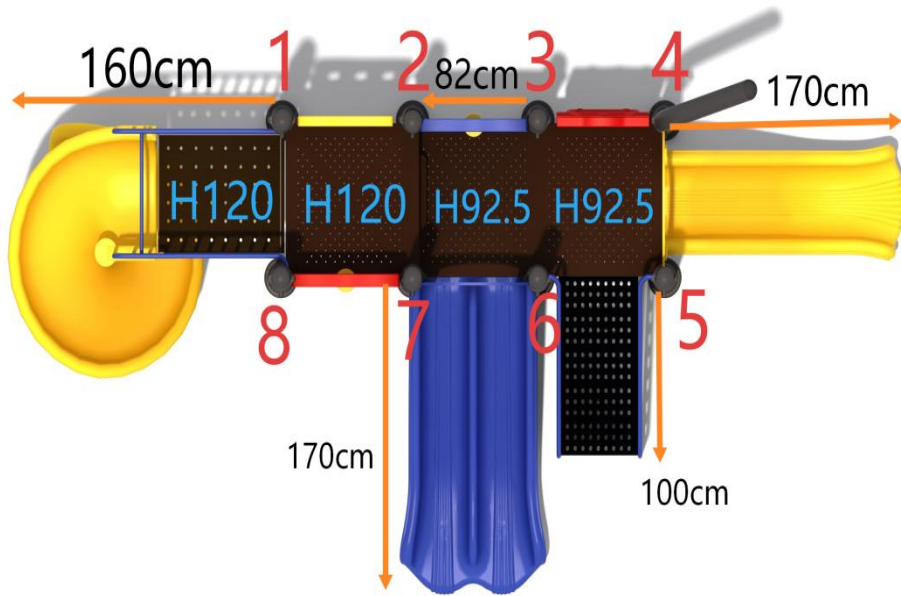
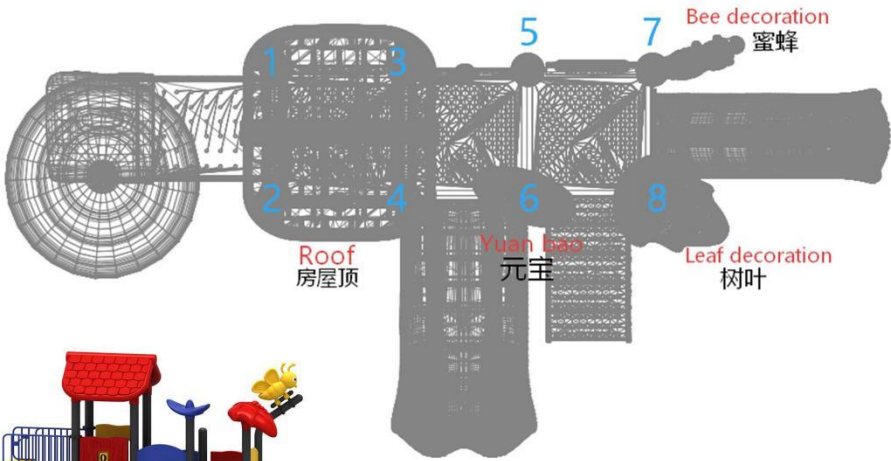
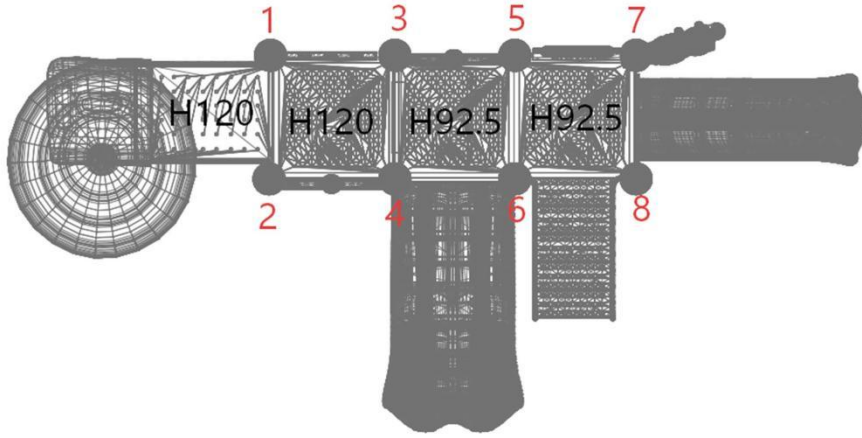

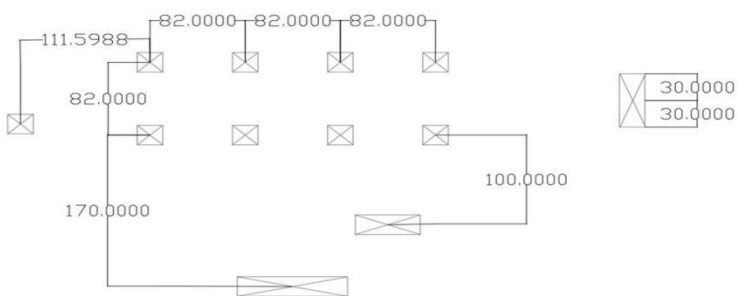
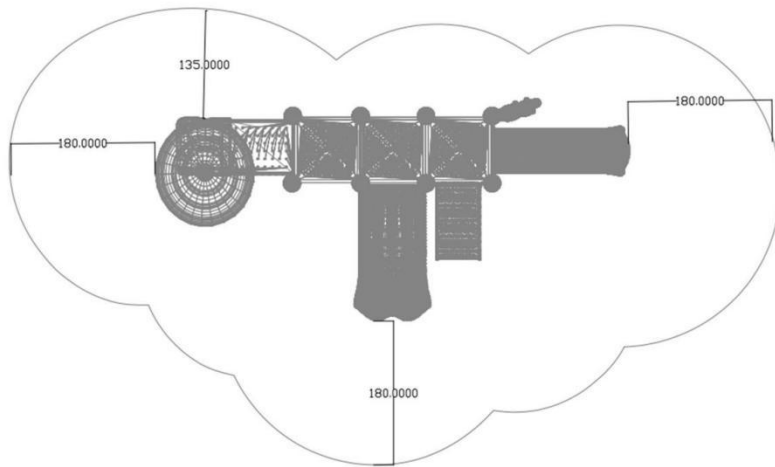
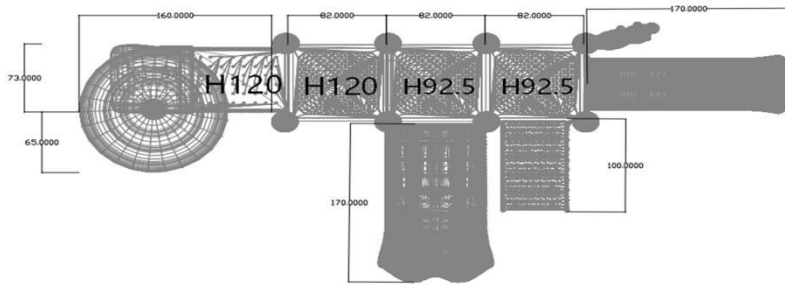

Post decorative elements

- . Position to be confirmed according to the top view layout
- . Fixed to the post using self-tapping screws with an electric drill

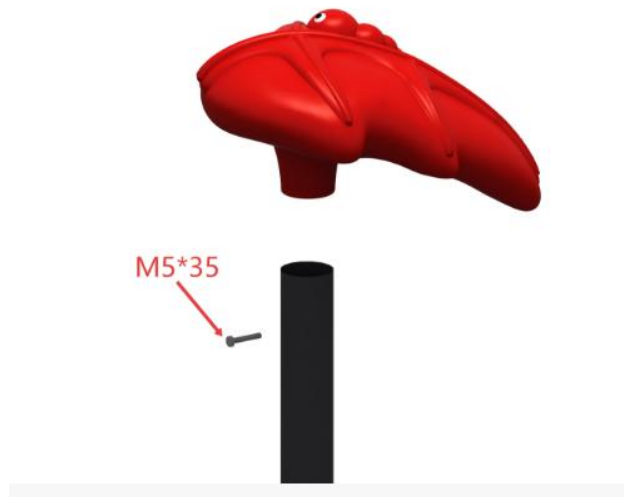

Accessories				
No.	Name	Specification	Picture	QTY
1	Self-tapping screws	M5×35		3 pcs

Roof

- . Position to be confirmed according to the top view layout
- . Install the post top cap and insert it into the roof opening
- . Install the accessories and tighten securely



Accessories			
No.	Name	Specification	QTY
1	Tail-locking screw	5*35	3pcs

Square platform

- . Position to be confirmed according to the top view layout
- . Install the platform onto the posts
- . Install the accessories and tighten securely

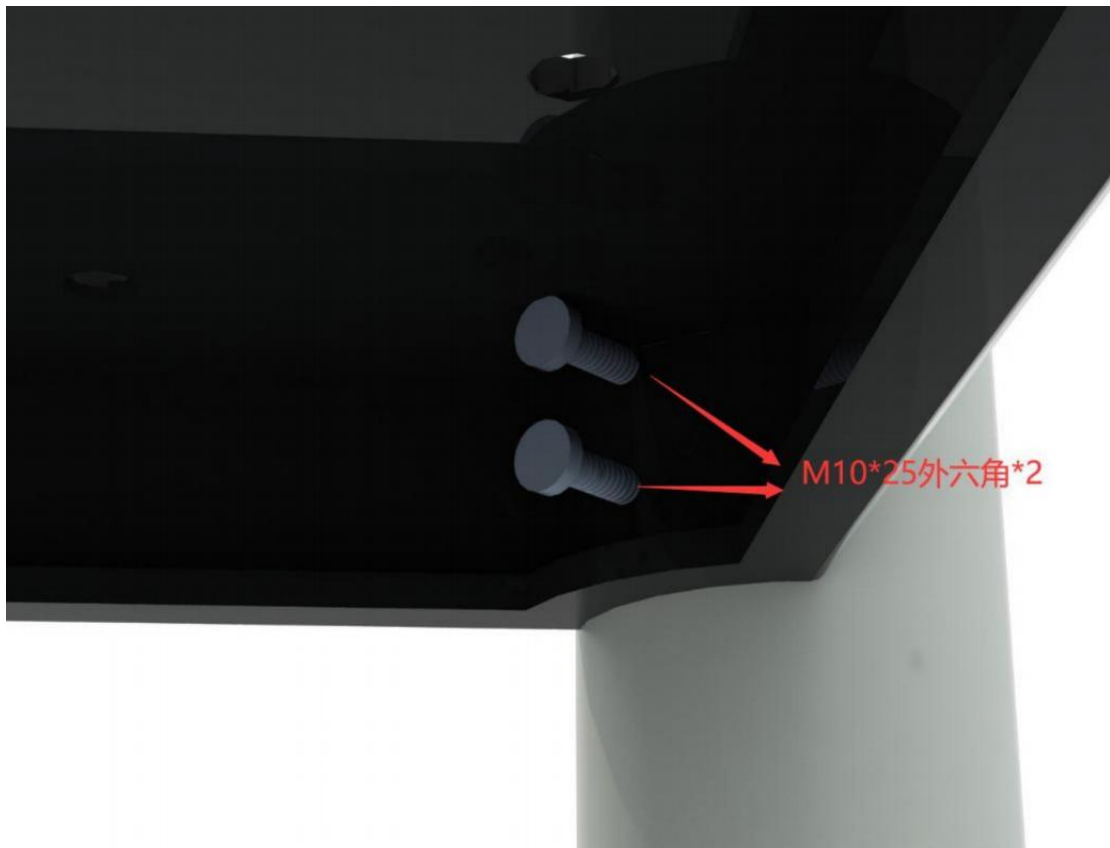

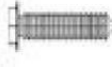

accessories				
No.	Name	Specification	Picture	QTY
1	Torx bolt	M10×25		8 pcs

Five-step ladder

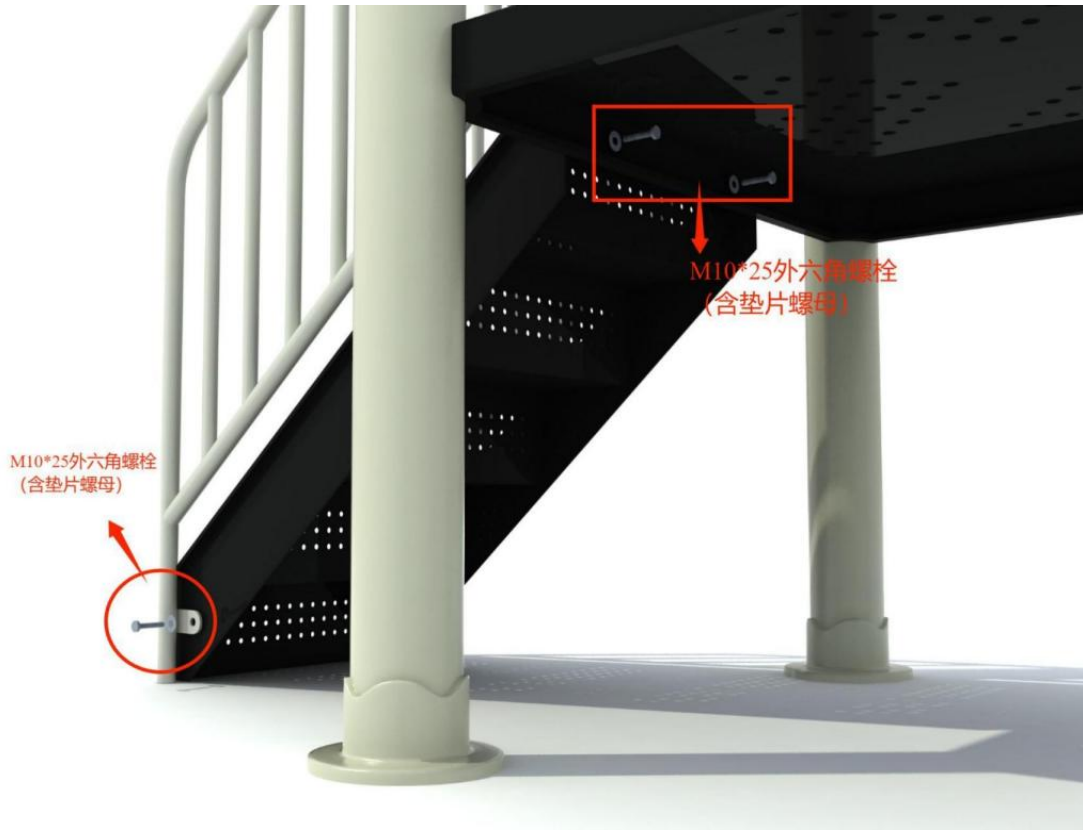
- . Position to be confirmed according to the top view layout
- . Install the ladder onto the platform
- . Install the accessories and tighten securely



accessories				
No.	Name	Specification	QTY	Picture
1	Torx bolt	M10×25	8 pcs	
2	Lock nut	M10	8 pcs	

S-shaped slide (H120)

- . Confirm the position of the S-shaped slide (H120) according to the top view layout
- . Install the S-shaped slide cover on each post
- . Install the accessories and tighten securely

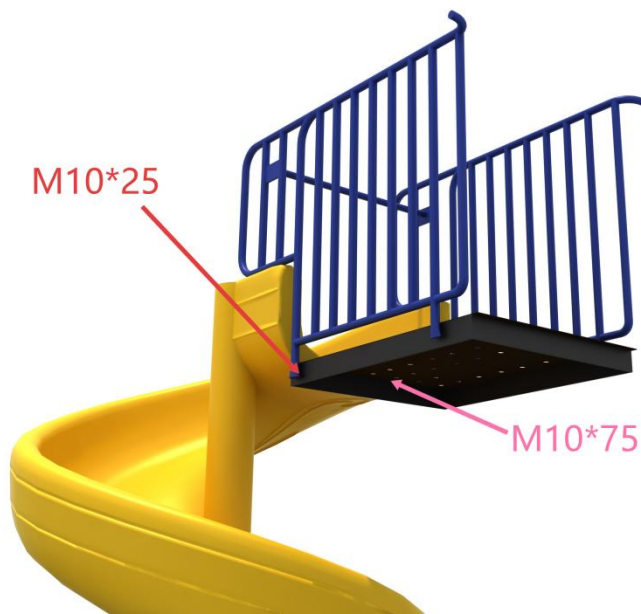

Accessories				
No.	Name	Specification	QTY	Picture
1	Torx bolt	M10×75	3 pcs	
2	Torx bolt	M10×25	8 pcs	
2	Lock nut	M10	11 pcs	

Single Slide (H92.5cm)

- Confirm the position of the single slide (H85) according to the top view layout
- Install the single slide onto the platform
- Install the accessories and tighten securely

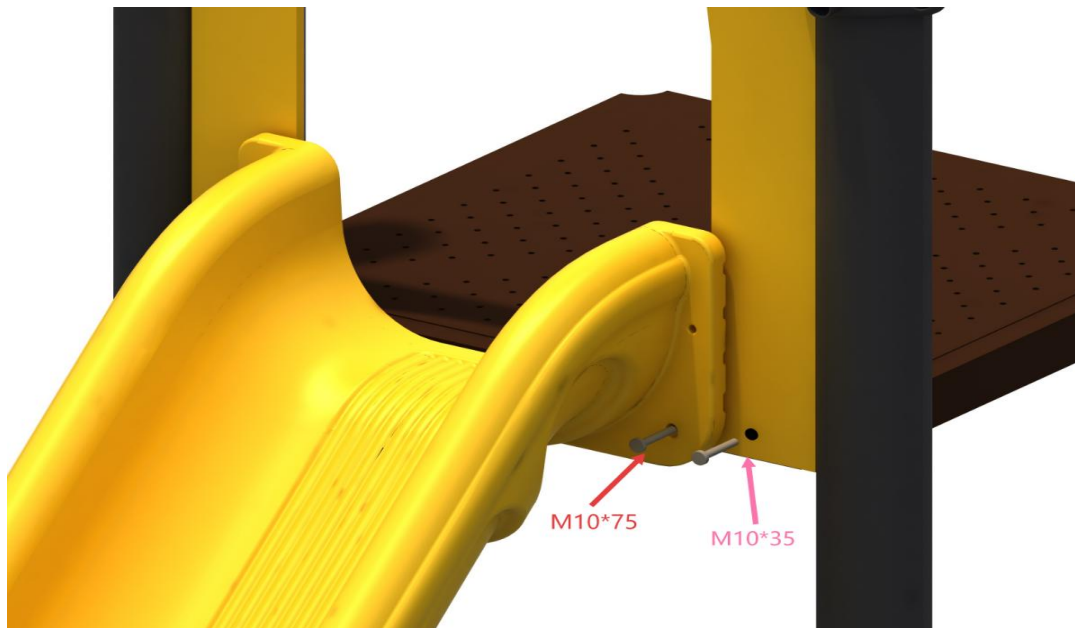

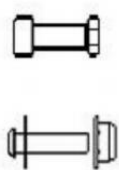
Accessories				
No.	Name	Specification	QTY	Picture
1	Torx bolt	M10×75	3 pcs	
2	Torx bolt	M10×35	2 pcs	
3	Lock nut	M10	4 pcs	

Double slide (H92.5cm)

- . Confirm the position of the double slide (H85) according to the top view layout
- . Install the double slide onto the platform
- . Install the accessories and tighten securely



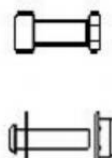

Accessories				
No.	Name	Specification	QTY	Picture
1	Torx bolt	M10×75	3 pcs	
2	Torx bolt	M10×35	2 pcs	
3	Lock nut	M10	4 pcs	

Plastic panel

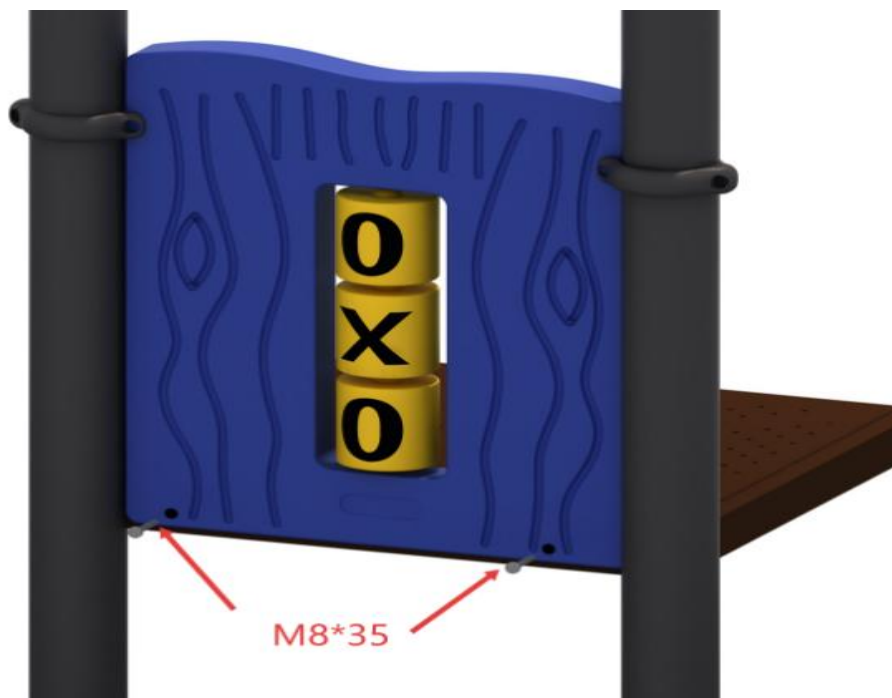
- . Confirm the position of the divider panel according to the top view layout
- . Install the divider panel onto the platform
- . Install the accessories and tighten securely



Accessories				
No.	Name	Specification	QTY	Picture
1	Torx bolt	M8×35	2 pcs	
2	Lock nut	M8	2 pcs	

Installation of small and large connectors

- . Distribute small and large connector pieces across all accessory installations
- . Install the small and large connector pieces onto the platform
- . Install the accessories and tighten securely



Accessories				
No.	Name	Specification	QTY	Picture
1	Button head hex socket bolt	M6×15	2 pcs	
2	Button head hex socket bolt	M6×30	2 pcs	
3	Button head hex socket bolt	M6×40	1 pcs	
4	M6 nut	M6	5 pcs	

Installation method :

We offer two installation methods(Please choose the one that suits you):

A. Expansion Bolt Installation – Suitable for cement or concrete floors. The equipment base is fixed directly to the ground with expansion bolts, making installation quick and easy.

B. Buried Installation – Suitable for sand, soil, or grass surfaces. Part of the post is buried in the ground and fixed with concrete for better stability. If there are no special requirements, the default buried depth is 30cm.

Please note: We will manufacture the equipment according to the installation method you choose, and it cannot be changed once production has started.

A. Expansion bolt installation method

1. The bottom of the frame type outdoor playground have corresponding mounting holes.
2. The installed expansion bolt has a length of 80 mm and a diameter of 10mm. It needs to be drilled with a 12mm diameter drill bit.
3. Installation of the ground requires the cement to harden the ground, or the installation hole is 30*30*30cm in the range of concrete ground.
4. The expansion bolt is tightened by the mounting hole of the outdoor playground.

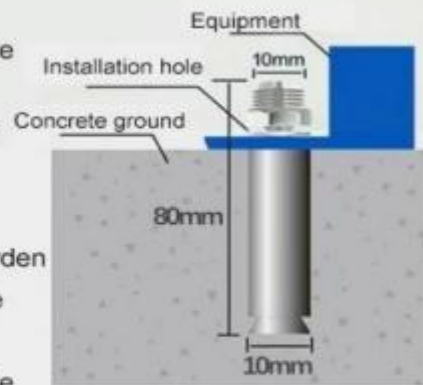

B. Directly buried installation method

1. Direct burying depth of outdoor playground: When the column is greater than or equal to 2 meters, the recommended pit size is 500*500*700mm.
2. The bottom of the outdoor playground directly buried pit needs 100mm thickness of concrete support to prevent the equipment from sinking.
3. Concrete mixing ratio (cement: sand: stone) 1:2:3.5

