

Nanjing Jingning Quality Inspection Company

TEST REPORT

1. TEST DATE: January 6 th, 2020
2. NUMBER OF SAMPLES TESTED: 50 PCS
3. APPLICABLE STANDARD: DIN933 Bolt, class -5.8 zinc plated 8x60 (156027)
4. INSPECTOR: LIJUN

DIN933 Bolt, class -5.8 zinc plated 8x60 (156027)

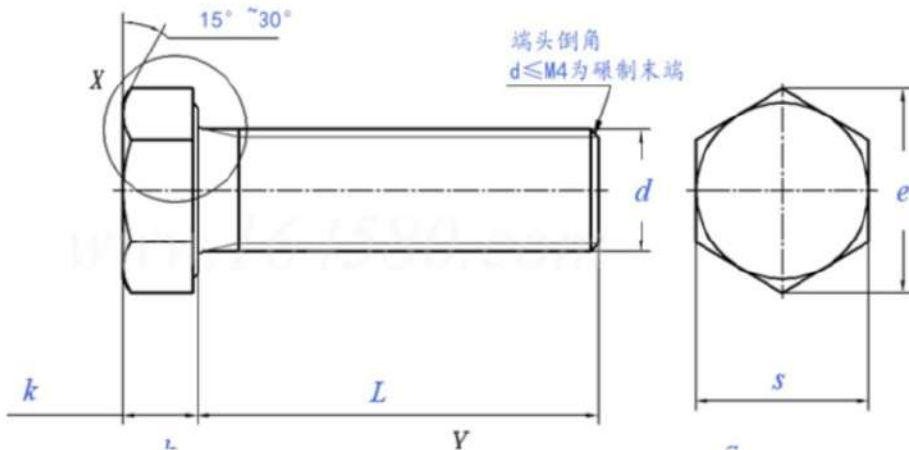

Items	d(mm)		k(mm)		s(mm)	
	Standard	Testing result	Standard	Testing result	Standard	Testing result
8x60	7.76-7.972	ACC	5.15-5.3	ACC	12.73-13	ACC

Items	Tensile Strength	
	Standard (kN)	Testing result
8x60	15.4	ACC

REMARK:

1. Test results are in accordance to the standard indicated.

2. ACC-Accept; REJ-Rejected

Material: Q195

Chemical composition & Technical specification

Element	C%	Si%	Mn%	P%	S%
8x60 Ratio	0.16~0.18	0.15~0.21	0.36~0.46	0.018~0.034	0.014~0.018

