

EMS AMBULANCE MAIN STRETCHER ACCESSORIES ES-125 / ES-126

2.3.8 Main Stretcher Mattress (ES-130)

The stretcher mattress has been produced from washable and fire retardant material. It has been pressed to have an ergonomic form.

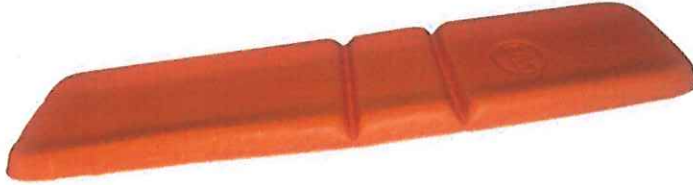

2.3.9 STRETCHER SAFETY BELTS (ES-100-3)

There are 3 safety belts to protect the patient against braking, acceleration, crash etc. In addition, there is a shoulder safety belt affixed to the safety belt over the chest.



2.3.9.1 Attaching the Head Strap

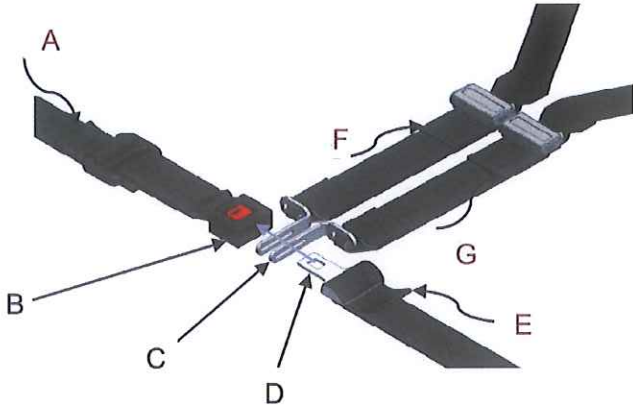

Attach the (C) clip as shown above. Put the male end of the belt (D) through the openings of (C) and into the (B) securely. Place all the parts on the center and pull them until the belts on the ends A, E, F and / or G become tight. (On the body belts, there are no C elements.)

2.3.9.2 Attaching the Body Strap

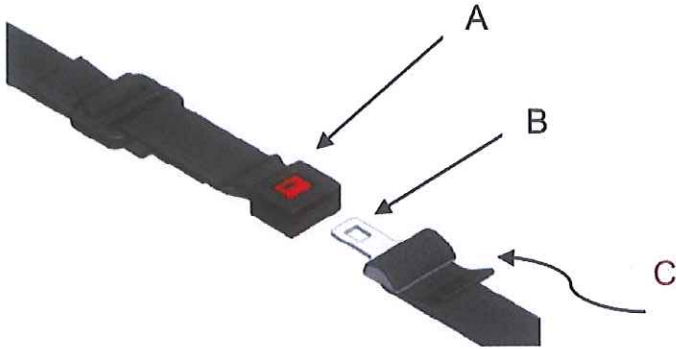

Position the female part of the buckle (A) and the male part of the buckle (B) like shown below and attach them to the nest. After securing the attachment, align them on the center of the patient and make them tight and adjust the tightness of the belt on the end C.



Make sure that the patient on the stretcher is protected via patient safety belts all the time.

2.4 OPTIONAL APPARATUSES

2.4.1 (IV POLE) (ES-100-05)

It is mounted on the stretcher guard rail. Its height can be adjusted. It can carry 2 serums. When it is not used, it is folded upon the guard rail.



2.4.2 Cylinder Carrier

It consists of a zipped bag having oxygen cylinders of 1 liter or 2 liters and sections for oxygen masks. It can be affixed to the stretcher and it can be carried on shoulder. It has been produced from nylon mixed material. It is portable, easily carried.

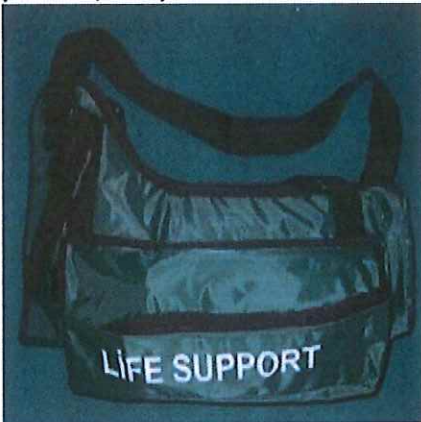

2.3.2 Fixation of the Stretcher (LOCK ES-100-07)

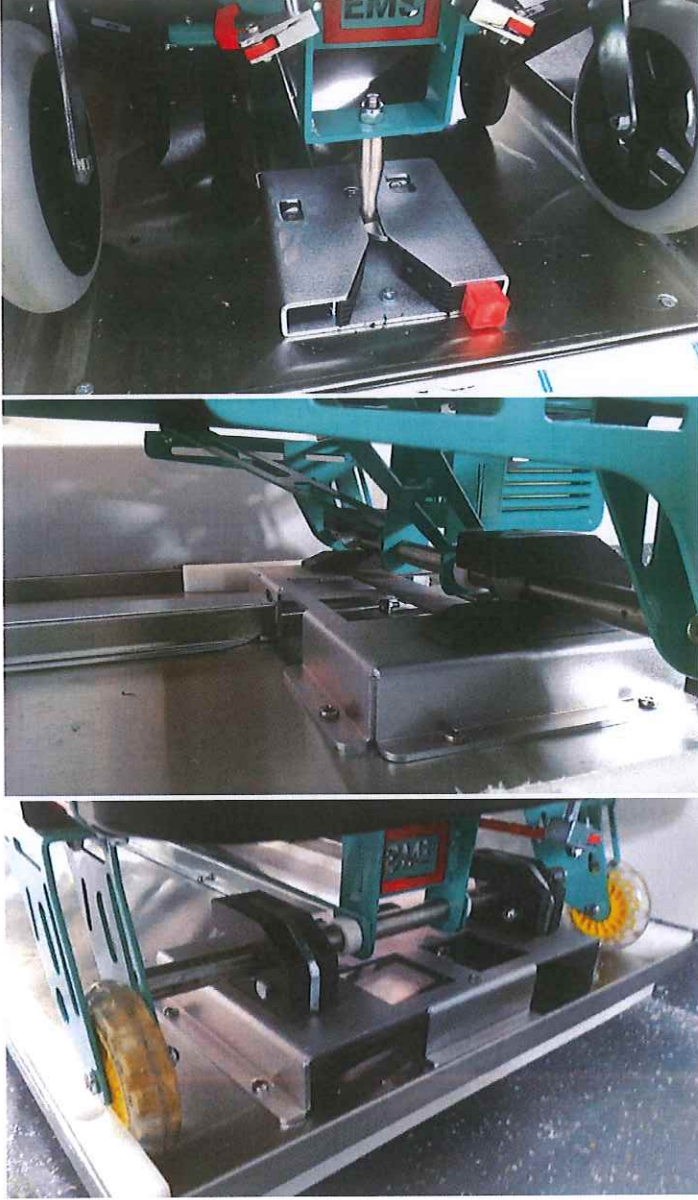

Before leaving the stretcher, make sure that the stretcher pin is locked. The locking system locks both at the front and at the rear part.

For locking, push the stretcher lock pin into the lock. Press the stretcher in the direction of locking until you hear (CLICK) sound from the lock.



Warning: Pay attention that the lock is on at this time. You must be sure that the stretcher has been locked. You confirm this by pulling the stretcher rearwards when it is locked. Concerning the risk of the opening of the rear doors of the ambulance, always give importance to the locking of the stretcher.

2.3.3. The Unloading of the Stretcher from the Ambulance Vehicle

The unloading of the stretcher starts by opening the stretcher rear lock. In order to unload a locked stretcher, the operator must press the red button and pull the stretcher rearwards.

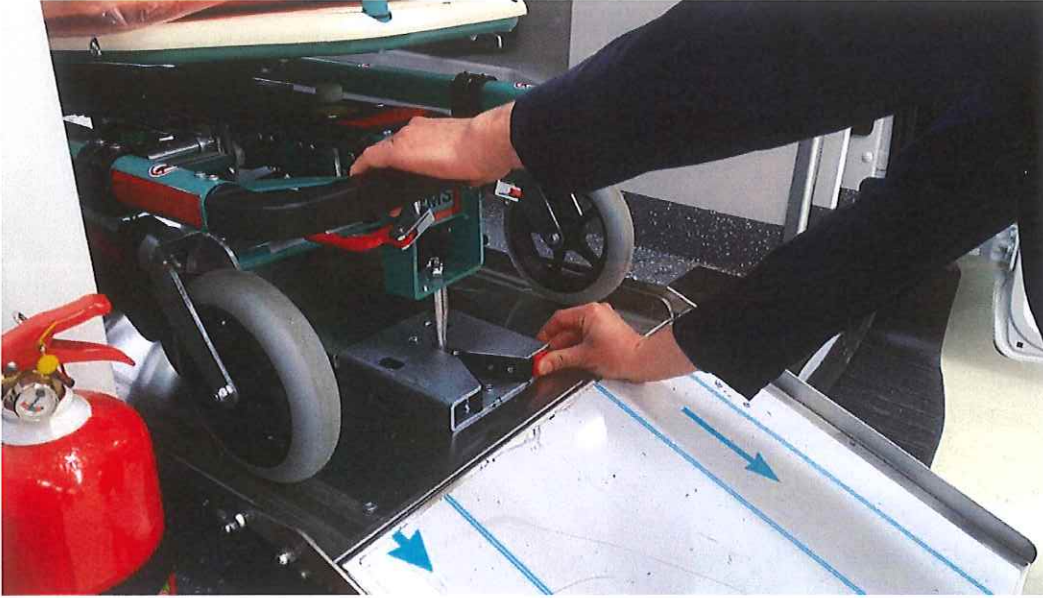
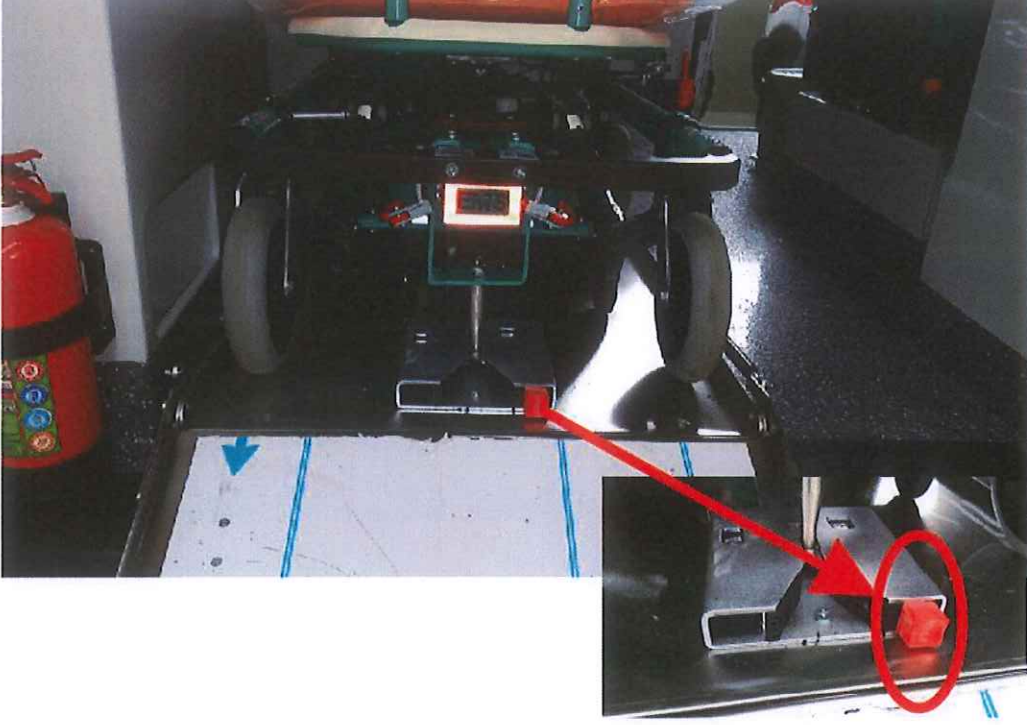

The stretcher is pulled rearwards slowly.