



# Technical Publications

5929163-1EN

Rev. 3



LOGIQ Totus™ User Manual

Version R4

[Operating Documentation](#)

[Copyright 2023 By GE HealthCare.](#)

# ***Regulatory Requirement***

**LOGIQ Totus complies with regulatory requirements of the following European Regulation 2017/745 EU concerning medical devices.**



**This User Manual is a reference for the LOGIQ Totus. It applies to Version R4 software for the LOGIQ Totus ultrasound system.**

GE HealthCare  
P.O. Box 414, Milwaukee, Wisconsin 53201 *U.S.A.*  
(Asia, Pacific, Latin America, North America)

GE HealthCare GmbH  
Beethovenstrasse 239  
Postfach 11 05 60  
D-42655 Solingen *GERMANY*  
TEL: 49 212.28.02.208; FAX: 49 212.28.02.380

---

# Revision History

## Reason for Change

REV	DATE (YYYY/MM/DD)	REASON FOR CHANGE
Rev. 1	2023/11/18	Initial release
Rev. 2	2023/12/08	Enhancement feedback
Rev. 3	2024/02/14	Enhancement feedback

## List of Effective Pages

PAGE NUMBER	REVISION NUMBER	PAGE NUMBER	REVISION NUMBER
Title Page	Rev. 3	Chapter 6	Rev. 3
Revision History	Rev. 3	Chapter 7	Rev. 3
Regulatory Requirements	Rev. 3	Chapter 8	Rev. 3
Table of Contents	Rev. 3	Chapter 9	Rev. 3
Chapter 1	Rev. 3	Chapter 10	Rev. 3
Chapter 2	Rev. 3	Chapter 11	Rev. 3
Chapter 3	Rev. 3	Chapter 12	Rev. 3
Chapter 4	Rev. 3	Chapter 13	Rev. 3
Chapter 5	Rev. 3	Index	Rev. 3

---

Please verify that you are using the latest revision of this document. Information pertaining to this document is maintained on MyWorkshop. If you need to know the latest revision, contact your distributor, local GE HealthCare Sales Representative or in the USA call the GE HealthCare Ultrasound Clinical Answer Center at 1 800 682 5327 or 1 262 524 5698.

---

---

This page intentionally left blank.

---

# Regulatory Requirements

## Conformance Standards

The following classifications are in accordance with the IEC/EN 60601-1:

- According to 2017/745 Medical Devices Regulation, this is Class IIa Medical Device.
- According to IEC/EN 60601-1,
  - Equipment is Class I, INTERNALLY POWERED ME EQUIPMENT, Type BF or CF Applied Parts.
- According to CISPR 11,
  - Equipment is Group 1, Class A ISM Equipment.
- According to IEC 60529,
  - The footswitch rate IPX8 is suitable for use in surgical rooms.
  - Probe head (immersible portion) and cable are IPX7  
Probe connector is not waterproof.
  - The Vscan Air CL which is wireless probe is classified to IP67, and its charger classified to IP41.

---

## Conformance Standards (continued)

This product complies with the regulatory requirement of the following:

- European Regulation 2017/745 EU concerning medical device: the CE label affixed to the product testifies compliance to the Regulation.

The location of the CE marking is shown in the Safety chapter of this manual.

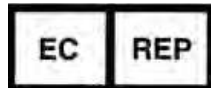

### Authorized EU Representative

European registered place of business:

GE Medical Systems SCS

283 rue de la Minière

78530 BUC, France

Tel: +33 (0) 1 30 70 4040

### Authorized Swiss Representative

GE Medical Systems (Schweiz) AG

Europa-Strasse 31

8152 Glattbrugg

Switzerland



- ANSI/AAMI ES 60601-1:2005/A2:2021, CAN/CSA-C22.2 No. 60601-1 (Amendment 2:2022)
- Certified to CSA CAN/CSA-C22.2 No60601-1 :14 General requirements for safety
- CE Marked to European Regulation 2017/745 EU concerning medical device Conforms to the following standards for safety:
- IEC/EN 60601-1 3.2 Edition. Medical electrical equipment - Part 1: General requirements for basic safety and essential performance
- IEC/EN 60601-1-2 Medical electrical equipment - Part 1-2: General requirements for safety - Collateral Standard: Electromagnetic compatibility - requirements and tests
- IEC/EN 60601-1-6 Medical electrical equipment Part 1-6: General requirements basic safety and essential performance - Collateral Standard: Usability

---

## Conformance Standards (continued)

- IEC/EN 60601-2-37 Medical electrical equipment - Part 2-37: Particular requirements for the safety of ultrasonic medical diagnostic and monitoring equipment
- IEC 61157 (Standard means for the reporting of the acoustic output of medical diagnostic ultrasonic equipment)
- IEC/EN 62366 Application of usability engineering to medical devices
- IEC/EN 62304 Software Life Cycle Processes
- IEC/EN 62359 Ultrasonic - Field characterization - Test methods for the determination of thermal and mechanical indices related to medical diagnostic ultrasonic fields
- EN ISO 15223-1 : Symbols to be used with medical device labels, labelling and information to be supplied
- ISO 10993-1 Biological evaluation of medical devices - Part 1 Evaluation and testing
- ISO 14971 : (Medical devices - Application of risk management to medical devices)
- EMC Emissions Group 1, Class A device requirements as per Sub clause 4.2 of CISPR 11
- WEEE (Waste Electrical and Electronic Equipment)
- ROHS according to 2011/65/EU Including national deviations
- Wireless equipment shall be certified to FCC, RED and Japan Radio Law.
- Medical Device Good Manufacturing Practice Manual issued by the FDA (Food and Drug Administration, Department of Health, USA)

---

## Certifications

- GE HealthCare Medical Systems is ISO 13485 certified.

## Original Documentation

- The original document was written in English.

## Importer Information

- Turkey

GE Medical Systems Türkiye Ltd. Şti.  
Esentepe Mah. Harman Sok. No: 8  
34394 Şişli İstanbul Türkiye

## Kazakhstan - Authorized representative in Kazakhstan

This information is only valid for Kazakhstan

English	Kazakh	Russian
GE HealthCare Kazakhstan LLP 26/41, Zenkova Street, Medeu District, Almaty, 050010, Kazakhstan  T +7 727 3560020	«ДжиИ Хэлскеа Қазақстан» ЖШС Қазақстан, Алматы қаласы, Медеу ауданы, көшесі ЗЕНКОВ, үй 26/41, пошталық индексі 050010 T +7 727 3560020	ТОО «ДжиИ Хэлскеа Қазақстан» Қазақстан, город Алматы, Медеуский район, улица Зенкова, дом 26/41, почтовый индекс 050010 T +7 727 3560020



---

# Table of Contents

Conformance Standards	i-3
Certifications	i-6
Original Documentation	i-6
Importer Information	i-6
Kazakhstan - Authorized representative in Kazakhstan	i-6
<b>Table of Contents</b>	
<b>Chapter 1 — Introduction</b>	
<b>System Overview</b>	
Attention	1-2
Documentation	1-3
Principles of Operation	1-8
Indications for Use	1-9
Contraindication	1-10
Prescription Device	1-10
Patient Population	1-10
Potential additional considerations of use environment	1-11
<b>Contact Information</b>	
Contacting GE HealthCare Ultrasound	1-12
Manufacturer	1-17
<b>Chapter 2 — Safety</b>	
<b>Owner Responsibility</b>	
Owner requirements	2-2
Notice against user modification	2-2
Reporting	2-3
<b>Safety Precautions</b>	
Precaution Levels	2-4
Hazard Symbols	2-5
Patient Safety	2-7
Equipment and Personnel Safety	2-11
Classifications	2-18
EMC (Electromagnetic Compatibility)	2-19
Patient Environmental Devices (LCD monitor)	2-38
Acoustic Output	2-41
RoHS LOGIQ Totus Hazardous Substances	2-45
WEEE Passport	2-47
Safe Product and Packaging Disposal	2-47
<b>Device Labels</b>	
Label Icon Description	2-48
Label on the packing box	2-58

---

Probe Labeling - - - - -	2-59
<b>Chapter 3 — Preparing the System for Use</b>	
<b>Site Requirements</b>	
Introduction - - - - -	3-2
Before the system arrives - - - - -	3-3
Environmental Requirements - - - - -	3-4
<b>Console Overview</b>	
Console Graphics (LCD monitor) - - - - -	3-6
Peripheral/Accessory Connection - - - - -	3-13
<b>Powering the System</b>	
Connecting the System - - - - -	3-19
Circuit breaker - - - - -	3-21
Power On - - - - -	3-22
<b>System Language Configuration</b>	
Select the System Language and Date/Time Format - - - - -	3-40
<b>Connecting the Probe</b>	
Connecting the Probe - - - - -	3-46
Unpacking - - - - -	3-47
Chirping noise - - - - -	3-48
Cable Handling - - - - -	3-48
Selecting probes - - - - -	3-49
Deactivating the Probe - - - - -	3-50
Disconnecting the Probe - - - - -	3-50
Storing the Probe - - - - -	3-51
Storage/Transportation - - - - -	3-51
<b>Operator Controls</b>	
Control Panel Map - - - - -	3-52
Control panel adjustment - - - - -	3-53
Keyboard - - - - -	3-55
Touch Panel - - - - -	3-58
Mode, Display and Print - - - - -	3-60
Measurement and Annotation - - - - -	3-61
<b>Monitor</b>	
Adjusting the Monitor Position - - - - -	3-62
Locking/unlocking the Monitor - - - - -	3-65
Adjusting the Monitor - - - - -	3-66
Wide Screen Monitor Display Settings - - - - -	3-68
Test Patterns - - - - -	3-72
<b>Monitor Display</b>	
Monitor Display - - - - -	3-74
Monitor Display Layout - - - - -	3-76
Using the Monitor Display Controls to Manage Images - - - - -	3-81
<b>System Positioning/Transporting</b>	
Moving the System - - - - -	3-82
Wheels - - - - -	3-86
Transporting the System - - - - -	3-89
Acclimation Time - - - - -	3-90

---

## Chapter 4 — Preparing for an Exam

### Beginning an Exam

Introduction	4-2
Patient Screen	4-3
OB Exam	4-7

### Starting an examination

Cautions and Warnings	4-10
Creating a new patient record	4-12
Perform an exam	4-13
Ending an exam	4-14
Scanning without entering any patient data	4-14
Starting a new exam on an existing patient	4-15
Retrieve Patient/Exam Information from Worklist	4-16
Sending Multiple Exams and Patients with Single Click to PACS	4-17
Change Patient Information except Patient ID and scan	4-17
Change Patient ID of the existing patient (Edit & Copy)	4-18

### Retrieving and editing archived information

Searching for an existing patient	4-21
Changing Patient Information or an Exam	4-24
Deleting the existing patient/exam/image	4-25

### MyPreset

Overview	4-27
Activating MyPreset	4-27
Arranging MyPreset Tab	4-29

## Chapter 5 — Optimizing the Image

### Optimizing B-Mode

Intended Uses	5-2
B-Mode Scanning Hints	5-3
B-Mode Controls	5-4
Auto Optimize	5-8
Continuous Tissue Optimization (CTO)	5-10
SRI-HD (High Detection Speckle Reduction Imaging)	5-11
CrossXBeam	5-14
B-Flow	5-15
LOGIQView	5-19
B Steer+ (Option)	5-21
Preset	5-25
Touch TGC	5-26
Speed of Sound (SoS) Tissue Imaging	5-28
Minimizing Grating Lobe/Side Lobe Artifacts	5-29

### Optimizing M-Mode

Intended Use	5-31
Introduction	5-31
Typical exam protocol	5-32
M-Mode Controls	5-32
Anatomical M-Mode (AMM) and Anatomical Color M-Mode (ACMM)	5-33

<b>Optimizing Color Flow</b>	
Intended Use	5-35
Introduction	5-35
Activating Color Flow	5-37
Color Flow Mode Controls	5-37
Radiantflow	5-40
Flow Model Shortcuts	5-41
Power Doppler Imaging (PDI)	5-44
<b>Optimizing M Color Flow</b>	
M Color Flow Mode	5-48
<b>Optimizing Spectral Doppler</b>	
Intended Use	5-49
Spectral Doppler Display	5-51
PW Doppler Mode Display	5-52
Doppler Mode Controls	5-53
<b>Using 3D</b>	
Overview	5-57
3D Acquisition	5-58
3D Acquisition Parameter Description	5-60
Manipulating the Volume of Interest	5-62
Easy 3D	5-64
Advanced 3D	5-66
Movie 3D	5-69
Tru3D and Volume Measurement	5-70
<b>Chapter 6 — Scanning/Display Functions</b>	
<b>Freezing an Image</b>	
Introduction	6-2
Freezing an image	6-2
<b>Using CINE</b>	
Introduction	6-3
Using CINE	6-5
Mark CINE	6-7
Preview	6-8
Background Store	6-8
Image Storage Hints	6-9
Cine Capture	6-10
<b>Image Zoom</b>	
Overview	6-14
HD Zoom	6-15
Pan Zoom	6-16
Magnification Zoom	6-17
<b>Split Screen</b>	
Overview	6-18
Dual screen	6-18
Quad screen	6-19
Simultaneous mode	6-19
Dual Caliper	6-19

---

<b>Annotating an Image</b>	
Introduction - - - - -	6-23
Adding Comments to an Image - - - - -	6-25
Body Patterns- - - - -	6-35
<b>Using the Fast Key</b>	
Overview - - - - -	6-44
Create a Fast Key - - - - -	6-44
Start a Fast Key - - - - -	6-45
Backup and Restore the Fast Key - - - - -	6-45
<b>Chapter 7 — General Measurements and Calculations</b>	
<b>Introduction</b>	
Introduction - - - - -	7-2
Basic Operation - - - - -	7-3
Measurement Controls - - - - -	7-6
Touch Panel- - - - -	7-7
Exam category/Study/Measurement - - - - -	7-11
General Instructions - - - - -	7-12
Measurement Cursor - - - - -	7-14
Copy, move and paste measurement tools - - - - -	7-15
Performing Measurements on Saved Images - - - - -	7-16
<b>Generic Measurements</b>	
Overview - - - - -	7-18
B-Mode Measurements - - - - -	7-19
M-Mode Measurements- - - - -	7-29
Doppler Mode Measurements - - - - -	7-32
Helpful hints - - - - -	7-37
<b>Mode Measurements</b>	
B-Mode Measurements - - - - -	7-38
Doppler Mode Measurements - - - - -	7-45
M-Mode Measurements- - - - -	7-56
<b>Worksheet</b>	
Introduction - - - - -	7-58
To view a worksheet - - - - -	7-59
To edit a worksheet- - - - -	7-60
Recording Worksheet - - - - -	7-64
OB Worksheet - - - - -	7-65
Vascular Worksheet - - - - -	7-67
<b>Anatomical Survey</b>	
Overview - - - - -	7-71
Editing - - - - -	7-72
<b>Measurement and Calculation Setup</b>	
Starting Study and Measurement Setup - - - - -	7-75
Display/hide a folder or a measurement in the Touch Panel - - - - -	7-80
Setting up an automatic measurement flow - - - - -	7-85
Change the tool used to make a measurement - - - - -	7-86
Adding Folders and Measurements - - - - -	7-87
M & A Advanced Preset - - - - -	7-100

---

Doppler tab - Modify Calculation- - - - -	7-105
Application Measurement Preset - - - - -	7-106
<b>Chapter 8 — Application M&amp;A</b>	
<b>General Information</b>	
Overview - - - - -	8-2
General Guidelines - - - - -	8-2
<b>Abdomen</b>	
Overview - - - - -	8-3
<b>Small Parts</b>	
B-Mode Measurements - - - - -	8-4
<b>OB</b>	
Introduction - - - - -	8-6
OB Type change- - - - -	8-7
To Start an Obstetrics Exam - - - - -	8-8
OB Measurements Performed Over Multiple Planes- - - - -	8-12
OB Calculation - - - - -	8-15
OB Graphs- - - - -	8-17
OB-Multigestational- - - - -	8-26
OB Table Editor - - - - -	8-28
<b>GYN</b>	
Introduction - - - - -	8-42
B-Mode Measurements - - - - -	8-42
<b>Cardiac</b>	
Overview - - - - -	8-45
Naming Format for Cardiac Measurements - - - - -	8-45
Cardiac Doppler Measurements - - - - -	8-49
<b>Vascular</b>	
Introduction - - - - -	8-50
IMT Measurement- - - - -	8-55
Auto Vascular Calculation - - - - -	8-65
Manual Vascular Calculation - - - - -	8-69
Intravessel ratio - - - - -	8-70
Bypass Graft Anastomosis Graph - - - - -	8-72
<b>Urology</b>	
Introduction - - - - -	8-75
Bladder Volume - - - - -	8-75
Renal Volume- - - - -	8-76
Prostate Volume- - - - -	8-76
Pelvic Floor Measurements - - - - -	8-78
<b>Pediatrics</b>	
Overview - - - - -	8-81
Pediatrics Hip- - - - -	8-82
<b>Chapter 9 — Recording images</b>	
<b>Getting Set Up to Record Images</b>	
Overview - - - - -	9-2
Image Management Guide - - - - -	9-4
Adding Devices - - - - -	9-5

Adding a Dataflow- - - - -	9-5
Adding Devices to a Print Button - - - - -	9-5
<b>Storing Images and Cineloops</b>	
Storing an image - - - - -	9-6
Storing a cine loop - - - - -	9-7
<b>Review images in archive</b>	
Review the patient exam/image - - - - -	9-10
Active Images- - - - -	9-11
Image Tags - - - - -	9-13
Image Reorder - - - - -	9-18
Image History- - - - -	9-20
<b>Clipboard</b>	
Clipboard icon - - - - -	9-22
Saving the image /cine to the Clipboard - - - - -	9-22
Previewing Clipboard Images- - - - -	9-23
Recalling Images from the Clipboard - - - - -	9-23
To delete an image from the clipboard - - - - -	9-23
<b>Save As</b>	
Overview - - - - -	9-24
SaveAs - - - - -	9-24
'SaveAs' Images- - - - -	9-28
Storing Images with More Resolution - - - - -	9-28
<b>Unified Background Export</b>	
Export from Patient Screen - - - - -	9-29
Export from Active Image Screen - - - - -	9-31
Spooler Screen- - - - -	9-32
Spooler Status Icons- - - - -	9-33
<b>DICOM Viewer</b>	
Installing the DICOM Viewer - - - - -	9-34
Configuring the DICOM Viewer - - - - -	9-35
<b>Data Transfer</b>	
Overview - - - - -	9-36
Export/Import - - - - -	9-36
Worklist (Search and retrieve the Patient/Exam information)- - - - -	9-38
<b>External drives</b>	
Intended Use - - - - -	9-39
USB Hard Disk Drive and USB Flash Drive - - - - -	9-40
USB Quick Save- - - - -	9-45
<b>Printing Options</b>	
Setting up Digital Peripherals - - - - -	9-46
External Paper Printer- - - - -	9-54
<b>Portable Exam</b>	
Perform a Portable Exam (Using the Worklist) - - - - -	9-58
<b>Chapter 10 — Customizing Your System</b>	
<b>Presets</b>	
Overview - - - - -	10-2

---

## System Presets

Overview	10-6
Changing system parameters	10-7
System/General Preset Menu	10-8
System/System Display Preset Menu	10-12
System/System Imaging Preset Menu	10-15
System/System Measure Preset Menu	10-19
System Backup and Restore Preset Menu	10-22
System/Peripherals Preset Menu	10-24
System/User Configurable Key	10-26
System/About Preset Menu	10-29
Licenses	10-29
System/Scanner Apps Info	10-29

## Imaging Presets

Overview	10-30
Changing imaging presets	10-31
General	10-31

## Comments Libraries Presets

Overview	10-33
Comments Libraries/Libraries Preset Menu	10-33
Comments Libraries/Comments Preset Menu	10-36
Comments Libraries/Applications Preset Menu	10-37
Comments Libraries/Mapping Preset Menu	10-39

## Body Patterns Presets

Overview	10-42
Body Pattern Libraries/Libraries Preset Menu	10-42
Body Pattern Libraries/Body Patterns Preset Menu	10-44
Body Pattern Libraries/Applications Preset Menu	10-45

## Application Presets

Overview	10-47
----------	-------

## User Specific

### Test Patterns

#### 3D/4D

Overview	10-56
4D Presets	10-56

## Configuring Connectivity

Connection Manager	10-62
Scanner Page	10-63
Network Page	10-65
Proxy	10-70
Special Devices Page	10-92

## Measure

### Reports

## System Administration

Overview	10-141
Administrator Tasks	10-142
Privacy and Security	10-142



System Admin	10-150
Users	10-153
Logon	10-154
Groups	10-167
System Password	10-170
Disk Encryption	10-171
Audit Report and System Log Server Configuration	10-179
<b>Imaging Preset Manager</b>	
Overview	10-182
Creating a User-Defined Application Preset	10-182
Sharing User Presets between LOGIQ Totus Systems	10-187
Retain Field of View	10-188
<b>Backup and Restore</b>	
Overview	10-189
<b>Search</b>	
Utility Parameter Search	10-194
<b>Chapter 11 — Probes and Biopsy</b>	
<b>Probe Overview</b>	
Ergonomics	11-2
Supported Probes	11-2
Probe orientation	11-10
Probe Naming Conventions	11-10
<b>Probe Safety</b>	
Care and Handling	11-11
Handling precautions	11-12
Electrical shock hazard	11-13
Special handling instructions	11-14
Probe handling and infection control	11-16
<b>Care and Maintenance</b>	
Inspecting probes	11-17
Probe Reprocessing	11-19
Probe Cleaning and Disinfecting Notes	11-38
Probe Disinfectants	11-41
Coupling Gels	11-46
V Nav Cleaning Requirements	11-48
Planned Maintenance	11-49
Automatic Probe Diagnostics	11-50
Probe Check (not available in all countries)	11-51
Probe Care Cards	11-54
Returning/Shipping Probes and Repair Parts	11-56
<b>Biopsy Special Concerns</b>	
Precautions Concerning the Use of Biopsy Procedures	11-57
Freehand Biopsy	11-59
Biopsy Guide Sterilization	11-60
<b>Performing a Biopsy</b>	
Displaying the Guidezone	11-61
Preparing the Biopsy Guide Attachment	11-66

---

4D Probe Biopsy Needle Path Selection - - - - -	11-86
Biopsy Needle Path Verification - - - - -	11-86
The Biopsy Procedure- - - - -	11-87
Post Biopsy - - - - -	11-88
Probe Biopsy Reprocessing- - - - -	11-89
<b>Chapter 12 — User Maintenance</b>	
<b>System Data</b>	
Features/Specifications - - - - -	12-2
Clinical Measurement Accuracy - - - - -	12-7
<b>Privacy and Security</b>	
Introduction - - - - -	12-14
Privacy & Security Environment - - - - -	12-14
How to contact GE HealthCare - - - - -	12-14
Identity Provisioning - - - - -	12-15
Network Infrastructure - - - - -	12-16
<b>Anti-Virus Software Note</b>	
LOGIQ Totus Security- - - - -	12-17
<b>Loading Windows Patches</b>	
Loading a Windows Patch - - - - -	12-20
Performing Software Patch Verification- - - - -	12-21
Patch Installation Notes- - - - -	12-24
Reloading Software- - - - -	12-24
<b>Software Download</b>	
Overview - - - - -	12-25
<b>Base Image and Software Load</b>	
Base Image and Software Load Procedure - - - - -	12-30
<b>Copyrighted Material</b>	
Viewing Copyrighted Third Party Software License Information- - - - -	12-31
<b>System Care and Maintenance</b>	
Overview - - - - -	12-32
Maintenance Schedule - - - - -	12-33
Cleaning and Disinfecting the System- - - - -	12-34
Other Maintenance - - - - -	12-43
<b>Quality Assurance</b>	
Introduction - - - - -	12-51
Typical Tests to Perform - - - - -	12-52
Baselines- - - - -	12-54
Periodic Checks - - - - -	12-54
Results - - - - -	12-55
System Setup- - - - -	12-55
Test Procedures - - - - -	12-56
Setting up a Record Keeping System - - - - -	12-65
Ultrasound Quality Assurance Checklist - - - - -	12-66
<b>Image Quality Check</b>	
Image Quality Check (IQC) - - - - -	12-67
<b>Assistance</b>	
Supplies/Accessories - - - - -	12-68

---

## Chapter 13 — Advanced Features

### Table of Contents

#### Using 4D

4D Introduction - - - - -	13-4
Features supported with 4D - - - - -	13-4
4D Principles of Operation - - - - -	13-5
4D Operational Controls - - - - -	13-13
4D Presets - - - - -	13-16
Performing a 4D Scan - - - - -	13-17
Tomographic Ultrasound Imaging (TUI) - - - - -	13-41
SonoRenderlive - - - - -	13-45
OmniView - - - - -	13-47
STIC (Spatio-Temporal Image Correlation) - - - - -	13-51

#### Contrast Imaging

Overview - - - - -	13-55
Contrast Imaging Overview - - - - -	13-57
Mode - - - - -	13-59
Contrast MVI Mode - - - - -	13-59
Contrast Presets - - - - -	13-60
Sonazoid™ Contrast Agent - - - - -	13-60
Contrast Controls - - - - -	13-61
Static 3D with Contrast - - - - -	13-66
Time Intensity Curve (TIC) Analysis - - - - -	13-68

#### Strain Elastography

Description - - - - -	13-100
Using Strain Elastography - - - - -	13-101
Clinical Applications - - - - -	13-103
Strain Elastography Controls - - - - -	13-103
Application Parameters - - - - -	13-105
General Imaging Parameters by Application/Probe/Feature - - - - -	13-105

#### Elastography Analysis

Overview - - - - -	13-106
Using Elastography Analysis - - - - -	13-106
Elastography Analysis Display Description - - - - -	13-109
Additional Notes for Elastography Analysis - - - - -	13-110

#### Shear Wave Elastography

Overview - - - - -	13-111
Intended Uses - - - - -	13-113
Configuring Shear Wave - - - - -	13-113
Activating Shear Wave - - - - -	13-117
Shear Wave Display - - - - -	13-118
Shear Wave Touch Panel - - - - -	13-124
Using Shear Wave (SW) - - - - -	13-129
Typical Exam Protocol (Liver) - - - - -	13-130
Shear Wave Measurements - - - - -	13-132
Scanning Hints - - - - -	13-140

<b>Ultrasound-Guided Attenuation Parameter (UGAP) Option</b>	
Overview - - - - -	13-141
Activation - - - - -	13-142
Measurement and Worksheet - - - - -	13-143
2D Color Map - - - - -	13-146
<b>Continuous Wave Doppler (CWD)</b>	
Overview - - - - -	13-147
Steerable - - - - -	13-147
Non-Imaging - - - - -	13-147
Activating CW Doppler - - - - -	13-148
Exiting CW Doppler - - - - -	13-148
<b>Tissue Velocity Imaging (TVI)</b>	
Intended Use - - - - -	13-149
Activating TVI - - - - -	13-149
Optimizing TVI - - - - -	13-150
TVI and TVD - - - - -	13-151
<b>Quantitative Analysis (QAnalysis)</b>	
Overview - - - - -	13-152
Quantitative Flow Analysis - - - - -	13-152
Selecting QAnalysis Image Range - - - - -	13-158
Activating QAnalysis - - - - -	13-158
Common QAnalysis Function - - - - -	13-159
<b>Stress Echo</b>	
Introduction - - - - -	13-172
Getting started with a stress study - - - - -	13-173
Image acquisition - - - - -	13-176
Continuous Capture mode - - - - -	13-182
Analysis - - - - -	13-194
Editing/Creating template - - - - -	13-198
Wall Motion Segment Setup - - - - -	13-205
Utility Application Settings for Protocol - - - - -	13-205
Report - - - - -	13-206
<b>Cardiac Automated Functional Imaging (Cardiac Strain)</b>	
Cardiac Strain - - - - -	13-208
<b>Auto EF</b>	
Auto EF Measurements - - - - -	13-231
Acquisition - - - - -	13-231
Starting AutoEF - - - - -	13-232
Tracking Validation - - - - -	13-233
Possible causes of poor tracking - - - - -	13-233
<b>ECG</b>	
Overview - - - - -	13-238
ECG Cable - - - - -	13-240
Physiological Trace Monitor Display - - - - -	13-241
ECG Touch Panel - - - - -	13-242
<b>Volume Navigation</b>	
Introduction - - - - -	13-244

Load the Volume Dataset - - - - -	13-249
Query/Retrieve - - - - -	13-250
Setting Up V Nav sensors - - - - -	13-258
Activate V-Nav - - - - -	13-262
Using V-Nav- - - - -	13-268
Perform the registration- - - - -	13-270
Advanced GPS Markers - - - - -	13-281
V Nav Trackers- - - - -	13-290
Setting up the V Nav Needle Tip Tracker - - - - -	13-292
V Nav Virtual Tracker (Part of V Nav Option)- - - - -	13-294
Calibrating the V Nav Virtual Tracker - - - - -	13-297
Active Tracker - - - - -	13-298
<b>Breast Productivity Package</b>	
Overview - - - - -	13-302
Breast Lesion M&A - - - - -	13-302
Breast Measure Assistant (Auto Contour) - - - - -	13-305
Breast Assistant, Powered by Koios DS (not available in all countries)- - - - -	13-306
<b>Thyroid Productivity Package</b>	
Overview - - - - -	13-308
Worksheet and Summary Worksheets - - - - -	13-312
Thyroid Assistant, Powered by Koios DS (not available in all countries)- - - - -	13-313
<b>Start Assistant</b>	
Introduction - - - - -	13-315
Start Assistant Mapping Editor - - - - -	13-317
<b>Scan Assistant</b>	
Introduction - - - - -	13-320
Scan Assistant Definitions - - - - -	13-321
Scan Assistant Description - - - - -	13-322
Setting up Scan Assistant - - - - -	13-323
Using Scan Assistant - - - - -	13-325
Exporting Scan Assistant Programs to Another LOGIQ Totus - - - - -	13-329
Scan Assistant Creator - - - - -	13-330
<b>Compare Assistant</b>	
Overview - - - - -	13-358
Workflow example - - - - -	13-360
Setting Up Compare Assistant - - - - -	13-361
<b>OB Measure Assistant</b>	
Overview - - - - -	13-369
<b>Hepatic Assistant</b>	
Overview - - - - -	13-371
Activate Hepatic Assistant - - - - -	13-372
Visualization- - - - -	13-374
<b>Vscan Air™ CL (Option)</b>	
Overview - - - - -	13-378
Install the Vscan Air CL Probe Charger- - - - -	13-383
Charge the Vscan Air CL Probe - - - - -	13-384

Vscan Air CL Battery Indicator - - - - -	13-387
<b>EZ Imaging</b>	
Overview - - - - -	13-398
Activate EZ Touch Panel - - - - -	13-398
Quick Patient Change - - - - -	13-406
<b>Anonymize the patient</b>	
Overview - - - - -	13-407
Anonymize the patient - - - - -	13-408
<b>Report Writer</b>	
Introduction - - - - -	13-409
Creating a report - - - - -	13-410
Activating the Report - - - - -	13-411
Editing a Report - - - - -	13-415
Accessing Worksheet, OB Graph and Anatomical Survey Pages - -	13-428
Storing the Report - - - - -	13-428
Retrieving an Archived Report - - - - -	13-428
Deleting a Report from Archive - - - - -	13-429
Printing the Report - - - - -	13-429
Exporting the Report to Media - - - - -	13-430
Exiting the report - - - - -	13-430
Designing Your Own Template - - - - -	13-431
Direct Report - - - - -	13-456
Report Presets - - - - -	13-460
<b>Configuring DICOM</b>	
Overview - - - - -	13-466
DICOM Job Spooler - - - - -	13-467
Patient Menu DICOM Functionality - - - - -	13-468
Troubleshooting DICOM Connectivity Issues - - - - -	13-469
<b>Configuring the Wireless Network</b>	
Wireless LAN (WLAN) - - - - -	13-470
Wireless LAN (WLAN) Specifications - - - - -	13-471
Connecting to the WLAN - - - - -	13-473
Network and Spooler Status Icons - - - - -	13-474
Adding a Wireless Network - - - - -	13-475
Removing a WLAN - - - - -	13-476
Customizing Wireless Network Settings - - - - -	13-477
Setting an IP Address - - - - -	13-478
Refreshing a WLAN - - - - -	13-479
Managing Connectivity to a Wireless Network - - - - -	13-479
Monitoring the WLAN - - - - -	13-479
WLAN Diagnostics - - - - -	13-480
Repairing the WLAN - - - - -	13-480
Available WLAN Channels - - - - -	13-481
Disconnecting from the WLAN - - - - -	13-481
<b>Tricefy Uplink</b>	
Introduction - - - - -	13-482
Uploading Exam Information to the Tricefy Cloud - - - - -	13-484
Tricefy Icons - - - - -	13-487

---

Tricefy Activation - - - - -	13-487
<b>Device Mgmt</b>	
Overview - - - - -	13-488
Upload For Fleet and Manual Backup (Cloud Backup) - - - - -	13-490
Backup Automatically (Local and Cloud Backup) - - - - -	13-491
Manual Backup (Cloud Backup) - - - - -	13-491
Assign Configuration to Fleet or to the Device (on Cloud) - - - - -	13-492
Receive Installation Notification - - - - -	13-493
Installation Dialog - - - - -	13-494
Detailed Restore from Cloud - - - - -	13-501
Cancel a Failed Job - - - - -	13-503
Icon and Notification - - - - -	13-504
<b>Smart Device Apps</b>	
LOGIQ Apps - - - - -	13-505
<b>Digital Expert</b>	
Digital Expert Remote Training - - - - -	13-515
<b>Service and Applications Support</b>	
GE HealthCare Connect Guide - - - - -	13-516
Support Requests - - - - -	13-520
<b>Service Desktop</b>	
Overview - - - - -	13-525
Accessing the Service Desktop - - - - -	13-525
<b>Battery Power Mode</b>	
Overview - - - - -	13-526
Scan on Battery Option (ScoB) - - - - -	13-527
View current battery status - - - - -	13-531
Battery charging - - - - -	13-534
Refreshing the battery - - - - -	13-535
Battery deterioration - - - - -	13-536
Battery Disposal - - - - -	13-536
<b>Magstripe Card Reader</b>	
Magstripe Magnetic Card Reader - - - - -	13-537
<b>Footswitch</b>	
Wired Footswitch - - - - -	13-538
<b>DVR</b>	
Setting up the DVR - - - - -	13-539
Using the DVR - - - - -	13-540
<b>Auto Preset Assistant</b>	
- - - - -	13-545
Auto Abdominal Color Assistant - - - - -	13-552
<b>Voice Control</b>	
Set up Voice Control - - - - -	13-558
Start Voice Control - - - - -	13-559
Command Set - - - - -	13-560
Stop Voice Control - - - - -	13-562
Change Voice Control settings - - - - -	13-563

---

**Data Streaming (Option)**

User Setup for Data Streaming - - - - -	13-566
Enable Data Streaming - - - - -	13-567
Enable Data Streaming - - - - -	13-568
Data Streaming in Process - - - - -	13-569

**Index**



---

# Chapter 1

## Introduction

*This chapter consists of information concerning indications for use/contraindications, contact information and how this documentation is organized.*

# System Overview

## Attention

This manual contains necessary and sufficient information to operate the system safely. Advanced equipment training may be provided by a factory trained Applications Specialist for the agreed-upon time period.

Read and understand all instructions in this manual before attempting to use the LOGIQ Totus system.

Keep this manual with the equipment at all times. Periodically review the procedures for operation and safety precautions.

Disregarding information on safety is considered abnormal use.

Not all features, products, probes, or peripherals described in this document may be available or cleared for sale in all markets. Please contact your local GE HealthCare Ultrasound representative to get the latest information.

*NOTE: Please note that orders are based on the individually agreed upon specifications and may not contain all features listed in this manual.*

*NOTE: All references to standards / regulations and their revisions are valid at the time of publication of the user manual.*

## Documentation

Safety instructions must be reviewed before operating the system.

The LOGIQ Totus manuals are written for users who are familiar with basic ultrasound principles and techniques. They do not include sonographic training or detailed clinical procedures.

Documentation is provided in the following ways:

- Online Help PDFs viewable on the system
- Offline PDFs viewable on a Windows PC
- PDFs on the internet at the GE HealthCare Customer Documentation Portal
- Paper copies (orderable via H-Cat)

Table 1-1: Documentation

Publication	Translated	Available via F1 (Online help using F1 key on system)	Available via Media in the eIFU Kit	Available on Paper (if purchased via H-Cat)
User Manual Provides information needed by the user to operate the system safely.	Yes (all required languages)	Yes	Yes	Yes
Release Notes Provides precautions and instructions that supplement the Basic User Manual	Yes	No	Yes	Yes
Advanced Reference Manual Provides Acoustic Output Data and System Measurement and Analysis Tables and Formulas.	English and French	No	Yes	Yes
Privacy and Security Manual Describes Privacy and Security considerations and capabilities, and how they may be configured and used appropriately on the system.	Yes (all required languages)	No	No	No

### Documentation (continued)

*NOTE: An AIUM Booklet is shipped with systems shipped in the United States and Canada.*

*NOTE: Dates on screenshots are represented in MM/DD/YYYY format throughout the manual. Information on how to change the system's date can be found in Customizing Your System.*

*NOTE: The screen graphics in this manual are only for illustrational purposes. Actual screen output may differ.*

*NOTE: The Basic Service Manual referenced in this manual is part number 5936427. The latest version of the Service Manual is available at: <https://www.gehealthcare.com/support/documentation>*

### Online Help PDFs

Online Help PDFs are available on the system by pressing the F1 key or via the eIFU icon on the second Utility Page.

### Viewing Online Help in a Language Different from the System Language

On the Utility > System > General Preset page, select the language you wish to view Online Help with from the Online Help Language dropdown selections.

If the translated Online Help is not available, the default language (English) is viewable.

Translated Online Help files can be updated via the eIFU USB Flash Drive provided with the ultrasound system in the eIFU Kit. To order another kit, contact your GE HealthCare Representative.

## Electronic Media

### Offline PDFs

To view user documentation PDFs on a Windows PC,

1. Insert the media into the media drive.
2. Open the media drive on your desktop.
3. Double click the HTML document for the ultrasound system.
4. Select the item you want to view (click on the blue, underlined link in the File Name column).

To close the window, click on the 'X' in the upper, right-hand corner of the browser window.

*NOTE: If your PC does not have Adobe Reader, a free download is available on the Adobe website at <http://www.adobe.com>.*

### Updating Documentation on the Ultrasound Scanner Via the USB

The latest version of the Online Help is located on the USB flash drive. To update to the latest version:

1. Power down the ultrasound system and insert the eIFU USB flash drive into a rear USB port.

**NOTE:** *Ensure that the system is USB Device Enabled (check setting on System Admin Utility Page).*

2. Power on the ultrasound system and follow the screen prompts.
  - a. Select Install SW ... on the Start Application screen.
  - b. Select OK on the first StartLoader screen.
  - c. Select the package and then select Install on the second StartLoader screen; software installation begins. After "Installation has completed" message appears and system restarts, remove USB flash drive.
  - d. As you verify each feature works correctly, select "Passed." If all features work correctly and "Passed" is selected for all features, the signature field is enabled at the bottom of the New Software Verification Checklist. Type your signature (minimum of three characters) and press OK. The system is now ready for use.

**NOTE:** *You can search through a document, use hyperlinks in the Table of Contents and Index to locate topics, and navigate via bookmarks.*

**NOTE:** *In addition to viewing documentation on the Ultrasound system, the Documentation media can be read on any PC.*

To exit, press the 'X' in the upper, right-hand corner of the documentation window.

### Viewing Online Help in a Language Different from the System Language

On the Utility > System > General Preset page, select the language you wish to view Online Help with from the Online Help Language dropdown selections

If the translated Online Help is not available, the default language (English) is viewable.

Translated Online Help files can be updated via the eIFU USB Flash Drive provided with the ultrasound system in the eIFU Kit. To order another kit, contact your GE HealthCare Representative.

## **Online Customer Documentation Portal**

Documentation is available in the Customer Documentation Portal on the internet at the GE HealthCare Support Documentation Library at:

<https://www.gehealthcare.com/documentation>

Navigate to the Customer Documentation Portal on the website and enter the following information to search for the desired manual:

- Document Number

OR

- Modality
- Product(s)
- Document Type
- Keyword

You can download the desired manual from the website or copy the manual url to share the link.

## **Paper Documentation**

Paper manuals can be ordered via H-Cat.

### Principles of Operation

Medical ultrasound images are created by computer and digital memory from the transmission and reception of mechanical high-frequency waves applied through a transducer. The mechanical ultrasound waves spread through the body, producing an echo where density changes occur. For example, in the case of human tissue, an echo is created where a signal passes from an adipose tissue (fat) region to a muscular tissue region. The echoes return to the transducer where they are converted back into electrical signals.

These echo signals are highly amplified and processed by several analog and digital circuits having filters with many frequency and time response options, transforming the high-frequency electrical signals into a series of digital image signals which are stored in memory. Once in memory, the image can be displayed in real-time on the image monitor. All signal transmission, reception and processing characteristics are controlled by the main computer. By selection from the system control panel, the user can alter the characteristics and features of the system, allowing a wide range of uses, from obstetrics to peripheral vascular examinations.

Transducers are accurate, solid-state devices, providing multiple image formats. The digital design and use of solid-state components provides highly stable and consistent imaging performance with minimal required maintenance. Sophisticated design with computer control offers a system with extensive features and functions which is user-friendly and easy to use.



## Indications for Use

The LOGIQ Totus is intended to be used in a hospital, medical clinic and private practice office.

## US Indications for Use Statement

The LOGIQ Totus is a general purpose diagnostic ultrasound system intended for use by qualified and trained healthcare professionals for ultrasound imaging, measurement, display and analysis of the human body and fluid. LOGIQ Totus clinical applications include : Fetal / Obstetrics; Abdominal (including Renal, Gynecology/Pelvic); Pediatric; Small Organ (Breast, Testes, Thyroid); Neonatal Cephalic; Adult Cephalic; Cardiac (Adult and Pediatric); Peripheral Vascular; Musculo-skeletal Conventional and Superficial; Urology (including Prostate); Transrectal; Transvaginal.

Modes of operation include: B, M, PW Doppler, CW Doppler, Color Doppler, Color M Doppler, Power Doppler, Harmonic Imaging, Coded Pulse, 3D/4D Imaging mode, Elastography, Shear Wave Elastography, Attenuation Imaging, Contrast Enhanced Imaging and Combined modes: B/M, B/Color, B/PWD, B/Color/PWD, B/Power/PWD.

## Operator Profile

- Qualified and trained Healthcare professionals, including physicians, sonographers and equivalent/compareable professions, with at least basic ultrasound knowledge.
- The operator must have read and understood the user manual.

*NOTE: Only qualified physicians or sonographers should perform ultrasound scanning on human subjects for medical diagnostic reasons. Request training, if needed.*

## Types of use

multiple patients, multiple use

## Frequency of Use

Daily (Typically 8 hours)

## Contraindication

The LOGIQ Totus ultrasound system is not intended for ophthalmic use or any use causing the acoustic beam to pass through the eye.

## Prescription Device



CAUTION: United States law restricts this device to sale or use by, or on the order of a physician.

## Clinical Benefit (System and Probes)

The clinical benefit of a diagnostic ultrasound device and probe is to help healthcare professional provide accurate diagnostic information (visualize human tissue/internal structure) that enhances the diagnostic and treatment care pathways of the patient for a variety of diseases and conditions.

## Patient Population

- Age: all ages (including embryos and fetuses)
- Location: worldwide
- Sex: male and female
- Weight: all weight categories
- Height: no limitations

*NOTE: Extreme obesity may affect operation of the device*



WARNING

Do not cross-use the ultrasound system between human and veterinary/animal use.

## Use Environment

The system is intended to be used in the following environments: Intensive Care Unit(ICU, CVICU, CCU), Neonatal Intensive Care Unit(NICU), Pediatric Intensive Care Unit(PICU), Emergency Room, Operating Room, Outpatient Surgery Clinic, Radiology, Medical Office(Nurse Practitioner), Observational Units, Cath Lab, Clinic, Physician's Office, Labor/Deliver Unit and Oncology.

## Potential additional considerations of use environment

- Room Size: 8' x 10' (exam room)
- Power: AC outlet operation
- Lighting: dim(exam room) to bright(operating room)
- Noise: low(exam room) to high(emergency room)
- Other devices in environment: EMR PC, exam lights, exam table, sink, supplies for performing the ultrasound procedure, additional equipment in the ER or operating room(life-saving devices, instruments/tools, monitors), treadmill(for cardiac exams).
- Other environmental conditions: Level of stress on the operator: low to high, Barriers between the operator and the product: gloves typically worn during an examination, Sterility: may be used in a sterile environment, Entry and Exit: minimum one standard entry door.

## System Environmental Requirements

Table 1-2: System Environmental Requirements

	Operational	Storage	Transport (<16hrs.)
Temperature	10° - 35°C/50° - 95°F with 2D probe 18° - 30°C/64.4° - 86°F with 4D probe	-10° - 50°C 14° - 122°F	-10° - 50°C 14° - 122°F
Humidity	30 - 80% non-condensing	10 - 90% non-condensing	10 - 90% non-condensing
Pressure	700 - 1060hPa	700 - 1060hPa	700 - 1060hPa

# Contact Information

## Contacting GE HealthCare Ultrasound

For additional information or assistance, please contact your local distributor or the appropriate support resource listed on the following pages:

### INTERNET

<http://www.gehealthcare.com>

<https://www.gehealthcare.com/transducers>

### Clinical Questions

For information in the United States, Canada, Mexico and parts of the Caribbean, call the Customer Answer Center.

TEL: (1) 800-682-5327 or (1) 262-524-5698

In other locations, contact your local Applications, Sales, or Service Representative.

### Service Questions

For service in the United States, call GE HealthCare CARES.

TEL: (1) 800-437-1171

In other locations, contact your local Service Representative.

### Information Requests

To request technical product information in the United States, call GE HealthCare.

TEL: (1) 800-643-6439

In other locations, contact your local Applications, Sales, or Service Representative.

### Placing an Order

To order accessories, supplies, or service parts in the United States, call the GE HealthCare Technologies Contact Center.

TEL: (1) 800-558-5102

In other locations, contact your local Applications, Sales, or Service Representative.

**Contacting GE HealthCare Ultrasound (continued)**

Table 1-3: Americas

ARGENTINA	GE Healthcare Argentina Nicolas de Vedia 3616 piso 5 Buenos Aires - 1307	TEL: (+54) 11-5298-2200
BRAZIL	GE Healthcare do Brasil Comércio e Serviços para Equipamentos Médicos - Hospitalares Ltda. Av. Magalhães de Castro, 4800, Andar 11 Conj. 111 e 112, Andar 12 Conj. 121 e 122, Torre 3 - Cidade Jardim - CEP: 05676-120 - São Paulo/SP - Brasil CNPJ : 00.029.372/0001-40 Responsável Técnico: Renata Bellentani Brandão - CRF/SP nº 36.198	TEL: 3004 2525 (Capitals and Metropolitan Regions)  08000 165 799 (Other Locations)
CANADA	GE Ultrasound 9900 Innovation Drive Wauwatosa, WI 53226	TEL: (1) 800-668-0732  Customer Answer Center TEL: (1) 262-524-5698
LATIN & SOUTH AMERICA	GE Ultrasound 9900 Innovation Drive Wauwatosa, WI 53226	TEL: (1) 262-524-5300  Customer Answer Center TEL: (1) 262-524-5698
MEXICO	GE Sistemas Medicos de Mexico S.A. de C.V. Rio Lerma #302, 1º y 2º Pisos Colonia Cuauhtemoc 06500-Mexico, D.F.	TEL: (5) 228-9600 FAX: (5) 211-4631
USA	GE Ultrasound 9900 Innovation Drive Wauwatosa, WI 53226	TEL: (1) 800-437-1171 FAX: (1) 414-721-3865

Table 1-4: Asia

ASIA PACIFIC JAPAN	GE Healthcare Asia Pacific 4-7-127, Asahigaoka Hinoshi, Tokyo 191-8503, Japan	TEL: +81 42 585 5111
AUSTRALIA	32 Phillip Street Parramatta 2150 Sydney, NSW, Australia	TEL: 1800 659 465
CHINA	GE Healthcare - Asia No. 1, Yongchang North Road Beijing Economic & Technology Development Area Beijing 100176, China	TEL: (8610) 5806 8888 FAX: (8610) 6787 1162 Service: 4008128188 (24h)
INDIA	Wipro GE Healthcare Pvt Ltd No. 4, Kadugodi Industrial Area Sadaramangala, Whitefield Bangalore, 560067	TEL: +(91) 1-800-425-8025

Table 1-4: Asia (Continued)

KOREA	15F, 416 Hangang Dae ro, Chung-gu Seoul 04637, Korea	TEL: +82 2 6201 3114
NEW ZEALAND	Level 7 Vero Centre 48 Shortland St, Auckland, 1010 New Zealand	TEL: 0800 659 465
SINGAPORE	GE Healthcare ASEAN (Singapore) 11 North Buona Vista Drive #11-07 The Metropolis Tower 2 Singapore 138589	TEL: +65 6291 8528 FAX: +65 6291 7006

Table 1-5: Africa

EGYPT	GE Medical Systems Egypt, LLC Plot 44 Tesseen El Shamaly Street Al Salam Axis First Sector City Centre, 5th settlement Cairo, Egypt	TEL: +20 2 25354200 FAX: +20 2 25370031
KENYA	GE East Africa Services Limited General Mathenge Drive, Courtyard Building Westlands Nairobi 30 00100 KE	TEL: +254 719 093 044
NIGERIA	GE International Operations (Nig) Ltd Bishop Aboyade Cole Street No. 927/928 Mansard Place, PO Box 54255 Victoria Island Lagos LA NG	TEL: +234 (01) 4607101 TEL: +234 (01) 4607102
KINGDOM OF SAUDI ARABIA	GE Healthcare Arabia Co. Ltd Platinum Centre, Building 1 Salahuddin Ayoubi Road Riyadh-12811 Kingdom of Saudi Arabia	TEL: +966 (11) 494 5779 FAX: +966 (11) 207 3946
SOUTH AFRICA	General Electric South Africa (Pty) Ltd. 60 Glenhove Road Green on Glenhove Customer Innovation Centre Johannesburg GP 2196 ZA	TEL: +270100725000 FAX: +27 0862958385

Table 1-6: Europe

AUSTRIA	GE Healthcare Austria GmbH & Co OG EURO PLAZA, Gebäude E Technologiestrasse 10 A-1120 Vienna	TEL: (+43) 1 97272 0 FAX: (+43) 1 97272 2222
BELGIUM & LUXEMBURG	GE Healthcare BVBA/SPRL Kouterveldstraat 20 1831 DIEGEM	TEL: (+32) 2 719 7204 FAX: (+32) 2 719 7205

Table 1-6: Europe (Continued)

CZECH REPUBLIC	GE Medical Systems Česká Republika, s.r.o. Bucharova 2641/14 158 00 Praha 5 Česká republika	TEL: (+420) 224 446 162 FAX: (+420) 224 446 161
DENMARK	GE Healthcare Park Allè 295 DK-2605 Brøndby, Denmark	TEL: (+45) 43 295 400 FAX: (+45) 43 295 399
ESTONIA & FINLAND	GE Healthcare Finland Oy Kuortaneenkatu 2, 000510 Helsinki P.O.Box 330, 00031 GE Finland	TEL: (+358) 10 39 48 220 FAX: (+358) 10 39 48 221
FRANCE	GE Medical Systems SCS Division Ultrasound 24 Avenue de l'Europe - CS20529 78457 Vélizy Villacoublay Cedex	TEL: (+33) 1 34 49 52 70 FAX: (+33) 13 44 95 202
GERMANY	GE Healthcare GmbH Beethovenstrasse 239 42655 Solingen	TEL: (+49) 212-28 02-0 FAX: (+49) 212-28 02-380
GREECE	GE Healthcare 8-10 Sorou Str. Marousi Athens 15125 Hellas	TEL: (+30) 210 8930600 FAX: (+30) 210 9625931
HUNGARY	GE Hungary Zft. Bence utca 3 Budapest BU 1138 HU	TEL: (+36) 23 410 314 FAX: (+36) 23 410 390
IRELAND	NORTHERN IRELAND GE Healthcare Victoria Business Park 9, Westbank Road Belfast BT3 9JL.  REPUBLIC OF IRELAND GE Healthcare 3050 Lake Drive Citywest Business Campus Dublin 24	TEL: (+44) 028 90229900      TEL: 1800 460 550 FAX: (+353) 1 686 5327
ITALY	GE Medical Systems Italia spa Via Galeno, 36, 20126 Milano	TEL: (+39) 02 2600 1111 FAX: (+39) 02 2600 1417
KAZAKHSTAN	«Дженерал Электрик Қазақстан» ЖШС Қазақстан, Алматы қаласы 050040, Тимирязев көшесі, 28В ү., 307 кеңсе.	T +7 727 3560020
LUXEMBORG	See Belgium.	
NETHERLANDS	GE Healthcare De Wel 18 B, 3871 MV Hoevelaken PO Box 22, 3870 CA Hoevelaken	TEL: (+31) 33 254 1290 FAX: (+31) 33 254 1292

Table 1-6: Europe (Continued)

NORWAY	GE Vingmed Ultrasound AS Sandakerveien 100C 0484 Oslo, Norway	TEL: (+47) 23 18 50 50 FAX: (+47) 23 18 60 35
	GE Vingmed Ultrasound Strandpromenaden 45 P.O. Box 141, 3191 Horten	TEL: (+47) 33 02 11 16
POLAND	GE Medical Systems Polska Sp. z o.o., ul. Woloska 9 02-583 Warszawa, Poland	TEL: (+48) 22 330 83 00 FAX: (+48) 22 330 83 83
PORTUGAL	General Electric Portuguesa SA Avenida do Forte 6 - 6A Edifício Ramazzotti 2790-072 CARNAXIDE	TEL: (+351) 21 425 1300 FAX: (+351) 21 425 1343
RUSSIA	GE Healthcare Presnenskaya nab. 10 Block C, 12 floor 123317 Moscow, Russia	TEL: (+7) 4957 396931 FAX: (+7) 4957 396932
SPAIN	GE Healthcare España C/ Gobelos 35-37 28023 Madrid	TEL: (+34) 91 663 2500 FAX: (+34) 91 663 2501
SWEDEN	GE Healthcare Sverige AB FE 314, 182 82 Stockholm Besöksadr: Vendeavagen 89 Danderyd, Sverige	TEL: (+46) 08 559 500 10 FAX: (+46) 08 559 500 15 Service Center (+46) 020-120 14 36
SWITZERLAND	GE Medical Systems (Schweiz) AG Europastrasse 31 8152 Glattbrugg	TEL: (+41) 1 809 92 92 FAX: (+41) 1 809 92 22
TURKEY	GE Healthcare Türkiye Istanbul Office Levent Ofis Esentepe Mah. Harman Sok. No:8 Sisli-Istanbul	TEL: +90 212 398 07 00 FAX: +90 212 284 67 00
UNITED ARAB EMIRATES (UAE)	GE Healthcare Dubai Internet City, Building No. 18 First Floor, Dubai - UAE	TEL: (+971) 4 429 6101 or 4 429 6161 FAX: (+971) 4 429 6201
UNITED KINGDOM	GE Medical Systems Ltd Pollards Wood Nightingales Lane Chalfont St Giles Buckinghamshire HP8 4SP	TEL: (+44) 1494 544000 FAX: (+44) 1707 289742
For all other European countries not listed, please contact your local GE HealthCare distributor or the appropriate support resource listed on <a href="http://www.gehealthcare.com">www.gehealthcare.com</a> .		



## Manufacturer



GE Ultrasound Korea, Ltd.  
9, Sunhwan-ro 214beon-gil, Jungwon-gu, Seongnam-si,  
Gyeonggi-do, 13204  
Republic of Korea



---

# Chapter 2

# Safety

*Describes the safety and regulatory information pertinent for operating this ultrasound system.*

# Owner Responsibility

## Owner requirements

It is the responsibility of the owner to ensure that anyone operating the system reads and understands this section of the manual. However, there is no representation that the act of reading this manual renders the reader qualified to operate, inspect, test, align, calibrate, troubleshoot, repair or modify the system. The owner should make certain that only properly trained, fully-qualified service personnel undertake the installation, maintenance, troubleshooting, calibration and repair of the equipment.

The owner of the ultrasound unit should ensure that only properly trained, fully qualified personnel are authorized to operate the system. Before authorizing anyone to operate the system, it should be verified that the person has read, and fully understands, the operating instructions contained in this manual. It is advisable to maintain a list of authorized operators.

Should the system fail to operate correctly, or if the unit does not respond to the commands described in this manual, the operator should contact the nearest field GE HealthCare Ultrasound Service Office.

For information about specific requirements and regulations applicable to the use of electronic medical equipment, consult the local, state and federal agencies.

### ***For USA only***

Federal law restricts this device to use by, or on the orders of, a physician.

## Notice against user modification

Never modify this product, including system components, software, cables, and so on. User modification may cause safety hazards and degradation in system performance. All modification must be done by a GE HealthCare qualified person.

## **Reporting**

In the case of a serious incident occurring in relation to LOGIQ Totus ultrasound products, the incident should be reported to GE HealthCare and the competent Authority.

# Safety Precautions

## Precaution Levels

### Icon description

Various levels of safety precautions may be found on the equipment and different levels of concern are identified by one of the following flag words and icons which precede the precautionary statement.



DANGER

Indicates that a specific hazard is known to exist which through inappropriate conditions or actions will cause:

- Severe or fatal personal injury



WARNING

Indicates that a specific hazard is known to exist which through inappropriate conditions or actions may cause:

- Minor personal injury
- Substantial property damage



CAUTION

Indicates that a potential hazard may exist which through inappropriate conditions or actions will or can cause:

- Property damage

**NOTE:** *Substantial property damage is defined as system requires service to function.*

**NOTE:** *Indicates precautions or recommendations that should be used in the operation of the ultrasound system, specifically:*







- *Maintaining an optimum system environment*
- *Using this Manual*
- *Notes to emphasize or clarify a point.*

## Hazard Symbols

### Icon Description

Potential hazards are indicated by the following icons:

Table 2-1: Potential Hazards

Icon	Potential Hazard	Usage
	<p><b>Biological Hazard</b> Describes precautions necessary to prevent the risk of disease transmission or infections.</p> <ul style="list-style-type: none"> <li>• Patient/user infection due to contaminated equipment.</li> </ul>	<ul style="list-style-type: none"> <li>• Cleaning and care instructions</li> <li>• Sheath and glove guidelines</li> </ul>
	<p><b>Electrical Hazard</b> Describes precautions necessary to prevent the risk of injury through electric hazards.</p> <ul style="list-style-type: none"> <li>• Electrical micro-shock to patient, e.g., ventricular</li> </ul>	<ul style="list-style-type: none"> <li>• Probes</li> <li>• ECG, if applicable</li> <li>• Connections to back panel</li> </ul>
	<p><b>Moving Hazard</b> Describes precautions necessary to prevent the risk of injury through moving or tipping hazard!</p> <ul style="list-style-type: none"> <li>• Console, accessories or optional storage devices that can fall on patient, user, or others.</li> <li>• Collision with persons or objects may result in injury while maneuvering or during system transport.</li> <li>• Injury to user from moving the console.</li> </ul>	<ul style="list-style-type: none"> <li>• Moving</li> <li>• Using brakes</li> <li>• Transporting</li> </ul>
	<p><b>Acoustic Output Hazard</b></p> <ul style="list-style-type: none"> <li>• Patient injury or tissue damage from ultrasound radiation.</li> </ul>	<ul style="list-style-type: none"> <li>• ALARA, the use of Power Output following the 'as low as reasonably achievable' principle</li> </ul>
	<p><b>Explosion Hazard</b> Describes precautions necessary to prevent the risk of injury through explosion hazard!</p> <ul style="list-style-type: none"> <li>• Risk of explosion if used in the presence of flammable anesthetics.</li> </ul>	<ul style="list-style-type: none"> <li>• Flammable anesthetic</li> </ul>
	<p><b>Fire and Smoke Hazard</b></p> <ul style="list-style-type: none"> <li>• Patient/user injury or adverse reaction from fire or smoke.</li> <li>• Patient/user injury from explosion and fire.</li> </ul>	<ul style="list-style-type: none"> <li>• Replacing fuses</li> <li>• Outlet guidelines</li> </ul>

### Important Safety Considerations

The following topic headings (Patient Safety, and Equipment and Personnel Safety) are intended to make the equipment user aware of particular hazards associated with the use of this equipment and the extent to which injury can occur if precautions are not observed. Additional precautions may be provided throughout the manual.



#### DANGER

Improper use can result in serious injury. The use of the system outside the described conditions or intended use, and disregarding safety related information is considered abnormal use. The user must be thoroughly familiar with the instructions and potential hazards involving ultrasound examination before attempting to use the device. Training assistance is available from GE HealthCare if needed.

Disregarding information on safety is considered abnormal use.

Following are potential risks inherent to technology:

- Ultrasonic energy delivered to non-targeted tissue with the use of Ultrasound devices, and the interaction of sound energy with tissue at sufficiently high levels can produce biological effects.
- Monitoring the Mechanical Index (MI) can be a tool to help monitor the probability that cavitation could occur.



## Patient Safety

### Related Hazards



#### WARNING

The concerns listed can affect the safety of patients undergoing a diagnostic ultrasound examination.

### Patient identification

Always include proper identification with all patient data and verify the accuracy of the patient's name and ID numbers when entering such data. Make sure correct patient ID is provided on all recorded data and hard copy prints. Identification errors could result in an incorrect diagnosis.

The ultrasound system is not meant to be long term storage for patient data or images. The customers are responsible for the data on the system and a regular backup is highly recommended.

It is advisable to back up system data prior to any service repairs to the hard drive. It is always possible during system failure and repair to lose patient data. GE HealthCare will not be held responsible for the loss of this data.

### Diagnostic information

The images and calculations provided by the system are intended for use by competent users, as a diagnostic tool. They are explicitly not to be regarded as the sole, irrefutable basis for clinical diagnosis. Users are encouraged to study the literature and reach their own professional conclusions regarding the clinical utility of the system.

The user should be aware of the product specifications and of the system accuracy and stability limitations. These limitations must be considered before making any decision based on quantitative values. If in doubt, the nearest GE HealthCare Ultrasound Service Office should be consulted.

Equipment malfunction or incorrect settings can result in measurement errors or failure to detect details within the image. The equipment user must become thoroughly familiar with the equipment operation in order to optimize its performance and recognize possible malfunctions. Applications training is available through the local GE HealthCare representative. Added confidence in the equipment operation can be gained by establishing a quality assurance program.



#### WARNING

The system provides calculations (e.g. estimated fetal weight) and charts based on published scientific literature. The selection of the appropriate chart and clinical interpretation of calculations and charts is the sole responsibility of the user. The authorized user should consider proper indications for the use of a calculation or chart as described in the scientific literature. The diagnosis, decision for further examination, and medical treatment must be performed by qualified personnel following good clinical practice.



#### CAUTION

Features that facilitate measurements such as VOCAL or SonoNT must be used with extreme care. The measurement results are a suggestion of the system, if in doubt verify with manual measurement methods.

The user is responsible for the diagnostic interpretation of the measurement results.

## Mechanical hazards

The use of damaged probes or improper use and manipulation of intracavity probes can result in injury or increased risk of infection. Inspect probes often for sharp, pointed, or rough surface damage that could cause injury or tear protective barriers.

The use of damaged probes can result in injury or increased risk of infection. Inspect probes often for sharp, pointed, or rough surface damage that could cause injury or tear protective barriers.



Electrical  
Hazard

A damaged probe can also increase the risk of electric shock if conductive solutions come in contact with internal live parts. Inspect probes often for cracks or openings in the housing and holes in and around the acoustic lens or other damage that could allow liquid entry. Become familiar with the probe's use and care precautions outlined in *Probes and Biopsy*.



DANGER

Ultrasound transducers are sensitive instruments which can easily be damaged by rough handling. Take extra care not to drop transducers and avoid contact with sharp or abrasive surfaces. A damaged housing, lens or cable can result in patient injury or serious impairment or operation.

### ALARA



#### DANGER

Ultrasound can produce harmful effects in tissue and potentially result in patient injury. Always minimize exposure time and keep ultrasound levels low when there is no medical benefit. Use the principle of ALARA (As Low As Reasonably Achievable), increasing output only when needed to obtain diagnostic image quality. Observe the acoustic output display and be familiar with all controls affecting the output level. See the *Bioeffects* section of the *Acoustic Output* chapter in the *Advanced Reference Manual* for more information.

### Training

It is recommended that all users receive proper training in applications before performing them in a clinical setting. Please contact the local GE HealthCare representative for training assistance.

ALARA training is provided in the Medical Ultrasound Safety booklet shipped in the eDOCs kit. The ALARA education program for the clinical end-user covers basic ultrasound principles, possible biological effects, the derivation and meaning of the indices, ALARA principles, and examples of specific applications of the ALARA principle.

## Equipment and Personnel Safety

The concerns listed in the Related Hazards section can seriously affect the safety of equipment and personnel during a diagnostic ultrasound examination.

### Related Hazards



DANGER

This equipment contains dangerous voltages that are capable of serious injury or death.

If any defects are observed or malfunctions occur, stop operating the equipment and perform the proper action for the patient. Inform a qualified service person and contact a Service Representative for information.

There are no user serviceable components inside the console. Refer all servicing to qualified service personnel only.

Ensure that unauthorized personnel do not tamper with the unit.



Electrical  
Hazard

To avoid injury:

- Do not remove protective covers. No user serviceable parts are inside. Refer servicing to qualified service personnel.
- To assure adequate grounding, connect the attachment plug to a reliable (hospital grade) grounding outlet (having equalization conductor  $\downarrow$  ).
- Never use any adaptor or converter of a three-prong-to-two-prong type to connect with a mains power plug. The protective earth connection will loosen.
- Do not place liquids on or above the console. Spilled liquid may contact live parts and increase the risk of shock.
- In North America, a 220-240V installation requires the use of a center-tapped AC power source.

### Related Hazards (continued)



#### DANGER

The concerns listed below can seriously affect the safety of equipment and personnel during a diagnostic ultrasound examination.



#### Explosion Hazard

Risk of explosion if used in the presence of flammable anesthetics.

Never operate the equipment in the presence of flammable or explosive liquids, vapors or gases. Malfunctions in the unit, or sparks generated by fan motors, can electrically ignite these substances. Operators should be aware of the following points to prevent such explosion hazards.

- If flammable substances are detected in the environment, do not plug in or turn on the system.
- If flammable substances are detected after the system has been turned on, do not attempt to turn off the unit, or to unplug it.
- If flammable substances are detected, evacuate and ventilate the area before turning off the unit.



#### Smoke & Fire Hazard

The system must be supplied from an adequately rated electrical circuit. The capacity of the supply circuit must be as specified.



#### DANGER

#### Biological Hazard

For patient and personnel safety, be aware of biological hazards while performing invasive procedures. To avoid the risk of disease transmission:

- Use protective barriers (gloves and probe sheaths) whenever possible. Follow sterile procedures when appropriate.
- Thoroughly clean probes and reusable accessories after each patient examination and disinfect or sterilize as needed. Refer to *Probes and Biopsy* for probe use and care instructions.
- Follow all infection control policies established by your office, department or institution as they apply to personnel, equipment and accessories.

Related Hazards (continued)



DANGER

Do not unpack the LOGIQ Totus. This must be performed by qualified service personnel only. Improper unpacking could lead to injury.



DANGER

GE HealthCare recommends dedicated probes for use on humans only or animals only. Mark probes dedicated for animals with special labels.

Observe any country specific rules and regulations for handling equipment used on both animals and humans. Such national restrictions may prohibit transfer of probes used on animals to humans and vice-versa.

Failure to follow these instructions could lead to exposure to infectious agents.



WARNING

- Make sure to verify the media after writing data, such as EZBackup, SaveAs or Export.
- Before deleting a patient or image from the patient screen, make sure you have saved the data by EZBackup/Backup or Export and verify that the media data transfer was successful. Not following the instructions could result in the loss of data requiring a rescan.



WARNING

When you move the Control Panel up/down with the monitor, place BOTH hands on the Control Panel. Touching other moving parts other than the Control Panel may cause personal injury.



WARNING

Contact with natural rubber latex may cause a severe anaphylactic reaction in persons sensitive to the natural latex protein. Sensitive users and patients must avoid contact with these items.



WARNING

The LOGIQ Totus is not intended to be used as a data storage device; backup of the Patient and Image Database is your institution's responsibility. GE HealthCare is NOT responsible for any lost patient information or for lost images. Loss of image data may require a rescan.

**Related Hazards (continued)**



WARNING

To minimize accidental loss of data, perform EZBackup and Backup on a regular basis.

1. First, perform EZBackup to save the images.
2. Next, perform Backup at Utility -> Backup/Restore. Enable the following checkboxes under Backup:
  - User defined configuration
  - Service



CAUTION

Only approved and recommended peripherals and accessories should be used.

All peripherals and accessories must be securely mounted to the LOGIQ Totus. Failure to follow these instructions could lead to unexpected diagnostic performance.



CAUTION

Non-supported peripheral devices that use their own AC power source CANNOT be attached to the LOGIQ Totus. DO NOT connect the peripheral device's power cord into the LOGIQ Totus system. Only peripheral devices purchased from GE HealthCare with the purpose of being used with the LOGIQ Totus system should be used.

Use a USB printer cable that is less than 3 meters in length.

Failure to follow these instructions could lead to unexpected diagnostic performance.



CAUTION

Do not use this equipment if a safety problem is known to exist. Have the unit repaired and performance verified by qualified service personnel before returning to use.



**Related Hazards (continued)**



CAUTION

To avoid injury or system damage, NEVER place any object or liquid on the operator panel.

**Material Safe Data**

**Rubber part**

Material: EPDM

Where Used: Probe holder/Gel holder/Keyboard bumper/Front and Rear Foot Pedal/System bumper at the four corners.

### Related Hazards (Monitor)



#### WARNING

- **DO NOT** place a finger, hand or any object on the joint of the monitor or monitor arm to avoid injury when moving the monitor and monitor arm.
- To avoid result of injury or system damage, **NEVER** place any object or liquid on the monitor, whether in the home or flip down/transport position.
- **DO NOT** scratch or press on the panel with any sharp objects, such as a pencil or pen, as this may result in damage to the panel.
- To avoid injury or damage, make sure nothing is within the range of motion before moving the monitor and monitor arm. This includes both objects and people.
- Pay attention to the monitor arm position to avoid hitting it against anyone or anything.
- Before moving the system to another location, be sure to lock the monitor arm in the transport position.
- The monitor screen may have defective pixels. These pixels may appear as a slightly light or dark area on the screen. This is due to the characteristics of the panel itself, and not the product.
- The backlight of the monitor has a fixed life span. When the screen becomes dark or begins to flicker, contact a qualified Service Representative for information.

*NOTE: Bright light could impact readability of screen.*

### Related Hazards (Volume Navigation)



#### DANGER

**DO NOT** use the Volume Navigation feature on any patient relying on life-sustaining electronic equipment, such as a pacemaker or defibrillator. Failure to follow this instruction could lead to interference with patient electronic device(s).

## Related Hazards (Specific modes and features)



### CAUTION

- Be aware that diagnostic conclusions must not be drawn from a specific mode, such as Render Mode or LOGIQView Mode. Always check with other diagnostic procedures.
- The accuracy of measurements in specific modes such as Render Mode, LOGIQView, STIC or VOCAL is limited and can be lower than measurements in B-images.
- Do not diagnose based on 3D/4D Acquisition Mode. Always check and confirm diagnostic findings in B-Mode.

## Reusable Accessory Cleaning



### DANGER

Reusable accessories should be cleaned and disinfected or sterilized as stated by the manufacturer, before first use and after each patient examination.

## Classifications

Type of protection against electric shock

Class I Equipment (\*1)

Degree of protection against electric shock

Type BF Applied part (\*2) (for Probes marked with BF symbol)

Type CF Applied part (\*3) (for ECG, eTRAX needle marked with CF symbol)

Continuous Operation

System is Ordinary Equipment (IPX0)

Footswitch is IPX8; Probes are IPX7 or greater

Internally powered ME equipment

Vscan Air CL is IP67, Vscan Air CL charger is IP41.

**NOTE:** *Probe connector is not waterproof.*

### **\*1. Class I Equipment**

EQUIPMENT in which protection against electric shock does not rely on BASIC INSULATION only, but includes an earth ground. This additional safety precaution prevents exposed metal parts from becoming LIVE in the event of an insulation failure.

### **\*2. Type BF Applied Part**

TYPE BF APPLIED PART providing a specified degree of protection against electric shock, with particular regard to allowable LEAKAGE CURRENT.

Table 2-2: Type BF Equipment

	Normal Mode	Single fault condition
Patient leakage current	Less than 100 microA	Less than 500 microA

### **\*3. Type CF Applied Part**

TYPE CF APPLIED PART providing a degree of protection higher than that for Type BF Applied Part against electric shock particularly regarding allowable LEAKAGE CURRENTS.

Table 2-3: Type CF Equipment

	Normal Mode	Single fault condition
Patient leakage current	Less than 10 microA	Less than 50 microA

## EMC (Electromagnetic Compatibility)

**NOTE:** *This equipment generates, uses and can radiate radio frequency energy. The equipment may cause radio frequency interference to other medical and non-medical devices and radio communications. To provide reasonable protection against such interference, this product complies with emissions limits for a Group 1, Class A Medical Devices Directive as stated in EN 60601-1-2. However, there is no guarantee that interference will not occur in a particular installation.*

**NOTE:** *If this equipment is found to cause interference (which may be determined by turning the equipment on and off), the user (or qualified service personnel) should attempt to correct the problem by one or more of the following measure(s):*

- *reorient or relocate the affected device(s)*
- *increase the separation between the equipment and the affected device*
- *power the equipment from a source different from that of the affected device*
- *consult the point of purchase or service representative for further suggestions.*

**NOTE:** *The manufacturer is not responsible for any interference caused by using other than recommended interconnect cables or by unauthorized changes or modifications to this equipment. Unauthorized changes or modifications could void the users' authority to operate the equipment.*

**NOTE:** *To comply with the regulations on electromagnetic interference for a Class A FCC Device, all interconnect cables to peripheral devices must be shielded and properly grounded. Use of cables not properly shielded and grounded may result in the equipment causing radio frequency interference in violation of the FCC regulations.*



### CAUTION

Unexpected diagnostic system performance or failure from interference broadcasted by device due to electromagnetic incompatibility with cauterizing knife causing obvious deterioration of image quality.

## EMC (Electromagnetic Compatibility) (continued)

**NOTE:** *Do not use devices which intentionally transmit RF Signals (cellular phones, transceivers, or radio controlled products), other than those supplied by GE HealthCare, in the vicinity of the equipment, as it may cause performance outside the published specifications. Keep the power to these type devices turned off when near this equipment.*



### CAUTION

Portable RF communications equipment (including peripherals such as antenna cables and external antennas) at frequencies noted in Table 2-4 on page 2-23 should be used no closer than 30cm (12 inches) to any part of the LOGIQ Totus, including cables specified by GE HealthCare.

Otherwise, degradation of the performance of this equipment could result.

*The medical staff in charge of this equipment is required to instruct technicians, patients, and other people who maybe around this equipment to fully comply with the above requirement.*

## EMC Performance

All types of electronic equipment may characteristically cause electromagnetic interference with other equipment, either transmitted through air or connecting cables. The term EMC (Electromagnetic Compatibility) indicates the capability of equipment to curb electromagnetic influence from other equipment and at the same time not affect other equipment with similar electromagnetic radiation from itself.

Proper installation following the service manual is required in order to achieve the full EMC performance of the product.

The product must be installed as stipulated in 4.2, Notice upon Installation of Product.



### CAUTION

Use of this equipment adjacent to or stacked with other equipment should be avoided because it could result in improper operation. If such use is necessary, this equipment and the other equipment should be observed to verify that they are operating normally. Failure to follow these instruction could lead to unexpected diagnostic performance.

In case of issues related to EMC, please call your service personnel.

The manufacturer is not responsible for any interference caused by using other than recommended interconnect cables or by unauthorized changes or modifications to this equipment. Unauthorized changes or modifications could void the users' authority to operate the equipment.

### EMC Performance (continued)



#### WARNING

Do not use devices which intentionally transmit RF signals (cellular phones, transceivers, or radio controlled products), other than those supplied by GE HealthCare (wireless microphone, broadband over power lines, for example) unless intended for use with this system, in the vicinity of this equipment as it may cause performance outside the published specifications.

Keep power to these devices turned off when near this equipment.

Medical staff in charge of this equipment is required to instruct technicians, patients and other people who may be around this equipment to fully comply with the above regulation.

Portable and mobile radio communications equipment (e.g. two-way radio, cellular/cordless telephones, wireless computer networks) should be used no closer to any part of this system, including cables, than determined according to the following method:



**EMC Performance (continued)**

Table 2-4: Recommended separation distances between portable and mobile RF communications equipment and this system

<p><b>This system is intended for use in an electromagnetic environment in which radiated RF disturbances are controlled. The customer or the user of this system can help prevent electromagnetic Interference by maintaining a minimum distance between portable and mobile RF communications equipment (transmitters) and this system as recommended below, according to the maximum output power of the communications equipment.</b></p>			
<p>Rated Maximum Output Power (P) of Transmitter Watts (W)</p>	<p>Separation distance according to transmitter frequency</p>		
	<p><b>150 kHz - 80 MHz</b> d=[3.5/3] square root of P</p>	<p><b>80 MHz - 800 MHz</b> d = [3.5/3] square root of P</p>	<p><b>800 MHz - 2.5 GHz</b> d = [7/3] square root of P</p>
	<p>Where: d= separation distance in meters, P = rated power of the transmitter.</p>		
	<p><b>The separation distance in meters should be</b></p>		
0.01	0.12	0.12	0.23
0.1	0.37	0.37	0.74
1	1.17	1.17	2.33
10	3.69	3.69	7.38
100	11.7	11.7	23.3
<p>For transmitters rated at a maximum output power not listed above, the separation distance can be estimated using the equation in the corresponding column, where P is the maximum output power rating of the transmitter in watts (W) according to the transmitter manufacturer. NOTE: At 80 MHz and 800 MHz, the separation distance for the higher frequency range applies. These guidelines may not apply in all situations. Electromagnetic propagation is affected by absorption and reflection from structures, objects, and people.</p>			

### Notice upon Installation of Product

Separation distance and effect from fixed radio communications equipment: field strengths from fixed transmitters, such as base stations for radio (cellular/cordless) telephones and land mobile radios, amateur radio, AM and FM radio broadcast, and TV broadcast transmitter cannot be predicted theoretically with accuracy. To assess the electromagnetic environment due to fixed RF transmitters, an electromagnetic site survey should be considered. If the measured field strength in the location in which the ultrasound system is used exceeds the applicable RF compliance level as stated in the immunity declaration, the ultrasound system should be observed to verify normal operation. If abnormal operation is observed, additional measures may be necessary, such as re-orienting or relocating the ultrasound system or using an RF shielded examination room may be necessary.

1. Use either power supply cords provided by GE HealthCare or ones designated by GE HealthCare. Products equipped with a power source plug should be plugged into the fixed power socket which has the protective grounding conductor. Never use any adaptor or converter to connect with a power source plug (e.g. three-prong-to-two-prong converter).
2. Locate the equipment as far away as possible from other electronic equipment.
3. Be sure to use only the cables provided by or designated by GE HealthCare. Connect these cables following the installation procedures (e.g. wire power cables separately from signal cables).
4. Lay out the main equipment and other peripherals following the installation procedures described in the Option Installation manuals.

**General Notice**



**WARNING**

Use of accessories, transducers and cables other than those specified or provided by GE HealthCare of this equipment could result in increased electromagnetic emissions or decreased electromagnetic immunity of this equipment and result in improper operation.

**Probe cables**

Table 2-5: Probe cables

Probe	Length (m)	Cable Type
9L-D	2.4	Shielded
L3-12-D	2.2	Shielded
ML6-15-D	2.2	Shielded
L6-24-D	3.0	Shielded
M5Sc-D	2.2	Shielded
6S-D	2.2	Shielded
C1-6-D	2.2	Shielded
C1-6VN-D	2.2	Shielded
C2-7-D	2.2	Shielded
C2-7VN-D	2.2	Shielded
C3-10-D	2.2	Shielded
IC5-9-D	2.0	Shielded
12S-D	2.5	Shielded
RAB6-D	2.1	Shielded
RIC5-9-D	2.5	Shielded
P2D	2.2	Shielded
P6D	2.0	Shielded
Vscan Air CL		

**General Notice (continued)**

**Other cables**

Table 2-6: Other cables

<b>Model name</b>	<b>Length (m)</b>	<b>Cable Type</b>
Power cable	4.0	Non-Shielded
ECG cable	3.6	Shielded
ECG lead wire	0.7	Shielded
V-Nav transmitter	3.3	Shielded
V-Nav Dual 10mm sensor	2.5	Shielded
Footswitch	2.5	Shielded
Vscan air CL charger cable	0.15	Non-Shielded

## **General Notice (continued)**

1. Designation of Peripheral Equipment Connectable to This Product.

The equipment indicated in the Supplies/Accessories section can be hooked up to the product without compromising its EMC performance.

Avoid using equipment not designated in the list. Failure to comply with this instruction may result in poor EMC performance of the product.

2. Notice against User Modification

The user should never modify this product. User modifications may cause degradation in EMC performance.

Modification of the product includes changes in:

- a. Cables (length, material, wiring, etc.)
- b. System installation/layout
- c. System configuration/components
- d. Securing system parts (cover open/close, cover screwing)

3. Operate the system with all covers closed. If a cover is opened for some reason, be sure to shut it before starting/resuming operation.
4. Operating the system with any cover open may affect EMC performance.

### Peripheral Update for EC countries

The following is intended to provide the users in EC countries with updated information concerning the connection of the LOGIQ Totus to image recording and other devices or communication networks.

#### Peripherals used in the patient environment

The LOGIQ Totus has been verified for overall safety, compatibility and compliance with the following image recording devices:

- Sony UP-D898DC Digital Printer
- Sony UP-D25 Digital Printer
- Sony UP-DR80MD Color Printer
- Drive Bay (for Tru3D and Volume Navigation)
- USB 2.0/3.0 Flash Drive
- USB Hard Disk Drive

*NOTE: The LOGIQ Totus supports the USB 3.0 standard (on the Operator Panel and Peripheral/Accessory Connector Panel).*

The LOGIQ Totus has also been verified for compatibility, and compliance for connection to a local area network (LAN) via the rear panel Ethernet connection, provided the LAN components are IEC/EN 60950 and IEC/EN 62368 compliant.

A Wireless LAN option is available. Conforms to IEEE 802.11 a/ b/g/n/ac Wi-Fi with Bluetooth 5.2 Standard.

The LOGIQ Totus may also be used safely while connected to devices other than those recommended above if the devices and their specifications, installation, and interconnection with the system conform to the requirements of IEC/EN 60601-1.

### Peripherals used in the patient environment (continued)

Accessory equipment connected to the analog and digital interfaces must be certified according to the respective IEC standards (i.e., IEC60950 or IEC62368 for data processing equipment and IEC60601-1 for medical equipment).

Furthermore, all complete configurations shall comply with the valid version of the system standard IEC60601-1. Everyone who connects additional equipment to the signal input part or signal output part of the LOGIQ Totus system configures a medical system, and is therefore responsible to ensure that the system complies with the requirements of the valid version of IEC60601-1. If in doubt, consult the technical service department or your local GE HealthCare representative.

General precautions for installing an alternate on-board device would include:

1. The added device must have appropriate safety standard conformance and CE Marking.
2. The total power consumption of the added devices, which connect to the LOGIQ Totus and are used simultaneously, must be less than or equal to the rated supply of the LOGIQ Totus.
3. There must be adequate heat dissipation and ventilation to prevent overheating of the device.
4. There must be adequate mechanical mounting of the device and stability of the combination.
5. Risk and leakage current of the combination must comply with IEC/EN 60601-1.
6. Electromagnetic emissions and immunity of the combination must conform to IEC/EN 60601-1-2.

### Peripherals used in the patient environment (continued)

General precautions for installing an alternate off-board, remote device or a network would include:

1. The added device(s) must have appropriate safety standard conformance and CE Marking.
2. The added device(s) must be used for their intended purpose having a compatible interface.
3. Signal or mains isolation devices and additional protective earth may be needed to assure compliance with IEC/ EN 60601-1.



## Declaration of Emissions

This system is suitable for use in the following environment. The user must assure that it is used only in the electromagnetic environment as specified.

Table 2-7: Declaration of Emissions

<b>Guidance and manufacturer's declaration - electromagnetic emissions</b>		
<b>The system is intended for use in the electromagnetic environment specified below. The user of the system should assure that it is used in such an environment.</b>		
<b>Emission Type</b>	<b>Compliance</b>	<b>Electromagnetic Environment</b>
RF Emissions CISPR 11	Group 1	This system uses RF energy only for its internal function. Therefore, its RF emissions are very low and are not likely to cause any interference in nearby electronic equipment.
RF Emissions CISPR 11	Class A	This system is suitable for use in all establishments, other than domestic establishments and those directly connected to the public low-voltage power supply network that supplies buildings used for domestic purposes, provided the following warning is heeded: WARNING: The EMISSIONS characteristics of this equipment make it suitable for use in industrial areas and hospitals (CISPR 11 class A). If it is used in a residential environment (for which CISPR 11 class B is normally required) this equipment might not offer adequate protection to radio-frequency communication services. The user might need to take mitigation measures, such as relocating or reorienting the equipment.
Harmonic Emissions IEC 61000-3-2	Class A	
Voltage Fluctuations/Flicker Emissions IEC 61000-3-3	Complies	

## Declaration of Immunity

This system is suitable for use in the following environment. The user must ensure that the system is used according to the specified guidance and only in the electromagnetic environment listed.

Table 2-8: Declaration of Immunity Compliance Statement Supporting

Guidance and manufacturer's declaration - electromagnetic immunity			
This system is intended for use in the electromagnetic environment specified below. The customer or the user of this system should assure that it is used in such an environment.			
Environments of INTENDED USE	Professional HealthCare facility environment		
Immunity Type	IEC 60601-1-2 test level	IEC 60601-1-2 Compliance Level	Electromagnetic Environment Guidance
IEC 61000-4-2 Electrostatic discharge (ESD)	± 8 kV contact ± 15 kV air	± 8 kV air ± 15 kV air	Floors should be wood, concrete, or ceramic tile. If floors are covered with synthetic material, the relative humidity should be at least 30%.
IEC 61000-4-4 Electrical fast transient/burst	±2 kV for power supply lines 100 kHz rate ± 1 kV for input/output lines 100 kHz rate	± 2 kV for power supply lines 100 kHz rate ± 1 kV for input/output lines 100 kHz rate	Mains power quality should be that of a typical commercial and/or hospital environment.
IEC 61000-4-5 Surge Immunity	± 1 kV line-line ± 2 kV line-earth	± 1 kV line-line ± 2 kV line-earth	Mains power quality should be that of a typical commercial and/or hospital environment.
IEC 61000-4-11 Voltage dips and short interruptions and voltage variations on power supply input lines	0 % UT; 0.5cycle, Phase: 0,45,90,135,180,225,270,315° 0 % UT; 1cycle, Phase: 0° 70 % UT; 25/30cycle, Phase: 0° 0 % UT; 250/300 cycle Note: Apply IEC 60601-2-37 (202.6.2.7)	0 % UT; 0.5cycle, Phase: 0,45,90,135,180,225,270, 315° 0 % UT; 1cycle, Phase: 0° 70 % UT; 25/30cycle, Phase: 0° 0 % UT; 250/300 cycle Note: Apply IEC 60601-2-37 (202.6.2.7)	Mains power quality should be that of a typical commercial and/or hospital environment. If the user requires continued operation during power mains interruptions, it is recommended that the system be powered from a UPS or a battery option.

Table 2-8: Declaration of Immunity Compliance Statement Supporting (Continued)

<b>Guidance and manufacturer's declaration - electromagnetic immunity</b>			
<b>This system is intended for use in the electromagnetic environment specified below. The customer or the user of this system should assure that it is used in such an environment.</b>			
<b>Environments of INTENDED USE</b>	<b>Professional HealthCare facility environment</b>		
<b>Immunity Type</b>	<b>IEC 60601-1-2 test level</b>	<b>IEC 60601-1-2 Compliance Level</b>	<b>Electromagnetic Environment Guidance</b>
IEC 61000-4-8 Power frequency (50/60 Hz) magnetic field	30 A/m	30 A/m	Power frequency magnetic fields should be at levels characteristic of a typical location in a typical commercial and/or hospital environment.
NOTE: UT is the AC mains voltage prior to application of the test level.			

Table 2-8: Declaration of Immunity Compliance Statement Supporting (Continued)

Guidance and manufacturer's declaration - electromagnetic immunity			
This system is intended for use in the electromagnetic environment specified below. The customer or the user of this system should assure that it is used in such an environment.			
Environments of INTENDED USE	Professional HealthCare facility environment		
Immunity Type	IEC 60601-1-2 test level	IEC 60601-1-2 Compliance Level	Electromagnetic Environment Guidance
IEC 61000-4-6 Conducted RF	3 Vrms 150kHz to 80MHz 6 Vrms in ISM bands between 150 kHz to 80MHz	3 Vrms 150kHz to 80MHz 6 Vrms in ISM bands between 150 kHz to 80MHz	Portable and mobile RF communications equipment should be used no closer to any part of this system, including cables, than the recommended separation distance calculated from the equation appropriate for the frequency of the transmitter. Recommended Separation Distance (see Table 2-4) $d = \left[ \frac{3.5}{3} \right] \sqrt{P}$ (80 MHz to 800 MHz (see Table 2-4)) $d = \left[ \frac{3.5}{3} \right] \sqrt{P}$ (800 MHz to 2.7 GHz (see Table 2-4)) $d = \left[ \frac{7}{3} \right] \sqrt{P}$ where $P$ is the maximum output power rating of the transmitter in watts (W) according to the transmitter manufacturer and $d$ is the recommended separation distance in meters (m). Field strengths from fixed RF transmitters, as determined by an electromagnetic site survey, a should be less than the compliance level in each frequency range b.
IEC 61000-4-3 Radiated RF EM fields	3 V/m 80 MHz - 2.7 GHz 80% AM 1 kHz	3 V/m 80 MHz - 2.7 GHz 80% AM 1 kHz	
IEC 61000-4-39 Radiated Fields in Close Proximity	134.2kHz, PM 50% 2.1kHz, 65 A/m 13.56MHz, PM 50% 50kHz, 7.5A/m	134.2kHz, PM 50% 2.1kHz, 65 A/m 13.56MHz, PM 50% 50kHz, 7.5A/m	

Table 2-8: Declaration of Immunity Compliance Statement Supporting (Continued)

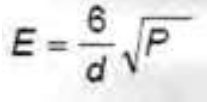
Guidance and manufacturer's declaration - electromagnetic immunity			
This system is intended for use in the electromagnetic environment specified below. The customer or the user of this system should assure that it is used in such an environment.			
Environments of INTENDED USE	Professional HealthCare facility environment		
Immunity Type	IEC 60601-1-2 test level	IEC 60601-1-2 Compliance Level	Electromagnetic Environment Guidance
IEC 61000-4-3 Proximity fields from RF wireless communications equipment	9 V/m to 28 V/m spot frequencies 385 MHz: 27 V/m 450 MHz: 28 V/m 710 MHz: 9 V/m 745 MHz: 9 V/m 780 MHz: 9 V/m 810 MHz: 28 V/m 870 MHz: 28 V/m 930 MHz: 28 V/m 1720 MHz: 28 V/m 1845 MHz: 28 V/m 1970 MHz: 28 V/m 2450 MHz: 28 V/m 5240 MHz: 9 V/m 5500 MHz: 9 V/m 5785 MHz: 9 V/m PM 18 Hz or 217 Hz (50% duty cycle)	9 V/m to 28 V/m spot frequencies 385 MHz: 27 V/m 450 MHz: 28 V/m 710 MHz: 9 V/m 745 MHz: 9 V/m 780 MHz: 9 V/m 810 MHz: 28 V/m 870 MHz: 28 V/m 930 MHz: 28 V/m 1720 MHz: 28 V/m 1845 MHz: 28 V/m 1970 MHz: 28 V/m 2450 MHz: 28 V/m 5240 MHz: 9 V/m 5500 MHz: 9 V/m 5785 MHz: 9 V/m PM 18 Hz or 217 Hz (50% duty cycle)	Minimum separation distances for higher IMMUNITY TEST LEVELS shall be calculated using the following equation:  Where P is the maximum power in W, d is the minimum separation distance in m, and E is the IMMUNITY TEST LEVEL in V/m.
<p>a. Field strengths from fixed transmitters, such as base stations for radio (cellular/cordless) telephones and land mobile radios, amateur radio, AM and FM radio broadcast, and TV broadcast cannot be predicted theoretically with accuracy. To assess the electromagnetic environment due to fixed RF transmitters, an electromagnetic site survey should be considered. If the measured field strength in the location in which this system is used exceeds the applicable RF compliance level above, this system should be observed to verify normal operation. If abnormal performance is observed, additional measures may be necessary, such as reorienting or relocating this system.</p> <p>b. Over the frequency range 150 kHz to 80 MHz field strengths should be less than 3 V/m.</p> <p>c. As an alternative to FM modulation, 50 % pulse modulation at 18 Hz may be used because while it does not represent actual modulation, it would be worst case.</p> <p>NOTE: These guidelines may not apply in all situations. Electromagnetic propagation is affected by absorption and reflection from structures, objects, and people.</p>			

**Declaration of Immunity (continued)**

Table 2-9: Spot Frequencies for IEC 61000-4-3 Proximity fields from RF wireless communications equipment

Test Frequency (MHz)	Band (MHz)	Service	Modulation	Maximum Power (W)	Distance (m)	Immunity Test Level (V/m)
385	380 - 390	TETRA 400	Pulse modulation 18 Hz	1.8	0.3	27
450	430 - 470	GMRS 460, FRS 460	FM $\pm$ 5 kHz deviation 1 kHz sine	2	0.3	28
710	704 - 787	LTE Band 13, 17	Pulse modulation 217 Hz	0.2	0.3	9
745						
780						
810	800 - 960	GSM 800/ 900 TETRA 800 iDEN 820 CDMA 850 LTE Band 5	Pulse modulation 18 Hz	2	0.3	28
870						
930						
1720	1700 - 1990	GSM 1800; CDMA 1900; GSM 1900; DECT; LTE Band 1, 3, 4, 25; UMTS	Pulse modulation 217 Hz	2	0.3	28
1845						
1970						
2450	2400 - 2570	Bluetooth, W LAN, 802.11 b/g/n, RFID 2450, LTE Band 7	Pulse modulation 217 Hz	2	0.3	28
5240	5100 - 5800	WLAN 802.11 a/n	Pulse modulation 217 Hz	0.2	0.3	9
5500						
5785						

## **Essential performance**

The essential performance of the ultrasound unit is:

- The ability to display B-mode image as input for diagnosis.
- The ability to display M-mode image as input for diagnosis.
- The ability to display Doppler-mode image as input for diagnosis.
- The ability to display Color Flow-mode image as input for diagnosis.
- The display of acoustic power indexes as an aid for safe use of ultrasound diagnostic (MI, TIS, TIB, TIC).

## Patient Environmental Devices (LCD monitor)

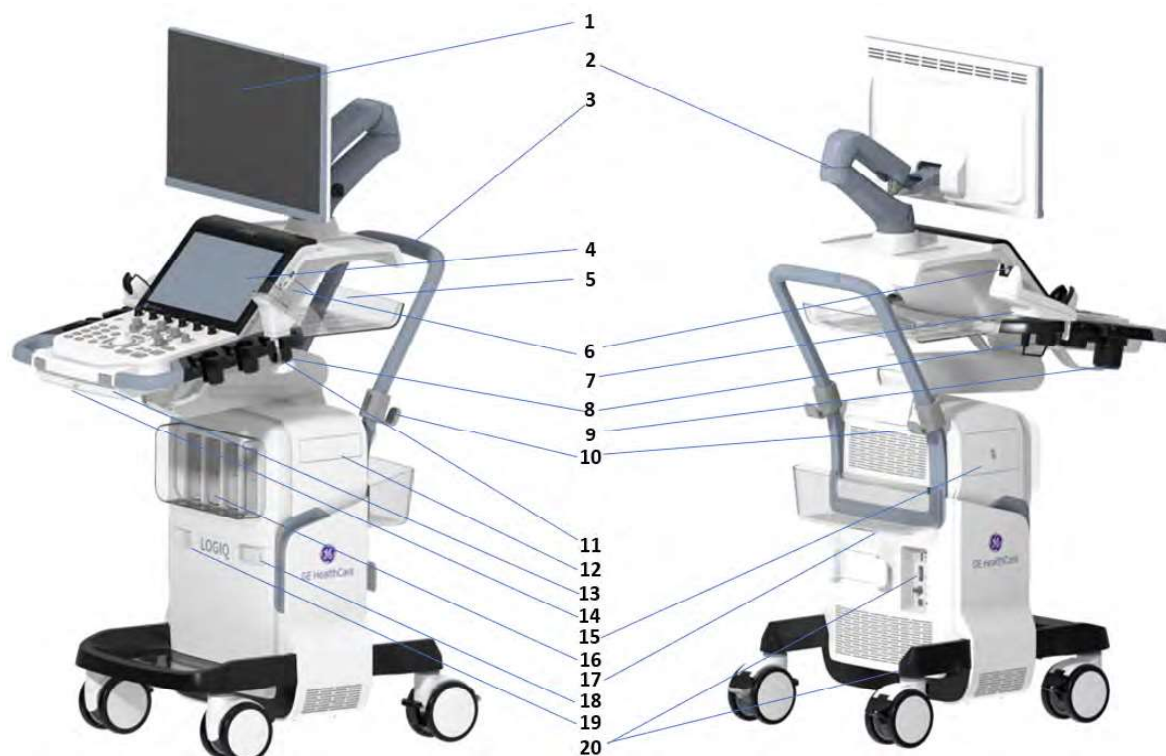

Figure 2-1. Patient Environmental Devices

- |  |   |
|--|---|
| 1. 23.8 inch widescreen monitor                | 12. V-Navi controller (Option)                                  |
| 2. Monitor arm                                 | 13. Front handle with control panel rotation and up/down button |
| 3. Rear handle                                 | 14. AN Keyboard (option)  |
| 4. Control panel with touch panel display      | 15. BW printer (option) or Drawer (option) bay                  |
| 5. OPIO rear tray (option)                     | 16. Probe connectors  |
| 6. USB port (2 A types, 2 C types), Microphone | 17. Rear basket (option)  |
| 7. Horizontal TV probe holder (option)         | 18. Patient I/O Port (Option)                                   |
| 8. Probe holder                                | 19. CW probe port (Option)                                      |
| 9. Gel holder or Gel warmer (option)           | 20. External I/O connectors and Mains power switch              |
| 10. Rear handle cable hook (option)            |   |
| 11. Wireless probe charger (option)            |   |



Patient Environmental Devices (HDU monitor)

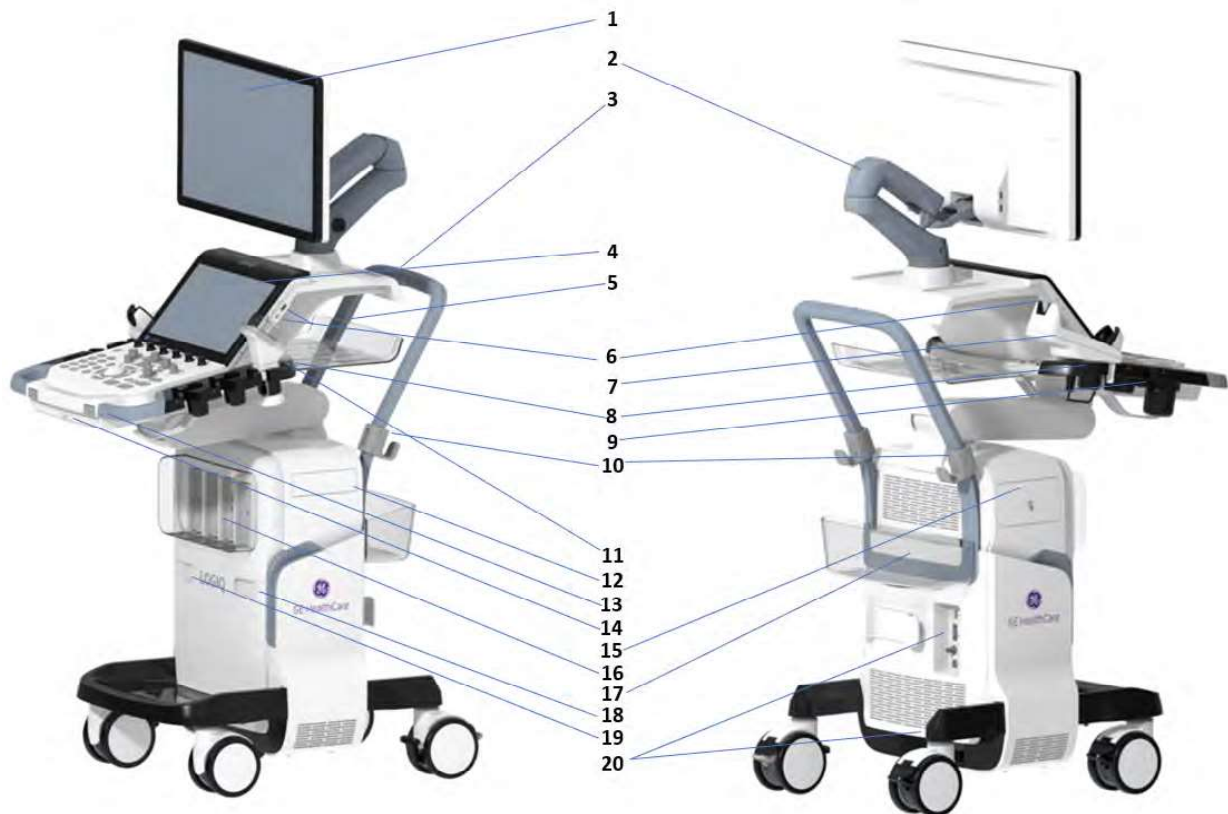

Figure 2-2. Patient Environmental Devices

- |  |   |
|--|---|
| 1. 23.8 inch widescreen monitor                | 12. V-Navi controller (Option)                                  |
| 2. Monitor arm                                 | 13. Front handle with control panel rotation and up/down button |
| 3. Rear handle                                 | 14. AN Keyboard (option)  |
| 4. Control panel with touch panel display      | 15. BW printer (option) or Drawer (option) bay                  |
| 5. OPIO rear tray (option)                     | 16. Probe connectors  |
| 6. USB port (2 A types, 2 C types), Microphone | 17. Rear basket (option)  |
| 7. Horizontal TV probe holder (option)         | 18. Patient I/O Port (Option)                                   |
| 8. Probe holder                                | 19. CW probe port (Option)                                      |
| 9. Gel holder or Gel warmer (option)           | 20. External I/O connectors and Mains power switch              |
| 10. Rear handle cable hook (option)            |   |
| 11. Wireless probe charger (option)            |   |

### Acceptable Devices

The Patient Environmental devices shown on the previous page are specified to be suitable for use within the PATIENT ENVIRONMENT.



#### CAUTION

DO NOT connect any probes or accessories without approval by GE HealthCare within the PATIENT ENVIRONMENT.

See 'Peripheral Update for EC countries' on *page 2-28 for more information.*

Any device connected to the LOGIQ Totus must conform to one or more of the requirements listed below:

1. IEC standard or equivalent standards appropriate to devices.
2. The devices shall be connected to PROTECTIVE EARTH (GROUND).

### Unapproved Devices



#### DANGER

DO NOT use unapproved devices.

If devices are connected without the approval of GE HealthCare, the warranty will be INVALID.

Any device connected to the Ultrasound System must conform to one or more of the requirements listed below:

1. IEC standard or equivalent standards appropriate to devices.
2. The devices shall be connected to PROTECTIVE EARTH (GROUND).

### Accessories, Options, Supplies



#### CAUTION

Unsafe operation or malfunction may result. Use only the accessories, options and supplies approved or recommended in these instructions for use.

## Acoustic Output

When the “Auto Freeze Time (probe selection required)” preset is selected on the Utility -> System -> System Imaging screen, the system auto freezes after the time specified (10 or 30 minutes, 1 hour, or Never) of scanning if it detects no change in the image.

Located on the upper right section of the system display monitor, the acoustic output display provides the operator with real-time indication of acoustic levels being generated by the system. See the *Acoustic Output chapter* in the *Advanced Reference Manual* for more information.

## Acoustic Output Display Specifications

The display consists of three parts: Thermal Index (TI), Mechanical Index (MI), and a relative Acoustic Output (AO) value.

The TI and MI are displayed at all times. The TI display starts at a value of 0.0, increments in steps of 0.1 and accuracy is  $\pm 50\%$ . For MI display values between 0 and 0.4, the display increments in steps of 0.01 and for values greater than 0.4, increments in steps of 0.1. The MI accuracy is  $\pm 25\%$ .

The AO percentage (AO%) value informs the user of where the system is operating within the range of available output. Accuracy of the AO% is  $\pm 10\%$ .

## Acoustic Output Display Specifications (continued)

### Thermal Index

Depending on the examination and type of tissue involved, the TI parameter will be one of three types:

- **Soft Tissue Thermal Index (TIS)**. Used when imaging soft tissue only, it provides an estimate of potential temperature increase in soft tissue.
- **Bone Thermal Index (TIB)**. Used when bone is near the focus of the image as in the third trimester OB examination, it provides an estimate of potential temperature increase in the bone or adjacent soft tissue.
- **Cranial Bone Thermal Index (TIC)**. Used when bone is near the skin surface as in transcranial examination, it provides an estimate of potential temperature increase in the bone or adjacent soft tissue.

### Mechanical Index

MI recognizes the importance of non-thermal processes, cavitation in particular. The Index is a relative indicator of the likelihood of mechanical bioeffect within the tissue.

### Changing the Thermal Index Type

You can select the displayed TI type on Utility -> Imaging -> B-Mode. This preset is application dependent so each application could specify a different TI type.

### Controls Affecting Acoustic Output

The potential for producing mechanical bioeffects (MI) or thermal bioeffects (TI) can be influenced by certain controls.

*Direct.* The Power Output control has the most significant effect on Acoustic Output.

*Indirect.* Indirect effects may occur when adjusting controls. Controls that can influence MI and TI are detailed under the Bioeffects portion of each control in the Optimizing the Image sections.

Always observe the Acoustic Output display for possible effects.

## Best practices while scanning



### HINTS

Raise the Acoustic Output only after attempting image optimization with controls that have no effect on Acoustic Output, such as Gain and TGC.

**NOTE:** *Refer to the Optimizing the Image sections for a complete discussion of each control.*



### DANGER

Be sure to have read and understood control explanations for each mode used before attempting to adjust the Acoustic Output control or any control that can affect Acoustic Output. During a screening and diagnostic ultrasound examination, high frequency sound penetrates and interacts with tissue in and around the area of anatomy to be imaged. Only a small portion of this sound energy is reflected back to the transducer for use in constructing the image, while the remainder is dissipated within the tissue. The interaction of sound energy with tissue at sufficiently high levels can produce biological effects (aka bioeffects) of either a mechanical or thermal nature. Although the generation of bioeffect is intentional with therapeutic ultrasound, it is generally undesired in screening and diagnostic applications and may be harmful in some conditions.



### Acoustic Output Hazard

Use the minimum necessary acoustic output to get the best diagnostic image or measurement during an examination. Begin the exam with the probe that provides an optimum focal depth and penetration.

## Acoustic Output Default Levels

In order to assure that an exam does not start at a high output level, the LOGIQ Totus initiates scanning at a reduced default output level. This reduced level is preset programmable and depends upon the exam category and probe selected. It takes effect when the system is powered on or **New Patient** is selected.

To modify acoustic output, adjust the Power Output level on the Touch Panel.

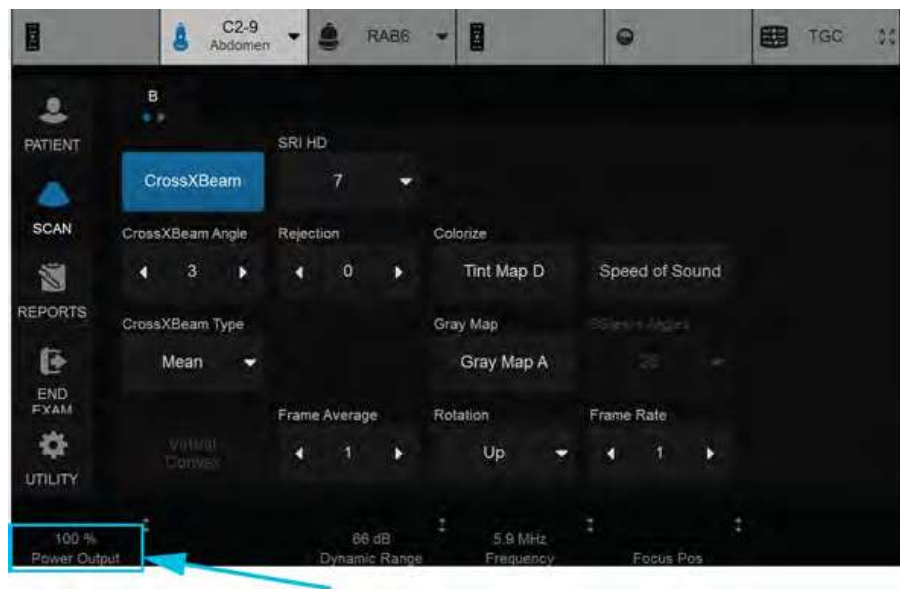

Figure 2-3. Location of Power Output control

## Acoustic Output on Pleural Preset

The U.S. Food and Drug Administration (FDA) recommends that MI levels should be lower than 1.4 when scanning lungs.

Select the Pleural preset when performing a lung exam. The displayed MI will not exceed 0.8 with Pleural preset selected. Differences in MI values are a result of probe to probe variation as well as the calculation accuracy of the displayed MI value.

## RoHS LOGIQ Totus Hazardous Substances

The following product pollution control information is provided according to SJ/T11364-2014 Marking for Control of Pollution caused by Electronic Information Products.



This symbol indicates the product contains hazardous materials in excess of the limits established by the Chinese standard GB/T 26572 Requirements for Concentration Limits for Certain Hazardous Substances in Electronic Information Products. The number in the symbol is the Environment-friendly Use Period (EFUP), which indicates the period during which the hazardous substances or elements contained in electrical and electronic products will not leak or mutate under normal operating conditions so that the use of such electrical and electronic products will not result in any severe environmental pollution, any bodily injury or damage to any assets. The unit of the period is “Year.”

In order to maintain the declared EFUP, the product shall be operated normally according to the instructions and environmental conditions as defined in the product manual, and periodic maintenance schedules specified in Product Maintenance Procedures shall be followed strictly. Consumables or certain parts may have their own label with an EFUP value less than the product. Periodic replacement of those consumables or parts to maintain the declared EFUP shall be done in accordance with the Product Maintenance Procedures.

This product must not be disposed of as unsorted municipal waste, and must be collected separately and handled properly after decommissioning.

## Name and Concentration of Hazardous Substances

Table 2-10: Table of hazardous substances' name and concentration for LOGIQ Totus

Component Name	Hazardous substances' name					
	Pb	Hg	Cd	Cr (VI)	PBB	PBDE
HDU Display	O	O	O	O	O	O
LCD Display	O	O	O	O	O	O
Circuit Boards	O	O	O	O	O	O
Touch Panel	O	O	O	O	O	O
Ultrasound Probes	O	O	O	O	O	O
Console Cabinet	O	O	O	O	O	O
Operator Panel	O	O	O	O	O	O
Console Frame (Base Casting, Castings, Card Rack)	O	O	O	O	O	O
System Covers	O	O	O	O	O	O
System Cables	O	O	O	O	O	O

This table is prepared according to SJ/T 11364.  
O: Indicates that this hazardous substance contained in all of the homogeneous materials for this part is below the limit requirement in GB/T 26572.  
X: Indicates that this hazardous substance contained in at least one of the homogeneous materials used for this part is above the limit requirement in GB/T 26572.

- Data listed in the table represents best information available at the time of publication.
- Applications of hazardous substances in this medical device are required to achieve its intended clinical uses, and/or to provide better protection to human beings and/or to environment, due to lack of reasonably (economically or technically) available substitutes

Note: Options may not be present on every system.



## **WEEE Passport**

The WEEE (Waste Electrical and Electronic Equipment) Passport describes product recycling information. To access the WEEE passport for GE HealthCare products:

1. Go to the GE HealthCare Support Documentation Library at:  
<https://www.gehealthcare.com/support/documentation>
2. Select the modality "Ultrasound (UL)."
3. Enter the document name or the keyword "WEEE."
4. Press "Search."
5. Select the desired WEEE passport.

## **Safe Product and Packaging Disposal**

This product and package should be disposed of according to hospital disposal practices, and local environmental and waste disposal regulations. Components and accessories of the LOGIQ Totus which have come into direct or indirect contact with the patient may be biohazardous, and should be disposed of according to facility guidelines for biohazardous material. The waste of electrical and electronic equipment must not be disposed as unsorted municipal waste and must be collected separately. Please contact an authorized representative of the manufacturer for information concerning the disposal/ decommissioning of equipment.

# Device Labels

## Label Icon Description

The following tables describes the purpose and location of safety labels and other important information provided on the equipment.

**NOTE:** *This machine should be used in compliance with law. Some jurisdictions restrict certain uses, such as gender determination (shown for country specific label).*

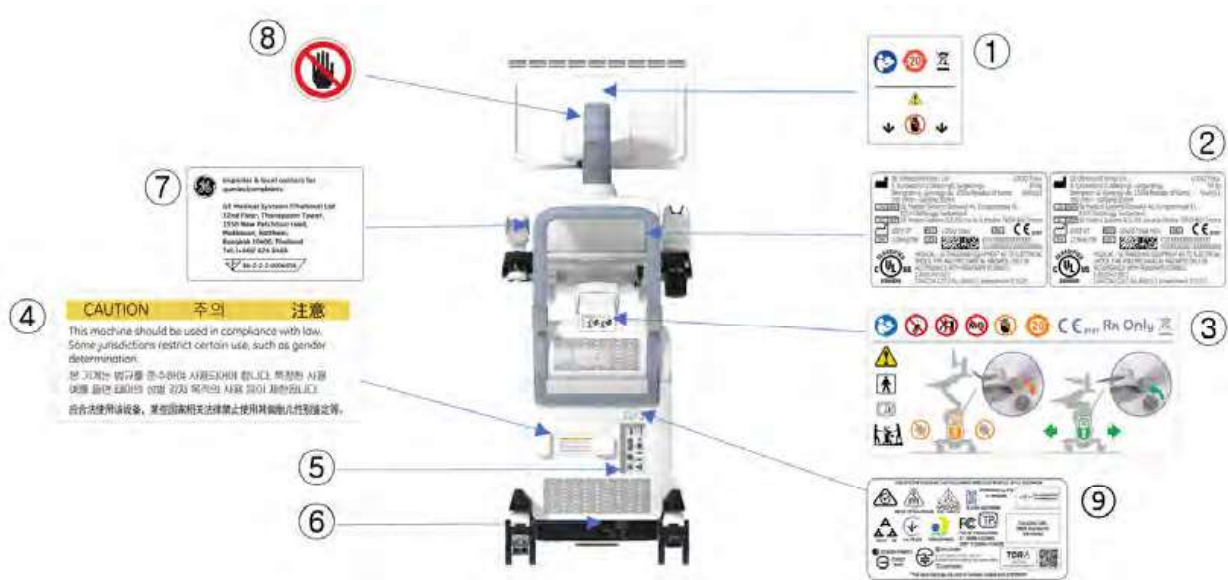

Figure 2-4. Rear Panel Label Location

**Label Icon Description (continued)**

Table 2-11: Label Icons (Rear of Console)







No.	Label/Icon	Purpose/Meaning/Reference Standard
		GE HealthCare Logo
1.		<p>Monitor Label: GE HealthCare created</p> <p>DO NOT place a finger, hand or any object on the joint of the monitor or monitor arm to avoid injury when moving the monitor and monitor arm.</p>
1. and 3.		<p>Follow instruction for use.</p> <p>IEC 60601-1:2005+A1:2012 Annex D.1 and ISO 7010-M002</p>
1. and 3.		<p>Indicates the presence of hazardous substance(s) above the maximum concentration value. Maximum concentration values for electronic information products, as set by the People’s Republic of China Electronic Industry Standard SJ/T11364-2006, include the hazardous substances of lead, mercury, hexavalent chromium, cadmium, polybrominated biphenyl (PBB), and polybrominated diphenyl ether (PBDE). “20” indicates the number of years during which the hazardous substance(s) will not leak or mutate so that the use of this product will not result in any severe environmental pollution, bodily injury, or damage to any assets.</p> <p>China Electronic Industry Standard SJ/T11364-2014</p>
1 and 3.		<p>This WEEE symbol indicates that waste electrical and electronic equipment must not be disposed of as unsorted municipal waste and must be collected separately. Please contact an authorized representative of the manufacturer for information concerning the decommissioning of your equipment. Standard: EN 50419.</p> <p>WEEE Directive 2012/19/EU</p>
1. and 3.		<p>“General Warning Sign” Possible shock hazard. Do not remove covers or panels. No user serviceable parts are inside. Refer servicing to qualified service personnel. Standard: ISO 7010-W001.</p>

Table 2-11: Label Icons (Rear of Console) (Continued)

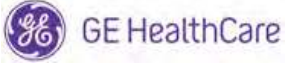





No.	Label/Icon	Purpose/Meaning/Reference Standard
1. , 3. and 8.		<p>Pinch point caution Watch your hands and fingers when adjusting the monitor. Keep hands clear of openings.</p> <p>GE HealthCare created</p>
		<p>Maximum load 1kg- Danger of breaking. Do not put any items exceeding the indicated maximum load limit on this shelf.</p> <p>ISO 7010-P012</p>
2.		<p>Every system has a unique marking for identification, the Unique Device Identification (UDI) Label. The UDI label consists of a series of alpha-numeric characters and barcode which uniquely identify the LOGIQ Totus system as a medical device manufactured by GE HealthCare. Scan or enter the UDI information into the patient health record as required by country-specific laws.</p>
	<p>(01)00000000000000 (11)000000(21)00000000</p>	<p>UDI Human Readable Label Text: Global Trade Item Number (GTIN), Manufacturing Date, Serial Number</p> <p>GE HealthCare created</p>
		<p>UDI Symbol and Data Matrix</p> <p>ISO15223-1</p>
2.	<p>100-240V~, 50/60Hz, 650VA</p>	<p>System Voltage (100-240VAC) Frequency Power Rating</p> <p>IEC 61293 /IEC 60601-1</p>
2.		<p>Alternating Current symbol is in accordance with IEC 60417-5032</p>
2.		<p>Catalog/Model Number. Standard: ISO 7000-2493.</p>
2.		<p>Serial Number. Standard: ISO 7000-2498.</p>

Table 2-11: Label Icons (Rear of Console) (Continued)







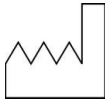

No.	Label/Icon	Purpose/Meaning/Reference Standard
2.		Legal Manufacturer's name and address. Standard: ISO 7000-3082.
2.		Date of manufacture YYYY-MM. Standard: ISO 7000-2497.
2.		ANSI/AAMI ES 60601-1:2005/A2:2021, CAN/CSA-C22.2 No. 60601-1 (Amendment 2:2022)
3.		The CE Mark of Conformity indicates this equipment conforms with the European Medical Device Regulation 2017/745  European Medical Device Regulation 2017/745
3.		Do not use the following devices near this equipment: cellular phone, radio receiver, mobile radio transmitter, radio controlled toy, broadband power lines, etc. Use of these devices near this equipment could cause this equipment to perform outside the published specifications. Keep power to these devices turned off when near this equipment.  ISO 7010-P013
3.		DO NOT push the system. Use the handle to push/pull the system, e.g., DO NOT use the monitor. Failure to do so may cause serious injury or system damage.  IEC 60601-1:2005+A1:2012 Annex D.2 and ISO 7010-P017
3.		United States only Prescription Device label 21 CFR 801.109 and Alternative to Certain Prescription Device Labeling Requirements Guidance to Industry 1/2/2000 U.S. Food&Drug Administration modified by GE HealthCare for clarity that this is for the USA
3.		Type BF Applied Part (man in the box) symbol is in accordance with IEC 60417-5333.
3.		Symbol indicating that the Instructions for Use are supplied in electronic form. ISO 7000-3500

Table 2-11: Label Icons (Rear of Console) (Continued)







No.	Label/Icon	Purpose/Meaning/Reference Standard
3.		<p>Use two people to transport system on inclines. This label also indicates the system weight.</p> <p>To avoid possible injury and equipment damage when transporting from one area of use to another:</p> <ul style="list-style-type: none"> <li>• Be sure the pathway is clear.</li> <li>• Limit movement to a slow careful walk.</li> <li>• Use two or more persons to move the equipment on inclines or long distance.</li> </ul> <p>GE HealthCare created</p>
3.		<p>This product is a medical device</p> <p>ISO15223-1</p>
3.		<p>Unlock/Lock the monitor arm</p> <p>GE HealthCare created</p>
3.		<p>The MR Unsafe label is to <b>warn</b> that this Ultrasound System poses risks to the patient, medical staff or other persons within the MR environment and that the Ultrasound system should remain outside of the MR environment</p> <p>ISO 7010</p>
3.		<p>The CH-REP label indicates the authorized representative in Switzerland</p> <p>Regulation (EU) 2017/745</p>
4.		<p>Gender Caution (only for India, China, Korea)</p> <p>GE HealthCare created</p>
5.		<p>Possible shock hazard. Do not remove covers or panels. No user serviceable parts are inside. Refer servicing to qualified service personnel.</p> <ol style="list-style-type: none"> <li>1. Network/Disk/Battery Indicators</li> <li>2. Audio out connector</li> <li>3. Ethernet connector</li> <li>4. USB 3.0 port</li> <li>5. USB 3.0 port</li> <li>6. HDMI connector</li> <li>7. DP connector</li> <li>8. VGA connector</li> <li>9. Composite connector</li> <li>10. S-Video connector</li> </ol>

Table 2-11: Label Icons (Rear of Console) (Continued)



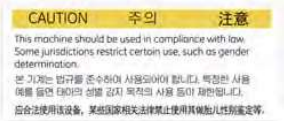

No.	Label/Icon	Purpose/Meaning/Reference Standard
6.		<p>1. System voltage (~100-240VAC) Frequency Power Rating</p> <p>2. “Equipotentiality” indicates the terminal to be used for connecting equipotential conductors when interconnecting (grounding) with other equipment. Connection of additional protective earth conductors or potential equalization conductors is not necessary in most cases and is only recommended for situations involving multiple equipment in a high-risk patient environment to provide assurance that all equipment is at the same potential and operates within acceptable leakage current limits. An example of a high-risk patient would be a special procedure where the patient has an accessible conductive path to the heart such as exposed cardiac pacing leads.</p> <p>IEC60417-5021 IEC 60601-1:2005+A1:2012 Annex D.1 and IEC 60417-5021</p>
7.	Country Specific Label	Country Specific label are required to comply with country regulation
9.		<p>The system contains the following wireless module: INTEL AX210NGW</p> <p>*Those symbols and certification marks corresponding to number “9” are only for wireless module : INTEL AX210NGW. Those are not related to the certification of LOGIQ Totus.</p> <p>**The latest information on INTEL certification can be found at the following link: <a href="https://www.intel.com/content/www/us/en/support/articles/000007443/wireless/legacy-intel-wireless-products.html">https://www.intel.com/content/www/us/en/support/articles/000007443/wireless/legacy-intel-wireless-products.html</a></p>
9.		Australia RCM certification mark
9.		Moldova SM certification mark and number
9.		Malaysia MCMC certification mark and number

Table 2-11: Label Icons (Rear of Console) (Continued)



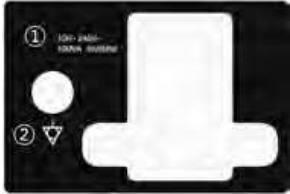







No.	Label/Icon	Purpose/Meaning/Reference Standard
9.		South Korea KC certification mark and number
9.		South Africa - ICASA certification mark and number
9.		Pakistan Telecommunication Authority (PTA)
9.		Serbia RATEL certification mark
9.		Ukraine NCCIR certification mark
9.		Brazil ANATEL certification mark and number
9.		USA FCC certification mark and number
9.		Canada ISED certification number
9.		China SRRC certification number
9.		Belarus TR BY certification mark
9.		Singapore IMDA certification mark

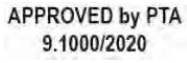

Table 2-11: Label Icons (Rear of Console) (Continued)



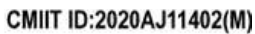

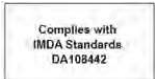

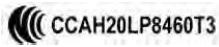

No.	Label/Icon	Purpose/Meaning/Reference Standard
9.		Taiwan NCC certification mark and number
9.		Taiwan BSMI certification mark and number
9.		Japan MIC certification mark and number
9.		UAE TDRA certification mark and number
		Degrees of protection provided by enclosures (IP Code)  IEC 60529
Operator control panel		“ON” indicates the power on position of the power switch. <b>CAUTION:</b> This Power Switch <b>DOES NOT ISOLATE</b> Mains Supply.  IEC 60601-1:2005+A1:2012 Annex D.1, IEC 60417-5007 and IEC 60417-5009
System packing		DO NOT USE HOOK  To indicate that hooks shall not be used for handling the transport package.  ISO7000-0622
System packing		TOP, UPRIGHT - Transportation and Storage  To indicate correct upright position of the transport package.  ISO7000-0623
System packing		Fragile, handle with care  Indicate a medical device that can be broken or damaged if not handle carefully  ISO15223-1: 5.3.1 ISO7000-0621

Table 2-11: Label Icons (Rear of Console) (Continued)









No.	Label/Icon	Purpose/Meaning/Reference Standard
System packing		<p>Do not stack</p> <p>ISO7000-2402</p>
System packing		<p>Keep dry (Protect from moisture)</p> <p>Indicates a medical device that needs to be protected from moisture.</p> <p>ISO15223-1: 5.3.4 ISO7000-0626</p>
System packing		<p>Temperature limitation</p> <p>Indicates the temperature limits to which the medical device can be safely exposed.</p> <p>ISO15223-1: 5.3.7 ISO7000-0632</p>
System packing		<p>Humidity control</p> <p>Indicates the range of humidity to which the medical device can be safely exposed.</p> <p>ISO15223-1: 5.3.8 ISO7000-2620</p>
System packing		<p>Range of Air Pressure</p> <p>Indicates the range of atmospheric pressure to which the medical device can be safely exposed.</p> <p>ISO15223-1: 5.3.9 ISO7000-2621</p>
System packing		<p>RECYCLING PAPER 30% USED</p> <p>To indicate that the marked item or its material is part of a recovery or recycling process.</p> <p>ISO 7000-1135</p>
ECG connector		<p>Defibrillation-proof CF applied part</p> <p>IEC 60601-1:2005+A1:2012 Annex D.1 and IEC 60417-5336</p>

Table 2-11: Label Icons (Rear of Console) (Continued)

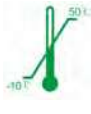
No.	Label/Icon	Purpose/Meaning/Reference Standard
eTRAX needle		CF applied part IEC 60601-1:2005+A1:2012 Annex D.1 and IEC 60417-5335

## Label on the packing box



Figure 2-5. Package label

This label is printed on the packing box of the system to indicate the humidity, temperature and air pressure condition for the storage and shipment.

## Probe Labeling

Each probe is labeled with the following information:

- Seller's name and manufacturer
- Operating frequency (not shown on all probes)
- GE HealthCare part number
- Probe serial number
- Month and year of manufacture
- Probe designation-provided on the probe grip and the top of the connector housing, so it is easily read when mounted on the system and is also automatically displayed on the screen when the probe is selected.
- UDI Symbol and Data Matrix
- DI Human Readable LabelText: Global Trade Item Number, GTIN

The following information appears on all probe labels, regardless of the connector type, except for “IPX7,” “CE Mark,” and “XDclear™” which only appears on applicable probes.



Figure 2-6. Probe Label (Example)

- |  |  |
|--|--|
| 1. GE HealthCare Logo  | 9. CE Mark and Notified Body Number                          |
| 2. Probe Model (Name)  | 10. REF: Catalog/model number                                |
| 3. UDI Symbol and Data Matrix  | 11. Serial Number  |
| 4. UDI Human Readable LabelText: Global Trade Item Number, GTIN, (01), Manufacturing Date (11), Serial Number (21) | 12. Manufacturer's site country of origin                    |
| 5. Type BF/CF Applied Part   | 13. Legal Manufacturer's Name and Address                    |
| 6. Caution: Consult the Manual.  | 14. Date of Manufacture, as YYYY-MM                          |
| 7. WEEE Waste Symbol   | 15. Product Marketing Indicator information may appear here. |
| 8. Chinese RoHS Hazardous Substance Symbol   | 16. IP Classification  |
|  | 17. Symbol indicates the item is a medical device.           |

**NOTE:** *Non-GE HealthCare probes will also have a UDI symbol and equivalent information.*



---

## Chapter 3

# Preparing the System for Use

*Describes the site requirements, console overview, system positioning/transporting, powering on the system, adjusting the display monitor, probes and operator controls.*

# Site Requirements

## Introduction

Qualified and trained HealthCare professionals, including physicians, sonographers and equivalent/compareable professions, with at least basic ultrasound knowledge. Only qualified physicians or sonographers should perform ultrasound scanning on human subjects for medical diagnostic reasons. Request training, if needed.

Do not attempt to set up the system alone. GE HealthCare, Affiliate, or Distributor Field Engineers and Application Specialists will install and setup the system. See 'Contact Information' on *page 1-12 for more information*.

The LOGIQ Totus does not contain any operator serviceable internal components. Ensure that unauthorized personnel do not tamper with the unit.

Never set liquids on the unit to ensure that liquid does not drip into the control panel or unit.



## **Before the system arrives**

### **NOTICE**

This medical equipment is approved, in terms of the prevention of radio wave interference, to be used in hospitals, clinics and other institutions which are environmentally qualified. The use of this equipment in an inappropriate environment may cause some electronic interference to radios and televisions around the equipment.

Ensure that the following is provided for the new system:

- A separate power outlet with a 20 amp circuit breaker for 120 VAC for 120 V area, 10 amp circuit breaker for 250 VAC for 220/240 V area.
- Take precautions to ensure that the console is protected from electromagnetic interference.

Precautions include:

- Operate the console at least 5 meters (15 feet) away from motors, typewriters, elevators, and other sources of strong electromagnetic radiation (non-medical grade UPS must be at least 2 meters (6 feet) away from console).
- Operation in an enclosed area (wood, plaster or concrete walls, floors and ceilings) helps prevent electromagnetic interference.
- Special shielding may be required if the console is to be operated in the vicinity of radio broadcast equipment.

## Environmental Requirements

### LOGIQ Totus

The system should be operated, stored, or transported within the parameters outlined below. Either its operational environment must be constantly maintained or the unit must be turned off.

*NOTE: You may get an overheating message with regard to fan speed. Ensure adequate system/room ventilation.*

Table 3-1: System Environmental Requirements

	Operational	Storage	Transport (<16hrs.)
Temperature	10° - 35°C/50° - 95°F with 2D probe 18° - 30°C/64.4° - 86°F with 4D probe	-10° - 50°C 14° - 122°F	-10° - 50°C 14° - 122°F
Humidity	30 - 80% non-condensing	10 - 90% non-condensing	10 - 90% non-condensing
Pressure	700 - 1060hPa	700 - 1060hPa	700 - 1060hPa

**Probe**

Probes should be operated, stored, or transported within the parameters outlined below.

Table 3-2: Probe Environmental Requirements

	Operational
Temperature	10° - 35°C with 2D probe 18° - 30°C with 4D probe
Humidity	10 - 80% non-condensing for 2D probe 30 - 80% non-condensing for 4D probe
Pressure	700 - 1060hPa



CAUTION

Note that the environmental conditions of the ultrasound system and the probe may differ.



CAUTION

Ensure that the probe face temperature does not exceed the normal operation temperature range.



CAUTION

Check the room temperature before you use the 4D probe.

# Console Overview

## Console Graphics (LCD monitor)

The following are illustrations of the console:

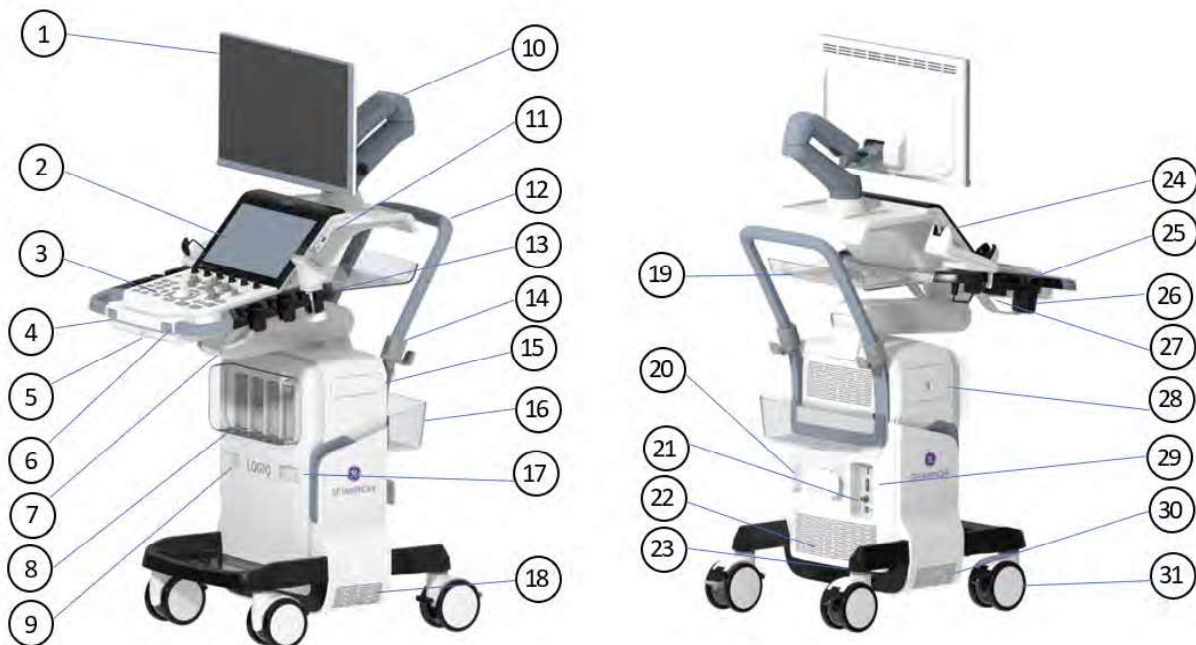

Figure 3-1. LOGIQ Totus System

- |   |   |
|---|---|
| 1. Monitor  | 18. Air filter (Inside the side cover right)                                  |
| 2. Touch panel  | 19. Control panel rear tray (Option)  |
| 3. Control panel with power on/off button                 | 20. Rear cable hook   |
| 4. Control panel swivel button                            | 21. DP, VGA, Composite, S-Video Connector (Option)                            |
| 5. Physical A/N keyboard (Option)                         | 22. Air filter (Inside the rear cover)  |
| 6. Control panel up/down button                           | 23. Circuit breaker, AC inlet   |
| 7. Probe cable management Hook (underneath Control panel) | 24. USB 3.0 Ports   |
| 8. Probe ports (4)  | 25. Probe holder left   |
| 9. CW probe port (Option)                                 | 26. Gel holder or Gel warmer (Option)   |
| 10. Monitor arm   | 27. Probe cable management Hook (underneath Control panel)                    |
| 11. USB 3.0 ports   | 28. B/W printer (Option)  |
| 12. Rear handle   | 29. Peripheral USB 3.0 ports, Ethernet Connector, HDMI connector, Audio input |
| 13. Probe holder right                                    | 30. Air filter (Inside the side cover left)                                   |
| 14. Rear handle cable hook (Option)                       | 31. Wheel (4)   |
| 15. V-Nav controller (Option)                             |   |
| 16. Rear basket (Option)                                  |   |
| 17. Patient I/O Port (Option)                             |   |

Console Graphics (HDU monitor)

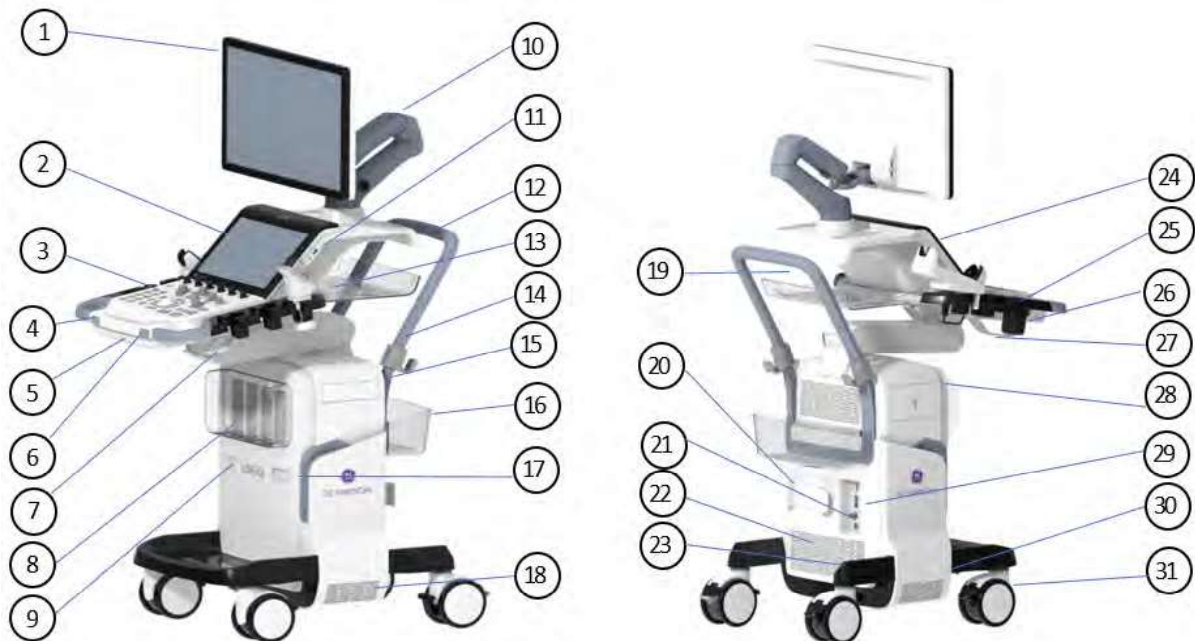

Figure 3-2. LOGIQ Totus System

- |   |  |
|---|--|
| <ul style="list-style-type: none"> <li>1. Monitor</li> <li>2. Touch panel</li> <li>3. Control panel with power on/off button</li> <li>4. Control panel swivel button</li> <li>5. Physical A/N keyboard (Option)</li> <li>6. Control panel up/down button</li> <li>7. Probe cable management Hook (underneath Control panel)</li> <li>8. Probe ports (4)</li> <li>9. CW probe port (Option)</li> <li>10. Monitor arm</li> <li>11. USB 3.0 ports</li> <li>12. Rear handle</li> <li>13. Probe holder right</li> <li>14. Rear handle cable hook (Option)</li> <li>15. V-Nav controller (Option)</li> <li>16. Rear basket (Option)</li> <li>17. Patient I/O Port (Option)</li> </ul> | <ul style="list-style-type: none"> <li>18. Air filter (Inside the side cover right)</li> <li>19. Control panel rear tray (Option)</li> <li>20. Rear cable hook</li> <li>21. DP, VGA, Composite, S-Video Connector (Option)</li> <li>22. Air filter (Inside the rear cover)</li> <li>23. Circuit breaker, AC inlet</li> <li>24. USB 3.0 Ports</li> <li>25. Probe holder left</li> <li>26. Gel holder or Gel warmer (Option)</li> <li>27. Probe cable management Hook (underneath Control panel)</li> <li>28. B/W printer (Option)</li> <li>29. Peripheral USB 3.0 ports, Ethernet Connector, HDMI connector, Audio input</li> <li>30. Air filter (Inside the side cover left)</li> <li>31. Wheel (4)</li> </ul> |
|---|--|



### DANGER

**DO NOT** touch the patient and any of the connectors on the ultrasound unit simultaneously, including ultrasound probe connectors. **DO NOT** touch the conducting parts of the USB, Ethernet, Video or Audio cables when connecting equipment to the unit. Failure to follow these instruction could lead to electrical shock.



### CAUTION

For compatibility reasons, use only GE HealthCare approved probes, peripherals or accessories.

**DO NOT** connect any probes or accessories without approval by GE HealthCare. Failure to follow these instructions could lead to unexpected diagnostic performance.

## **External drives (USB Flash Drive, USB HDD)**

Approved USB Hard Disk and USB Flash Drives may be used for Save As and Backup/Restore in the powered system USB ports.

You can use these to perform software upgrades, image archiving, and service diagnostics.

USB Drives are an ESD-sensitive device. Only use USB 2.0/3.0/ C Drives recommended by GE HealthCare.

### Speakers

Audio is provided via internal speakers.

**NOTE:** You make volume adjustments on the Utility Touch Panel (Master Volume, Effects Volume).

- Audio Doppler operation
- Audio playback of recorded scan sessions
- Audio error notification.

### Storage areas

Storage areas are available and can be used to store gel, options, probe cables, accessories, etc.



Figure 3-3. Storage area

1. Base tray - Max. allowable load : 2kg
2. Control panel rear tray (Option) - Max. allowable load : 1kg
3. Rear basket (Option) - Max. allowable load : 2kg

**NOTE:** DO NOT put the max. allowable load exceeded on the tray or basket.



## Install the TVTR Probe holder (Option)

Push the TVTR Probe holder into the left-side probe holder until it clicks as the picture below.



Figure 3-4. Install TVTR Probe holder



Figure 3-5. TVTR Probe Holder

When remove the TVTR probe holder from the system, pull the hook and pull out the probe holder.



Figure 3-6. Pull the hook to disassemble the probe holder

## Peripheral/Accessory Connection

### Peripheral/Accessory Connector Panel

LOGIQ Totus peripherals can only be properly connected using the peripheral/accessory connector panel. Available connectors are audio out, two USB 3.0 ports, HDMI port and Ethernet connector, with options DP, VGA, S-VIDEO and COMPOSITE.



#### DANGER

The connection of equipment or transmission networks other than as specified in these instructions can result in electric shock hazard. Alternate connections will require verification of compatibility and conformity to IEC/EN 60601-1 by the installer. Equipment modifications and possible resulting malfunctions and electromagnetic interference are the responsibility of the owner.



#### CAUTION

For compatibility reasons, use only GE HealthCare-approved probes, peripherals, or accessories.

**DO NOT** connect any probes or accessories without approval by GE HealthCare. Failure to follow these instructions could lead to unexpected diagnostic performance.

Table 3-3: Peripheral/Accessory Connector Panel

	<ol style="list-style-type: none"> <li>1. Audio Out</li> <li>2. RJ-45 Modular, 8-pin Ethernet</li> <li>3. USB 3.0 port</li> <li>4. USB 3.0 port</li> <li>5. HDMI connector</li> <li>6. DP connector (Option)</li> <li>7. VGA connector (Option)</li> <li>8. Composite connector (Option)</li> <li>9. S-Video connector (Option)</li> </ol>
--	--

### Unity Video Scaler and Converter (UVSC)

The LOGIQ Totus UVSC Option enables the ability for the console to view or record scanning via an DP, DVI, S-Video and Composite.

*NOTE: The S-Video and Composite image displays a portion of the main display that includes the probe image in both single and dual probe display modes. To provide increased resolution and maintain the proper aspect ratio on the S-Video and Composite display, the entire main display image is not projected on the S-Video and Composite monitor. The S-Video and Composite crop area was selected to optimize the probe image so when the console is not in an imaging mode the S-video and Composite will continue to display a cropped portion of the screen which may appear incorrect.*

## External Monitor

An external monitor can be connected to the LOGIQ Totus via the HDMI port, under the following guidelines:

- The display resolution must be set to (1080i) 1920x1080 on the external monitor, matching the main system display. Other resolutions are not supported.
- An isolation transformer must be used to power the external monitor to prevent adverse effects on the ultrasound scanner.
- It is the customer's responsibility to ensure leakage current and grounding is tested and complies with electrical leakage standards.



Figure 3-7. Connect HDMI Cable to back of LOGIQ Totus and External Monitor

## Front Panel Connections and Indicators

There are three sets of connector/indicators on the Front Panel: Hard Disk Drive and Network Status Indicators, CW Probe, Patient Cardiac/ECG Connections, and Volume Navigation (V Nav) Connections/Indicators

## Rear Panel Indicators

There are four sets of connector/indicators on the rear panel : SSD, Network and Battery Status Indicators

## Network Status Indicators

There are three front-panel status indicators:

Table 3-4: Local Drive and Network Status

	<ol style="list-style-type: none"><li>1. Local Drive Activity Status</li><li>2. Network Activity Status</li><li>3. Battery Activity Status</li></ol> <p>Charging : LED blinking Full charged : LED on Charge off (not full charge) or Discharging : LED off</p>
--	---

**Network and Spooler Status Icons**

The following icons identify network and spooler statuses. These appear on the display monitor.

Table 3-5: Network and Spooler Status Icons

Ethernet Active 	Ethernet Error 	Ethernet Active Spooler Active 	Ethernet Active Spooler Error 	Mobile 
Mobile Error 	Mobile Bluetooth 	Mobile Wifi 	Spooler Active 	Spooler Active Error 
Spooler Inactive 	Spooler Inactive Error 	Wifi 1 Bar 	Wifi 2 Bars 	Wifi 3 Bars 
Wifi 4 Bars 	Wifi Alert 	Wifi Spooler Active 	Wifi Spooler Error 	Wifi Error 

**NOTE:** The Mobile icons are used for the Smart Device Apps (Tablet and Mobile Phone).

**ECG Connections**

Table 3-6: ECG connection



	<ol style="list-style-type: none"> <li>1. ECG Connector</li> </ol>
---	--

Table 3-7: ECG Lead Placement

Lead	Patient Cable Marking		Position on Patient
	AHA	IEC	
I	RA (White)	R (Red)	Right Arm
II	LA (Black)	L (Yellow)	Left Arm
III	LL (Red)	F (Green)	Left Leg

**Volume Navigation Connections/Indicator**

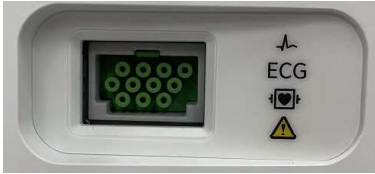
Table 3-8: Volume Navigation Connections

	<ol style="list-style-type: none"> <li>1. Non-V Nav Inside Probe V Nav Receiver Connector (2 cables)</li> <li>2. V Nav Needle Tip Tracker/Virtual Tracker Sensor Connector</li> <li>3. V Nav Active Tracker Connector</li> <li>4. V Nav Transmitter Indicator</li> <li>5. V Nav Transmitter Connector</li> </ol>
---	--



# Powering the System

## Connecting the System



DANGER

Under no circumstances should the AC power plug be altered, changed, or adapted to a configuration rated less than specified. Never use an extension cord or adapter plug.

To help assure grounding reliability, connect to a “hospital grade” or “hospital only” grounded power outlet.



DANGER

Use the appropriate power cord provided by or designated by GE HealthCare. Failure to follow these instructions could lead to exposure to electrical shock.



WARNING

Use caution to ensure that the power cable does not disconnect during system use.

If the system is accidentally unplugged, data may be lost.



WARNING

To avoid leakage current above safety limits as prescribed by IEC 60601-1 and to ensure continuity of protective earth, DO NOT connect LOGIQ Totus and mains-operated accessories to a single or multiple socket extension cord or power strip.

## Connecting the System (continued)

To connect the system to the electrical supply:

1. Ensure that the wall outlet is the appropriate type.
2. Ensure that the power switch is turned off.
3. Unwrap the power cable. Make sure to allow sufficient slack in the cable so that the plug is not pulled out of the wall if the system is moved slightly.
4. Attach the power plug securely into the wall outlet.
5. Push the power plug securely into the wall outlet.

**NOTE:** *Do not use an extension cord or adapter plug except for GE HealthCare approved UPS.*

6. Ensure the circuit breaker is on (Figure 3-8 a). See 'Circuit breaker' on *page 3-21 for more information.*



Figure 3-8. Circuit Breaker (a) and Power Plug (b)

## Circuit breaker

The Circuit Breaker is located under the rear panel of the system. On supplies main power to all internal systems. Off removes main power from all internal systems. The circuit breaker automatically shuts off power to the system in case of a power overload.

If a power overload occurs:

1. Turn off all peripheral devices.
2. Reactivate the Circuit Breaker switch.

The Circuit Breaker switch should stay in the **On** position (“I”); **DO NOT** hold the switch in the **On** position. If the Circuit Breaker switch remains **On**, follow the Power On procedure.

*NOTE: If the Circuit Breaker switch does **not** remain in the **On** position or trips again:*

1. Disconnect the Power Cable.
2. Call Service immediately.

**DO NOT** attempt to use the system.

### Power On

Press the Power On/Off switch to turn the power on. The circuit breaker must also be in the on position. See 'Circuit breaker' on page 3-21 for more information.

#### To turn on the system

1. Ensure that the unit is properly plugged into an AC outlet of sufficient capacity (120V/10A or 240V/5A).
2. Turn on the breaker at the back of the system (refer to Figure 3-8 on page 3-20). At this point, the On/Off switch should be turned off.
3. Momentarily press the On/Off switch. The switch turns on a light. (refer to Figure 3-9 on page 3-22 ).
4. The system should now go through its boot-up process with no further user intervention (approximately 1 to 2 minutes).



Figure 3-9. Power On/Off Switch Location

## Power Up Sequence

The system is initialized. During this time:

- The system boots up and the status is reflected on the monitor.
- Probes are initialized for immediate operation.

*NOTE: If no probe is connected, the system goes into freeze mode.*

- Peripheral devices are activated on power up.

After initialization is complete, controls on the Control Panel backlight and the default B-Mode screen is displayed on the monitor (if a probe is connected).

### Password Protection

#### Login

At login, you are notified that “You are accessing a diagnostic medical device that is provided by authorized usage only. Data stored on this device may be subject to various regulations including but not limited to regulations which govern disclosure and privacy of this data. By using this device you are acknowledging that you are authorized to do so and are trained in appropriate use and regulatory guidelines.”

*NOTE:* You can change the wording that appears on the Login screen. See ‘Logon Banner’ on page 10-157 for more information.

1. **Operator:** Enter the Operator ID.
2. **Password:** Enter Operator’s password (optional).
3. **Logon or Cancel.**
  - **OK:** Proceed with the logon
  - **Emergency:** Data stored only for the duration of the current exam (EUSR).
4. **Change Password:** Change password, as specified by the Password Policy.

## Initial Login to the LOGIQ Totus

When first logging in to the LOGIQ Totus:

1. The Administrator should log in, typing “ADM” as the Operator Login.

*NOTE: No password is needed for the initial administrator log in.*

*NOTE: The Touch Keyboard displays when a field is selected. Use the keyboard to enter the Operator ID and Password.*

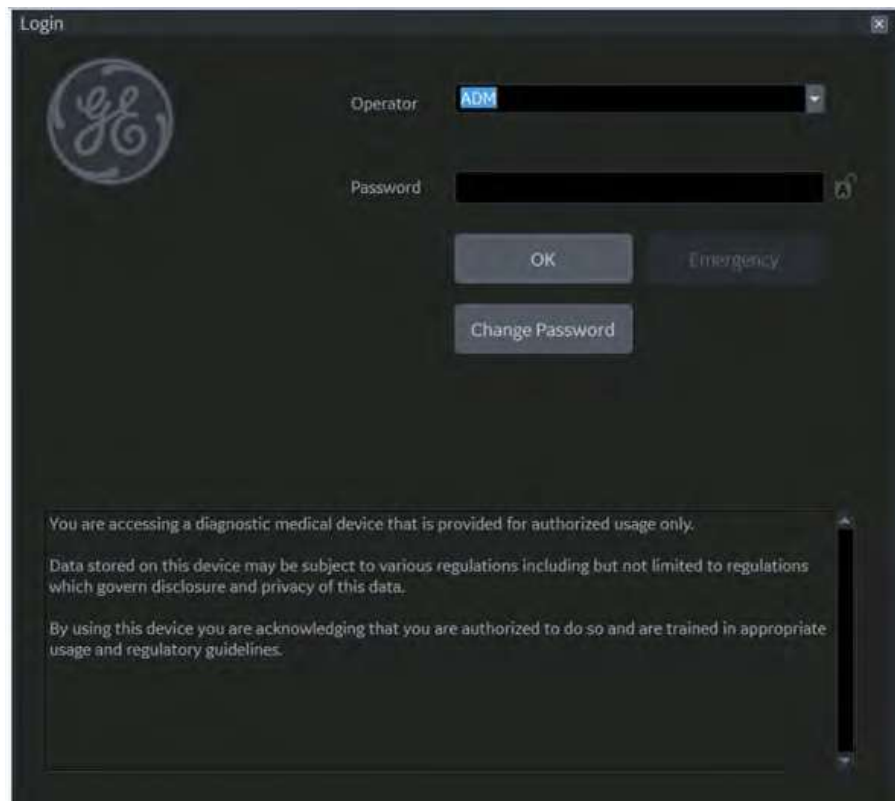

Figure 3-10. First Admin Login to the LOGIQ Totus

## Initial Login to the LOGIQ Totus (continued)

- Upon ADM Login, specify the institution's Default Security Level for the LOGIQ Totus: Lowest, Medium, High (Recommended), or Highest, then select **Apply Change**.

**NOTE:** You may choose Skip For Now up to 20 times total to postpone choosing the Security Level. After 20 skips the system will require a Security Level to be chosen.

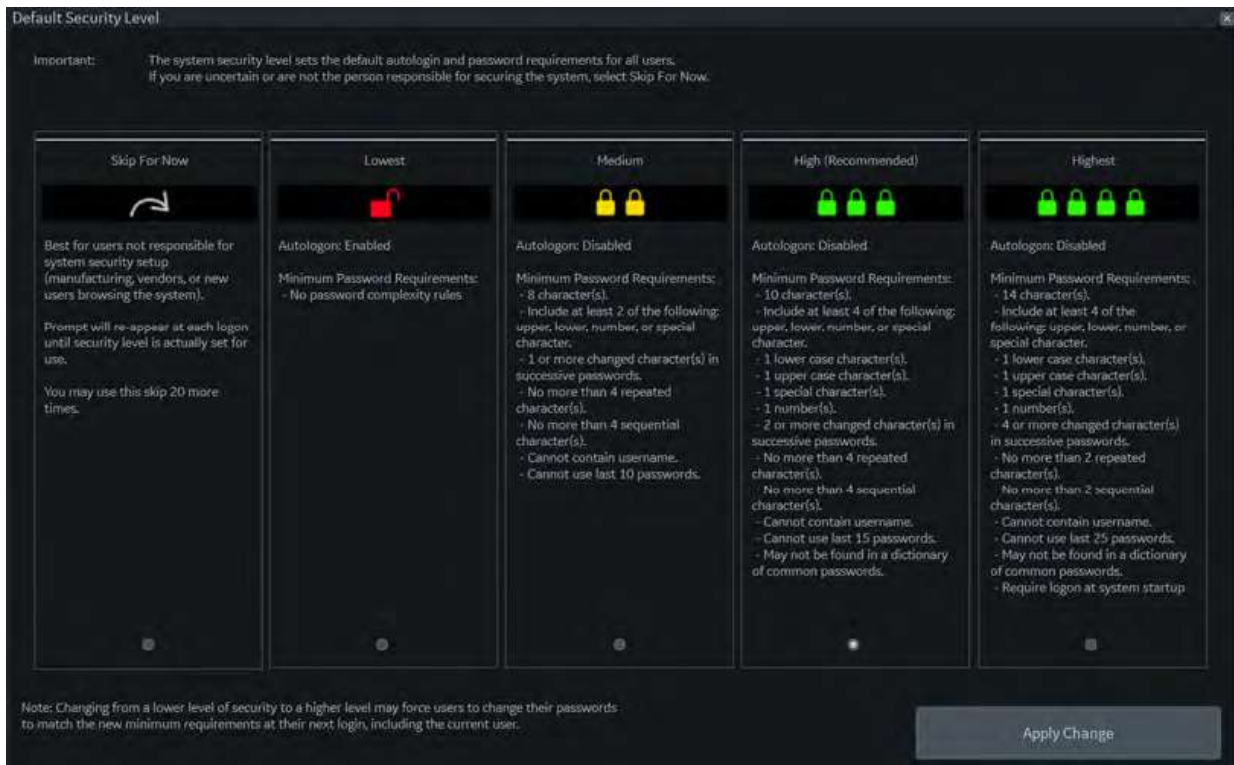

Figure 3-11. Default Security Level

Table 3-9: Security Levels

Security Level	Complexity Rules
Skip For Now	Best for users not responsible for system security setup (manufacturing, vendors or new users browsing the system). Prompt will re-appear at each logon until security level is set for use. This skip can be chosen 20 total times before the system will require a security level to be chosen.
Lowest	Autologon enabled. No password complexity rules.
Medium	Autologon disabled. Minimum Password Requirements: <ul style="list-style-type: none"> <li>• 8 characters.</li> <li>• Include at least two of the following: one upper case character, one lower case character, one number and/or one special character.</li> <li>• One or more changed character(s) in successive passwords.</li> <li>• No more than four repeated characters.</li> <li>• No more than four sequential characters.</li> <li>• Cannot contain username.</li> <li>• Cannot use the last 10 passwords.</li> </ul>



Table 3-9: Security Levels (Continued)

Security Level	Complexity Rules
High (Recommended)	<p>Autologon disabled. Minimum Password Requirements:</p> <ul style="list-style-type: none"> <li>• 10 characters.</li> <li>• One lower case character.</li> <li>• One upper case character.</li> <li>• One special character.</li> <li>• One number.</li> <li>• Two or more changed characters in successive passwords.</li> <li>• No more than four repeated characters.</li> <li>• No more than four sequential characters.</li> <li>• Cannot contain username.</li> <li>• Cannot use last 15 passwords.</li> <li>• May not be found in a dictionary of common passwords.</li> </ul>
Highest	<p>Autologon disabled. Minimum Password Requirements:</p> <ul style="list-style-type: none"> <li>• 14 characters.</li> <li>• One lower case character.</li> <li>• One upper case character.</li> <li>• One special character.</li> <li>• One number.</li> <li>• Four or more changed characters in successive passwords.</li> <li>• No more than two repeated characters.</li> <li>• No more than two sequential characters.</li> <li>• Cannot contain username.</li> <li>• Cannot use last 25 passwords.</li> <li>• May not be found in a dictionary of common passwords.</li> <li>• Require logon at system startup.</li> </ul>

### Initial Login to the LOGIQ Totus (continued)

3. If a Security Level is chosen, the Confirm Change screen appears.

If *Lowest* or *Medium* Security Level was chosen, you will be prompted to acknowledge that the security setting is lower than GE HealthCare recommends to secure the system. You will not be able to Confirm Change unless the “I Agree” box is selected.

If *Medium*, *High* or *Highest* Security Level was chosen, you can choose to change your password immediately and/or to force all users to change their password at next login.

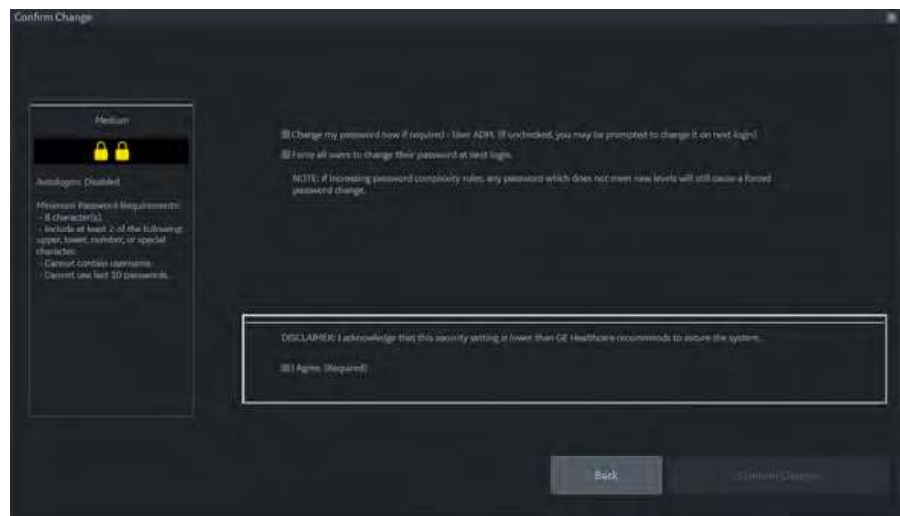

Figure 3-12. Confirm Change Screen

**Initial Login to the LOGIQ Totus (continued)**

4. You will be prompted to set up the ADM password, based on the selected Security Level.

**NOTE:** *If the password you type doesn't meet the selected Security Level's password complexity rules, the screen will prompt you (in red) to correct the password, as shown below.*

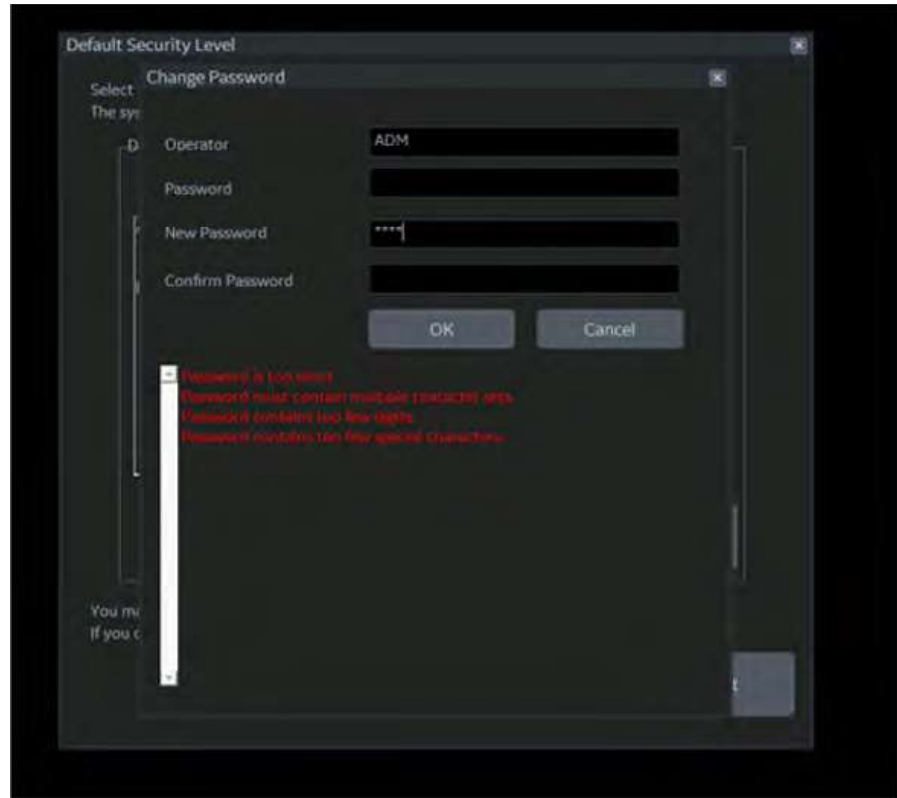

Figure 3-13. Change Password

### Initial Login to the LOGIQ Totus (continued)

5. After logging in, complete the system encryption setup. Navigate to the Disk Encryption Utility, Utility--> Admin--> Disk Encryption page. The system encrypts patient data by default (Encryption On. Disks are unlocked automatically). If you wish to change the default encryption setting, select the desired Encryption Policy, then press Accept.

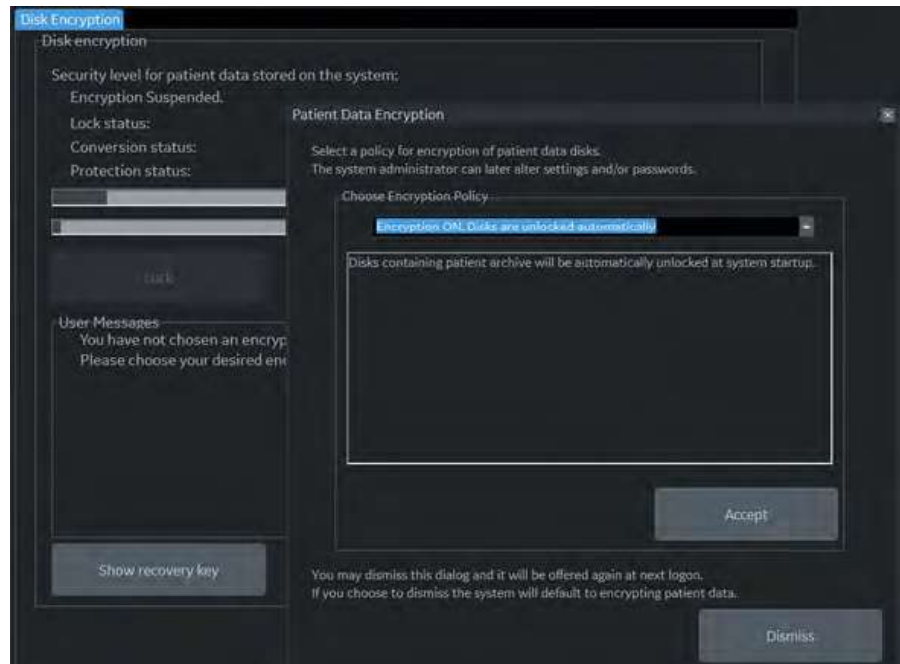

Figure 3-14. Initialize System Encryption

**NOTE:** *If you (or the Field Service Engineer) reloads system software, you will need to press “Initialize System Encryption” to encrypt the system and reset System Encryption password and preferences.*

## Initial Login to the LOGIQ Totus (continued)

Table 3-10: Encryption Policy Selections

Encryption Policy	Description
Encryption OFF	Patient Data will not be encrypted. Selecting "OFF" will unencrypt the drive. System drive and recovery partition will remain encrypted.
Encryption ON. Disks are unlocked automatically	System Default. Patient data is encrypted and unlocked at system boot-up. Recovery Key and Password tied to the hard drive.
Encryption ON. Require Pre-Boot PIN/Password before unlocking system drives	The system will not boot until the Pre-Boot PIN or Password has been entered. Unlike other manual key entry configurations, <b>no system functionality</b> is available without the PIN/Password. This encryption policy is intended for high security environments or customers with specific needs.
Encryption ON. Key is stored on USB/password is entered manually	The system will request the encryption password or recovery key at system startup. The system is not accessible until this password or a disk recovery key is provided. Requiring a password to access the patient archive may prevent emergency usage of the system.

**NOTE:** *If you choose to dismiss this dialog, this dialog will be offered to you again at the next logon.*

### Initial Login to the LOGIQ Totus (continued)

6. You must set the Encryption Password and record the Recovery Key in order to ensure access to your institution's patient data (required if replacing the system drive, ECB Board, or reformatting the C:\ Drive).

Recovery Keys are not backed up by the system; you must record / archive the Recovery Key in order to retrieve patient data.

- a. Reset the Encryption Password by pressing "Change password".

Reply "**No**" to this Question, "Password is already set on a disk. Do you want to reuse it? Press **No** to delete existing password. You will be prompted to set new.

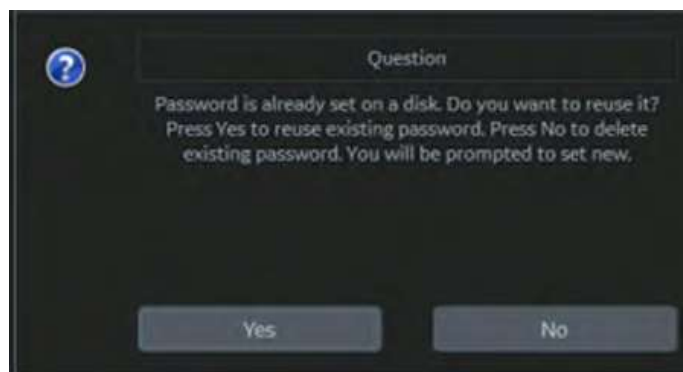

You can now update the encryption password, then press **OK**.



### Initial Login to the LOGIQ Totus (continued)

- b. Record the Recovery Key by pressing “Show recovery key”, then printing it to a local printer or PACS. Or, save the Recovery Key to a USB Flash Drive by pressing “Save recovery keys”.

```
Recovery Keys
HW Number: engineer_500469057
Drive Letter: D:
Full recovery key identification: B1026E15-1930-4AFA-8242-23CD8D3C5825
BitLocker Recovery Key: 211178-413270-085998-416427-664752-148687-189992-430155
Drive Letter: E:
Full recovery key identification: 64C8EF7D-DS4F-49AC-87D1-EEEE25D0FCAA
BitLocker Recovery Key: 211178-413270-085998-416427-664752-148687-189992-430155
Drive Letter: V:
Full recovery key identification: 0F6163AC-A86C-47BC-9AAA-A67D9B628C67
BitLocker Recovery Key: 211178-413270-085998-416427-664752-148687-189992-430155
```

You can Show or Hide the Encryption key. Store the Recovery Key in a secure location, accessible to the ADM user as necessary.

### Encryption Notes

The system is usable while it is being encrypted. Encryption can take between 20 minutes and several hours, depending upon system configuration; a status bar tracks encryption progress. It is a background task. You can scan while the system is being encrypted. You can also power the system down and back on while the disk is being encrypted; disk encryption will pick up where it left off in the encryption process.

### Changing Your Password

The System Administrator manages system groups, users, and permissions. After you have been added as a valid user, the System Administrator will assign you a temporary password. When you log into the system for the first time, you will be prompted to change your password.

You can change your password at any time when first logging onto the system. To change your password

1. Type your name in the Operator field.
2. Press the Change Password button. The Change Password pop-up appears.

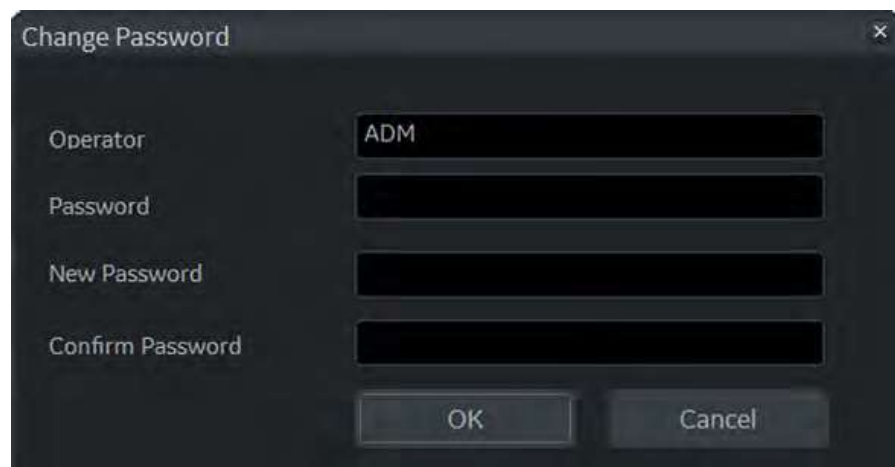

The image shows a 'Change Password' dialog box with a dark background. It has a title bar with the text 'Change Password' and a close button (X) in the top right corner. Below the title bar are four text input fields arranged vertically. The first field is labeled 'Operator' and contains the text 'ADM'. The second field is labeled 'Password'. The third field is labeled 'New Password'. The fourth field is labeled 'Confirm Password'. At the bottom of the dialog are two buttons: 'OK' on the left and 'Cancel' on the right.

Figure 3-15. Password Change

3. Type the following:
  - **Password:** Type your current password.
  - **New Password:** Type your new password.
  - **Confirm Password:** Retype your new password.

**NOTE:** *If you do not wish to set a password, or to change your password, select OK to continue.*



## Emergency User

If an Emergency User has been enabled by the Administrator via Utility--> Admin--> Logon, they need to login as "EUSR."

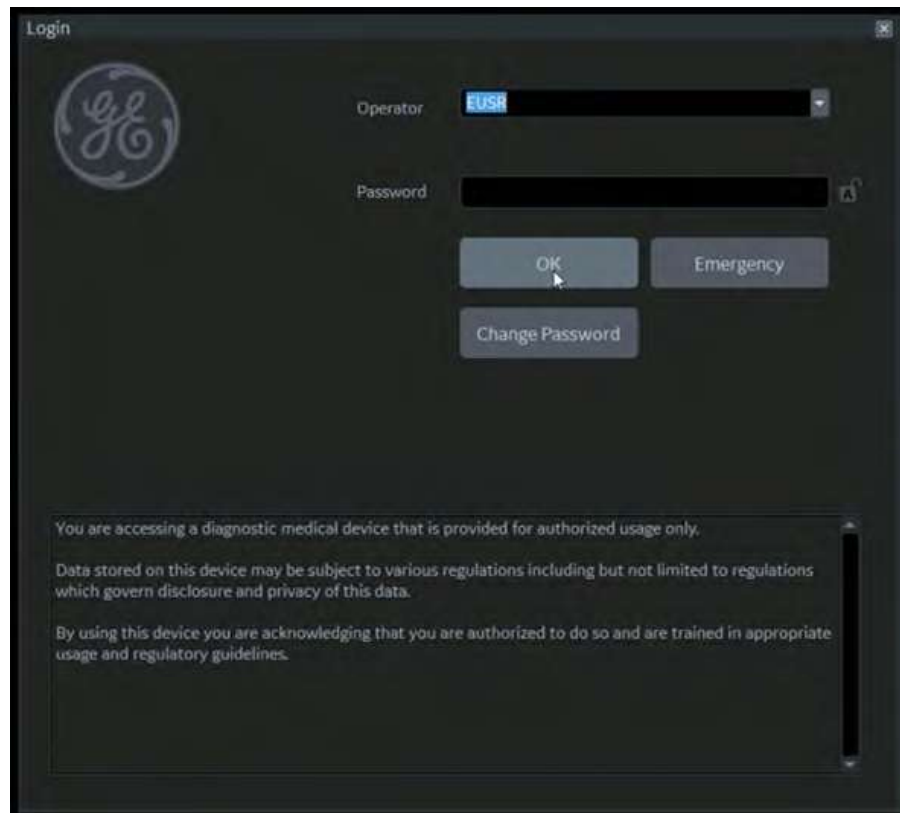

Figure 3-16. Emergency User

User Rights for the Emergency User are set by the Administrator via Utility--> Admin--> Groups. Emergency Users do not have access to your institution's patient data, as shown in the example below.

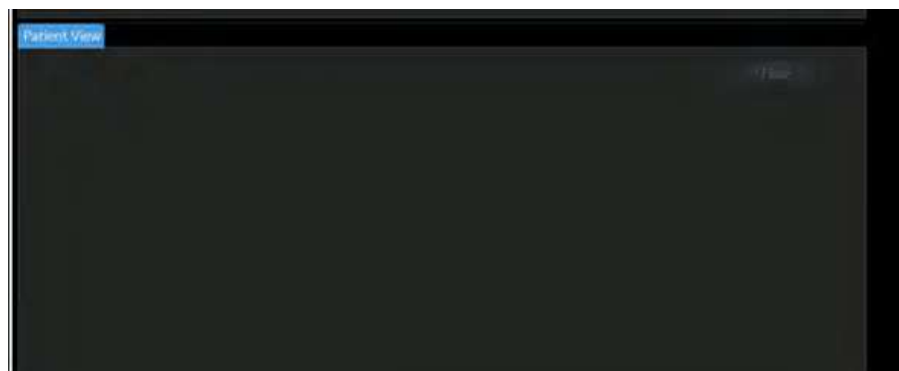

Figure 3-17. Patient Information Not Accessible

### Logoff

To logoff, press the **Power On/Off** switch momentarily and a SYSTEM-EXIT window appears.

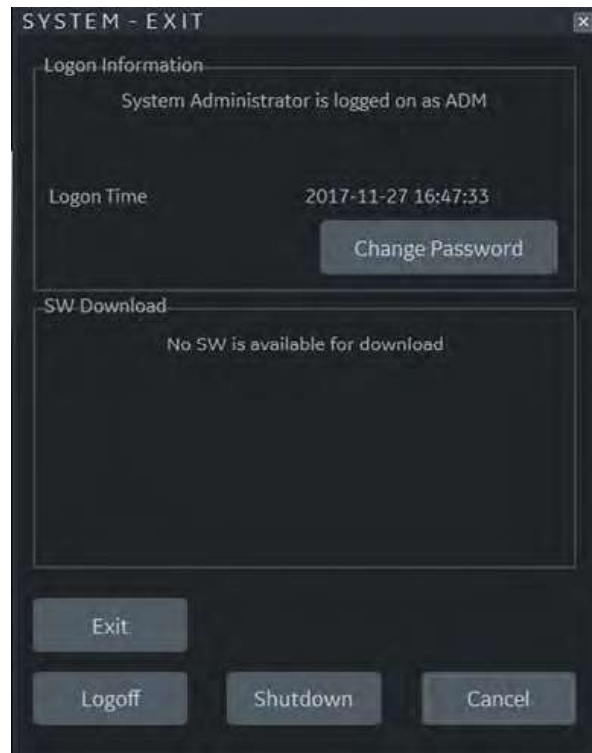

Figure 3-18. System Exit Window

## Power Off

For optimum system operation, we recommend that you restart the system at least once every 24-hour period. If you shut down the system at the end of the day, no other action is needed.



### WARNING

To avoid losing patient data, ensure that you have properly ended the patient's exam and transferred all exam data / images / clips.

To power off the system:

1. Set the brake and use the operator panel movement controls to lock the control panel in place.
2. When you shutdown the system, enter the scan screen and lightly press the **Power On/Off** switch at the front of the system once. The System-Exit window is displayed.

### NOTE:

*DO NOT press and hold down the Power On/Off switch to shutdown the system. Instead, lightly press the Power On/Off switch and select Shutdown.*

### Power Off (continued)

- Using the **Trackball**, select Shutdown.

The shutdown process may take up to two (2) minutes and is completed when the control panel illumination shuts down.

**NOTE:** *If a system shutdown is initiated while the system is still processing an incoming or outgoing DICOM job, a dialog box appears, notifying the user to confirm shutdown, check the spooler status or cancel the shutdown (see Figure 3-19).*

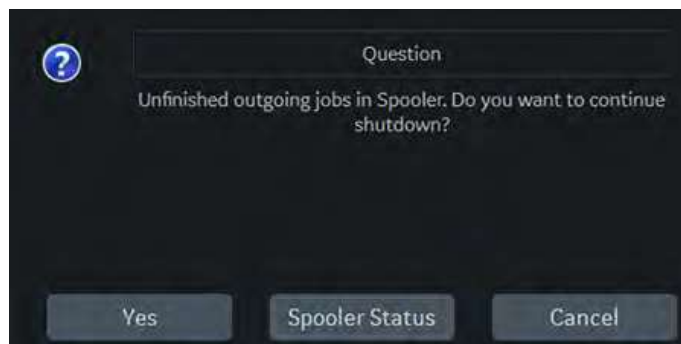

Figure 3-19. Confirm Shutdown

- Disconnect the probes.

Clean or disinfect all probes as necessary. Store them in their shipping cases or another appropriate probe storage system to avoid damage.



#### WARNING

**DO NOT** turn off the circuit breaker before the Power On/Off switch LED is white.

Data may be lost or system software damaged if the circuit breaker is turned off before the Power On LED is white.

**NOTE:** *When the Power Assistant is installed, Power Assistant battery replacement may be necessary if the circuit breaker is turned off for long periods of time (3 to 6 months).*

## **Crash Recovery Instructions**

In case of a system crash, power cycle the system. Upon boot-up, all images and measurements, except for generic worksheets, are preserved in the system. When the system returns, the system alerts you that unsaved images are still in the system from the previous patient. Respond to the prompt to continue the current patient. Check that all images and measurements have been preserved in the system. Then resume the exam.

If the system fails to respond to your commands within a typical period of time, you need to manually reset the system. Simply hold down the power switch to initiate a normal power down sequence. After the system has completely shut down (power switch white), restart the system using the standard power-up sequence. All images and measurements, except for generic worksheets, are preserved in the system. When the system has fully powered up, the system alerts you that unsaved images are still in the system from the previous patient. Respond to the prompt to continue the current patient. Check that all images and measurements have been preserved in the system. If you do not have any images on the clipboard, the patient must be retrieved from the database. Then resume the exam.

# System Language Configuration

## Select the System Language and Date/Time Format

The default operating system language and keyboard may be changed from the Utility > System > General page.

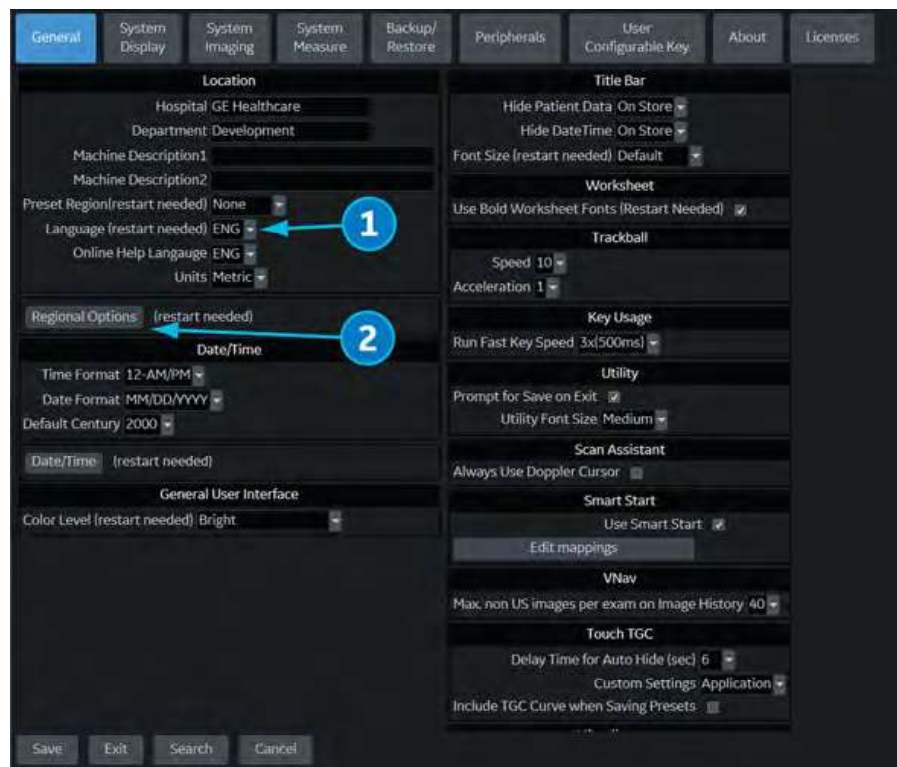

Figure 3-20. Utility System General Screen

1. Select the desired system language from the **Language** dropdown menu (1). Then select **Save** at the bottom left of the screen. Do NOT restart yet.
2. Select **Regional Options** (2) to open the Regional Options Dialogue Box

## Select the System Language and Date/Time Format (continued)

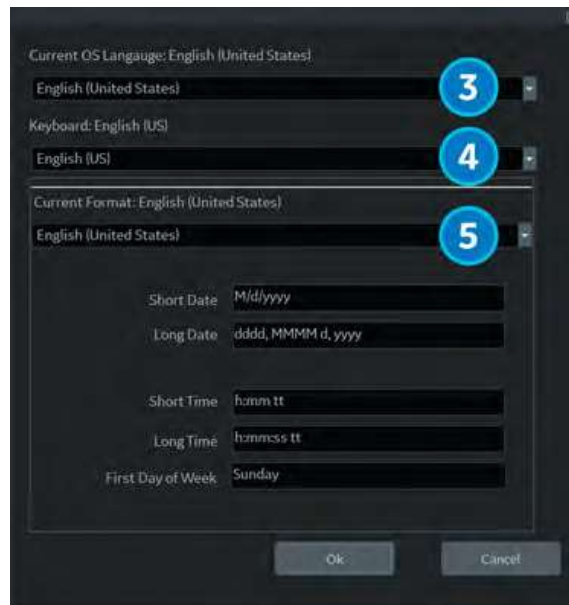

Figure 3-21. Regional Options Dialogue Box

3. Select the following Regional Options:
  - **Current OS Language** - Select the language from the dropdown menu (3) to match the system language selected in Step 1.
  - **Keyboard** - Select the keyboard language preference from the dropdown menu (4).
  - **Current Format** - Select the date and time format preference from the dropdown menu (5).
4. After making changes to the Regional Options, select **OK**; when prompted to restart, choose **OK** again to restart system.

**NOTE:** *For the United Kingdom, it is recommended to use ENG Language (1), English (United States) OS Language (3), and modify "Current Format" time/date settings to English (United Kingdom) (4) (see Figure 3-21 on page 3-41).*

### Change the Keyboard Language (Temporary)

To temporarily change the keyboard language, press the left Alt+Shift keys on the keyboard to toggle through all available keyboard languages until you reach the desired language.

**NOTE:** *When the system is restarted, the keyboard language will return to the keyboard language last set in Regional Options.*

### **English (International) Keyboard**

When the system language is set to English (United States), pressing the Ctrl+Shift on the keyboard toggles between the English (United States) keyboard and the English (International) keyboard.

### **Apostrophe/Quotation Marks**

To type an apostrophe or quotation marks while using the English (International) keyboard, you must press the space key after the apostrophe or quotation mark to display the character.



### Preset Restore User Interface Corruption

When restoring presets with the user interface in Russian, Greek, Japanese or Simplified Chinese, if the OS Region Language does not match the selected system software application language at the time of the preset restore, the user interface text may appear corrupted.

To prevent the corruption, before restoring presets, confirm that the OS Region language and system software application language match by following the procedure below, 'Match the OS Language with System Software Application Language' on *page 3-43*, referring to Figure 3-22.

If the corruption has already occurred and the text on the screen is not readable, follow the same procedure ('Match the OS Language with System Software Application Language' on *page 3-43*) to correct the settings, referring to Figure 3-23, which shows the location of the Regional Options and Language fields on the corrupted screens.

#### Match the OS Language with System Software Application Language

Change the default operating system language on the Utility > System > General page.

1. Select **Regional Options** to open the Regional Options dialogue box (1).
2. Select **Current OS Language** and select the OS language from the dropdown menu to match the system language (2).
3. Select **OK** (3). The system will restart.

Match the OS Language with System Software Application Language (continued)

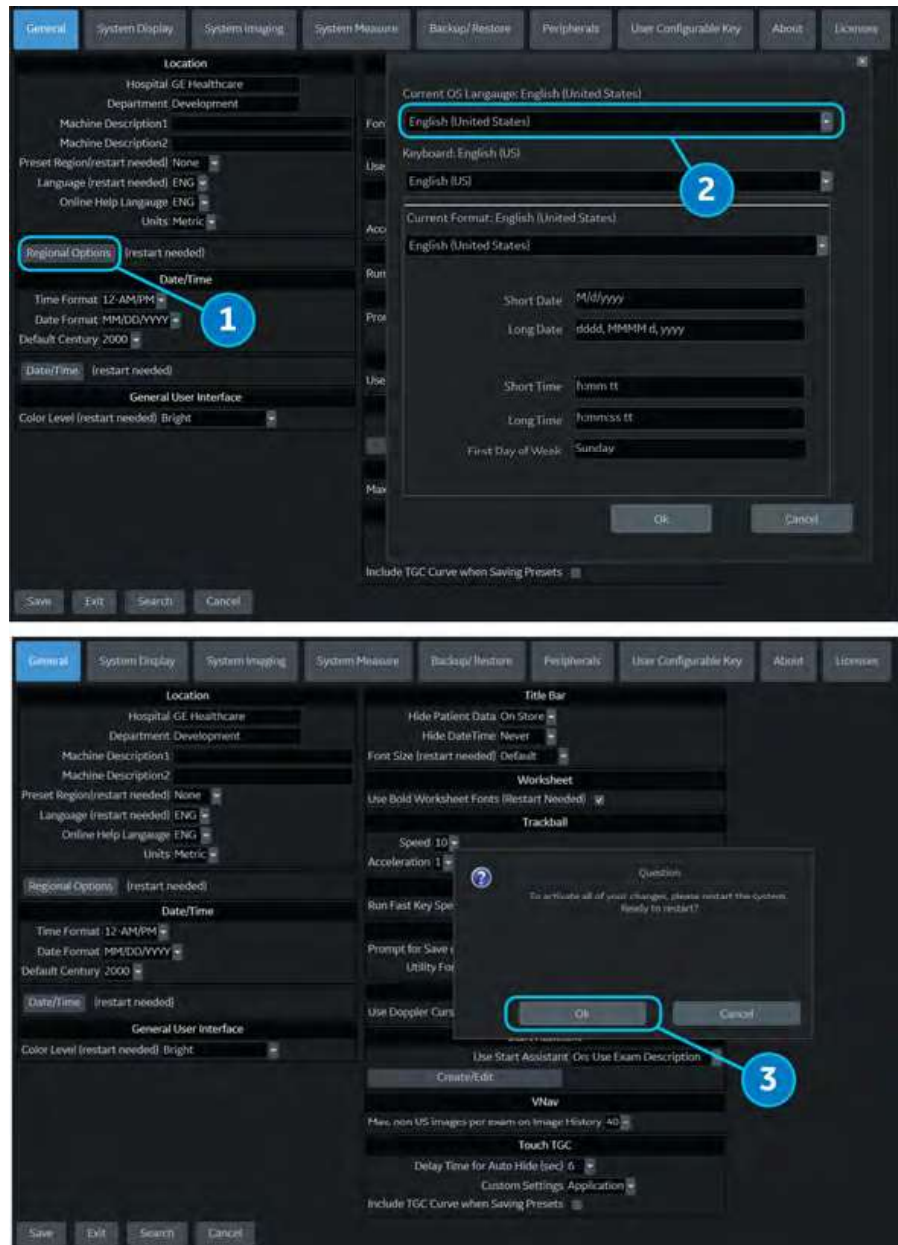

Figure 3-22. Match OS Language with System Software Application Language (Preventative)

Match the OS Language with System Software Application Language (continued)

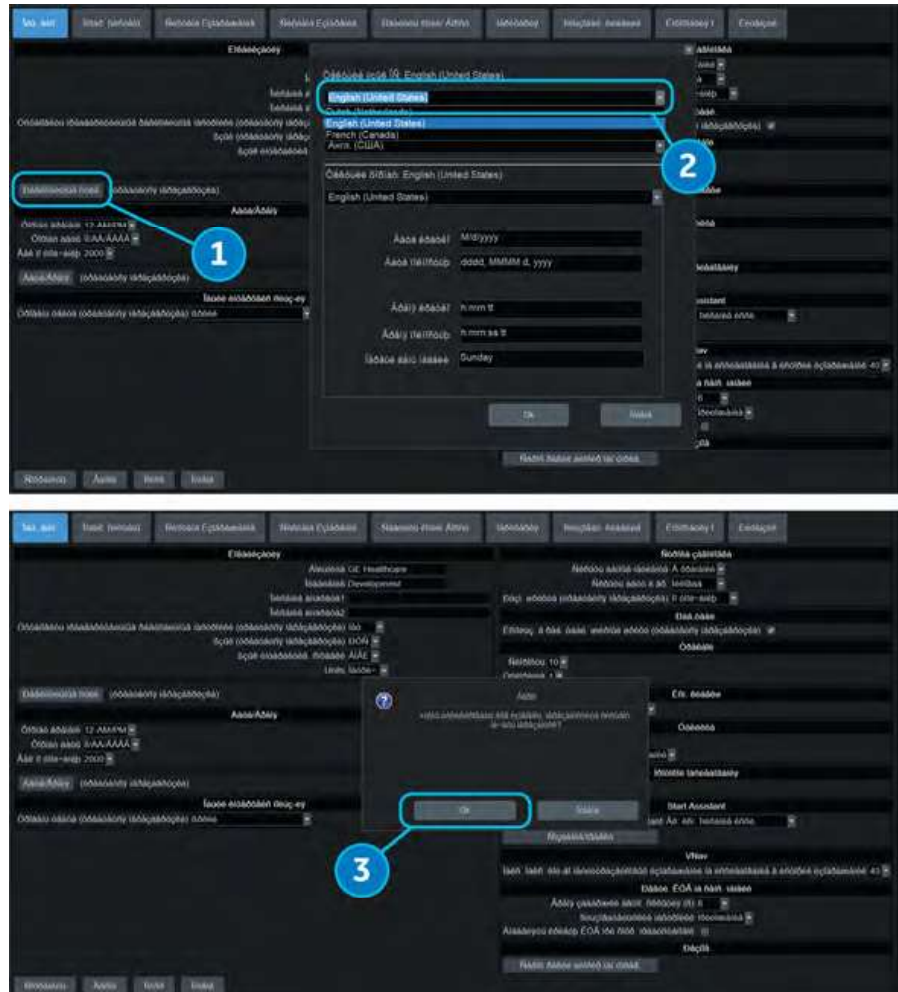

Figure 3-23. Match OS Language with System Software Application Language (Corrective)

# Connecting the Probe

## Connecting the Probe



### DANGER

Fault conditions can result in electric shock hazard to user/patient. Do not touch the surface of probe connectors which are exposed when the probe is removed. Do not touch the patient when connecting or disconnecting a probe.



### CAUTION

Inspect the probe before and after each use for damage or degradation to the housing, strain relief, lens, seal, cable and connector. **DO NOT** use a transducer which appears damaged until functional and safe performance is verified. A thorough inspection should be conducted during the cleaning process.

Probes can be connected at any time, regardless of whether the console is powered on or off. To ensure that the ports are not active, place the system in the image freeze condition.

To connect a probe:

1. Place the probe's carrying case on a stable surface and open the case.
2. Carefully remove the probe and unwrap the probe cord.
3. **DO NOT** allow the probe head to hang free. Impact to the probe head could result in irreparable damage. Use the integrated cable management hook to wrap the cord.

## Connecting the Probe (continued)

4. Prior to inserting the probe, ensure that the connector locking handle is positioned to the left.
5. Align the connector with the probe port and carefully push into place.

**NOTE:** *When connecting the probe, DO NOT turn the locking lever if resistance is felt. If this is the case, remove the probe connector and check for misaligned or damaged pins. Probes with damaged connector pins should be taken out of service immediately.*

6. Turn the connector locking handle to the right to secure the probe connector.
7. Carefully position the probe cord so it is free to move and is not resting on the floor.



Figure 3-24. Probe port

1. Active probe port
2. Pencil probe port

## Unpacking



CAUTION

If the packaging has been

- Damaged.
- Unintentionally opened before use.
- Exposed to environmental conditions outside of those specified.

Contact your GE HealthCare representative

### **Chirping noise**

- Probes may generate slight audible noise emissions when operated in volume mode
- The repetitive transmission of ultrasound-pulses can generate audible high frequency sounds in the transducer. The frequency and loudness of these sounds (chirping sound) varies with operating mode and U/S image penetration. This sound is due to normal operation and does not indicate degradation of probe safety, performance, or reliability.

### **Cable Handling**

Take the following precautions with probe cables:

- Keep free from wheels. Use the cable hooks located below the operator panel.
- Do not bend the cable acutely
- Avoid crossing cables between probes.

## Selecting probes

To activate the probe, select the appropriate probe from the probe indicators on the Touch Panel.

1. Select the probe that provides optimum focal depths and penetration for the patient size and exam.
2. Select the exam application.
3. Select the application preset.
4. Begin the scan session using the default Power Output setting for the probe and exam.

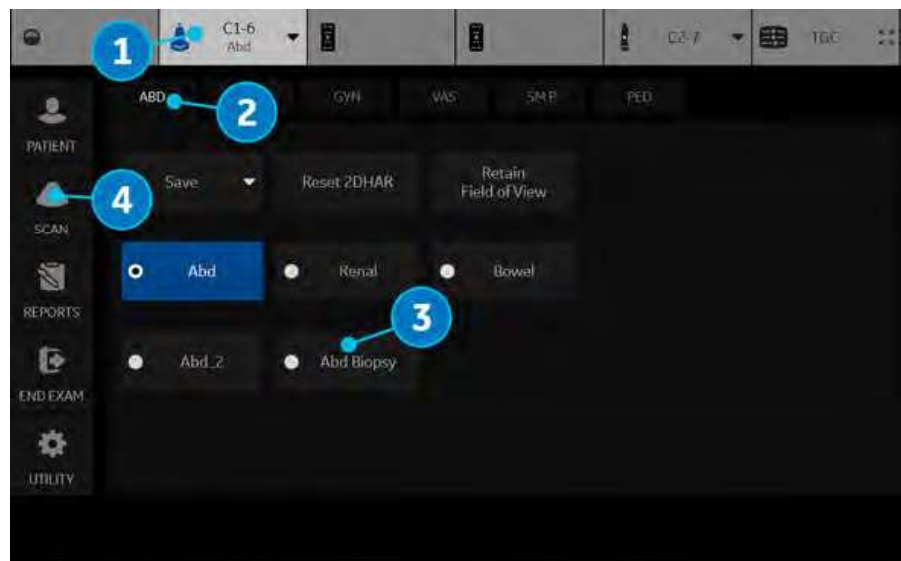

Figure 3-25. Probe Application/Preset Touch Panel

The probe's default settings for the mode and selected exam are used automatically.

**NOTE:** *Selecting a new probe unfreezes the image.*

### Deactivating the Probe

When deactivating the probe, the probe is automatically placed in freeze mode.

To deactivate a probe:

1. Ensure the selected probe is deselected or the LOGIQ Totus is in freeze mode. If necessary, press the **Freeze** key.
2. Gently wipe the excess gel from the face of the probe.
3. Carefully slide the probe around the right side of the keyboard, toward the probe holder. Ensure that the probe is placed gently in the probe holder.

### Disconnecting the Probe



CAUTION

DO NOT allow the probe head to hang free. Impact to the probe head could result in irreparable damage. Use the integrated cable management hook to wrap the cord.

Probes can be disconnected at any time. However, the probe should not be active when disconnecting the probe.

1. Ensure the probe is deactivated. Deactivate by selecting another probe or pressing Freeze.
2. Move the probe locking handle to the left.
3. Pull the probe connector straight out of the probe port carefully.
4. Carefully slide the probe and connector away from the probe port and around the right side of the keyboard.
5. Ensure the cable is free.
6. Be sure that the probe head is clean before placing the probe in its storage box or wall hanging unit.



## Storing the Probe

It is recommended that all probes be stored in the provided carrying case or in the wall rack designed for probe storage.

Carrying case:

- First place the probe connector into the carrying case.
- Carefully wind the cable into the carrying case.
- Carefully place the probe head into the carrying case. DO NOT use excessive force or impact the probe head.

## Storage/Transportation



DANGER

Placing a dirty or contaminated probe in a carrying case or shipping carton will contaminate the foam insert. Failure to follow proper cleaning guidelines could lead to patient exposure to contaminant.

Each probe should be supported in its own probe holder on the console. If a carrying case is provided with the probe, always use the carrying case to transport the probe from one site to another.

Secure the probe in its holder for moving short distances.

When transporting a probe a long distance, store it in its carrying case.

If possible, use a rigid container with a lid that secures the probe's connector in place so as not to damage the probe head or lens. Place a soft cloth in the bottom of the container to prevent movement during transport.

# Operator Controls

## Control Panel Map

Controls are grouped together by function for ease of use.



Figure 3-26. Control Panel

- |   |   |
|---|---|
| 1. Probe Holder and Cable Management                | 7. Trackball, Trackball keys, Pointer, Measure, Comment, Body pattern, Clear, Zoom, Programmable keys |
| 2. Touch Panel                                      | 8. L/R, Start/Stop, Freeze keys   |
| 3. Joystick controls                                | 9. Steer/Width/Depth/Reverse joystick   |
| 4. On screen keyboard (not display in this graphic) | 10. Auto, CF/PW auto positioning  |
| 5. User defined keys                                | 11. P1, P2  |
| 6. Mode/Gain/XYZ (3D) controls                      |   |

## Control panel adjustment



### CAUTION

To avoid injury or damage, make sure nothing is within the range of motion before moving the control panel. This includes both objects and people.

Ensure that the hands of the patient are away from the Control panel arm when moving the Control panel.

### To raise/lower the control panel

1. Hold the front handle in two hands.
2. Push and hold down the Up/Down button next to the right front handle.
3. Raise or lower the control panel.
4. Release the Up/Down button at the desired height.



Figure 3-27. Up/Down control button

**To swivel the control panel**

1. Hold the front handle in two hands.
2. Push and hold down the swivel button next to the left front handle.
3. Move the control panel to the left or the right.
4. Release the swivel button at the desired position.



Figure 3-28. Swivel control button

## Keyboard

### On Screen Keyboard

You can use "On Screen Keyboard" on touchscreen. Keyboard will show up when you press "Keyboard" User Defined key. And you can hide it with "Exit" button on Keyboard or Keyboard UD key.



Figure 3-29. On Screen Keyboard



Figure 3-30. Keyboard User Defined key

### Physical A/N keyboard (Option)

Physical A/N keyboard is under the control panel.



Figure 3-31. Physical A/N keyboard

Push the keyboard to project forward.



Figure 3-32. Push the keyboard

## Functional keys

The standard alpha-numeric keyboard has some special functions.

Table 3-11: Special key function

Keyboard key	Function
Esc	Exit current display screen.
F1	Help Access Online help/user manual.
F2	Arrow Annotation Arrow.
F3	Eject Eject media.
F4	Spooler Activates DICOM Job Spooler screen.
F5	Creates a Fast Key.
F6	Plays a Fast Key.
F7	Home/Set Home Move annotation cursor to home position; shift+key to set current annotation cursor position as the new home position.
F8	Text1/Text2 Switch between user text annotation overlays.
F9	Grab Last Activate the last selected data for edit.
F10	Word delete Erase word associated with comment cursor.

If you encounter a problem and cannot collect the logs immediately:

Table 3-12: Key for collecting the log

Keyboard key	Function
Alt+1 or Alt+2	Place a marker in the log.
Alt+D	Collect the logs.

Once the logs are collected, the engineering team would be able to see the marker you added which will help engineering to troubleshoot the problem.

### Touch Panel

The Touch Panel contains exam function and mode/function specific controls.

#### Exam Function Controls

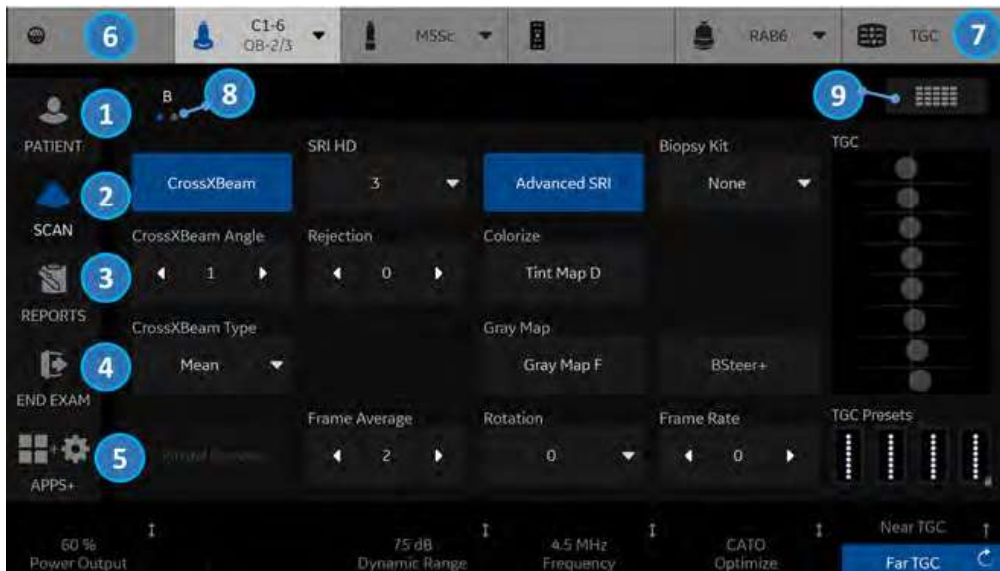

Figure 3-33. Exam Function Controls

1. Patient: Enters Patient screen
2. Scan: Enters scanning mode screen
3. Reports: Activates default report and Touch Panel of report choices.
4. End Exam: Activates Image Management and Touch Panel with end of exam options.
5. APPS+: Activates Apps and Utility.
6. Probe Indicator: Indicates and selects the probes.
7. TGC Control: Activates TGC function.
8. Indicates the number of pages for this mode. To move to the next page, touch the “dot” or swish your hand from right to left/left to right.
9. To view all/fewer of the controls for this Touch Panel, press this Research/Clinical button.

**NOTE:** *Different menus are displayed depending on which Touch Panel Tab is selected.*

At the bottom of the Touch Panel, there are six combination rotary dials/push buttons. The functionality of these rotaries changes, depending upon the currently-displayed menu. Press the button to switch between controls, or rotate the dial to adjust the value, or move the control left/right or up/down to adjust the value.



## Mode/Function Specific Controls

In general, the key name is indicated at the top of the key. There are different types of Touch Panel keys as illustrated below:



Figure 3-34. Mode/Function Specific Controls

1. Press to toggle control on/off.
2. Progress/Select keys are used for controls that have three or more choices.
3. Progression keys are used to assess the impact of the control on the image progressively.
4. 3-way functionality knobs (below the Touch Panel): Adjust controls by pressing (dot symbol), rotate (circled arrow symbol), move up/down (vertical line with arrows) or left/right (horizontal line with arrows).

### Mode, Display and Print

This group of controls provides various functions relating to the display mode, display orientation, image recording/saving, freeze, gain and Cine scroll.

The Mode Controls select the desired display mode or combinations of display modes.

- During dual display modes the **L** and **R** keys activate the Left or Right displayed image. See 'Split Screen' on *page 6-18 for more information*.
- Auto is used to:
  - initiate auto optimize.
  - turn off auto optimize.
- Depth controls the image display depth.
- The Reverse key (via Depth key if preset) toggles the left/right orientation of the scan image.
- Print keys are used to activate/print the designated recording device.
- The Freeze key is used to stop the acquisition of ultrasound data and freeze the image in system memory. Pressing **Freeze** a second time continues live image data acquisition.
- To activate a specific mode, press the appropriate mode key.

Each mode has its own gain control via the larger gray knob surrounding the mode key.

## Measurement and Annotation

This group of controls performs various functions related to making measurements, annotating and adjusting the image information.

- The Comment key enables the image text editor and displays the annotation library Touch Panel.
- The Clear key is generally used to erase functions, such as annotations/comments, body patterns and measurements. Pressing the Clear key again exits the selected function.
- The Body Pattern/Ellipse control has a dual purpose:
  - Press the Body Pattern/Ellipse control, it enables the Body Pattern Touch Panel and displays the default pattern on the screen. When body patterns are active, the knob rotates the probe position indicator.
  - Rotate the Body Pattern/Ellipse control, it activates the ellipse measurement function after the first distance measurement has been set and the second caliper is activated.

Press Set to fix the measurement after the ellipse adjustment is complete. The measurement is then displayed in the measurement result window.

- The Measure key is used in all types of basic measurements. When the Measure key is pressed, the measurement Touch Panel is displayed.
- The Set key, located on the Trackball on-screen controls, is used for various functions, but is generally used to fix or finish an operation (e.g. to fix a measurement caliper).
- The Trackball is used with almost every key function in this group. Trackball control depends on the last key function pressed.

## Adjusting the Monitor Position



CAUTION

**DO NOT** apply force to the monitor surface by finger or other hard object.

The monitor surface may be damaged and permanently discolored.

- LCD Monitor



- HDU Monitor

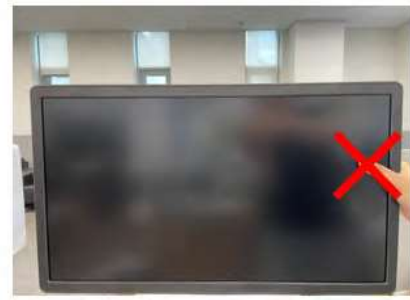

## Adjusting the Monitor Position (continued)



### CAUTION

If any defects or damages are observed on the display screen or monitor itself, do not operate the equipment but inform a qualified service person.

Contact a Service Representative for information.

Grab the frame of the monitor with both hands when you adjust the position of the monitor and monitor arm.

Table 3-13: How to grab (LCD Display)

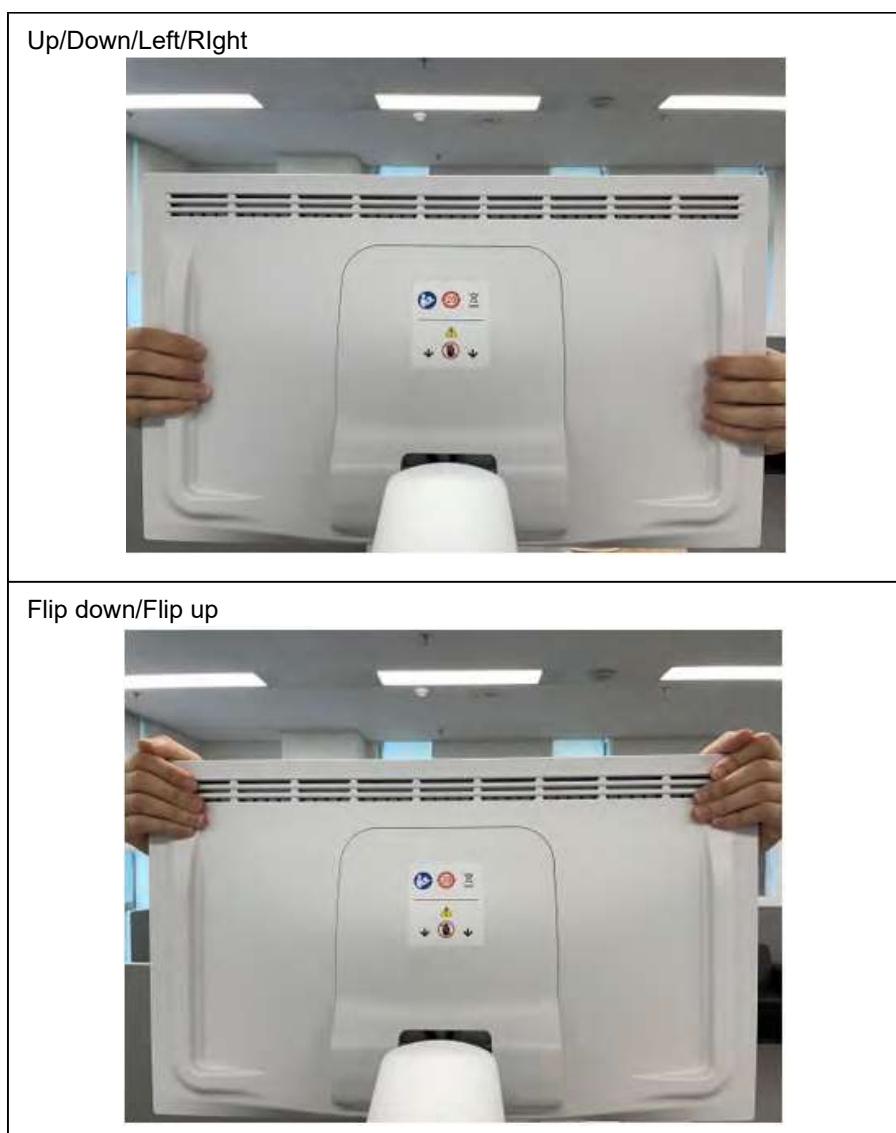

## Adjusting the Monitor Position (continued)

Table 3-14: How to grab (HDU Display)

Up/Down/Left/Right



Flip down/Flip up



## Locking/unlocking the Monitor

1. Turn the release knob clockwise to unlock the monitor. The monitor can be moved freely in all directions (Figure 3-35 1).
2. Turn the release knob clockwise to raise the lock and move the monitor into the parked position, then turn the lock counterclockwise to lock. (Figure 3-35 2).



Figure 3-35. Unlock/Lock the monitor arm

1. Unlocked
2. Locked

## Adjusting the Monitor

You make adjustments to all monitors via the second Utility Menu page. To view the monitor while making these adjustments

1. Press Utility--> select the second page.
2. Press **Scan Screen**. The scan screen displays on the main display while the Utility Touch Panel is active so you can see the affect your adjustments are making to the monitor.

Table 3-15: Monitor Adjustments

Monitor Adjustments	Parameters	Affect on the Monitor
<b>Room Profile:</b> Monitor luminance varies, depending on the room's profile (light, dark, semi-dark). Adjusting this control helps to adapt the monitor to different room lighting conditions.	Set the Room Profile to match the room:	Brightness/Contrast Equivalent:
	LCD display	
	Dark	50/85
	Semi-Dark	70/85
	Light	90/85
	HDU display	
	Dark	50/40
	Semi-Dark	50/65
	Light	50/100
	User Defined	If you select User Defined, adjust the Brightness/Contrast control at the bottom of the Touch Panel.
Note: Brightness/Contrast setting is changeable when the Room Profile setting is available and set to "User Defined".		
<b>Color Profile:</b> Color Profile controls color temperature, or overall tint of the monitor.	0	6500K
	1	9000K (LCD display) / 9300K (HDU display)
	2	11000K
	3	13000K



Table 3-15: Monitor Adjustments (Continued)

Monitor Adjustments	Parameters	Affect on the Monitor
<p>Gamma Setting: With Grayscale Standard Display Function (GSDF) enabled, the gamma button on the Touch Panel affects the image, emulating the appearance of that gamma. The system gamma is adjusted to match the GSDF gamma compensation to the new monitor gamma.</p>	<p>Set the Gamma to 2.2 or 2.4</p>	<p>Note: With GSDF disabled, the monitor still uses a gamma curve that may be selected on the Touch Panel (for backwards compatibility with sites that are happy with their PACS or may have a mix of older systems).</p>
<p>Return to Default settings.</p>	<p>Press "Reset Monitor", then restart the system.</p>	

## Wide Screen Monitor Display Settings

Further clarification on three settings on the Utility--> System--> System Display configuration page is provided below:

- Image Size (Default, Large)
- Image Display Area (Default, Large, Extra Large)
- Use Wide Screen For... (On, Off, Auto)

Table 3-16: Wide Screen Monitor Display Settings

Preset Setting	Description	Choices
<b>Image Size:</b>	The parameter "Image Size" changes the size of the ultrasound image without changing the screen image, which includes the title bar and the image parameter window. It also does not change the size of comments, measurement cursors and lines, or the measurement result box. With all other settings the same, increasing Image Size from Default to Large creates a larger ultrasound image both on the LOGIQ Totus display and on PACS' displays. It will not affect the appearance of screen image items like the title bar and the image parameter window.	<ul style="list-style-type: none"> <li>• Default</li> <li>• Large</li> </ul>

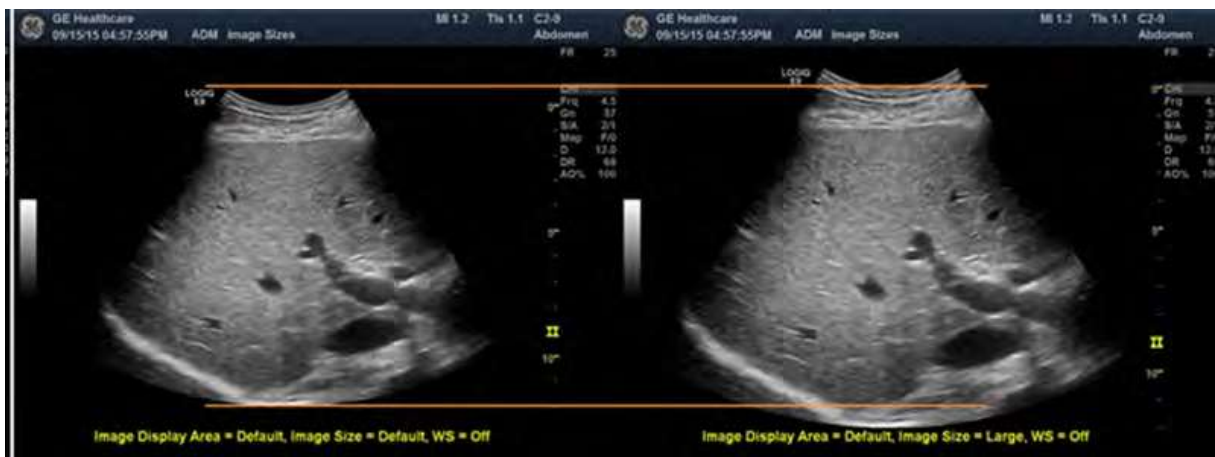

Image Size = Default (Left) and Image Size = Large (Right)

Hint: If you select and save "Last Used" on this page, the system starts with last used Room Profile setting every time.

Table 3-16: Wide Screen Monitor Display Settings (Continued)

Preset Setting	Description	Choices
Image Display Area	<p>“Image Display Area” changes the size of the screen image.</p> <p>On the LOGIQ Totus display, this parameter changes the size of the ultrasound image. It also changes the arrangement of the items like the title bar and image parameter window, but not their individual size. Comments, measurement cursors and lines, and the measurement result box also do not change.</p> <p>This parameter also changes the pixel count of the image. Many PACS software packages scale all images of the same aspect ratio to the same viewing size, regardless of their pixel count. Because the ultrasound image displayed is enlarged as the pixel count is increased, the PACS display size of the ultrasound image does not change. However, items like the title bar, image parameter window, comments, and measurements do not get larger as the pixel count is increased, so they appear smaller on PACS. If text appears too small on PACS, change the Image Display Area to Default (decreasing the screen image pixel count).</p>	<ul style="list-style-type: none"> <li>• Default</li> <li>• Large</li> <li>• Extra Large</li> </ul>



Ultrasound System Image Display Area: Left = Default, Right = Large



PACS Image Display Area: Left = Default, Right = Large

Table 3-16: Wide Screen Monitor Display Settings (Continued)

Preset Setting	Description	Choices
Use Wide Screen For...	<p>“Use Wide Screen for...” determines when the system will use a wide screen aspect ratio (16:9) as opposed to a “standard” aspect ratio (4:3). If “Single Image” under this heading is set to On, then the 16:9 aspect ratio is always used.</p> <p>A third aspect ratio is used if Extra Large is selected under Image Display Area. In this case the Wide Screen display options are not used and a 16:10 aspect ratio is used for all images. The 16:10 aspect ratio will be only modestly different than the 16:9 aspect ratio.</p> <p>Note: PACS display the top and bottom of the image as black bars, just like watching a wide-format movie on a non-wide screen TV.</p>	<ul style="list-style-type: none"> <li>• On</li> <li>• Off</li> <li>• Auto</li> </ul>



Ultrasound System Left&Right: Image Size=Large, Image Display Area=Default; Right: Wide Screen=On



PACS Left&Right: Image Size=Large, Image Display Area=Default; Right: Wide Screen=On

## Image Display Area Preset Setting Notes

The following table shows pixel counts (columns × rows) for saved images for all combinations of Image Display Area and Wide Screen on/off.

Table 3-17: Wide Screen Single Image and CINE Clip Pixel Count

Image Display Area Setting	Single Image	Single Image	CINE Clip*	CINE Clip*	Stress Clip
	On	Off	On*	Off*	
Default	1456 x 819	1092 x 819	1346 x 748	982 x 748	1092 x 819
Large	1552 x 873	1164 x 873	1442 x 802	1054 x 802	1164 x 873
Extra Large	1552 x 970	1552 x 970	1442 x 899	1442 x 899	1552 x 970

\*Under CINE Clip, “On” and “Off” mean Wide Screen Single Image On/Off, **NOT** CINE Clip On/Off.

**NOTE:** Note the different pixel counts for single frames and cine clips. This is because saved cine clips cut off the title bar and image parameter window.

## Use Wide Screen For... Preset Setting Notes

The following table shows the aspect ratio for saved images for all combinations of Image Display Area and Wide Screen on/off. For comparison, it also includes data for the image display on 19” monitors. For CINE clips, the aspect ratios will not be exactly the same as for single frames, but they will be very close.

Table 3-18: Wide Screen Aspect Ratio, Single Image

Image Display Area Setting	On	Off
Default	16:9	4:3
Large	16:9	4:3
Extra Large	16:10	16:10

## Test Patterns

The LOGIQ Totus monitors follow the DICOM Gray Scale Display Function (GSDF) standard\* which uses a GSDF curve to evaluate the health and effectiveness of the monitor. The GSDF standard is what is commonly used for calibrating PACS' monitors. This setting may help to make the image appearance more uniform between the LOGIQ Totus and PACS.

**NOTE:** *The monitor is GSDF-compliant with all contrast settings, but not all brightness settings.*

There is a GSDF on/off switch, "Enable DICOM grayscale display mode (GSDF)" via the Utility--> System--> System Display page that allows you to adjust the monitor you are using to the PACS.

Table 3-19: Test Patterns



Test Pattern	Description	Screen Example
Gray Bars	Confirm that you can clearly see all of the different gradations of the grayscale in each gray cell.	
Color Bars	Confirm that you can clearly see all of the different colors in each colored cell.	
Resolution	Confirm that this image is clear and crisp, without jagged edges or lines.	

Table 3-19: Test Patterns (Continued)

Test Pattern	Description	Screen Example
Brightness Contrast	Before making any adjustments, record the settings for contrast and brightness. In a dimly lit room, adjust the monitor to Brightness 50 & Contrast 40. Increase the contrast until the left most block in the second row from the bottom is just visible. All the remaining blocks in the last 2 rows of the image should now be visible. Reset the contrast and brightness to the recorded levels.	
LN1 to LN18	Luminance for different grayscale levels. Usually, the facility's Biomed Engineer tests each gray level map on the monitor from LN-1 to LN-18 with a light meter and then graphs these on a scale to ensure that the curve falls within the GSDF's standard. Generally, this is performed yearly.	<p data-bbox="1091 629 1150 656">LN-1</p>  <p data-bbox="1091 907 1166 934">LN-18</p> 
QC	Quality Control. Confirm that this image is clear and crisp, without jagged edges or lines.	
CT	Contrast. Confirm that you can you detect the circles within the square grayscale boxes.	
<p data-bbox="189 1749 1402 1899">**"Assessment of Display Performance for Medical Imaging Systems." Report of the American Association of Physicists in Medicine (AAPM) Task Group 18, Medical Physics Publishing, Madison, WI, AAPM On-Line Report No. 03, April 2005, Samei E, Badano A, Chakraborty D, Compton K, Cornelius C, Corrigan K, Flynn MJ, Hemminger B, Hangiandreou N, Johnson J, Moxley M, Pavlicek W, Roehrig H, Rutz L, Shepard J, Uzenoff R, Wang J, Willis C.</p> <p data-bbox="189 1906 975 1933">*Also see <a href="https://www.aapm.org/pubs/reports/OR_03.pdf">https://www.aapm.org/pubs/reports/OR_03.pdf</a>, section 4.3.</p>		

# Monitor Display

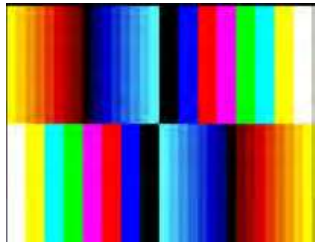
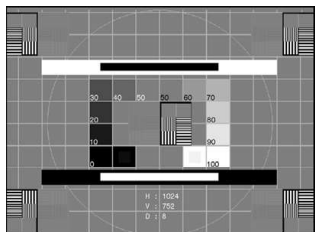
## Monitor Display

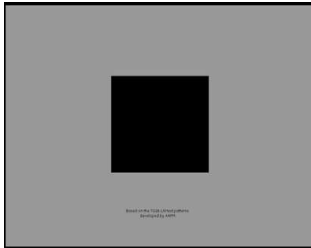
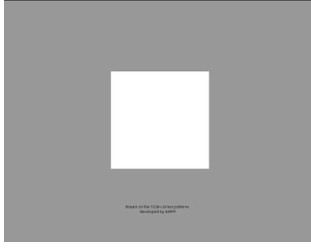
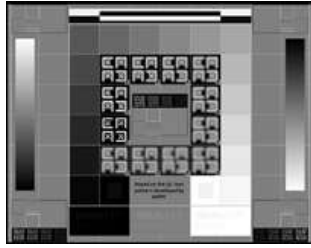
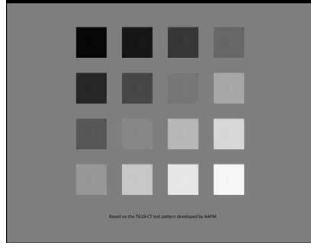

Figure 3-36. Monitor Display Tour



## Monitor Display (continued)





1. System Date and Time (Note: The date on the monitor may truncate the century when using the YYYY-MM-DD date format.)
2. Caps Lock
3. Network Connection Indicators (Wireless LAN, Wired, Mobile Bluetooth), Battery Status
4. DVR Status
5. InSite Indicator
6. Image Clipboard
7. Image Preview
8. Worksheet/Direct Report
9. Gray/Color Bar
10. Institution/Hospital Name, Date, Time
11. Operator Identification, Patient Name
12. Probe Orientation Marker
13. Measurement Calipers and System Message Bar
14. Color Window
15. Power Output Readout
16. Probe Identifier, Exam Preset
17. Live/Freeze Indicator
18. Imaging Parameters by Mode, Speed of Sound (SoS) Indicator (if applicable)
19. Focus Indicator and Color Flow Focal Zone Marker
20. Depth Scale
21. Image Management Icons and LOGIQ Apps Icon (not shown)
22. Body Pattern
23. CINE Gauge
24. Trackball Controls and Status

### Live/Freeze Indicator

Live/Freeze Indicator shows active image scan status with Single/Dual/Quad format and has four choices (Live/Not Live/Update/B Pause).

Live/Freeze Indicator display (on/off) is configurable on Utility -> System -> System Display menu.

Table 3-20: Live/Freeze Indicator

Live		Update	
Not Live		B Pause	

### Monitor Display Layout

Monitor Display Layout is configurable on Utility -> System -> System Display menu.

See 'System/System Display Preset Menu' on *page 10-12 for more information.*



Figure 3-37. Default Image Format (4:3)

1. Title bar
2. Information window 1
3. Information window 2
4. Scan Area
5. Control Window
6. Preview window/User Label
7. Clipboard
8. Trackball mapping and Set keys
9. Status area

## Information Window

Measurement Summary, Side Clipboard, Scan Assistant Guide, and My Desktop are displayed options for Info1 or Info2 window.



Figure 3-38. Information Window - Example

1. Measurement Summary
2. Side Clipboard
3. Scan Assistant Guide
4. My Desktop

## My Desktop

The user can import graphics (jpeg) and write a caption for that graphic to display on My Desktop in Utility -> User Specific.

Table 3-21: User Specific

Preset Parameter	Description
My Desktop Title	Free text
Picture 1 and 2	Browse to load jpeg and type the caption.
Background Color	Select Color: Select the background color. Default Color: Reset the background color to factory default.
Import	Import the graphic.

## User Label

In Utility -> Application -> Settings -> Label Area, you can enter User Label which displays in the Preview Window as a brief note.

For example, P1 - Stills only, P2 - Stills, Clips (3 sec.), P3 - Volume, P4 Screen Capture.



Figure 3-39. Application Settings Preset Menu

Table 3-22: Label Area

Preset Parameter	Description
Show labels	If selected, the system displays the User Label in the Preview Window at the left-bottom of the monitor.
Label 1 - 8	User labels have eight text lines. Each User Label is limited to 50 characters.

## Change the Display Image Area

You can change the screen format layout by pressing the lower, right-hand corner of the Display Image Area icon on the display:

Table 3-23: Display Image Area Selections

<p>Display Image Area icons</p> 	<p>Click Image Display Area icon to toggle current display area and extra large area.</p> <p>Default Layout</p> <ul style="list-style-type: none"> <li>• (4:3 Layout) Standard</li> <li>• (16:9 Layout) Full Wide</li> </ul> <p>Large Image Layout</p> <ul style="list-style-type: none"> <li>• (4:3 Layout) Standard</li> <li>• (16:9 Layout) Full Wide</li> </ul> <p>Extra Large Layout</p> <ul style="list-style-type: none"> <li>• (16:10 Layout) Partial Wide</li> </ul>
---	---

Table 3-24: Display Image Area Examples





<p>Default Layout Standard</p>	
<p>Default Layout Full Wide</p>	

Table 3-24: Display Image Area Examples (Continued)

<p>Large Image Layout Standard</p>	
<p>Large Image Layout Full Wide</p>	
<p>Extra Large Layout Partial Wide</p>	

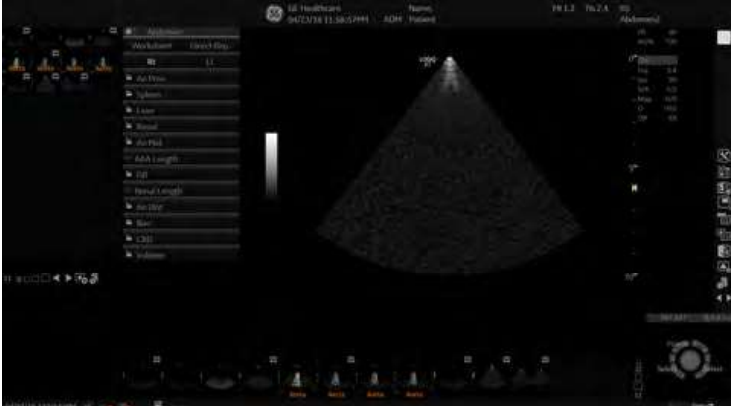
**NOTE:** Even if there are buttons on the rear cover of the monitor, DO NOT use those buttons for adjustment. The LOGIQ Totus system will override the parameter(s) and the monitor does not have capability to retain parameters.

## Using the Monitor Display Controls to Manage Images

### Image Management Icons

You can manage images from the display via these on-display controls.

Table 3-25: Image Management Icons

	<p><b>Image Display Area</b> Press Image Display Area to select Image Display Area - Default/Large/Extra large. See 'Change the Display Image Area' on <i>page 3-79 for more information.</i></p>
	<p><b>Worksheet</b> Activate the Worksheet.</p>
	<p><b>Active Images</b> Press Active Images to go to the Patient Active Images page.</p>
	<p><b>Compare Assistant</b> Press to activate Compare Assistant.</p>
	<p><b>Activate Save As Menu</b> - Note: Save As Menu icon is displayed only when an image is recalled or scan state is frozen/CINE Loop.</p>
	<p><b>Delete Recalled Image/Delete Last Image</b> - Delete Recalled Image is displayed only when one image is recalled. / Delete last image icon is displayed only when the image is not recalled and there are non-stored images. You can use this to delete an image from the clipboard. Place the cursor on the clipboard image you want to delete, then press <b>Set</b> to select the image. Then place the cursor on the Delete icon and press <b>Set</b>.</p>
	<p><b>Next/Previous Image(s) and Clipboard Slide Show</b> Press the left arrow to move to the previous image; press the right arrow to move to the next image. <b>Clipboard Slide Show</b> The Clipboard Slide Show plays all images on the clipboard and wraps around the ends. To activate, press and hold [Ctrl] + [Previous Arrow] or [Ctrl] + [Next Arrow].</p> <ul style="list-style-type: none"> <li>• Each image recalls for three seconds, or the length of the loop, whichever is longer.</li> <li>• You can manually skip to a new image during the slide show by recalling it, as usual.</li> <li>• To end the slide show manually, press [Ctrl] + [Previous]/[Next] again.</li> <li>• Slide Show ends when you go to live scanning, or if the clipboard is not shown when it's time for the next image to load.</li> </ul>

# System Positioning/Transporting

## Moving the System

When moving or transporting the system, follow the precautions below to ensure the maximum safety for personnel, the system, and other equipment.



CAUTION

This equipment is not to be used during transportation (e.g. ambulance cars, aircraft).



CAUTION

Handle carefully. A drop of more than 5 cm can cause mechanical damages.



Moving  
Hazard

Never move the system with locked wheels.



## Before moving the system

1. Press the **Power On/Off** switch to power off the system. See 'Power Off' on page 3-37 for more information.
2. Unplug the power cord.
3. Wind the power cable around the neck of rear handle.



DANGER

**LOOSELY** (not twisting tightly) wrap the Power Cord around the neck of rear handle. Occasionally wrap the Power Cord around the neck of rear handle in the opposite direction.

**NEVER** allow the Power Cord to drag on the floor.

**NEVER** roll over the Power Cord with the wheels.

Failure to follow these instructions could lead to exposure to electrical shock.

4. All cables from off-board peripheral devices (external Color Digital/Report printer, etc.) and the ethernet connection must be disconnected from the console.
5. Ensure that no loose items are left on the console.
6. Connect all probes to be used while off site. Ensure that probe cables are out of the way from the wheels and not protruding beyond the console. Use the probe management hooks located below the Operator Panel to further secure the probe cables

**NOTE:** *If more than four (4) probes are intended to be used, store the additional probes securely.*

7. Store all other probes in their original cases or in soft cloth or foam to prevent damage. In addition, on-board storage bins are available as a system option.

### Before moving the system (continued)

8. Store sufficient gel and other essential accessories in the provided space.
9. Adjust the monitor and control panel to their lowest positions by using the up/down switch on the front of the operator panel. Make sure the operator panel is locked in place.



CAUTION

To prevent system damage while not in use AND/OR before moving the system, flip down the monitor and lock the monitor arm and operator panel firmly in place.



Figure 3-40. Flip down the monitor and lock the monitor arm

10. Unlock the wheels.

## When moving the system



### CAUTION

1. Always use the rear handle grips to move the system.
  - **DO NOT** attempt to move the console using any cables or fixtures, such as the probe connectors.
  - **DO NOT** attempt to move the system with the monitor by pulling cables or belts placed around the monitor and/or monitor arm.
  - **DO NOT** restrain the LOGIQ Totus at the monitor or the monitor neck using a belt. Always secure the monitor at the body part of the console.
2. Take extra care when moving the system long distances and on inclines. Ask for help if necessary.

Avoid ramps that are steeper than ten degrees to avoid tipping over the system. Utilize additional care and personnel when moving on a steep incline (>5 degrees) or loading the system into a vehicle for transport.

### NOTE:

*Wheel chair ramps are usually less than five degrees.*

3. Use the foot brake (pedal), located on the bottom of the system in the front, when necessary.
4. Do not let the system strike walls or door frames.
5. Use extra care when crossing door or elevator thresholds.
6. Once the destination is reached, lock the wheels.



### WARNING

To avoid possible injury and equipment damage:

- Be sure the pathway is clear.
- Limit movement to a slow careful walk.
- Use two or more persons to move the system on inclines or long distances.

Failure to follow instructions could lead to possible injury and/or equipment damage.

## Wheels

Examine the wheels frequently for any obvious defects that could cause them to break or bind. Each wheel has an independent brake pedal. A left rear wheel also has a swivel lock.

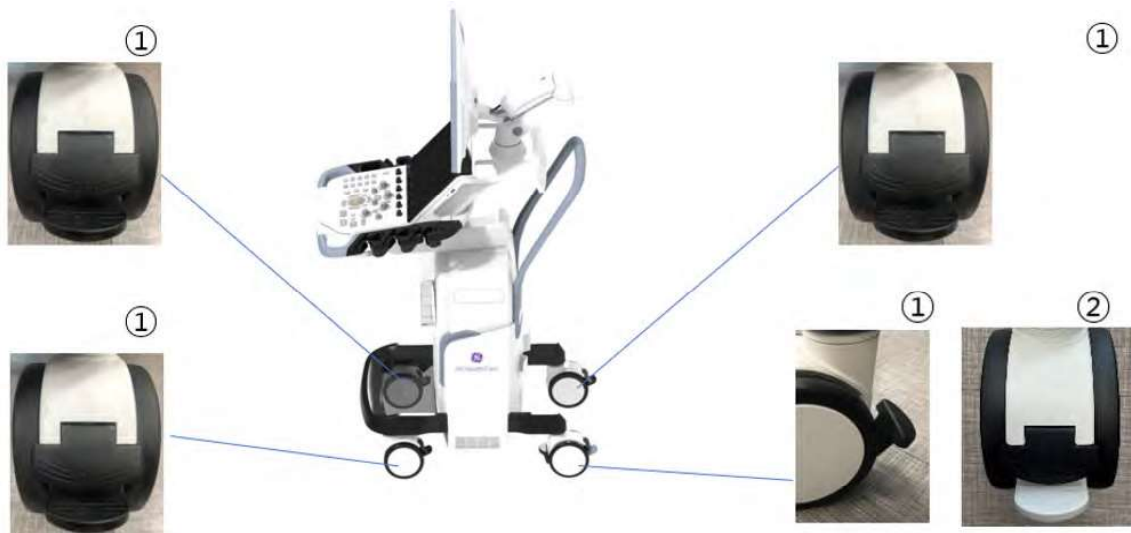

Figure 3-41. Brake lock and Swivel lock

1. Brake lock pedal

2. Swivel lock pedal



CAUTION

If you park the system on a slippery slope, you **MUST** use the brakes on the wheel.

## Brake pedal



Figure 3-42. Front and Right-rear caster

1. Step on Lower side pedal to activate Brake
2. Step on Upper side pedal to release Brake

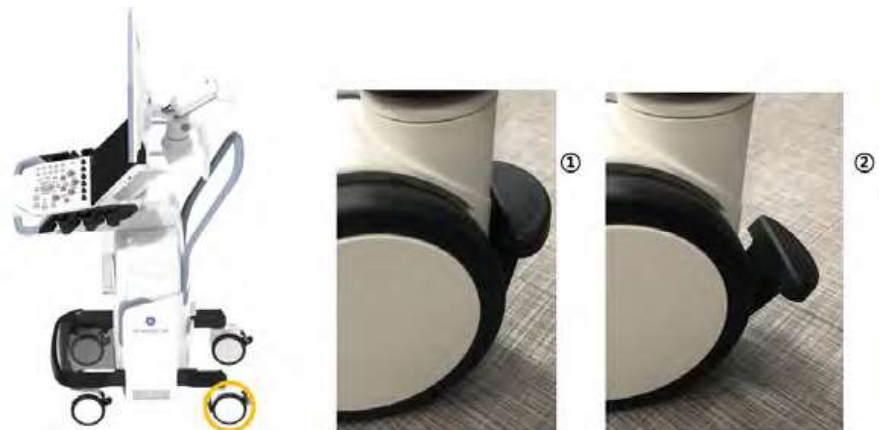

Figure 3-43. Left-rear caster

1. Step on to activate Brake
2. Raise up to release Brake

## Swivel lock



Figure 3-44. Rear-left with Swivel lock

1. Step on Lower side pedal to activate Swivel Lock with clicking sound
2. Step on Lower side pedal to de-activate Swivel Lock

**NOTE:** *Wheel needs to be straight when you activate Swivel Lock.*

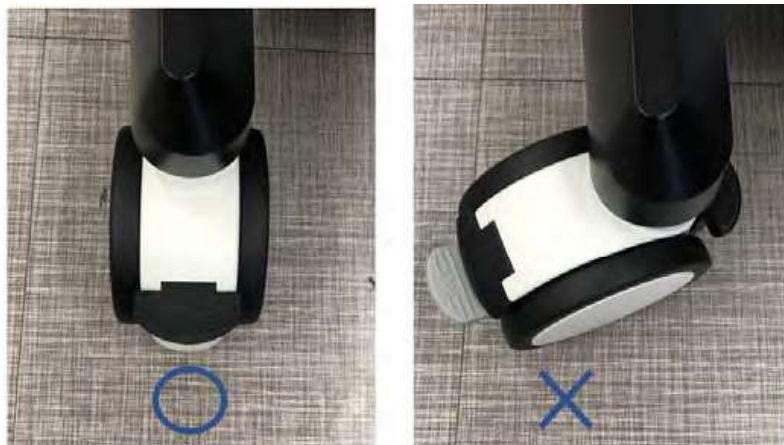

Figure 3-45. Caster position for Swivel lock

## Transporting the System

Use extra care when transporting the system using vehicles. In addition to the instructions used when moving the system (see 'Before moving the system' on page 3-83 for more information), also perform the following:

1. Before transporting, place the system in its special storage case.
2. Only use vehicles that are designed for transport of the LOGIQ Totus system.
3. Load and unload the system to a vehicle parked on a level surface.
4. Ensure that the transporting vehicle can handle the weight of the system plus the passengers.
5. Ensure that the load capacity of the lift (a minimum of 85 kg [187 lbs] is recommended) is capable of handling the weight of the system and any other items on the lift at the same time.
6. Ensure that the lift is in good working order.
7. Secure the system while it is on the lift so that it cannot roll. Use either wood chocks, restraining straps, or other similar types of constraints. Do not attempt to hold it in place by hand.

*NOTE: Strap the system below its handle so that the system does not break loose.*

8. Employ two to three persons to load and unload safely from a vehicle.
9. Load the unit aboard the vehicle carefully and over its center of gravity. Keep the unit still and upright.

*NOTE: Do not lay the unit down on its side.*

10. Ensure that the system is firmly secured while inside the vehicle. Any movement, coupled with the weight of the system, could cause it to break loose.
11. Secure system with straps or as directed otherwise to prevent motion during transport.
12. Prevent vibration damage by driving cautiously. Avoid unpaved roads, excessive speeds, and erratic stops or starts.

## Acclimation Time

After being transported, the unit requires one hour for each 2.5 degree increment when its temperature is below 10 degree C or above 40 degree C before powering on.

Table 3-26: System Acclimation Time Chart

<b>Degree C</b>	60	55	50	45	40	35	30	25	20	15	10
<b>Degree F</b>	140	131	122	113	104	95	86	77	68	59	50
<b>hours</b>	8	6	4	2	0	0	0	0	0	0	0
<b>Degree C</b>	5	0	-5	-10	-15	-20	-25	-30	-35	-40	
<b>Degree F</b>	41	32	23	14	5	-4	-13	-22	-31	-40	
<b>hours</b>	2	4	6	8	10	12	14	16	18	20	



---

## Chapter 4

# Preparing for an Exam

*Describes how to begin an exam.*

# Beginning an Exam

## Introduction

Begin an exam by entering new patient information.

The operator should enter as much information as possible, such as:

- Dataflow
- Exam category
- Patient ID
- Patient name
- Exam Information

The patient's name and ID number is retained with each patient's image and transferred with each image during archiving or hard copy printing.

## Patient Screen

Press **Patient** on the Touch Panel to display the Patient Screen on the monitor.

- Enter Patient Data with the alphanumeric keyboard.
- To navigate through the Patient Entry menu, use the **Tab** key or **Trackball** and **Set** to move and fix the cursor.

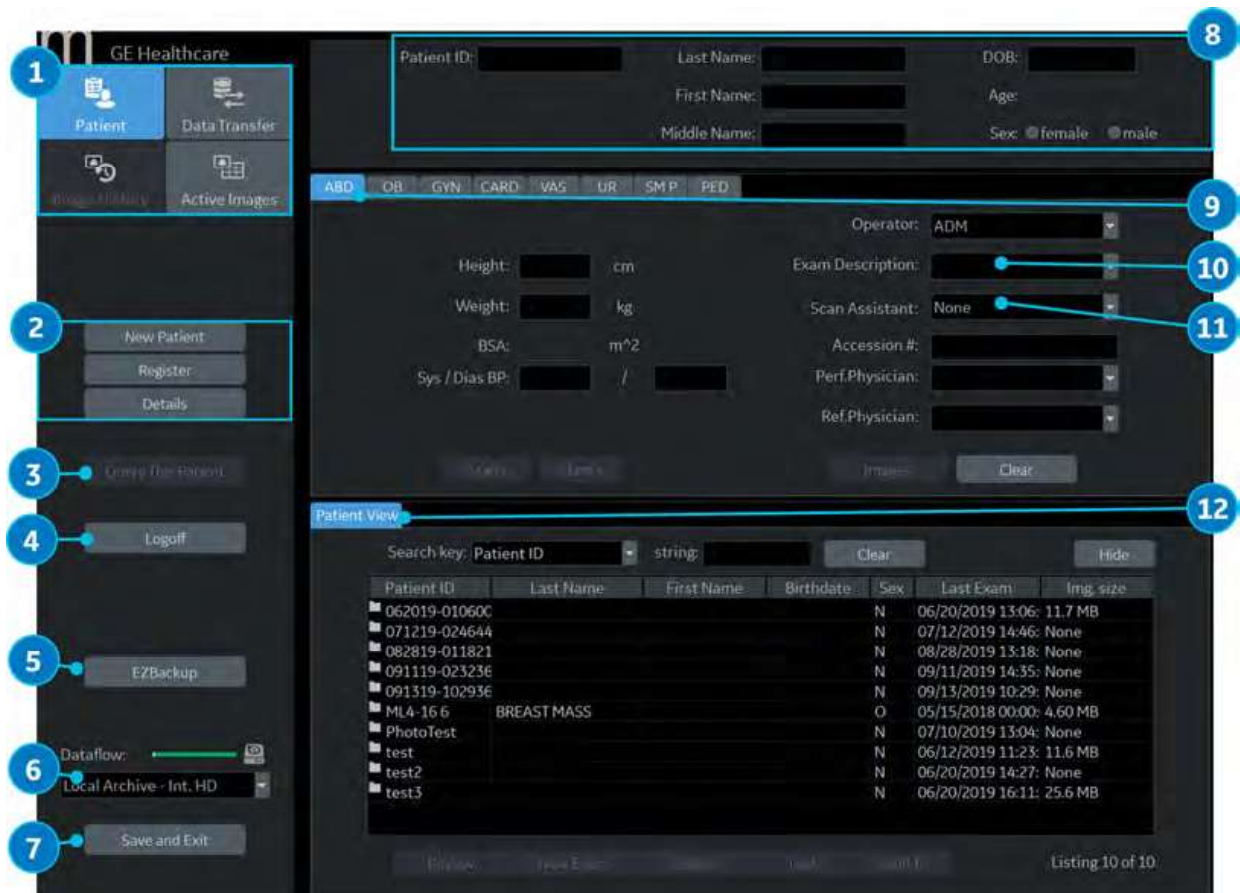

Figure 4-1. Patient Screen (Example: Category ABD)

Table 4-1: Patient Screen

No.	Function	Description
1.	Image Management	<ul style="list-style-type: none"> <li>• Patient–Provides a search and creation of patient. (currently selected)</li> <li>• Image History–Provides a list of images per exam for the currently selected patient.</li> <li>• Active Images–Provides preview of the currently selected exam and Compare Assistant.</li> <li>• Data Transfer–Provides an interface to handle patient data from a remote device.</li> </ul>

Table 4-1: Patient Screen (Continued)

No.	Function	Description
2.	Function Selection	<ul style="list-style-type: none"> <li>• New Patient–Used to clear patient entry screen in order to input a new patient’s data into the database.</li> <li>• Register–Used to enter new patient information into the database prior to the exam. If you are using the auto-generate Patient ID feature, do not select Register. It is always a good practice to Register all patients.</li> <li>• Details–Select the Details box to activate/deactivate the exam details. The Exam Description pull-down selection is used as the DICOM identifier.</li> </ul>
3.	Query This Patient	Allows for One Click Q/R for the current patient.
4.	Logoff	Used to logoff system.
5.	EZBackup	One-step method to backup patient images to an external media.
6.	Dataflow Selection	Select archive and other pre-defined services. If you place the cursor on the icon, the pop-up menu displays disk capacity.
7.	Save and Exit	Used to save all changes and exit the Patient Menu.
8.	Patient Information	<ul style="list-style-type: none"> <li>• Patient ID Number</li> <li>• Alternate (Other, Second) Patient ID Name and Number. The system allows you to enter a second identification number for the same patient, which may be required in certain countries. This is only displayed if enabled on the Connectivity -&gt; Miscellaneous screen.</li> <li>• Patient Name–Last, First and Middle</li> <li>• DOB (Birthdate)</li> <li>• Age (automatically calculated when birthdate is input)</li> <li>• Sex</li> </ul>
9.	Category Selection	Select from 8 exam application categories. When a category is selected, the measurement and category presets are displayed.
10.	Exam Information	Shows the Current/Active Exam information. Information pertinent to the selected exam category appears in the window. All possible information needs to be entered. <ul style="list-style-type: none"> <li>• Images–Displays the selected exam’s images in the middle of screen.</li> <li>• Clear–Clears existing data.</li> <li>• Past Exam (only for OB)–Input past exam data (register the patient before using).</li> </ul>
11.	Scan Assistant Program	The Scan Assistant Program is either selected automatically or manually, depending on the preset as configured on the Utility--> System--> General page.
12.	Patient View/Exam View	Display either patient or examination list. Refer to ‘Patient View/Exam View’ on page 4-5 for details.

Patient View/Exam View

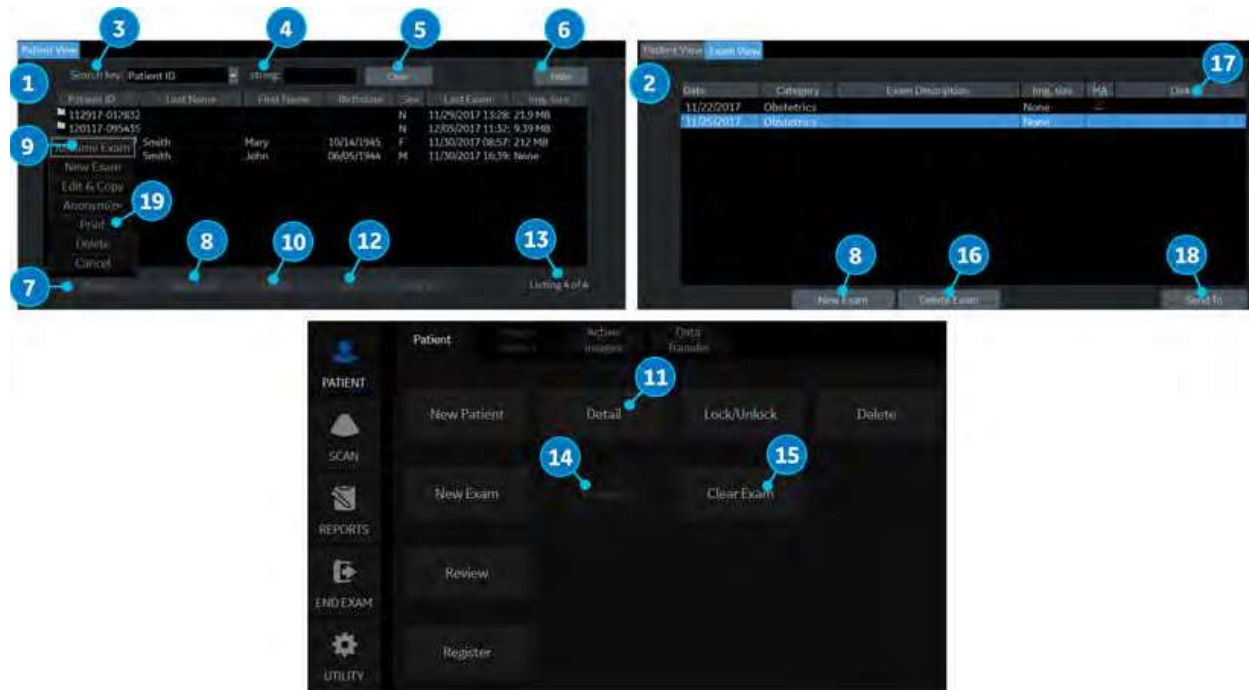

Figure 4-2. Patient View and Exam View

Table 4-2: Patient View/Exam View

No.	Function	Description
1.	Patient View	Lists the patients in the database. When you double-click a patient on the patient list using the <b>Set</b> key, the Review screen or New Exam entry screen displays depending upon how the “Double click on patient list to start” preset is set at Utility -> Connectivity -> Miscellaneous.
2.	Exam View	Displays the list of all the exams for the Current Patient. The system can display the Detail Mode instead of Exam View when you select a patient on the patient list and press Review or Register (to Register, enter a patient ID and select). If the Detail Mode preset on Utility -> Connectivity -> Miscellaneous menu is selected, the Detail Mode displays.
3.	Search	Select a search criteria. Note: Criteria “Img. Archived” means that the exam was backed up to external media by EZBackup or Export.
4.	String	Enter appropriate information for search criteria. Note: If you select Locked (Y, N) or Archived (Y, N) for the Search key, enter Y (Yes) or N (No).
5.	Clear	Clears the entered string.
6.	Hide	Hide the patient view.

Table 4-2: Patient View/Exam View (Continued)

No.	Function	Description
7.	Review	Highlight the patient and press Review. Exam view is displayed. Note: If the selected patient has a Current Exam or the selected exam is the Current Exam, the Review button changes to "Resume Exam" on Patient List.
8.	New Exam	Creates a new exam for the current patient.
9.	Resume Exam	Continues the exam for that patient if you select the last exam of the day.
10.	Delete	Delete one or more patient record from Patient View. Note: "Delete" is only displayed when you login as Administrator.
11.	Detail	The detail information for the selected category displays.
12.	Lock/Unlock	Locks the exam/patient. Prevents move and delete functions. If you select the patient, all exams are locked. If you select one exam, the selected exam is locked and the lock icon displays in the patient ID cell.
13.	Listing xx/xx	Displays the quantity of patients that match the search criteria in the search window or the quantity of patients in the database.
14.	Images	Display images of the selected exam in the middle of the monitor.
15.	Clear Exam	Clear exam (located on the Touch Panel).
16.	Delete Exam	Delete one or more exams from Exam View. Note: "Delete" is only displayed when you login as Administrator.
17.	Disk	Displays the disk name on which you saved the exam's image data. If "+" displays behind the disk name, the data is saved on two or more disks.
18.	Send To	Send the images to the DICOM Device.
19.	Print	Print the search list to a standard printer. Highlight the patient and press left Set key. Select Print from the pop-up and press the right Set key.

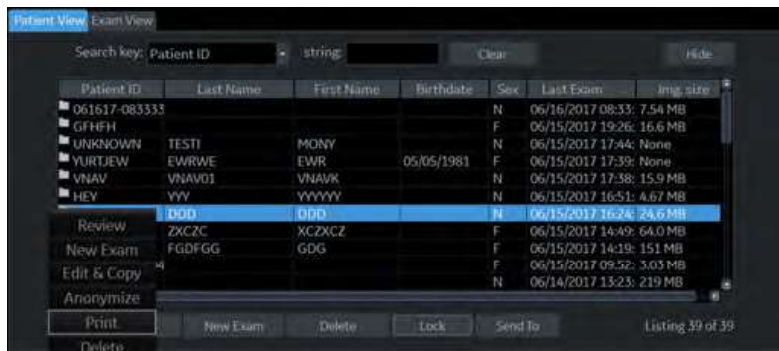

**NOTE:** Refer to 'Change Patient ID of the existing patient (Edit & Copy)' on page 4-18 for more information about Edit&Copy and Anonymize.

## **OB Exam**

### **Exam Preparation**

Prior to an ultrasound examination, the patient should be informed of the clinical indication, specific benefits, potential risks, and alternatives, if any. In addition, if the patient requests information about the exposure time and intensity, it should be provided. Patient access to educational materials regarding ultrasound is strongly encouraged to supplement the information communicated directly to the patient. Furthermore, these examinations should be conducted in a manner and take place in a setting which assures patient dignity and privacy.

- Prior material knowledge and approval of the presence of nonessential personnel with the number of such personnel kept to a minimum.
- An intent to share with the parents per the physician's judgement, either during the examination or shortly thereafter, the information derived.
- An offer of choice about viewing the fetus.
- An offer of choice about learning the sex of the fetus, if such information becomes available.

Ultrasound examinations performed solely to satisfy the family's desire to know the fetal sex, to view the fetus, or to obtain a picture of the fetus should be discouraged.

## Acoustic Output Considerations



DANGER

The Ultrasound system is a multi-use device which is capable of exceeding FDA Pre-enactment acoustic output (spatial peak-temporal average) intensity limits for fetal applications. The interaction of sound energy with tissue at sufficiently high levels and/or longer duration can produce biological effects (aka bioeffects) of either a mechanical or thermal nature.



DANGER

It is prudent to conduct an exam with the minimum amount and duration of acoustic output necessary to optimize the image's diagnostic value. The interaction of sound energy with tissue at sufficiently high levels can produce biological effects (aka bioeffects) of either a mechanical or thermal nature.

### Concerns surrounding fetal exposure

Always be aware of the acoustic output level by observing the Acoustic Output Display. In addition, become thoroughly familiar with the Acoustic Output Display and equipment controls affecting output.

### Training

It is recommended that all users receive proper training in fetal Doppler applications before performing them in a clinical setting. Please contact a local sales representative for training assistance.



## To Start an Obstetrics Exam

**NOTE:** Calculation formulas are listed in the *Advanced Reference Manual*.

To begin an Obstetrics exam, you have to enter the OB-specific information. Obstetric patient fields are listed in the following table.

Table 4-3: Obstetric fields

Field	Description
LMP	Last Menstrual Period; enter the date that the patient started her last menstrual period. You must enter 4 digits for the year. When you type the month and day, the system fills in the slash (/). The Date Format preset chosen in Utility -> System -> General determines the required format.
BBT	Basal Body Temperature.
EDD by LMP	Estimated Delivery Date by LMP; the system fills in the date after you enter the LMP.
GA by LMP	Gestational Age by LMP; the system fills in the age after you enter the LMP.
Gravida	Number of pregnancies.
Para	Number of births.
AB	Number of abortions.
Ectopic	Number of ectopic pregnancies.
Fetus #	Number of fetuses; default is 1. Can be 1-4.
Accession #	Exam number used with hospital information system (DICOM). This is a tracking number from the worklist.
Exam Description	Describe the type of exam.
Perf Physician	The physician who performs the exam. Choose from the list or type the name.
Ref. Physician	The physician who requested the exam. Choose from the list or type the name.
Operator	The person (not a physician) who performs the scan. Choose from the list.

**NOTE:** To fill in the following information, move the **Trackball** to highlight the **Detail** button and press **Set**.

Table 4-4: Obstetric fields: Detail

Field	Description
Indications	Why the patient needs the ultrasound exam.
Comments	Comments about the exam.

# Starting an examination

## Cautions and Warnings



WARNING

Imaging functions may be lost without warning. Develop emergency procedures to prepare for such an occurrence. Failure to prepare for unexpected loss of functionality could lead to patient injury.



WARNING

Always ensure you have selected a dataflow. If No Archive is selected, no patient data is saved and a rescan may be required. A Ø appears next to Dataflow if No Archive is selected.



WARNING

To avoid patient identification errors, always verify the identification with the patient. Make sure the correct patient identification appears on all screens and hard copy prints.



CAUTION

Always use the minimum power required to obtain acceptable images in accordance with applicable guidelines and policies.



CAUTION

Always use the system on a flat surface in the patient environment.

## **Cautions and Warnings (continued)**



### **CAUTION**

Ensure that the hands of the patient are away from the system during the exam.

The position of the operator and the patient vary by scan region.

In most cases, the operator sits/stands straight in front of the operator console and the patient lies on the bed on the right (or left) side of the system.

## Creating a new patient record

When starting a new patient's exam, ensure you do the following:

1. Press **Patient** on the Touch Panel.
2. Press **New Patient** on the Touch Panel or the monitor.
3. Fill in patient information.

**NOTE:** Press **Tab** or **Enter** on A/N keyboard to move the cursor to next field.

**NOTE:** Do not use the following characters when filling in patient information:

“ ‘ \ / : ; , . , \* < > | + = [ ] &

4. Choose the exam category.  
Enter the required information for the selected exam category.



Figure 4-3. Exam category

5. Verify the dataflow.

**NOTE:** DO NOT use the removable media dataflows on the New Patient menu.

**NOTE:** The system can display a warning dialog when the patient is registered to “No Archive”. If the “Warn register to No Archive” preset is selected in the Utility -> Connectivity -> Miscellaneous menu, a warning displays. A different dataflow for permanent storage of patient data should be selected.

6. Select **Register**.
7. Select the probe to start scanning (or select Save and Exit, Esc, Scan, or Freeze).

## Perform an exam

1. Select the probe, exam category, and application.

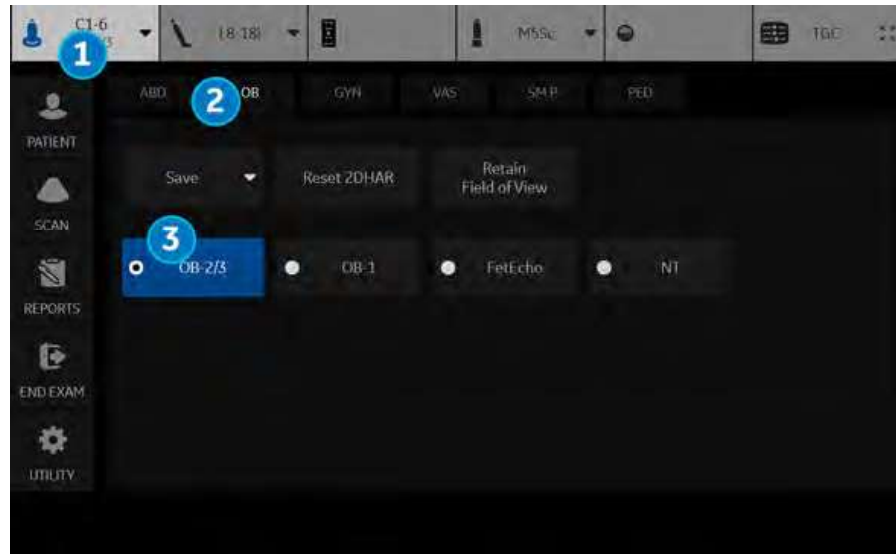

Figure 4-4. OB Preset - example

1. Probe
2. Exam category
3. Application preset

**NOTE:** See 'Imaging Preset Manager' on page 10-182 if you want create/edit user defined preset.

2. Perform an exam.
3. Store the raw data to the clipboard.

To store the still image, press **Freeze** and run the cineloop using the **Trackball**. Select the frame and press **P1** (or the assigned Print key).

To store the cineloop, press Print key without freezing or press **Freeze** and run the cineloop using the **Trackball**. Select the start/end frame and run the selected loop. Press **P1** (or the assigned Print key).

### Ending an exam



#### WARNING

To ensure correct storage of measurements, verify that the measurement result window is updated before you send or save the image.

1. When you have completed the study, press **End Exam** on the Touch Panel.
2. The image management screen displays. Select the images (still frame or cinelooop) you want to store or select **Select All** to store all images. Select **Permanent Store** to store the images permanently.

**NOTE:** *Return to the patient screen automatically from the scan screen when you select OK from the "ID is not unique" warning message.*

### Scanning without entering any patient data

To scan a patient without entering any patient data until the end of the exam:

1. Press **Scan**.
2. When you scan the patient and save images to clipboard without a patient, you will receive a warning that states, "A patient must be selected for permanent storage of image." Press OK.
3. Press **Patient** to display the Patient Search screen.
4. Enter the Patient ID.

**NOTE:** *If you have images or measurements that are not attached to a Patient ID, the message "Unsaved images, measurements or fetus number will be linked to the current patient information, continue?" appears when the patient ID is registered.*

5. Enter patient data and exam information as necessary.
6. Press **Active Images**.
7. Press **Permanent Store**.

## Starting a new exam on an existing patient

1. Press **Patient**.
2. Press **New Patient** on the Touch Panel or the monitor.
3. Enter Patient ID or Last name, etc. in the patient information to display the target patient in Patient View.  
For example, if you type “v” in Patient ID, only display patients begins with patient ID “v”.  
or select Search key and enter a string to search a patient.
4. Highlight the target patient and double click the right **Set** key. Selected patient information displays.
5. Choose the exam category for new exam.
6. Select **New Exam**. A new exam is created in Exam View.
7. Select the probe to start scanning (or select Exit, Esc, Scan, or Freeze).

## Retrieve Patient/Exam Information from Worklist

**NOTE:** Before you retrieve data from the Worklist server, make sure that Network LAN is connected correctly. If the worklist is not displayed, reboot the system.

1. Press **Patient** and select **Data Transfer**. The Data Transfer screen displays.
2. Click on a radio button of **Worklist**. The patient/exam list displays in the Transfer To section.



Figure 4-5. Data Transfer

1. Worklist
2. Worklist radio button
3. Transfer button
4. Worklist server
5. The Worklist used last time is displayed on the monitor display. Press **Refresh** to refresh the list or select another Worklist server from the Transfer From pull-down menu.
6. Select the patient(s) or the exam(s) from the list.
7. Press **Transfer**. The progress bar displays during the transfer.
8. Enter the required items and start an exam.



## Sending Multiple Exams and Patients with Single Click to PACS

In the Patient View window, select 1 or multiple patients -- you can select by whole exam or whole patient -- to send to PACS. Select multiple items by using the Shift+Trackball Set Key.



Figure 4-6. Multiple Patient/Exam Send To

## Change Patient Information except Patient ID and scan

1. Perform Step 1 to 6 in 'Starting a new exam on an existing patient' on *page 4-15*.
2. You can change Patient information except Patient ID.



Figure 4-7. Change Patient Information

3. Select the probe to start scanning (or select Exit, Esc, Scan, or Freeze).

## Change Patient ID of the existing patient (Edit & Copy)

1. Ensure that you are logged in as an Administrator on the system.
2. Change the dataflow to Local Archive.
3. Select the patient from the Patient View list and left click to bring up the “Edit & Copy” pop-up menu.

**NOTE:** *If you do not see the Edit and Copy ID option on the pop up menu, make sure the top half of the patient screen is blank.*

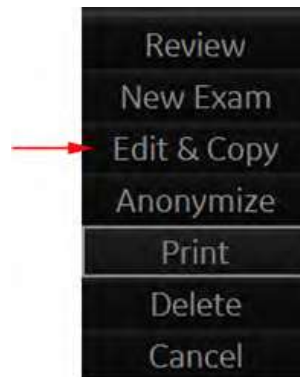

Figure 4-8. Select an Exam to Copy and Edit

4. A confirmation dialog displays. Select **OK**.

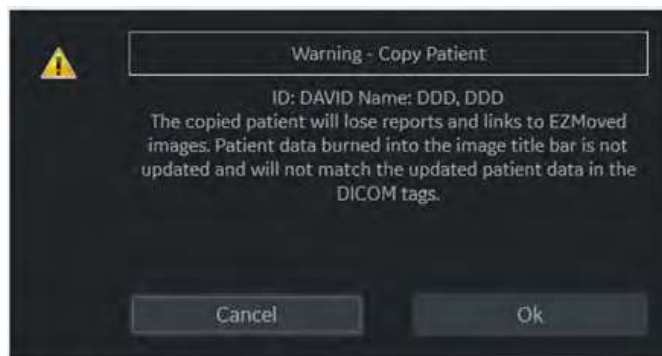

Figure 4-9. Copy Patient Pop-Up Confirmation

## Change Patient ID of the existing patient (Edit & Copy) (continued)

- The “Edit and Copy Patient” dialog displays. All the fields inherit the values from the original patient’s exam, except for Patient ID.

Figure 4-10. Edit and Copy Patient Dialogue

- **Generate Patient ID** generates a patient ID.
- **Clear All** clears all fields except for Patient ID and Other ID.
- **Cancel** button cancels the “Edit and Copy Patient” function.

- Fill in the Patient information fields, then press OK.

**NOTE:** *If the newly entered Patient ID is not unique in the database, the Patient ID turns to red and an error message displays on the status bar.*

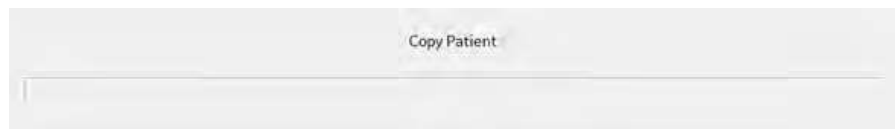

Figure 4-11. Copy Status Bar

- When the copy is done, the patient list is refreshed.

Make sure that the patient record with new Patient ID is created.

**NOTE:** *If you want delete Patient record with old Patient ID, click **Delete** on the Touch Panel.*

### Tips



#### WARNING

Confirm the patient identification prior to deleting/entering/importing any patient data. The user is responsible for patient data, diagnostic information or any other patient-related information entered in the database. Failure to follow instructions could lead to loss of or incorrect patient data.

The “Edit and Copy Patient” function:

- Copies data of a registered patient from the local archive to a newly-created patient in the local archive. The newly-created patient would have a new identification: patient ID, other ID, patient name, and sex etc.
- Assigns a new identification: new UIDs to the copied exam data. The newly-copied patient would have the same medical data as the patient being copied but with a different identification.

**NOTE:** *“Edit and Copy Patient” will only copy patient data, images inside the local archive; it will not allow patient data or images from outside of the local archive. This includes the following types of images: exported, SaveAs, DICOM Store, or (DICOM) print.*

**NOTE:** *“Edit and Copy Patient” does not copy the patient’s report.*

**NOTE:** *“Edit and Copy Patient” does not deal with patient information already burned in image pixels.*

**NOTE:** *The image and title bar, including patient information, is copied as is.*

**NOTE:** *The “Edit & Copy” function does not display for a current patient.*

**NOTE:** *The “Edit & Copy” function does not display when multiple patients are selected.*

# Retrieving and editing archived information

## Searching for an existing patient

1. Press **Patient** to display the Patient Screen.
2. Select the search key (Patient ID, First Name, Last Name, etc.). Type the search string.

When default configured, the system automatically searches to see if the patient is already in the archive. The result of this search is displayed in the Patients list.

**NOTE:** *When the number of patients on a hard disk is in the hundreds, it takes time to search for a patient or switch to another screen. In this case, do one of the following:*

- *Uncheck the “Auto search for patient” preset, found under Patient/Exam Menu Options in Utility -> Connectivity -> Miscellaneous.*
- *Delete unnecessary patient data.*

3. Highlight the patient in the Patients list.

Select the Exam View tab to display a list of examinations instead of the patient records.

## Searching for an existing patient (continued)



1            2            3            4

Figure 4-12. Patient Search Screen

1. Select **Review** to review the exam history of this patient.  
If the study was performed on the same day, **Resume Exam** will populate in place of **Review** to continue the exam
2. Select **New Exam** to create a new exam for this patient.
3. Select **Delete** to delete this patient.
4. Lock/Unlock. Use to lock/unlock the exam/patient.

**NOTE:** "Delete" is only displayed when you login as Administrator.

## Pop-up menu

If you select the patient and press the left **Set** key, the pop-up menu displays.



Figure 4-13. Archived Patient

If the study was performed on the same day, **Resume Exam** will populate to continue the exam.



Figure 4-14. Patient of the Day

**NOTE:** The preset “Double click on patient list to start”, located on the Utility -> Connectivity -> Miscellaneous screen, allows you to display either the Review or New Exam screen by double clicking the **Set** key on the patient name.

## Changing Patient Information or an Exam

If patient information needs to be edited, pressing **Patient** enables the Patient Screen for modifying information.

If the patient is still active, you can go to the New Patient page to change any field as well as select a different category. The exam changes in the Exam View area.

If the exam category needs to be changed, pressing **New Exam** allows modification of the Patient Screen without erasing accumulated patient images, measurements, annotations, calculations and worksheets.

1. Display the Patient screen by pressing **Patient**.
2. Select patient from the Patient list. The system automatically searches to see if the patient is already in the database.
  - Select Search key (Patient Data: ID, First Name, Last Name, Birthdate, Sex or Exam Date.
  - Enter search string (for example, initial letter of Patient Name)
3. The appropriate patient is displayed.

If patient information needs to be edited or the exam category changed, use the New Exam feature. Pressing **New Exam** allows modification of the Patient Screen without erasing accumulated patient images, measurements, annotations, calculations and worksheets.

**NOTE:** *Patient identification information cannot be modified.*



## Changing Patient Information or an Exam (continued)

4. To have the database shown in its entirety, **Backspace** on the Search string and all patient names appear.
5. Select Register to register the new exam.  
A new exam is automatically created on that patient unless an exam already exists on that day for that patient.
6. To display the patient information on the title bar, press the **Esc** key, the **B-Mode** key or **Register**.  
Select the Model and appropriate probe Touch Panel keys, if necessary.

## Deleting the existing patient/exam/image



### WARNING

Before deleting a patient or image from the Patient Screen, make sure you have already saved the data with EZBackup, Backup, or Export. Verify the media before deletion. Failure to follow instruction could lead to loss of patient data.

## Deleting the existing patient

1. Search and select the patient in the patient list with the **Ctrl** or **Shift** keys.
2. Select **Delete**. The confirmation dialog box displays.  
OR  
Press the left **Set** key. A pop-up menu displays. Select **Delete**. The confirmation dialog box displays.

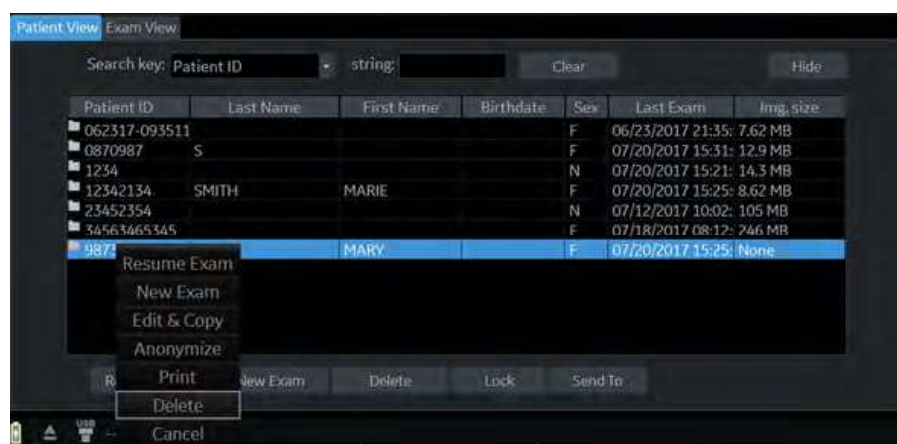

Figure 4-15. Select the patient in the patient list

3. Select **Yes** to delete or **No** to cancel.

## **Deleting the existing patient/exam/image (continued)**

### **Delete multiple patients from the patient list**

1. Select the multiple patients to be deleted from the patient list.
2. Select **Delete**. The confirmation dialog box displays.  
OR  
Press the left **Set** key. A pop-up menu displays. Select **Delete**. The confirmation dialog box displays.
3. Select **Yes** to delete or **No** to cancel.

### **Deleting the existing exam**

1. Search and select the patient in the patient list.
2. Select **Review**.
3. The patient exam screen displays. Select the exam to be deleted.
4. Select **Delete**. The confirmation dialog box displays.
5. Select **Yes** to delete or **No** to cancel.

### **Deleting the existing image**

1. Search and select the patient in the patient list.
2. Select **Review**. The patient exam screen displays.
3. Select the exam which contains the image to be deleted.
4. Select **Active Images** to display the image list.
5. Select the image to delete and select **Delete**. The confirmation dialog box displays.
6. Select **Yes** to delete or **No** to cancel.

# MyPreset

## Overview

MyPreset allows you to configure the specific-presets according to the probe.

You can arrange and edit the presets on the Touch Panel in Utility. See 'Arranging MyPreset Tab' on *page 4-29* for more information.

## Activating MyPreset

1. Check **Default MyPreset** in Utility > System > System Imaging > Control to start MyPreset.
2. From the Touch Panel, select the active probe icon. MyPreset exam tab displays on the Touch Panel.

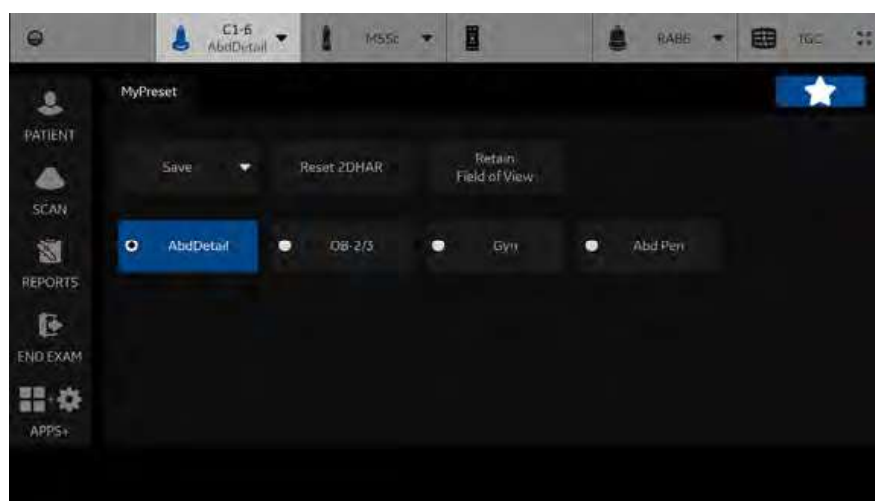

Figure 4-16. MyPreset Tab

**NOTE:** Select MyPreset (star icon) on the Touch Panel. Conventional exam tab displays.

## Activating MyPreset (continued)

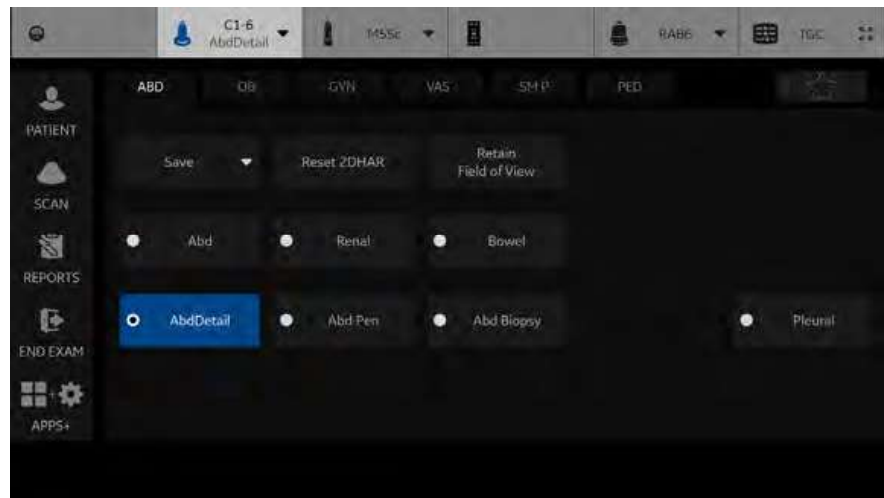

Figure 4-17. Conventional Exam Tab

## Arranging MyPreset Tab

You can update MyPreset Configuration for each probe if desired. Need for each probe separately.

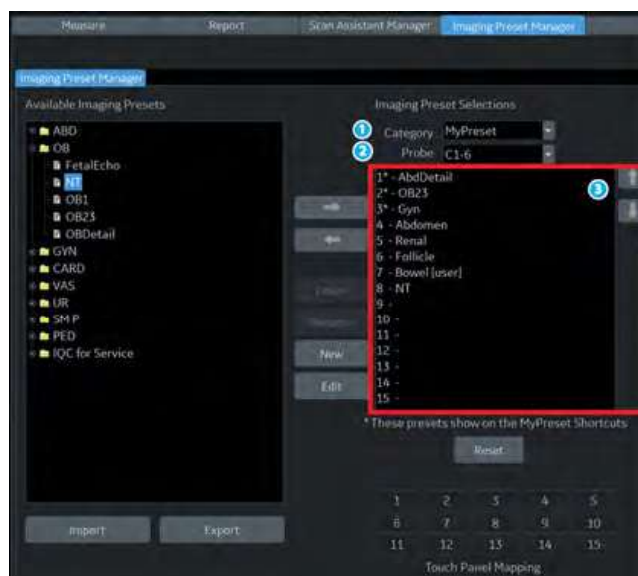

Figure 4-18. Imaging Preset Manager

1. Select MyPreset.
2. Select desired Probe.
3. Select presets from Available Imaging Presets column to be displayed on MyPreset tab. Use the up/down arrow to move the preset to a position.



---

## Chapter 5

# Optimizing the Image

*Describes how to adjust the image. This chapter is broken into the following sections: B-Mode, M-Mode, Color Flow Mode, M Color Flow, Doppler Mode, and 3D Mode.*

# Optimizing B-Mode

## **Intended Uses**

B-Mode is intended to provide two-dimensional images and measurement capabilities concerning the anatomical structure of soft tissue.

## **Typical B-Mode Exam Protocol**

A typical examination using B-Mode might proceed as follows:

1. Record exam-related patient information. Verify system setup (probes and presets).
2. Position the patient and the console for optimum operator and patient comfort. Perform the scan.
3. Complete the study by collecting all the data.



## B-Mode Scanning Hints



### HINTS

These B-Mode controls produce the following results:

**Auto Optimize.** Automatically improves the contrast resolution of the image by changing the gray scale to match the image data. Available in B-Mode and Doppler Mode.

**Coded Harmonics.** Improves image clarity and tissue contrast by reducing clutter and artifacts.

**B-Flow.** Provides a more intuitive representation of non-quantitative hemodynamics in vascular structures.

**Frequency.** Changes system parameters to best optimize for a particular patient type.

**Gray Map.** Affects the presentation of B-Mode information. Choose the gray map prior to making other adjustments. There is an interdependency between gray maps, gain, and dynamic range. If you change a map, revisit gain and dynamic range settings.

**Dynamic Range.** Changes the amount of gray scale information displayed. A higher dynamic range shows more gray scale information displayed, while a lower dynamic range displays less gray scale information onto the same display scale. If you increase the gain, you may want to decrease the Dynamic Range.

**Frame Average.** Smooths the image by averaging frames. Reduces noise in the image.

**TGC.** Adjust TGC to adjust Gain in specific areas.

**Width.** Sizes region of interest. Adjust the Width to the smallest reasonable size to maximize frame rate.

## B-Mode Controls

Table 5-1: B-Mode Controls

Control	Adjusts Acoustic Output	Description/Benefit
Depth	Yes	To increase/decrease, adjust <b>Depth</b> . Depth controls the distance over which the B-Mode images anatomy. To visualize deeper structures, increase the depth. If there is a large part of the display which is unused at the bottom, decrease the depth.
Gain	No	To decrease/increase, rotate <b>Gain</b> (Mode key). B-Mode Gain increases or decreases the amount of echo information displayed in an image. It may have the effect of brightening or darkening the image if sufficient echo information is generated. Note: Always optimize gain before increasing the Power Output.
Focus 	Yes	In B-Mode, 4D and Contrast (Reference and Contrast) mode, the Focus is applied uniformly across the entire field of view, as indicated by the Focus indicator overlaid on the Depth indicator (see example 1 on the left).  In Contrast MVI, CF/PDI/MVI, the Focus position is focused in the Region of Interest, as indicated by the “Dot” indicator overlaid on the Depth indicator (see example 2 on the left). The focus position is assigned to a rotary on the Contrast MVI, CF/PDI/MVI tab.
Auto Optimize	No	See ‘Auto Optimize’ on <i>page 5-8 for more information</i> .
ACE	No	Use ACE (Adaptive Contrast Enhancement) to emphasize echoes from real structures while reducing noise/haze. This results in enhanced signal-to-noise ratio. A sub-selection of ACE allows you to adjust how much ACE is applied, including a setting showing the coherence factor. Values are Light, Medium, or High filtering, or None (no filtering).
Mode Cursor	No	Displays the M/D-Mode cursor on the B-Mode image. To activate/deactivate the M/D-Mode cursor, press <b>Mode Cursor</b> (left Set key). <b>Trackball</b> to position the M/D-Mode cursor. Adjust the Angle and SV Length as necessary.
SRI-HD	No	See ‘SRI-HD (High Detection Speckle Reduction Imaging)’ on <i>page 5-11 for more information</i> .

Table 5-1: B-Mode Controls (Continued)

Control	Adjusts Acoustic Output	Description/Benefit
CrossXBeam	No	CrossXBeam Angle adjusts maximum steering angle of CrossXBeam. Higher values correspond to larger angles. See 'CrossXBeam' on page 5-14 for more information.
Coded Harmonic Imaging (CHI)	Yes	To activate Coded Harmonic imaging, press <b>CHI</b> on the control panel. Coded Harmonics enhances near field resolution, diminishes low frequency high amplitude noise and improves imaging technically difficult patients. Coded Harmonics may be especially beneficial when imaging isoechoic lesions in shallow-depth anatomy in the breast, liver, and hard-to-visualize fetal anatomy.
Frequency	Yes	Adjust <b>Frequency</b> until the desired frequency is selected. Multi Frequency mode lets you downshift to the probe's next lower frequency or shift up to a higher frequency.
Steer	Yes	To slant the linear image to the left/right, select <b>Steer</b> . You can slant the B-Mode or Color Flow linear image left or right to get more information without moving the probe. The angle steer function only applies to linear probes. Linear probes can be steered left, center, or right up to a maximum of 15 degrees, depending on the probe.
Virtual Convex	Yes	To activate/deactivate Virtual Convex, select <b>Virtual Convex</b> . On Linear and Sector probes, Virtual Convex provides a larger field of view in the far field. Virtual Convex is defaulted as active with Sector probes.
Max Angle	Yes	With IC5-9-D and RIC9-5-D probes, the Virtual Convex control becomes Max Angle. Max Angle toggles the field of view to 179 degrees.
TGC	No	TGC amplifies returning signals to correct for the attenuation caused by tissues at increasing depths. TGC slide pots are spaced proportionately to the depth. The area each pot amplifies varies as well. A TGC curve may appear on the display (if preset), matching the controls that you have set (except during zoom). You can choose to deactivate the TGC curve on the image.
Width	Yes	To narrow/widen the sector width, rotate the <b>Width</b> control (located on the Depth control). You can widen or narrow the size of the sector angle to maximize the image's region of interest (ROI).

Table 5-1: B-Mode Controls (Continued)

Control	Adjusts Acoustic Output	Description/Benefit
Tilt	Yes	<p><i>Tilt</i> is available on the Trackball and/or the Rotary control, allowing sector angle adjustment to obtain more information without moving the probe.</p> <p>Trackball Control: When shown as available on the Trackball controls on the display, use the Trackball key and the Trackball to tilt the angle to the left/right.</p> <p>Rotary Control: Rotate the Rotary control to tilt the angle to the left/right. Pressing the control resets Tilt to center.</p> <p><i>Tilt</i> is not available on Linear probes.</p> <p><i>Tilt</i> is not available while in CrossXBeam.</p>
Dynamic Range	No	<p>To increase/decrease, adjust Dynamic Range.</p> <p>Dynamic Range controls how echo intensities are converted to shades of gray, thereby increasing the adjustable range of contrast. Dynamic Range is useful for optimizing tissue texture for different anatomy. Dynamic Range should be adjusted so that the highest amplitude edges appear as white while lowest levels (such as blood) are just visible.</p>
Reverse (if Preset)	No	<p>To flip the image 180 degrees, press the <b>Reverse</b> key.</p> <p>Flips the image 180 degrees left/right.</p> <p><b>WARNING:</b> When reading a reverse image, be careful to observe the probe orientation to avoid possible confusion over scan direction or left/right image reversal. Failure to follow instructions could result in misinterpretation.</p>
Maps	No	<p>To select a map, press the <b>Gray Map</b> on the Touch Panel. A map window displays. The image reflects the map as you go through the selections.</p> <p>The system supplies B, M, and Doppler Mode system maps. Maps are preset-specific and are arranged in order from the softest map on the top of the menu to the map with the most contrast on the bottom of the menu.</p> <p>The only exception is Map J, which is a very soft map.</p>
Frame Average	No	<p>Temporal filter that averages frames together, thereby using more information to make up one image. This has the effect of smoothing the image and reducing apparent noise.</p>
Colorize	No	<ol style="list-style-type: none"> <li>1. Select <b>Colorize</b> on the Touch Panel.</li> <li>2. <b>Trackball</b> to cycle through available maps.</li> <li>3. Press <b>Set</b> to select.</li> </ol> <p>Colorize is the colorization of a conventional B-Mode image or Doppler Spectrum to enhance the user's ability to discern B, M, and Doppler Mode intensity valuations.</p> <p><i>NOTE: You can colorize realtime or CINE images or Timeline CINE, but not DVR images.</i></p> <p>Colorizes the gray scale image to enhance the eye's discrimination capability.</p> <p>The gray bar displays while Colorize is activated.</p> <p>To deselect, select a gray map.</p>

Table 5-1: B-Mode Controls (Continued)

Control	Adjusts Acoustic Output	Description/Benefit
Rotation	No	Rotates the image 180 degrees. Beneficial in transvaginal and transrectal scanning. <b>WARNING:</b> When reading a rotated image, be careful to observe the probe orientation to avoid possible confusion over scan direction or left/right image reversal. Failure to follow instructions could result in misinterpretation.
Frame Rate	Yes	Optimizes frame rate or spatial resolution for the best possible image. High Frame Rate is useful in fetal heartbeat, adult cardiac applications, and clinical radiology applications which require significantly higher frame rates. Low Frame Rate (high resolution) is useful in situations where very small vessels are being imaged, e.g., thyroid, testicles.
Rejection	No	Selects a level below which echoes will not be amplified (an echo must have a certain minimum amplitude before it will be processed). Allows for the elimination from the display of low level echoes caused by noise.
Suppression	No	Suppresses the noise in the image.
Speed of Sound	No	See 'Speed of Sound (SoS) Tissue Imaging' on <i>page 5-28 for more information.</i>

### Auto Optimize

#### Description

Continuous Auto Tissue Optimize (CATO) optimizes the image based on the B-Mode image data. Different preset levels (Low, Medium, High) allow users to choose a preference for contrast enhancement of the B-Mode image. Low provides the least amount of contrast enhancement, high provides most.

CATO is available in single or multi images, on live, frozen or CINE images (in B-Mode only), and while in zoom.

**NOTE:** *The probe orientation mark color is blue with green lines above and below.*

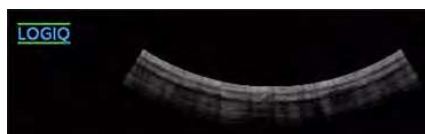

Figure 5-1. Probe Orientation Marker

Auto in PW Doppler Mode (ASO: Auto Spectral Optimization) optimizes the spectral data. Auto adjusts the Velocity Scale/PRF (live imaging only), baseline shift, dynamic range, and invert (if preset). "Running Auto Spectral Optimization" appears at the bottom of the monitor upon activation. Upon deactivation, the spectrum is still optimized.

#### Benefit

Auto can reduce optimization time and create a more consistent process.

#### Adjusting

To activate, press Right **Auto** key.

Press Left **Auto** key to turn off Auto.

#### Auto Optimize Preset

The CATO preset can be set at Utility > Imaging > B-Mode > Auto Optimize Mode. Specify the CATO Level: Low, Medium, or High.



Figure 5-2. CATO Preset

<b>Values</b>	Auto is active until you deactivate it or when you change the following: Probe, Exam Category, Exam Calcs, or New Patient.
<b>Affect on other controls</b>	You may need to adjust the Gain.

### Continuous Tissue Optimization (CTO)

**Description** CTO optimizes the spatial continuous gain adjustment on the B-Mode image. CTO can be used alone or in combination with CATO.

*NOTE: The probe orientation mark color is turquoise with an over and under line.*

**CTO Preset** Select Auto Optimize Mode at Utility > Imaging > B > Auto Optimize Mode. CTO only, CATO only or both may be selected to use a combination of CTO and CATO to optimize the B-Mode image.

**Adjusting** To activate CTO, press the right **Auto** control.  
To deactivate CTO, press the left **Auto** control.  
To adjust the overall CTO Gain, use “CTO Gain” on the Touch Panel or B-Mode Gain. This can be set via Utility--> Imaging--> B--> CTO Gain.

**Benefit** CTO can reduce optimization time and create a more consistent process.

**CTO Availability** CTO is available on the C1-6-D, C1-6VN-D, C2-7-D, C2-7VN-D, C3-10- D, IC5-9-D, RIC5-9-D, RAB6-D, 9L-D, L3-12-D, ML6-15-D, L6-24-D, 12S-D, M5Sc-D and 6S-D probes, in certain applications



## SRI-HD (High Detection Speckle Reduction Imaging)

**Description** SRI-HD (High Detection Speckle Reduction Imaging) is an adaptive algorithm to reduce the unwanted effects of speckle in the ultrasound image. Image speckle usually appears as a grainy texture in otherwise uniform areas of tissue. Its appearance is related to image system characteristics, rather than tissue characteristics, so that changes in system settings, such as probe type, frequency, depth, and others, can change the appearance of the speckle. Too much speckle can impair image quality and make it difficult to see the desired detail in the image. Likewise, too much filtering of speckle can mask or obscure desired image detail. Extra care must be taken to select the optimal SRI-HD level.

**SRI-HD** SRI-HD is available in B-Mode imaging and may be used with any transducer or clinical application when image speckle appears to interfere with the desired image detail.

**Advanced SRI Type 1** Advanced SRI Type 1 is available in B-Mode for select applications, to produce images with clear borders and reduced speckle while maintaining natural image texture.

**Advanced SRI Type 2** Advanced SRI Type 2 is available in B-Mode for OB/GYN applications (as a purchasable option), to produce smoother, cleaner images with enhanced border delineation.

SRI-HD Type 2 is available for the probes and applications listed in Table 5-2.

Table 5-2: Advanced SRI Type 2 OB/GYN Probes and Applications

Probe	OB1	OB23	FetalEcho	NT	GYN	Follicle
C1-6-D/C1-6VN-D	X	X	X	X	X	X
RAB6-D	X	X	X	X	X	X
9L-D	X	X	X	X	X	X
L3-12-D	X	X	X	X		
IC5-9-D	X	X		X	X	X
RIC5-9-D	X	X		X	X	X

**NOTE:** When available per probe and application, the SRI Type can be chosen on the B-Mode tab, page 2.

## SRI-HD (High Detection Speckle Reduction Imaging) (continued)

**Adjusting** Adjust SRI-HD levels on the Touch Panel. You can also set presets via Utility--> Imaging--> B-Mode.

**NOTE:** We recommend selecting the SRI-HD level by observing the enhanced image in side-by-side dual image comparison with the original, unprocessed image. Dual display mode is activated by pressing the L and R keys simultaneously.

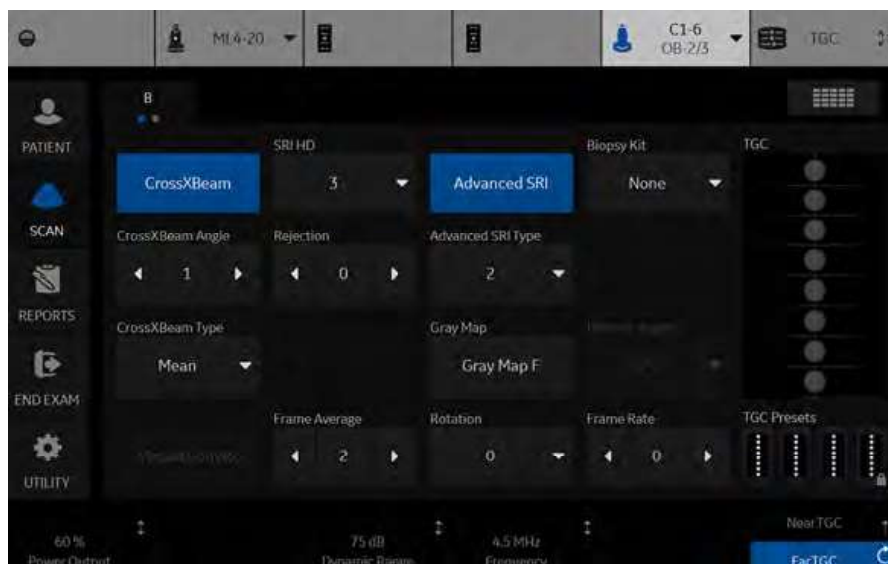

Figure 5-3. SRI-HD Adjustment

**Values** Level values vary, depending upon the probe. 0 = Minimal Filtering. Increasing the level value increases the amount of SRI filtering and will result in smoother images.

**Benefits** SRI-HD smooths the image when image speckle interferes with the desired image detail.

## SRI-HD (High Detection Speckle Reduction Imaging) (continued)

### Tips and Notes

When selecting the SRI-HD level, observe the effect of SRI-HD in the desired region of interest and make a real-time comparison with the original image. The optimal level depends on the clinical situation. Observing the original and SRI-HD-processed images together helps to determine whether too much or too little SRI-HD has been applied.

Dual image mode for SRI-HD can also be activated on a stored CINE Loop. This allows you to always see the original, unprocessed or enhanced image by going into the Dual display mode and to change the SRI-HD settings when reviewing the CINE Loop.

SRI-HD is available on 3D/4D (sectional image and render image).

- You cannot change SRI-HD after the scan starts.
- The effects for the rendered image are less than the 2D-image.

### CrossXBeam

<b>Description</b>	<p>CrossXBeam is the process of combining three or more frames from different steering angles into a single frame. CrossXBeam is available on Convex and Linear probes.</p> <p>CrossXBeam combines multiple co-planar images from different view angles into a single image at real-time frame rates.</p> <p>CrossXBeam Angle adjusts maximum steering angle of CrossXBeam. Higher values correspond to larger angles.</p>
<b>Adjusting</b>	<p>To activate CrossXBeam, press the <b>CrossXBeam</b> key on the Touch Panel; an “X” appears on the display next to “CHI” or “B.”</p> <p>You can also adjust the <b>CrossXBeam Angle</b> and <b>CrossXBeam Type</b> (Mean/Hybrid/Max/MotionCorrection) on the Touch Panel. <b>Max</b> detects maximum values; <b>Mean</b> detects averaged values; <b>Hybrid</b> detects a mix of both average and maximum values; <b>MotionCorrection</b> suppresses blurriness and/or artifacts caused by lateral motion.</p>
<b>Values</b>	<p>All linear and convex probes are supported. B-Mode CrossXBeam is available while in B-Mode, Color Flow, or PW Doppler Mode. Steering is optimized by probe.</p>
<b>Benefits</b>	<p>The combined single image has the benefits of:</p> <ul style="list-style-type: none"><li>• reduced speckle noise,</li><li>• reduced clutter, and</li><li>• continuity of specular reflectors.</li></ul> <p>Therefore, this technique can improve:</p> <ul style="list-style-type: none"><li>• contrast resolution with increased conspicuity of low contrast lesions,</li><li>• better detection of calcifications,</li><li>• biopsy needle visualization, and</li><li>• cystic boundary definition.</li></ul>

## B-Flow

<b>Description</b>	<p>B-Flow is intended to provide a more intuitive representation of non-quantitative hemodynamics in vascular structures.</p> <p>B-Flow is digitally-encoded Ultrasound, using digital codes to enhance weak signals from small particulate reflectors (blood flow) and suppress signals from strong reflectors (tissue). Flow and tissue are displayed simultaneously without threshold decision and overlay.</p> <p>All B-Mode measurements are available with B-Flow active: depth, distance along a straight line, % stenosis, volume, trace, circumference, and enclosed area.</p>
<b>Presetting</b>	<p>Preset the default B Flow Mode via Utility--&gt; Imaging--&gt; General--&gt; BF button.</p>
<b>Activating</b>	<p>To activate/deactivate B-Flow, press <b>B-Flow</b> on the control panel. The preset default B Flow Mode appears. PW Doppler Mode is available while in B-Flow; however, M-Mode and Color Flow/PDI Modes are not available.</p>
<b>Using B-Flow</b>	<p>To optimize the image:</p> <p>Adjust the frequency, display depth, and focal zone location based on the patient body type and anatomy of interest. Adjust Sensitivity/PRI and Background setting as needed (see below).</p> <p>Adjust the remaining Imaging parameters and presets as needed; functionally is the same as B-Mode when in B-Flow mode.</p>
<b>Scanning Hints</b>	<p>B-Flow provides an intuitive view of blood flow, acute thrombosis, soft plaque, small vessel perfusion, and high grade stenosis. Compared to Color Doppler, it does not display bleeding, blooming, or aliasing artifacts.</p> <p>To view high speed jets only for stenosis, use a PRI value of 10 or lower. Use the Background control to display an appropriate amount of tissue background including plaque.</p> <p>To view slow flow, use a large PRI value while avoiding a PRI value that introduces a bar artifact.</p>

### B-Flow (continued)

**Benefits** Compared to Color Doppler mode, B-Flow provides better spatial and temporal resolution, displays blood flow in the entire image, i.e. NO ROI, and is not angle dependent as it does not use the Doppler Principle. B-Flow is therefore a more realistic (intuitive) representation of flow information, allowing you to view both high and low velocity flow at the same time.

**Affect on other controls** When you activate B-Flow, the system remembers the imaging parameters set while in B-Mode. When you optimize the frame rate via Line Density, you compromise the resolution and when you optimize the resolution, you compromise the frame rate. B-Flow is not available in 3DView; but is available in Easy 3D.

**Bioeffects** Using B-Flow Frequency, Focus Position/Number, Sensitivity/PRI, Line Density, Visualization and Power Output may change the TI and/or MI. Observe the output display for possible effects.

### Background

**Description** Background and Tissue controls work together to display the amount of background shown on the B-Flow image. Background provides a large change in the amount of tissue displayed; Tissue provides fine tuning to the amount of tissue displayed.

Adjusts the amount of tissue displayed on the B-Flow image. Works along with the Tissue control.

**Value** 0, 1, 2, 3

- 0 = Least amount of tissue displayed.
- 3 = Most tissue displayed.

*NOTE: Not available for Frozen images or in CINE.*

### Accumulation

**Description** Accumulation enhances the flow in an image; ideal to capture dynamic flow in a still picture.

**Values** Off - Infinite. Infinite provides the same result as applying CINE Capture to a B-Flow CINE clip.

**Benefit** Accumulation detects the maximum signal and holds it (accumulates it) for the level specified (Off - Infinite).

## B-Flow (continued)

### Capture

#### Description

B-Flow Capture provides users the ability to create an accumulated image in B-Flow Live. Maximum intensity projection algorithm to detect the strongest signal between the frames and display the results.

Capture allows the user to represent the dynamic flow situation in the vasculature with a single still image. Adjustments can be made to modify the start and end frames used in the process. Select from the Touch Panel, a “C” will appear in the image parameter list in place of frame average.

*NOTE: B-Flow Capture is assigned to the right Trackball key. You can operate B-Flow Capture from the Touch Panel or the right Trackball key. B-Flow Capture is available only while in Research mode.*

*NOTE: When turning on Live Capture, the cine buffer is cleared of prior data.*

### Sensitivity/PRI

#### Description

Sensitivity/PRI (Pulse Repetition Interval) is proportional to the time interval between the pulses sent to develop the B-Flow image.

In general, a larger value is recommended for slow flow as slow flow detection requires more time separation between pulses so the system can detect the difference in flow profile. However, a larger value could cause bar artifacts on the image. Therefore, it is suggested to not increase the PRI value more than needed. A small value of PRI should be used when the interest is in fast flow only, e.g. viewing a jet in a stenosis case, where the jet is of interest.

*NOTE: Sensitivity/PRI is Probe and Exam Category dependent.*

#### Bioeffects

Using B-Flow Sensitivity/PRI may change the TI and/or MI. Observe the output display for possible effects.

### B-Flow (continued)

#### Visualization

**Description**

Define the display technique.

**Values**

- **B-Flow.** Displays only B-Flow image.
- **Dual.** Displays B-Mode and B-Flow images simultaneously using dual screen.
- **Hybrid.** Displays the B-Flow image over the B-Mode image using Hybrid Map.

*NOTE: Press **L** and **R** at the same time to switch between Visualization values. The switch sequence can be selected in Utility -> Imaging -> BF -> "L/R Button Sequence".*

*NOTE: Available for C1-6-D, C1-6VN-D, C2-7-D, C2-7VN-D, C3-10-D, 9L-D, L3-12-D, L6-24-D, M5Sc-D and ML6-15-D probes.*



## LOGIQView

### Description

LOGIQView provides the ability to construct and view a static 2D image which is wider than the field of view of a given transducer. This feature allows viewing and measurements of anatomy that is larger than what would fit in a single image. Examples include scanning of vascular structures and connective tissues in the arms and legs.

LOGIQView constructs the extended image from individual image frames as the operator slides the transducer along the surface of the skin in the direction of the scan plane. The quality of the resulting image is somewhat user-dependent and requires some additional skill and practice to develop proper technique and become fully proficient.

LOGIQView is not available for the following:

- Multi Image
- Timeline Modes
- B-Flow Mode
- Color Flow Mode
- PDI Mode

### Benefits

The user can look at a larger region of interest within one field of view that is wider than any given probe would normally provide.

### Clinical Use

LOGIQView is intended for scanning areas too large to fit on one image.

### Using LOGIQView

To perform an exam using LOGIQView,

1. Perform a detailed examination of the anatomy/pathology. Optimize parameters for tissue texture and visible window PRIOR TO activating LOGIQView.
2. Press the LOGIQView key on the Control Panel.
3. To start acquiring the image, press **Start** (Trackball key).



### HINTS

When you scan, start with a strong, quick sweep in the direction of the acquisition and then complete the LOGIQView image with a slow steady sweep. LOGIQView acquires images via leading edge vectors (and does not acquire slices, as in CINE). The image is being stored as you perform the scan and you can watch the LOGIQView as it is being acquired.

### LOGIQView (continued)

4. To restart the scan, press **Start** again. You can back up the probe, realign it, then go forward to redo a portion of the scan.
5. To complete the scan, press **End** or Freeze (or allow the scan to auto complete. The LOGIQView is then displayed, scaled to fit entirely on the screen.
6. Perform measurements and record images.
7. Select Frame Review to move through the LOGIQView one frame at a time. Use the Trackball to scroll.

*NOTE: Measurement error is within 5% of the distance you measured for all linear probes.*

### Uniform Motion

The quality and usefulness of LOGIQView images is affected by transducer motion. Incorrect technique can contribute to image distortion.

Guidance and precautions for uniform motion:

- Continuous contact is required throughout the length of the extended image. DO NOT lift the transducer from the skin surface.
- Always keep the transducer perpendicular to the skin surface. DO NOT rock the transducer.
- Keep the motion within the same scan plane, if possible. DO NOT slide the transducer laterally.
- Lateral turning (change in direction to follow anatomical structure) can be accommodated with slower motion. DO NOT make abrupt changes in direction.
- The system accommodates a reasonable range of motion velocity. DO NOT make abrupt changes in speed of motion. Deeper scans generally require reduced speed.

### Bioeffects

Activating LOGIQView has no affect upon Acoustic Output values.

*NOTE: Available for most of 2D imaging supported probes*

## B Steer+ (Option)

<b>Description</b>	BSteer+ allows you to obtain improved biopsy needle visualization without changing B-Mode imaging parameters. B Steer+ is available in B-Mode, Color Flow mode, and PDI mode. BSteer+ is available with all linear probes and the following convex probe: C1-6-D.
<b>Preset</b>	<p>To enable/disable B Steer+: Set the “Steer knob activates B Steer+” preset via the Utility --&gt; Imaging --&gt; General page.</p> <p>To set the B Steer+ Angle and Needle Gain: Set via the presets on the Utility --&gt; Imaging --&gt; B Tab.</p>
<b>Adjustment</b>	<p>To activate B Steer+, adjust the Steer/Width/Depth/Reverse Joystick to the left or right. The B Steer+ symbol and border line display on the image (at the opposite side of product logo).</p> <p><i>NOTE: Make the biopsy and beam angle as perpendicular as possible.</i></p> <p>Needle gain and angle adjustments are available using the:</p> <ul style="list-style-type: none"> <li>• Touch Panel controls (B Steer+ Angles and Needle Gain). Select the appropriate beam angle or needle gain via the Touch Panel control.</li> <li>• Steer/Width/Depth/Reverse Joystick (Needle Gain). Rotate the Steer/Width/Depth/Reverse Joystick left/right to adjust the gain.</li> <li>• Auto (B Steer+ Angle). Press Auto left/right to adjust the B Steer+ Angle.</li> </ul> <p>Find the best needle visibility by changing the needle gain and needle angle.</p>
<b>Values</b>	<p>B Steer+ angle (beam steering angle for needle visualization) is selectable from 15 to 40 degrees. Needle Gain is adjustable from 0 to 100.</p> <p>B Steer values (including enable/disable, B Steer+ angle, and Needle Gain) are returned to factory or user preset values when you change: Probe, Exam Category, Exam Calcs, or New Patient.</p>
<b>Benefits</b>	<p>BSteer+ provides better needle visualization compared to normal B-Mode. B Steer+ allows you to adjust beam angle and needle gain to achieve best possible needle visualization without affecting the B-Mode image. The enhanced needle is superimposed on top of the BMode image, giving the best possible image of both needle and tissue..</p>
<b>Bioeffects</b>	<p>Activating B Steer+ may change the TI and/or MI. Observe the output display for possible effects.</p>

### Activating

To activate BSteer+ press the BSteer+ button (1) in the B tab on the Touch Panel.

**NOTE:** To activate BSteer+ in Color Flow or PDI mode, first select the B tab on the Touch Panel.

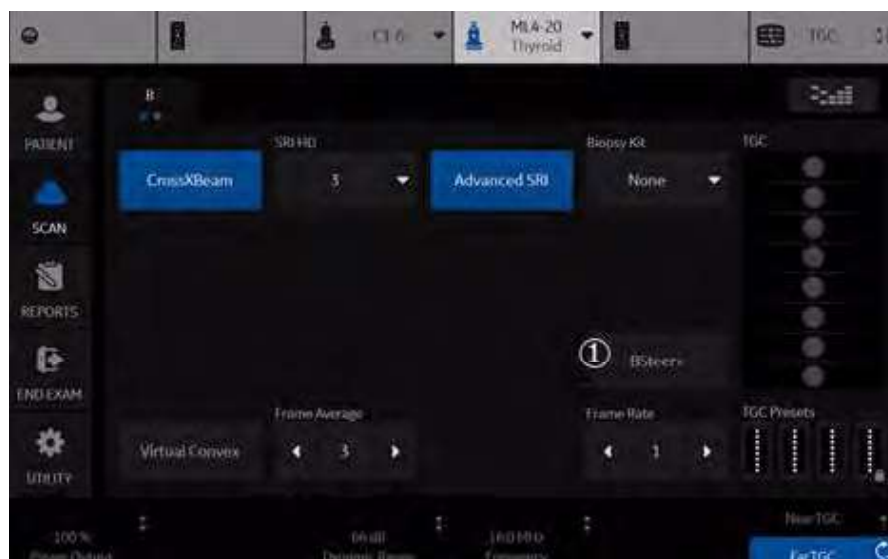

Figure 5-4. Button for activating BSteer+

The steer knob may also be used to activate BSteer+. To do this, check the option Steer knob activates BSteer+ in Utility > Imaging > General menu. Pushing the steer knob left or right will then activate BSteer+.

**NOTE:** When using the Steer knob for BSteer+, this functionality only applies only to the selected probe and preset in the Utility > Imaging menu.

**NOTE:** When using the Steer knob for BSteer+, normal steer functionality will not be available for the selected probe and preset. Activating BSteer+ may decrease frame rate.

### Using B Steer+

When BSteer+ is activated, the BSteer+ symbol (1), and a borderline appears on the image. The borderline indicates the boundary of the needle enhancement area. Beneath the line, the needle is not enhanced by BSteer+.



Figure 5-5. BSteer+ Symbol (1) and Borderline (2)

**NOTE:** For convex probes, 2 borderlines may appear. The region between the lines is the needle enhancement area. This area is narrow relative to the width of the image for a convex probe because the beams are steered so that they are parallel. For convex probes, a limited part of the needle in the image will be enhanced (the tip as it first enters the tissue, and the upper part of the shaft as it is inserted deeper).



Figure 5-6. Two Borderlines May appear in BSteer+ for Convex Probes

The BSteer+ tab and the following controls appear on the Touch Panel.



Figure 5-7. BSteer+ Tab and Controls on the Touch Panel

1. Beam Direction
2. Beam Angle
3. Dynamic FOV (field-of-view)
4. Needle Resolution
5. Needle Gain BSteer+ (for deactivating BSteer+)

To optimize the biopsy image using BSteer+ functionality, adjust BSteer+ beam direction, angle and needle gain.

Adjust BSteer+ beam direction and angle to make needle and beam angle as perpendicular as possible.

BSteer+ beam direction and angle are selectable using the direction and angle buttons on the Touch Panel.

**NOTE:** *BSteer+ angle can also be adjusted using the Set Keys above the trackball if **Use set keys to change BSteer+ Angle** is checked in Utility > System > User Configurable Key menu.*

**NOTE:** *When the BSteer+ tab is active on the Touch Panel, the Auto Keys can also be used to adjust BSteer+ angle. To use Auto Keys to activate and deactivate auto optimize while in BSteer+, select the B tab on the control panel.*

*Adjust Needle Gain to achieve desired needle brightness. Gain is adjustable by rotating the Needle Gain rotary or the Depth rotary (range from 0 to 100).*

**NOTE:** *If the Needle Gain is too high, noise may be amplified along with needle.*

Turning on Dynamic FOV will make the needle signal stronger when the steering angle is not perfectly perpendicular to the needle.

**NOTE:** *Turning on BSteer+ Dynamic FOV may decrease frame rate.*

Select Needle Resolution to achieve desired spatial resolution for the needle. High will make needle appear thinner, and Low will make needle appear thicker.

BSteer+ values (including enable/disable, beam direction, angle and Needle Gain) are returned to factory default values or user preset values when the following change: Probe, Exam Category, Exam Calcs or New Patient.

## Preset



Figure 5-8. BSteer+ Preset

- BSteer+ Beam Direction - preset via Utility -> Imaging -> B Tab.
- BSteer+ Beam Angle - preset via Utility -> Imaging -> B Tab.
- BSteer+ Needle Gain - preset via Utility -> Imaging -> B Tab.
- BSteer+ Dynamic FOV - preset via Utility -> Imaging -> B Tab.
- BSteer+ Needle Resolution - preset via Utility -> Imaging -> B Tab.

### Touch TGC

**Description** TGC amplifies returning signals to correct for the attenuation caused by tissues at increasing depths. TGC slide pots are spaced proportionately to the depth. A TGC curve may appear on the display (if preset), matching the controls that you have set (except during zoom).

*NOTE: TGC adjusts the image automatically when using zoom.*

**Values** When you change the depth, TGC is rescaled across the new depth range. Each pot is proportionately scaled across the depth.

**User-Defined Preset** There are 4 presets located on and selected via the Touch Panel. The right-most preset is locked and cannot be changed.  
TGC Display On/Off -- preset via Utility --> System --> System Display.

**Benefits** TGC balances the image so that the density of echoes is the same throughout the image.

### Adjusting Touch TGC with B-Mode Image Overlay

You can adjust the TGC by overlaying the TGC slidepots over the B-Mode image on the Touch Panel (1), or via the Touch Panel TGC slide pots (2).

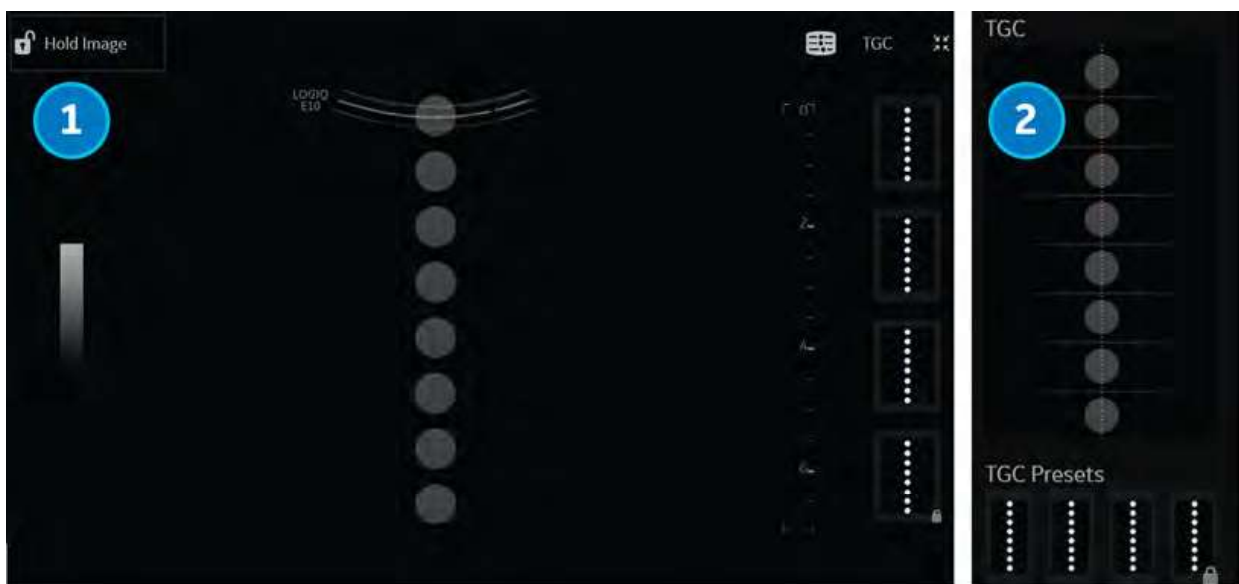

Figure 5-9. Adjusting the TGC



## Touch TGC (continued)

### Adjusting TGC with the B-Mode Image Overlay

To adjust the TGC interactively with the B-Mode image overlay,



1. Press the TGC control, located in the upper, right-hand corner of the B-Mode Touch Panel. TGC “slidepots” appear over the B-Mode image.

Pressing the bottom, right rotary or bottom, right corner of the Touch Panel also enters Touch TGC and adjusts the image.

2. Adjust these slidepots by sliding each slidepot on the Touch Panel with your finger.



#### HINTS

To hold the B-Mode image while adjusting the TGC, select the Hold Image lock located in the upper left-hand corner of the Touch Panel. The Hold Image lock overrides the Utility screen Auto Hide delay timer and hides the TGC slidepots, allowing unobstructed view of the image on the Touch Panel.

When Hold Image is active (or the Auto Hide delay timer is set to Off on the Utility screen), the Full Image button appears. Select the Full Image button to toggle between active B-Mode and the full image area.

NOTE: Though the B-Mode image is locked, you can still adjust the TGC curve while the image lock is active.

3. To save this TGC setting as a preset, press and hold the box on the right until the box displays a blue outline. This TGC setting now appears in the “Custom” window.
4. To reset to the default setting, touch the TGC Presets preset at the bottom of the TGC display on the Touch Panel.

NOTE: *Timeout for TGC display can be set in Utilities --> System ==> General.*

### Adjusting TGC using the Touch Panel

You can also adjust the TGC or select a TGC preset directly on the Touch Panel.

1. Adjust these slidepots by sliding each slidepot on the Touch Panel with your finger; or select TGC preset.
2. To save a TGC setting as a preset, press and hold an available TGC preset box on the bottom of the Touch Panel until the box displays a blue outline.

## Speed of Sound (SoS) Tissue Imaging

Speed of Sound is available on all probes for the following applications: Abdomen, AbdDetail, Abdomen 2, Renal, Bowel, and Breast. The Speed of Sound control is displayed only for these applications and are hidden in all other applications, even when research mode is enabled.

**NOTE:** *Speed of Sound displays on the monitor display as “SoS” with the speed following, “SoS 1500” (when the speed of sound is not equal to 1540).*

A control has been added on the Touch Panel to change the transmitted speed of sound for various breast tissue types:

To activate Speed of Sound for Breast, for example,

1. Select Probe --> Small Parts--> Breast--> B-Mode--> Speed of Sound.
2. Press Speed of Sound on the Touch Panel. Speed of Sound selections appear at the bottom of the Touch Panel in place of the Focus Position control.
3. Adjust the Speed of Sound control up/down to achieve the desired image. The system displays the Speed of Sound (SoS) on the Touch Panel in the upper, right-hand corner of the display as “SoS #####”.

SoS settings are returned to the default for an SoS of 1540 (or when the SoS is not displayed on the display).

## Minimizing Grating Lobe/Side Lobe Artifacts

### Overview

Grating lobes/side lobes often create a spurious structure or clouding within an ultrasound image. Such artifacts are not uncommon in gray scale 2D imaging mode. They are caused by an undesired off-axis ultrasound beam contaminating the main beam.

The ultrasound system presumes that the reflections returning to the transducer always come from the steered direction. However, when these (weaker) off-axis beams encounter a strong specular reflector, the returning reflected energy will be received and "added" to the main beam.

Grating lobe/side lobe artifacts can be especially noticeable within anechoic regions (i.e. fluid, cysts, heart chamber, large blood vessels, etc.).

### Corrective Adjustments

On the LOGIQ Totus, if grating lobe/side lobe artifacts are suspected during the scan, adjustments can be made to reduce such artifacts.

1. Adjust scan window
2. Reduce CrossXBeam Angle
3. Decrease AO

For example, on C3-10-D probe, at default setting for NeoHead, grating lobe/side lobe artifacts are present in Figure 5-10.

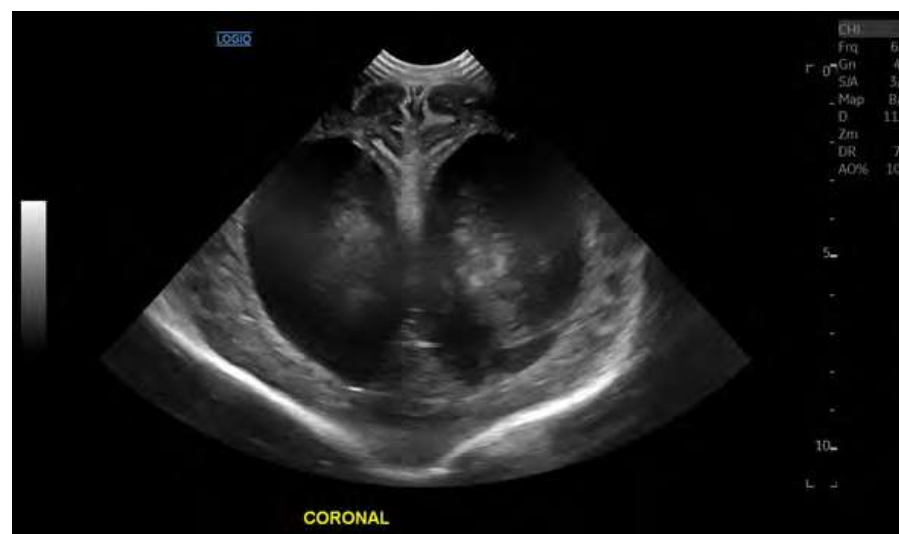

Figure 5-10. Image with Grating Lobe Artifact

### Corrective Adjustments (continued)

To correct, reduce the CrossXBeam Angle and decrease the AO from 100% to 90%. The grating lobe/side lobe artifacts are removed as shown in Figure 5-11.



Figure 5-11. Image with Grating Lobe Artifact Removed

# Optimizing M-Mode

## Intended Use

M-Mode is intended to provide a display format and measurement capability that represents tissue displacement (motion) occurring over time along a single vector.

## Introduction

M-Mode is used to determine patterns of motion for objects within the ultrasound beam. The most common use is for viewing motion patterns of the heart.

LOGIQ Totus has three types of M-Mode:

- Conventional M-Mode: displays a distance/time plot of a cursor line in the axial plane of the 2D-image. Conventional M-Mode can be combined with Color Mode.
- Anatomical M-Mode (AMM)
- Curved Anatomical M-Mode (CAMM)

## M-Mode Display

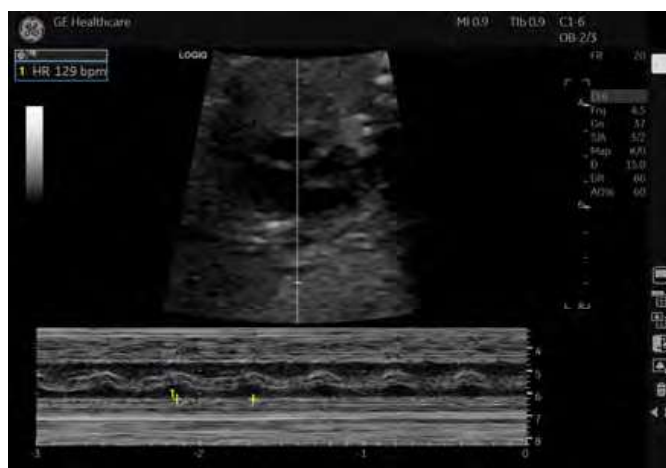

Figure 5-12. M-Mode Display

## Typical exam protocol

A typical examination using M-Mode might proceed as follows:

1. Get a good B-Mode image. Survey the anatomy and place the area of interest near the center of the B-Mode image.
2. Press **Mode Cursor**.
3. Trackball to position the mode cursor over the area that you want to display in M-Mode.
4. Press M-Mode.
5. Adjust the Sweep Speed, TGC, Gain, Power Output, as needed.
6. Press **Freeze** to stop the M trace.
7. Record the trace to disk or to the hard copy device.
8. Press **Freeze** to continue imaging.
9. To exit, press M-Mode.

## M-Mode Controls

*NOTE: You can set default value of each parameter by probe and application on the Utility --> Imaging page. See 'Imaging Presets' on page 10-30 for more information.*

Table 5-3: M-Mode Controls

Control	Adjusts Acoustic Output	Description/Benefit
Sweep Speed	No	To increase/decrease, select <b>Sweep Speed</b> . Changes the speed at which the timeline is swept. Available in M-Mode, Doppler Mode and M Color Flow Mode. You can speed up or slow down the timeline to see more or fewer occurrences over time.

## Anatomical M-Mode (AMM) and Anatomical Color M-Mode (ACMM)

### Description

Anatomical M-Mode gives you the ability to manipulate the cursor at different angles and positions. The M-Mode display changes according to the position of the cursor.

Anatomical M-Mode displays a distance/time plot from a cursor line, which is independent from the axial plane. AMM is available in B, Color and TVI.

**NOTE:** To set up AMM, go to Utility--> Imaging--> AMM. Select the specific probe and parameters.

**NOTE:** Turn off CrossXBeam before activating AMM/CAMM.



Figure 5-13. Anatomical M Mode

### Activating

To activate Anatomical M-Mode, while in M-Mode, press the **Anatomical M** Touch Panel control.

**NOTE:** AMM is not available on Linear probes.

**NOTE:** Anatomical M-Mode can also be used with previously acquired digitally stored 2D images. More than one heart cycle should be stored if performing M-Mode in post processing.

To activate Anatomical Color M-Mode, after accessing Anatomical M-Mode, activate Color Flow (CF).

### Adjusting

Use Touch Panel Trackball to position the M cursor over the required area of the B-Mode image.

1. Use the trackball (assigned function: Pos) to position the M cursor over the required area of the image.
2. Press the top Trackball key to allow free rotation of the solid arrow line throughout the 2D image (trackball assigned function: Angle).

**NOTE:** Rotate the Touch Panel control to angle the M cursor at a given angle.

## Anatomical M-Mode (AMM) and Anatomical Color M-Mode (ACMM) (continued)

<b>Benefits</b>	Color Flow Mode and Color M-Mode are Doppler Modes intended to add color-coded qualitative information concerning the relative velocity and direction of fluid motion within the B-Mode or M-Mode image.
<b>Bioeffects</b>	Changing the Packet Size, Scale, and ROI size may change the TI and/or MI. Observe the output display for possible effects.

### Curved Anatomical M-Mode (CAMM)

Curved Anatomical M-Mode (CAMM) displays a distance/time plot from a free-drawn cursor line. CAMM is available in B, CF and TVI.

1. Select **Curved AMM** on the Touch Panel.
2. Use the Trackball to position the start point of the time motion curve in the B-Mode image.
3. Press **Set** to fix the start point.
4. Use the Trackball to position the next point.  
The time motion curve is drawn by the green line.
5. Press **Set** to fix the point.
6. Repeat step 4 and 5 to draw a complete time motion curve.

**NOTE:** *The time motion curve can be edited by following the curve back to the desired point and redrawn as desired. Following the curve back to the starting point will delete the time motion curve.*

7. Press **Set** twice to complete.

**NOTE:** *Move the cursor to the desired anchor point and press **Set**. Move the point to the desired position and press **Set**.*

8. The arrow cursor appears on the M-Mode image and the red bar appears on the time motion curve.

The red bar indicates the position of the time motion curve relative to the arrow cursor on the CAMM image. They move relative to one another.

**NOTE:** *Press **Set** to clear a cursor line.*

**NOTE:** *Curved Anatomical M-Mode can also be used with previously acquired digitally stored B-Mode images.*

**NOTE:** *CAMM is not available on Linear probes.*



# Optimizing Color Flow

## Intended Use



### WARNING

Color Flow Doppler is intended for qualitative studies only.

Color Flow Mode is a Doppler Mode intended to add color-coded qualitative information concerning the relative velocity and direction of fluid motion within the B-Mode image.

Information regarding the flow velocity and direction is color-coded and rendered onto a BMode image. Flow that travels away from the transducer (negative Doppler shift) is depicted in blue, and flow that is traveling toward the transducer (positive Doppler shift) is depicted in red (colors are user-definable), with lighter shades of each color denoting higher velocities.

## Introduction

A typical examination using Color Flow Mode,

1. Follow the same procedure as described under B-Mode to locate the anatomical area of interest.
2. After optimizing the B-Mode image, add Color Flow.  
*NOTE: Use all noise reduction controls with care. Excessive application may obscure low level diagnostic information.*
3. Move the color flow area of interest as close to the center of the image as possible.
4. Optimize the color flow parameters so that a high frame rate can be achieved and appropriate flow velocities are visualized.
5. Press **Freeze** to hold the image in memory.
6. Record color flow images as necessary.
7. If more definitive information is needed about flow, utilize the procedures described under Doppler Mode.

8. To exit Color Flow, press **CF-Mode** or **B-Mode**.

*NOTE: Most parameters are user presettable by probe and application in the preset menu (Utility -> Imaging -> CF).*

## Activating Color Flow

Color Flow is useful to see flow in a broad area. Color Flow allows visualization of flow in the CF ROI, whereas Doppler Mode provides spectral information in a smaller area.

Color Flow is also sometimes used as a stepping stone to Doppler. You use Color Flow to locate flow and vessels prior to activating Doppler.

## Color Flow Mode Controls

Color Flow Mode and Color M-Mode are Doppler Modes intended to add color-coded qualitative information concerning the relative velocity and direction of fluid motion within the B-Mode or M-Mode image.

Table 5-4: Color Flow Mode Controls

Control	Adjusts Acoustic Output	Description/Benefit
Flow Selection	No	In the Lower Extremity Vein (LEV) and Abdominal applications, you can quickly select the flow state via a shortcut on the Color Flow Mode Touch Panel menu.
Gain	No	Gain amplifies the overall strength of echoes processed in the Color Flow window or spectral Doppler timeline. Allows you to control the amount of color within a vessel or to fill in or clean out spectral information.
Scale (Velocity Scale)	Yes	To raise/lower the velocity scale, adjust <b>Scale</b> . Increases/decreases the Scale on the color bar. Imaging of higher velocity flow requires increased scale values to avoid aliasing.
Wall Filter	No	Filters out low flow velocity signals. It helps get rid of motion artifacts caused from breathing and other patient motion. Gets rid of excess, unnecessary low frequency signals caused by motion.
Size/Position of the color window	No	Adjust size and position of the color window. To adjust the size, press the top trackball key to select <b>Size</b> then move the Trackball left/right, up/down. To adjust the position, press the top trackball key to select <b>Pos</b> then move the <b>Trackball</b> to position the color window. Increase the color window to see a larger area; decrease the color window to improve frame rate and spatial resolution.
Invert (Color Invert)	No	To reverse the color flow, press <b>Invert (Color Invert)</b> . Lets you view blood flow from a different perspective, e.g., red away (negative velocities) and blue toward (positive velocities). You can invert a real-time or frozen image. <i>NOTE: Invert reverses the color map, NOT the color Scale.</i>

Table 5-4: Color Flow Mode Controls (Continued)

Control	Adjusts Acoustic Output	Description/Benefit
Baseline	No	To adjust the baseline, adjust <b>Baseline</b> up/down, as necessary. Changes the Color Flow or Doppler spectrum baseline to accommodate higher velocity blood flow. Minimizes aliasing by displaying a greater range of forward flow with respect to reverse flow, or vice versa. Baseline adjusts the alias point. The default baseline is at the midpoint of the color display and at the midpoint of the color bar reference display.
Angle Steer	Yes	To slant the linear image to the left/right, adjust <b>Angle Steer</b> . You can slant the ROI of the Color Flow linear image left or right to get more information without moving the probe. The Angle Steer function only applies to linear probes. Provides a Doppler cursor angle suitable for linear probe orientation. Beneficial in Peripheral Vascular to image carotids.
Accumulation	No	Accumulation enhances the flow in an image. Accumulation detects the maximum signal and holds it for the level specified. Note: If Accumulation is turned off, then Frame Averaging is used.
Color Flow Line Density	Yes	Optimizes the Color Flow frame rate or spatial resolution for the best possible color image. Low line density is useful in fetal heartbeat, adult cardiac applications, and clinical Radiology applications which require significantly higher frame rates. High resolution is useful in situations where very small vessels are being imaged, e.g., thyroid, testicles.
Map	No	Allows you to select a specific color map. After you have made your selection, the color bar displays the resultant map. Shows the direction of the flow and highlights the higher velocity flows. Velocity Maps (V). Flow shown as blue away/red toward the probe. Velocity Variance Maps (VV). Provides a measure of turbulence (stenosis). Adds green to velocity maps.
Map Compress	No	When you increase the value, high velocity elements in the map are compressed so that the map darkens. When you decrease the value, low velocity elements in the map are compressed so that the map lightens. The effect is visible in the color bar.
Radiantflow	No	Radiantflow provides an easy, fast visualization of tiny vessels, displaying as a 3D effect.
Threshold	No	Threshold assigns the gray scale level at which color information stops. Limits color flow overlay to low level echoes inside vessel walls. Helps minimize color `bleeding' outside vessel walls.
Frame Average	No	Averages color frames. Higher frame averaging keeps the color displayed longer for increased flow visualization while lower frame averaging provides greater flow dynamics.

Table 5-4: Color Flow Mode Controls (Continued)

Control	Adjusts Acoustic Output	Description/Benefit
Transparency Map	No	Brings out the tissue behind the color map. Helps demonstrate the tissues behind the color.
Spatial Filter	No	Smooths out the color, makes it look less pixelated.
Flash Suppression	No	Activates/deactivates Flash Suppression, a motion artifact elimination process. Beneficial to suppress flash.
Packet Size	Yes	Controls the number of samples gathered for a single color flow vector. Allows you to improve the color sensitivity and accuracy of color averaging (increase packet size) or frame rate (decrease packet size), as needed.
Power Doppler Imaging (PDI)	No	See 'Power Doppler Imaging (PDI)' on <i>page 5-44 for more information.</i>

### Radiantflow



#### CAUTION

Radiantflow is a display method which uses the amplitude of the Color flow signal. Note that this may alter the appearance of the Ultrasound information displayed. For diagnostic purposes, this must be taken into account or the Region of Interest must be checked without Radiantflow.

Radiantflow is a rendering technique for Color Flow and Power Doppler Imaging, available on all probes. Radiantflow provides an easy, fast visualization of tiny vessels, displaying as a 3D effect. Press Radiantflow on the Color Flow Touch Panel and select the amount of power signal gradient.

- Off. - Normal Color Flow/Power Doppler Imaging.
- Min. - Less gradient.
- Mid. - More gradient.
- Max. - Most gradient.



Figure 5-14. Radiantflow Map

### Flow Model Shortcuts

Flow Model Shortcuts values vary by application. You can configure these Shortcuts on the Utility--> Imaging--> CF. Below is an example of the Renal Flow Model Shortcuts and the following table lists all the following Flow Model Shortcuts by application.

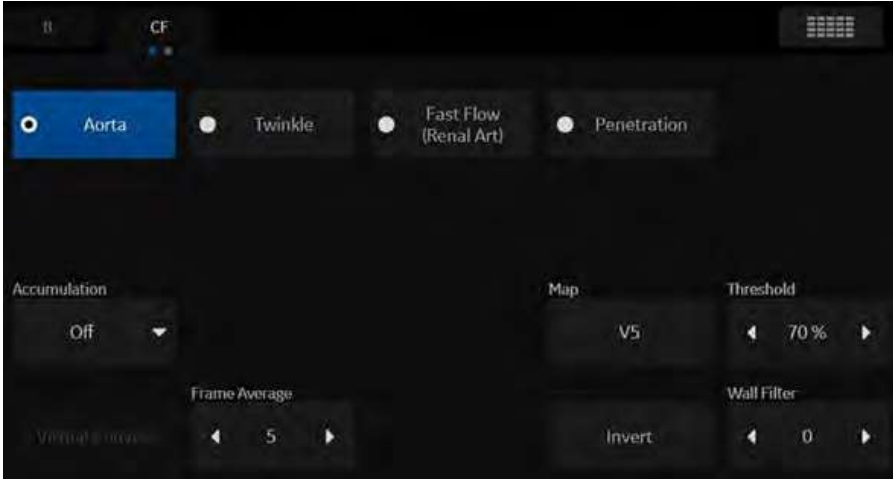

Figure 5-15. Application Flow Model Shortcuts

**Flow Model Shortcuts (continued)**

Table 5-5: Flow Model Shortcuts

Application	Flow Model Shortcuts			
ABD, ABD Biopsy	Aorta	Slow Flow (Renal)	Fast Flow (Renal Art)	Penetration
Renal	Aorta	Twinkle	Fast Flow (Renal Art)	Penetration
OB1, OB23	Fetal Echo	Ovary		
PedAbd	Slow Flow (Renal)		Twinkle	Penetration
NeoHead	Slow Flow			Penetration
NeoAbd	Slow Flow (Renal)			Penetration
Cardiac (Adult, Pediatric)	Fast Frame Rate	Penetration	Slow Flow	
Scrotal	Slow Flow			
Thyroid	Slow Flow	Med Flow	Carotid	
Breast, MskGen	Slow Flow	Med Flow	Fast Flow	Penetration
MskSup	Slow Flow	Med Flow	Fast Flow	Rheuma
LEV	Slow Flow	Fast Flow		
UEV	Slow Flow			
Carotid	Vascular Surgery	Vertebral Arterial (Vert.Art.)		
UEA	Vascular Surgery	Slow Flow		
GYN	Ovary			



## Editing Flow Model Shortcuts

1. Via Utility--> Imaging--> CF, highlight the Flow Model line you want to add/update.

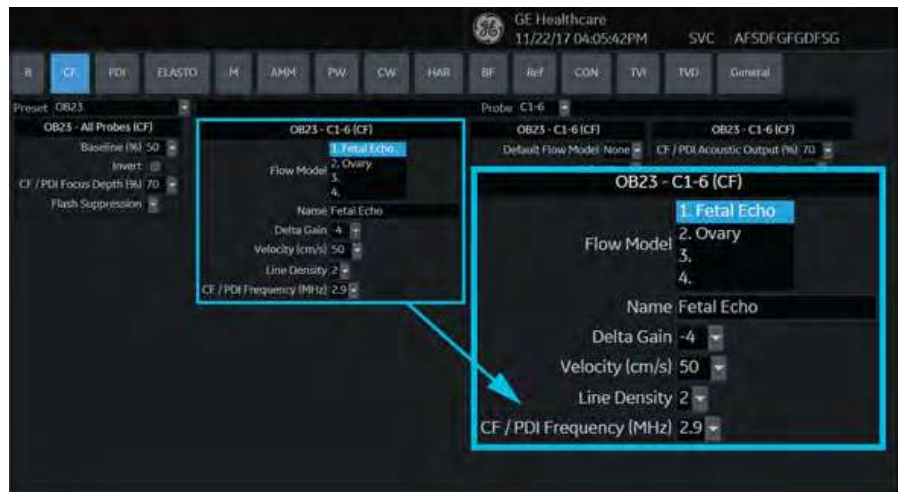

Figure 5-16. Setting up Flow Models

2. Type the Flow Model name in the **Name** field. The Flow Model is updated as you type.
3. Update Delta Gain (increases/decreases Displayed Gain by the dB selected here), Velocity, Line Density, CF/PDI Frequency for this Flow Model.
4. Set Default Flow Model.
5. Press Save, then Exit.

The updated Flow Model is located in the designed position on the Color Flow Touch Panel.

**NOTE:** *Users can free type custom flow shortcuts into the Scan Assistant Creator to use them within Scan Assistant.*

### Power Doppler Imaging (PDI)

**Description** Power Doppler Imaging (PDI) is a color flow mapping technique used to map the strength of the Doppler signal coming from the flow rather than the frequency shift of the signal. Using this technique, the ultrasound system plots color flow based on the number of reflectors that are moving, regardless of their velocity. PDI does not map velocity, therefore it is not subject to aliasing. A sub-mode of PDI has been optimized for visualization of small slow flow vessels, called Micro Vascular Imaging (MVI).

**Adjusting** Press **PDI**. The color flow window appears over the B-Mode image. Move the Trackball to move the CF window. To exit, press **PDI** or select a new mode.

*NOTE: Most parameters are user presettable by probe and application in the preset menu (Utility -> Imaging -> PDI).*

**Values** On/Off.

Twelve power and four directional PDI maps are available.

**Benefits** Since PDI does not display velocity, it does not alias.

**Affect on other controls** When PDI is activated, the following controls are adjusted: Color Map is set to a power map. Line Density is adjusted. Threshold is set to 100%. Frame Averaging is adjusted. Packet Size is adjusted.

*NOTE: These controls are reset to their previous values upon exiting PDI.*



#### HINTS

When changing maps, higher gain settings may be needed.

## Power Doppler Imaging (PDI) (continued)

Table 5-6: Power Doppler Imaging Controls

Control	Adjusts Acoustic Output	Description/ Benefit
Map	No	<p>Allows you to select a specific color map. After you have made your selection, the color bar displays the resultant map. Shows the direction of the flow and highlights the higher velocity flows. Power Maps. Assortment of Black/White, Pink, Blue, Yellow, Red, or B-Flow Maps.</p> <p>Directional Maps. Directional Power Doppler Maps from PDI. Note: If the image is aliasing while in Directional MVI Maps, increase the Scale.</p> <p>You can set the default map by probe via Utility -&gt; Imaging -&gt; MVI -&gt; Default Map.</p>
Background	No	<p>Displays the amount of background image shown on the MVI image. Use the Background control to display an appropriate amount of tissue background including plaque.</p> <ul style="list-style-type: none"> <li>• 0=Least amount of image displayed</li> <li>• 6=Most amount of image displayed</li> </ul>

## Presets

You can set the default PDI imaging mode via Utility -> Imaging -> General -> Default PDI:



Figure 5-17. Set Default PDI

### Micro Vascular Imaging (MVI)

Smaller vessels can be imaged using Micro Vascular Imaging (MVI), which is a sub-mode of PDI optimized for visualization of small, slow flow vessels. It's available on the C1-6-D, C1-6VN-D, 9L-D, L3-12-D, ML6-15-D and L6-24-D probes. MVI is used to detect and visualize micro-vasculature by providing higher sensitivity and higher spatial resolution.

### Activating MVI

Refer to 'System/User Configurable Key' on *page 10-26*.

## Directional Power Doppler

You can select the DPO 0, 1, 2, and 3 Directional Power Doppler maps while in PDI.

**NOTE:** *If you store a PDI image and recall it, you can still switch to the Directional Power Doppler map and vice versa. However, an image stored as non-directional then switched to directional just adds direction to a non-directional map and vice versa.*



### HINTS

If the image is aliasing while in Directional Power Doppler, increase the Scale.

# Optimizing M Color Flow

## M Color Flow Mode

<b>Description</b>	<p>M Color Flow is used for cardiac applications. There is a cursor on the B-Mode image that determines the extent of the Color.</p> <p>The Color Flow maps available in M-Mode are the same as in Color Flow Mode. The size and position of the Color Flow window in B-Mode determines the size and position of the Color Flow window in M-Mode.</p> <p>All M-Mode measurements are available with M Color Flow active: depth, distance along a straight line, % stenosis, volume, trace, circumference, enclosed area, distance, time, slope, and heart rate.</p>
<b>Activating</b>	<p>To activate M Color Flow Mode, press <b>M</b> (M-Mode). Then press <b>CF</b> (Color Flow) - or - press <b>CF</b>, then press <b>M</b>.</p> <p>To toggle between M Color Flow controls and Color Flow controls, press the appropriate Touch Panel Mode tab.</p>
<b>Benefits</b>	<p>Color Flow Mode and Color M-Mode are Doppler Modes intended to add color-coded qualitative information concerning the relative velocity and direction of fluid motion within the B-Mode or M-Mode image.</p>
<b>Bioeffects</b>	<p>Changing the Sweep Speed, Packet Size, Frame Rate/Resolution, Zoom, PRF, and ROI size may change the TI and/or MI. Observe the output display for possible effects.</p>

# Optimizing Spectral Doppler

## Intended Use

Doppler is intended to provide measurement data concerning the velocity of moving tissues and fluids. PW Doppler lets you examine blood flow data selectively from a small region called the sample volume.

## Typical Use - PW Doppler

In Pulsed Wave Doppler (PW) Mode, energy is transmitted from the ultrasound probe into the patient, as in B-Mode. However, the received echoes are processed to extract the difference in frequency between the transmitted and received signals. Differences in frequencies can be caused by moving objects in the path of the ultrasound signal, such as moving blood cells. The resultant signals are presented audibly through the system speakers and graphically on the system display. The X axis of the graph represents time while the Y axis represents the shift in frequency. The Y axis can also be calibrated to represent velocity in either a forward or reverse direction.

PW Doppler is typically used for displaying the speed, direction, and spectral content of blood flow at selected anatomical sites. PW Doppler operates in two different modes: conventional PW and High Pulse Repetition Frequency (HPRF).

PW Doppler can be combined with B-Mode for rapidly selecting the anatomical site for PW Doppler examination. The site where PW Doppler data is derived appears graphically on the B-Mode image (Sample Volume Gate). The sample volume gate can be moved anywhere within the B-Mode image.

### Typical exam protocol

A typical examination using PW Doppler Mode might proceed as follows:

1. Locate the anatomy to be examined. Get a good B Mode image. Press CF to help locate the vessel you wish to examine.
2. Press **Mode Cursor** to display the sample volume cursor and gate.  
or  
Press **PW**. The PW Doppler spectrum appears and the system operates in combined B+Doppler Mode. Adjust **Volume** to adjust Doppler audio. The Doppler signal is heard through the speakers.
3. Position the sample volume cursor by moving the **Trackball** left and right. Position the sample volume gate by moving the **Trackball** up and down. Size the gate by clicking **SV Length**.
4. Optimize the PW Doppler spectrum, as necessary. Refer to the *Doppler Optimization* section of this chapter for more information.
5. Press **Update** to toggle between real time B-Mode with Doppler Mode (with audio).
6. Sample along the whole length of the vessel. Make sure that the probe is parallel to flow. Listen, then look, when positioning the sample volume cursor.
7. Press **Freeze** to hold the trace in memory and stop imaging. Activate CINE Timeline, as necessary. See 'Using CINE' on page 6-3 for more information.
8. Perform measurements and calculations, as necessary. Refer to the Measurements and Calculations chapter for more information.
9. Record results by pressing the appropriate print key, depending on the setup of your recording devices.
10. Press **Freeze** to resume imaging.
11. Repeat the above procedure until all relevant flow sites have been examined.



## Spectral Doppler Display

Time zero (the start of the trace) appears on the left side of the graph. As time progresses, the trace moves to the right. The baseline of the graph (representing zero velocity, zero frequency shift, or no detected flow), appears as a solid line running horizontally across the display. By convention, movement toward the probe is positive and movement away from the probe is negative. Positive frequencies or velocities appear above the baseline. Negative frequencies or velocities appear below the baseline.

Typically, blood flow is not uniform but is composed of a mix of blood cells moving at different velocities and in different directions. Thus, the display is composed of a spectrum as gray scale values. Strong signals are displayed as bright while weak signals are displayed as varying shades of gray.

HPRF (High Pulse Repetition Frequency) is invoked when you are operating in PW Doppler Mode and conditions activate HPRF (when the velocity scale factor or sample volume gate depth exceeds certain limits). When HPRF is active, multiple sample volume gates appear along the Doppler mode cursor. Doppler information can be received from any of the multiple sample volume gates. The Doppler signals from all the gates are added together and displayed in one spectrum.

Information about the PW Doppler display is automatically written on the screen and updated when scanning parameters are changed.

This chapter includes:

- A discussion of PW Doppler.
- Activating Pulsed Wave Doppler.
- Optimizing the Doppler spectrum.

## PW Doppler Mode Display

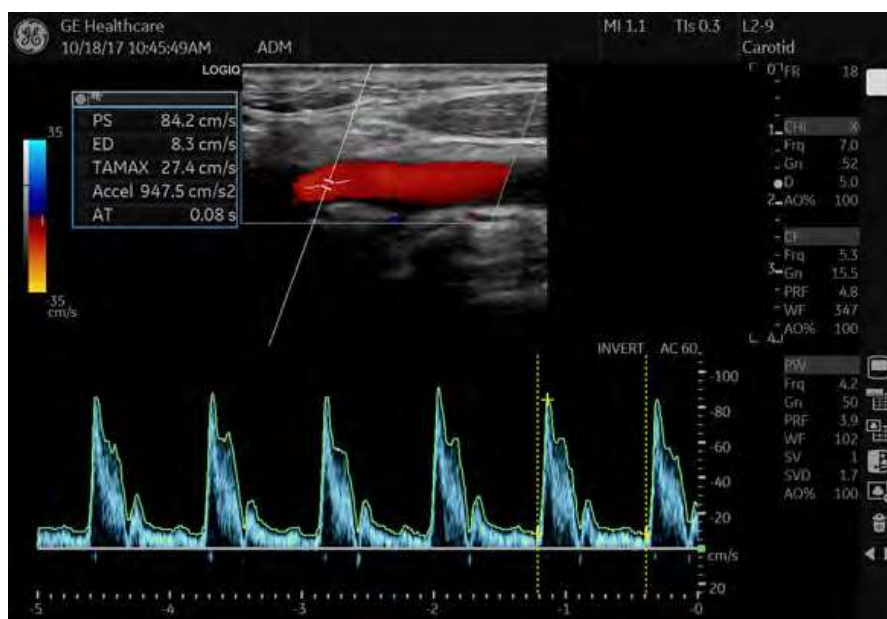

Figure 5-18. PW Doppler Mode Display

Table 5-7: Doppler Mode Display Explanations

Doppler Display	Description, Format, Values
Scale	Velocity Scale, displayed as PRF in kHz.
Wall Filter	Wall filter size, displayed as WF in Hz.
Doppler Gain*	Displays as GN in decibels (dB).
Sample Volume Depth	Displays (in Cm) when Doppler cursor is present.
Doppler Angle (AC ##)	Indicates angle in degrees between the Doppler mode cursor and the angle correction indicator. Displays when Doppler cursor is present. The Doppler Angle displays in red when the angle exceeds 60°. Velocities obtained when the angle is greater than 80° are displayed as asterisks (**).
Spectral Invert	INVERT appears when the spectral trace is inverted and the plus/minus signs (+/-) are reversed.
HPRF	HPRF mode is used when detected velocities exceed the processing capabilities of the currently selected PW Doppler scale or when the selected anatomical site is too deep for the selected PW Doppler scale.
Time Scale	Each selection represents a different sweep time.
Angle Correct	Indicates flow direction.
Sample Volume Gate	Indicates sample volume box. Each probe defaults to a specific range gate.
Doppler Velocity Scale	Flow direction has a positive and negative indicator, noted in centimeters per second (cm/sec). When the velocity scale is less than 10 cm/s, it is displayed to the first decimal point (4.6 rather than 5 cm/s). The Doppler velocity scale adjust as you adjust the Scale.

## Doppler Mode Controls

**NOTE:** You can set the default value of each parameter by probe and application on the Utility --> Imaging page. See 'Imaging Presets' on page 10-30 for more information.

Table 5-8: Doppler Mode Controls

Control	Adjusts Acoustic Output	Description/Benefit
Doppler Sample Volume Gate Position (Trackball)	Yes	To move sample volume gate position, press the top trackball key to select <b>Pos</b> , move <b>Trackball</b> up or down until positioned inside the vessel. Moves the sample volume gate on the B-Mode's Doppler Mode cursor. The gate is positioned over a specific position within the vessel. Positions the sample volume gate to sample blood flow.
Doppler sample volume length (SV Length)	Yes	To increase/decrease the gate size, adjust <b>SV Length</b> on the Touch Panel. Hold down key to continuously size gate. Sizes the sample volume gate. A smaller gate produces accurate sampling results because it is more sensitive. You can also enlarge the gate for sampling large vessels or areas.
Angle Correct/Auto Angle	No	To adjust the angle relative to the probe face, adjust <b>Angle Correct</b> to the left/right. The velocity scale changes when you adjust angle correct. Press <b>Angle Correct</b> to access <b>Auto Angle</b> . Estimates the flow velocity in a direction at an angle to the Doppler vector by computing the angle between the Doppler vector and the flow to be measured. Optimizes the accuracy of the flow velocity. This is especially useful in vascular applications where you need to measure velocity. <i>NOTE: When the Doppler Mode Cursor and angle correct indicator are aligned (the angle is 0), you cannot see the angle correct indicator.</i>
Quick Angle	No	Quickly adjusts the angle by 60 degrees. Press <b>Quick Angle</b> to toggle between Off, Right and Left.
Steer and Fine Steer	Yes	To slant the linear image to the left/right, adjust <b>Steer</b> to the left or right. Press <b>Steer</b> to access <b>Fine Steer</b> . You can slant the ROI of the Color Flow linear image left or right to get more information without moving the probe. The angle steer function only applies to linear probes. Provides a Doppler cursor angle suitable for linear probe orientation. Beneficial in Vascular applications.
Audio Volume	No	Controls audio output. An audio representation of the flow within a vessel can be used to evaluate proper probe angle and position.
Cycles to Average	No	The average value over a number of cycles (from 1-5).

Table 5-8: Doppler Mode Controls (Continued)

Control	Adjusts Acoustic Output	Description/Benefit
Display Format	No	Changes the horizontal/vertical layout between B-Mode and M-Mode, or timeline only.
Update	Yes	<p>To activate, press <b>Update</b> to toggle between simultaneous and update. Doppler Mode does not restart each time the image is updated; however, a black bar may appear with a lightning bolt signaling a break in the timeline.</p> <p>Toggles between simultaneous and update presentation while viewing the timeline.</p> <p>Update increases the Spectral Doppler display quality.</p>
Simultaneous (Duplex/Triplex)	Yes	<p>Duplex allows two modes to be active at the same time; Triplex allows three modes to be active at the same time.</p> <ul style="list-style-type: none"> <li>• B + PW or B + CW or B + CF (Duplex)</li> <li>• B + PW + CF (Triplex)</li> </ul> <p>Update pauses the image while keeping the CW / PW timeline active.</p> <p>When Duplex/Triplex is OFF, either the image or timeline is active. Update then switches the active side between the image and the timeline.</p>
Baseline	No	Adjusts the baseline to accommodate faster or slower blood flows to eliminate aliasing.
Compression	No	Compression controls how echo intensities are converted to shades of gray, thereby increasing the range of contrast you can adjust. Optimizes the image's texture and smoothness by increasing or decreasing the amount of gray scale.
Invert	No	<p>Vertically inverts the spectral trace without affecting the baseline position.</p> <p>The plus (+) and minus (-) signs on the velocity scale reverse when the spectrum is inverted.</p> <p>If you change the probe angle to accommodate anatomy, blood flow still moves in the same direction, but the Doppler information will be reversed. It is easier in cases like this to invert the spectrum instead of reversing the probe orientation.</p>
Scale (Velocity Scale)	Yes	<p>To view signal detail, adjust Scale to enlarge the vertical spectral Doppler trace. Velocity range directly controls the pulse repetition frequency, which is responsible for the setting of the Nyquist limit (the ability to detect maximum velocity without aliasing).</p> <p>If the sample volume gate range exceeds single gate Scale capability, the system automatically switches to high PRF mode. Multiple gates appear, and HPRF is indicated on the display.</p>
Trace Method (Spectral Trace)	No	<p>To get a peak trace, click MAX. A green trace displays on the spectrum.</p> <p>To get a mean trace, click MEAN. A blue trace displays on the spectrum.</p> <p>Traces the average mean and peak velocities in realtime or frozen images.</p> <p>Lets you trace the cardiac cycle.</p>

Table 5-8: Doppler Mode Controls (Continued)

Control	Adjusts Acoustic Output	Description/Benefit
Trace Sensitivity	No	Adjust the trace to follow the waveform for signal strength. If the signal is very faint, increasing the Trace Sensitivity will allow the system to trace that signal strength.
Trace Direction	No	Specifies trace direction. You can select where on the waveform to perform the trace, above, below, or both (above and below).
Cursor Moving	No	On Utility--> Imaging, specify No Action, Update 2D/CF-Long, Medium, or Short, or Update Doppler-Slow, Medium, or Fast. Cursor Moving lets you 'walk' Doppler through a vessel while the Doppler gate is moving. Updates are more frequent on Fast vs. Medium vs. Slow. If you set the preset to Update 2/D/CF, this causes the B Mode/Color Flow image to go live while you move the Doppler cursor.
Time resolution	No	Adjusts image appearance so that if you select a lower setting, the image appears smoother; if you select a higher setting, the image appears sharper.
Wall Filter	No	To increase/decrease, select <b>Wall Filter</b> on the Touch Panel. Insulates the Doppler signal from excessive noise caused from vessel movement. Gets rid of excess, unnecessary information. Cleans out low level noise above and below the baseline so you don't see or hear it on the spectrum.
Auto (Auto Optimize)	No	To activate, press Right <b>Auto</b> key. Press Left <b>Auto</b> key to turn off Auto. Auto in PW Doppler Mode (ASO: Auto Spectral Optimization) optimizes the spectral data. Auto adjusts the Velocity Scale/PRF (live imaging only), baseline shift, dynamic range, and invert (if preset). "Running Auto Spectral Optimization" appears at the bottom of the monitor upon activation. Upon deactivation, the spectrum is still optimized. See 'Auto Optimize' on <i>page 5-8 for more information</i> .
Mode Cursor	No	Displays the Doppler Mode cursor on the B-Mode image. To activate/deactivate the Doppler Mode cursor, press Mode Cursor. Trackball to position sample volume graphic.
Modify Auto Calcs	No	Activates the menu to select which calculations are automatically calculated.
Auto Calcs	No	Activates the calculation automatically which you select in the Modify Auto Calculation when the system is in a state of freeze or live. <ul style="list-style-type: none"> <li>• Live: Auto calculation activates when the system in a state of live.</li> <li>• Freeze: Auto calculation activates when you press Freeze.</li> <li>• Off</li> </ul>

### Auto Doppler Assist

Auto Doppler Assist automatically positions and steers Color Flow ROI and PW Cursor. This to feature is available on all linear probes. Available in Color Flow, Color Flow + PW (Triplex and non-Triplex).

To use Auto Doppler Assist, position the cursor in the Color Flow ROI (the Color Flow ROI has to include the vessel of interest, or part of it). Press the appropriate Touch Panel Auto control (shown below) or press the Auto control to the left for Color Flow or to the right for Pulsed Wave. Manual map the “Auto” controls via Utility--> User Configurable Key.



Figure 5-19. Auto Doppler Assist

Upon pressing the Auto Doppler Assist button, the system will automatically:

- Pick the artery or vein (depending on the selected application).
- Center the Color Flow ROI on the vessel of interest.
- Steer with the direction of the vessel.
- Keeps the Sample Volume in the middle of the ROI.
- Steers the PW Cursor (if existing) to maintain the angle correct set by the operator under Auto Correct on the Utility --> Imaging --> PW --> Angle Correct.

**NOTE:** *If the angle is set to zero, then the system uses 60 degrees.*

# Using 3D

## Overview



### DANGER

DO NOT use the Volume Navigation feature on any patient relying on life-sustaining electronic equipment, such as a pacemaker or defibrillator. Failure to follow this instruction could lead to interference with patient electronic device(s).

Easy 3D is compatible with every 2D transducer using a freehand acquisition to generate a volume dataset.

3D Volume datasets are allowing the navigation in the 3D cube itself and providing access to the 3 different main planes – axial, sagittal and coronal.

There are three 3D Packages:

Table 5-9: 3D Package Options

3D Type	Description	Sensor/No Sensor
Easy 3D	Designed for rendering B Mode and Color Flow Mode images, e.g., Baby Face scans.	No sensor
Advanced 3D	Designed for rendering B Mode and Color Flow Mode images, e.g., vessel trees.	No sensor
Tru3D	Designed for rendering B Mode and Color Flow Mode images, e.g., vessel trees.	Sensor

### 3D Acquisition

#### Acquiring a 3D Scan

To acquire a 3D scan,

1. Optimize the B-Mode image. Ensure even gel coverage.
  2. Press the 3D/4D control panel key. Two screens appear.
  3. Set appropriate values for Acq Mode and Scan Plane. Also, set the scan distance before scanning.
    - Acquisition mode  
Sensorless Parallel is for all acquisitions done with the linear probes and on regular shapes, where you can move the probe parallel on the skin.  
Sensorless Sweep is for the sweep acquisition using the curved probe (i.e. intercostal liverscan or kidney).
    - Scan Distance  
The Scan Distance is an indicator for the size of the Volume: Have you acquired longer distance than 6 cm, increase the Scan distance. Have you acquired a shorter distance than 6 cm, decrease the Scan distance. For sweep acquisition 6 means a transducer angulation of around 60°.
  4. To start acquiring the image, press **Start** (Trackball key).
  5. To perform a parallel scan, scan evenly. To perform a sweep (fan) scan, rock the probe once. Note the distance of the scan.
  6. The 3D volume of interest (VOI) is dynamically assembled on the right side of the screen.
- NOTE: If the image stops before you're done scanning, start acquiring the 3D volume of interest again.*
7. To complete the 3D scan, press **End** (Trackball key).

*NOTE: You can also press Freeze, but then you need to also press the 3D key to obtain the final render.*



## Acquiring a 3D Scan (continued)

### 3D Notes

- Adjust the 3D dataset brightness with B-Mode or Color Flow Mode Gain.
- Use Colorize to change the color of the active dataset.
- Use Zoom to increase the zoom factor of the active dataset.
- Vertical lines may be seen in a resliced image. This usually happens when you scan too fast or if the scan distance is set to a high value.

Scan more slowly, adjust the frame rate for a faster rate or adjust the scan distance.

### 3D Acquisition Parameter Description

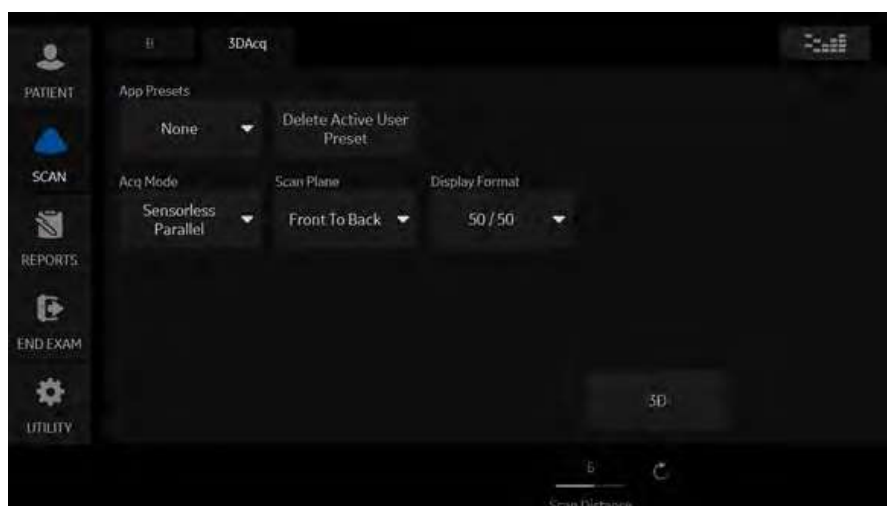

Figure 5-20. 3D Acquisition

Table 5-10: 3D Acquisition Description and Instructions for Use

3D Parameter	Description
App (Application) Presets	<p>Selections: None, OB - Baby Face, Vascular, User 1, User 2, User 3</p> <p><b>None.</b> No application preset applied.</p> <p><b>OB - Baby Face.</b> After having scanned in this mode, certain rendering parameters are set automatically. The gray surface mode is activated and the texture mode is switched off. The gray surface mode values for opacity and threshold are set automatically according to the datasets histogram.</p> <p><b>Vascular.</b> Available only with Advanced 3D or Tru 3D package. After having scanned in this mode, certain rendering parameters are set automatically. The color image is rendered in the texture mode. The values for opacity and threshold of the texture mode are set automatically according to the datasets histogram. The B-Mode image is rendered in the gray surface mode. Opacity and threshold values are defined according to the histogram.</p>
Delete Active User Preset	Select to delete a user preset (User 1, User 2, or User 3).

Table 5-10: 3D Acquisition Description and Instructions for Use (Continued)

3D Parameter	Description
Acquisition Mode	<p>Selections: Sensorless Parallel, Sensorless Sweep</p> <p><b>Sensorless Parallel.</b> In this mode the probe must be moved during 3D data acquisition without angling it. You should scan the object you want to render in 2-4 seconds. The speed at which you scan should be constant. No sensor is mounted on the probe.</p> <ul style="list-style-type: none"> <li>• Since the time for post-processing depends on the acquired number of frames, it is recommended that you check the frame rate. Low frame rates result in fewer acquired frames for the 3D dataset which results in intensive post-processing (interpolation). Therefore, low frame rate = long post-processing.</li> </ul> <p><b>Sensorless Sweep.</b> In this mode the probe must be moved to a position where you can clearly see a middle cut of the object you want to scan and render. Tilt the probe to about 30 degrees until the object you want to scan disappears. Start the acquisition and tilt the probe over a distance of around 60 degrees until the object disappears again. The entire scan time should be around 2-4 seconds. During the sweep, the probe may not be moved parallel, just tilted. No sensor is mounted on the probe.</p> <p>Before starting an acquisition, take care that the transmitter is positioned correctly during data acquisition and that the transmitter cannot move.</p>
Scan Plane	<p>Selections: Front to Back, Side to Side</p> <p><b>Front to Back.</b> After having scanned in this mode, the rendered dataset is shown in a frontal view. For acquiring a fetal face in sagittal cuts, use this mode.</p> <p><b>Side to Side.</b> After having scanned in this mode, the rendered dataset is shown from a side view. For acquiring a fetal face in coronal cuts, use this mode.</p>
Display Format 50/50 Only 2D	<p><b>50/50.</b> Display in Dual Image (2D and 3D).</p> <p><b>Only 2D.</b> Display in Single Image.</p>
3D	Starts the rendering process.
Scan Distance	Adjusts the distance covered during the scan. Depending on the real width of a scan acquired during a sensorless 3D acquisition, the volume of interest's width can be enlarged or reduced. You can adapt the form of a fetal face if the baby's head looks oval instead of round. The assumed default width of a parallel scan is 6 cm; or a fan scan 60 degrees.

**NOTE:** *The selection of user presets is effective only while 3D mode is active. Exiting 3D mode and activating 3D mode again resets the 3D presets to the default setting, regardless if Patient or application changes.*

**NOTE:** *Changing the tab between [Easy] and [Adv3D] changes some parameters that are not common between those tabs.*

**NOTE:** *When a 3D image is recalled, no 3D presets are active and parameters are recalled from the image file.*

**NOTE:** *Default Scan Distance, Opacity and Threshold may not be consistent and may change per scan. After the User Preset is saved and recalled, Opacity and Threshold are consistent.*

## Manipulating the Volume of Interest

Imagine you are able to manipulate the 3D volume of interest (VOI) in your hand. The 3D VOI is a tangible anatomical object that you can see and manipulate easily using the Trackball and Set control panel keys.

Practice positioning the pointer at different places within the 3D VOI. Highlight different colors (white, red, yellow, or green). Press Set to select a VOI for manipulation. Use the hand to manipulate the 3D VOI.

Table 5-11: Manipulating the Volume of Interest

Procedure	Example
<p>Rotating the 3D VOI Left/Right or Forward/Backward                      You can rotate it left to right or right to left. You can rotate it forward/backward. Press right Set key when the white pointer finger is positioned on the white box. Move the closed white hand to manipulate the 3D VOI.</p>	
<p>Moving Through the 3D VOI                      You can move through the 3D VOI using the red hand. Press Set when the red pointer finger is positioned on the red box. Move the closed red hand to move through the 3D VOI.  <i>Note: Any plane in the volume can be made active (highlighted with red box) by clicking on it.</i></p>	

Table 5-11: Manipulating the Volume of Interest (Continued)

Procedure	Example
<p>Viewing Specific Portions of the Anatomy</p> <p>You can pull back tissue to view specific portions of anatomy using the yellow hand. Press Set when the yellow pointer finger is positioned on the yellow box. Move the closed yellow hand to manipulate the 3D VOI.</p> <p><i>Note: This actually moves an edge. A yellow hand appears only when the pointer is on an edge of the VOI.</i></p>	
<p>Pulling Back a Corner of the VOI to View Specific Anatomy</p> <p>You can pull back a corner to view specific portions of anatomy using the green hand. Press Set when the green pointer finger is positioned on the green box. Move the closed green hand to manipulate the 3D VOI.</p>	

## Easy 3D

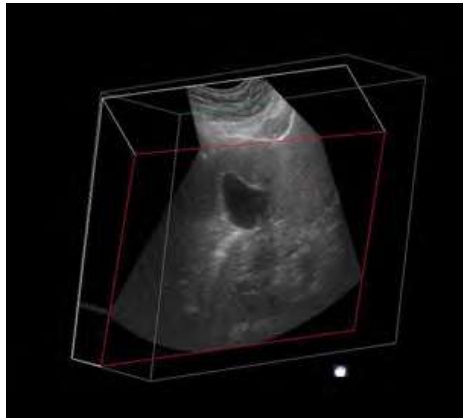
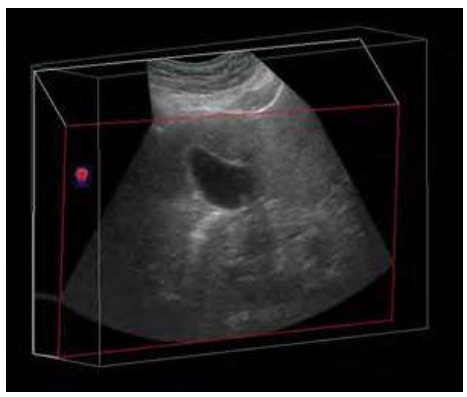
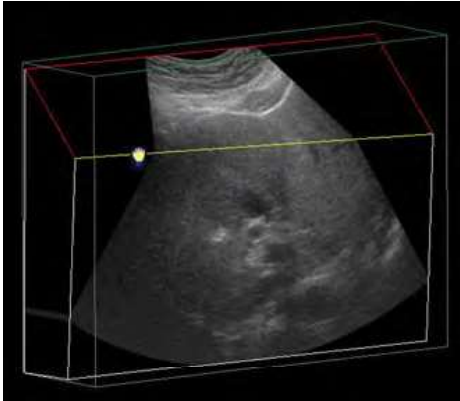
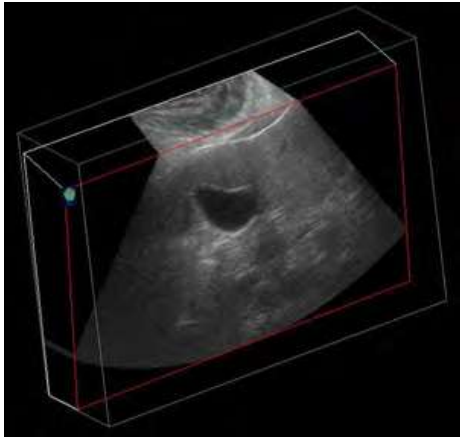
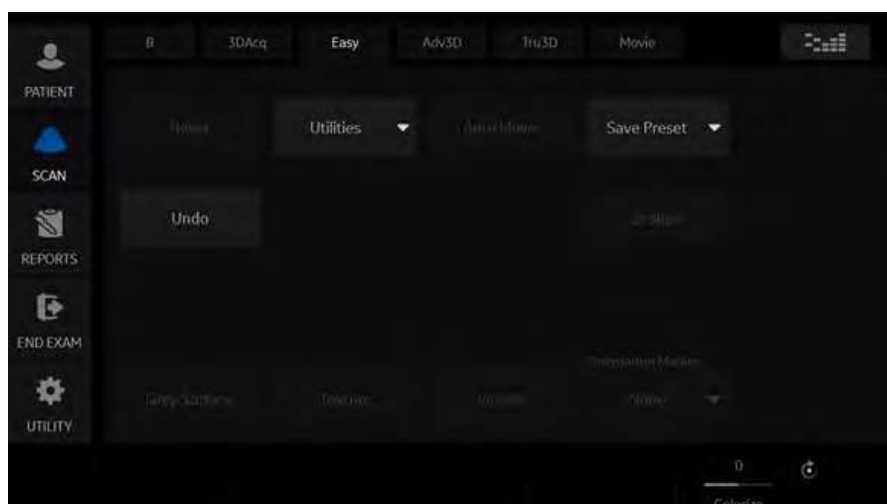

Figure 5-21. Easy 3D

Descriptions and instructions for using Easy 3D follow:

Table 5-12: Easy 3D Description and Instructions for Use

3D Parameter	Description
Reset	Resets the 3D volume of interest back to its original orientation.
Utilities	Select Average Off, Average Light, Average Medium, or Average Strong. Use smoothed volume for rendering the 3D volume. Strong = Most Smoothing.
Auto Movie	Initializes the calculation and display of a 3D movie. A rotation of 30 degrees left and right around the actual image position (either the default position after acquisition or the position that was manually defined by manipulating the 3D volume of interest) is shown. For this 60 degree rotation, eleven images in steps of 6 degrees are calculated.
Save Preset	Save as a user preset (User 1, 2, or 3).
Undo	Undoes any manipulation you have done to your 3D dataset.
Scalpel	Structures, for example a part of the placenta hiding the view to a fetal face, can be cut out in a rendered image. All visible structures can be cut out. The option of 'erase inside' deletes all structures inside the marked region. The option of 'erase outside' deletes all structures outside the marked region. The region in the rendered image is marked with the right Set key. To define the contour of the region, press the right Set key for each vertex. To close the contour, double click the right Set key. As long as a contour is not closed, it can be traced back with the left Set key. The cut out process can be undone by the Undo Last function. As soon as the Apply button is pressed, a new dataset is generated.
Gray Surface	Activates the gray surface rendering mode. It leads to a transparent appearance of the object, generated by displaying only a surrounding shell of structures.

Table 5-12: Easy 3D Description and Instructions for Use (Continued)

3D Parameter	Description
Texture	<p>Activates the texture or photorealistic rendering mode. It creates a photorealistic appearance of the object. The shading depends on the orientation of the surface of the object.</p> <p>If both Texture and Gray Surface mode are switched on, the mixture percentage of both modes can be defined.</p>
Render	<p>Changes between the rendered image view and the view of a volume of interest. The volume of interest shows the acquired ultrasound images transformed into an isotropic rectangular coordinate system. The volume of interest can be manipulated as described above.</p>
Orientation Marker	<p>You can now specify/define, then add the following orientation markers while in 3D via the <b>Orientation Marker</b> key:</p> <ul style="list-style-type: none"> <li>• TRV Sup to Inf</li> <li>• TRV Inf to Sup</li> <li>• SAG Lt to Rt</li> <li>• SAG Rt to Lft</li> <li>• Defined</li> <li>• None</li> </ul>
Threshold/Opacity	<p>Threshold defines which gray values are used for rendering and which are considered noise. Opacity defines how strict Threshold is used for discrimination. A low opacity value creates a firmer appearance of the surface. A high opacity value leads to a transparent appearance of the rendered image.</p>
Scan Distance	<p>Adjusts the distance covered during the scan. Depending on the real width of a scan acquired during a sensorless 3D acquisition, the volume of interest's width can be enlarged or reduced. You can adapt the form of a fetal face if the baby's head looks oval instead of round. The assumed default width of a parallel scan is 6 cm; or a fan scan 60 degrees.</p>
Colorize/Contrast	<p>Colorizes the 3D render or adds contrast to the 3D rendered image.</p>

## Advanced 3D

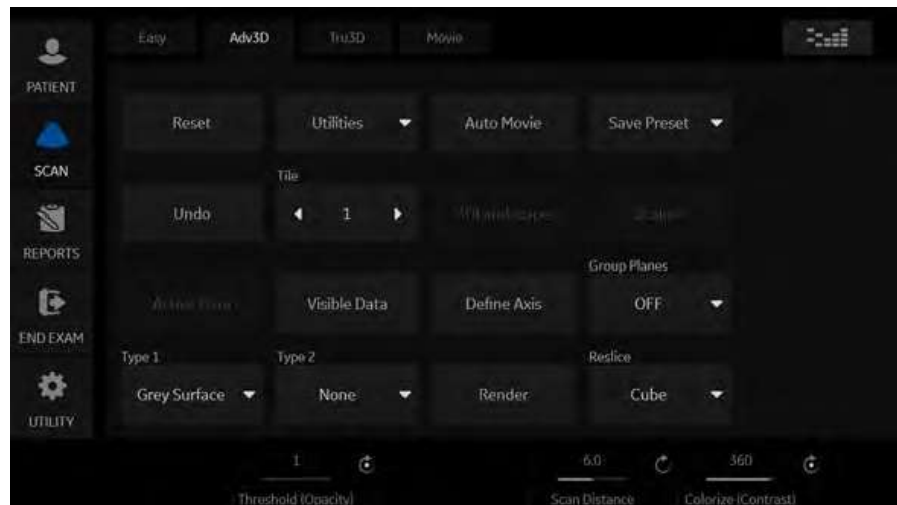

Figure 5-22. Advanced 3D

Descriptions and instructions for using Advanced 3D follow:

Table 5-13: Advanced 3D Description and Instructions for Use

3D Parameter	Description
Tile	The display can be divided into 1, 2, 4, or 6 windows. Switching to a lower number of windows keeps the images from left to right.
3D Landscape	Shows a combination of 2D slices and a 3D rendered image. After a color acquisition you can combine the 2D B-Mode image slices with a 3D rendered color image. This mode allows stepping through the B-Mode images along a vessel structure. The 2D slice can be moved with the right Set key. The Trackball symbol has to be positioned inside the 2D plane.
Active Data	Manipulations of rendering parameters only have an effect on the data defined as Active Data. After having selected Active Data, a list of data is displayed, Gray Data or Inversion. Choose the data to be manipulated. Active Data is only available when you select both Inversion and Gray Data in Visible Data. <i>NOTE: Inversion Mode is only available for Black-and-White mode.</i>
Visible Data	After selecting Visible Data, a list of data is displayed, Gray Data or Inversion. Choose the data you want to display. For example, if only Inversion is chosen, the B-Mode image is switched off in the rendered image and only inversion mode is displayed.
Define Axis	For certain display and measurement modes (Angular Plane Mode, Angular Volume Measurement Mode), an axis in the volume of interest is required. To define the axis, set the start point by using the Trackball to position one end of the axis and pressing the right Set key, then positioning the other end of the axis and pressing the right Set key.



Table 5-13: Advanced 3D Description and Instructions for Use (Continued)

3D Parameter	Description
Group Planes	<p>Selections: Off, Main, Parallel, Angular</p> <p><b>Off.</b> A VOI or a rendered image is displayed. The Render button changes between the rendered image view and the view of the VOI. The VOI shows the acquired Ultrasound images transformed into an isotropic rectangular coordinate system.</p> <p><b>Main.</b> Three orthogonal cuts (with colored frames) of the acquired VOI are displayed after pressing Main. The VOI shows the acquired ultrasound images transformed into an isotropic rectangular coordinate system. On the left top of the image a complete VOI is displayed. It shows the position of the three orthogonal planes in the VOI. A green point displayed in each plane defines the point of intersection of the three planes. This point can be set to different positions in the planes by double clicking the right Set key. A plane can be moved parallel in the VOI by pressing the right Set key on the position of the green point and moving the Trackball up and down inside the plane.</p> <p><b>Parallel.</b> In this mode all displayed VOIs get the orientation of the last modified volume. Normally four VOIs are displayed. It is possible to display six VOIs by increasing the number of displayed volumes in the Tile area. Between the first and the last VOI, the selected planes are parallel and equidistant. A modification on the plane in one VOI results in a parallel modification of the planes in all other VOIs.</p> <p><b>Angular.</b> Before starting the Long Axis Rotation Mode, make sure that a long axis has correctly been defined in the VOI (see Define Axis above). The function starts in the long axis display mode. In the upper, left-hand corner a short axis cut is shown which gives an overview of the orientation of the long axis planes. To move these planes, press and hold down the right Set key while moving the Trackball.</p>
Type 1/2	<p>Defines the rendering modes. Selections: Gray Surface, Texture, Maximum Intensity, Minimum Intensity, Average Intensity, and None. If both Type 1 and Type 2 rendering modes are switched on, the mixture of both modes can be defined.</p> <p><b>Gray Surface.</b> Activates the gray surface rendering mode. It leads to a opaque appearance of the object, generated by displaying only a surrounding shell of anatomical structures. Adjust Threshold and Opacity as well.</p> <p><b>Texture.</b> Activates the texture of photorealistic rendering mode. It creates a photorealistic appearance of the object. The shading depends on the orientation of the surface of the object. Adjust Threshold and Opacity as well.</p> <p><b>Maximum Intensity.</b> Transparent appearance of the object. Generated by displaying the maximum gray values in the VOI.</p> <p><b>Minimum Intensity.</b> The rendered image is generated by displaying the lowest gray values in the VOI that exceed the defined threshold. Dark anatomical structures, like cysts, can be shown in this mode.</p> <p><b>Average Intensity.</b> Transparent appearance of the object. Generated by a summation of the gray values.</p> <p><b>None for Type 2.</b> No second rendering mode is used in addition to the Type 1 rendering mode.</p>
Render	<p>Changes between the rendered image view and the view of a volume of interest. The volume of interest shows the acquired ultrasound images transformed into an isotropic rectangular coordinate system. The volume of interest can be manipulated as described above.</p>

Table 5-13: Advanced 3D Description and Instructions for Use (Continued)

3D Parameter	Description
Reslice	<p><b>Cube.</b> The VOI shows the acquired ultrasound images transformed into an isotropic rectangular coordinate system. This mode allows you to work simultaneously with six cut planes.</p> <p><b>Virtual Rescan.</b> The marked cut planes under Reslice Cube (red border) is displayed without any perspective distortions, e.g., parallel to the screen. This allows you to move through the volume one slice at a time in any direction.</p> <p><b>Cubic Plane.</b> Only one cut plane view is shown in a perspective displayed VOI. The cut plane can be moved freely without any limitations.</p>

## Movie 3D

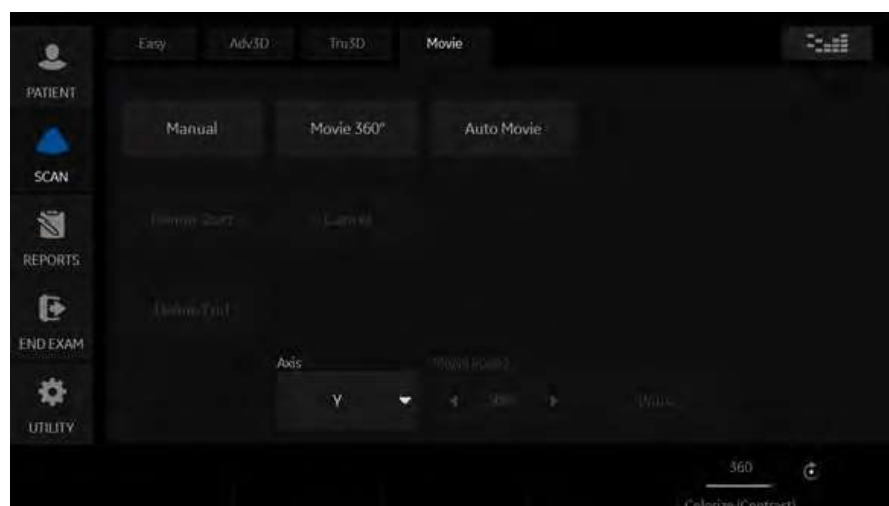

Figure 5-23. Movie 3D

Descriptions and instructions for using Movie 3D follow

Table 5-14: Movie 3D Descriptions and Instructions for Use

3D Parameter	Description
Manual Define Start/End	An animated rotation of the rendered image can be calculated and displayed by this function. Using this function, you first need to define the start and end position of the rotation. To define this, move the VOI to the start position, then press Define Start. Move the VOI to the end position and press Define End.
Movie 360 Degrees	The calculation and display of a complete rotation around the axis, defined by the Axis button, starts in steps of 15 degrees.
Auto Movie	Initializes the calculation and display of a 3D movie. A rotation of 30 degrees left and right around the actual image position (either the default position after acquisition or the position that was manually defined by manipulating the 3D volume of interest) is shown. For this 60 degree rotation, eleven images in steps of 6 degrees are calculated.
Axis	All rotations (Auto Move and Movie 360) are calculated as rotations around the specified axis (X, Y, or Z).
Movie Speed	You can adjust the speed of any 3D rotation.
Pause	Stops and restarts the rotation. As soon as Pause is pressed, the different rotation steps can be displayed by moving the Trackball.

## Tru3D and Volume Measurement

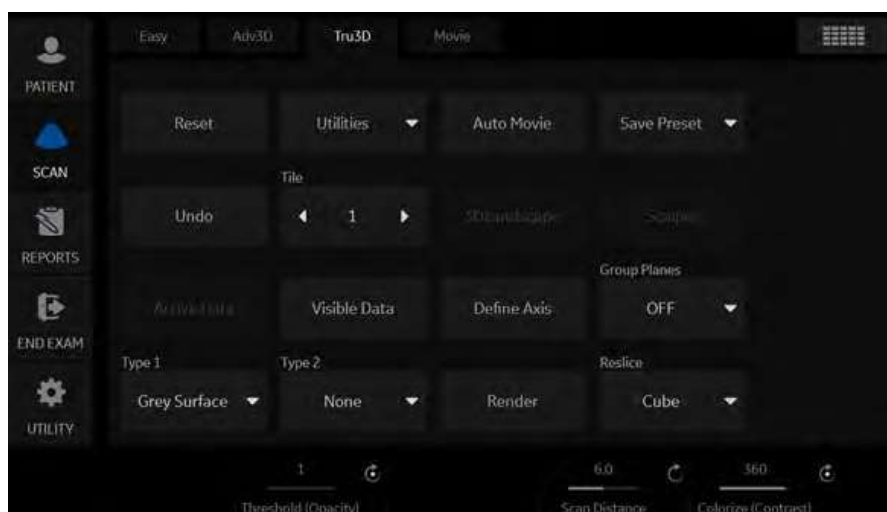

Figure 5-24. Tru3D

Descriptions and instructions for using Tru3D are the same as noted in the Advanced 3D section. See Table 5-13 on page 5-66 for a description of these controls.

### Performing a Sensor Scan

To perform a sensor scan,

1. Attach the sensor cables to the front of the Ultrasound system.
2. Attach the probe bracket to the probe, unless using a VNav Inside (VN) probe.  
Insert the receiver into the bracket on the probe.
3. Position the magnet near the patient, within 18 inches of the probe, next to the patient on the bed.
4. On the Touch Panel, select With Sensor.
5. Acquire the 3D scan.

## Tru3D

Table 5-15: Tru3D Descriptions and Instructions for Use

3D Parameter	Description
Acquisition Mode	<p><b>With Sensor.</b> Only available if you are using the Tru 3D package. In this mode the probe can be moved in different ways over the object you want to render. The probe can be moved parallel and angled during the same 3D acquisition. The sensor system registers any movement. It is recommended not to move in one direction and back again during one scan. It is also not recommended to turn the probe around its axis. The scanning speed does not have to be constant, but you should not change the velocity too much. In this mode the sensor has to be mounted on the probe.</p> <p>Before starting an acquisition, take care that the transmitter is positioned correctly during data acquisition and that the transmitter cannot move. The transmitter has to be placed in such an orientation that the probe with the receiver attached is always in the forward hemisphere of the transmitter during scanning.</p> <p>The patient MAY NOT move during the acquisition.</p> <p>The sensor device consists of an electromagnetic field transmitter and a field receiver. The field transmitter generates an alternating spheric electromagnetic field in a strength of up to five times the earth's magnetic field, depending on the distance between the transmitter and the receiver. For 3D data acquisition, the probe with the attached position sensor can be moved freely in an area of 70 cm around the transmitter.</p> <p>During data acquisition, the electromagnetic sensor device generates with a frequency of about 100 Hz a set of three translation and three angle values. These values describe the position of the ultrasound probe in space.</p>

**Magnetic field range from the transmitter**

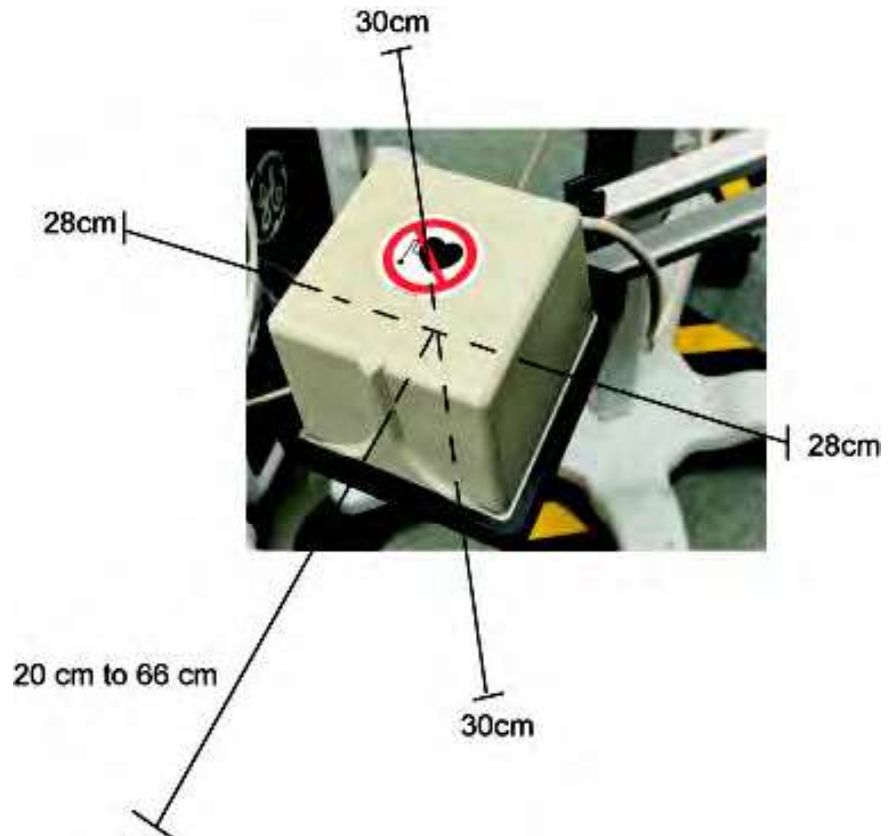

Figure 5-25. Magnetic field range from the transmitter

From the center of the transmitter,

1. 30cm above and below
2. 28cm left and right
3. 20 - 66cm forward

**NOTE:** *Remove the metal product from the region of the magnetic field to increase accuracy of position detection.*

## Volume Measurement

The average measurement error for distance measurements is 5% and for volume measurements is 10%.

### Workflow example

**NOTE:** *If you print out a Volume Measurement image with a B/W printer or store it onto the Clipboard, change the following presets before performing the Volume Measurement. On the Utility -> Connectivity -> Button preset menu in the Volumes section, choose Volume File Format\* = 2 - Standard DICOM with Raw Data and in the Still Images section, choose Format = Secondary Capture Image.*

1. Scan in 2D-mode. Select Auto Sweep. Acquire and store the image.
2. Recall Image. Activate **3D/4D**.
3. Select **Vol. Meas** Tab. Select **Angular Method**.



Figure 5-26. 3D Volume Measurement

**NOTE:** *Angular method is intended for spherical objects. Serial method is intended for rectangular objects.*

### Volume Measurement (continued)

4. Define the axis and press **Enter**.
5. Six cut planes are displayed. You measure the volume by marking the contour of the anatomy.
6. When all traces are completed, the system displays the volume in the Results Window.

Measurement examples are shown below:

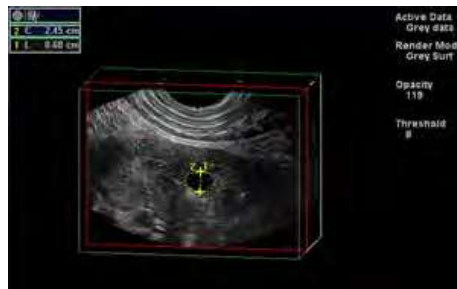

Figure 5-27. 2D Measurement (Example)

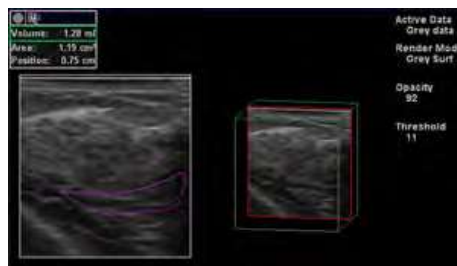

Figure 5-28. Example of Segment Method

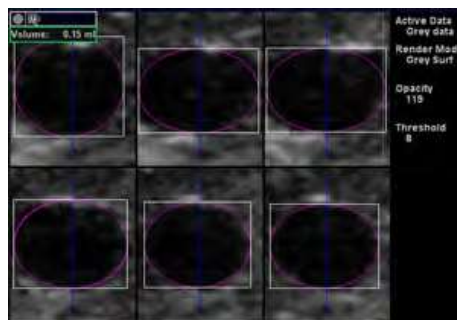

Figure 5-29. Example of Angular Method



## Volume Measurement (continued)

Table 5-16: Volume Measurement Descriptions and Instructions for Use

3D Parameter	Description
2D	<p>Type of 2D measurement: Distance, Angle, Circumference, Area</p> <p><b>Distance.</b> Set the start and end distance using the right Set key.</p> <p><b>Angle.</b> An angle is measured by marking two lines. Press the right Set key once marks the beginning of the first line. Press the right Set key again to mark the end of the first line and simultaneously the beginning of the second line (the intersection of two lines). Press the right Set key a third time to close the angle measurement.</p> <p><b>Circumference.</b> The circumference of an area is measured by marking the contour of the anatomy by a polygon contour. Each point of the polygon is marked by pressing the right Set key. A double click of the right Set key closes the circumference. As long as the contour is not finished, each point can be deleted by a single press of the left Set key.</p> <p><b>Area.</b> An area is measured by marking the contour of the anatomy by a polygon contour. The area of an area is measured by marking the contour of the anatomy by a polygon contour. Each point of the polygon is marked by pressing the right Set key. A freehand contour can be drawn by pressing and holding down the right Set key and moving the Trackball. Double click the right Set key to complete the area. As long as the contour is not finished, each point can be deleted by a single press of the left Set key.</p>
Angular Method	<p>This function allows you to mark any volume of interest in the dataset to measure its volume or to perform a segmentation of the object.</p> <p>The volume of a 3D object is determined by drawing the contour in several planes, which are rotated around an axis defined by the user. The contours are used to calculate the volume of the object.</p> <p>To determine the volume of an object based on the multiplanar Simpson rule, you need to define the rotation axis via Define Axis.</p> <p>When you press Angular Method, six cut planes are displayed. The Long Axis is marked in blue. You measure the volume by marking the contour of the anatomy. The contour can be marked in different ways: Polygon, Spline, Ellipse, Rectangle, or Rotate.</p> <p><b>Polygon.</b> Each point of the polygon is marked with a single press of the right Set key. A freehand contour can be drawn by pressing and holding down the right Set key and moving the Trackball. Double click the right Set key to complete the area. As long as the contour is not finished, each point can be deleted by a single press of the left Set key.</p> <p><b>Curve.</b> An area can be marked by single points positioned by pressing the right Set key. A double click on the right Set key closes the spline. The position of the points defining the contour can be changed by clicking on the point and moving it by pressing the right Set key and using the Trackball. As long as the contour is not finished, each point can be deleted by a single press of the left Set key.</p>

Table 5-16: Volume Measurement Descriptions and Instructions for Use (Continued)

3D Parameter	Description
Angular Method	<p><b>Ellipse.</b> When you select this mode, a circle is displayed. You can move the circle by pressing and holding down the right Set key while moving the circle with the Trackball. Press the right Set key to set the chosen position. To manipulate the shape of the circle, move the edges of the circle while pressing the right Set key.</p> <p><b>Rectangle.</b> When you select this mode, a rectangle is displayed. You can move the rectangle by pressing and holding down the right Set key while moving the rectangle with the Trackball. Press the right Set key to set the chosen position. To manipulate the shape of the rectangle, move the edges of the circle while pressing the right Set key.</p> <p><b>Rotate.</b> Using the rotate function, you can rotate an area around the Z axis. When you select this function, the Trackball symbol changes as soon as it is positioned to an edge of a region. The region can then be rotated by pressing and holding down the right Set key.</p> <p>A region can be selected and deleted by pressing the Clear key.</p> <p>To save a measurement, press Save Segment, Save to Report, or Cancel.</p>
Serial Method	<p>The Serial Method allows you to mark any volume of interest in the dataset to measure its volume or perform a segmentation of the object.</p> <p>A volume definition is done by defining areas at different depths.</p> <p>Before starting the volume measurement, you need to select a plane showing a cut in which the object can be clearly defined. When you press Serial Method, the display window shows two different views. The left side displays the active plane as a single plane. The VOI on the right side is displayed in cubic mode.</p> <p>In the right VOI select the cut plane position where the measurement process should start. In the left plane, mark the object of interest by designating one of the area definition modes (Curve, Ellipse, Rectangle, Polygon, Rotate).</p> <p>After you have completed defining the first area, the depth of the VOI should be changed on the right side. To change the depth, position the Trackball symbol inside the plane to be moved. press and hold down the right Set key while moving the Trackball backwards. By defining the contour of an object at different depths, its volume can be calculated by summing up the defined slices.</p> <p>To save a measurement, press Save Segment, Save to Report, or Cancel.</p>
Define Axis	<p>For certain display and measurement modes (Angular Plane Mode, Angular Volume Measurement Mode), an axis in the volume of interest is required. To define the axis, set the start point by using the Trackball to position one end of the axis and pressing the right Set key, then positioning the other end of the axis and pressing the right Set key.</p>
Save Segment	<p>After measuring a volume, you can use the defined volume for segmentation by pressing Save Segment. Segmentation means that a new dataset is created with voxel information based on the defined volume. A dataset containing only voxels inside the measured volume is created. The original dataset is saved additionally to the segmented data. The segmented data can be chosen in the Active Data or Visible Data list.</p>
Save to Report	<p>After measuring a volume, press Save to Report to register the measurement result in a database that is used for report generation.</p>

---

# Chapter 6

## Scanning/Display Functions

*Describes additional ways in which to adjust the image.*

# Freezing an Image

## Introduction

Freezing a real-time image stops all movement and allows you to measure and print the image.

*NOTE: While the image is frozen, all Power Output is suspended.*

## Freezing an image

To freeze an image,

1. Press **Freeze**. The Freeze key backlight turns blue.

If you are in a mixed mode, both screen formats stop immediately. Deactivating Freeze restarts both modes and places a black bar on the trace to indicate the time discontinuity.

To reactivate the image,

1. Press Freeze again.

*NOTE: Selecting a new probe unfreezes the image*

*NOTE: Deactivating Freeze erases all measurements and calculations from the display (but not from the worksheet).*

Use the Trackball to start CINE after pressing Freeze.

# Using CINE

## Introduction

CINE images are constantly being stored by the system and are available for playback or manual review via CINE.

You can view CINE as a continuous loop via CINE Loop or manually review CINE images frame by frame via the Trackball.

Data in CINE is available until new data is acquired. CINE is stored on the system's memory and can be archived as well.

CINE is useful for focusing on images during a specific part of the heart cycle or to view short segments of a scan session.

## Cine gauge



Figure 6-1. Cine gauge

1. Loop speed
2. Cine gauge
3. Current frame number/total frame number  
The cine gauge indicates which frame you are viewing of the whole loop.
4. Current number of seconds/total number of seconds  
The cine gauge indicates which frame you are viewing of the whole loop.
5. Start frame
6. End frame

### Touch Panel

The following Touch Panel appears:

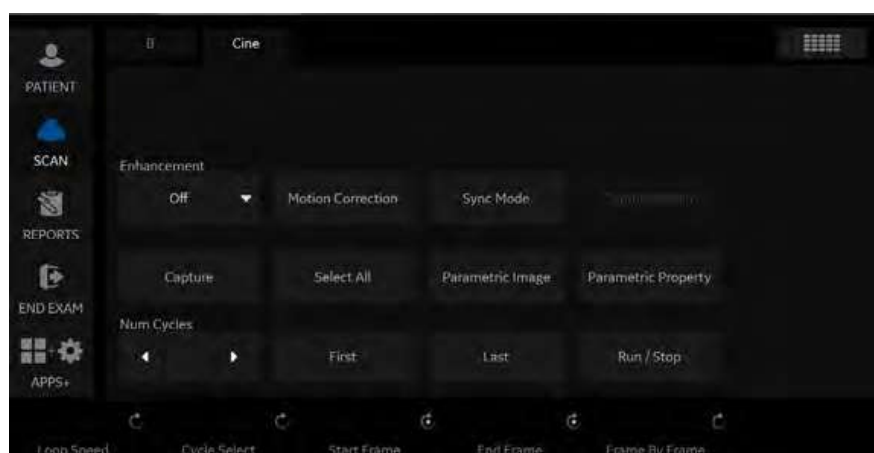

Figure 6-2. Cine Touch Panel

Table 6-1: Cine Touch Panel description

Parameter	Description
Select All	Select all frames of the cineloop.
Sync Mode	Phase synchronizes multiple cineloops.
Num Cycles	Control the number of heart cycles to be included in the cineloop.
First	Move to the first frame of cineloop.
Last	Move to the last frame of cineloop.
Run/Stop	Start/Stop the cineloop review.
Loop Speed	Adjust the cineloop playback speed.
Cycle Select	Select the heart cycle to review.
Start Frame	Rotate the rotary to select the start frame and push to set the frame.
End Frame	Rotate the rotary to select the end frame and push to set the frame.
Frame by Frame	Review the cine image frame by frame manually.
Capture	Searches through all images between the start frame and end frame and displays each peak or the highest velocity/tissue power.
Capture Recon.	Capture Recon. reconstructs small blood vessels in the cine mode.
Enhancement	Execute the enhancement to the Cine capture image. Select Off, Shade FW, Shade Rv, Enhance1, Enhance2 or Enhance3.
Motion Correction	Motion correction compensates each frame and cancels the motion.

## Using CINE

*NOTE: Preset the parameters as necessary.*

1. Press **Freeze**.
2. Move the Trackball to activate Cine.
3. Use the trackball or **Frame by Frame** to scroll through the acquisition and find the sequence of interest.
4. Press **Start Frame** or **End Frame** to set the corresponding cineloop boundary to the current frame as necessary.  
Rotate **Start Frame** and **End Frame** to trim or expand the cineloop boundaries.
5. Adjust **Cycle Select** to move from heart beat to heart beat and select the heart cycle of interest.
6. Adjust **Num cycles** to select the number of heart beats to play back.
7. Press **Run/Stop** to run the cineloop and then press the print key to store the cineloop.  
Cine loops stored on the clipboard are indicated with a movie strip icon.
8. Press **Run/Stop** again to stop the cine loop.
9. Press **Freeze** to return to live scanning.

*NOTE: If you don't need edit, only press Run/Stop to run the cineloop and print key to store.*

*NOTE: Cineloop storage can be configured to store heart cycles with additional time before and after the R-wave and to display a preview before storage. See 'Print Controls' on page 10-50 for more information.*

### Adjust the cine loop speed

Rotate Loop Speed to set the speed of the cineloop playback.

The speed factor (%) is displayed above the cine gauge.

### To view a cineloop frame by frame

In freeze, use the trackball or **Frame by Frame** to scroll through the cineloop frame by frame.

### Synchronize cine loops

1. Recall stored cine loop to right side of dual screen.
2. Recall same cine loop to left side of dual screen.
3. Change visualization of left side image
4. Select **Sync mode** to start the synchronization.

*NOTE: This is useful for Hybrid Contrast to display and check Contrast and Hybrid Contrast for example.*

### Recalling a cine loop

To recall a cine loop, double click on the cine loop on the clipboard.

*NOTE: CINE Loops stored on the Clipboard are indicated with a movie strip icon.*

### Cine Mode Selection

To scroll the B-Mode cine loop only, toggle the top Trackball key and select **Scroll B**.

To scroll the Timeline cine loop only, toggle the top Trackball key and select **Scroll D**.

### Velocity Scale with B-Mode Only

If you review the B-Mode cine loop while in Doppler Mode with the Timeline using Scroll B, the Velocity Scale displayed with the Timeline is for the time phase of the currently-displayed B-Mode image, NOT for the time phase of the acquired Doppler Spectrum.

Check the velocity value with the measurement function if you review the cine loop using Scroll B. Note that there may be a discrepancy between the velocity scale displayed and the velocity measured using the measurement function.



## Mark CINE

### Preset

1. Check **Enable Mark Cine Control** via Utility -> Application -> Print Controls.



Figure 6-3. Mark Cine on Print Control

Table 6-2: Mark Cine

Preset Parameter	Description
Enable Mark Cine Control	Lets you mark where you want the CINE Loop to start (prospective CINE).
Preview Loop Longer than...(s)	When selected, allows you to review cine loops before storage for loops longer than selected time frame (in seconds).

2. Press **Save**.

### How to use

1. Press **Mark Cine** to specify the starting point for loop storing or cine review.  
When you press **Mark Cine**, the current image frame is noted as a start frame.
2. Press the appropriate print key while continuing to live scan to store the cine loop.

**NOTE:** *The Mark CINE control on the Trackball key is available while live scanning in non-timeline modes (B-Mode, B-Flow and Color Flow Mode).*

**NOTE:** *Selecting Mark CINE when a Mark CINE already exists causes the new Mark CINE to replace the previous one.*

**NOTE:** *Changing modes or other actions that flush CINE memory causes the Mark CINE to be removed and the image data will not be saved.*

**NOTE:** *A Print button can be configured to store a Single Image during Mark Cine, without stopping the Cine loop.*

### Preview

Loop Preview can be enabled independently for Time-Based Store, ECG-Based Store, and Mark CINE. This is useful for setting preview preferences based on the application.

*NOTE: The Contrast Time Span setting overrides the Time Span when in Contrast Mode.*

### Background Store

Live Clips are stored in the background to allow you to continue scanning. This works for both Raw Data and for DICOM Loops (with Direct Store On or Off). Image Ordering is preserved with Background Store.

The benefit of Background Store is that clips are stored with minimal interruption to live scanning.

*NOTE: Background Store IS NOT supported with V Nav, 4D, or with previously-acquired CINE Loops.*

*NOTE: The system may stop acquisition while storing if CINE memory is at least 80% full. Monitor CINE memory while storing CINE loops to ensure continuous live scanning.*

*NOTE: DICOM loops take significantly longer to store. Storage time may approach or exceed loop time. Allow extra space in CINE memory when saving DICOM loops.*

*NOTE: The CINE gauge turns purple to indicate the section of CINE memory that is being stored in the background.*

## Image Storage Hints



### HINTS

#### Setup Tips

- Print Button Setup is Application specific. When you access Application--> Print Controls, the current Application is the default Application.
- To apply the same Print Control Settings for all Applications, select All Applications as the preset on the Print Controls Menu. Be sure to re-enter values if the field is green.
- Print button setup for the file format and destinations are still configured via the Connectivity Menus.



### HINTS

#### Usage Tips

- If you select Mark CINE, the next time you press Print completes the Mark CINE Loop Store, independent of its configuration.
- The CINE gauge turns green when a Prospective CINE Clip is pending.
- You can cancel Prospective Store by pressing Freeze/Unfreeze or by changing Modes.

### Cine Capture

Selecting **Capture** searches through all images between the start frame and end frame and displays each peak or the highest velocity/tissue power. Adjust the start frame and end frame points to limit the image frames used in the process.

1. Display the CINE loop which is in memory or recalled from archive.

*NOTE: Cine Capture applies only to 2D images (B, B Flow, CF, PDI, Contrast, etc.).*

*NOTE: On 2D duplex modes (B/CF, B/PDI, etc.), Cine Capture is not applied to the background B-Mode image, even if the CF/PDI display is turned off.*

2. Run the cineloop.
3. Select **Capture** on the Touch Panel to display the captured image.

A character 'C' displays on the screen instead of the frame average level.

4. If necessary, save the captured image.
5. Press **Capture** again to turn Cine Capture off.

*NOTE: Cine Capture can be used on exported files by using the Save As function. You can save the still image (jpeg) and cine loop (avi) by using Save As.*

*NOTE: Cine Capture does not effect TIC Analysis.*

## Capture Recon.

### Description

Capture Recon. reconstructs small blood vessels in the CINE mode.

It is available in B-Flow, Contrast, CF, PDI, and B-Mode without CrossXBeam.

Capture Recon. shows smaller blood flow information than conventional B-Flow image, which is expected for the characterization of tumor, chronic liver disease, vascular abnormality, etc.

### Procedure

1. Scan B-Flow mode in the ordinary way, except:  
Sensitivity can be larger (20 (default) to 30 or more).
2. Acquire a short clip, then freeze.
  - Combination of Capture helps to imagine resulting image.
  - 3-dimensional sweep may be efficient to visualize many vessels.
3. Press **Capture Recon** on the CINE Touch Panel. Adjust threshold as necessary.
4. The order of the frames is rearranged by order of smaller artifact. The frame which has motion artifact is rejected. Move the Trackball or assigned rotary to review the image Frame by Frame.

**NOTE:** *While the Capture Recon, is activated, the color of CINE gauge turns pink.*

### Enhancement

**Enhancement** executes the enhancement process to cine capture images.

- NOTE:**
1. Display the cine capture image using **Capture**.  
*Enhancement applies only to Cine Capture images.*
  2. Select **Enhancement**. A character 'C' displays on the screen instead of the frame average level.
    - **Shade Fw/Shade Rv**  
Select Fw (Forward) that brings start frame or Rv (Reverse) that brings last frame of cine to the front. The system has two thresholds for the Shade process. Comparison will be made frame by frame after the thresholds have been met. If the two thresholds are satisfied, no comparison will be made with the rest of the frame.  
Using Shade Fw/RV, lower intensity echoes in the near frame will be masked by higher intensity echoes in the far frame. ShadeFw/Rv makes it possible to show lower intensity echoes in the near frame despite the fact that there may be a higher echo projection in the far frame. Therefore, the anteroposterior position of the blood vessel is clearly displayed.
    - **Enhance1/Enhance2/Enhance3**  
The part corresponding to the data of the selected frame is enhanced and superimposed on the entire cine capture images. This allows you to visualize the spatial relationships with the B-Mode image and the flow appearance.

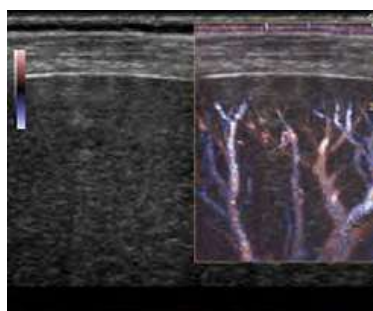

Figure 6-4. Enhancement image example

3. If necessary, save the enhanced image.

**NOTE:** *You can save the still image (JPEG) and cine loop (WMV) by using Save As.*

## Motion Correction

Understanding of the vascular structure is important, for example, with liver cancer. Though, the captured image distorts or blurs due to the patient's breathing. Motion correction compensates each frame and cancels the motion.

*NOTE: Motion Correction is activated only for B, CHI, Contrast and B-Flow.*

1. Displays the cine capture image using **Capture**.
2. Select **Motion Correction**. The system generates the captured image with motion correction.

The user can store the cine clip with the state of motion correction kept in the raw data.

The user can store the still image as the single frame DICOM image without the raw data.

# Image Zoom

## Overview

There are three kinds of zoom on the system: Pan Zoom, HD Zoom and Magnification Zoom.

- **HD Zoom** only acquires the image data within the ROI, increasing the density of the image in the ROI. Image adjustments can only be performed during live scanning.
- **Pan Zoom** magnifies the display of the data within the ROI without making any changes to the ultrasound image data acquired. The entire image is acquired and the ROI can be adjusted (moved and resized).
- **Magnification Zoom** magnifies the entire image on the screen (non-ROI zoom).

## Location of Zoom Control

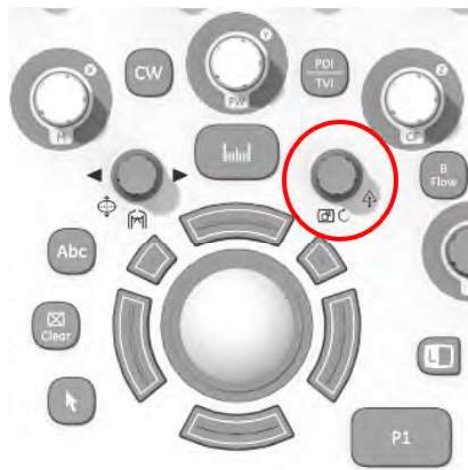

Figure 6-5. Zoom Control Knob



## HD Zoom

In HD Zoom, the Ultrasound line density and/or sampling frequency increases, resulting in higher resolution. HD Zoom can be performed on live images.

1. To activate HD Zoom, push the **Zoom** control knob inward while scanning live.

*NOTE: If already in Magnification Zoom, push the **Zoom** control knob inward to first turn off Magnification Zoom, then push again to activate HD Zoom.*

Press the top trackball key to select **Size** for change ROI size or **Pos** for change ROI position.

Use the trackball to position the zoom area over the desired portion of the image.

2. To exit HD Zoom, push the **Zoom** control knob inward again.

*NOTE: When HD Zoom is on and the image is live, the right trackball button toggles from HD Zoom to Pan Zoom.*

## Bioeffect

HD Zooming an image changes the frame rate which tends to change thermal indices. The position of the focal zones may also change which may cause the peak intensity to occur at a different location in the acoustic field. As a result, the MI (TI) may change.



Acoustic  
Output  
Hazard

Observe the output display for possible effects.

### Pan Zoom

Pan Zoom can be performed on a live, frozen, CINE or recalled raw data image.

1. To activate Pan Zoom (when frozen or in CINE) push the **Zoom** knob inward.

Press the top trackball key to select **Size** to change ROI size or **Pos** to change ROI position. Use the trackball to change the ROI size or position the zoom area over the desired portion of the image.

2. To deactivate Pan Zoom push the **Zoom** control knob inward again.

**NOTE:** *When Pan Zoom is on and the image is live, the right trackball button toggles from Pan Zoom to HD Zoom.*



Figure 6-6. Zoomed Image Example

1. Zoom Image
2. Reference Image: Reference image is the small un-zoomed image.
3. Zoom ROI: Zoom ROI indicates the region of the image to zoom.
4. Pos/Size: Use the top trackball key to change position and size of ROI.

## Magnification Zoom

Magnification Zoom magnifies the entire image on the screen (non-ROI zoom).

1. To activate Magnification Zoom, rotate the **Zoom** control knob clockwise.
2. There are three ways to deactivate Magnification Zoom:
  - Press Mag Zoom Rest on the trackball button.
  - Rotate the **Zoom** control value to 0.
  - Activate B-Mode (push the B-Mode button on the Front Panel).

## Panning in Magnification Zoom

While in Magnification Zoom, you can pan the image across the screen.

1. Press the Top Trackball button to highlight the Position Indicator “Pos.”



Figure 6-7. Position Indicator

2. Move the Trackball to pan the image across the screen.

# Split Screen

## Overview

LOGIQ Totus supports the following multiple image format:

- Dual (split the window area into 2 areas)
- Wide Dual (split the window area into 2 areas, but wider than the normal dual)
- Quad (split the window area into 4 small areas)  
This is useful, for example, when measuring AFI of OB.
- Simultaneous (Dual) (split the module window into 2 areas, with both panes live and active)

*NOTE:* Recalled dual/quad images can be edited.

## Dual screen

1. Press **L** to activate a dual screen. The single image is placed on the left side.

*NOTE:* When you activate the dual screen by pressing **L**, the single image is placed on the left side; when you activate by pressing **R**, the single image is placed on the right side.

2. Press **R**. The left side image is freezed and the image displays in the right side.
3. Press **Freeze** to freeze the image of the right side.
4. Press **Freeze** again to unfreeze the active image which has the gray bar under the image.  
To switch between active images, press **L** or **R**.
5. Press **B**-mode key to return to the single screen.

*NOTE:* To put a copy of the image on the opposite side when entering dual split screen, use the "When Entering Dual Image" preset found on Utility --> Application --> Settings preset page.

## Quad screen

1. Press and hold down **L** to activate a quad screen. The single image is placed on the upper left.
- NOTE: When you activate the dual screen by pressing L, the single image is placed on the left side; when you activate by pressing R, the single image is placed on the right side.*
2. Press **R**. The left side image is frozen and the image displays in the upper right.
  3. Press **Freeze**.
  4. Press **Freeze** again to unfreeze the image which has the gray bar under the image.  
Press **L** or **R** to move the gray bar to the image of the left side or the right side.
  5. Press **B-mode** key to return to the single screen.

## Simultaneous mode

While using CFM or PDI, press **L** and **R** keys simultaneously to display B and B+CFM, or B and B+PDI in real-time on the left and right side.

It is useful to observe the ROI in B-Mode.

*NOTE: Simultaneous mode can also be used within B-Mode to view with (Right) and without CrossXBeam (Left) if CrossXBeam is turned on.*

## Dual Caliper

In split screen, you can draw a caliper, area, ellipse, or spline trace on both the left and right image at the same time. Whichever side of the screen that you annotate is called the "Original" graphic. The copy is called the "Shadow" graphic.

This feature is available in the following modes:

- B-Mode:B-Mode
- Color Flow Mode:Color Flow Mode
- B-Mode:Color Flow Mode
- Simultaneous Mode.
- Contrast
- Elastography
- Volume Navigation

### Dual Caliper (continued)

**NOTE:** *Dual Caliper IS NOT available in B-Mode: B/PW Mode or in B-Mode:B/M Mode, or with different probes.*

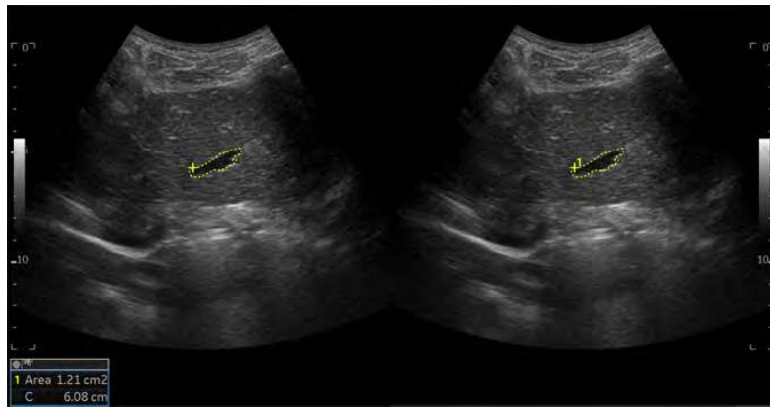

Figure 6-8. Original (Left), Shadow (Right)

**NOTE:** *Only the Original graphic contains the graphic numbering. In this way you can always distinguish between the Original and the Shadow graphic.*

**NOTE:** *You can only edit the Original graphic; however, when you do edit the Original graphic, the Shadow graphic is also edited at the same time.*

**NOTE:** *If you delete either graphic, both are deleted.*

**NOTE:** *When a measurement is selected without Dual B-Mode images or with different probe images, a warning message is displayed on the status bar and the selected measurement is cancelled.*

**NOTE:** *If the first point of the Original graphic is out of the Shadow image area, then a warning message displays on the status bar and the Shadow graphic is not drawn.*

**NOTE:** *The Trackball move area is limited to the narrow area of both images.*

**NOTE:** *You cannot take a measurement across dual images.*

**NOTE:** *The 2D Dual measurement tool cannot be copied.*

## Dual caliper for 2D image

2D Dual Caliper / 2D Dual Area / 2D Dual Ellipse / 2D Dual Spline Trace / 2D Dual Circle are not available through the factory default. To enable these measurements, add a new measurement using “2D Dual Caliper”, “2D Dual Area”, “2D Dual Ellipse”, “2D Dual Spline Trace” or “2D Dual Circle” tool in the Utility--> Measure--> M&A preset menu.

1. Select Blank from Add measurement.



Figure 6-9. Add Measurement

2. Select appropriate dual caliper tool from Tool drop-down menu.

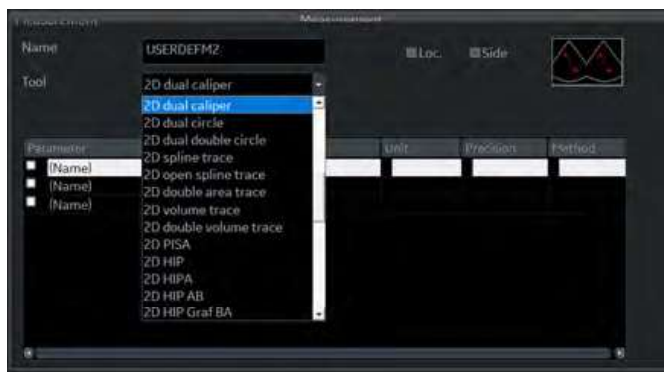

Figure 6-10. Drop-down menu

3. Type the measurement and parameter name as you like.
4. Add the created measurement to the Touch Panel.
5. Display the dual image and press **Measure**.
6. Select an added measurement from the Touch Panel to enable the appropriate measurement. A caliper displays.

**NOTE:** *When the measurement is selected without dual B images or with different probe images, a warning message displays on the status bar and the selected measurement is cancelled.*

### Dual caliper for 2D image (continued)

7. To position the caliper at the start point, move the **Trackball**. You can use both images as an original image.

*NOTE: If the first point of the original graphic is out of the shadow image area, then the warning message displays on the status bar and the shadow graphic is not drawn.*

8. To fix the start point, press **Set**. The caliper changes to an active caliper.

*NOTE: Only original graphic has graphic numbering to distinguish between original image and shadow image.*

*NOTE: The trackball move area is limited to the narrow area of both images.*

*NOTE: Only the original graphic can be edited. When the original graphic is edited, the shadow graphic is also updated.*

9. To complete the measurement, press **Set**. The system displays the measurement result in the Results Window.

### Dual Caliper for V Nav

1. Check **Dual Caliper on VNav** in Utility -> System -> System Measure. Only available distance, area, trace and angle measurement for V-Nav.

*NOTE: You cannot measure on the recalled image.*

*NOTE: Measure is available on the cine image shortly after freezing the image; however, you cannot measure on recalled images.*

2. Select the measurement via the Trackball key for a live scan image. Select the measurement from the Measurement Type table for Volume data.

*NOTE: Numbers are only displayed on the live scan image.*

3. If you want to measure live scan and volume data separately, select **Off** for Dual Caliper using the Touch Panel key.

*NOTE: After the Dual caliper measurement, graphics and measurement results are removed from the Volume dataset when you press **Measure**.*

*NOTE: If you use Zoom after the Dual caliper measurement, graphics and measurement results are removed.*



# Annotating an Image

## Introduction

The comment function provides the capability to type the comments of free text and/or insert the pre-defined comments from the comment library. It also provides the user with arrow markers to point to parts of the image.

Pressing the **Comment** key or any keys on the alphanumeric keyboard initiates the comment mode. This assigns the Trackball function to controlling the cursor and displays the comment library on the Touch Panel menu.

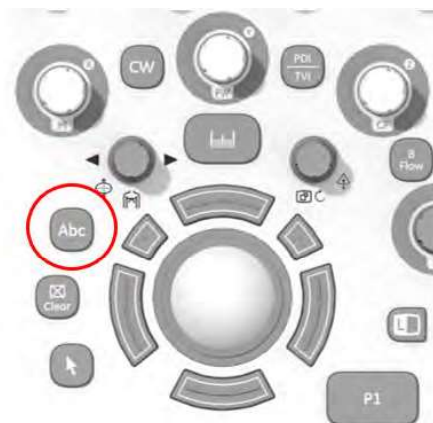

Figure 6-11. Comment Key on the Front Panel

In comment mode, text can be added by using the comment library or by typing from the alphanumeric keyboard.

Comments can be erased by powering down, when you press **Clear** or **New Patient**, or when preset via Utility -> Comments.

### Introduction (continued)

In addition, the display's home position can be changed (preferred comment area) for each display so that all subsequent comments begin in the same spot.

To return to the user specified position or factory default position, press the **F7 (Cursor Home)** key or the **Home** control on the Annotation Touch Panel (see Figure 6-13 on page 6-29).

To establish a new cursor home position, place the cursor in the desired position and press **Shift+F7** or press and hold the Home control on the Annotation Touch Panel.

Comment Mode is activated by pressing the **Comment** key. Comment Mode can also be automatically activated by typing from the alphanumeric keyboard.

*NOTE: In this case, the cursor begins at the same location where the comment mode was exited.*

After activating the comment mode, a vertical bar type cursor appears on the screen. Use the **Trackball** to move the cursor.

The factory default color for comments is yellow. The color selection can be changed to any of the colors available on the system. The choices are white, yellow, bright red, orange, etc.

*NOTE: The user cannot change the Font Family.*

To indicate a specific comment or text group is selected, the color turns to blue. Once the comment is set or fixed, the color returns to yellow or to the user selected color.

On the Touch Panel annotations have been color-coded for easy replacement or to easily add annotations. See Annotation Groupings below.

To delete comments by character, press the **Backspace** key.

To delete all comments and arrow marks, press the **Clear** key twice immediately after entering the comment mode.

To exit the Comment/Library Comment function, press the next function you wish to do.

To move by words or by text group, press the **Tab** key.

## Adding Comments to an Image

### Comment Retention

Comments from the B-Mode images are retained and carried over when switching to multi-image format or duplex mode.

The position of the comments is adjusted so that it is at the same relative position with respect to the display window in the new format as it was in the single image format.

**NOTE:** *Comments may not be retained when the image is switched to M-Mode image format depending on the preset.*

### Arrow Pointers

Arrow pointers can be used by activating the **F2 (Arrow)** key on the keyboard or by selecting the **Arrow** control on the Annotation Touch Panel (see Figure 6-13 on page 6-29). When the pointer comes up, it is a blue color, indicating it is active and can be moved.

- Move the pointer using the **Trackball** to any place on the screen. The pointer head direction can be controlled by movement of the Trackball or **Arrow Rotate** control.
- To readjust the length and thickness of the pointer, use the **Arrow Resize** rotary control. The default for the pointer size can be preset.
- Press **Set** to fix the place of the pointer and direction of the pointer head. The blue color turns to yellow (or the default color if changed).
- To delete the arrow marks, press the **Clear** key right after pressing the **F2 (Arrow)** key or press and hold the **Arrow** control on the Annotation Touch Panel.

**NOTE:** *To prevent the Trackball from changing the arrow angle, select the “Keep arrow angles” preset at Utility -> Annotation -> Comments.*

### Text Overlays

There are 2 layers of the text in comments, which can be selected by toggling the **F8 (Text1/Text2)** key on the keyboard or by selecting the **Comment Layer Switch** control on the Annotation Touch Panel (see Figure 6-12). Text1 is the default choice.



Figure 6-12. Comment Layer Switch Control

By using this function, users can perform a HIDE TEXT/SHOW TEXT, allowing the users to save or print an image without clearing the typed text.

You can specify to display text 1, text 2, or both. This allows you to have some comments that do not change during the exam while allowing you to change the other comment. Toggle the **F8** key or **Comment Layer Switch** control to cycle through the three Text 1/Text 2 states:

1. Text 1 Only -- Only Text 1 comments displayed and editable.
2. Text 2 Only -- Only Text 2 comments displayed and editable.
3. Text 1 and Text 2 -- Both displayed; only Text 2 comments editable. Only Text 2 comments erased by Clear key. Word Delete only deletes Text 2 comment. Both Text 1 and Text 2 comments erased with new patient, new exam, or probe change.

To preset the Text Overlay Sequence, go to **Utility -> Comment -> Comment** and select either **Text 1 and Both** or **Text 1 and Text 2 and Both**.

## **Text Overlays (continued)**

The font color for the Text1 and Text2 overlays can be set separately. Go to **Utility -> Comment -> Comment** and specify the text color for Text 1 Color and Text 2 Color.

*NOTE: If you check "Erase when image is unfrozen" in the Utility menu, only the editable text plane erases when you unfreeze the image.*

### Annotating an Image Using the Library

To reduce the amount of time spent annotating an image, store frequently-used comments in the Comment Library. As many as 6 libraries are available per study. One of the selected libraries is designated as the default and its entries shall be displayed on the Touch Panel when the comment mode is activated for that study.

Press **Comment** and move the comment cursor location using the **Trackball**.

Select the desired comment from the Touch Panel.

Each Touch Panel key can also be configured to hold a small list of up to 3 comments. The first word in the list is displayed on the Touch Panel and the others can be accessed by toggling the key or pop-up menu. To show the presence of a small list stored under a particular key, a small indicator (>) is placed on the key.

To program your system with specific comments, see 'Comments Libraries Presets' on *page 10-33* for more information.

## Annotating an Image by Comment Groupings

Comments can be grouped together for ease of annotating. For example, in the figure below there are blue, yellow, and green groups.



Figure 6-13. Annotation Touch Panel

When you select comments with a different color, the selected comment is added to the existing comment. In the example below, **Right** was selected from the blue group of comments. **Trans** was selected from the yellow group, so it was added to the first comment. **Bowel** was selected from the green group, so it was also added.

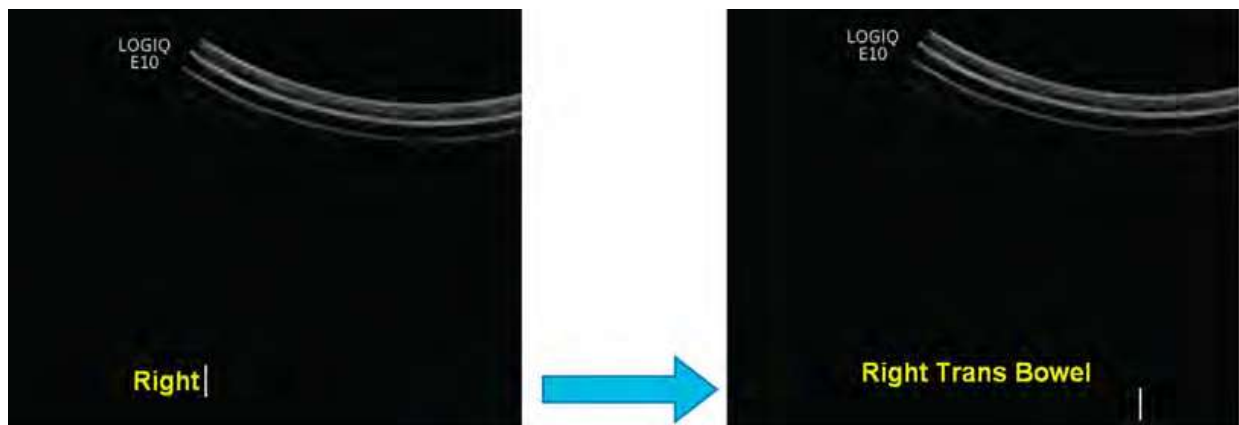

Figure 6-14. Added Comments (Different Color Groups)

### Annotating an Image by Comment Groupings (continued)

When you select comments with the same color, the selected comment is overwritten with the new comment. In the example below, **Bowel** was selected from the green group of comments, but then **Appendix** was selected from the same green group, so it replaced **Bowel**.

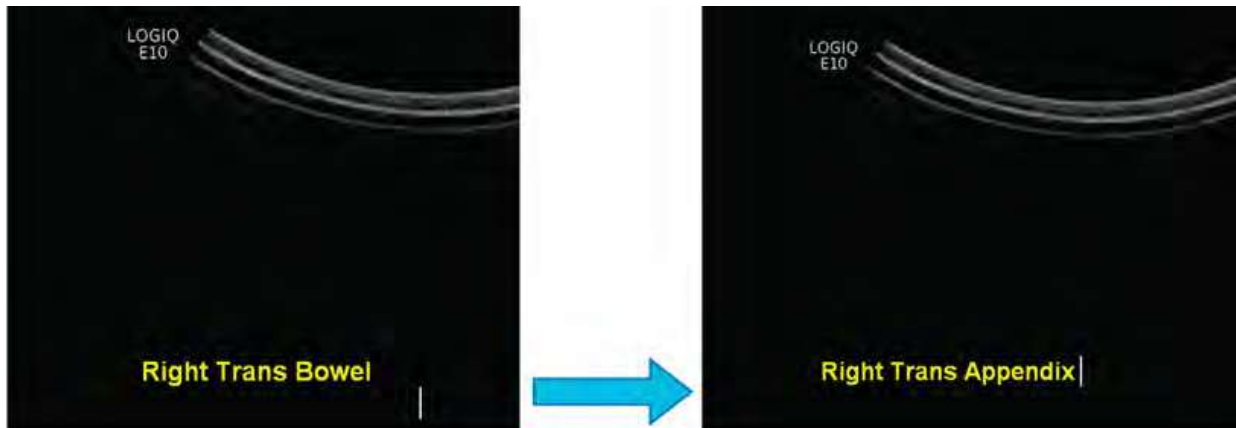

Figure 6-15. Replaced Annotation (Same Color Group)



**Annotating an Image by Comment Groupings (continued)**

You can configure these Comment color groupings via Utility--> Comments--> Libraries (up to 5 groups). Groups are organized by color. Position the cursor over the rectangular region to the left of the annotation to display the group drop-down selection menu, then select the color that matches your grouping.

*NOTE: You can also group annotations by dots (: and .). Dots are for color blindness recognition in groupings.*

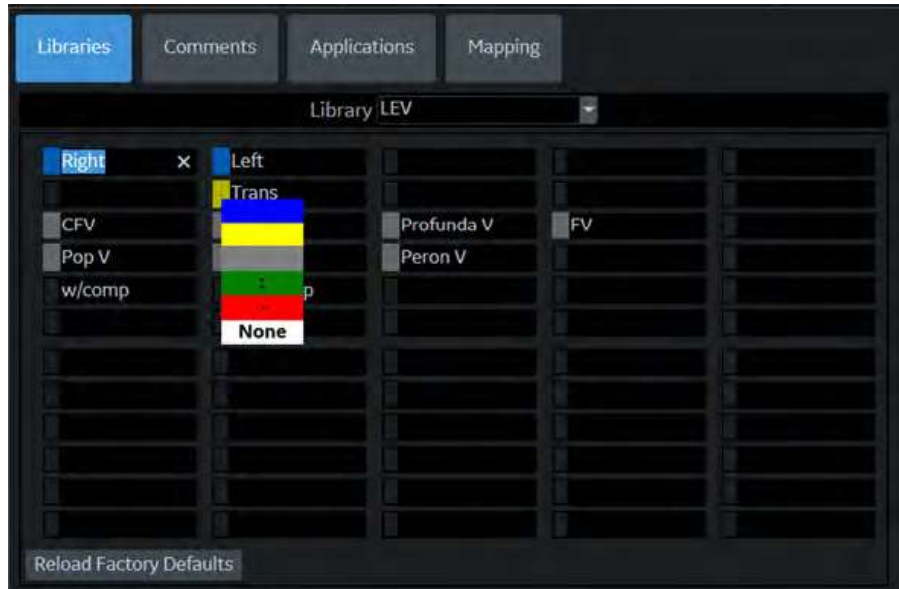

Figure 6-16. Tagging a Group Color to an Annotation

The configured comments are displayed on the Touch Panel.



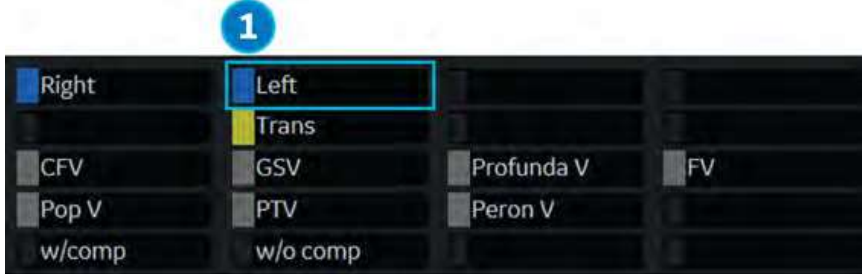

Figure 6-17. Color-Tagged Annotation Touch Panel

**Rearranging Touch Panel Comments**

You can easily move comments to a new location by selecting the annotation and moving it to the new, empty location.

**NOTE:** *You cannot move a comment to a location with a comment. The new location must be empty.*

Table 6-3: Moving Touch Panel Annotations

Step	Example
<p>1. Position the cursor over the annotation you want to move. In the example, we are going to move “Left” to a cell to the right.</p>	
<p>2. Hold and drag the “Left” annotation to the new cell; in this case the empty cell to the right.</p>	
<p>3. Release the cursor when you have the annotation positioned in the new cell location. Then Save and Exit the Utility Page.</p>	

## Annotating an Image with Typed Words

- Press **Comment** and type the comments where the cursor is currently located (the display's home position) and use the **Trackball** to further place the comment cursor in the desired location.
- Press **Enter** to move to the next line.

**NOTE:** *Comments wrap to the next line when they are within one character of the right margin if Word Wrapping is selected in the Text Boundary preset. See 'Comments Libraries/Comments Preset Menu' on page 10-36 for more information.*

The word wrap starts one line below the start of that comment.

Comments appear on all prints, photos, DVR or CINE loops.

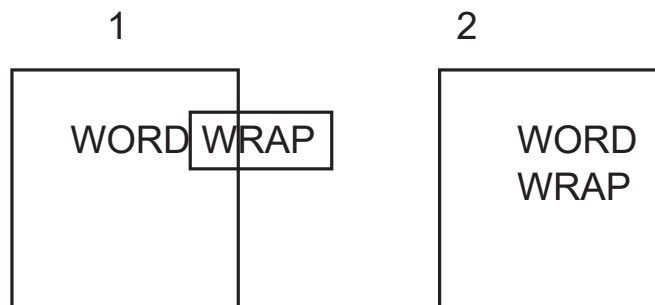

Figure 6-18. Next Line Word Wrap

1. Before

2. After

If the cursor appears at the right edge of the lowest line, or a word cannot be completed in the lower right corner, word wrap cannot be executed.

**NOTE:** *The same word wrap principles apply for library scripts as typed comments.*

### Moving Text

You have the ability to move comments already on the screen and place them in different locations.

- Place the cursor on the desired text or text group and press **Set**.
- The selected text color turns to green.
- Use the **Trackball** to move the selected text and press **Set**.

### Editing While Annotating

Backspace over any error(s) made. Blank spaces take the place of the letter(s) that were there. Continue typing the comment after backspacing over all incorrect letters.

To delete previous character(s):

- Press **Backspace** as many times as necessary to make the deletion.
- Once all texts within the selected text group are deleted, then the cursor will find another text group to delete to the upper left direction.
- If there is no more text to delete, the cursor will be located at home position.
- To delete all comments and arrow marks, press the **Clear** key twice immediately after entering the comment mode.

To move through the text a word at a time:

- Press **Tab** to move to the right by text group (Preset Keyboard Tab = Word)

*NOTE: Press Shift + Tab to move to the left.*

To activate the last text group typed or selected from the Library:

- Press **F9 (Grab Word)** key. The selected comment will be highlighted.
- To increase/decrease the area of the highlighted selection use HIGHLIGHT rotary.

*NOTE: Once the text is highlighted, typing comments or choosing them from the library replaces the highlighted text.*

*NOTE: To select all text groups, Press Shift + F9 (Grab Word) key.*

To cancel the last action:

- Press **Undo** key.

## Body Patterns

An additional way to annotate the image display is with body patterns. Body patterns are a simple graphic of a portion of the anatomy that is frequently scanned. The body pattern and probe marker can serve as a reference for a patient and probe positioning when images are archived or scanned.

1. Press **Bodypattern/Ellipse**. Body patterns specific to the current application are displayed.

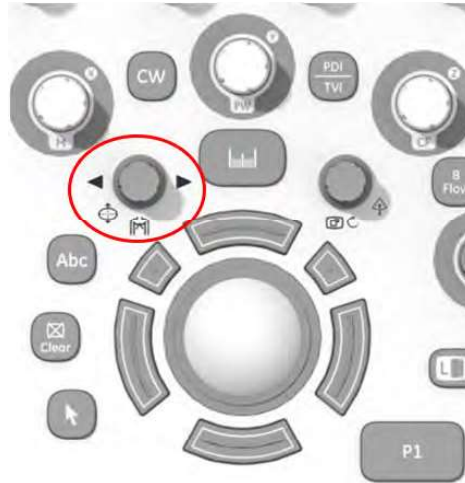

Figure 6-19. Body Pattern/Ellipse Control

2. Touch the body pattern to insert. The selected body pattern with a probe marker is displayed on the scanning screen.
3. Using the trackball, adjust the position of the probe marker.
4. Rotate **Body Pattern/Ellipse** to set the probe marker orientation.
5. To move the body pattern:
  - Press **Move Pattern**.
  - Move the bodymark to a new location with the trackball.
  - Press **Set** to anchor the bodypattern to the new location.
6. Press **Set** on the keyboard or **Scan** on the Touch Panel to exit without erasing the body pattern.
7. To clear the body pattern, press the **Body Pattern/Ellipse** control to activate body patterns and then press the **Clear** key.

The body pattern packages may be customized to accommodate user preference. Up to 30 individual body patterns in the packages can be changed. See 'Body Pattern Libraries/Applications Preset Menu' on *page 10-45* for more information.

## Body Patterns (continued)

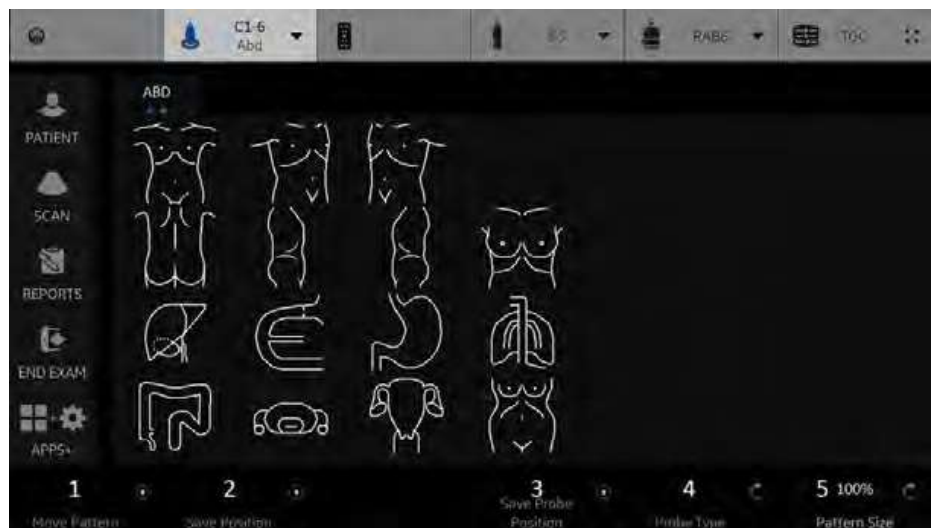

Figure 6-20. Touch Panel displays of Body Pattern - example

Table 6-4: Control Touch Panel

No.	Function	Description
1.	Move Pattern	Each Touch panel key can also be configured to hold a small list of up to 3 comments. The first word in the list is displayed on the Touch Panel and the others can be accessed by toggling the key. To program your system with specific comments, see 'Creating a small list' on page 10-37 for more information.
2.	Save Position	Move the body pattern to the desired location and press the <b>Save Position</b> . Current position of Body Pattern is saved as a Home Position of current display format. Hold down <b>Save Position</b> to reset the home position to factory default.
3.	Save Probe Position	Rotate the arrow. You can also rotate the arrow by Trackball.
4.	Probe Type	The probe mark type is selectable by rotating the <b>Probe Type</b> control on the Touch Panel. There are different choices available with one being a blank selection.
5.	Pattern Size	Rotate the rotary. You can adjust the size of the body pattern..

To select the active side in dual B-Mode, use the **Active Side** rotary control at the bottom of the Touch Panel.

You can use the **Zoom** control to select the body pattern. If you want to assign the select function to the Zoom control, see See 'Body Pattern Libraries/Libraries Preset Menu' on page 10-42 for more information..

## Notes for Body Pattern (Probe mark)

- Probe Type is the type of probe mark displayed on the body pattern. It can be saved only for each body pattern on the Touch Panel while body pattern is activated, but not in the Utility preset menu. Therefore, Probe Type cannot be saved as an Application or System Preset.

To save the Probe Type,

- a. Activate the **Body Pattern**.
- b. Select a Body Pattern on the Touch Panel.
- c. Select a type of probe mark with the **Probe Type** Touch Panel key.
- d. Place the probe mark at the proper location.
- e. Select the **Save Probe Position** Touch Panel key.

*NOTE: "Save Probe Position" saves both the Probe Mark position and Probe Type.*

- When a Body Pattern is selected and no Probe Mark has been saved on it, the latest used Probe Mark is carried over to the Body Pattern.

### Notes for Body Pattern (Probe mark) (continued)

- Check the Body Pattern on the Touch Panel if the Probe Mark does not appear on the monitor.

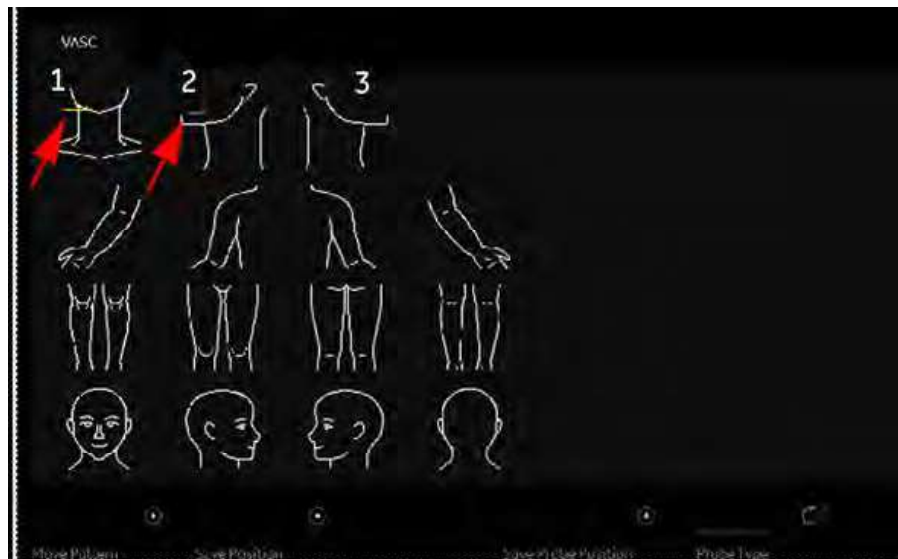

Figure 6-21. Body Pattern Touch Panel

1. When the Probe Mark is saved for the Body Pattern, the Probe Mark is displayed in yellow on the Touch Panel and should also be shown on the monitor.
2. When the Probe Mark is saved with "Probe Type - None", the Probe Mark is displayed in gray on the Touch Panel and is not shown on the monitor. Reselect an appropriate Probe Type and save as necessary.
3. When the Probe Mark is not saved, no Probe Mark is displayed either on the Touch Panel or the monitor. Select an appropriate Probe Type and save as necessary.



## Body Patterns (continued)

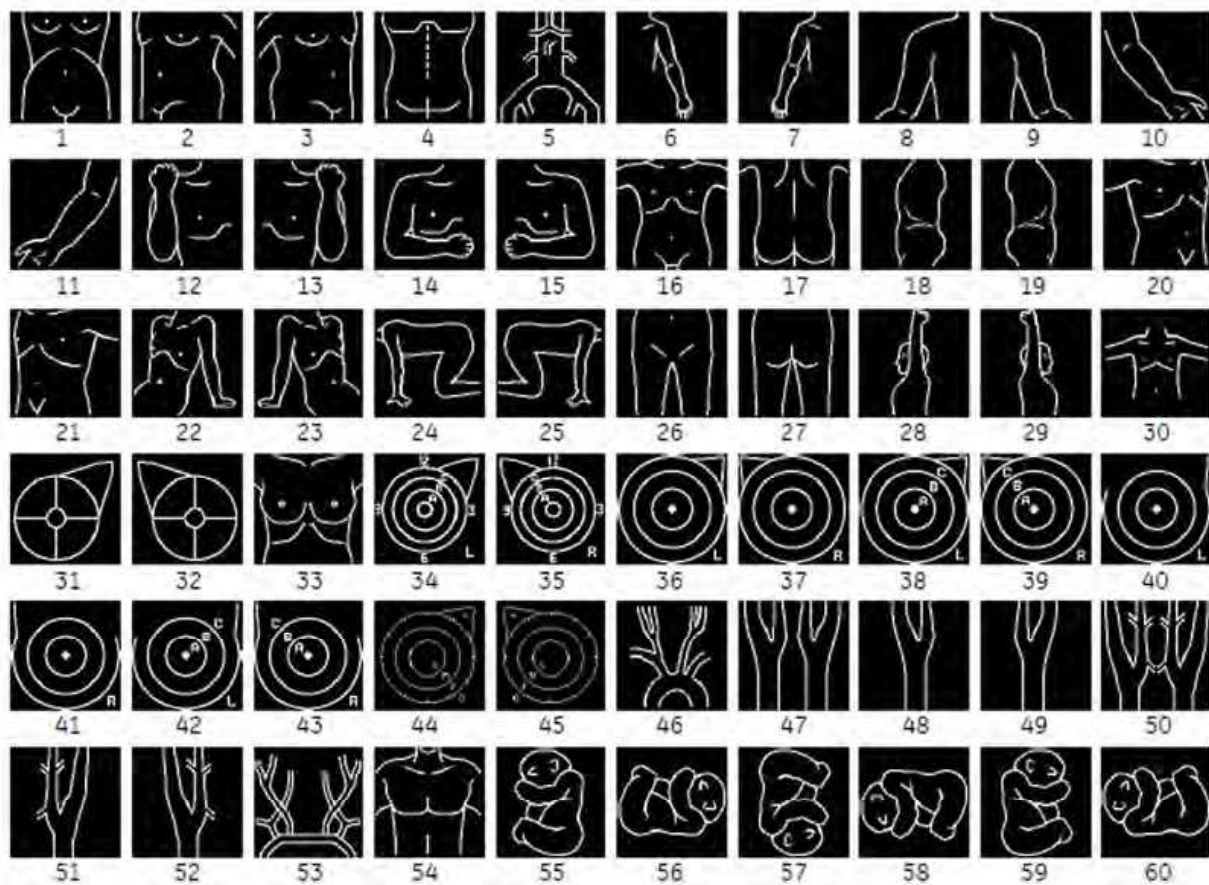

Figure 6-22. Body Patterns Available

- |            |                |                 |                  |
|------------|----------------|-----------------|------------------|
| 1. abdo 1  | 16. body 1     | 31. breast 1    | 46. carotid 1    |
| 2. abdo 2  | 17. body 2     | 32. breast 2    | 47. carotid 2    |
| 3. abdo 3  | 18. body 3     | 33. breast 3    | 48. carotid 3-Lt |
| 4. abdo 4  | 19. body 4     | 34. breast 4-Lt | 49. carotid 3-Rt |
| 5. aorta   | 20. body 5     | 35. breast 4-Rt | 50. carotid 4    |
| 6. arm 1   | 21. body 6     | 36. breast 5-Lt | 51. carotid 4-Lt |
| 7. arm 2   | 22. body 7-Lt  | 37. breast 5-Rt | 52. carotid 4-Rt |
| 8. arm 3   | 23. body 7-Rt  | 38. breast 6-Lt | 53. carotid 5    |
| 9. arm 4   | 24. body 8-Lt  | 39. breast 6-Rt | 54. chest 1      |
| 10. arm 5  | 25. body 8-Rt  | 40. breast 7-Lt | 55. fetus 1      |
| 11. arm 6  | 26. body 9     | 41. breast 7-Rt | 56. fetus 2      |
| 12. arm 7  | 27. body 10    | 42. breast 8-Lt | 57. fetus 3      |
| 13. arm 8  | 28. body 11-Lt | 43. breast 8-Rt | 58. fetus 4      |
| 14. arm 9  | 29. body 11-Rt | 44. breast 9-Lt | 59. fetus 5      |
| 15. arm 10 | 30. body 12    | 45. breast 9-Rt | 60. fetus 6      |

Body Patterns (continued)

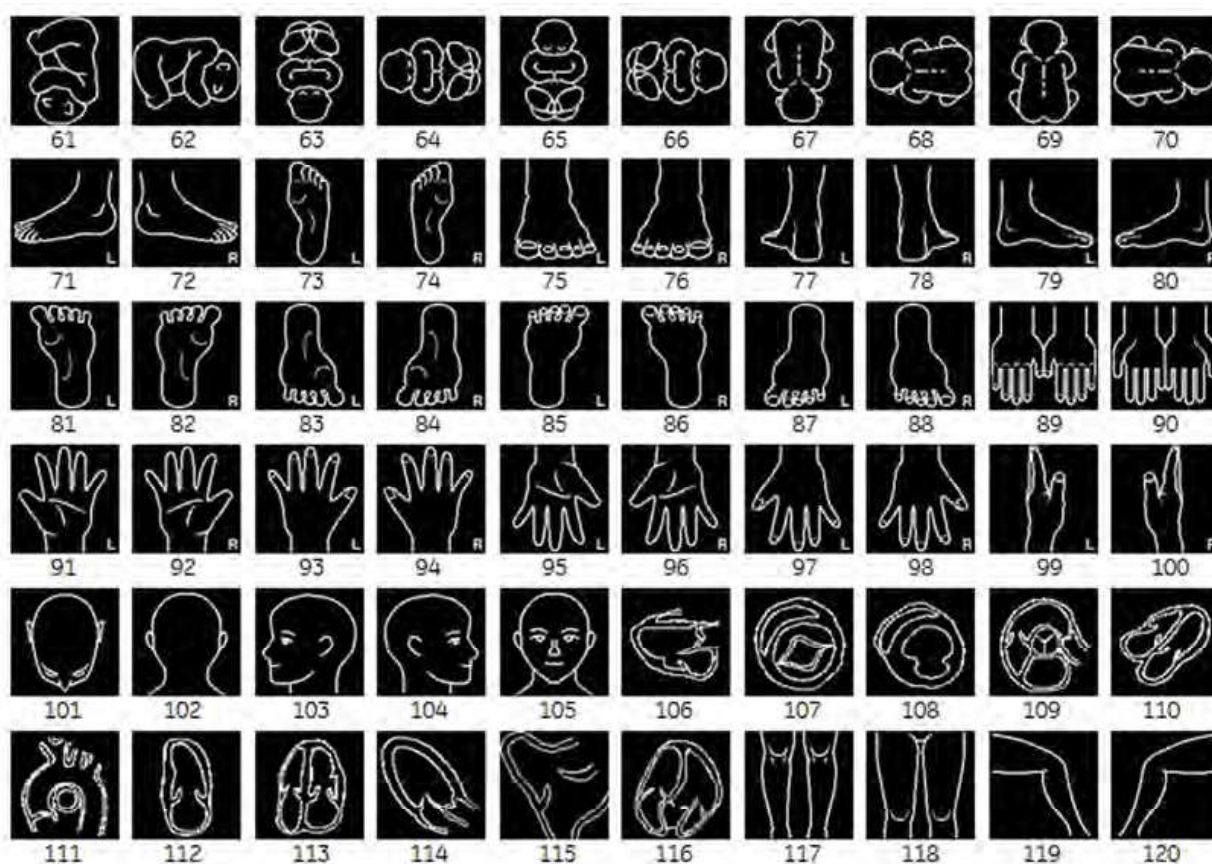

Figure 6-23. Body Patterns Available (continued)

- |               |               |                |               |
|---------------|---------------|----------------|---------------|
| 61. fetus 7   | 76. foot 3-Rt | 91. hand 3-Lt  | 106. heart 1  |
| 62. fetus 8   | 77. foot 4-Lt | 92. hand 3-Rt  | 107. heart 2  |
| 63. fetus 9   | 78. foot 4-Rt | 93. hand 4-Lt  | 108. heart 3  |
| 64. fetus 10  | 79. foot 5-Lt | 94. hand 4-Rt  | 109. heart 4  |
| 65. fetus 11  | 80. foot 5-Rt | 95. hand 5-Lt  | 110. heart 5  |
| 66. fetus 12  | 81. foot 6-Lt | 96. hand 5-Rt  | 111. heart 6  |
| 67. fetus 13  | 82. foot 6-Rt | 97. hand 6-Lt  | 112. heart 7  |
| 68. fetus 14  | 83. foot 7-Lt | 98. hand 6-Rt  | 113. heart 8  |
| 69. fetus 15  | 84. foot 7-Rt | 99. hand 7-Lt  | 114. heart 9  |
| 70. fetus 16  | 85. foot 8-Lt | 100. hand 7-Rt | 115. heart 10 |
| 71. foot 1-Lt | 86. foot 8-Rt | 101. head 1    | 116. heart 11 |
| 72. foot 1-Rt | 87. foot 9-Lt | 102. head 2    | 117. legs 1   |
| 73. foot 2-Lt | 88. foot 9-Rt | 103. head 3    | 118. legs 2   |
| 74. foot 2-Rt | 89. hand 1    | 104. head 4    | 119. legs 3   |
| 75. foot 3-Lt | 90. hand 2    | 105. head 5    | 120. legs 4   |

## Body Patterns (continued)

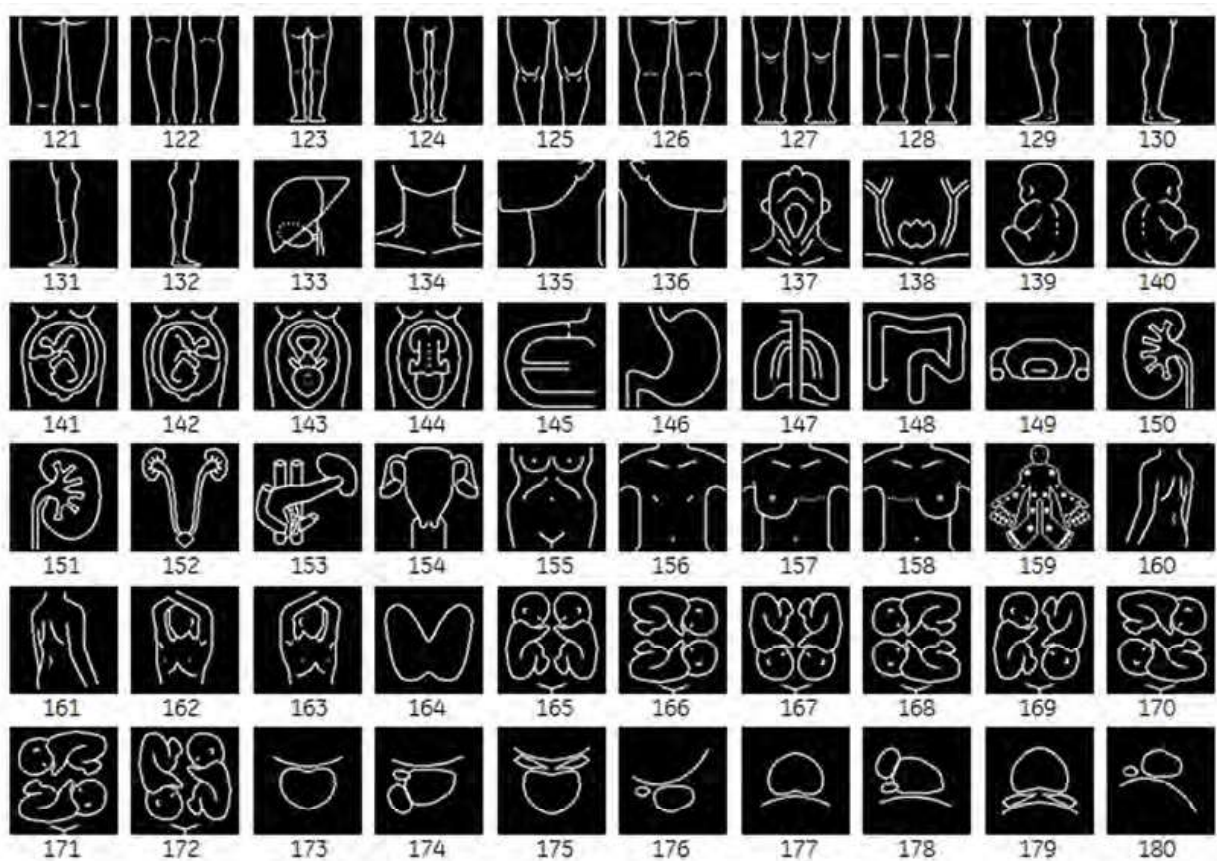

Figure 6-24. Body Patterns Available (continued)

121. legs 5	136. neck 3	151. organ 7	166. twin 2
122. legs 6	137. neck 4	152. organ 8	167. twin 3
123. legs 7	138. neck 5	153. organ 9	168. twin 4
124. legs 8	139. ob 1	154. pelvis 1	169. twin 5
125. legs 9	140. ob 2	155. pelvis 2	170. twin 6
126. legs 10	141. ob 3	156. post-breast-bilateral	171. twin 7
127. legs 11	142. ob 4	157. post-breast-Lt	172. twin 8
128. legs 12	143. ob 5	158. post-breast-Rt	173. uro 1
129. legs 13-a-Lt	144. ob 6	159. rheuma	174. uro 2
130. legs 13-a-Rt	145. organ 1	160. shoulder-back-Lt	175. uro 3
131. legs 13-Lt	146. organ 2	161. shoulder-back-Rt	176. uro 4
132. legs 13-Rt	147. organ 3	162. shoulder-front-Lt	177. uro 5
133. liver	148. organ 4	163. shoulder-front-Rt	178. uro 6
134. neck 1	149. organ 5	164. thyroid	179. uro 7
135. neck 2	150. organ 6	165. twin 1	180. uro 8

Body Patterns (continued)

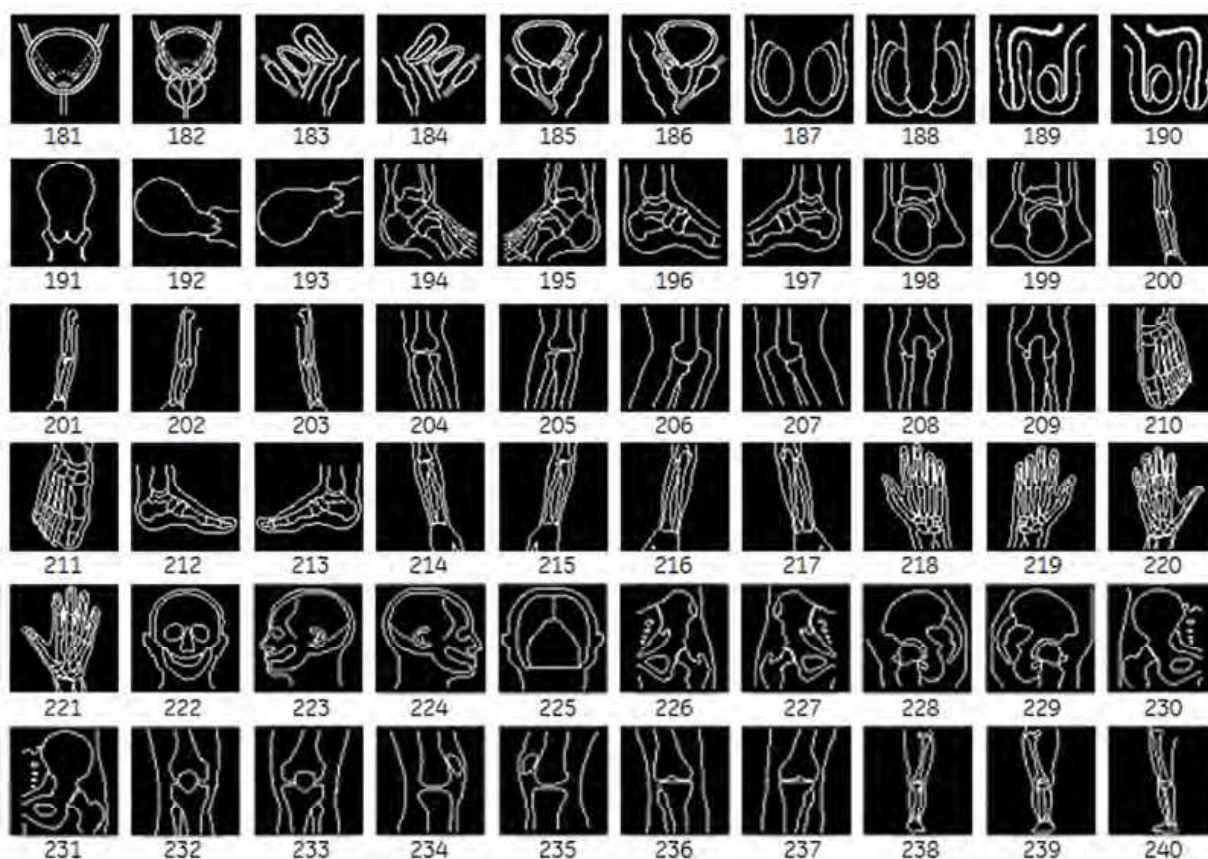

Figure 6-25. Body Patterns Available (continued)

- |                       |                    |                      |                   |
|-----------------------|--------------------|----------------------|-------------------|
| 181. uro 9 female     | 196. ankle lat-Lt  | 211. foot-Rt         | 226. hip-Lt       |
| 182. uro 9 male       | 197. ankle lat-Rt  | 212. foot lat-Lt     | 227. hip-Rt       |
| 183. uro 10 female-Lt | 198. ankle post-Lt | 213. foot lat-Rt     | 228. hip lat-Lt   |
| 184. uro 10 female-Rt | 199. ankle post-Rt | 214. forearm-Lt      | 229. hip lat-Rt   |
| 185. uro 10 male-Lt   | 200. arm-Lt        | 215. forearm-Rt      | 230. hip post-Lt  |
| 186. uro 10 male-Rt   | 201. arm-Rt        | 216. forearm post-Lt | 231. hip post-Rt  |
| 187. uro 11           | 202. arm post-Lt   | 217. forearm post-Rt | 232. knee-Lt      |
| 188. uro 12           | 203. arm post-Rt   | 218. hand-Lt         | 233. knee-Rt      |
| 189. uro 13-Lt        | 204. elbow-Lt      | 219. hand-Rt         | 234. knee lat-Lt  |
| 190. uro 13-Rt        | 205. elbow-Rt      | 220. hand post-Lt    | 235. knee lat-Rt  |
| 191. uterus 1         | 206. elbow lat-Lt  | 221. hand post-Rt    | 236. knee post-Lt |
| 192. uterus 2         | 207. elbow lat-Rt  | 222. head            | 237. knee post-Rt |
| 193. uterus 3         | 208. elbow post-Lt | 223. head lat-Lt     | 238. leg-Lt       |
| 194. ankle-Lt         | 209. elbow post-Rt | 224. head lat-Rt     | 239. leg-Rt       |
| 195. ankle-Rt         | 210. foot-Lt       | 225. head post       | 240. leg post-Lt  |

Body Patterns (continued)

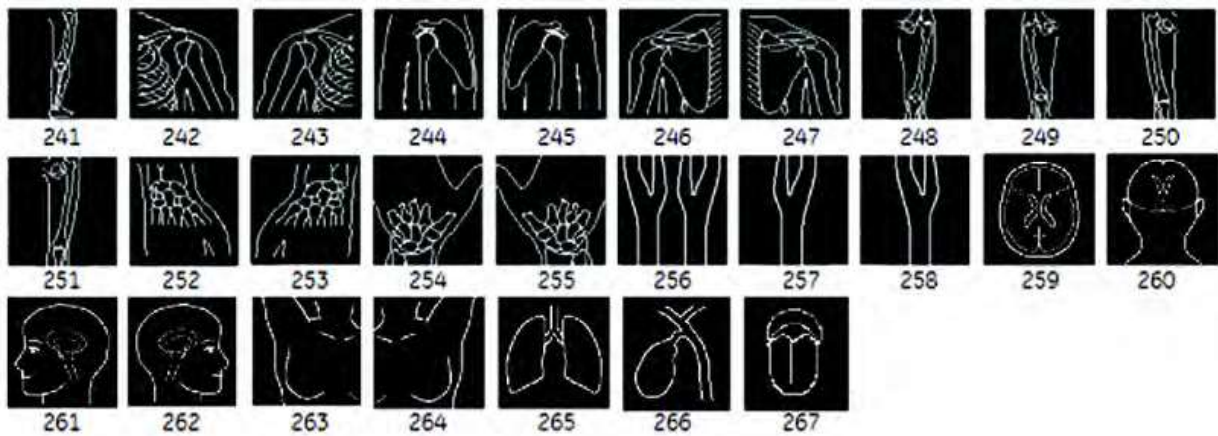

Figure 6-26. Body Patterns Available (continued)

- |                       |                    |                    |                  |
|-----------------------|--------------------|--------------------|------------------|
| 241. leg post-Rt      | 248. thigh-Lt      | 255. wrist post-Rt | 262. brain4      |
| 242. shoulder-Lt      | 249. thigh-Rt      | 256. new carotid 2 | 263. breastSA-Rt |
| 243. shoulder-Rt      | 250. thigh post-Lt | 257. carotid2-Lt   | 264. breastSA-Lt |
| 244. shoulder lat-Lt  | 251. thigh post-Rt | 258. carotid2-Rt   | 265. lung1       |
| 245. shoulder lat-Rt  | 252. wrist-Lt      | 259. brain1        | 266. organ10     |
| 246. shoulder post-Lt | 253. wrist-Rt      | 260. brain2        | 267. organ11     |
| 247. shoulder post-Rt | 254. wrist post-Lt | 261. brain3        |                  |

# Using the Fast Key

## Overview

A keyboard Fast Key is available to record and run a sequence of often-run keystrokes.

**NOTE:** *Ensure that you have a patient selected prior to running the Fast Key operation.*

## Create a Fast Key

1. Press the **F5** key. The “Do you want to create the Fast Key?” dialog displays. Select OK to continue.
2. Select a key to assign a Fast Key to (a-z, 0-9).

If you select a Front Panel control, a Touch Panel key or any key besides a-z or 0-9, a warning dialog displays and the procedure is cancelled.

**NOTE:** *Assign Fast Key Function to Key 0 - 9 in Utility -> System -> User Configurable Key before you create a Fast Key.*

**NOTE:** *There is no distinction between capital and small letters.*

**NOTE:** *The key code is the same in Russian and Greek (a-z, 0-9).*

3. If the selected key is already assigned to a Fast Key, a warning dialog displays.  
Select Yes to continue. The Fast Key file is overwritten.  
Select No to cancel the Fast Key setup.

4. Input the key sequence to be assigned.

**NOTE:** *It is impossible to save a power cycle sequence or any input from outside of the system.*

**NOTE:** *If a warning dialog displays due to the limitations of the number of key sequences, press F5 to finish and retry.*

5. Press the **F5** key to complete a Fast Key setup. The information dialog displays. Select OK.

## Start a Fast Key

1. Press the **F6** key to start a Fast Key. The message “Select the key which the Fast Key is assigned to” displays on the status bar.

*NOTE: The F6 key is ignored if another dialog displays on the system.*

*NOTE: If you press F5 after F6, the F6 function cancels and the F5 function is enabled.*

2. Press the key assigned to the Fast Key macro. The message “Fast Key playback is finished” displays on the status bar when the macro is finished.

To stop the Fast Key during the operation, press **F6**. The message “Fast Key playback is cancelled” displays on the status bar.

*NOTE: Select the running speed in the Run Fast Key Speed preset on Utility -> System -> General.*

## Backup and Restore the Fast Key

You can backup/restore the Fast Key via Utility -> System -> Backup/Restore.

To backup, select User Defined Configuration in the Backup section.

To restore, select User Defined Configuration in the Restore section.





---

## *Chapter 7*

# General Measurements and Calculations

*Describes how to perform general measurements and calculations.*

# Introduction

## Introduction

Measurements and calculations derived from ultrasound images are intended to supplement other clinical procedures available to the attending physician. The accuracy of measurements is not only determined by system accuracy, but also by the use of proper medical protocols by the user. When appropriate, be sure to note any protocols associated with a particular measurement or calculation. Formulas and databases used within the system software that are associated with specific investigators are so noted. Be sure to refer to the original article describing the investigator's recommended clinical procedures.



### WARNING

The system provides calculations (e.g. estimated fetal weight) and charts based on published scientific literature. The selection of the appropriate chart and clinical interpretation of calculations and charts is the sole responsibility of the user. The authorized user should consider proper indications for the use of a calculation or chart as described in the scientific literature. The diagnosis, decision for further examination, and medical treatment must be performed by qualified personnel following good clinical practice.

## Basic Operation

### Measure and Assign

1. Press **Measure** on the control panel.
2. Select the measurement tool via the upper trackball key.
3. Perform the measurement. Follow the instructions displayed on the message area at the bottom of the screen.
4. To assign a label, select the measurement in the Measurement result window and press **Set**.



Figure 7-1. Label menu

5. Select the required label from the menu. For example, if it is a distance measurement, the list includes all distance calculations for the current study.

or

Select **User Name** from the menu. The dialogue window displays.

Enter the appropriate name and select OK.



Figure 7-2. Enter Measurement Name

### List of general measurements

The following types of general measurements are available when you press **Measure** but do not choose a specific calculation. The type of measurement depends on the current scan mode.

After pressing **Measure**, rotate between various measurement types with the upper Trackball keys.

#### **B and CF Modes**

- Dist (Caliper)
- Trace
- Spline
- Intensity
- Open Trace
- Open Spline

*NOTE: You can preset the sequence of B and CF area measurements in the Measure Key Sequence (B/CF) preset in the Utility -> Measure -> Advanced screen. See the "M&A Advanced Preset" section for more information.*

#### **Doppler Mode**

- Velocity
- Trace
- Slope
- Time

#### **M-Mode**

- Caliper
- Time
- Slope

## **Assign and Measure**

1. Press **Measure** on the control panel.
2. Select the measurement on the Touch Panel.  
If you select the measurement folder, the sub menu tab is displayed. You can select and perform the measurement in the tab.  
If the folder is configured with auto-sequence measurement, the next measurement in the study is pre-selected. To skip a pre-selected measurement, select another measurement.
3. Perform the measurement. Follow the instructions displayed on the message area at the bottom of the screen.

## Measurement Controls

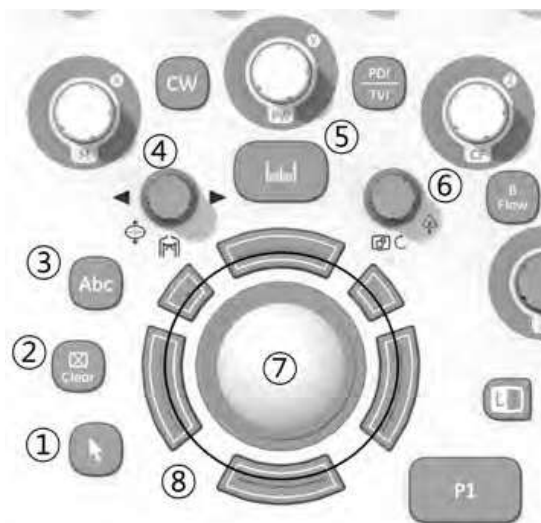

Figure 7-3. Measurement Controls on the Control panel

Table 7-1: Measurement controls

Control	Description
1. Cursor	<b>Pointer Key.</b> Select to display a pointer on the monitor.
2. Clear	During a measurement sequence, erases the measuring caliper and measurement data from the display. When not performing a measurement sequence, clears all calipers and measurements from the display. To remove all annotations/body markers/arrows, hold down the Clear button.
3. Annotation	Annotations can be added to measurements on the image.
4. Body Pattern	Body patterns can be added to measurements on the image.
5. Measure	Activates a measurement caliper and the calculation package associated with the currently selected preset.
6. Zoom Rotary	Zoom Rotary controls Pan Zoom, HD Zoom and Magnification Zoom. Pan Zoom magnifies the display of the data without making any changes to the ultrasound image data that is acquired. HD Zoom only acquires the image data within the ROI, and can only be performed during live scanning because of the acquisition adjustments that are done. When preset, you can adjust the Depth by moving the toggle up and down. If preset, you can scroll through the body patterns with the Zoom control. Magnification Zoom magnifies the entire image on the screen (non-ROI zoom).
7. Trackball	Moves the measurement calipers, selects the measurement on the Summary Window. Trackball also selects items on the Touch Panel with the Pointer and Set keys.
8. Trackball keys	The functionality of these keys changes (for example, Set, Change Measure, etc.) depending on the mode or action. Current functionality is displayed on the lower-right corner of the monitor.

## Touch Panel

### B/M/Doppler Mode Select Tab

The B, M, or Doppler mode select tab key allows the user to select measurements associated with a particular mode of active study.

The system provides a default mode selection.



Figure 7-4. B-Mode - Example

### Exam Calcs Tab

The Exam Calcs Tab is used for selecting calculations from other study in the selected Exam Category.

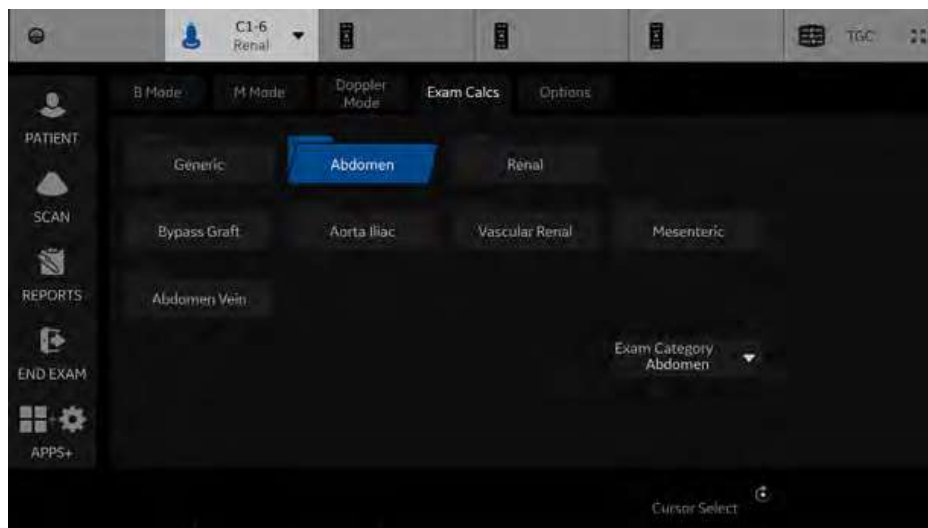

Figure 7-5. Exam Calcs Tab - example

#### Selecting a measurement in a different application

While scanning a patient, you may find that you want to measure an item that is not in the current application. In that case, Exam Category allows you to select other calculations without changing application.

1. Select **Exam Calcs** in the measurement mode.
2. Select **Exam Category**.
3. Select the exam category that has the calculation you want to make.
4. Select the study and the desired measurement.
5. After you complete the measurement, to return to the original application, repeat steps 1–4.

**NOTE:** *This measurement **DOES NOT** appear on the original application worksheet.*



## Options tab

The Options tab allows you to specify the following measurement and display options:

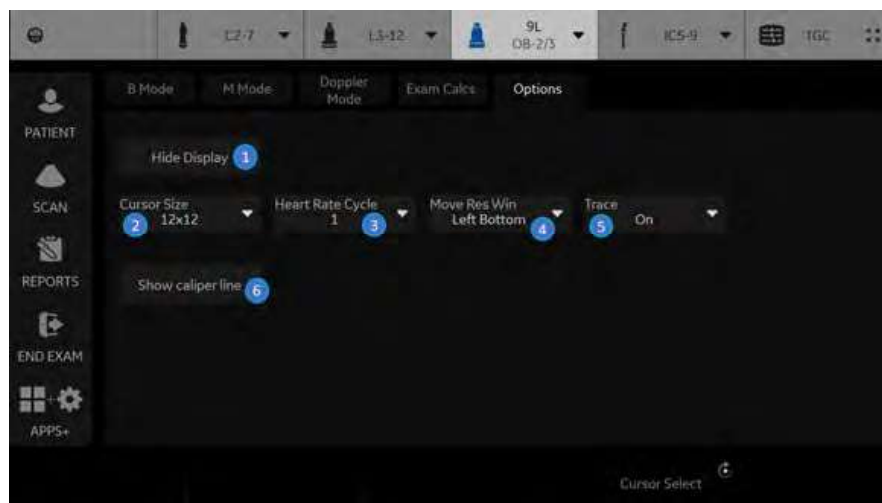

Figure 7-6. Measurement and Display Options - Example

Table 7-2: Measurement and Display Options

No.	Description
1.	Select <b>Hide Display</b> to hide the Results Window and Summary Window. Hide Display on the Touch Panel key is lit. To re-display them, select <b>Hide Display</b> again.
2.	The system displays the following choices: <ul style="list-style-type: none"> <li>• 12 x 12</li> <li>• 9 x 9</li> </ul>
3.	Select <b>Heart Rate Cycle</b> to change the number of cycles used in the calculation. The system displays a list of choices from 1 – 10.
4.	You may want to change where the Results Window is positioned on the monitor display. To change the location of the Results Window, select <b>Move Res Win</b> . The system displays a list of choices.
5.	Select Auto or Manual for Doppler Trace. <ul style="list-style-type: none"> <li>• Auto – the system traces the Doppler waveform from the begin time to the end time.</li> <li>• Manual – trace the waveform manually.</li> </ul>
6.	After you press Set to complete the measurement, the dotted line remains on the display if the Show Caliper Line is selected. If Show Caliper Line is not selected, the system erases the dotted line and only the measurement calipers with a number or symbol are displayed. Note: The Show Caliper Line on the Options tab takes precedence over the Cursor Line Display preset, found on the System -> System Measure screen.

### **Push/Rotary button area**

At the bottom of the Touch Panel, there are six (6) combination rotary dials/push buttons. The functionality of these rotaries changes, depending upon the mode, exam category, study, etc.

### **Side Rt/Lt**

The system has measurements for the patient's right and left side. To change side, push or rotate the Side rotary button.

### **Delete**

Delete active caliper.

### **Cursor select**

When there are several measurements on the display, to rotate through and activate previously fixed calipers, push or rotate the Cursor Select rotary button.

## Exam category/Study/Measurement

For each patient, the system organizes information by exam category, study, and measurement. The definitions of these terms are as follows:

- **Exam Category** – categories include the following:
  - Abdomen
  - Obstetrics
  - Gynecology
  - Cardiology
  - Vascular
  - Urology
  - Small Parts
  - Pediatrics
- **Study/Preset** – after you choose an exam category, the system allows you to select a study. For example, when you choose the Obstetrics exam category, you can choose one of the following studies:
  - Generic
  - OB-1
  - OB-2/3
  - OB-General
  - Fetal Heart
  - OB/GYN Vessel
- **Measurement** – the measurements and calculations needed to analyze an item of anatomy. For example, a femur length is a measurement. A measurement can include several pieces of measurement data. For example, to calculate the ovarian volume, you need to measure width, length, and height.

### General Instructions

#### General Guidelines

Any measurement can be repeated by selecting that measurement again from the Touch Panel.

The system retains all measurements, but the worksheet retains only the last six measurements of each type.

#### Measurement and calculation results

As you take measurements, each measurement is given a sequential number on the display and in the Results Window. The system can display nine measurements on the screen at one time.

Once the Results Window has nine measurements, if you make any further measurements, the system erases the first measurement and adds the new measurement ("first in, first out").

Measurement graphics are kept while in cine scroll. The measurement graphic is redisplayed on the frame where it is taken, if preset "Keep Graphics with Cine Scroll" on the Advanced M&A page.

#### Selecting a calculation

When you take measurements, you can select the calculation before you take the measurement or after you take it. For example, in Obstetrics, if you select the calculation before you take the measurement, the estimated fetal age is displayed as you take the measurement. If you select the calculation after you take the measurement, the estimated fetal age is displayed after you complete the measurement.

**NOTE:** *After you take a measurement, if you select a calculation and the measurement is not applicable for the calculation, then the system assumes you want to start the calculation. The system then uses the calculation for the next measurement.*

## General Instructions (continued)

### Erasing measurements

These actions erase measurements from the system's memory:



#### HINTS

- If you adjust the Trackball, unfreeze the image, or press Clear, the system erases all completed measurements and calculations on the display. Measurements and calculations, however, remain on the worksheets.
- If you select New Patient, the system erases all measurements and calculations on the display and clears the worksheets.
- If you make a new measurement that exceeds the maximum number of allowable measurements, the system erases the first (oldest) measurement and adds the new measurement.
- If the second caliper is active, to erase the second caliper and activate the first caliper, press Clear.

These actions you can take while performing measurements.



#### HINTS

- Before making measurements, to stop the acquisition of image data, press **Freeze**.
- For measurements such as distance, to make fine adjustments before completing the measurements, press the top Trackball key to toggle between active calipers.
- Before completing the measurement sequence, to erase the active measuring caliper and the current data measured, press **Clear**.
- After the sequence is complete, to erase all data that has been measured to this point, but not data entered on worksheet pages, press **Clear**.
- When there are several measurements on the display, to rotate through and activate previously fixed calipers, adjust the **Cursor Select** knob. After a cursor is activated, you can change the measurement.  
*NOTE: If you want to change a trace measurement, you must erase it and trace again.*
- To repeat any measurement, select that measurement again from the Touch Panel.

Calculation formulas are available in the *Advanced Reference Manual*.

## Measurement Cursor

While you are making a measurement, the measurement cursor is either active (open plus sign) or fixed (closed plus sign). An active cursor is green and a fixed cursor is yellow.

The system allows you to identify measurements by number or by unique symbol. The symbols are used in sequence as listed. The first symbol is used for the first measurement, the second symbol for the second measurement, and so on.



Figure 7-7. Fixed Caliper Symbols

Measurement graphics are kept while in cine scroll. The measurement graphic is redisplayed on the frame where it is taken, if preset on the Advanced M&A page.

## Cursor preset

You can preset the measurement cursor in Utility -> System -> System Measure.

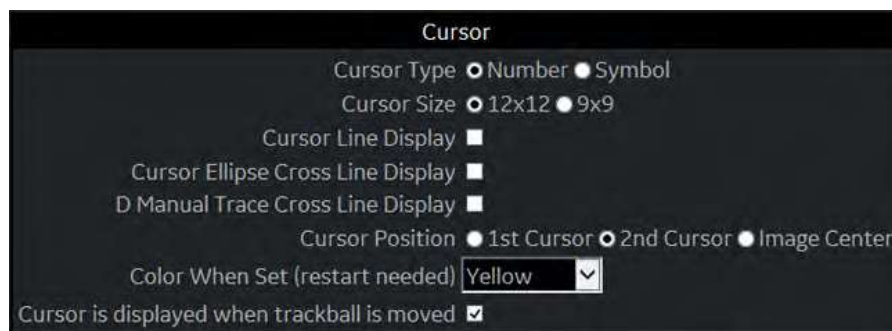

Figure 7-8. System/System Measure Preset Menu

Table 7-3: Cursor

Preset Parameter	Description
Cursor Type	Select whether to mark measurements with numbers or symbols.
Cursor Size	Specify 12x12 or 9x9.
Cursor Line Display	If selected, after you press Set to complete a measurement, the cursor line is displayed. If not selected, after you press Set to complete a measurement, only the cursor number or symbol is displayed.
Cursor Ellipse Cross Line Display	Check box to display the cross line in Ellipse.

Table 7-3: Cursor (Continued)

Preset Parameter	Description
D Manual Trace Cross Line Display	Check box to display the cross line with the caliper.
Cursor Position	Select 1st Cursor, 2nd Cursor, or Image Center.
Color When Set (reboot)	Select white, yellow, bright red, or orange.
Cursor is Displayed when Trackball is Moved	The active cursor does not display until you move the Trackball. This assumes the following presets are set: Repeat Measurement, Repeat, Default Measurement, and Cursor.

## Copy, move and paste measurement tools

You can copy, move and paste the measurement graphic.

**NOTE:** *This function is supported with trace, area trace, spline trace, volume trace, ellipse, 3-point ellipse, circle and intensity. The Double tools and Dual tools are not supported.*

### Copy and Paste

1. Measure the trace.
2. If present, clear the active caliper using the **Clear** key. Press the **Arrow** key to display the green arrow cursor on the screen. Move the cursor to the + mark of the measurement graphic. The selected graphic color changes from yellow to green.
3. Press **Set**. The pop-up menu displays. Select **Copy**.

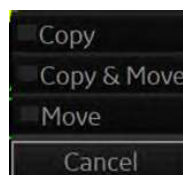

Figure 7-9. Copy and Move Menu

4. Press **Set** on the outer side of the measurement graphic. The pop-up menu displays.
5. Select **Paste**. The copied graphic displays on top of the original graphic in green. Move it to the desired position using the **Trackball** and press **Set** to fix the location.

**NOTE:** *If the copied graphic is bigger than the pasted area, "Paste" fails and "The copied graphic cannot be pasted to this area" message displays on the status bar.*

### Copy and Move

1. Measure the trace.
2. If present, clear the active caliper using the **Clear** key. Press the **Arrow** key to display the green arrow cursor on the screen. Move the cursor to the + mark of the measurement graphic. The selected graphic color changes from yellow to green.
3. Press **Set**. The pop-up menu displays. Select **Copy&Move**.
4. The copied graphic displays on top of the original graphic in green. Move it to the desired position using the **Trackball** and press **Set** to fix the location.

### Move

1. Measure the trace.
2. If present, clear the active caliper using the **Clear** key. Press the **Arrow** key to display the green arrow cursor on the screen. Move the cursor to the + mark of the measurement graphic. The selected graphic color changes from yellow to green.
3. Press **Set**. The pop-up menu displays. Select **Move**.
4. Move the selected graphic to the desired position using the **Trackball** and press **Set** to fix the location.

### Performing Measurements on Saved Images

You can perform measurements on recalled images. Select the image, then perform the measurement. If the image was not saved as a raw DICOM image, you need to calibrate the image prior to performing the measurement.

To calibrate the image,

1. Recall the image.
2. Press **Measure**. The Measurement Calibration Touch Panel appears.
3. Select the mode you need to be in to perform the measurement.
4. Press the appropriate mode key on the Touch Panel (**2D calib** for B-Mode, **MM calib** for M-Mode, or **Dop. calib** for Doppler mode). The specified mode calibration pop-up appears.



## Performing Measurements on Saved Images (continued)

5. The system prompts you, depending on the mode.

B-Mode:

- a. Place the first point of the caliper on the ruler. Press **Set**.
- b. Position the cursor at the 5 cm point on the ruler. Press **Set**.
- c. Type "5" into the 2D-Mode Calibration pop-up window. Press OK.

M-Mode or Doppler Mode:

- a. Place the cross on zero depth and minimum or zero time.
- b. Place the cross on maximum depth and time.
- c. Type the time (in seconds) and velocity (cm/sec) in the M-Mode/Doppler Mode calibration pop-up window.

# Generic Measurements

## Overview

Each exam category has a Generic study. The Generic studies provide you quick access to measurements such as volume, angle, A/B ratio, and % stenosis. The particular measurements available in each Generic study vary, depending on the exam category and the mode. This section describes generic measurements, organized by mode.

To access Generic studies:

1. On the Control Panel, press **Measure**.
2. On the Touch Panel, select **Exam Calcs**.
3. On the Touch Panel, select the **Generic** folder.

Calculation formulas are available in the *Advanced Reference Manual*.

## B-Mode Measurements

In B-Mode, the Generic study includes the following measurements:

- % Stenosis
- Volume
- Angle
- Velocity
- Stiffness
- V Ratio
- Stiff. Ratio
- A/B Ratio

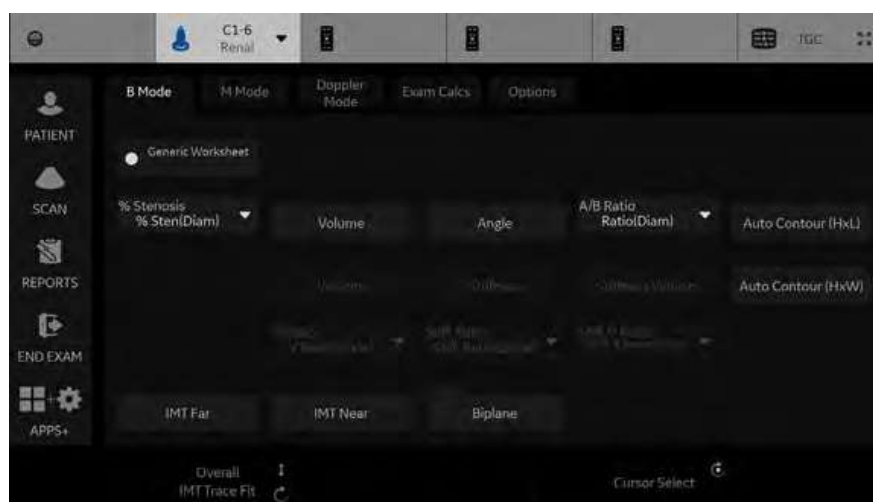

Figure 7-10. B-Mode Generic Study

**NOTE:** *The following instructions assume that you first scan the patient and then press **Freeze**.*

### % Stenosis

You can calculate % Stenosis by diameter or by area, depending on the mode.

**NOTE:** *The LOGIQ Totus automatically activates the % Stenosis with the default selection. If another method is preferred, select it from the Touch Panel.*

### Diameter

**NOTE:** *When you use diameter to calculate the %stenosis, always take the measurement from a cross-sectional view of the vessel.*

To calculate percent stenosis by diameter:

1. From the Generic Touch Panel, select **% Stenosis**.
2. Select **%sten(Diam)**.  
The system displays an active caliper.
3. Make a distance measurement of the inner area of the blood vessel.  
The system displays an active caliper for the second distance measurement.
4. Make a distance measurement of the outer area of the blood vessel.

The system displays each distance measurement and the % Stenosis in the Results Window.

For details on how to make a distance measurement, See 'Distance measurement' on page 7-39 for more information.

**NOTE:** *For the diameter calculation, do NOT take a distance measurement from a longitudinal view. This may lead to an inaccurate assessment of % stenosis.*

**% Stenosis (continued)****Area**

To calculate percent stenosis by area:

1. From the Generic Touch Panel, select **% Stenosis**.

2. Select **%sten(Area)**.

The system displays a caliper.

3. Make a trace measurement of the inner area of the blood vessel.

*NOTE:* To erase an open trace, move the **Trackball**.

4. Press **Set**.

The system displays a second caliper.

5. Make a trace measurement of the outer area of the blood vessel.

The system displays the two area measurements and percent stenosis in the Results Window.

**Ellipse + Area**

To calculate percent stenosis by ellipse and area:

1. From the Generic Touch Panel, select **% Sten[E+A]** folder.

2. Ellipse is selected by default.

The system displays a caliper.

*NOTE:* You can select the trace at this time.

3. Make an ellipse measurement of the inner area of the blood vessel.

4. Press **Set**.

The system displays a caliper.

5. Make a trace measurement of the outer area of the blood vessel.

The system displays the two area measurements and percent stenosis in the Results Window.

*NOTE:* **% Stenosis (E+A)** is not available through the factory default. To enable **%Stenosis (E+A)**, add “%Steno(E+A)” to the Measure & Study list on the Utility -> Measure -> M&A screen.

### Volume

The volume calculation can be made from any of the following measurements:

- One distance
- Two distances
- Three distances
- One ellipse
- One distance and one ellipse

For details on how to make a distance measurement, See 'Distance measurement' on *page 7-39 for more information*.

For details on how to make an ellipse measurement, See 'Circumference and area (ellipse) measurement' on *page 7-41 for more information*.

**NOTE:** *IMPORTANT!! If you want to make a volume calculation using one or two distances, you must select **Volume** BEFORE you make the measurements.*

**NOTE:** *If you select Fix Caliper by Print Key on the Utility --> System --> System Measure, the print key does not function like the Set key, but instead ends the measurement sequence and initiates the volume calculation based on the number of measurements taken so far.*

To make a volume calculation using one or two distances:

1. Select **Volume**.
2. Make one or two distance measurements.
3. Select **Volume**.

The system displays the distances and the volume in the Results Window.

**NOTE:** *Use the **Clear** key to erase the green caliper.*

## Volume (continued)

To make a volume calculation using three distances:

1. Make three distance measurements.

**NOTE:** *Three distances can be done in the dual format mode (side by side images). One measurement is usually made in the sagittal plane and two measurements in the axial plane. To use the dual format mode, press the **L** or **R** key on front panel.*

2. Select **Volume**.

The system displays the distances and the volume in the Results Window.

To make a volume calculation using one ellipse:

1. Make one ellipse measurement.
2. Select **Volume**.

The system displays the ellipse measurement and the volume in the Results Window.

To make a volume calculation using one ellipse and one distance:

1. Make one distance measurement and one ellipse measurement.
2. Select **Volume**.

The system displays the distance and ellipse measurement and the volume in the Results Window.



### HINTS

- Volumes are most accurate when measurements are taken in the sagittal and axial scan planes.
- To display sagittal and axial plane images simultaneously, use the side-by-side dual format option.

**NOTE:** *If you change the parameters or category during the volume measurement, please follow the procedure below before you restart the measurement.*

1. Check the number of each measurement in the summary window.
2. If the numbers are not all the same, it shows that you have the calculation which is not completed. Open the Worksheet and clear that calculation.

Volume (continued)

Table 7-4: Volume Calculations

Calc Name	Input Measurements
Volume (spherical)	One distance
Volume (prolate spheroidal)	Two distances, $d_1 > d_2$
Volume (spheroidal)	Three distances
Volume (prolate spheroidal)	One ellipse: (d1 major axis, d2 minor axis)
Volume (spheroidal)	One distance d1, and one ellipse (d2 major axis, d3 minor axis)

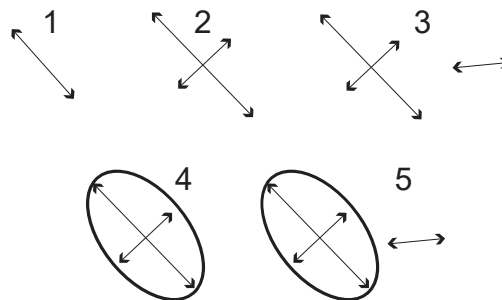

Figure 7-11. Volume Calculation Examples

1. One distance
2. Two distances
3. Three distances
4. One ellipse
5. One distance and one ellipse

Calculation formulas are available in the *Advanced Reference Manual*.



## Volume (continued)

### Post-assignment for General Volume

You can input a unique name for the general volume measurement. You can group the general volume measurements for each application.

1. Complete the volume measurement.
2. Move the caliper to the measurement result box (with green frame) and select **Set**.
3. The volume name menu appears. Select Name Volume.



Figure 7-12. Volume Name menu

4. The dialog box displays. Enter a new name or choose the existing name.



Figure 7-13. Volume Name Dialog box

**NOTE:** *The factory default volume name cannot be changed (for example, Renal Volume).*

### Angle

This function measures the angle between two intersecting planes.

1. From the Generic Touch Panel, select **Angle**.  
The system displays an active caliper.
2. To position the caliper at the start point, move the **Trackball**.
3. To fix the position of the first caliper, press **Set**.  
The system displays a second active caliper.
4. To position the second caliper at the apex of the angle, move the **Trackball**.
5. To fix the position of the second caliper, press **Set**.  
The system displays a third active caliper.
6. To position the third caliper, move the **Trackball**.
7. To complete the angle measurement, press **Set**.  
The system displays the angle in the Results Window.

**NOTE:** *To rotate through and activate previously fixed calipers, adjust the **Cursor Select** control.*

## A/B Ratio

In B-Mode, you can calculate A/B ratio by diameter or by area.

**NOTE:** *The LOGIQ Totus automatically activates the A/B Ratio with the default selection. If another method is preferred, select it from the Touch Panel.*

### Diameter

1. From the Generic Touch Panel, select **A/B Ratio**.
2. Select **ratio(Diam)**.  
The system displays an active caliper.
3. Make a distance measurement of the first diameter.  
The system displays an active caliper for the second distance measurement.
4. Make a distance measurement of the second diameter.  
The system displays each distance measurement and the A/B ratio in the Results Window.

**NOTE:** *The first distance is the A diameter. The second distance is the B diameter.*

For details on how to make a distance measurement, See 'Distance measurement' on page 7-39 for more information.

### Area

To calculate A/B ratio by area:

1. From the Generic Touch Panel, select **A/B Ratio**.
2. Select **ratio(Area)**.  
The system displays a caliper.
3. Make a trace measurement of the A area.  
**NOTE:** *To erase an open trace, move the **Trackball**.*  
The system displays a second caliper.
4. Make a trace measurement of the B area.  
The system displays the two area measurements and the A/B ratio in the Results Window.

For details on how to make a trace measurement, See 'Circumference and area (trace) measurement' on page 7-42 for more information.

### Dual Caliper

If “Dual Caliper on VNav and Simultaneous” is checked in Utility--> System--> System Measure menu, then when you enter simultaneous view, there is a “Dual Caliper: On/Off” setting on the Touch Panel. If the setting is on, dual caliper is enabled in simultaneous view.

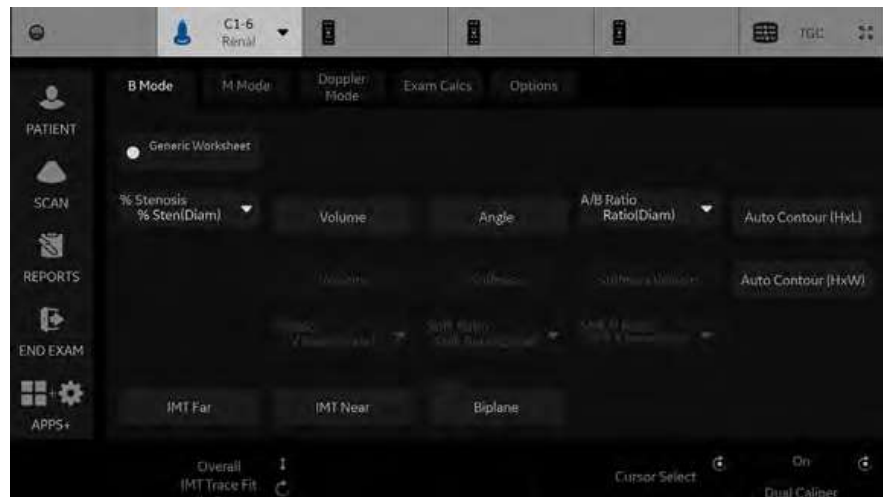

Figure 7-14. Dual Caliper

### Velocity and Stiffness Ratios

If set to display via configuration settings, these two measurements appear. Refer to Elastography Option documentation.

## M-Mode Measurements

In M-Mode, the Generic study includes the following measurements:

- % Stenosis
- A/B Ratio
- HR (Heart Rate)

### % Stenosis

See ‘% Stenosis’ on page 7-20 for more information.

### A/B Ratio

In M-Mode you can measure A/B ratio by diameter, time, or velocity.

*NOTE: The LOGIQ Totus automatically activates the A/B Ratio with the default selection. If another method is preferred, select it from the Touch Panel.*

### Diameter

See ‘Diameter’ on page 7-27 for more information.

### Time

To calculate A/B ratio by time:

1. Select **A/B**.
2. Select **ratio(Time)**.  
The system displays an active caliper.
3. To position the caliper at the A point, move the **Trackball**.
4. To fix the measure point, press **Set**.  
The system displays a second active caliper.
5. To position the second caliper at the B point, move the **Trackball**.
6. To complete the measurement, press **Set**.

The system displays the two time measurements and A/B ratio in the Results Window.

### A/B Ratio (continued)

#### Velocity

To calculate AB ratio by velocity:

1. Select **A/B**.
2. Select **ratio(Velocity)**.  
The system displays an active caliper with vertical and horizontal dotted lines.
3. To position the caliper at the A velocity, move the **Trackball**.
4. To fix the measure point, press **Set**.  
The system displays a second active caliper.
5. To position the second caliper at the B velocity, move the **Trackball**.
6. To complete the measurement, press **Set**.  
The system displays the two velocity measurements and the A/B ratio in the Results Window.

## Heart Rate

To calculate the heart rate from M-Mode:

1. Obtain an image and press Measure. Select **HR**.  
The system displays an active caliper.
2. To position the caliper at a recognizable point in the first cycle, move the **Trackball**.
3. To fix the first caliper, press **Set**.  
The system displays a second active caliper.
4. To position the caliper at the identical point in the next cycle (depending on preset), you need to move the **Trackball**.

**NOTE:** *In the message bar at the bottom of the display, the system indicates the number of cycles you should measure.*

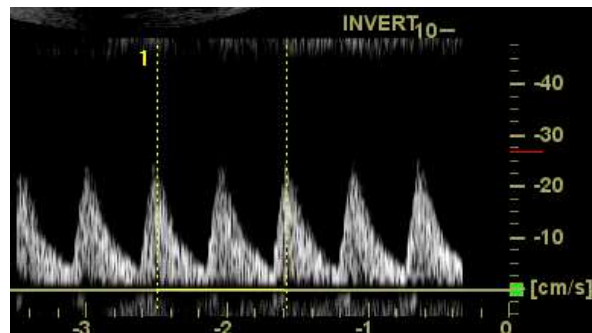

Figure 7-15. Two Heart Beat Reference (example in Doppler mode)

5. To complete the measurement and transfer the calculation to the worksheet, press **Set**.

**NOTE:** *For information about how to specify the number of heart beats that the system will use, See 'Options tab' on page 7-9 for more information.*

### Doppler Mode Measurements

In Doppler Mode, the Generic study includes the following measurements:

- PI (Pulsatility Index)
- RI (Resistive Index)
- PS/ED Ratio or ED/PS Ratio
- A/B Ratio
- HR (Heart Rate)

*NOTE: The following instructions assume that you do the following:*

1. In the B-Mode part of the display, scan the anatomy you want to measure.
2. Go to the Doppler Mode part of the display.
3. Press **Freeze**.

### Control Assignment

#### Cancel Transfer

*NOTE: Only for Vascular, Abdomen, OB and GYN.*

After the Auto Vascular calculation results are assigned to a particular vessel, the user can cancel the assignment and assigned parameters are removed from Worksheet and Report page.

When Cancel Transfer occurs, a message appears on the screen to indicate the value was erased from Worksheet and Report page.

#### Vessel location

If the vessel has a location, you can select one of the following:

- Proximal (**Prox**)
- Middle (**Mid**)
- Distal (**Dist**)

*NOTE: If you do not wish to assign a vessel location, press the lit location, then no location is assigned. Choose the folder you want the value assigned to.*

To select one of the locations, adjust the Touch Panel control.



## Pulsatility Index (PI)

For auto trace:

1. Select **PI**.  
The system displays a caliper and a vertical dotted line.
2. Position the caliper at the beginning of the waveform.
3. To fix the start point, press **Set**.  
The system displays a second active caliper.
4. Position the caliper at the end of the waveform.
5. To complete the measurement, press **Set**.  
The system displays peak systole, minimum diastole, end diastole, TAMAX, and PI in the Results Window.

For manual trace:

1. Select **PI**.  
The system displays a caliper and a vertical dotted line.
2. Position the caliper at the beginning of the waveform.
3. To fix the start point, press **Set**.  
The system displays a second active caliper.
4. Manually trace the entire waveform.
5. To complete the measurement, press **Set**.  
The system displays peak systole, minimum diastole, end diastole, TAMAX, and PI in the Results Window.

## Resistive Index (RI)

1. From the Doppler Generic Touch Panel, select **RI**.  
The system displays an active caliper with vertical and horizontal dotted lines.
2. To position the caliper at the peak systolic velocity, move the **Trackball**.
3. To fix the measure point, press **Set**.  
The system displays a second active caliper.
4. To position the second caliper at the end diastolic velocity, move the **Trackball**.
5. To complete the measurement, press **Set**.  
The system displays PS, ED, and RI in the Results Window.

### PS/ED or ED/PS Ratio

To calculate the Peak Systole/End Diastole ratio or End Diastole/Peak Systole ratio:

1. Select **PS/ED** or **ED/PS**.

The system displays an active caliper with vertical and horizontal dotted lines.

2. To position the caliper at peak systole (PS) or end diastole (ED), move the **Trackball**.

3. To fix the measure point, press **Set**.

The system displays a second active caliper.

4. To position the second caliper at end diastole (ED) or peak systole (PS), move the **Trackball**.

5. To complete the measurement, press **Set**.

The system displays the peak systole, end diastole, and PS/ED or ED/PS ratio in the Results Window.

### Heart Rate

To measure heart rate, See 'Heart Rate' on *page 7-31 for more information*. or select any of the following measurements.

### A/B Ratio

In Doppler Mode you can measure A/B ratio by velocity, time, or acceleration.

*NOTE: The LOGIQ Totus automatically activates the A/B Ratio with the default selection. If another method is preferred, select it from the Touch Panel.*

### Velocity

See 'Velocity' on page 7-30 for more information.

### Time

See 'Time' on page 7-29 for more information.

### Acceleration

To measure A/B ratio by acceleration:

1. Select **A/B**.
2. Select **ratio(Acc)**.  
The system displays an active caliper.
3. Make a distance measurement of the A acceleration point.
  - a. To position the active caliper at the start point, move the **Trackball**.
  - b. To fix the start point, press **Set**.  
The system fixes the first caliper and displays a second active caliper.
  - c. To position the second active caliper at the end point, move the **Trackball**.  
A dotted line connects the measurement points.
  - d. To complete the measurement, press **Set**.  
The system displays the distance value in the Results Window and displays an active caliper for the second distance measurement.
4. To make a distance measurement of the B acceleration point, repeat steps a–d.  
The system displays the two acceleration measurements and the A/B ratio in the Results Window.

### Acceleration

1. Select **Accel**.  
The system displays an active caliper with vertical and horizontal dotted lines.
2. To position the caliper at peak systole, move the **Trackball**.
3. To fix the measure point, press **Set**.  
The system displays a second active caliper.
4. To position the second caliper at end diastole, move the **Trackball**.
5. To complete the measurement, press **Set**.  
The system displays the peak systole, end diastole, acceleration time, and acceleration in the Results Window.

### Acceleration Time (AT)

1. Select **AT**. The system displays an active caliper and a vertical dotted line.
2. To position the caliper at the start point, move the **Trackball**.
3. To fix the first caliper, press **Set**.  
The system displays a second active caliper.
4. To position the caliper at the end point, move the **Trackball**.
5. To complete the measurement, press **Set**.  
The system displays the acceleration time in the Results Window.

### Peak Systole (PS), End Diastole (ED), or Minimum Diastole (MD)

To calculate the peak systole, end diastole, or minimum diastole:

1. Select **PS**, **ED**, or **MD**.  
The system displays an active caliper with vertical and horizontal dotted lines.
2. To position the caliper at the measurement point, move the **Trackball**.
3. To complete the measurement, press **Set**.  
The system displays the peak systole, end diastole, or minimum diastole in the Results Window.

## Helpful hints



### HINTS

The following hints can help when making a measurement

- Prior to making measurements, use the Cine function, if necessary, to display the best image.
- As you take measurements, each measurement is given a sequential number on the display and in the Results Window. Nine measurements can be displayed in the Results Window at one time.
- Once the Results Window has nine measurements, if you make any further measurements, the system erases the top (first) measurement and adds the new measurement last ("first in, first out").
- While you are taking a measurement, the value in the Results Window updates until you complete the measurement.

# Mode Measurements

## B-Mode Measurements

The following measurements can be made in B-Mode.

- Distance
- Circumference
- Circumference and Area
  - Ellipse Method
  - Trace Method
  - Spline Method
  - Intensity (Echo level) Method

**NOTE:** *The following instructions assume that you first scan the patient and then press **Freeze**.*



**WARNING**

DO NOT perform a depth measurement using 4D probes.

## Distance measurement

To make a distance measurement:

1. Press **Measure** once; an active caliper displays.
2. To position the active caliper at the start point, move the **Trackball**.
3. To fix the start point, press **Set**.  
The system fixes the first caliper and displays a second active caliper.
4. To position the second active caliper at the end point, move the **Trackball**.  
A dotted line connects the measurement points, if preset accordingly.
5. To complete the measurement, press **Set**.  
The system displays the distance value in the Results Window.



### HINTS

- **Before** you complete a measurement:
  - To toggle between active calipers, press the top Trackball key.
  - To erase the second caliper and the current data measured and start the measurement again, press **Clear** once.
- **After** you complete the measurement:
  - To rotate through and activate previously fixed calipers, adjust **Cursor Select**.
  - To erase all data that has been measured to this point, but not data entered onto worksheets, press **Clear**.

### Circumference measurement

#### Open Trace

To trace the circumference of a portion of the anatomy and calculate its length:

*NOTE: Set OpenTrace to the Touch Panel in Utility -> Measure before perform the measurement. See 'Display/hide a folder or a measurement in the Touch Panel' on page 7-80 for more information.*

1. Press **Measure**.
2. Select **Open Trace** from the Touch Panel.
3. Position the caliper at the start point.
4. To fix the trace start point, press **Set**. The caliper changes to an active caliper.
5. Move the **Trackball** to trace the measurement area. A dotted line shows the traced area.
6. To complete the measurement, press **Set**. The system displays the circumference in the Results Window.



## Circumference and area (ellipse) measurement

You can use an ellipse to measure circumference and area. To measure with an ellipse:

1. Press **Measure** once; an active caliper displays.
2. To position the active caliper, move the **Trackball**.
3. To fix the start point, press **Set**. The system fixes the first caliper and displays a second active caliper.
4. To position the second caliper, move the **Trackball**.
5. Adjust the **Ellipse** control; an ellipse with an initial circle shape displays.
6. To position the ellipse and to size the measured axes (move the calipers), move the **Trackball**.
7. To increase the size, adjust the **Ellipse** control in a clockwise direction. To decrease the size, adjust the **Ellipse** control in a counterclockwise direction.
8. To toggle between active calipers, press the top **Trackball key**.
9. To complete the measurement, press **Set**. The system displays the circumference and area in the Results Window.



### HINTS

Before you complete the ellipse measurement:

- To erase the ellipse and the current data measured, press **Clear** once. The original caliper is displayed to restart the measurement.
- To exit the measurement function without completing the measurement, press **Clear** a second time.

### Circumference and area (trace) measurement

To trace the circumference of a portion of the anatomy and calculate its area:

1. Press **Measure**.
2. Press the top **Trackball key** to select Trace; a caliper displays.
3. To position the caliper at the start point, move the **Trackball**.
4. To fix the trace start point, press **Set**. The caliper changes to an active caliper.
5. To trace the measurement area, move the **Trackball** around the anatomy. A dotted line shows the traced area.
6. To complete the measurement, press **Set**. The system displays the circumference and the area in the Results Window.



#### HINTS

Before you complete the trace measurement:

- To erase the line (bit by bit) back from its current point, move the **Trackball** or adjust the **Ellipse** control counterclockwise.
- To erase the dotted line but not the caliper, press **Clear** once.
- To clear the caliper and the current data measured, press **Clear** twice.

## Circumference and area (spline trace) measurement

To trace the circumference of a portion of the anatomy and calculate its area:

**NOTE:** *Spline trace is not available through the factory default. The system defaults to trace. To enable spline trace, modify the Measure Key Sequence preset found in Utility -> Measure -> Advanced preset menu.*

1. Press **Measure**.
2. Press the top **Trackball key** to select Spline Trace; a caliper displays.
3. To position the first caliper at the start point, move the **Trackball**.
4. To fix the trace start point, press **Set**. The first caliper turns yellow. The second caliper appears at the same position as the first caliper and is green.

**NOTE:** *When pressing the **Clear** key once, the second caliper disappears and the first caliper is activated.*

*If **Clear** is pressed again, the first caliper disappears and the Spline trace is cancelled.*

5. To position the second caliper, move the **Trackball** and press **Set**. The third caliper appears at the same position.

**NOTE:** *The **Clear** key functionality is the same as noted in the previous step.*

The spline trace requires at least three points to draw the trace. Continue setting the points of the trace until the desired points are set.

6. Press **Set** again after the last caliper is fixed to finalize the spline trace. All points are removed from the line and the spline trace turns yellow.

**NOTE:** *Pressing **Set** twice finishes the trace measurement.*

If **Clear** is pressed twice when more than 3 points exist on the trace, all points are removed and the first caliper again displays.

## Circumference and area (spline trace) measurement (continued)

### Edit the spline trace

1. Select **Cursor Select**. The spline trace changes to green and all points appear on the trace as yellow.  
A pick-caliper appears on the center of the image and the message “Edit spline trace” displays at the bottom of the screen.

**NOTE:** *The pick-caliper is used to select and move the trace points.*

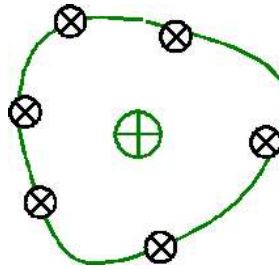

Figure 7-16. Edit spline trace

Select **Cursor Select** again. The trace is deactivated (changes to yellow) and all points, including the pick-caliper, are removed.

If the previous/next fixed caliper exists on the image, it is activated.

**NOTE:** *Pressing **Clear** at this time removes all points and the trace graphic.*

2. Move the pick-caliper to the desired point and press **Set**. The point is activated and turns green.
3. Move the point to the desired position and press **Set**. The point is fixed and turns yellow. The pick-caliper appears on the center of the image.

**NOTE:** *The spline trace is updated at run time.*

**NOTE:** *To remove a point, press **Clear** while moving the point. The trace turns green and the remaining points continue to be shown as yellow. If there are less than three points, the spline trace is removed.*

4. Press **Set** again. All points are removed from the trace and the trace is shown as yellow.

## Intensity (Echo level) measurement

To make an echo level measurement:

1. Press **Measure**.
2. Press the top Trackball key to select Intensity. A caliper displays.
3. To position the caliper at the start point, move the **Trackball**.
4. To fix the trace start point, press **Set**. The caliper changes to an active caliper.
5. To trace the measurement area, move the **Trackball** around the anatomy. A dotted line shows the traced area.
6. To complete the measurement, press **Set**. The system displays the echo level, as EL \_\_ dB, in the Results Window.

*NOTE: The echo level measurement is only available on a frozen image, not on a B-paused image.*

*NOTE: Echo Level is not available through the factory default. To enable echo level, modify the Measure Key Sequence preset, found in the Utility -> Measure -> Advanced preset.*

## Doppler Mode Measurements

Four basic measurements can be made in Doppler Mode.

- Velocity
- TAMAX and TAMEAN (Manual or Auto Trace)
- Two Velocities with the Time Interval and Acceleration between them
- Time Interval
- Volume Flow

*NOTE: The following instructions assume that you do the following:*

1. In the B-Mode part of the display, scan the anatomy you want to measure.
2. Go to the Doppler Mode part of the display.
3. Press **Freeze**.

### Velocity

To measure velocity:

1. Press **Measure**; an active caliper with a vertical dotted line displays.
2. To position the caliper at the desired measurement point, move the **Trackball**.
3. To complete the measurement, press **Set**. The system displays the velocity measurement in the Results Window.

### Slope (Velocity, Time Interval and Acceleration)

To measure two velocity values, the time interval (ms), and acceleration ( $m/s^2$ ):

1. Press **Measure**. Press the top Trackball key to select Slope; an active caliper with vertical and horizontal dotted lines displays.
2. To position the caliper at the start point, move the **Trackball**.
3. To fix the start point, press **Set**. The system fixes the first caliper and displays a second active caliper.
4. To position the second caliper at the end point, move the **Trackball**.
5. To complete the measurement, press **Set**. The system displays the two peak end point velocities, the time interval, and the acceleration in the Results Window.

### Time interval

To measure a horizontal time interval:

1. Press **Measure**. Press the top Trackball key to select Time; an active caliper with vertical and horizontal dotted lines displays.
2. To position the active caliper at the start point, move the **Trackball**.
3. To fix the start point, press **Set**. The system fixes the first caliper and displays a second active caliper.
4. To position the second caliper at the end point, move the **Trackball**.
5. To complete the measurement, press **Set**. The system displays the time interval between the two calipers in the Results Window.

## TAMAX and TAMEAN

### Manual Trace

The value measured depends upon the Vol Flow Method preset. The two selections available are: Peak (TAMAX) and Mean (TAMEAN).

To do a manual trace of TAMAX or TAMEAN:

1. Press **Measure**. Press the top Trackball key to select Trace; a caliper displays. Select **Manual** on the Touch Panel.
2. To position the caliper at the trace start point, move the **Trackball**.
3. To fix the start point, press **Set**.
4. To trace the velocity spectrum boundary, move the **Trackball**.

*NOTE: To edit the trace line, move the **Trackball**.*

5. To complete the measurement, press **Set**. The system displays the measurement values in the Results Window.

### Auto Trace

The value measured depends upon the Vol Flow Method preset. The two selections available are: Peak (TAMAX) and Mean (TAMEAN).

To auto trace TAMAX:

1. Press **Measure**. Press the top Trackball key to select Trace; an active caliper with a vertical dotted line displays. Select **Auto** on the Touch Panel.
2. To position the caliper at the trace start point in the Doppler spectrum, move the **Trackball**.
3. To fix the start point, press **Set**.
4. To position the vertical caliper at the end point, move the **Trackball**.
5. To complete the measurement, press **Set**. The system automatically fixes both calipers and traces the maximum value between the two points. The system displays this value in the Results Window.

*NOTE: When you set the Auto Trace for Both (above and below), the system picks up the maximum power of the signal, NOT the maximum velocity. If the maximum velocity is not the maximum power, the system may not trace accurately. If you want to use maximum velocity, select either Above or Below.*

### Edit Trace

Auto Trace can be edited after taking an Auto Trace measurement.

1. After taking an Auto Trace measurement, select the measurement result on the result window. The Edit Trace (Edit Peak or Edit Mean) menu window appears.

*NOTE: If the system cannot take the trace data correctly from the image, Edit Trace does not work.*

2. Select Edit Trace. The first caliper (manual trace caliper) appears on the center of the image. Use the **Trackball** to move the caliper on the trace line to the start point.

*NOTE: To cancel Edit Trace at this time, press **Clear**, **Scan**, or **Freeze**.*

3. Press **Set** to fix the first caliper. The second caliper appears. Edit the trace manually using the second caliper.

The Ellipse control is used to edit the trace.

*NOTE: When pressing the **Clear** key once at this time, the second caliper disappears and the first caliper appears in the center of the image.*

*NOTE: If you press **Scan** or **Freeze** at this time, the caliper is automatically fixed and the result window updates.*

4. Press **Set** to fix the second caliper. The trace and the result window update. The trace data (TAMAX and TAMEAN) are updated, though the other points (e.g. PS, ED) are not updated by trace. The points can be edited with **Cursor Select**.

*NOTE: While in Edit Trace, Cursor Select is disabled.*

5. Repeat Edit Trace as needed.



## Doppler Auto Calc Average Cycle

When using Auto Calc, a selection is available to average a number of cycles automatically. There is also a preset selection in the Utility Imaging PW page for this feature. When using average cycle:

- Selected cardiac cycle lines display on the image. Point calipers are not displayed.
- When changing the number of cycles from 1 to >1, all the data is reacquired from the image, recalculated and updated.
- When multiple cycles are selected in AutoCalc, the average values calculate and display automatically.
- When selecting Peak Value (PV), average cycle is not available.

**NOTE:** *You cannot edit the lines while in Average Cycle. Cursor Select is not available at that time.*

**NOTE:** *Average Cycle data is acquired from the display image area only, for both live and frozen. The average cycle data fails if the setting for the number of cycles is larger than the number of image cycles.*

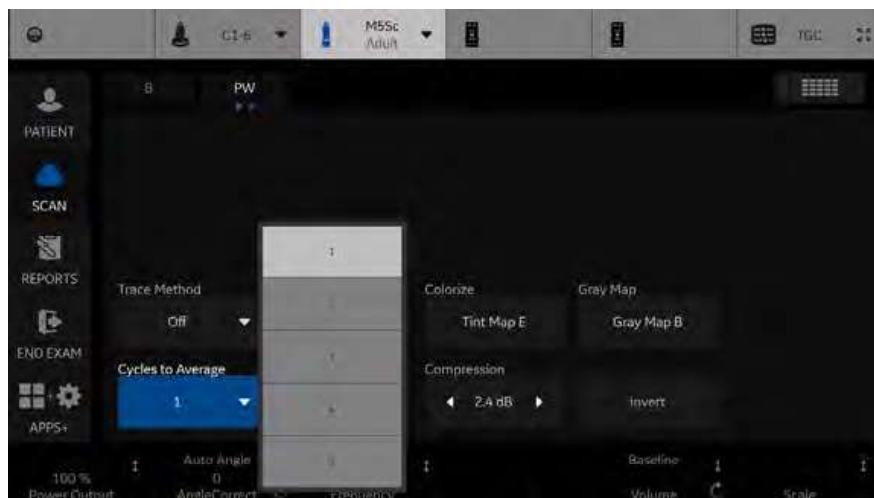

Figure 7-17. PW Touch Panel

### Volume Flow - Manual Calc

You perform a manual Volume Flow measurement using the TAMAX plus a Volume Flow coefficient compensation.

1. To perform the Volume Flow measurement using the TAMAX plus a Volume Flow coefficient compensation, in Utility-->Measure-->Advanced, select the following:
  - Trace = Manual
  - Vol Flow Method = TAMAX [you MUST also select a Volume Flow coefficient for use with TAMAX.]
  - Vol Flow Compensation with TAMAX = [select value from 0.5 to 1.0]
2. Set Auto Calcs to Off via Doppler Mode-->Modify Auto Calcs-->Off.
3. Select a folder in Doppler Mode-->select a calculation folder-->select Show All.
4. Select **Volume Flow**. You'll notice that TAMAX is automatically selected.

*NOTE: Ensure that you have placed the caliper in the spectral window when selecting the Volume Flow measurement.*

5. Trace the TAMAX. The system prompts you to "Mark the first point on the spectral doppler." Press **Set**.
6. The system prompts you to "Trace the velocity spectrum boundary." Press **Set**.

*NOTE: You can back up while tracing the TAMAX by using the Trackball.*

7. Trace the vessel diameter. The system prompts you to "Mark first point of vessel diameter for volume flow calculation." Press **Set**.
8. The system prompts you to "Mark last point of vessel diameter for volume flow calculation." Press **Set**.
9. The Volume Flow is calculated in ml/min.

## Volume Flow - Auto Calc

You can perform an automatic Volume Flow measurement using TAMEAN or using the TAMAX and a Volume Flow coefficient.

1. To perform the Volume Flow measurement using the TAMEAN, in Utility-->Measure-->Advanced, select the following:
  - Trace = Auto
  - Vol Flow Method = TAMEANOR, to perform the Volume Flow measurement using the TAMAX plus a Volume Flow coefficient compensation, select the following:
  - Trace = Auto
  - Vol Flow Method = TAMAX [if you use TAMAX, you MUST also select a Volume Flow coefficient for use with TAMAX.]
  - Vol Flow Compensation with TAMAX = [select value from 0.5 to 1.0]
2. Set Auto Calcs to Live via Doppler Mode-->Modify Auto Calcs-->Live.
3. Perform the scan.
4. Select **Volume Flow** via Doppler Mode-->Modify Auto Calcs-->VOLUME FLOW. The system prompts you through the measurement.
5. Take vessel diameter for volume flow calculation. Set the first cursor.
6. Mark last point of vessel diameter for volume flow calculation. Press **Set**.
7. The calculation automatically completes the Volume Flow measurements as ml/min.

**NOTE:** *If you change the TAMAX coefficient, the Volume Flow is automatically adjusted when in Auto Calcs (but not in Manual Calcs).*

### Flow Volume (FV)

Flow Volume estimates the volume of blood that flows through a vessel per unit time. It is derived from a vessel's cross-sectional diameter obtained from the B-Mode portion of the image and the mean velocity of flow in the vessel obtained from the Doppler portion of the image. It is measured in milliliters. When the FV measurement is made, FVO is automatically calculated.

To measure flow volume:

1. Select **FV** from Doppler Touch Panel.
2. Place the dotted horizontal line caliper at each of the time base on the Doppler spectrum.
  - If Trace Auto is selected, the waveform is automatically traced.
  - If Trace Auto is not selected, manually trace the desired portion of the waveform.

The caliper moves to the B-Mode area.

3. Use the Ellipse or Trace method to measure the circumference and area of the vessel.

The flow volume (FV) is calculated and displayed in milliliters. The flow volume output (FVO) is also calculated and displayed in milliliters/minute.

### Flow Volume Output (FVO)

This measurement is used to measure the flow volume output in a vessel on the Doppler spectrum. It is measured in milliliters/minute. When the FVO measurement is made, FV is automatically calculated.

## Auto vs. Manual Calculations

The same calculations can be performed using either manual or auto calcs.

### Manual Calcs

To perform manual calcs:

1. To turn Auto Calcs off and perform manual measurements, choose **Auto Calcs -> OFF** on the PW tab of the Touch Panel.
2. After obtaining a waveform, press **Measure**. Choose the appropriate vessel folder or calculation. The system walks you through the measurement.

*NOTE: To program which calculations are done under manual calcs when using measurement folders for measuring specific vessels, press the Utility key. Select Measure -> Doppler and program your manual calcs (Auto Calcs OFF). Each vessel must be programmed individually and saved after each change.*

### Auto Calcs

To perform auto calcs:

1. Ensure that the auto calcs function is on by choosing **Auto Calcs -> Frozen** or **Live** on the Doppler tab of the Touch Panel.
  - Live: Auto calculation activates when the system is in real-time.
  - Frozen: Auto calculation activates when you press Freeze.
  - Off
2. After obtaining a waveform, press **Measure**. Choose the appropriate vessel folder, side and location. The measurements that are pre-programmed are performed automatically and entered in the worksheet.

To modify auto calcs:

1. Select **Modify Auto Calcs** on the Touch Panel.
2. Choose the measurements to be performed with this preset.
3. To save these measurements:
  - If this is a temporary change, press **Return**.
  - If this is a permanent change, select **Save as default**.

The measurements are saved and can be performed with the auto calcs function.

### Edit Auto Calcs

Auto Calcs can be edited after taking an Auto Trace measurement.

1. After taking an Auto Calc with a trace, select the measurement result on the result window. The Edit Trace menu window appears.

*NOTE: If the system cannot take the trace data correctly from the image, Edit Trace does not work.*

2. Select Edit Trace. The first caliper (manual trace caliper) appears on the center of the image. Use the **Trackball** to move the caliper on the trace line to the start point.

*NOTE: To cancel Edit Trace at this time, press **Clear**, **Scan**, or **Freeze**.*

3. Press **Set** to fix the first caliper. The second caliper appears. Edit the trace manually using the second caliper.

The Ellipse control is used to edit the trace.

*NOTE: When pressing the **Clear** key once at this time, the second caliper disappears and the first caliper appears in the center of the image.*

*NOTE: If you press **Scan** or **Freeze** at this time, the caliper is automatically fixed and the result window updates.*

4. Press **Set** to fix the second caliper. The trace and the result window are updated. The data is retaken from the trace and updated.

*NOTE: While in Edit Trace, Cursor Select is disabled.*

The trace data (TAMAX and TAMEAN) is updated, but the other selections (e.g. PS, ED) are not updated by trace. The points can be edited using **Cursor Select** if needed.

5. Repeat Edit Trace as needed.

## Modify Auto Calcs

When you select this key, the Modify Calculation menu is displayed as below. In this menu, you select parameters to display in the Auto Vascular Calculation window. Only parameters that can be used by the calculation are displayed.

Select **Save as Default** to save the selected parameters as the default calculations for this application.

Select **Return** to return to the previous Touch Panel screen.

If you select **PV**, all selected parameters are turned off. When you deselect **PV**, the system returns to the previously selected calculation.

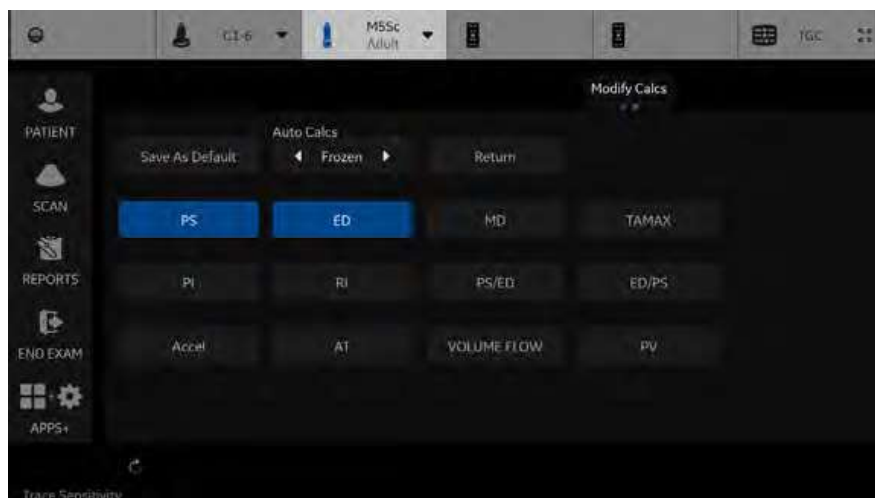

Figure 7-18. Modify Auto Calculation Menu

### M-Mode Measurements

Basic measurements that can be taken in the M-Mode portion of the display are:

- Tissue Depth (Distance)
- Time Interval
- Time Interval and Velocity



CAUTION

DO NOT perform a depth measurement using 4D probes.

*NOTE:* The following instructions assume that you do the following:

1. In the B-Mode part of the display, scan the anatomy you want to measure.
2. Go to the M-Mode part of the display.
3. Press **Freeze**.

### Tissue depth

Tissue depth measurement in M-Mode functions the same as distance measurement in B-Mode. It measures the vertical distance between calipers.

1. Press **Measure** once; an active caliper with a vertical and horizontal dotted line displays.
2. To position the active caliper at the most anterior point you want to measure, move the **Trackball**.
3. To fix the start point, press **Set**.  
The system fixes the first caliper and displays a second active caliper.
4. To position the second caliper at the most posterior point you want to measure, move the **Trackball**.
5. To complete the measurement, press **Set**.

The system displays the vertical distance between the two points in the Results Window.



## Time interval

To measure a horizontal time interval and velocity:

1. Press **Measure**. Press the top Trackball key to select Time; an active caliper with vertical and horizontal dotted lines displays.
2. To position the caliper at the start point, move the **Trackball**.
3. To fix the first caliper, press **Set**. The system fixes the first caliper and displays a second active caliper.
4. To position the second caliper at the end point, move the **Trackball**.
5. To complete the measurement, press **Set**. The system displays the time interval between the two calipers in the Results Window.

## Slope (Time interval and Velocity)

To measure time and velocity between two points:

1. Press **Measure**. Press the top Trackball key to select Slope; an active caliper with vertical and horizontal dotted lines displays.
2. To position the active caliper at the start point, move the **Trackball**.
3. To fix the start point, press **Set**.  
The system fixes the first caliper and displays a second active caliper.
4. To position the second caliper at the end point, move the **Trackball**.
5. To complete the measurement, press **Set**.  
The system displays time(s) and slope between the two points in the Results Window.

# Worksheet

## Introduction

The worksheet function enables the user to review, edit, delete or print data independently of a report. All measurements and calculations taken during the examination can be viewed at any time using the worksheet.

As you complete measurements, the system puts measurement data in the appropriate worksheets.

*NOTE: Worksheets are not saved if the system crashes.*

## To view a worksheet

To view a worksheet, select **Worksheet** on the Touch Panel.

OR

Select **Worksheet** on the measurement summary window.

The system displays the worksheet for the current study.



Figure 7-19. OB Worksheet

The OB Worksheet has three sections of information:

1. Patient data
2. Measurement information
3. Calculation information

To return to scanning, do one of the following:

- Select **Worksheet**.
- Press **Esc**.
- Select the **Exit** button.

### To view a worksheet (continued)

To view a different worksheet, select the worksheet key for the desired exam.

To view worksheet data for a particular mode, select the key for that mode. To view a worksheet with data for more than one mode, select **Expand**. When Expand is selected, it defaults to view all measurements, noted by mode, on the worksheet.

If a worksheet has more data on a second page, to view the next page, adjust the **Page Change** control.

### To edit a worksheet



#### HINTS

Some fields on the worksheet are view only, and others you can change or select. To easily see which fields you can change or select, move the **Trackball**. As the cursor moves over a field that you can change or select, the field is highlighted.

### Change data

1. Select **Worksheet** from any page of the Vascular Calculation Touch Panel.
2. Position the cursor at the field you want to change by moving the **Trackball**.  
The cell is highlighted. Press **Set**. The field backlights.
3. Type the new data in the field and move the cursor to another place. Press **Set**. The new data, displayed in blue with an asterisk, is appended to the updated value and resultant value to indicate that it was manually entered.

The average measurements, calculations and ratios are automatically updated to reflect the edited values.

**NOTE:** *If the user moves the cursor to the edited value and presses the **Set** key once, the value returns to the original value before the edit was made.*

## To edit a worksheet (continued)

### Exclude data

When the user selects a particular value on the Worksheet and selects **Exclude Value**, this value is excluded from result line and resultant value is re-calculated without this value and also calculation values using this value is 'blank'.

1. To position the cursor at the field you want to delete or exclude, move the **Trackball**. The field is highlighted.
2. Do one of the following:
  - To exclude the field, select **Exclude Value**.  
The data in the field is not visible and is not included in worksheet calculations.
  - To include a value that you previously excluded, select **Exclude Value**.

### Delete data

1. Select **Worksheet** from any page of the Vascular Calculation Touch Panel Menu.
2. Position the cursor at the field you want to delete or exclude by moving the **Trackball**.  
The field is highlighted.
3. Select **Delete Value** from the Touch Panel.

For Example:

1. If the user measured RI 4 times, the latest 3 sets of RI measurements are displayed in the worksheet.

Table 7-5: Example of Latest Measurements in Worksheet

Result Number	#2	#3	#4
PS	0.500	0.600	0.700
ED	0.100	0.200	0.300
RI	0.800	0.667	0.571

To edit a worksheet (continued)

2. Then, the user deleted PS value of #3 from the worksheet.
3. Then, if the user deletes the PS value in column #3 from the worksheet, the whole set of measurements from column #3 is deleted from the worksheet and measurements from column #1 are shifted and displayed, as below.

Table 7-6: Example of Latest Measurements in Worksheet

Result Number	#1	#2	#4
PS	0.500	0.600	0.700
ED	0.100	0.200	0.300
RI	0.800	0.667	0.571

Examiner's comment

To type a comment on a worksheet:

1. Select **Examiner's Comments**. The Examiner's Comments window opens.
2. Type comments about the exam.
3. To close the Examiner's Comments window, select **Examiner's Comments**.

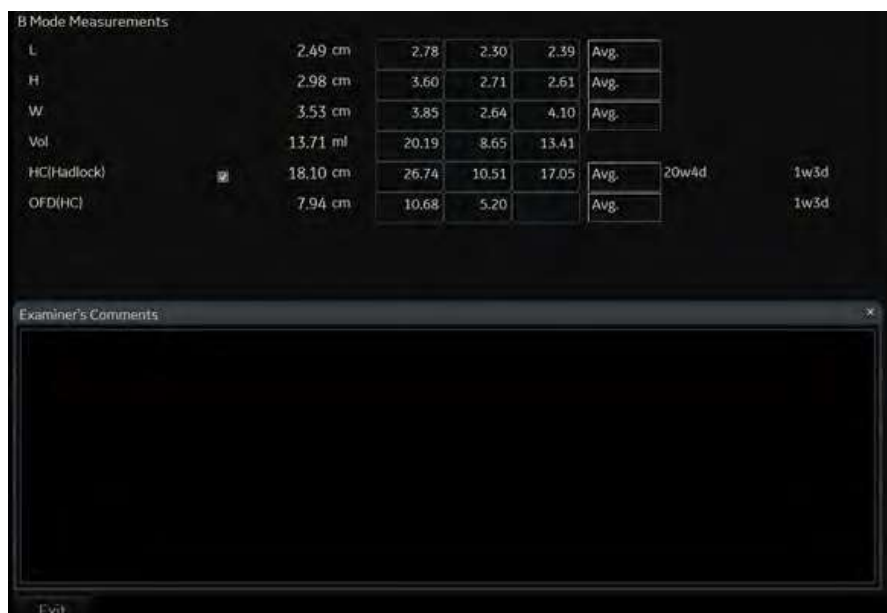

Figure 7-20. Examiner's comments field

## To edit a worksheet (continued)

### Volume measurement value off

1. Select the method type **Off**. The value field becomes blank.

### To select a method

1. Move the cursor over the value in the method column and press **Set**.
2. The pull-down menu displays. Move the cursor to select the method and press **Set**. The selected method is displayed in the column.



Figure 7-21. Pop-up menu of methods - example

1. Avg.: Average of the measurements taken
2. Max.: Maximum measurement
3. Min.: Minimum measurement
4. Last: Last measurement that was taken

### Delete All Worksheet Values

You can delete all worksheet values on a worksheet.

1. When the Worksheet is displayed on the monitor, press the **Clear** key; the following warning message appears:

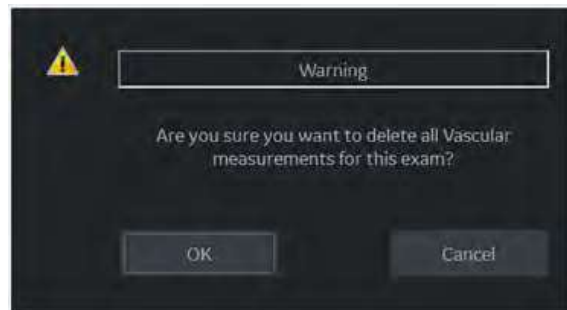

Figure 7-22. Delete All Warning Message

2. Select **OK** to delete all.  
Select **Cancel** to cancel the deletion.

### Recording Worksheet

The worksheet can be saved as you would any ultrasound image. Once it is displayed on the screen, it can be recorded on the DVR, printed on the B/W printer, stored on media with the Image Archive option, or placed on regular paper with a line printer.



## OB Worksheet

### Patient data

The Patient data section, at the top of the worksheet, lists information from the Patient Data Entry screen.

You can select the following fields:

- FetusNo – if this is a multi-gestational patient, you can select the fetus in this field. You can also adjust the **Fetus** selection to change the fetus.
- CUA/AUA – select the ultrasound age calculation method
  - Composite Ultrasound Age (CUA) – regression calculation
  - Average Ultrasound Age (AUA) – an arithmetic average

You can select the method in this field, or adjust the **Select CUA/AUA** control.

*NOTE: CUA/AUA is only available when you select USA OB Type in the Utility -> System -> System Measure menu.*

You can enter information in the following fields:

- FetusPos – type information about the fetus position.
- PLAC – type information about the placenta.

### Calculation information

This section of the worksheet provides calculation choices and lists calculation results.

- EFW – lists the parameters used to calculate EFW. This is followed by the calculation result.

To change which parameters are used:

- a. Select this field or press **Select EFW**.
- b. Select the desired parameters.

- EFW GP – lists the source used to calculate EFW–GP (growth percentile). This is followed by the growth percentile.

To change the source:

- a. Select this field or press **Select GP**.
- b. Select the desired source.

The remaining calculation information shows ratios for several measurements, and the Cephalic Index (CI).

The worksheet shows if any of the ratios are out of range (OOR). Out of range indicates one of the following:

- The measurement is out of the normal range based on the gestational age that is calculated from the LMP. The system determines OOR from the ultrasound age compared to the gestational age. The gestational age is calculated from the last menstrual period or the estimated delivery date.
- The measurement is outside of the range for the data used in the calculation. That means that the measurement is either less than or more than the range of measurements used to determine fetal age based on the measurement.

For more information about how to use the worksheet, see 'Worksheet' on *page 7-58* for more information.

## Vascular Worksheet

### Intravessel ratio

On the Vessel Worksheet page, to calculate the Intravessel ratio, you need a measurement of assessing pressure and stenotic velocities.

1. Select **Intrav. Ratio** from the Touch Panel. The Intravessel Ratio pop-up window displays in the header section of the worksheet.

	1	2	3	Method
<b>Prox CCA</b>				
PS (cm/s)	8.1			Last
ED (cm/s)	1.8			*
AC (deg)	60			*
<b>Mid CCA</b>				
PS (cm/s)	22.9			Last
ED (cm/s)	13.7			*
AC (deg)	60			*
<b>Dist CCA</b>				
PS (cm/s)	19.7	20.3		Last
ED (cm/s)	14.7	8.4		*
AC (deg)	60	60		*

Figure 7-23. Intravessel Pop-up Window

2. Select the first velocity. The value displays in the window. The value is displayed in the window.

Figure 7-24. Intravessel ratio one

### Intravessel ratio (continued)

- Select the second velocity.

The second value and Result value display in the window.

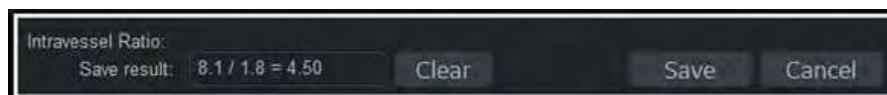

Figure 7-25. Intravessel ratio two

- To save the Intravessel ratio to the Vessel Summary, move the cursor to **Save** and press **Set**.
- To clear values, move the cursor to **Clear** and press **Set**.
- To cancel and exit Intravessel ratio, move the cursor to **Cancel** and press **Set**.

*NOTE: Intravessel Ratio is only displayed and saved in the Vessel Summary as Intra-Ratio.*

### Vessel Summary

The Vessel Summary is designed to automatically display measurements made at specific anatomical sites. Calculated ratios are automatically summarized and displayed.

The Vessel Summary can be displayed at any time during the exam by selecting **Vessel Summary** from the Vascular Worksheet Touch Panel.

	Right			Left		
	PS	ED	AC	PS	ED	AC
Prox CCA	8.1cm/s	1.8cm/s	60deg	21.0cm/s	10.0cm/s	60deg
Mid CCA	22.9cm/s	13.7cm/s	60deg	22.2cm/s	9.3cm/s	60deg
Dist CCA	20.3cm/s	8.4cm/s	60deg	19.4cm/s	11.5cm/s	60deg
Intra-Ratio	4.57					

Figure 7-26. Vessel Summary Example

## Vessel Summary (continued)

1. The first row, indicating Right or Left, is not displayed when the side is not defined in the vessel. In the third column on the second line, you select the calculations. Move the cursor to the third column, and the pop-up menu is displayed. The selected parameter is displayed in every third column.

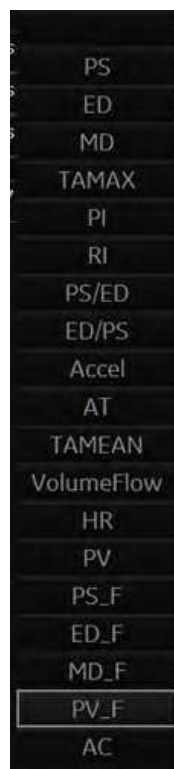

Figure 7-27. Pop-up menu

2. Vessel Name with location information.
3. Check Box. Use to select the vessel velocity for calculating the vessel ratio (ex. ICA/CCA). You can only select one location (position) in a vessel.
4. Result value column. This value cannot be changed or excluded from this page.
5. Calculation name and result. ICA/CCA: The ICA/CCA ratio selects the highest systolic ICA and CCA velocities when calculating this ratio, and displays the velocities.

### Carotid Study

In the configuration page for ICA/CCA ratio, you can specify which portion of the CCA vessel (Prox, mid, distal) is chosen. You can override the selections on the Vessel summary.

The ICA/CCA ratio is able to be configured for either systole or diastole.

The vertebral vessel also has systole and diastole selections. In the summary page, there is a box to select flow reversal for vertebral flows. The choices are Ante (Antegrade), Retr (Retrograde), and Abs (Absent).

To select the method:

Move cursor to the box and press **Set**. After the pop-up menu (Blank, Ante, Retr, Abs) is displayed, select from a menu of choices. The selected choice is displayed in the column.

The box is independent of Left and Right.

### Renal Artery Study

For renal arteries, you can calculate RENAL/AORTIC ratio (RAR) based on peak systolic velocities.

You can combine the two renal summary pages, and have a heading to separate the different measurements (main renal, intra renal). You can scroll between the measurements. The most commonly used, the main renal artery, is the default.

### Lower Extremity Artery Study

For the lower extremity artery, you need an intra vessel ratio (assessing pre vs. stenotic velocities). You can specify which (ratio is stenotic/pre).

The intra-vessel ratio needs to be available for all vascular measurements. This appears on the worksheet only if used.

### Recording Worksheet

The worksheet can be saved as you would any ultrasound image. Once it is displayed on the screen, it can be recorded on the DVR, printed on the B/W printer, stored on media with the Image Archive option, or placed on regular paper with a line printer.

### Print All Pages

When there are multiple pages, a "Print All Pages" button is displayed on the Touch Panel Default is ON. If Print All Pages is set to ON, press the Print button; then all pages are stored/printed, depending on the how the print button is configured.

# Anatomical Survey

## Overview

The Anatomical Survey page provides a checklist that indicates which anatomy was imaged and its appearance.

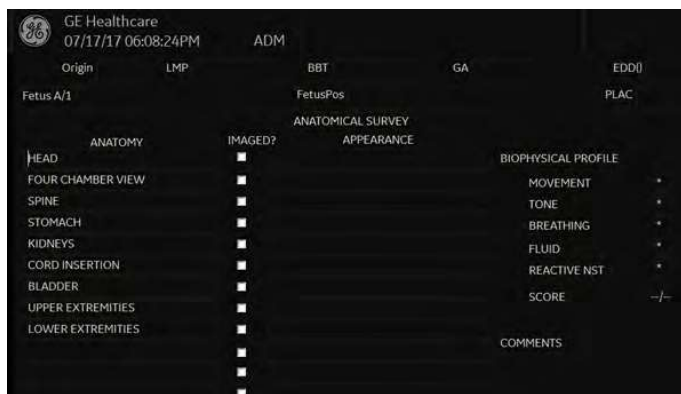

Figure 7-28. OB Anatomical Survey



Figure 7-29. Abdominal Anatomical Survey

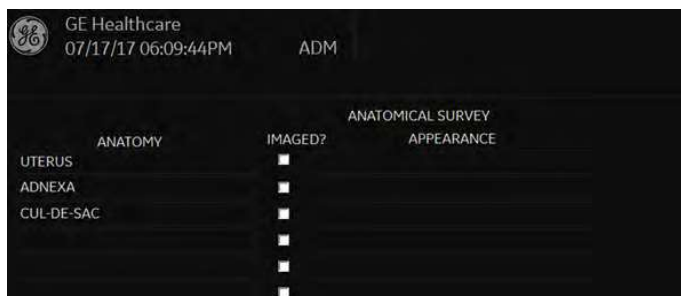

Figure 7-30. GYN Anatomical Survey

## Editing

1. To activate the Anatomical Survey, select **Anatomy** on the Worksheet Touch Panel.
2. Fill the required field.

Table 7-7: Abdomen Anatomical Survey

Field	Description
ANATOMY	<p>Enter the following information for each part of the anatomy imaged:</p> <ol style="list-style-type: none"> <li>1. Imaged?: Check the box that you did image this part of the anatomy.</li> <li>2. Appearance: If you checked the Imaged? box, indicate whether the appearance was normal or abnormal.</li> </ol> <p>You can add additional anatomy to this worksheet. Up to 9 additional items can be added.</p> <p>Move the Trackball to the blank field.</p> <p>Enter the anatomy name.</p>
COMMENTS	Free text

Table 7-8: OB Anatomical Survey

Field	Description
Fetus Pos	Indicate the fetal position within the uterus.
PLAC	Identify the location of the placenta.
ANATOMY	<p>Enter the following information for each part of the anatomy imaged:</p> <ol style="list-style-type: none"> <li>1. Imaged? : Check the box that you did image this part of the anatomy.</li> <li>2. Appearance : If you checked the Imaged? box, indicate whether the appearance was normal or abnormal.</li> </ol> <p>You can add additional anatomy to this worksheet. Up to 9 additional items can be added.</p> <p>Move the Trackball to the blank field.</p> <p>Enter the anatomy name.</p>
BIOPHYSICAL	The score is _ of 10 possible total points, depending upon the number of parameters entered. Enter the following information to assess the fetus's biophysical well-being.
Movement	Type 0, 1 or 2
Tone	Type 0, 1 or 2
Breathing	Type 0, 1 or 2
Fluid	Type 0, 1 or 2



Table 7-8: OB Anatomical Survey (Continued)

Field	Description
Reactive NST (Reactive non-stress test)	Type 0, 1 or 2
COMMENTS	Free text

Table 7-9: GYN Anatomical Survey

Field	Description
ANATOMY	<p>Enter the following information for each part of the anatomy imaged:</p> <ol style="list-style-type: none"> <li>1. Imaged?: Check the box that you did image this part of the anatomy.</li> <li>2. Appearance: If you checked the Imaged? box, indicate whether the appearance was normal or abnormal.</li> </ol> <p>You can add additional anatomy to this worksheet. Up to 9 additional items can be added.</p> <p>Move the Trackball to the blank field.</p> <p>Enter the anatomy name.</p>
COMMENTS	Free text

3. Select **Exit** to return to the Scan screen.

Select **Worksheet** to return to the Worksheet.

**NOTE:** *The patient specific contents input on the Anatomical Survey page are returned to the factory default settings after starting a new patient.*

# Measurement and Calculation Setup

Measurements and studies are organized for typical work flows. If you want, you can change this set up. You can specify which studies are in each exam category, and which measurements and calculations are in each study. You can change the measurements that are available on the Touch Panel. The LOGIQ Totus allows you to quickly and easily set up your system so that you can work most efficiently.

This section describes how to:

- Change a study to include different measurements
- Add a new study or measurement
- Remove a study from an exam category
- Change measurement parameters
- Create a measurement formula to correctly handle unit conversions
- Edit user-defined calculations
- Define application-specific measurement parameters
- Specify the default manual calc measurements for a selected study or folder

## Starting Study and Measurement Setup

You can make changes to studies and measurements in the Measurement & Analysis screen. To open the screen:

1. On the Touch Panel, select **Utility**.
2. On the Touch Panel, select **Measure**.
3. The system displays the Measurement & Analysis screen on the monitor display.

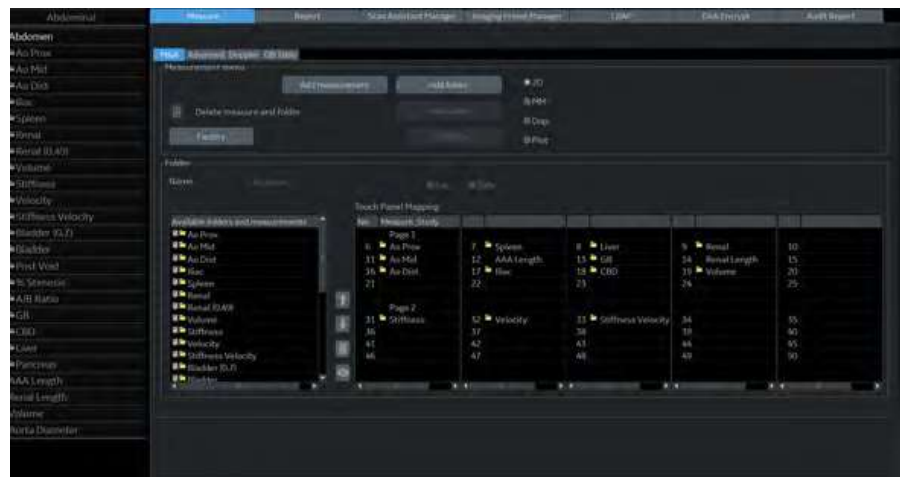

Figure 7-31. Measurement & Analysis screen

- **Selection menu:** select exam category, study, or measurement folder/measurement.
- **Measurement menu:** add and delete studies (folders) and measurements; select mode.
- **Folder or measurement:** define studies and measurements. This section changes between Folder and Measurement, depending on what you select in the Selection menu.

### Select the exam category

To select the exam category you want to work with:

1. Move the cursor to the exam category at the top of the Selection menu.
2. Press **Set**.  
The system displays a list of exam categories.
3. Move the cursor to the desired exam category.
4. Press **Set**.

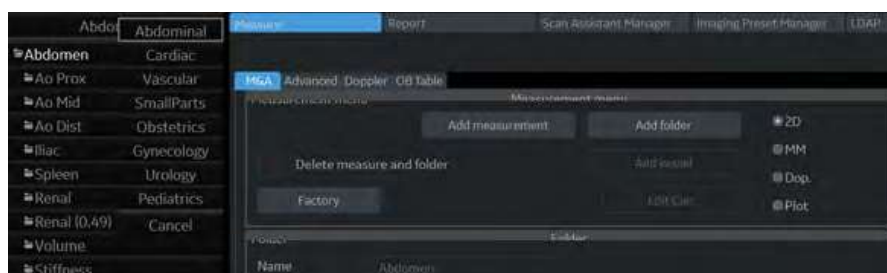

Figure 7-32. Select the exam category

## Select the study

1. Move the cursor to the current study in the Selection menu.



Figure 7-33. Select the study

2. Press **Set**. All study displays.

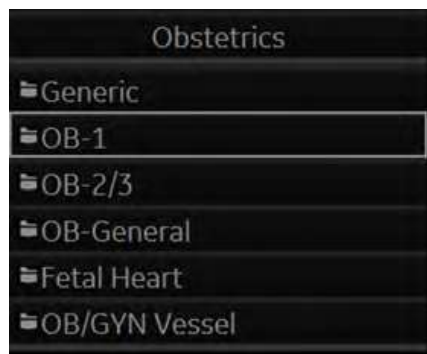

Figure 7-34. Select the study

3. Move the cursor to the desired study you want to open.
4. Press **Set**.

### Select a measurement folder or a measurement

1. Move the cursor to the desired measurement folder or the desired measurement in the Selection menu.
2. Press **Set**.
  - If you select a measurement folder, the Folder section displays information about the selected folder.



Figure 7-35. Folder - example

- If you select a measurement, the Measurement section displays information about the selected measurement.

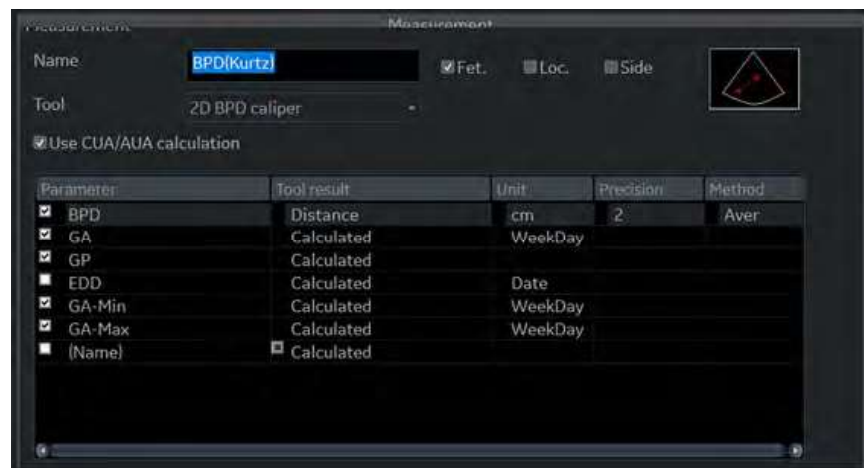

Figure 7-36. Measurement - example

## Select the measurement mode

In the Measurement menu, select the measurement mode which you work with.

- 2D (B-Mode)
- MM (M-Mode)
- Dop (Doppler Mode)
- Plot (Plot Mode—The measurement on the plot graph of the TIC/QAnalysis)



Figure 7-37. Measurement menu

### Display/hide a folder or a measurement in the Touch Panel

The Folder section of the Measurement & Analysis screen has two lists of folders and measurements. This is where you specify which items go in a study or folder.

- **Available folders and measurements.** The list contains all possible folders and measurements for the selected study or folder.
- **Measure & Study.** The list defines where the folder or measurement is located on the Touch Panel.

To display an item in the Touch Panel:

1. In the Measure & Study list, move the **Trackball** to highlight which folder you want to put the item in, and press **Set**.
2. Move the **Trackball** to highlight an item in the Available folders and measurements list, and press **Set**. The selected item is assigned to the Touch Panel.



Figure 7-38. Select the position and an item



Figure 7-39. Measure & Study list: New item added

The selected item is now displayed in the Touch Panel and the Summary Window.



## Touch Panel positions

Each Touch Panel has 25 positions, five across and five down. The items in the first row across are numbered 1–5, in the second row 6–10, and so on. Positions 1–5 are system programmed and cannot be edited.



Figure 7-40. Measure & Study display with Touch Panel positions, Page 1

### Touch Panel positions (continued)

Page 2 of the Touch Panel has 25 positions, five across and five down. The items in the first row across are numbered 26-30, in the second row 31-35, and so on. Positions 26-30 are system programmed and cannot be edited.



Figure 7-41. Measure & Study display with Touch Panel positions, Page 2

## Move, Remove or Hide Touch Panel Items



Figure 7-42. Move (1), Remove (2) and Hide (3) Icons

### Move Touch Panel Items

To move items on the Touch Panel, change the item position in the Measure & Study list.

1. Highlight an item in the Measure & Study list.
2. Move the cursor to the Up or Down Arrow Icon and press **Set** (see 1 in Figure 7-42 on page 7-83).

The item is displayed at the selected position on the Touch Panel.

### Remove Touch Panel Items

To remove items from the Touch Panel, remove the item from the Measure & Study list.

1. Move the **Trackball** to highlight the item in the Measure & Study list and press **Set**.
2. Select the Trash Icon to the right of the list (see 2 in Figure 7-42 on page 7-83).

The system removes the item from the Measure & Study list and from the Touch Panel. The item is still listed in the Available folders and measurements list.

### Hide Touch Panel Items

Modifiers for Stenosis, as well as Prox, Mid, Distal and Origin location identifiers, can be hidden on the Touch Panel using the Hide command in the Measure & Study list.

1. Move the **Trackball** to highlight the item in the Measure & Study list and press **Set**.
2. Select the Hide Icon to the right of the list (see **3** in Figure 7-42 on page 7-83).

The system hides the modifier from the Measure & Study list and from the Touch Panel. Once a modifier is hidden, another measurement can be assigned to the Touch Panel location.

To reestablish the hidden modifier, highlight the hidden modifier in the Measure & Study list, press **Set** and select the Hide Icon.

**NOTE:** *If a modifier is hidden in either 2D or Doppler mode, it will be hidden in both modes.*

## Setting up an automatic measurement flow

In some cases, related measurements are put in a measurement folder. This allows you to logically organize measurements. It also allows you to specify that the system automatically start each measurement in a folder, one after the other. This is the automatic sequence feature. To use this feature:

1. In the Selection menu, select the folder that contains the measurements you want.
2. In the Folder section, select Auto sequence.

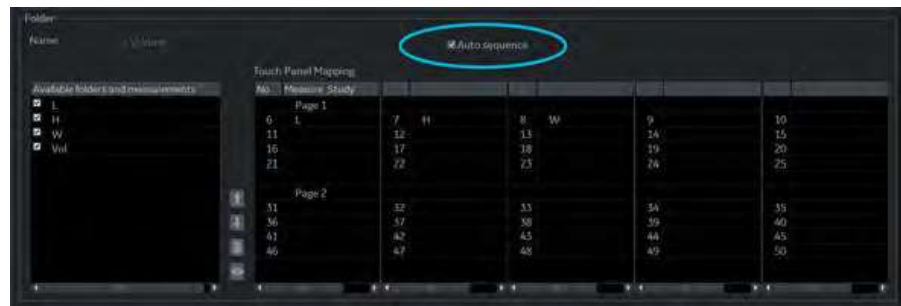

Figure 7-43. Measurement & Analysis screen: Auto sequence

### Change the tool used to make a measurement

You can make changes to some of the measurements. For example, Head Circumference can be measured with an ellipse, a trace, or two distances. You can select the measurement tool you want to use.

1. Select the measurement you want to change in Selection menu.
2. In the Measurement section, select the desired tool from the Tool list.

**NOTE:** *If the Tool field is gray, it cannot be changed.*

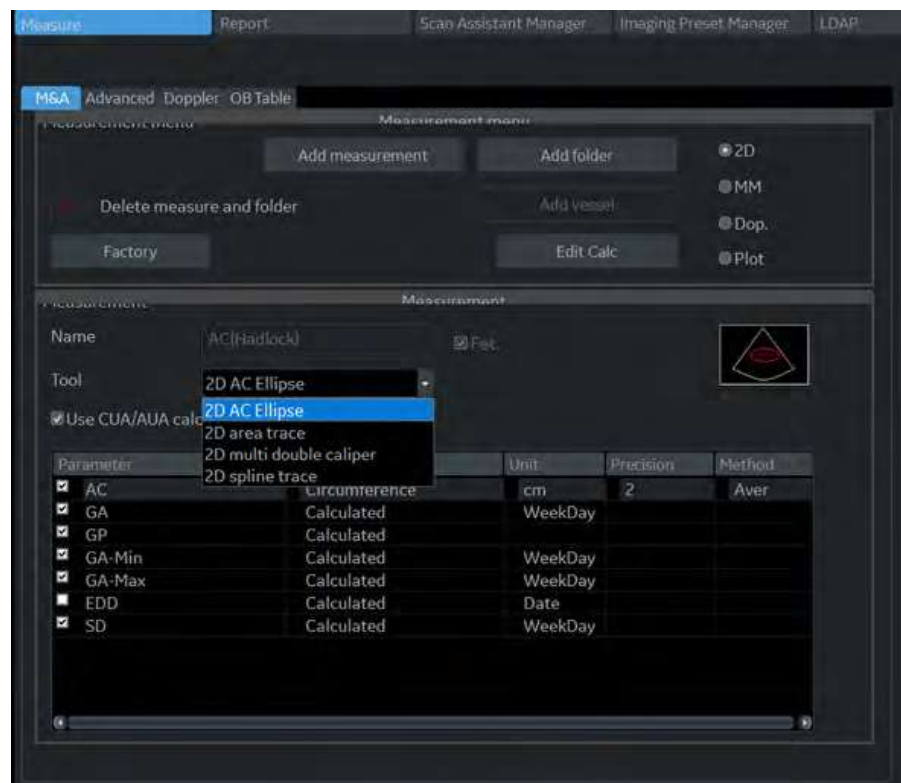

Figure 7-44. Change the tool

**NOTE:** *The diagram to the right of the Tool list shows the measurement type. In the following example, ellipse is selected and the diagram shows an ellipse.*

## Adding Folders and Measurements

### Adding a folder

When you add a folder, it can be a study, or a measurement folder that includes related measurements.



Figure 7-45. Measurement & Analysis: Add folder

1. In the Selection menu, select the study or folder where you want to add the folder.
2. Select the mode in the Measurement menu.

### Adding a folder (continued)

3. In the Measurement menu section, select Add folder.
  - If you select Blank, the system adds a folder with a name such as USERDEFS1. It is listed in the Selection menu.

**NOTE:** *For Generic study, you can only use Blank.*

- If you want to use an existing folder, select Insert, and then select a folder from the list.



Figure 7-46. Add folder Window

4. Select the user-defined folder in the Selection menu.

Type the name.

**NOTE:** *You cannot change an existing folder name.*

**NOTE:** *DO NOT use "single quotes" for a parameter name, a measurement name, a folder name or an author name.*

6. Add a measurement to the folder.



## Adding a Measurement



### DANGER

Please remember that you are responsible for confirming the correctness and accuracy of the user input formula that you enter or is entered into the system on your behalf. Failure to confirm the correctness and accuracy of user defined calculations could lead to patient injury.

You can add a measurement to the folder.

**NOTE:** *DO NOT use "single quotes" for a parameter name, a measurement name, a folder name or an author name.*

1. In the Selection menu, select the study or folder where you want to add the measurement.
2. In the Measurement menu section, select Add measurement.

The system displays the Add Measurement window.



Figure 7-47. Add Measurement window

3. Do one of the following:
  - If you want to create this measurement from a copy of an existing measurement, select Use copy of, and then select a measurement from the list. The list includes all measurements defined for the current exam category and selected mode.

**NOTE:** *This only applies to OB and Cardiac.*

- If you want to use an existing formula, select Insert, and then select a measurement from the list. The list includes all measurements defined for the current exam category and selected mode. You cannot edit this formula.
- If you want to create a blank new measurement, select Blank.

### Adding a Measurement (continued)

4. Select OK.
  - If you created a blank measurement, the system adds a measurement with a name such as USERDEFM3.
  - If you created a measurement from a copy of an existing measurement, the system lists the measurement and its parameters in the Measurement section.
5. When you create a new measurement, the measurement name is automatically highlighted. Type a name for the new measurement. You can change the name of a measurement you created from a copy.

**NOTE:** *2D Dual Caliper, 2D Dual Area, 2D Dual Ellipse, and 2D Dual Spline Trace are not available through the factory default. To enable these measurements, add a new measurement using “2D Dual Caliper”, “2D Dual Area”, 2D Dual Ellipse”, or “2D Dual Spline Trace” tool.*

### Changing measurement parameters



#### DANGER

Please remember that you are responsible for confirming the correctness and accuracy of the user input formula that you enter or is entered into the system on your behalf. Failure to confirm the correctness and accuracy of user defined calculations could lead to patient injury.

To change a measurement parameter:

1. In the Selection menu, select the measurement.
2. To change the name of the Parameter, move the **Trackball** to the parameter name and press **Set** twice. Type a name for the parameter.

## Adding measurement parameters

To add a measurement parameter:

1. In the Selection menu, select the measurement.
2. To change the tool used to make a measurement:  
In the Measurement section of the Measurement & Analysis screen, select the desired tool from the Tool list. Select the arrow to display the drop-down list.

*NOTE: If the Tool field is gray, it cannot be changed.*

3. If necessary, check Fetus (OB only), Location (Loc), or Side:
  - Fetus: If this is an OB measurement, check this box. (Default ON).
  - Location: If this measurement includes a Prox, Mid, or Dist location, check this box.
  - Side: If this measurement includes a Left or Right side, check this box.
4. In the Measurement section, move the **Trackball** to an empty line at the bottom of the Parameter list. Press **Set**.  
The system adds a parameter with a name of (Name).

### Adding measurement parameters (continued)

5. To change the name of the Parameter, move the Trackball to the (Name) and press **Set** twice. Type a name for the parameter.
6. Move the **Trackball** to the Tool result field, and double click the **Set** key.

The Edit Formula window is displayed.



Figure 7-48. Edit Formula

7. To create a formula:
  - a. In the Value Type field, select a value.
  - b. Do one of the following:
    - Type a formula in the Formula field.
    - Select formula components from the Operators, Parameters, and Functions drop-down lists. When you select a component, the system displays it in the Formula field.
8. To test the formula, select Check.

If there are no problems, the system displays “Syntax OK!”.  
If there are any problems with the formula, the system displays an Error message in place of the Formula field label.
9. When the formula is correct, select OK to save it.

The Edit Formula window closes. The formula is displayed in the Tool result field.

## Formula Unit Conversion

When you create a formula, the system changes the calculation result into an output unit as defined in the following table.

Table 7-10: Formula Unit Conversion

Unit		Conversion (coefficient value)
Time		
	s	x1
	ms	x1,000
	min	x0.0167
	h	x0.00027778
Ratio		
	%	x100
Frequency		
	bpm or BPM	x1.0
Angle		
	rad	x1.0
	deg	x57.2958
	grad	x63.6620
Distance		
	cm	x100
	m	x1
	dm	x10
	mm	x1,000
	inch	x39.37
	feet	x3.281
	pixels	x1
Velocity		

Table 7-10: Formula Unit Conversion (Continued)

Unit		Conversion (coefficient value)
	m/s	x1
	dm/s	x10
	cm/s	x100
	mm/s	x1,000
	inch/s	x39.37
Acceleration		
	m/s <sup>2</sup>	x1
	dm/s <sup>2</sup>	x10
	cm/s <sup>2</sup>	x100
	mm/s <sup>2</sup>	x1,000
	inch/s <sup>2</sup>	x39.37
Area		
	m <sup>2</sup> or m <sup>2</sup>	x1
	dm <sup>2</sup>	x100
	cm <sup>2</sup> or cm <sup>2</sup>	x10,000
	mm <sup>2</sup> or mm <sup>2</sup>	x1,000,000
	inch <sup>2</sup>	x1550
Volume		
	m <sup>3</sup>	x1
	dm <sup>3</sup>	x1,000
	cm <sup>3</sup>	x1,000,000
	l	x1,000
	dl	x10,000
	cl	x100,000
	ml	x1,000,000
	gallon	x264,178
	quart	x1056.71
Volume Flow		

Table 7-10: Formula Unit Conversion (Continued)

Unit		Conversion (coefficient value)
	m <sup>3</sup> /s	x1
	dm <sup>3</sup> /s	x1,000
	cm <sup>3</sup> /s	x1,000,000
	mm <sup>3</sup> /s	x1,000,000,000
	l/s	x1,000
	dl/s	x10,000
	cl/s	x100,000
	ml/s	x1,000,000
	m <sup>3</sup> /min	x60
	dm <sup>3</sup> /min	x60,000
	cm <sup>3</sup> /min	x60,000,000
	mm <sup>3</sup> /min	x60,000,000,000
	l/min or L/min	x60,000
	dl/min	x600,000
	cl/min	x6,000,000
	ml/min	x60,000,000
	ml/m <sup>2</sup>	x1,000,000
Pressure		
	mmHg	x1
	Pa	x133.322
	kPa	x0.133322
	bar	x0.00133322
Pressure/Time		
	mmHg/s	x1
Mass		
	kg	x1
	g	x1,000
	ounce	x35.273962
	pound	x2.2046226

Table 7-10: Formula Unit Conversion (Continued)

Unit		Conversion (coefficient value)
Others		
	l/minm <sup>2</sup>	x60000.0
	g/m <sup>2</sup>	x1000.0
	cm/m <sup>2</sup>	x100.0
	cm <sup>2</sup> /m <sup>2</sup>	x10000.0
	ml/kg/min	x60000000.0

For example, when a Volume formula is created:

$$\text{Vol [ml or cm}^3\text{]} = 0.523598 \cdot \{D1\} \cdot \{D2\} \cdot \{D3\}$$

(D1, D2, and D3 indicate a measurement result.)

In this case, the measurement (D1, D2, and D3) is a distance measurement, so the measured data is a meter [m] unit according to the above table.

To change into a milliliter, the system multiplies each measurement value by 100. As a result, it multiplies a formula by 1,000,000.

The standard unit of volume is a cube meter, so the system multiplies the result by 1,000,000.

The system multiplies the calculation result by the coefficient and converts it. To get a correct result, when you define the formula, you must convert the coefficient itself, such as the coefficient of 10<sup>^</sup>.



## Formula Unit Conversion (continued)

For example, if you want to define the following formula:

$$\text{efg[g]} = 10^{(1.5662-0.0108*\{P1\}+0.0468*\{P2\}+0.171*\{D1\}+0.00034*\{P1\}*\{P1\}-0.003685*\{P2\}*\{D1\})}$$

D1[cm]: Distance

P1[cm]: Perimeter

P2[cm]: Perimeter

The system defines the standard value of each measurement as a meter [m]. If the unit of each measurement value of this formula is defined as centimeter [cm], you must define the formula as follows:

$$\text{efw[g]} = 10^{(1.5662-0.0108*\{P1\}*100 + 0.0468*\{P2\}*100 + 0.171*\{D1\}*100 + 0.00034*\{P1\}*\{P1\}*100*100 - 0.003685*\{P2\}*\{D1\}*100*100)}$$

(This converts each measurement value to a centimeter [cm], since the system standard unit is a meter [m].)

The output unit of this formula is a gram. Since the standard unit of the system is defined as a kilogram [kg], the system multiplies the output by 1,000.

Because the output of this formula is defined as a gram, it is necessary to define the formula as follows.

$$\text{efw[g]} = 10^{(1.5662-0.0108*\{P1\}*100 + 0.0468*\{P2\}*100 + 0.171*\{D1\}*100 + 0.00034*\{P1\}*\{P1\}*100*100 - 0.003685*\{P2\}*\{D1\}*100*100)/1,000}$$

As shown, you can obtain an exact calculation result.

### Editing Calculations

To modify user-defined calculations:

1. Select Add Measurement from the Measurement menu. The system displays the Add Measurement window.
2. Select Blank and OK.
3. Type the appropriate name and select “Calculation” from the Tool pull-down menu.

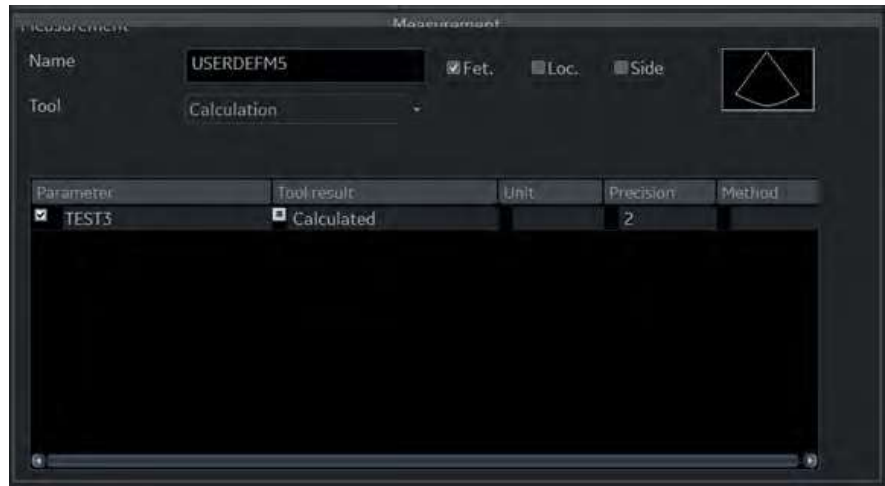

Figure 7-49. Measurement window

4. Type the parameter name.
5. Double click on the = Calculated symbol under Tool Result. The Edit Formula window displays.
6. Select OK.
7. In the Measurement menu section, select *Edit Calc.*



Figure 7-50. Edit Calc

The Modify User CALC window displays.

## Editing Calculations (continued)

8. In the User Defined list, select the calculation that you want modified, then select OK.



Figure 7-51. Modify User CALC window

9. The Measure tab for user-defined calculations displays. Double click on the equals sign symbol under Tool Result for the desired parameter.
10. Edit the formula as needed and select OK.

## Deleting a Folder or Measurement

**NOTE:** *You can only delete user-defined folders or measurements. You cannot delete default system folders or measurements.*

1. Select the folder or measurement in the Selection menu.
2. In the Measurement menu section, select the Trash icon next to Delete measure and study.

### M & A Advanced Preset

The Advanced tab allows you to specify application-specific values for certain parameters.

1. On the monitor display, select the Advanced tab.

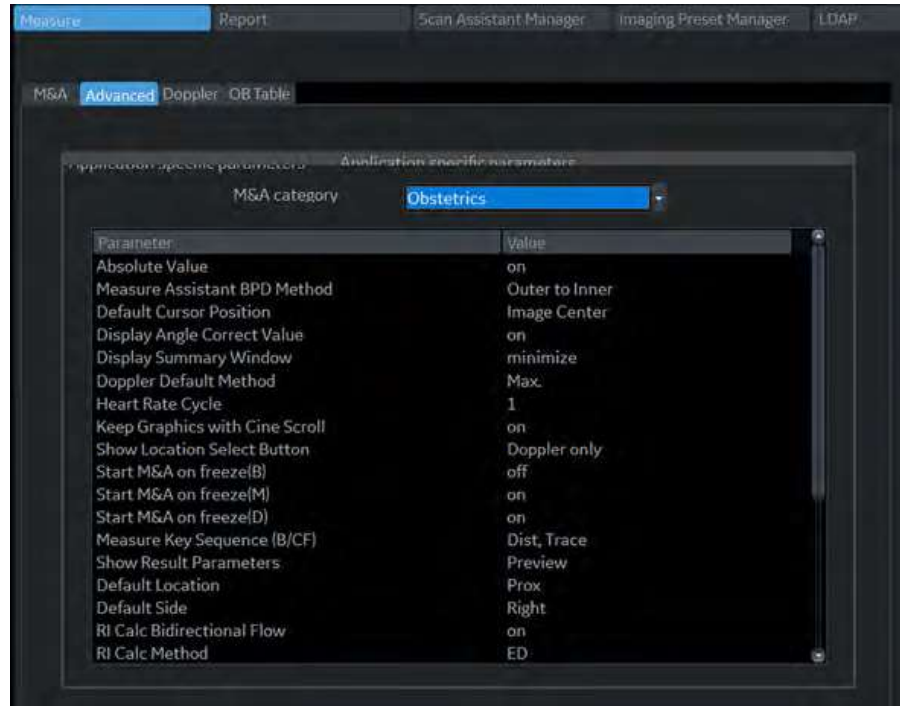

Figure 7-52. M&A Advanced Preset Menu

**M&A Category:** Display and select current exam category.

**Parameter:** Lists application specific parameters.

**Value:** Select the value for a parameter.

2. Select an exam category.  
The Parameters list displays parameters for the selected category.
3. Select a value for a parameter.

**NOTE:** *The parameters that appear are category dependent.*

M & A Advanced Preset (continued)

Table 7-11: M&A Advanced

Preset Parameter	Description
Absolute Value	Displays the absolute value of the Doppler Velocity measurement (On or Off)
Default Cursor Position	Image Center/Summary Window Select the display position of the cursor when the measurement key is pressed.
Display Angle Correct Value	On or Off
Display Sample Volume Depth (TCD)	On or Off
Display Summary Window	On or Off
Doppler Default Method	Avg, Max, Min or Last
Heart Rate Cycle	1, 2, 3, 4, 5, 6, 7, 8, 9, or 10 <i>NOTE: For Cardiac, you can select only "1".</i>
Keep Graphics with Cine Scroll	If you select "On", the measurement graphics remain while in CINE scroll. The measurement graphic redisplay on the frame where the measurement was taken in B-Mode.
Start M&A on a Freeze (B)	Off: Select measurement manually on Freeze
Start M&A on a Freeze (M)	On: Measurement menu appears automatically on Freeze.
Start M&A on a Freeze (D)	Caliper: Measurement menu and caliper appear automatically on Freeze.
Measure Key Sequence (B/CF)	2 Sequences: Dist, Trace; Dist, Spline 2 Sequences: Dist, Open Trace; Dist, Open Spline 3 Sequences: Dist, Trace, Spline; Dist, Spline, Trace; Dist, Spline, Intensity; Dist, Trace, Intensity; Dist, Trace, Open Trace; Dist, Spline, Open Trace 4 Sequences: Dist, Trace, Spline, Intensity; Dist, Spline, Trace, Intensity; Dist, Spline, Trace, Open Trace; Dist, Trace, Open Trace, Spline
Show Result Parameters	Preview or After Set cursor: Preview: Displays while taking the measurement. After Set Cursor: Displays after completing the measurement.
Default Location	Off, Prox, Mid or Dist
Default Side	Left, Right or Off
PI Calc Method	MD or ED
RI Calc Bidirectional Flow	On or Off
RI Calc Method	MD or ED
Shear Measure Size	Sets the Default Diameter size of the shear wave measurement circle.

## General Measurements and Calculations

Table 7-11: M&A Advanced (Continued)

Preset Parameter	Description
Shear Measure Fixed Size	On or Off
Shear Calculation Method	Specify Mean or Median <ul style="list-style-type: none"> <li>• Mean averages all of the shear wave points within the measurement circle.</li> <li>• Median sorts, then selects the middle point of all points within the measurement circle.</li> </ul>
Shear Units Determine Folder	If you have preset shear wave units via the Display Units on the Utility -> System -> System Imaging page, then when you specify On, the unit specified pre-selects the measurement folder. If m/s is specified as the unit, then the Velocity folder is used; if kPa is specified as the unit, then the Stiffness folder is used.
Show Location Select Button	Both on B and Doppler, Doppler only or No Display NOTE1: Only Abdominal, Vascular, Obstetrics and Gynecology have this preset. NOTE2: For Obstetrics and Gynecology, you can select only Doppler only or No Display.
Show BM Folder Name on Worksheet	On or Off
Show Measure Name on Worksheet	On or Off
Show Point Velocity	On or Off
Show Tissue Depth	On or Off
Keep Result Window	Auto, On or Off
Trace	Auto or manual
Length Unit	mm, cm, Default
Velocity Unit	mm/s, cm/s, m/s, Default
Acceleration Unit	mm/s <sup>2</sup> , cm/s <sup>2</sup> , m/s <sup>2</sup> , Default
Area Unit	mm <sup>2</sup> , cm <sup>2</sup> , Default
Volume Unit	cm <sup>3</sup> , ml, l, Default
Volume Flow Unit	cm <sup>3</sup> , ml, l, Default
Time Unit	ms, s, Default
Show Area Value While Tracing	On or Off
Vol Flow Method	TAMEAN or TAMAX
Vol Flow Compensation with TAMAX	If you select TAMAX as the volume flow method, then you MUST specify the coefficient to use. Select from 0.5 to 1.0.
Worksheet Default Display	Mode/Expand (Abdominal, Small Parts, Obstetrics, Gynecology, Urology and Pediatrics) or Worksheet Summary (Vascular)

Table 7-11: M&A Advanced (Continued)

Preset Parameter	Description
Primary Worksheet	For Abdominal and Small parts. Abdominal: Worksheet or Summary, Small parts: Worksheet or SWE summary
Doppler AutoCalc Velocity Unit	Velocity, Hz, Both or Auto
Default CCA location for ICA/CCA ratio	Prox/Mid/Dist/Off Select the default location of CCA which is used for the ICA/CCA ratio.
MCA/ICA Ratio	TAMAX or PS
Default ICA location for MCA/ICA ratio	Prox/Mid/Dist/Off Select the default location of CCA which is used for the MCA/ICA ratio.
WMS Freeze Loop at ES	On or Off
WMS Segment Model	16 segments or 18 segments
WMS Initial Scoring	Undefined or Normal
WMS Scoring Legend	ASE, European or Asian
Hip Orientation	Cranial-left or Caudal-left
Show area value while tracing	On or Off
Measure Assistant BPD Method	Outer to Inner, Outer to Outer
Restrict Breast Contour Caliper Edit	On or Off
AFI/AutoEF autoprocessing	Off, delay 1s, delay 2s, delay 3s or delay 4s
AFI/AutoEF ROI method	Auto ROI or 3 Points
AFI/AutoEF YOYO	Play or Stop
AFI Default Color Palette	Red-Blue, Green-Yellow-Red
AFI segment model	17 segments, 18 segments
AFI PSS/PSI Mode	PSS only, PSS&PSI
Auto sequence - Trigger for next measurement	Measure or Freeze
Link contents	Select to link parameters by cardiac cycle.
Default value for RAP	Blank, 3, 5, 7, 8, 10,15 (system default is 3)
UGAP Print and Unfreeze	On or Off
Length unit	Default, mm or cm
Velocity unit	Default, mm/s cm/s, or m/s
Acceleration unit	Default, mm/s <sup>2</sup> , cm/s <sup>2</sup> , or m/s <sup>2</sup>

Table 7-11: M&A Advanced (Continued)

<b>Preset Parameter</b>	<b>Description</b>
Area unit	Default, mm <sup>2</sup> , or cm <sup>2</sup>
Volume unit	Default, cm <sup>3</sup> /s, ml/s, l/s, cm <sup>3</sup> /min, ml/min, or l/min
Volume Flow unit	Default, cm <sup>3</sup> /s, ml/s, l/s, cm <sup>3</sup> /min, ml/min, or l/min
Time unit	Default, ms, or s
Primary Worksheet	Worksheet or Summary



## Doppler tab - Modify Calculation

The Doppler tab allows you to preset the parameters for manual calculations.

1. On the monitor display, select the Doppler tab.
2. The following example describes how to configure the Carotid Doppler calculations.

Select Vascular next to M&A Categories. The Vascular measurement category is displayed.

3. Select Carotid. The available calculations are displayed in Modify Calcs.



Figure 7-53. M&A Doppler Preset Menu

4. Check the desired calculations to be performed.

### Application Measurement Preset

The Application Measurement presets allow different calculation packages to be available under different application presets.

The presets allow you to configure the Measurement Categories and Measurement Exam Calcs. These presets are found on the Utility -> Application -> Measurements screen.

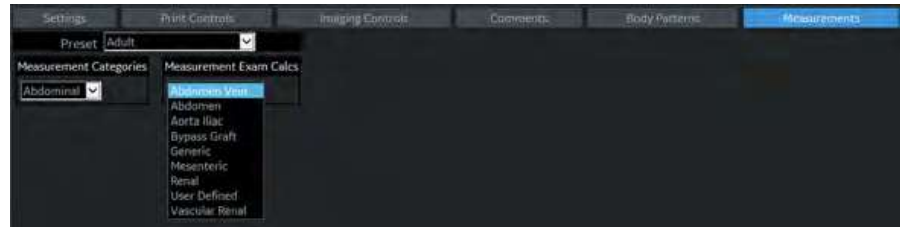

Figure 7-54. Application Measurements Menu

---

# Chapter 8

## Application M&A

*Describes how to perform application specific measurements and calculations.*

# General Information

## Overview

Measurements and calculations derived from ultrasound images are intended to supplement other clinical procedures available to the attending physician. The accuracy of measurements is not only determined by the system accuracy, but also by use of proper medical protocols by the user. When appropriate, be sure to note any protocols associated with a particular measurement or calculation. Formulas and databases used within the system software that are associated with specific investigators are so noted. Be sure to refer to the original article describing the investigator's recommended clinical procedures.

## General Guidelines

New Patient information must be entered before beginning an exam. See 'Beginning an Exam' on *page 4-2 for more information*.

Any measurement can be repeated by selecting that measurement again from the Touch Panel.

The system retains all measurements, but the worksheet retains only the last six measurements of each type.

# Abdomen

## Overview

Abdominal measurements offer a few different types of measurement studies. Select the desired study.

- Generic—Common to all applications. See ‘Generic Measurements’ on *page 7-18 for more information.*
- Abdomen
- Renal
- Bypass Graft
- Aorta Iliac
- Vascular Renal
- Mesenteric
- Abdomen Vein

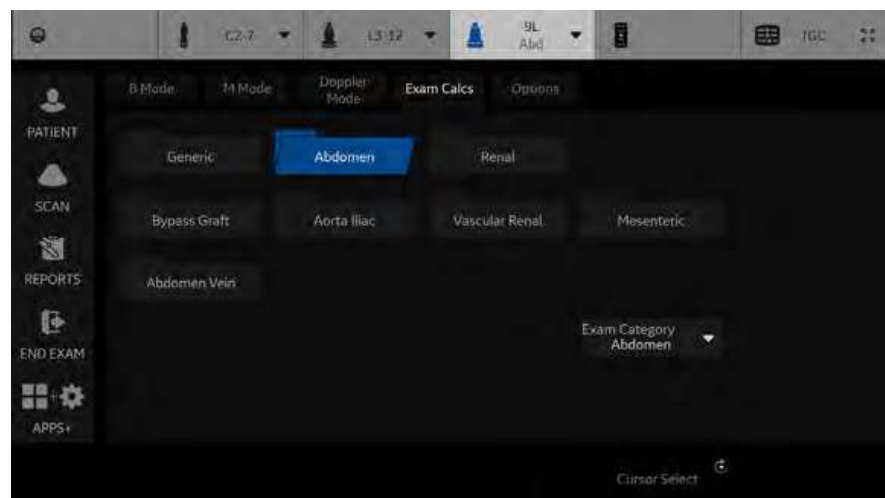

Figure 8-1. Abdomen Exam Category Touch Panel

# Small Parts

## B-Mode Measurements

The Small Parts exam category includes the following two folders:

- Generic—Common to all applications. See ‘Generic Measurements’ on *page 7-18 for more information*.
- Small Parts, which includes the breast, thyroid and scrotal measurement packages.

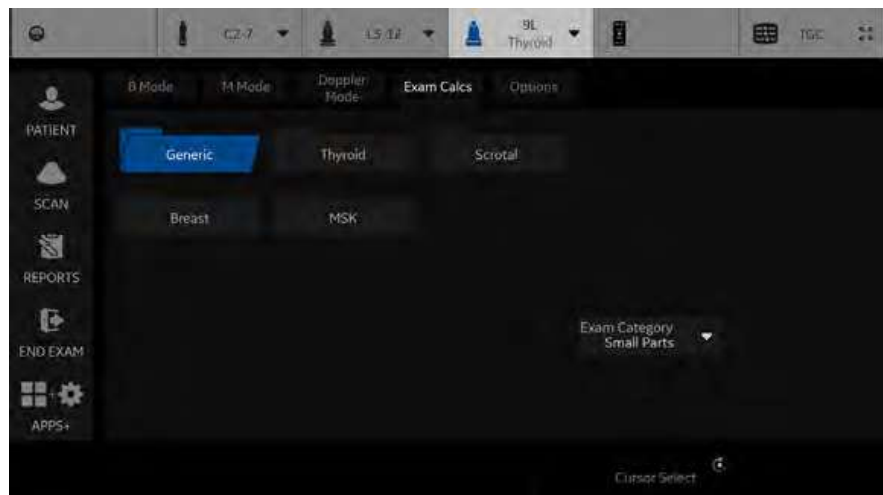

Figure 8-2. Small Parts Exam Category Touch Panel

## Thyroid

### Thyroid Left/Right

Each of these is a standard distance measurement. Length and height are typically measured in the sagittal plane. Width is measured in the transverse/axial plane.

To measure thyroid length, width, or height:

1. On the **Exam Calcs**, select **Small Parts**.
2. Select **Thyroid**.
3. Select **Lt or Rt Thyroid**. Change the orientation (side), if necessary.
4. Select **Thyroid L**, **Thyroid W**, or **Thyroid H**.  
An active caliper displays.
5. Perform a standard distance measurement.

### Isthmus AP

To measure the anterior/posterior isthmus tissue, perform a distance measurement.

## Scrotal

### Scrotal Left/Right

Each of these is a standard distance measurement. Length and height are typically measured in the sagittal plane. Width is measured in the transverse/axial plane.

To measure scrotal length, width, or height:

1. On the **Exam Calcs**, select **Small Parts**.
2. Select **Scrotal**.
3. Select **Lt or Rt Testicle**. Change the orientation (side), if necessary.
4. Select **Testicle L**, **Testicle W**, or **Testicle H**.  
An active caliper displays.
5. Perform a standard distance measurement.

## Epididymis

To measure the epididymis structure, perform a distance measurement.

## Introduction

Out of Range – If the system indicates that a measurement is out of range (OOR), it means one of the following:

- The measurement is out of the normal range based on the gestational age that is calculated from the LMP. The system determines OOR from the ultrasound age compared to the gestational age. The gestational age is calculated from the last menstrual period or the estimated delivery date.
- The measurement is outside of the range for the data used in the calculation. That means that the measurement is either less than or more than the range of measurements used to determine fetal age based on the measurement.

*NOTE: Calculation formulas are listed in the Advanced Reference Manual.*

*NOTE: Nuchal Translucency is not available through the factory default. To enable Nuchal Translucency, add NT to the measurement folder in Utility -> Measure -> M&A -> Add measurement (Insert).*



## OB Type change

The LOGIQ Totus system includes measurements for the following studies: USA, Europe, Tokyo, Osaka and ASUM.

Select OB Type in Utility -> System -> System Measure.



Figure 8-3. OB Type selection

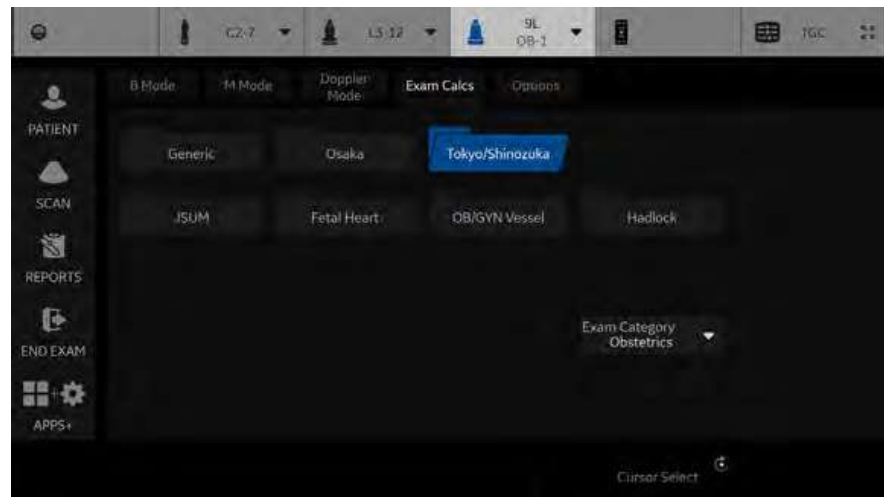

Figure 8-4. OB Type: Tokyo - example

**NOTE:** ASUM studies include the following measurements:

- ASUM: AC, BPD, and CRL
- ASUM 2001: AC, BPD, CRL, FL, HC, HL, and OFD

## To Start an Obstetrics Exam

**NOTE:** Calculation formulas are listed in the *Advanced Reference Manual*.

To begin an Obstetrics exam, you enter patient data or, if the patient data from a previous exam is saved in the system, find the patient information.

1. On the control panel, press **Patient**.  
The Patient Data Entry screen is displayed.
2. On the Patient Data Entry screen, select New Patient.
3. To choose an Obstetrics exam, move the **Trackball** to highlight Obstetrics, then press **Set**.  
The obstetric fields are listed in the Exam Information section of the Patient Data Entry screen.
4. Do one of the following:
  - If the patient data is already stored in the system, search for the data. Use the search fields in the bottom section of the Patient Data Entry screen. For information about how to search for patient data, see 'Changing Patient Information or an Exam' on *page 4-24* for more information.

When the correct patient data is listed in the search list, move the **Trackball** to highlight the patient name and press **Set**. The system displays the patient data.

**NOTE:** To change patient data, use the **Trackball** to move the cursor to the field and press **Set**. Press **Backspace** to delete the data, and then type the correct data.

- If the patient data is not stored in the system, enter the data. To enter data in a field, move the **Trackball** to highlight the field and then press **Set**. Use the **Tab** key to move between fields. Obstetric patient fields are listed in the following table.

**NOTE:** For information about entering general patient data such as Patient ID and name, see 'Beginning an Exam' on *page 4-2* for more information.

## To Start an Obstetrics Exam (continued)

Table 8-1: Obstetric fields

Field	Description
LMP	Last Menstrual Period; enter the date that the patient started her last menstrual period. You must enter 4 digits for the year. When you type the month and day, the system fills in the /. The Date Format preset chosen in Utility -> System -> General determines the required format.
BBT	Basal Body Temperature.
EDD by LMP	Estimated Delivery Date by LMP; the system fills in the date after you enter the LMP.
GA by LMP	Gestational Age by LMP; the system fills in the age after you enter the LMP.
Gravida	Number of pregnancies.
Para	Number of births.
AB	Number of abortions.
Ectopic	Number of ectopic pregnancies.
Fetus #	Number of fetuses; default is 1. Can be 1-4.
Accession #	Exam number used with hospital information system (DICOM). This is a tracking number from the worklist.
Exam Description	Describe the type of exam.
Perf Physician	The physician who performs the exam. Choose from the list or type the name.
Ref. Physician	The physician who requested the exam. Choose from the list or type the name.
Operator	The person (not a physician) who performs the scan. Choose from the list.

**NOTE:** To fill in the following information, move the **Trackball** to highlight the **Detail** button and press **Set**.

## To Start an Obstetrics Exam (continued)

Table 8-2: Obstetric fields: Detail

Field	Description
Indications	Why the patient needs the ultrasound exam.
Comments	Comments about the exam.

After you complete the patient information, you can begin the scan.

- To change from the Patient Data Entry screen to the Scan screen, do one of the following:
  - On the keyboard, press **Esc**.
  - On the Touch Panel, select **Scan**.
  - On the Control Panel, select **Patient** or **Freeze**.
  - On the Control Panel, press the **B-Mode** key.

The system displays the Scan screen.

- To choose the appropriate probe, select the probe icon on the Touch Panel.
- On the Control Panel, press **Measure**.

The default Obstetrics study is displayed on the Touch Panel.

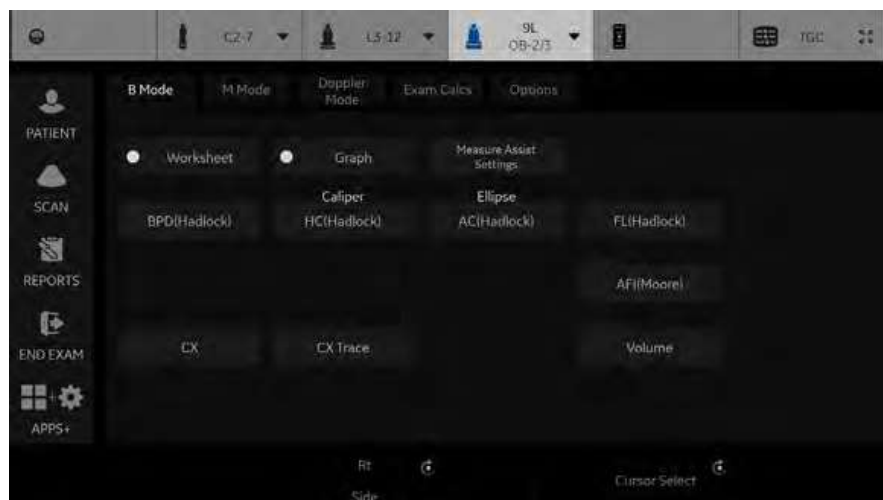

Figure 8-5. OB-General Study

## To choose a study

1. To change the study on the exam category, select **Probe**.  
The Obstetrics exam category allows you to choose from the following studies:
  - Generic
  - OB-1
  - OB-2/3
  - OB-General
  - Fetal Heart
  - OB/GYN Vessel
2. To select a study, select the appropriate study on the Touch Panel.

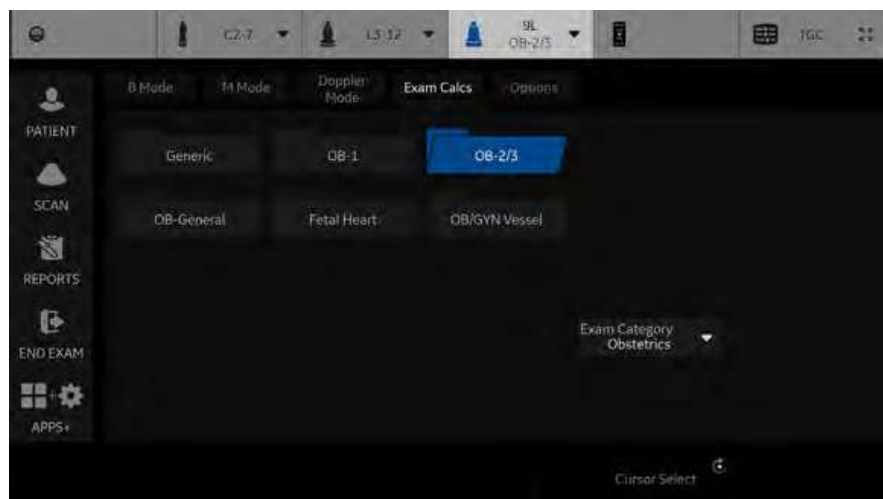

Figure 8-6. OB Study Touch Panel

**NOTE:** *The folders you see on the Touch Panel may be different if your system has been customized.*

## OB Measurements Performed Over Multiple Planes

### Gestational Sac

To calculate the gestational sac, you make three distance measurements in two scan planes. To display two scan planes, press the **L** or **R** key. Get an image in each scan plane and press **Freeze**.

1. Select **GS**; an active caliper displays.
  - a. To position the active caliper at the start point, move the **Trackball**.
  - b. To fix the start point, press **Set**.  
The system fixes the first caliper and displays a second active caliper.
  - c. To position the second active caliper at the end point, move the **Trackball**.  
A dotted line connects the measurement points.
  - d. To complete the measurement, press **Set**.  
The system displays the distance value in the Results Window and displays an active caliper.
2. To make the second and third distance measurement, repeat steps a–d.

After you complete the third distance measurement, the system displays the gestational sac measurement in the Results Window.

To calculate the gestational sac by a one distance measurement:

1. Select **GS**; an active caliper displays.
  - a. To position the active caliper at the start point, move the **Trackball**.
  - b. To fix the start point, press **Set**.  
The system fixes the first caliper and displays a second active caliper.
  - c. To position the second active caliper at the end point, move the **Trackball**.  
A dotted line connects the measurement points.
  - d. To complete the measurement, press **Set**.  
After you complete the measurement, the system displays the gestational sac measurement in the Results Window.

## Amniotic Fluid Index (AFI)

To calculate the amniotic fluid index, you make measurements of the four quadrants of the uterine cavity. The system adds these four measurements together to calculate the Amniotic Fluid Index.

*NOTE: The four quadrants can be measured with distance (caliper) or circumference (circle) measurements. Press the appropriate AFI quadrant Touch Panel key to toggle between caliper and circle.*

1. Select **AFI**.

The first distance measurement, AFI-Q1, is already selected.

2. Make a standard distance measurement for the first quadrant:

a. To position the active caliper at the start point, move the **Trackball**.

b. To fix the start point, press **Set**.

The system fixes the first caliper and displays a second active caliper.

c. To position the second active caliper at the end point, move the **Trackball**.

A dotted line connects the measurement points.

d. To complete the measurement, press **Set**.

The system displays the distance value in the Results Window.

3. When the measurement of the first quadrant is completed, unfreeze and move to the second quadrant.

4. After you obtain the image, press **Freeze** and then **Measure**.

The system prompts you to continue with the AFI measurements. Make sure that the next quadrant has been selected.

## Amniotic Fluid Index (AFI) (continued)

5. Perform a standard distance measurement for the second, third, and fourth quadrants (see step 2).

When all four quadrants have been measured, the system calculates the AFI total and displays it in the Results Window.



### HINTS

- If you unfreeze the image after doing an AFI measurement, the system does not delete the previous measurements. Unfreeze and change scan planes as necessary.
- To specify that an unassigned distance measurement be used for an AFI measurement:
  - Select **AFI**.
  - Press the top **Trackball** key.
  - Move the **Trackball** to highlight the unassigned distance measurement in the Results Window.
  - Select the AFI measurement on the Touch Panel.
- If the fluid in a pocket is zero, set the second caliper on top of the first one to give it a zero value.
- You can measure an AFI quadrant that is zero (0) by pressing **Set** twice.



## OB Calculation

### SonoNT (Nuchal Translucency)

**NOTE:** *This measurement can be adjusted and customized in the system setup.*

To measure the contour detection of the NT border:

1. Select NT. The measurement cursor appears.
2. Select the fetal position ("Face Up" or "Face Down").
3. Position and fix the first point (P1) of the rectangular ROI.
4. Position and enter the second point (P2) of the rectangular ROI. The NT border detection is performed. If a valid result is found, the borders are shown in red and the NT distance is displayed with two crosses.
5. If the measurement is correct according to the guidelines, accept and confirm the result to store in the report. If the system cannot detect a result, a warning message appears.

**NOTE:** *To edit the measurement, move the trackball and/or press Change to readjust the start and end point before accepting the measurement.*

**NOTE:** *It is possible to select the calculation method by pressing Method: (i-i: inner-inner or i-m: inner-middle).*

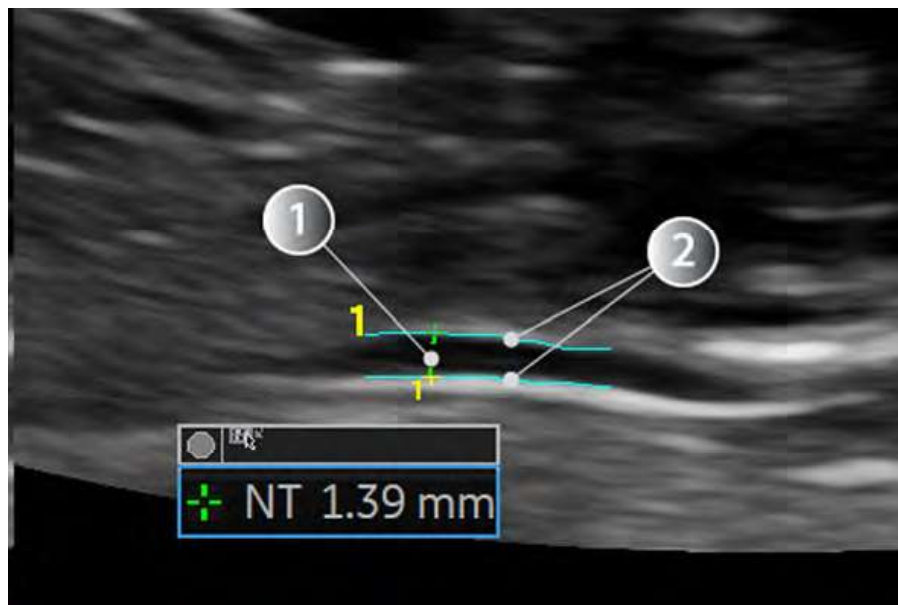

Figure 8-7. SonoNT

1. SonoNT Measurement

2. Detected NT Border

## **SonoNT (Nuchal Translucency) (continued)**

### **SonoIT (Intracranial Translucency)**

SonoIT (Sonography based Intracranial Translucency) is a system supported measurement for Intracranial Translucency. Starting from the routinely used midsagittal view of the fetal face, obtained for assessment of the Nuchal Translucency and nasal bone, the ultrasound system uses a semi-automated mode to measure the anterior-posterior diameter of the fourth ventricle recognizable as intracranial translucency.

The workflow is identical to SonoNT.

## OB Graphs

### Overview

OB Graphs allow you to assess fetal growth compared to a normal growth curve. When a patient has completed two or more ultrasound exams, you can also use the graphs to look at fetal trending. For multi-gestational patients you can plot all fetuses and compare the growth on the graphs.

The LOGIQ Totus provides the following two basic types of graphs:

- **Fetal Growth Curve graphs** – show one measurement per graph. These graphs show the normal growth curve, positive and negative standard deviations or applicable percentiles, and ultrasound age of the fetus using the current measurement. For multi-gestational pregnancies, you can view all fetuses. If previous exam data is available, the graph can show fetal trending.
- **Fetal Growth Bar graph** – shows the ultrasound age and the gestational age based on patient data. Plots all measurements on one graph.

### To View OB Graphs

To view OB graphs:

1. Press **Measure**.
2. Select **Graph**.

The system displays the OB Graph keys.

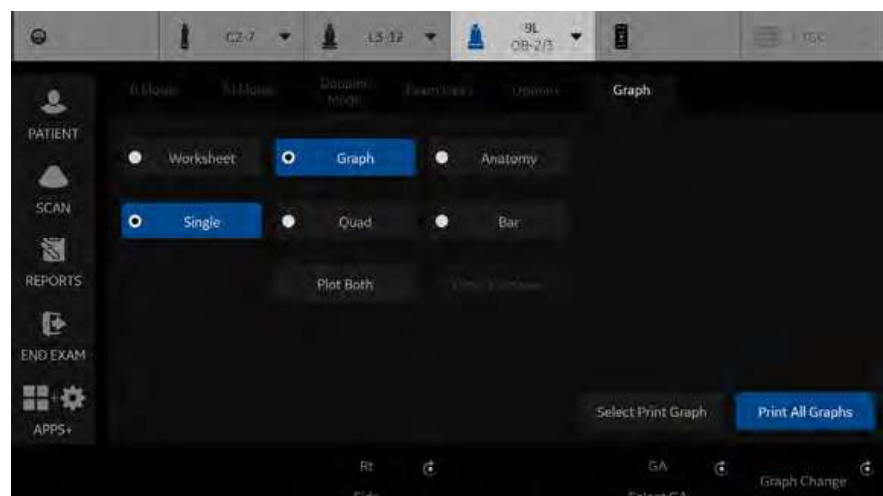

Figure 8-8. OB Graph keys on Touch Panel

## Fetal Growth Curve Graph

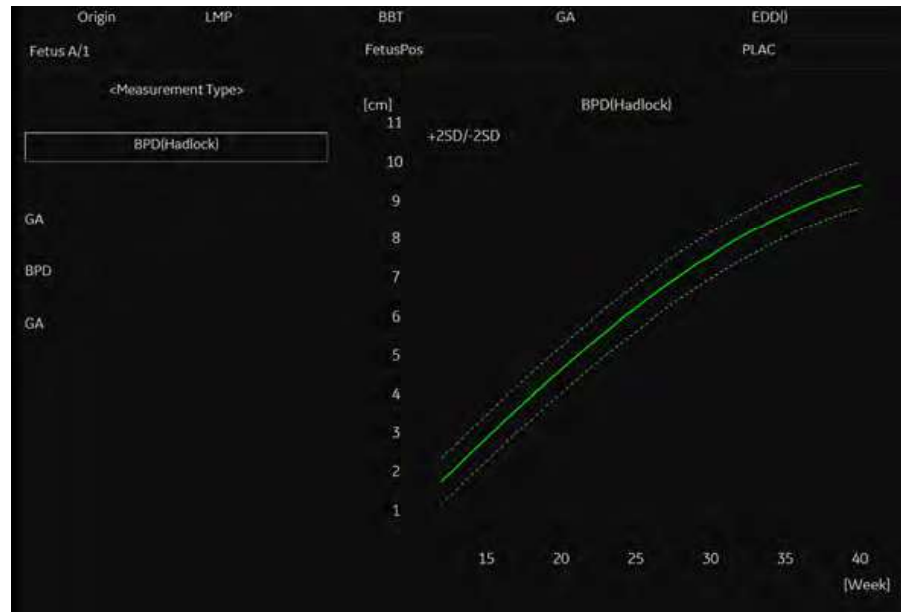

Figure 8-9. Fetal Growth Curve Graph (Single)

The horizontal axis shows the fetal age in weeks. The system determines this age from the data on the Patient Data Entry screen. The vertical axis shows one of the following:

- For measurements, mm or cm
- For ratios, percent
- For fetal weight, grams

The Fetal Growth Curve Graph shows the following information for the selected measurement:

- The normal growth curve
- The standard deviations or relevant percentiles
- The gestational age of the fetus, using patient data (vertical dotted line)
- Using the current ultrasound measurement data, where the fetus is on the growth curve

---

## Fetal Growth Curve Graph (continued)

### To select the measurement

To select which measurement you want to display on the Fetal Growth Curve Graph, do one of the following:

- To select a specific measurement:
  - a. On the graph display, move the **Trackball** to the **Measurement Type** field and press **Set**.  
The system displays a list of measurements.
  - b. Move the **Trackball** to select the desired measurement and press **Set**.  
The system displays the Fetal Growth Curve Graph for the selected measurement.
- To scroll through all Fetal Growth Curve Graphs, adjust the **Graph Change** control.

### To select the age to use

To plot the fetus age, the system allows you to use the gestational age (GA) from the LMP, or to use the composite ultrasound age (CUA). To select, adjust the **Select GA** control. The information in the left column changes between CUA and GA(EDD), and the data may change.

### To view a single or four graphs

You can view either a single Fetal Growth Curve Graph or you can view four graphs at the same time. To select each view, press **Single** or **Quad** to view 4 graphs at once.

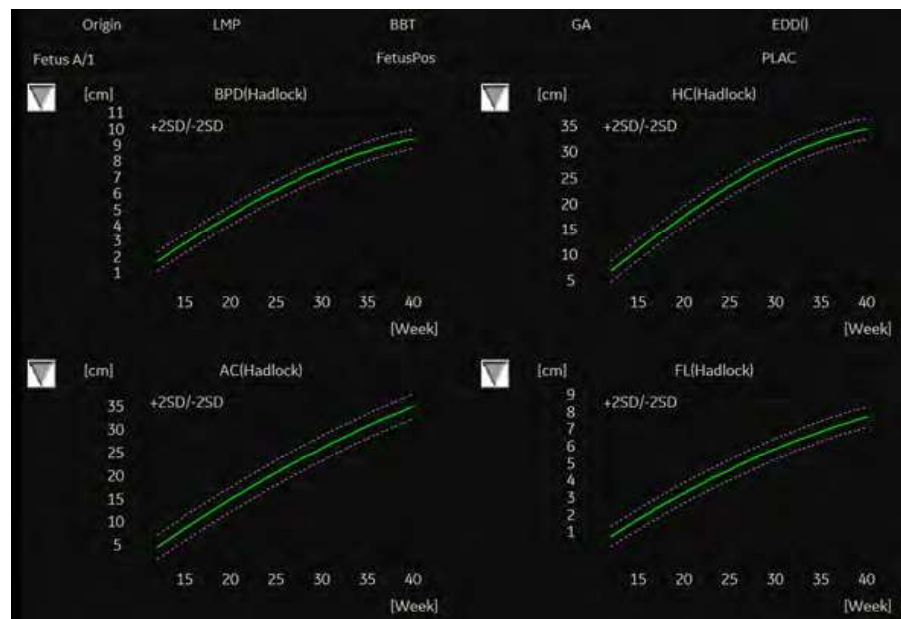

Figure 8-10. Fetal Growth Curve Graph: Quad View

The measurement values are displayed at the bottom of the graph.

---

### To change measurements in quad view

When you view four graphs simultaneously, you can select which four you want to see. To change each graph in quad view:

1. On the graph display, use the **Trackball** to move the cursor to the small box that is upper left of each graph, then press **Set**.

The system displays a list of measurements.

2. Move the **Trackball** to select the desired measurement and press **Set**.

The system displays the Fetal Growth Curve Graph for the selected measurement.

To scroll through all Fetal Growth Curve Graphs, adjust the **Graph Change** control.

The order of a quad graph view can be saved by selecting **Save**.

## Fetal Trending

When you have ultrasound data for more than one exam for a patient, you can use the data to look at fetal trending on the Fetal Growth Curve Graphs.

1. Select **Graph Display** and select the desired Fetal Growth Curve Graph.
2. Select **Plot Both**.

The system automatically finds the data from previous ultrasound exams, and displays it on the graph with the present data.

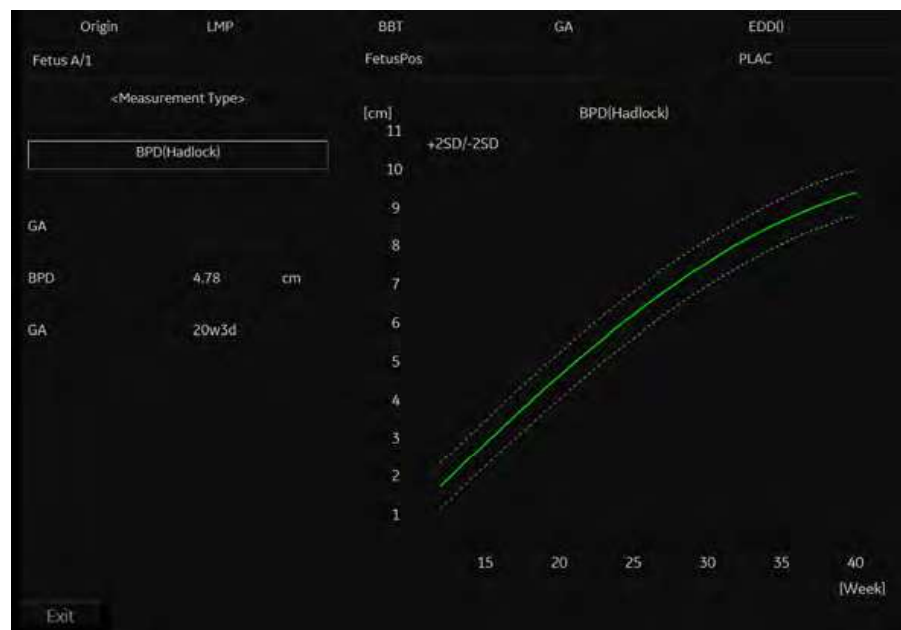

Figure 8-11. Fetal Trending on Fetal Growth Curve Graph

The legend at the bottom of the graph shows the symbols and colors that indicate Past and Present data.



## Fetal Trending (continued)

### To manually enter past exam data

If you have data from a previous ultrasound exam that you want to use for fetal trending, but it is not in the system, you can manually enter the data.

1. After you have registered the patient for this exam, on the Patient Data Entry screen, in the Exam Information (Obstetrics) section, select Past Exam.  
The system displays the Input Past Exam screen. See Figure 8-12.
2. Enter the data from previous exams.
3. To enter data on page 2, select Next.
4. After you enter the previous exam data, select Exit to Save.

The system saves the previous exam data. When you view the Fetal Growth Curve Graphs, select **Plot Both** to view fetal trending. The system automatically uses the data you entered.

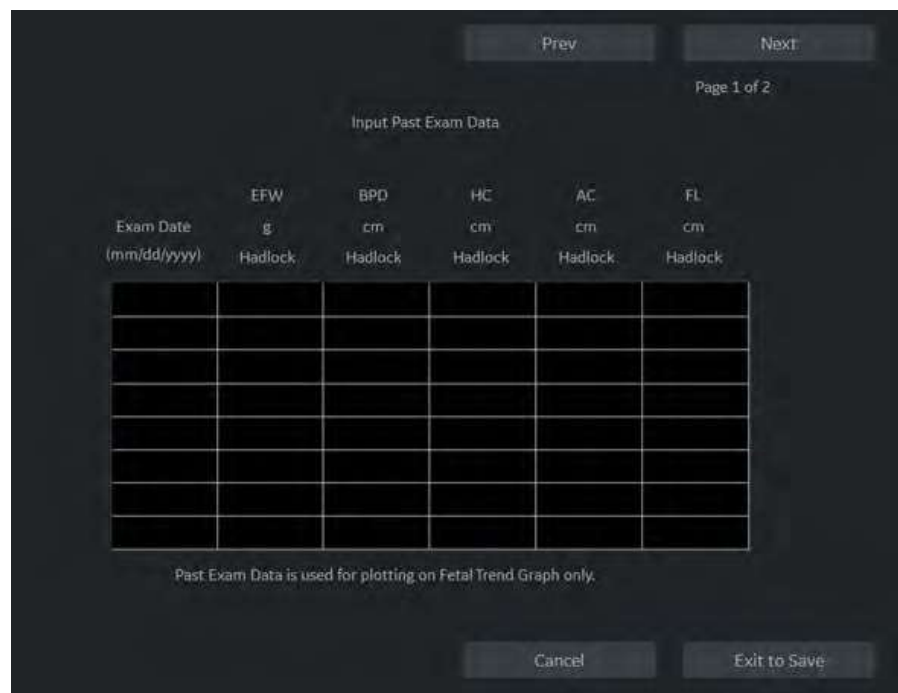

Exam Date (mm/dd/yyyy)	EFW g	BPD cm	HC cm	AC cm	FL cm
Hadlock	Hadlock	Hadlock	Hadlock	Hadlock	Hadlock

Figure 8-12. Input Past Exam screen, page 1

### To edit patient data

When you are working with graphs, you can change or enter the following patient data.

- GA(LMP) – this field is computed using the LMP date on the Patient Data Entry screen. To change this field:

*NOTE:*

*You can only change this field on the Fetal Growth Curve Graph in single view.*

- a. Move the **Trackball** to the field, which is left of the graph. To select the field, press **Set**.  
The system displays a window with the GA weeks and days.
- b. To select each field, move the **Trackball** to the field and press **Set**.
- c. Type the correct weeks or days.
- d. Select OK.

The system makes the following changes:

- GA (LMP) is now GA (GA) and shows the age you entered.
- In the Patient Data section, the GA changes.
- In the Patient Data section, The EDD (LMP) changes to EDD(GA) and shows an updated date, using the GA you entered.

The LMP is erased.

- FetusPos – type information about the fetus position.
- PLAC – type information about the placenta.

### To return from a graph to the scan display

After viewing graphs, to return to the scan display, do one of the following:

- On the graph display, select Exit.
- On the Touch Panel, select **Graph**.

## Fetal Growth Bar Graph

The fetal growth bar graph shows current exam measurements and the normal growth range based on the gestational age. It shows all measurements on one graph.

To view the Fetal Growth Bar Graph:

1. Press **Measure**.
2. Select **Graph**.
3. Select **Bar**.



Figure 8-13. Fetal Growth Bar Graph

- The horizontal axis shows the gestational weeks.
- The red vertical line shows the gestational age using the patient data.
- The blue dotted vertical line shows the ultrasound age using the current measurements.
- The yellow x shows the ultrasound age for each measurement.
- The green rectangle shows the normal age range for the measurement.

You cannot do fetal trending or view multiple gestation data on the bar graph.

## OB-Multigestational

### Multiple Fetus

LOGIQ Totus allows you to measure and report multiple fetus development. The system can report a maximum of four fetuses.

#### To enter the number of fetuses

If more than one fetus is imaged during the exam, enter the number of fetuses in the Patient Data Entry Menu.

The image shows a screenshot of the LOGIQ Totus Patient Data Entry Menu. At the top, there are tabs for different exam types: ABD, OB (selected), GYN, CARD, VAS, UR, SMP, and PED. Below the tabs, there are several input fields for patient data. The 'Fetus #' field is highlighted in blue and contains the number '2'. Other fields include LMP, EDD by LMP, GA by LMP, Gravida, Para, AB, Ectopic, Operator (ADM), Exam Description, Scan Assistant, Accession #, Perf. Physician, and Ref. Physician. At the bottom, there are buttons for 'Start Exam', 'Image', and 'Clear'.

Figure 8-14. Fetus Number

When you start an OB exam, the system automatically fills in the Fetus # field with 1. To change the number:

1. Move the cursor to the fetus number and press **Set** twice.  
The number is highlighted.
2. Type the correct number and press **Set**.  
The system displays a message to confirm that you want to change the fetus number.
3. Select Yes.

## To identify each fetus

For measurements, calculations, and worksheet displays, the system labels each fetus A, B, C, or D. Each fetus is identified by a letter and the total number of fetuses. For example, fetus A/3 is fetus A from a total of 3.

When scanning, you can enter information about the fetus position and placenta location. You can enter the information in the Patient Data section of the worksheets and the graphs. You can type up to 23 characters in the FetusPos and PLAC fields.



Figure 8-15. Patient Data section of the OB Worksheet

## To select a fetus

During measurements and calculations, to change between fetuses, do one of the following:

- Adjust the **Fetus** selection.
- Move the **Trackball** to the Summary Window and select the fetus.

You can change between fetuses at any time during the exam.

**NOTE:** *After you change to the next fetus, any measurements you make are recorded and reported to that fetus. If you have any active measurement or calculation that is not completed when you change the fetus, the system cancels the measurement or calculation.*

## To view multiple fetuses data on graphs

You can view multiple gestation data on fetal growth curve graphs. After you have made measurements for each fetus, select **Graph**.

1. To view the graph for each fetus, do one of the following:
  - Adjust the **Fetus** selection.
  - In the Patient Data section, move the **Trackball** to highlight the FetusNo field. In the list of fetuses, move the **Trackball** to select the fetus you want, and press **Set**.
2. To display data for multiple fetuses on the same graph, select **Fetus Compare**.

The legend at the bottom of the graph shows the symbols and colors that represent each fetus.

### To compare multiple fetus data on a worksheet

With multiple fetuses, you can list and compare measurements of the fetuses on the worksheet.

Select **Worksheet**, then select **Fetus Compare**.

When you select **Fetus Compare**, the system lists the measurement results for each fetus on the Worksheet.

### To Show Fetal Trending for Multiple Fetuses

When you have data for more than one exam, you can show fetal trending and compare fetuses on one graph.

To view fetal trending for multiple fetuses:

1. Select **Graph**.
2. Select **Fetus Compare**.
3. Select **Plot Both**.

**NOTE:** *You can only view fetal trending for multiple fetuses in single graph display.*

The symbol key for fetal trending and multiple fetuses is shown at the bottom of the graph.

## OB Table Editor

You can add user programmable OB tables to the system.

## OB Table Settings Menu

You add OB Tables in the Measurement & Analysis menu. To open the menu:

1. On the Touch Panel, select **Utility**, then select **M&A**.
2. Check the Exam Category on the far left of the monitor screen. Make sure that Obstetrics is selected.

If it is not selected, select Obstetrics and continue selecting the folders until the appropriate area is selected as to where this new OB Table will be entered. For example, select Obstetrics, then select OB-2/3. If there are further folders within OB-2/3, select that appropriate folder.

## OB Table Settings Menu (continued)

- On the monitor display, select the OB Table tab.  
The system displays the OB Table settings menu.

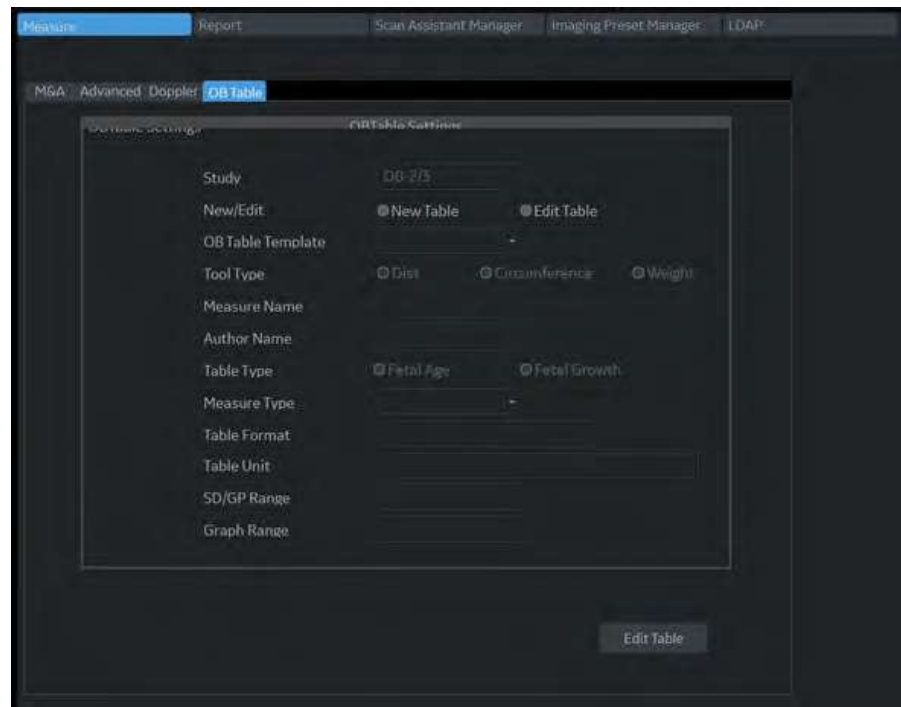

Figure 8-16. OB Table settings

- The OB Table settings menu lists OB Table parameters. Specify the following parameter values as appropriate:
  - Study:** Shows the study to which this measurement table belongs.
  - New/Edit:** To create a new OB table, select New Table. To edit an existing user-programmable OB table, select Edit Table.

**NOTE:** *You cannot edit the system's OB Tables.*

## OB Table Settings Menu (continued)

- **OB Table Template:** To create a new OB table, select the Template (1 - 7) which you want to use as the basis of the user programmable OB Table. See 'OB Table Templates' on page 8-31 for more information.  
To edit an existing user OB table, select the desired OB table to edit.
- **Tool Type:** Select the type of measurement: Distance or Circumference.
- **Measure Name:** Type the name of measurement that will display on the Touch Panel.
- **Author Name:** Type the author's name.
- **Table Type:** If necessary, select the Table Type: Fetal Age or Fetal Growth.
- **Measure Type:** Select a measurement type that can be used to calculate EFW, for example BPD.

*NOTE: Measure Type is used only when calculating EFW.*

*NOTE: The following items are display only: Table Format, Table Unit, SD/GP Range, and Graph Range. The system determines these values automatically, based on the type of OB table you are creating.*

5. After specifying all parameter values, move the **Trackball** to *Edit Table* and press **Set**.

The system displays the Edit Menu.

*NOTE: If any of the OB table parameters are not correct, the Edit Menu is not displayed.*



## OB Table Templates

Tool Type:

- Distance: 2D Caliper
- Circumference: 2D Ellipse, 2D Trace, 2D Caliper

### Template 1

Table 8-3: Template 1 (based on Hadlock)

Template 1: SD Range Table				
Fetal Age Table	Table Format	MEAS	MEAN	SD
	Table Unit	mm	Week	Week
	Table Range	1SD		
	Graph Range	1SD		
Measurement Result	Value [cm]			
	GA [#w#d]			
	Min [#w#d]			
	Max [#w#d]			
Fetal Growth Table	Table Format	AGE	MEAN	SD
	Table Unit	Week	mm	Week
	Others are same as above			

Template 2

Table 8-4: Template 2 (based on Tokyo)

Template 2: SD Range Table				
Fetal Age Table	Table Format	MEAS	MEAN	SD
	Table Unit	mm	Day	Day
	Table Range	1SD		
	Graph Range	1SD		
Measurement Result	Value [cm]			
	GA [#w#d]			
	SD: day(+/-)			
	EDD (Date)			
	GA-Min [#w#d]			
	GA-Max [#w#d]			
Fetal Growth Table	Table Format	AGE	MEAN	SD
	Table Unit	Day	mm	Day
	Others are same as above			

### Template 3

Table 8-5: Template 3 (based on Osaka)

Template 3: SD Table				
Fetal Age Table	Table Format	MEAS	MEAN	SD
	Table Unit	mm	Day	mm
	Table Range	1SD		
	Graph Range	1SD		
Measurement Result	Value [cm]			
	GA [#w#d]			
	SD: $sd=(mv-pv)/sd$			
	EDD (Date)			
	GA-Min [#w#d]			
	GA-Max [#w#d]			
Fetal Growth Table	Table Format	AGE	MEAN	SD
	Table Unit	Day	mm	mm
	Others are same as above			

**Template 4**

Table 8-6: Template 4 (based on several European tables)

Template 4: 5%-95% Table					
Fetal Age Table	Table Format	MEAS	MIN	MEAN	MAX
	Table Unit	mm	WeekDay	WeekDay	WeekDay
	Table Range	5%:95%			
	Graph Range	5%:95%			
Measurement Result	Value [cm]				
	GA [#w#d]				
	GP [%] GP is calculated by Fetal Growth Table. If you did not edit Growth Table, GP is not calculated by the system,				
	EDD (Date)				
	GA-Min [#w#d]				
	GA-Max [#w#d]				
Fetal Growth Table	Table Format	AGE	MIN	MEAN	MAX
	Table Unit	WeekDay	mm	mm	mm
	Table Range	5%:95%			
	Graph Range	5%:95%			

**Template 5**

Table 8-7: Template 5 (based on several European tables)

<b>Template 5: 5% - 95% Table</b>				
Fetal Age Table	Table Format	MEAS	MEAN	SD
	Table Unit	mm	WeekDay	mm
	Table Range	1SD		
	Graph Range	5%:95%		
Measurement Result	Value [cm]			
	GA [#w#d]			
	GP [%] GP is calculated by Fetal Growth Table. If you did not edit Growth Table, GP is not calculated by the system,			
	EDD (Date)			
	GA-Min [#w#d]			
	GA-Max [#w#d]			
Fetal Growth Table	Table Format	AGE	MEAN	MAX
	Table Unit	WeekDay	mm	mm
	Table Range	1SD		
	Graph Range	5%:95%		

**Template 6**

Table 8-8: Template 6 (based on several European tables)

Template 6: 5%-95% Table					
Fetal Age Table	Table Format	MEAS	MIN	MEAN	MAX
	Table Unit	mm	WeekDay	WeekDay	WeekDay
	Table Range	10%:90%			
	Graph Range	10%:90%			
Measurement Result	Value [cm]				
	GA [#w#d]				
	GP [%] GP is calculated by Fetal Growth Table. If you did not edit Growth Table, GP is not calculated by the system,				
	EDD (Date)				
	GA-Min [#w#d]				
	GA-Max [#w#d]				
Fetal Growth Table	Table Format	AGE	MIN	MEAN	MAX
	Table Unit	WeekDay	mm	mm	mm
	Table Range	10%:90%			
	Graph Range	10%:90%			

**Template 7**

Table 8-9: Template 7 (Based on several European tables)

<b>Template 7: 10% - 90% Table</b>				
Fetal Age Table	Table Format	MEAS	MEAN	SD
	Table Unit	mm	WeekDay	mm
	Table Range	1SD		
	Graph Range	10%:90%		
Measurement Result	Value [cm]			
	GA [#w#d]			
	GP [%] GP is calculated by Fetal Growth Table. If you did not edit Growth Table, GP is not calculated by the system,			
	EDD (Date)			
	GA-Min [#w#d]			
	GA-Max [#w#d]			
Fetal Growth Table	Table Format	AGE	MEAN	MAX
	Table Unit	WeekDay	mm	mm
	Table Range	1SD		
	Graph Range	10%:90%		

## OB Table Edit Menu

The data you enter in the OB Table Edit Menu depends on whether the table type is Fetal Age or Fetal Growth.

### Fetal Age Table

If you are creating or editing a Fetal Age table, the OB Table Edit Menu is as follows:

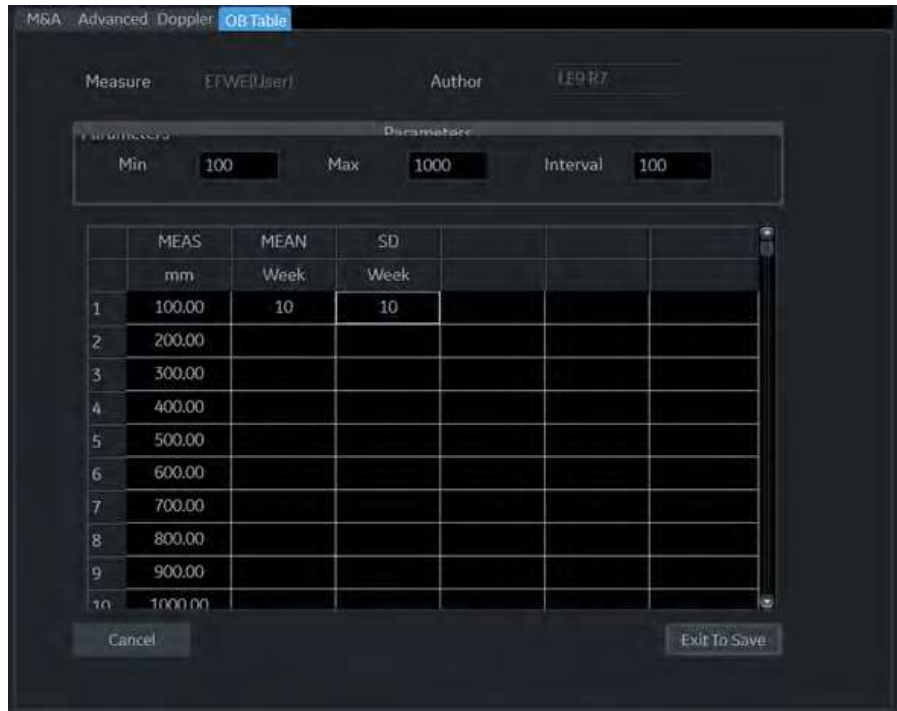

Figure 8-17. OB Table Edit Menu: Fetal Age Table

### Complete the field

1. Input value to Min, Max and Interval of the Parameters field. The system automatically fills in the MEAS column. Input value to the columns of MEAN and SD.

**NOTE:** To move between the fields in the table, use the up, down, left, and right arrow keys.

**NOTE:** You must enter a minimum of two rows of data. Any lines with a blank cell are not saved.

To save the Table Data, move the **Trackball** to Exit to Save and press **Set**. If you want cancel this table, move the **Trackball** to Cancel and press **Set**.



## Fetal Growth Table

If you are creating or editing a Fetal Growth table, the OB Table Edit Menu is as follows:

	MEAS	MEAN	SD			
	mm	Week	Week			
1	100.00	10	10			
2	200.00					
3	300.00					
4	400.00					
5	500.00					
6	600.00					
7	700.00					
8	800.00					
9	900.00					
10	1000.00					

Figure 8-18. OB Table Edit Menu: Fetal Growth Table

### Complete the field

1. Input value to the required columns.

**NOTE:** To move between the fields in the table, use the up, down, left, and right arrow keys.

**NOTE:** You must enter a minimum of two rows of data. Any lines with a blank cell are not saved.

2. To save the Table Data, move the **Trackball** to Exit to Save and press **Set**. If you want cancel this table, move the **Trackball** to Cancel and press **Set**.

After you complete the OB table, it is now available for the selected study. To use the measurement, you must assign it to a Touch Panel. See 'Measurement and Calculation Setup' on page 7-74 for more information.

## EFW for OB User Table/Formula Editor

### EFW Table Editor

You can edit an EFW Formula at the OB Table Editor.

1. Select Utility -> Measure -> OB Table.
2. Select the appropriate parameters and press **Edit Table**.
  - New/Edit: Select “New Table”
  - OB Table Template: Select appropriate template.
  - Tool Type: Select “Weight”
  - Measure Name: Enter measurement name.
  - Author Name: Enter author’s name.
  - Table Type: Select “Fetal Age”

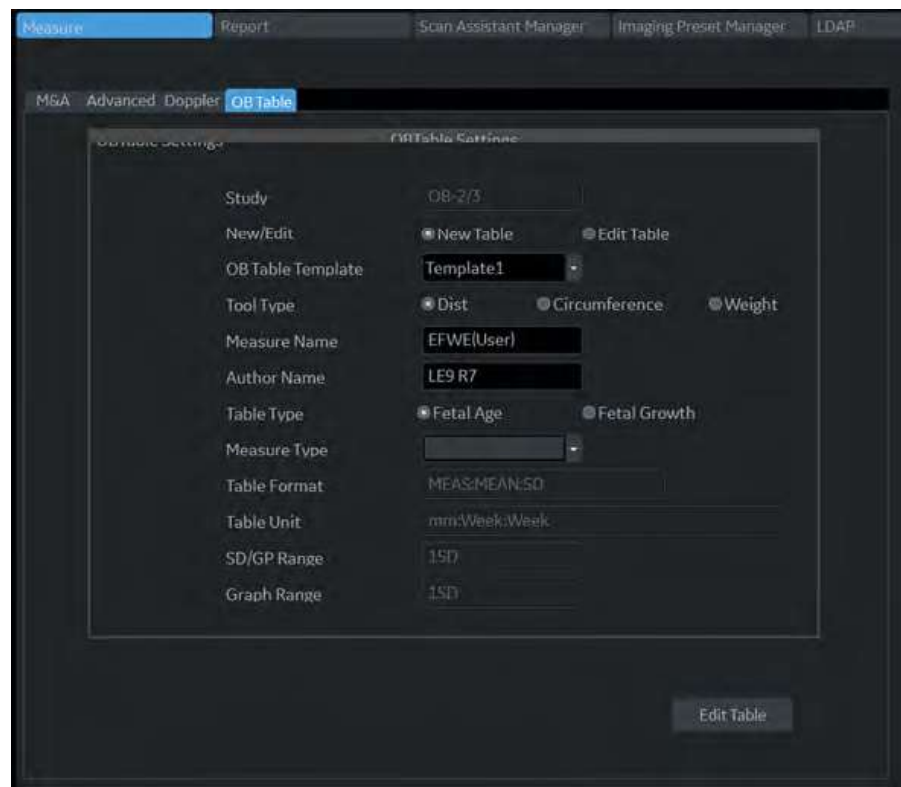

Figure 8-19. OB Table Tab Screen

## EFW Table Editor (continued)

3. Edit the table data and press **Exit To Save**.

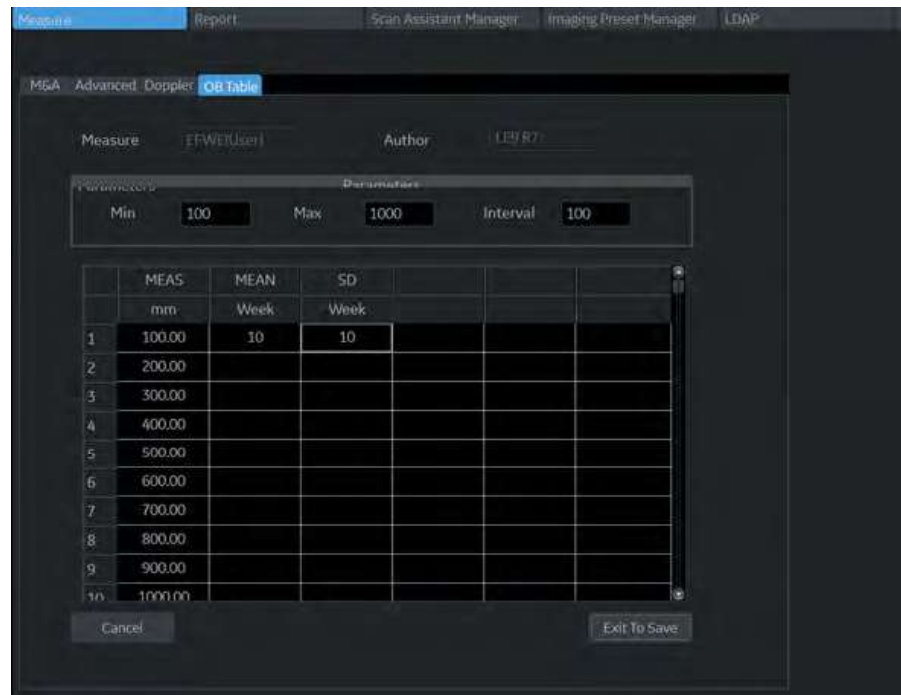

Figure 8-20. OB Table Editor Screen

## EFW Formula Editor

1. Select the M&A tab and select **Edit Calc**. The Modify User CALC window displays.  
Select the user table previously added from the User Defined pull-down menu and press **OK**.
2. Select the “Calculated” button for the EFW parameter.
3. The EDIT FORMULA window displays. Edit the formula and select **OK**.

**NOTE:** When you edit a formula, be careful of the following points.

- If you want to calculate EFW by centimeter, add “ \*100 ” to the {parameter}.
- If EFW is calculated in grams, add “ /1000 “ to the formula.

or example,

$$10^{(1.56\{AC[Hadlock]\} * 100 + 0.08 * \{FL[Hadlock]\} * 100) / 1000}$$

## Introduction

The Gynecology exam category includes the following three studies:

- Generic. This study is common to all exam categories. 'Generic Measurements' on page 7-18.
- General Gynecology. This study includes uterine, ovarian, ovarian follicle, and endometrium measurements.
- OB/GYN Vessel. This study includes the following vessels: uterine, ovarian, umbilical, middle cerebral artery, aorta, placenta, and descending aorta.

*NOTE: The calculation formulas are listed in the Advanced Reference Manual.*

## B-Mode Measurements

In B-Mode, you make the measurements in the General Gynecology study. These measurements include:

- Ovarian follicle
- Endometrium thickness
- Ovarian length, width, and height
- Uterine length, width, and height
- Cervix
- Fibroid

## Follicle measurements

You can make left and right ovary follicle measurements from one, two, or three distances.

To select the left or right, adjust the **Side** selection.

## Endometrium thickness

To measure the endometrium thickness, make one distance measurement.

1. Select **Endometrium**; an active caliper displays.
2. To position the active caliper at the start point, move the **Trackball**.
3. To fix the start point, press **Set**.  
The system fixes the first caliper and displays a second active caliper.
4. To position the second active caliper at the end point, move the **Trackball**.  
A dotted line connects the measurement points.
5. To complete the measurement, press **Set**.

The system displays the endometrium thickness in the Results Window.

## **Ovary length, width, and height**

You can measure the length, width, and height of the left and right ovaries. Each measurement is a typical distance measurement made in the appropriate scan plane.

Typically, length and height are measured on the sagittal plane while the width is measured on the axial/transverse plane.

To measure ovarian length, width, or height:

1. Scan the patient's right or left ovary in the appropriate plane.
2. To select left or right, adjust the **Side** selection.
3. Select the **OV** folder, then select **OVL**, **OVW**, or **OVH**.
4. Perform a standard distance measurement.

## **Uterus length, width, and height**

Each of these is a standard distance measurement. Typically, length and height are measured on the sagittal plane while the width is measured on the axial/transverse plane.

To measure uterus length, width, or height:

1. Scan the patient in the appropriate scan plane.
2. Select the **UT** folder, then select **UTL**, **UTW**, or **UTH**.  
An active caliper displays.
3. Perform a standard distance measurement.

## **Cervix measurements**

You can make cervix measurements from one distance or spline trace.

# Cardiac

## Overview

Cardiology measurements offer two different types of measurement studies, Generic and Cardiac.

- Generic—Common to all applications. See ‘Generic Measurements’ on *page 7-18 for more information..*
- Cardiac – This study includes all cardiac measurements.

## Naming Format for Cardiac Measurements

When you make a measurement, on the Touch Panel you select the abbreviation for the measurement. Most abbreviations are made using acronyms. The following table lists acronyms used for naming cardiac measurements.

Table 8-10: Cardiology Abbreviations

Acronym	Name
% STIVS	% Interventricular Shortening
A	Area
Acc	Acceleration
AccT	Flow Acceleration Time
ALS	Aortic Leaflet Separation
Ann	Annulus
Ao	Aorta
AR	Aortic Regurgitation
Asc	Ascending
ASD	Atrial Septal Defect
AV	Aortic Valve
AV Cusp	Aortic Valve Cusp Separation
AVA	Aortic Valve Area
AV-A	Aortic Valve Area by Continuity Equation

Table 8-10: Cardiology Abbreviations (Continued)

Acronym	Name
BSA	Body Surface Area
CI	Cardiac Index
CO	Cardiac Output
d	Diastolic
D	Diameter
Dec	Deceleration
DecT	Deceleration Time
Desc	Descending
Dur	Duration
EdV	End Diastolic Volume
EF	Ejection Fraction
EPSS	E-Point-to-Septum Separation
EsV	End Systolic Volume
ET	Ejection Time
FS	Fractional Shortening
FV	Flow Volume
FVI	Flow Velocity Integral
HR	Heart Rate
IVRT	IsoVolumetric Relaxation Time
IVS	Interventricular Septum
L	Length
LA	Left Atrium
LAA	Left Atrium Area
LAD	Left Atrium Diameter
LPA	Left Pulmonary Artery
LV	Left Ventricle
LVA	Left Ventricular Area
LVID	Left Ventricle Internal Diameter
LVL	Left Ventricle Length
LVM	Left Ventricular Mass



Table 8-10: Cardiology Abbreviations (Continued)

Acronym	Name
LVPW	Left Ventricle Posterior Wall
ML	Medial to Lateral
MPA	Main Pulmonary Artery
MR	Mitral Regurgitation
MV	Mitral Valve
MVcf	Mean Velocity Circumferential Fiber Shortening
MVO	Mitral Valve Orifice
OT	Outflow Tract
P	Papillary Muscles
PA	Pulmonary Artery
PAP	Pulmonary Artery Pressure
PDA	Patent Ductus Arteriosis
PEP	Pre-Ejection Period
PFO	Patent Foramen Ovale
PG	Pressure Gradient
PHT	Pressure Half Time
PI	Pulmonary Insufficiency
PISA	Proximal Isovelocity Surface Area
PR	Pulmonic Regurgitation
PV	Pulmonic Valve
PV-A	Pulmonic Valve Area by Continuity Equation
PVein	Pulmonary Vein
PW	Posterior Wall
Qp	Pulmonic Flow or CO
Qs	Systemic Flow or CO
RA	Right Atrium
RAA	Right Atrium Area
Rad	Radius
RAD	Right Atrium Diameter
RPA	Right Pulmonary Artery

Table 8-10: Cardiology Abbreviations (Continued)

Acronym	Name
RV	Right Ventricle
RVA	Right Ventricle Area
RVAW	Right Ventricle Anterior Wall
RVD	Right Ventricle Diameter
RVID	Right Ventricle Internal Diameter
RVL	Right Ventricle Length
RVOT	Right Ventricle Outflow Tract
s	Systolic
SI	Stroke Index
ST	Shortening
SV	Stroke Volume
SVI	Stroke Volume Index
T	Time
TA	Tricuspid Annulus
TAML	Tricuspid Annulus Medial to Lateral
TR	Tricuspid Regurgitation
TV	Tricuspid Valve
TVA	Tricuspid Valve Area
Vcf	Velocity Circumferential Fiber Shortening
Vel	Velocity
VET	Valve Ejection Time
Vmax	Maximum Velocity
Vmean	Mean Velocity
VSD	Ventricular Septal Defect
VTI	Velocity Time Integral

In this manual, the abbreviation for each measurement is listed in parenthesis after the measurement, as follows:

- Aortic Root Diameter (**Ao Diam**)
- Left Ventricle Posterior Wall Thickness, Diastolic (**LVPWd**)

For example, to measure the Aortic Root Diameter, you select **Ao Diam** on the Touch Panel.

---

## Cardiac Doppler Measurements

### E/E' Ratio

The ratio of early transmitral velocity to early diastolic velocity of the mitral annulus (E/E') is measured in Doppler Mode and TVD mode.

1. First, measure MV E/A Velocity to get "E".
2. Measure E'.

The system calculates E/E' ratio automatically.

## Introduction

Vascular measurements offer several different types of measurement studies:

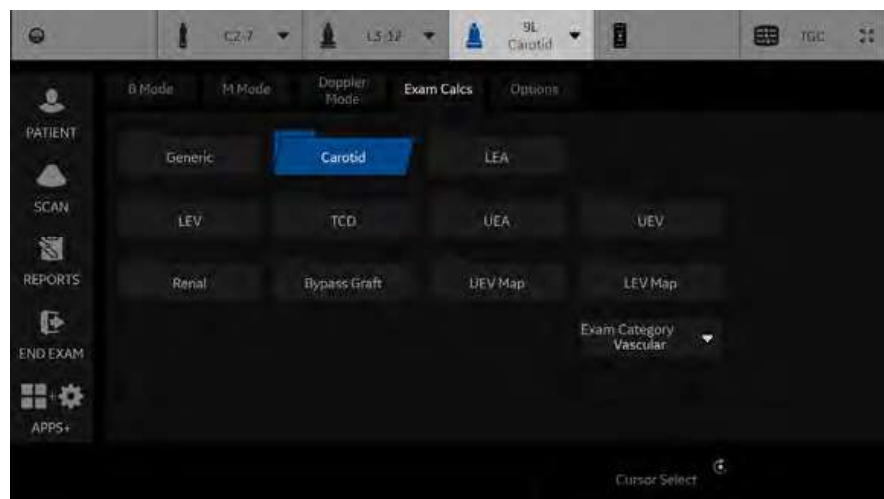

Figure 8-21. Vascular Exam Category Touch Panel

- Generic – Common to all applications. See ‘Generic Measurements’ on *page 7-18 for more information..*
- Carotid
- LEA (Lower Extremity Artery)
- LEV (Lower Extremity Vein)
- TCD (Trans Cranial Doppler)
- UEA (Upper Extremity Artery)
- UEV (Upper Extremity Vein)
- Renal
- Bypass Graft
- UEV (Upper Extremity Vein) Map
- LEV (Lower Extremity Vein) Map

## Introduction (continued)

A vascular study is a group of particular vessels. You can customize the vessel exam calcs in the configuration menu. See 'Measurement and Calculation Setup' on *page 7-74 for more information.*

When you use Auto Vascular calculation, you use the vessel keys on the Touch Panel to post-assign vascular calculations. When you are not using Auto Vascular calculation, the vessel key is used for manual measurement.

## Naming format for vessels

When you want to measure a vessel, on the Touch Panel you select the folder for the vessel. Many vessel folders are labeled with an abbreviation. The following table lists abbreviations used for naming vascular vessels.

Table 8-11: Vascular Vessel Abbreviations

Acronym	Name
ACA	Anterior Cerebral Artery
Acc RA	Accessory Renal Artery
AComA	Anterior Communicating Artery
Anast	Anastomosis
ArcA	Arcuate Artery
ATA	Anterior Tibial Artery
ATV	Anterior Tibial Vein
AVF	Arteriovenous Fistula
Axill	Axillary Artery
Axill V	Axillary Vein
BA	Basilar Artery or Brachial Artery
Bas V	Basilic Vein
BasV Antecub	Basilic Vein Antecubital Fossa
BIF IMT F/N	Bifurcation Intima Media Thickness Far/Near
Brac V	Brachial Vein
CA	Celiac Artery
CCA	Common Carotid Artery

Table 8-11: Vascular Vessel Abbreviations (Continued)

Acronym	Name
Ceph V	Cephalic Vein
Ceph V Antecub	Cephalic Vein Antecubital
CFA	Common Femoral Artery
CFV	Common Femoral Vein
CHA	Common Hepatic Artery
Com Femoral	Common Femoral Artery
CIA	Common Iliac Artery
CIV	Common Iliac Vein
Com Iliac A	Common Iliac Artery
DFA	Deep Femoral Artery
DFV	Deep Femoral Vein
Dors Pedis	Dorsalis Pedis
DPA	Dorsalis Pedis Artery
ECA	External Carotid Artery
EIA	External Iliac Artery
EIV	External Iliac Vein
Fr. Branch	Frontal Branch
FV	Femoral Vein
GBWall	Gall Bladder Wall
GDA	Gastroduodenal Artery
GR	Graft
GSV	Greater Saphenous Vein
HA	Hepatic Artery
Hilar A	Hilar Artery
HV	Hepatic Vein
IIA	Internal Iliac Artery
IIV	Internal Iliac Vein
ICA	Internal Carotid Artery (Transcranial Doppler)
ICA	Interior Carotid Artery (Carotid Artery)
IJV	Internal Jugular Vein

Table 8-11: Vascular Vessel Abbreviations (Continued)

Acronym	Name
IMA	Inferior Mesenteric Artery
IMT	Intima Media Thickness
IMV	Inferior Mesenteric Vein
Inn	Innominate
Int. Lobular A	Interlobular Artery
IVC	Inferior Vena Cava
LSV	Lesser Saphenous Vein
MCA	Middle Cerebral Artery
Mcub V	Median Cubital Vein
Mid Hep V	Middle Hepatic Vein
MPV	Main Portal Vein
MRA	Main Renal Artery
Par. Branch	Parietal Branch
PCA	Posterior Cerebral Artery
PCoMA	Posterior Communicating Artery
Peron	Peroneal
POP	Popliteal
Pseudo	False Artery (aneurysm)
PTA	Posterior Tibial Artery
PTV	Posterior Tibial Vein
PV	Portal Vein
RA	Renal or Radial Artery
RV	Renal or Radial Vein
SA	Splenic Artery
Sap Fem Junc	Sapheno-Femoral Junction
Seg. A	Segmental Artery
SFA	Superficial-Femoral Artery
SFJV	Sapheno-Femoral Junction Vein
SMA	Superior Mesenteric Artery
SMV	Superior Mesenteric Vein

Table 8-11: Vascular Vessel Abbreviations (Continued)

Acronym	Name
SSV	Small Saphenous Vein
STA	Superficial Temporal Artery
SUBC	Subclavian Artery
SUBC V	Subclavian Vein
SV	Splenic Vein
SV Pop Junc	Small Saphenopopliteal Junction
TCD	Transcranial Doppler
TIPS	Transjugular Intrahepatic PortalSystemic Shunt
UA	Ulnar Artery
UV	Ulnar Vein
VERT	Vertebral Artery
VES	Vessel



## IMT Measurement

You can measure the average of the intima media thickness for use as the index of arterial sclerosis.

IMT can be measured both on the posterior and the anterior walls of the vessel.

**NOTE:** *Due to the physical properties of ultrasound imaging, the posterior IMT measurement is generally more accurate than the anterior IMT measurement.*

### IMT Measurement - Auto

Auto IMT automatically measures the thickness of the Intima Media on the far and near vessel walls. Near Wall IMT is the distance between the trailing edges of the adventitia and intima; the Far Wall IMT is the distance between the leading edges of the adventitia and intima.

Set up the parameters you want to record on the worksheet on the Utility -> Measure -> M&A page while are in the Carotid application. Select CCA/ICA/BIF -> IMT Far/Near -> Parameter (Average, Max, Min, Standard Deviation, Points, or Distance).

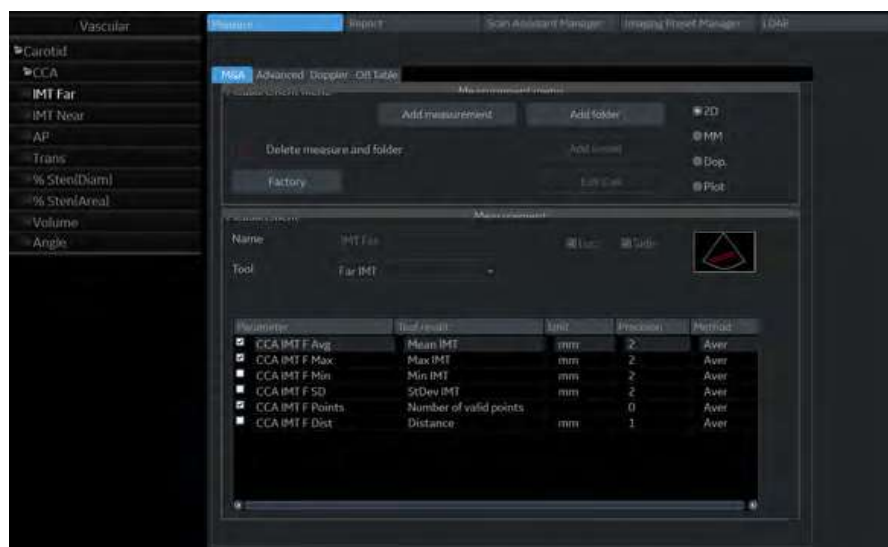

Figure 8-22. Configuring Auto IMT

**IMT Measurement - Auto (continued)**

In the Vascular Carotid application, the Auto IMT measurement is available.



Figure 8-23. Auto IMT Touch Panel

The following controls are available.

Table 8-12: Auto IMT Touch Panel Description

Parameter	Description
Worksheet	Select to view the Worksheet
IMT Far	Select to begin the Far Field IMT measurement.
IMT Near	Select to begin the Near Field IMT measurement.
AP	Anterior Posterior
Trans	Transverse
Length/Offset Rotary	Push to save Length/Offset as a preset. -40/+40 Length. At zero, you can freely adjust the length, but only vertically. Press key to save value as default. Offset distance, -20 (Left) / +20 (Right)
Overall / IMT Trace Fit / Intima	Adjusts (remeasures) the IMT automatically measured by the system.
Rt / Lt Side	Select Left / Right Side.
Cursor Select	Allows you to update cursor placement.

## IMT Measurement - Auto (continued)

To measure the IMT,

1. In the Carotid application, press **Freeze**, press **Measure**.
2. Position the cursor, then select **IMT Far**.
3. Use the **Trackball** to set the length.

Or

Use the **Length / Offset** control on the Touch Panel to set the length and offset distance. The Offset key controls how far away from the vertical line the measurement starts.

Length is the length of the tool itself. If set to zero, you can adjust it anywhere on the image.

4. Press **Set**.

You can either adjust the trace prior to pressing the Print key or press the Print key to store the image which also saves the measurement to the Worksheet.

To adjust the trace, use the **Overall IMT Trace Fit Intima** control on the Touch Panel. The Trace fit (up/down) adjusts the inter luminal line whereas the overall (rotate) adjusts both IMT lines.

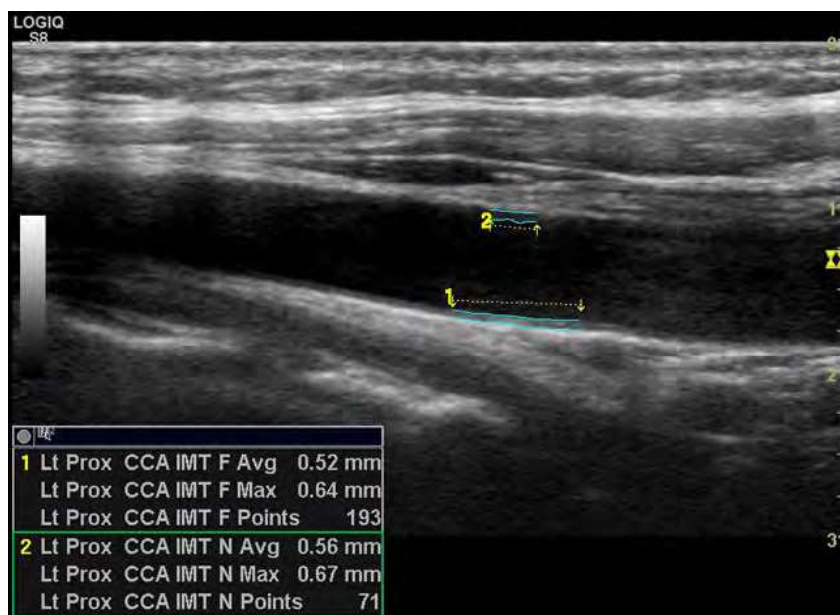

Figure 8-24. Example of Auto IMT Far Measurement

## IMT Measurement - Auto (continued)

5. Position the cursor, then select IMT Near.
6. Use the **Trackball** to set the length.

Or

Use the **Length / Offset** control on the Touch Panel to set the length and offset distance.

7. Press **Set**. “Store image to accept IMT measurement” displays in the message area. If the traces fit both layers of the wall, approve the measurement by pressing the **Print** key to store the image.

To adjust the trace prior to pressing the Print key, use the IMT Trace Fit control on the Touch Panel. The measurement is saved to the Worksheet.

*NOTE: Since the IMT measurements are semi-automatic, the operator has to approve the detection by visual inspection before storing the results in the worksheet and report.*

## IMT Measurement - Manual

1. Before you measure the IMT, add the IMT measurement to the Carotid folder via the Measurement & Analysis screen (by selecting one of the three types of IMT measurements under Add Measurement in the M&A screen).
  - IMT: Three vertical lines are parallel. Place the start point on the line and place the end point anywhere.
  - IMT2: Each vertical line can be rotated with the **Ellipse** control. You must place the start and end points on the line.
  - 5mm Scale: The horizontal line can be rotated with the **Ellipse** control. A maximum of 20 distance values which produce one average value can be taken. The number of distance values is specified when adding the measurement in the M&A screen.

IMT and IMT2 have three kinds of measurements:

- IMT --+/IMT2 --+: Measure from right to left.
  - IMT -+-/IMT -+ -: First measure at the center, then right and left are last.
  - IMT+-/IMT2 --+: Measure from left to right.
2. Acquire a longitudinal scan of the carotid artery and optimize the image. Then press **Freeze**.
  3. Scroll to an end-diastolic frame where the intima layer is clearly visible.

## IMT Measurement - Manual (continued)

- Press **Measure**, then select **IMT1**, **IMT2** or **5mm scale**. An active caliper displays.



Figure 8-25. IMT caliper (Example)

- Use the **Trackball** to move the caliper and the **Ellipse** control to adjust the angle. Press **Set** to fix the caliper.

**NOTE:** *The interval of the vertical line for IMT1 and IMT2 is 1cm and for the 5mm scale is 5mm.*

- Measure the thickness of three points for IMT1 and IMT2.  
OR

Measure the thickness of the specified number of points for the 5mm scale.

**NOTE:** *The caliper moves to the next point automatically.*

## IMT Measurement - Manual (continued)

7. After you complete the measurement, the system calculates the average automatically.



Figure 8-26. IMT Measurement

## IMT Measurement - Manual C(10)

1. Before you measure the IMT C10, create the IMT C10 measurement in the Carotid folder via the Measurement & Analysis screen.
  - IMT C10: Two vertical lines are parallel. One is the base line. Each vertical line can be rotated with the Ellipse control. Place the start point on the line and place the end point anywhere.
  - IMT2 C10: Two vertical lines are parallel. One is the base line. Each vertical line can be rotated with the Ellipse control. You must place the start and end points on the line.

IMT C10 and IMT2 C10 have two kinds of measurements:

- IMT C10 -+/IMT2 C10 -+: Base vertical line shows right side.
- IMT C10 +/-IMT2 C10 +/-: Base vertical line shows left side.

**IMT Measurement - Manual C(10) (continued)**

2. Acquire a longitudinal scan of the carotid artery and optimize the image. Then press **Freeze**.
3. Scroll to an end-diastolic frame where the intima layer is clearly visible.
4. Press **Measure**, then select **IMT C10**. An active caliper displays.

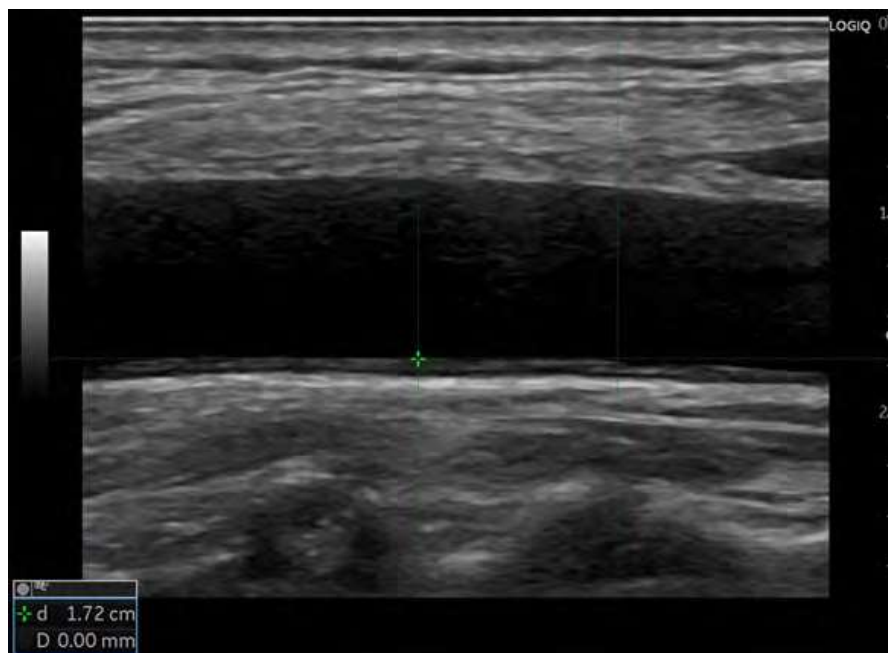

Figure 8-27. IMT C10 Active Caliper

5. Use the trackball to move the caliper and the Ellipse control to adjust the angle. Press **Set** to fix the caliper.

**NOTE:** *The interval of the vertical line for IMT1 and IMT2 is 1cm.*

6. Measure the thickness for IMT C10.

**IMT Measurement - Manual C(10) (continued)**

7. After you complete the measurement, the system shows base vertical line.

*NOTE: The base vertical line length is 1cm.*

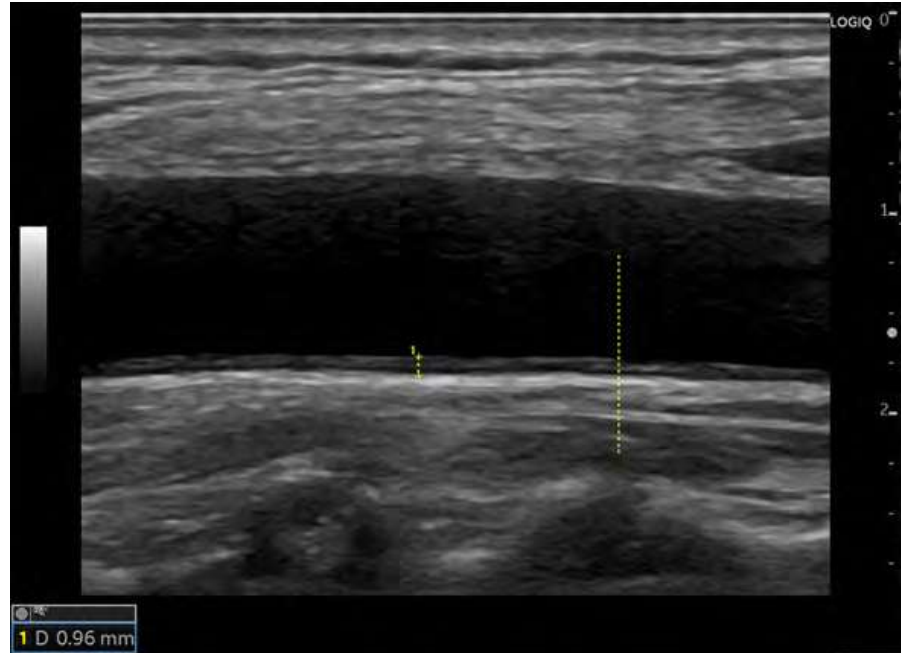

Figure 8-28. Base Vertical Line



## Plaque Score Tool

1. Before you measure, add Plaque Score to the Carotid folder at the Utility -> Measure -> Measurement & Analysis screen (by selecting 2D Plaque Score under Add Measurement in the M&A screen).

Label the parameters you want measured:

- Distance value (up to 20)
  - Sum (greater or equal to 1.1 mm)
  - Count (greater or equal to 1.1 mm)
  - Maximum value of each area
  - Average value
  - Average value of each area
2. Scan the carotid artery and press **Freeze**. Display dual images to measure across split screen images.
  3. Press **Measure** and select **Plaque Score Tool**. An active caliper, one horizontal line and five vertical lines display. The interval of the vertical lines are 1.5 cm.

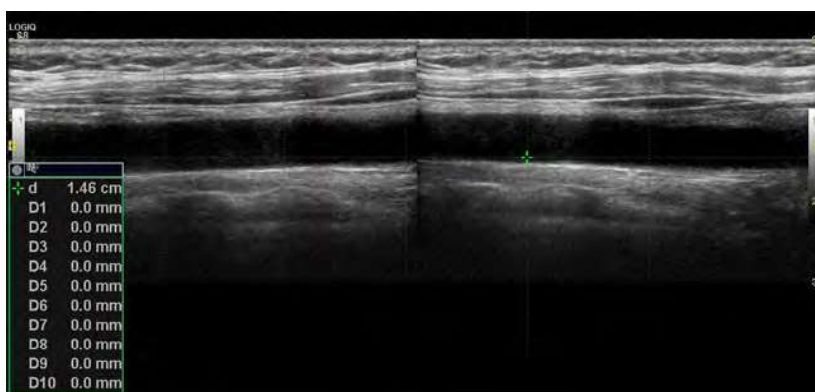

Figure 8-29. Plaque score example

4. Use the **Trackball** to move the caliper and the **Ellipse** control to adjust the angle. Press **Set** to fix the caliper.

## Plaque Score Tool (continued)

5. Measure the thickness (up to twenty times) on any place as necessary.

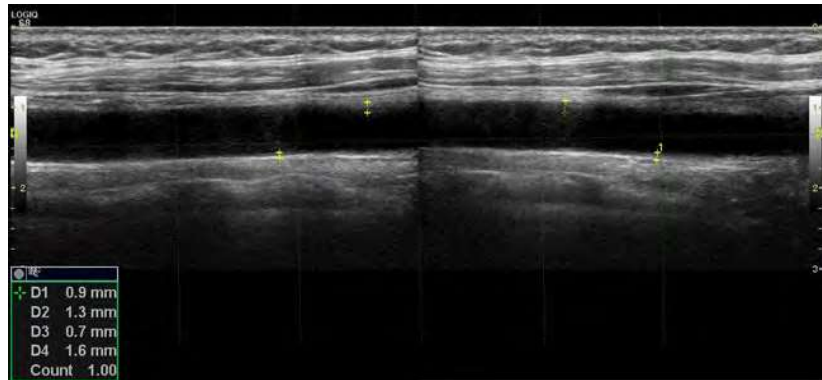

Figure 8-30. Plaque Score Example 2

6. The system displays the measurement result.

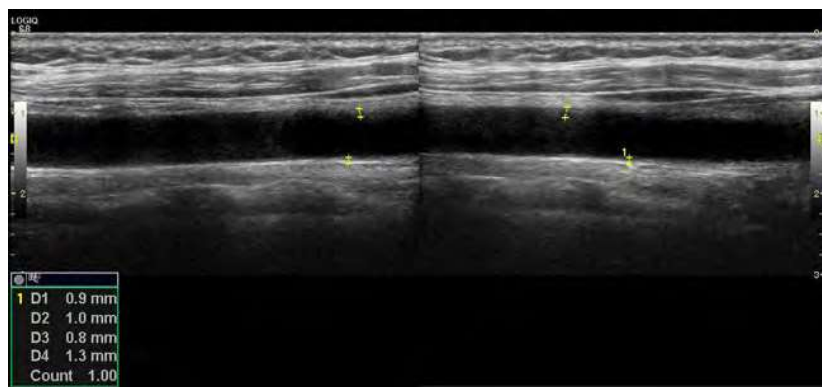

Figure 8-31. Plaque Score Example 3

**NOTE:** Only calculates the value larger than 1.1mm.

7. Double click the **Set** key to finish the measurement.

## Auto Vascular Calculation

Auto Vascular Calculation enables the LOGIQ Totus to detect and identify a cardiac cycle. It allows you to assign measurements and calculations during live timeline imaging, while the image is frozen, or in CINE. Peak values are detected for venous flow.

During cardiac cycle detection, the system identifies the cardiac cycle using calipers, vertical bars, and/or highlighting of timeline data. Use of identifiers is based on measurements and calculations selected by an operator for the current application. The system may place calipers at early systolic peak, peak systole, minimum diastole and end diastole. Vertical bars may also be placed to indicate the beginning and end of the cardiac cycle. The peak and/or mean trace may be highlighted. You can edit the cardiac cycle identified by the system or select a different cardiac cycle.

You can select the calculations to be displayed in the M&A Result window during live scanning or on a frozen image. These calculations are displayed at the top of M&A Result Window located adjacent to the image. These calculations are presettable by application which means you can set up the default calculations to be displayed for each application.

## Activating Auto Vascular Calculation

To activate Auto Vascular Calculation, select **Auto Calc** from Live (calculations displayed on the real-time image), or Freeze (calculations displayed on the frozen image).

To deactivate Auto Vascular calculation, select Off.

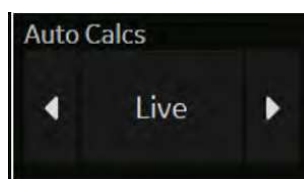

Figure 8-32. Auto Calculation Touch Panel key

## Setting up Auto Vascular Calculation Parameters

- **Selecting Auto Trace**

You can select to have a continuous auto trace of the max or mean velocities.

- Select Max or Mean using the **Trace Method** Touch Panel pull-down menu.

- **Selecting Trace Direction**

Trace Direction lets you use peak timeline data above, below, or composite (above and below) the baseline.

- Select Positive, Negative or Both to set the peak timeline data.

- **Modify Calculation**

- a. Select the **Modify Calcs** Touch Panel key.

The Modify Calculation menu is displayed.

- b. Select which measurements and calculations are to be displayed in the Auto Vascular calculation window.

You can select the following parameter: PS, ED, MD, HR, TAMAX, PI, RI, Accel, PS/ED, ED/PS, AT, Volume Flow, PV.

## Auto Vascular Calculation Exam

1. Preset the system.
2. Perform the scan and press **Freeze**.
3. Activate Auto Vascular Calculation.

The system performs a calculation automatically.

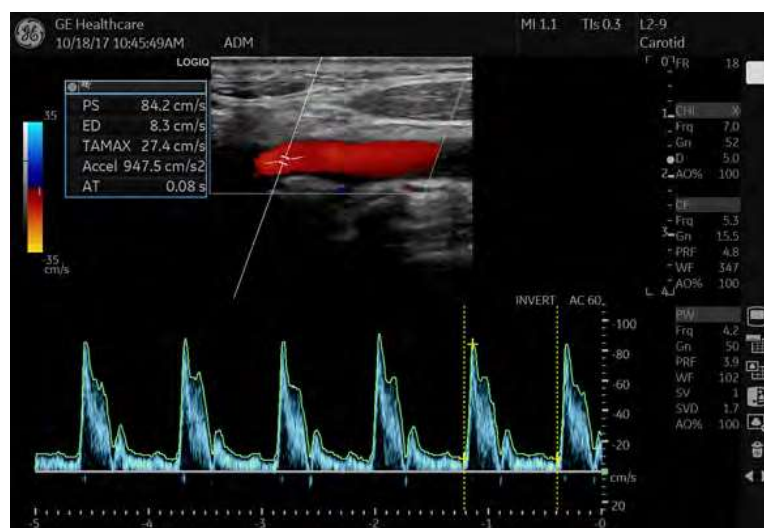

Figure 8-33. Auto Vascular Calculation

## Auto Vascular Calculation Exam (continued)

The Auto Vascular calculation is assigned to particular vessel measurements.

1. Press **Measure** to display the Measurement menu.
2. Select the location of the vessel (Prox, Mid, or Dist) and Side (Right or Left).
3. Select the desired vessel name from the Touch Panel.

Selected vessel measurements are automatically assigned with the Auto Vascular calculation. The results are then displayed in the Results Window.



Figure 8-34. Assigned Vessel

**NOTE:** When you want to cancel the assignment, you can use the **Cancel Transfer Touch Panel** key. See 'Cancel Transfer' on page 7-32 for more information..

## Auto Vascular Calculation (continued)

During the course of an exam, the cardiac cycle may be indicated between two yellow bars; the peak trace and the mean trace may appear in green; calculation indicators appear on the spectral trace as a caliper identifier (these vary, depending on the selected calculation in the Results Window).

The right-most, most complete cycle is typically chosen to be the selected cardiac cycle. You can select a different cardiac cycle.

To select a different cardiac cycle:

- Move through CINE memory with the Trackball until the desired cardiac cycle is selected by the system.
- Use the **Cycle Select** control to cycle to a different cardiac cycle.

*NOTE: You need several good cycles in front of the new cardiac cycle for this to be successful. Oftentimes, this is problematic near a freeze bar.*

*NOTE: You need several good cycles in front of the new cardiac cycle for this to be successful. Oftentimes, this is problematic near a freeze bar.*

To move the systole or diastole position:

- Use the **Cursor Select** control to move the start systole position or the end diastole position.

## Manual Vascular Calculation

You can perform the following calculations manually when Auto Doppler Calculation is not activated.

1. Press **Measure**.  
If necessary, you can select another Exam Calc and then select parameters from Modify Calculation.
2. Select the location of the vessel (Prox, Mid, or Dist) and Side (Right or Left).
3. Select the desired vessel folder.  
The Measurement menu is displayed.

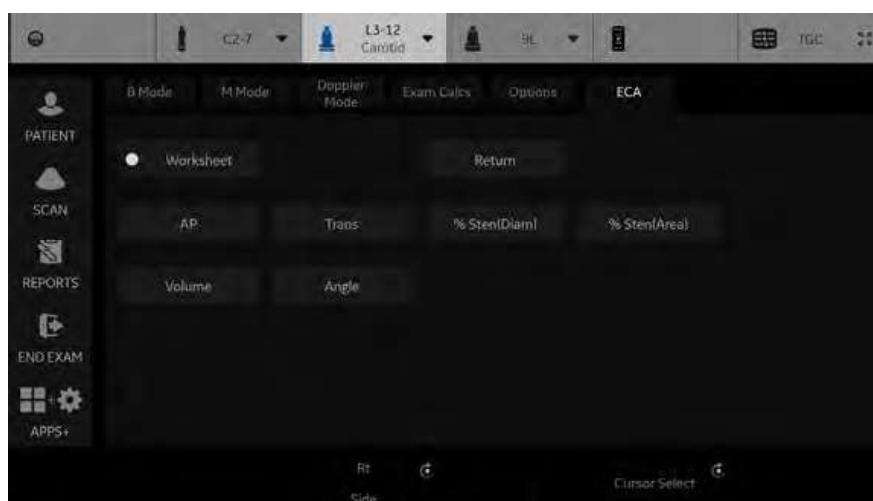

Figure 8-35. Measurement Menu Example

4. Make the required measurements according to the system, or select your preferred measurements.

### To select vascular measurements

Your system is set up to show the measurements that you usually make for each vessel. To make a measurement that is not shown for the selected vessel:

1. Select the folder for the vessel you want to measure.
2. Select **Show All**.  
The system displays all possible vessel measurements.
3. Select the desired measurement.

**NOTE:** *The following instructions assume that you first scan the patient and then press **Freeze**.*

## Intravessel ratio

On the Vessel Worksheet page, to calculate the Intravessel ratio, you need a measurement of assessing pressure and stenotic velocities.

1. Select **Intrav. Ratio** from the Touch Panel. The Intravessel Ratio pop-up window displays in the header section of the worksheet.

	1	2	3	Method
Prox CCA				
PS (cm/s)		8.1		Last
ED (cm/s)		1.8		*
AC (deg)		60		*
Mid CCA				
PS (cm/s)		22.9		Last
ED (cm/s)		13.7		*
AC (deg)		60		*
Dist CCA				
PS (cm/s)	19.7	20.3		Last
ED (cm/s)	14.7	8.4		*
AC (deg)	60	60		*

Figure 8-36. Intravessel Pop-up Window

2. Select the first velocity. The value displays in the window. The value is displayed in the window.

Intravessel Ratio:  
 Select Vprox: 8.1 / Clear Save Cancel

Figure 8-37. Intravessel ratio one



## Intravessel ratio (continued)

3. Select the second velocity.

The second value and Result value display in the window.

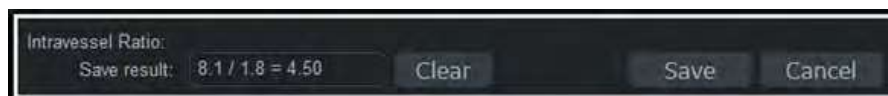

Figure 8-38. Intravessel ratio two

- To save the Intravessel ratio to the Vessel Summary, move the cursor to **Save** and press **Set**.
- To clear values, move the cursor to **Clear** and press **Set**.
- To cancel and exit Intravessel ratio, move the cursor to **Cancel** and press **Set**.

**NOTE:** *Intravessel Ratio is only displayed and saved in the Vessel Summary as Intra-Ratio.*

	Right			Left		
	PS	ED	AC	PS	ED	AC
Prox CCA	8.1cm/s	1.8cm/s	60deg	21.0cm/s	10.0cm/s	60deg
Mid CCA	22.9cm/s	13.7cm/s	60deg	22.2cm/s	9.3cm/s	60deg
Dist CCA	20.3cm/s	8.4cm/s	60deg	19.4cm/s	11.5cm/s	60deg
Intra-Ratio	4.57					

Figure 8-39. Vessel Summary Example

## Bypass Graft Anastomosis Graph

If there aren't any known Grafts associated with the current exam, you can create a Graft by describing its anastomosis locations and anastomosis modifiers.

**NOTE:** You can always create another new Graft by selecting one from the "Choose to Add" table, and then modifying it into what you want.

To graph Bypass Graft anastomosis,

1. Select Bypass Graft on the Touch Panel. The Add/Edit Grafts pop-up appears.

**NOTE:** This pop-up appears if there are not any known Grafts.



Figure 8-40. Add/Edit Graft

2. Use the Trackball to assign graft locations on the Add/Edit Grafts pop-up. Press Continue.

**NOTE:** You can select a Graft by choosing it in the table of Grafts that exist in the current exam.

**NOTE:** You can always modify the selected Graft by choosing new anastomosis locations and anastomosis modifiers.

**NOTE:** The Stent pop-up is nearly identical to the Graft pop-up, except that you also have the ability to specify the Stent's laterality.

## Bypass Graft Anastomosis Graph (continued)

- Graft assignments now appear on the Touch Panel: This is saved on the system and can be edited. Specify the Topographic Modifier (location), Stenosis Modifier, and Anatomic Modifier for any measurement you would like to take.

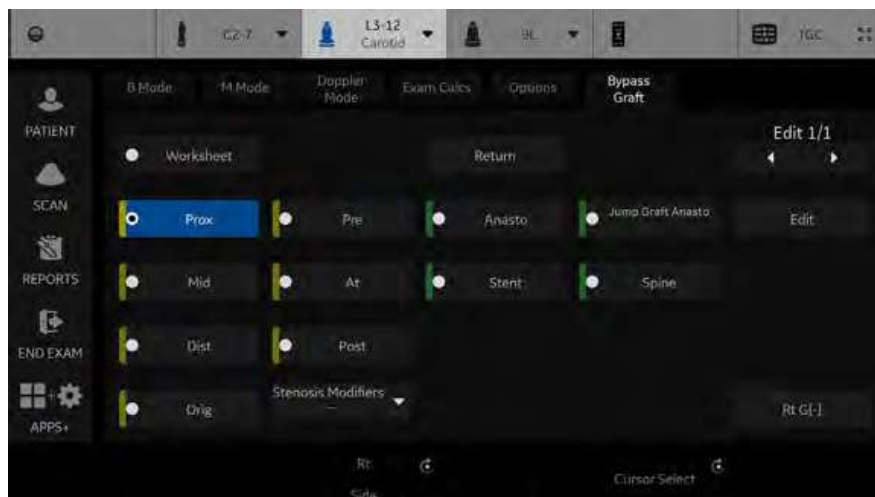

Figure 8-41. Graft table update

**NOTE:** For each measurement within a blood vessel, you can choose a Topographic Modifier (i.e., location) and a Stenosis Modifier. For Grafts and Stents, you can also choose an Anatomic Modifier (i.e., eye, ankle, or liver).

- To edit the Bypass Graft Anastomosis, select the “Edit 1/1” toggle on the Touch Panel to specify which of the Grafts you are measuring within.



### HINTS

Very Important: When creating Grafts or Stents, it is always recommended to perform the accompanying measurements. The measurements folder can be found in the lower, right-hand portion of the Touch Panel.

## Bypass Graft Anastomosis Graph (continued)

5. On the Doppler Mode M&A Touch Panel, you have the option to select the Stenosis Modifiers, Pre-Steno, At-Steno, or Post-Steno.

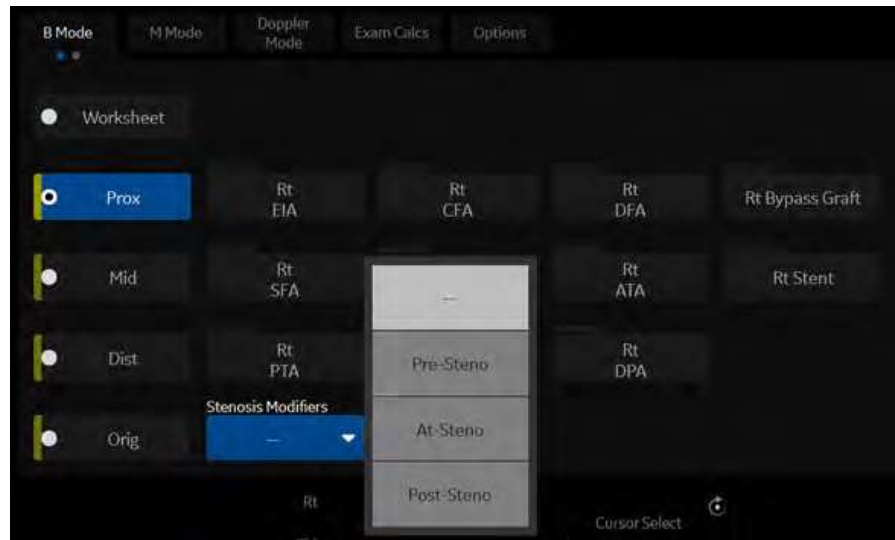

Figure 8-42. Select the Stenosis Modifier

# Urology

## Introduction

Urology measurements offer three different types of measurement studies:

- Generic—Common to all applications. See ‘Generic Measurements’ on *page 7-18 for more information..*
- Urology
- Pelvic Floor. See ‘Pelvic Floor Measurements’ on *page 8-78 for more information.*

**NOTE:** *Bladder(0.7) Vol, Bladder Vol, Post Void Vol, Prostate Vol, Renal Vol, Renal (0.8) Vol and Volume can be displayed on the Touch Panel if preset at the Utility -> Measure screen.*

## Bladder Volume

This calculation uses a standard distance measurement. Length is typically measured in the sagittal plane. Width and height are measured in the axial plane.

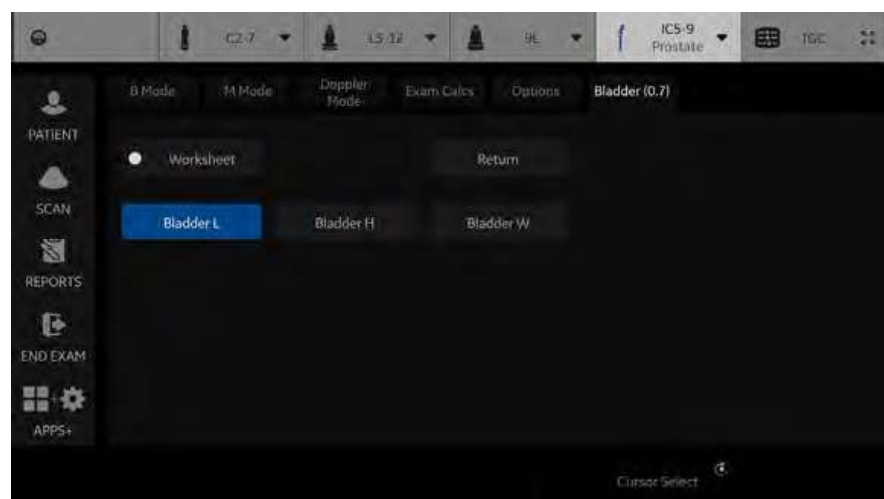

Figure 8-43. Bladder Volume Touch Panel

## Renal Volume

This calculation uses a standard distance measurement. Length is typically measured in the sagittal plane. Width and height are measured in the axial plane.

To select the left or right, adjust the **Side** selection.

To measure Renal Volume:

## Prostate Volume

This calculation uses a standard distance measurement. Length is typically measured in the sagittal plane. Width and height are measured in the axial plane.

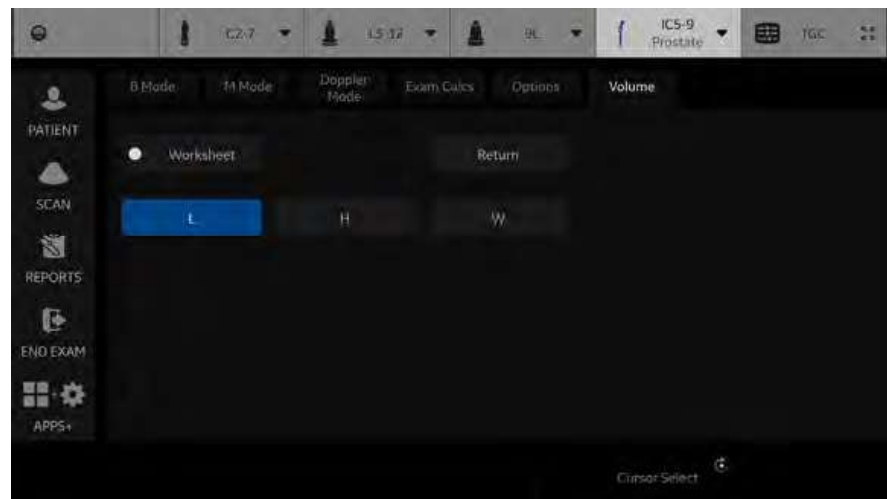

Figure 8-44. Prostate Volume Touch Panel

## Prostate Volume (continued)

### PSA Measurement

If you enter the value of PSA (Prostatic Specific Antigen) and PPSA Coefficient at the Urology Patient screen, PSAD and PPSA are automatically calculated.

The values are displayed on the Worksheet and Report (if set appropriately on the Report Designer page).

The screenshot shows a software interface with a dark background. At the top, there is a navigation bar with tabs labeled ABD, OB, GYN, CARD, VAS, UR (highlighted in blue), SM P, and PED. Below the tabs, there are three input fields:
 

- PSA: with a text input containing '0.000' and a unit dropdown set to 'ng/ml'.
- PPSA Coefficient 1: with a text input containing '0.12'.
- PPSA Coefficient 2: with a text input containing '0.12'.

Figure 8-45. Urology Patient Screen

1	Prostate L	2.88 cm
2	Prostate H	2.86 cm
3	Prostate W	2.15 cm
	Prostate Vol	9.29 ml
	PSAD	0.00
	PPSA(1)	1.12
	PPSA(2)	1.12

Figure 8-46. Measurement result window

PSAD: Prostatic Specific Antigen (PSA) Density – defined as:  
 $PSAD = PSA/Volume$

PPSA: Predicted Prostate Specific Antigen – defined as:  $PPSA = Volume \times PPSA \text{ Coefficient}$

## Pelvic Floor Measurements

Pelvic floor measurements can be performed in the Pelvic Floor study. The measurements are located in the Exam Calc folder in the Urology preset.

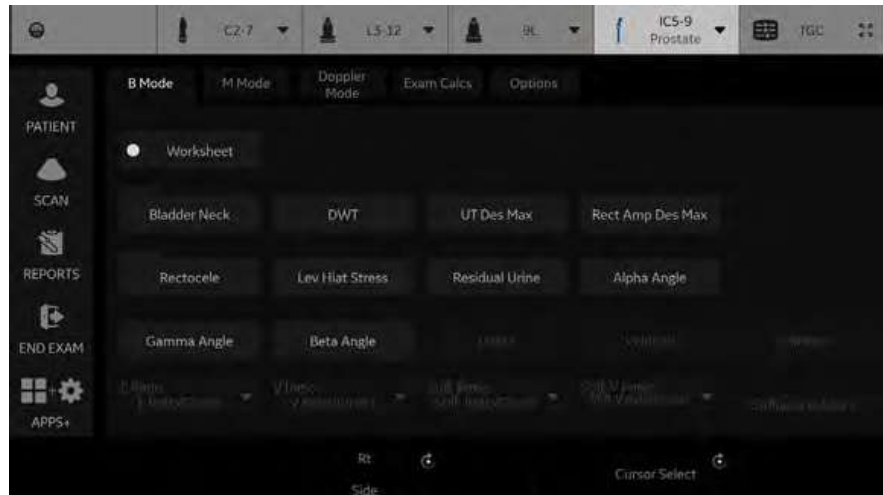

Figure 8-47. Pelvic Floor Study Touch Panel

### BN (Bladder Neck) Rest

Obtain an image with the patient at rest (relaxed).

1. Create a straight line (zero or baseline) to line up with the inferior/posterior of symphysis pubis bone.
2. Once the baseline is positioned, a caliper appears. Position the caliper at the anterior margin of the bladder neck. A positive number displays since the caliper is placed below the baseline.
3. A distance is calculated in millimeters.

### BN (Bladder Neck) Stress

Obtain an image after the patient performs the Valsalva maneuver.

1. Create a straight line (zero or baseline) to line up with the inferior/posterior of symphysis pubis bone.
2. Once the baseline is positioned, a caliper appears. Position the caliper at the anterior margin of the bladder neck.

If the bladder neck is below the baseline, the Bladder Neck Stress is a positive number. If the bladder neck is above the baseline (closer to the transducer face), the number is negative.



## Pelvic Floor Measurements (continued)

### BN (Bladder Neck) Descent

The Bladder Neck Descent is a calculation that should be calculated after measuring the Bladder Neck Rest and Bladder Neck Stress.

$BND = \text{Bladder Neck Rest} - \text{Bladder Neck Stress}$

*NOTE: If the Bladder Neck Stress is a negative number, it becomes positive and is added to the bladder neck rest measurement.*

### DWT (Detrusor Wall Thickening)

Three distance measurements of the bladder wall dome are calculated into a mean dimension and displayed in millimeters.

### UT (Uterine) Descent Max

1. Create a straight line (zero or baseline) to line up with the inferior/posterior margin of symphysis pubis bone.
2. Measure using a 2-caliper dimension to the inferior position of the uterus in a stress image and display in millimeters

### Rect Amp Des Max (Rectal Ampulla Descent Max)

1. Create a straight line (zero or baseline) to line up with the inferior/posterior margin of symphysis pubis bone.
2. Measure using a 2-caliper dimension to the inferior position of the rectal ampulla in a stress image and displayed in millimeters

### Rectocele (Depth and Width)

Two 2-caliper diameter measurements to measure depth and width of the rectocele. Displayed in millimeters.

## **Pelvic Floor Measurements (continued)**

### **Lev Hiat Stress (Levator Hiatus Stress)**

Two 2-caliper diameter measurements and calculate an area displayed as cm squared.

### **Residual Urine**

Two 2-caliper diameter measurements calculate as:

(x) times (y) times 5.9 minus 14.9 equals Residual Volume displayed in ml.

# Pediatrics

## Overview

Pediatrics measurements offer two different types of measurement studies:

- Generic. The Generic Calculations study is common to all applications. See 'Generic Measurements' on *page 7-18 for more information..*
- Pediatric Hip (PedHip).

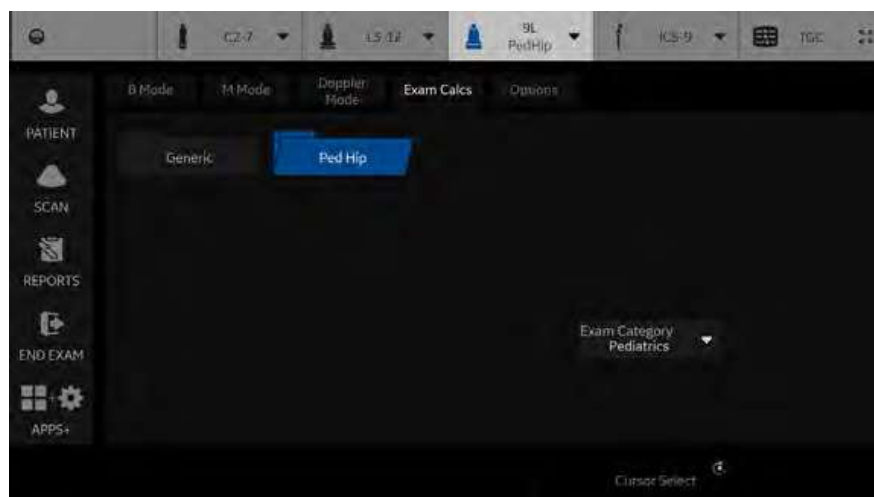

Figure 8-48. Touch Panel - Pediatrics Exam Calcs

## Pediatrics Hip

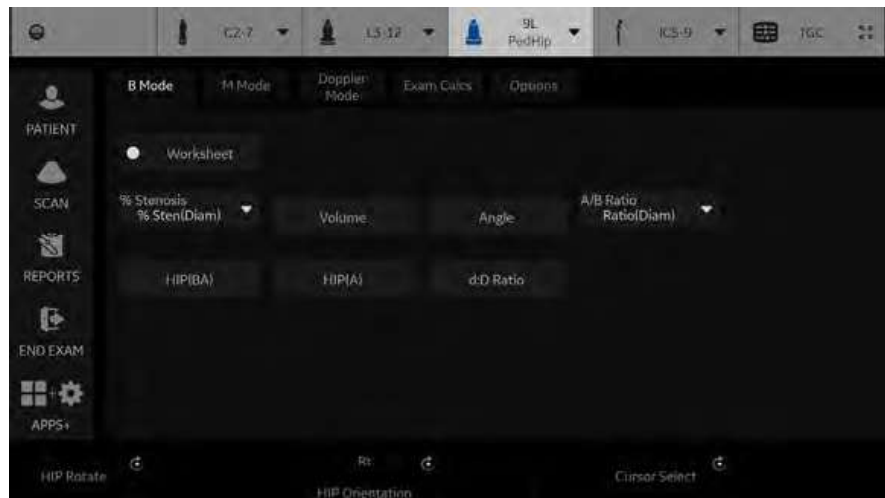

Figure 8-49. B-Mode Measurement Touch Panel – PedHip

## Hip Dysplasia Measurement

The HIP calculation assists in assessing the development of the infant hip. In this calculation, three straight lines are superimposed on the image and aligned with the anatomical features. The two angles are computed, displayed, and can be used by the physician in making a diagnosis.

The three lines are:<sup>1</sup>

1. The baseline connects the osseous acetabulum convexity to the point where the joint capsule and the perichondrium unite with the iliac bone.
2. The inclination line connects the osseous convexity to labrum acetabulare.
3. The Acetabulum roof line connects the lower edge of the osilium to the osseous convexity.

## Hip Dysplasia Measurement (continued)

The  $\alpha$  (Alpha) angle is the supplement of the angle between 1 and 3. It characterizes the osseous convexity. The  $\beta$  (Beta) angle is the angle between lines 1 and 2. It characterizes the bone supplementing additional roofing by the cartilaginous convexity.

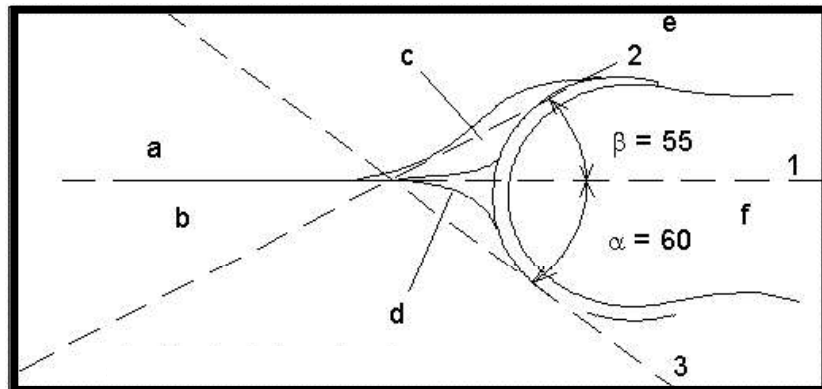

Figure 8-50. Hip Dysplasia

### Anatomical Landmarks

- |               |                                  |
|---------------|----------------------------------|
| a. Ilium      | d. Bony Roof                     |
| b. Iliac Bone | e. Cartilaginous acetabular roof |
| c. Labrum     | f. Femoral Head                  |

<sup>1</sup>Source: R GRAF, Journal of Pediatric Orthopedics, 4: 735-740(1984)

To make a Hip Dysplasia measurement:

1. From the Touch Panel, select either the **right** or **left side** (orientation) and then select **Beta Alpha HIP**.  
A horizontal dotted line displays.
2. To place the baseline, move the **Trackball**. Position the crosshairs edge at the osseous convexity of the ilium.
3. To rotate or change inclination, adjust the **Ellipse** control or **Hip Rotate**.
4. To fix the baseline, press **Set**.  
The system displays a second dotted line at an angle.

## Hip Dysplasia Measurement (continued)

5. To place the line along the inclination line of the osseous convexity to labrum acetabulare, move the **Trackball**.
6. To rotate or change inclination, adjust the **Ellipse** control or **Hip Rotate**.
7. To fix the second measurement line, press **Set**.  
The system displays a third dotted line at an angle.
8. To place the caliper along the acetabular roof line, move the **Trackball**.
9. To rotate or change inclination, adjust the **Ellipse** control or **Hip Rotate**.
10. To fix the third measurement line and complete measurement, press **Set**.

The system displays the hip measurements ( $\alpha$  and  $\beta$ ) in the Results Window.

## Alpha HIP

The Alpha HIP measurement measures the angle between the iliac baseline and the bony roof line. To make an Alpha HIP measurement:

1. From the Touch Panel, select either the **right** or **left side** (orientation) and then select **Alpha HIP**.  
A horizontal dotted line displays.
2. To place the baseline, move the **Trackball**. Position the crosshairs edge at the osseous convexity of the ilium.
3. To rotate or change inclination, adjust the **Ellipse** control or **Hip Rotate**.
4. To fix the baseline, press **Set**.  
The system displays a second dotted line at an angle.
5. To place the caliper along the acetabular roof line, move the **Trackball**.
6. To rotate or change inclination, adjust the **Ellipse** control or **Hip Rotate**.
7. To fix the second measurement line, press **Set**.

The system displays the alpha hip measurement ( $\alpha$ ) in the Results Window.

## d:D Ratio Measurement

The d:D Ratio measurement measures the percentage of the femoral head coverage under the bony roof. To make this measurement:

1. From the Touch Panel, select either the *right* or *left side* (orientation) and then select **d:D Ratio**.  
A horizontal dotted line displays.
2. Use the **Trackball** to place the baseline along the ilium. Position the crosshairs edge at the osseous convexity of the ilium.
3. Use the **Ellipse** control to adjust or change inclination or **Hip Rotate**.
4. Press **Set** to fix the baseline.
5. The system displays a circle representing the femoral head. Use the **Trackball** to position the circle.
6. Use the **Ellipse** control to size the femoral head circumference.
7. Press **Set** to fix the femoral head circumference.

The system displays the d:D ratio for the femoral head in the Results Window.





---

## *Chapter 9*

# Recording images

*Describes how to record images.*

# Getting Set Up to Record Images

## Overview

A typical workflow for connectivity might be as follows (this setup varies by each user setup):

1. Select the dataflow, worklist for example.
2. Start a new exam. Select the patient.
3. Perform the patient scan.
4. Store images as multi-frame CINE Loops and Raw DICOM data via the **P1** key.
5. Store secondary capture for DICOM print via **P2** key.
6. Store images to the color printer or B/W printer via **P3** key.
7. Check the DICOM Job Spooler via **F4** to verify delivery.
8. End the exam.
9. Permanently store images via the Patient menu to permanent storage.

During an examination, the operator stores data, images and cineloops for immediate purposes. The LOGIQ Totus includes an integrated patient archiving system for data and image storage.

The LOGIQ Totus enables also storing of data and images to external databases (removable media).

## Overview (continued)

Dataflow combines archive, data, DICOM, and onboard records into one coherent workflow. Destination devices are configured and assigned to the print keys. You select the appropriate dataflow (Portable, etc.) according to your requirements. You manage the patient database (local, shared, or via a worklist broker).

- DO NOT use the internal hard drive for long-term image storage. Daily backup is recommended. External storage media is recommended for image archive.

*NOTE: DICOM images are stored to external media storage devices separately from patient data, which also needs to be backed up to a dedicated database-formatted external storage media.*

- If working off-line with a dataflow pointing to a DICOM server, the images stored during the examination may have to be manually resent in the DICOM spooler when reconnecting the unit. Resend all jobs that failed or are on hold.

In addition, stored images and cineloops can be saved to a removable media in the standard formats JPEG, WMV, and DICOM.

- You need to set up a process for locating images stored to external storage media for easy recall
- GE HealthCare **IS NOT** responsible for lost data if you do not follow suggested back-up procedures. GE HealthCare **WILL NOT** aid in the recovery of lost data.

Refer to the Customizing Your System chapter for instructions on setting up your system's connectivity.

### Image Management Guide

**Save As to View on any PC** Use this to save images in a computer-friendly format so you can view it on any PC.

**EZBackup Images to Archive** Use this to take images off your Ultrasound system onto removable media for long-term archive. This is the way to free up hard disk space, rather than deleting images.

**Export/Import Data/Images Between Systems** Use this to copy both patient data and images for specified patient(s) from one system to another.

### Media Requirements

The system **ONLY** supports medical grade USB Hard Disk Drive and USB Flash Drive.

### Media Handling Tips

To eject the media, always press **F3**. **DO NOT** press the eject button on the drive:

1. Press **F3**. The Eject device menu is displayed.
2. Select the relevant media.
3. Select USB Drive from the pull-down menu to disconnect the USB Drive. Disconnect the USB drive after the success dialogue is displayed.

Remove the USB Drive from the USB port.

**NOTE:** *If the unsuccessful dialogue is displayed, retry after a while.*

**NOTE:** *Verify is NOT available on Flash Drive or Hard Disk Drive media.*

## **Adding Devices**

To add a destination device (printer, worklist server, etc.) to this system, see 'MyComputer Device Page' on *page 10-72*.

To verify a DICOM device, see 'Dicom Page' on *page 10-81*.

## **Adding a Dataflow**

To add a new dataflow to this system, see 'Dataflow Page' on *page 10-119*.

## **Adding Devices to a Print Button**

To add devices/dataflows to a print button, see 'Print Button Page' on *page 10-116*.

# Storing Images and Cineloops

Images and cineloops that are stored during a current examination are displayed as thumbnails on the clipboard.

When an image is stored, all the additional information that is displayed is saved with it (i.e. probe and application selected, image setting, annotations or measurements).

See Dataflow in Connectivity for detailed settings related storing image/Cine.

Image archive is set by the dataflow selected (See Dataflow in Connectivity for more information.)

When you want to print/store an image, P1 is most commonly used for the primary destination and internal hard drive.

## Storing an image

To store an image,

1. While scanning, press **Freeze**.
2. Scroll through the cine Loop and select the desired image.
3. Press the appropriate Print key.

The selected image is stored (per your preset instructions) and a thumbnail is displayed on the clipboard.

**NOTE:** *LOGIQ Totus numbers the images which are saved in the Local Archive (Instance Number). But Instance Number may change or get duplicated when adding/deleting images to the exam. So for identification, the recommendation is to use Content Date/Content Time on the DICOM server instead of Instance Number.*

## Storing a cine loop

A Cine loop is a sequence of images recorded over a certain time frame. The stored cine Loops are displayed chronologically on the clipboard.

Cine loops can be stored at any time during scanning. You can choose to preview the cine loop before storage and save the cine loop directly, as described below.

The system can be configured to perform either

- Prospective clip: The system begins storing Cine from when you press the Print button, based on the Time Span setting.
- Retrospective clip: The system stores Cine predetermined time before you press the Print button, based on the Time Span setting.

Refer to 'Retrospective Cine/Prospective Cine' on page 9-9 about the setting.

**NOTE:** LOGIQ Totus numbers the images which are saved in the Local Archive (Instance Number). But Instance Number may change or get duplicated when adding/deleting images to the exam. So for identification, the recommendation is to use Content Date/Content Time on the DICOM server instead of Instance Number.

## Previewing and Storing a CINE Loop

1. While scanning, press **Freeze**.
2. Move the Trackball to activate Cine.
3. Use the trackball or **Frame by Frame** to scroll through the acquisition and find the sequence of interest.
4. Press **Start Frame** or **End Frame** to set the corresponding cine loop boundary to the current frame as necessary.  
Rotate **Start Frame** and **End Frame** to trim or expand the cine loop boundaries.
5. Press **Run/Stop** to run the cine loop and then press the print key to store the cine loop.  
Cine loops stored on the clipboard are indicated with a movie strip icon.
6. Press **Run/Stop** again to stop the cine loop.
7. Press **Freeze** to return to live scanning.

Depending on whether the system has been configured to enable or disable "Preview Loop before store" (see 'Print Controls' on page 10-58), the following procedures enable the cine loop to be stored directly.

### Storing a cine loop without Preview

If “Preview Loop before store” is disabled,

1. While scanning, press the appropriate print key.
2. The last valid cine loop is stored in the archive and a movie clip thumbnail is displayed on the clipboard.
3. Scanning resumes immediately.

### Storing a cine loop with Preview

If “Preview Loop before store” is enabled,

1. While scanning, press the appropriate print key.
2. The last valid cine loop is previewed.
3. Adjust the cine loop, as necessary.
4. Press the appropriate print key.

The movie clip thumbnail is displayed on the clipboard.

### Preview

Loop Preview can now be enabled independently for Time-Based Store, ECG-Based Store, and Mark CINE. This is useful for setting preview preferences based on the application.

**NOTE:** *The Contrast Time Span setting overrides the Time Span when in Contrast Mode.*



## Retrospective Cine/Prospective Cine

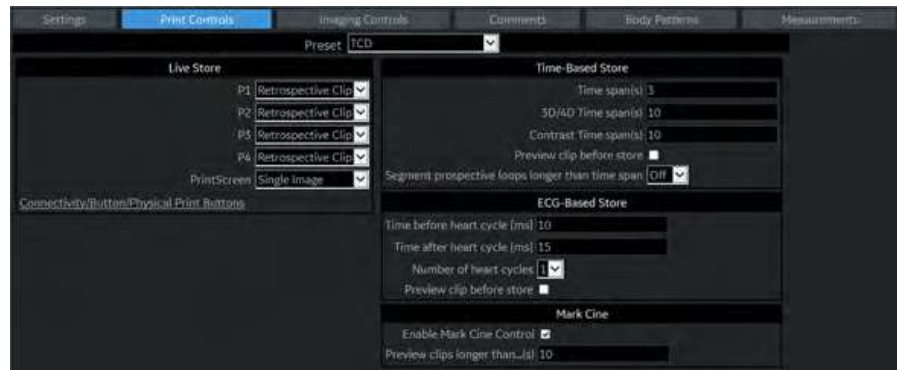

Figure 9-1. Print Control

### Retrospective CINE

When you select to store a Cine loop retrospectively, the system stores cine for a specified time before you press the Print Button.

1. Set Live Store P1 - P4 to “Retrospective Clip” via Utility -> Application -> Print controls.
2. Specify the recording time in Time-Based Store or ECG-Based Store.
3. Press **Save**.

**NOTE:** A Print button can be configured to store a Single Image during Retrospective Cine, without stopping the Cine loop.

### Prospective CINE

When you select to store a cine loop prospectively, the system begins storing cine from when you press the Print button.

1. Set Live Store P1 - P4 to “Prospective Clip”.
2. Specify the recording time in Time-Based Store or ECG-Based Store.
3. Press **Save**.

**NOTE:** A Print button can be configured to store a Single Image during Prospective Cine, without stopping the Cine loop.

**NOTE:** The CINE gauge turns green when a Prospective CINE Clip is pending.

**NOTE:** You can cancel Prospective Store by pressing Freeze/Unfreeze or by changing Modes.

# Review images in archive

There are two ways to access to archived images:

- Review the images from a selected examination.
- Select images from the Active Image screen displaying all the images sorted by examination for the actual patient record.

## Review the patient exam/image

To review the patient exam,

1. Move the cursor to the patient in the Patient View and double-click. Exam View displays.

or

Move the cursor to the patient and select Exam View tab or **Review**. Exam View Displays.

2. Move the cursor to the desired exam and double-click.
3. Active Images screen displays. Move the cursor to the image and double click or press **Review**.
4. The review screen displays. Select the image from clipboard.

*NOTE: See 'Clipboard' on page 9-21 for more information.*

## Active Images

Active Images displays the images of the exam.

**NOTE:** *CINE loops are not played interactively as you view the active images on the Patient screen.*



Figure 9-2. Active Images Screen

1. Select the exam which includes the image to review.
2. Select **Active Images**.
3. Select the image and press **Review** or double click on the image. The image is displayed.

If you select 2 - 4 images and select **Review**, the archived images are displayed in the split screen.

**NOTE:** *If the size of an image is larger than 2GB, the image does not display on the Active Image screen. Take care when you scan a long CINE Loop, such as in Contrast.*

## Active Images (continued)

Table 9-1: Active Images

Parameters	Description
Delete Images Delete Selected Images/ Delete All Temp. Images	To delete selected images, select the image in the active screen, then select <b>“Delete”</b> on the monitor display or <b>“Delete Selected Images”</b> on the Touch Panel. To delete all images, select the image, then select <b>“Delete All Temp. Images”</b> on the Touch Panel.
Permanent Store	Select the images which you want save to the Local hard disk drive.
Standard Print	To print an image, 1. Select the image you want to print from the Active Images screen. You can print one (1) image per sheet or 2x3 images per sheet. 2. Press <b>Standard Print</b> . NOTE: If the printer is not assigned to the button, you will get a message telling you to Check Printer Button Configuration. NOTE: There is no warning to let you know that the printer is not functioning. Check the printer. You need to configure the printer to the Standard Print button via <b>Utility --&gt; Connectivity --&gt; Button</b> .
SaveAs Images	Refer to “SaveAs’ Images’ on page 9-28 for the detail. You can select the multiple images collectively in Active Image screen which you want save by SaveAs. NOTE: We suggest that you save the images page by page with ‘SaveAs’ Images in Active Images. It takes time if you have many images or raw data.
Select Images/Select All Unselect All	<ul style="list-style-type: none"> <li>• To select one or multiple image, place the cursor on the image and press Set.</li> <li>• To select all images, press Select all on the Touch Panel.</li> <li>• To deselect images, press Deselect all on the Touch Panel.</li> </ul>
Send To	Note: “Send To” button is not displayed in Active Images menu and the Touch Panel if the patient is not selected.

## Analyzing Images

To analyze the archived images, select the image, then select **Review**. The archived images is displayed with the date and time of archival.

To compare the analyzed image to a live image, press **L/R**. Now both the archived and live images appear on the monitor display. Unfreeze the live image area.

## Image Tags

Image Tag buttons included on the Active Images Touch Panel screen can be used to tag or untag selected images. There are three Image Tag options :

- Red mark
- Green mark
- Yellow mark

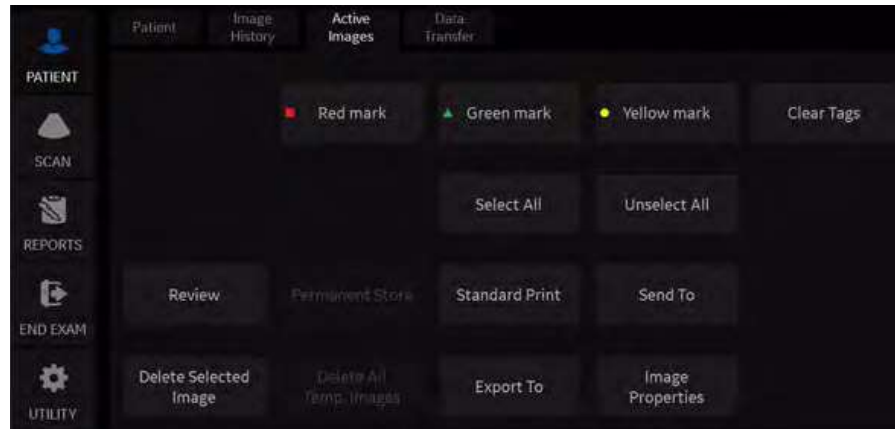

Figure 9-3. Active Images Touch Panel Screen

## Tagging Recalled Images

When recalling an image, the “Tags” tab displays.

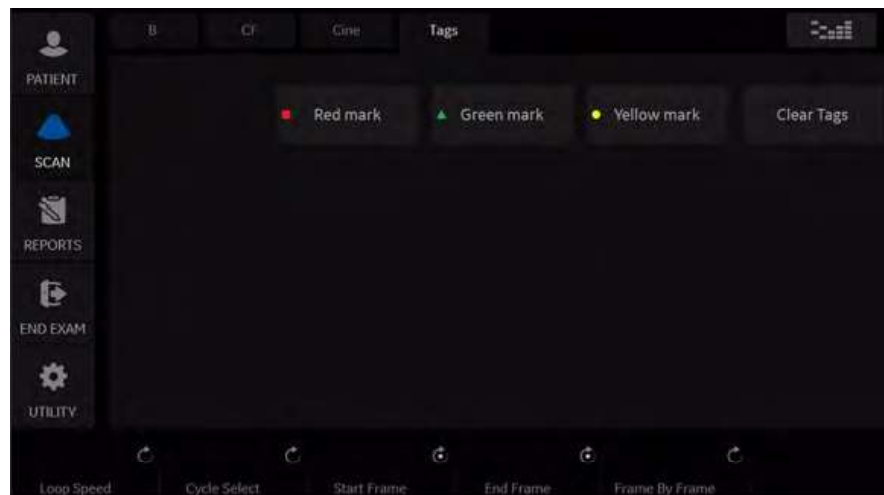

Figure 9-4. Touch Panel Screen

### Tag Icons on Image Clipboards

All image clipboards display the image tag icons on the image thumbnails.



Figure 9-5. Active Images Screen Clipboard

### Patient View/Exam View Tags Column

Image Tags icons are also displayed in a “Tags” column in the Patient View and Exam View screens. The “Tags” column can also be sorted by tags by clicking the “Tags” column heading.



Figure 9-6. Patient View Tags Column

## Patient Search by Tags

A patient search can be performed using Tags as a Search key

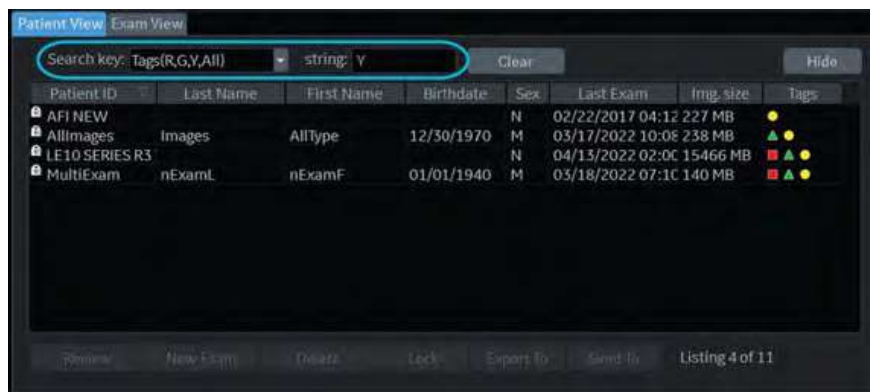

Figure 9-7. Tag Based Search

## Image Tag Presets

Image Tag preset configurations are available on the Utility > System > System Display screen. A custom label can be entered for each tag icon, which will be displayed as the button label.

Tags can be set for a specific Print button and the tags are applied automatically on the images saved with that Print button. The ultrasound system provides the option to show/hide the Tagging option for recalled images.



Figure 9-8. Image Tag Presets

Image Tag options are as listed below.

Table 9-2: Image Tags Presets

Preset Parameter	Description
Image Tag Labels	Edit the text to create custom labels for each image tag.
Image Tagging on Print buttons	Print buttons Assign Image Tagging on Print buttons.
Image Tag Options	Enable Image Tags when recalling images.



## Tagged Image Export

Images can be exported based on selected tags from the Patient View and Exam View screens.

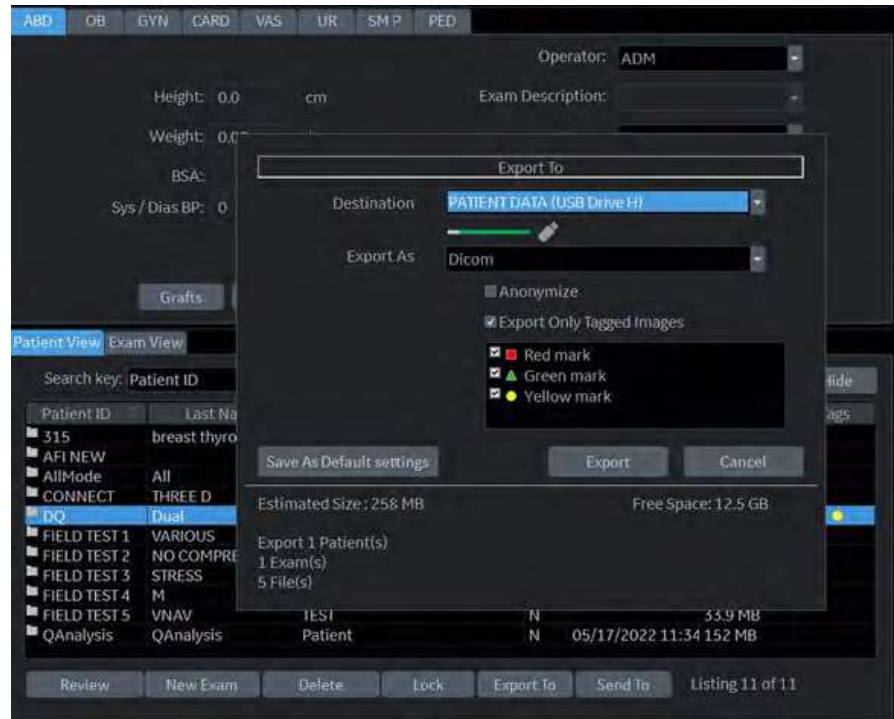

Figure 9-9. Export Tagged Images

### Image Reorder

To reorder the sequence of the images displayed on the Active Images screen:

1. Select Image Reorder on the left side of the screen.
2. Select the image(s) you wish to move with the left and right trackball buttons.

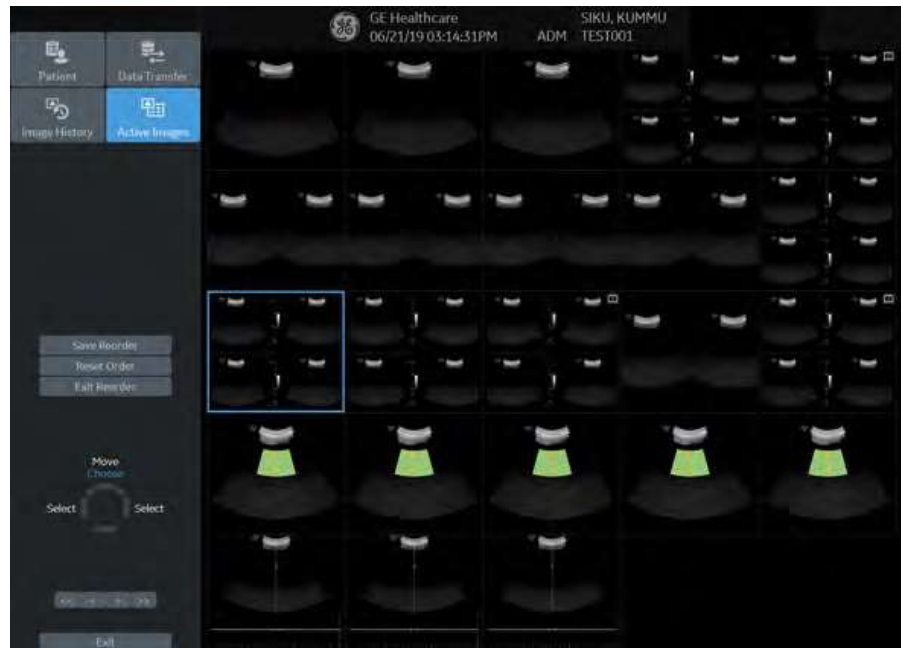

Figure 9-10. Select Image(s)

3. There are three ways you can freeze the selection and toggle from Choose to Move mode:
  - Press the top trackball button
  - Double-click the left or right trackball button
  - Drag and drop by holding the left or right trackball button

## Image Reorder (continued)

4. Move the placement cursor with the trackball to the position you want to move the images to.

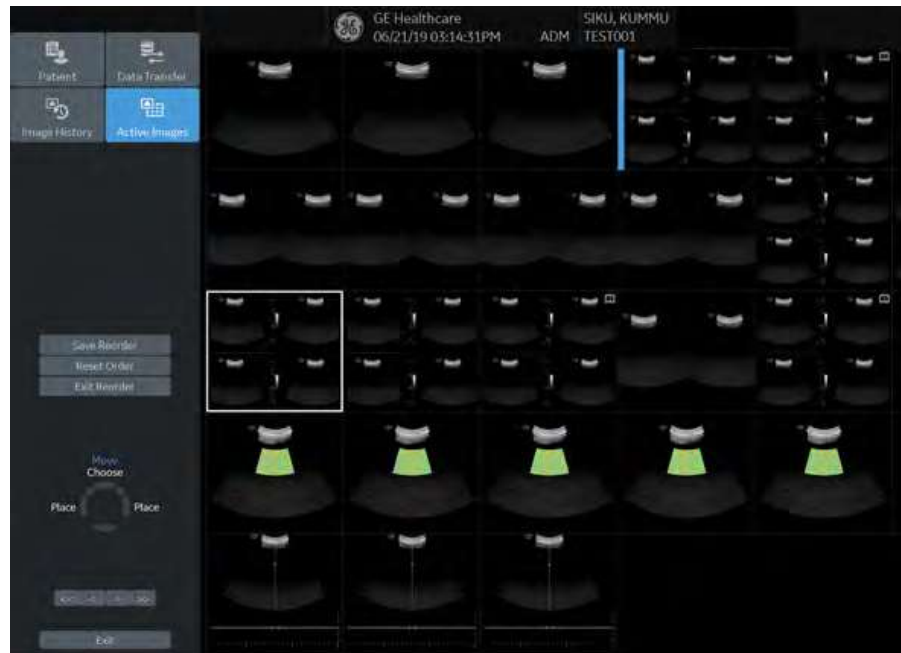

Figure 9-11. Move/Paste Image(s)

5. Press the top trackball button to paste the image(s) in the new location. After pasting, the system switches from Move mode to Choose mode.
6. Select Save Reorder to save the new image order, Reset Reorder to return to the original order, or Exit Reorder to return to the Active Images screen.

### Image History

Image History displays the images of each exam in chronological order of the patient.

1. Select the patient.
2. Select **Image History**.
3. Select the appropriate button which shows the old exam by date and storage location. 'Active Exam' is displayed on the button.



Figure 9-12. Image History Screen

4. Move the cursor to the required image for review.
5. Select **Review**. The selected image (maximum of 4 images) is displayed.

If the image data is saved on a disk and you do not insert the disk when displaying the Image History page, a triangle icon displays instead of a thumbnail.

Place the cursor on the icon. The disk name displays under the preview window. Insert the appropriate disk.

- Name of the disk displayed under the preview window
- Raw data B-Mode image appears in gray.
- Raw data Color image appears in color
- Image which does not have raw data (screen capture image) appears with a question mark.

### Viewing two different studies from the same patient

To view images side-by-side from two different studies on the same patient,

1. Select the patient.
2. Go to the Image History page.
3. Select the first image.
4. Select the next image from the other exam.
5. Press **Review**.

# Clipboard

The clipboard displays thumbnail images of the acquired data for the current exam. Images from other exams are not displayed on the current patient's clipboard.

**NOTE:** *If you have unsaved images in the clipboard and change the exam, the dialogue “You have unstored images. They will be saved to your current exam” displays. The unsaved images are saved to the current exam.*

All of the images can be viewed in the Active Images screen or in the Image History screen, available from the display or from the Patient menu.

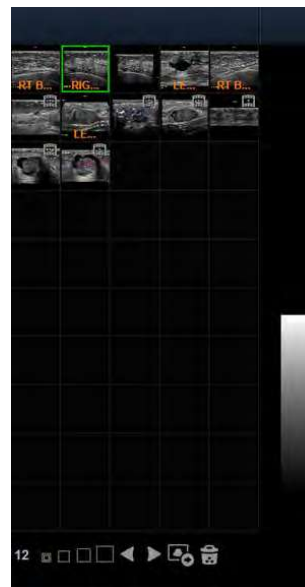

Figure 9-13. Clipboard example

### Clipboard icon



Figure 9-14. Side clipboard icon

1. Number of Images in Exam  
The number of images in an exam is tracked on the bottom of these Monitor Display Controls.
2. Thumbnail Size  
Place the cursor on one of the Thumbnail size box icons and press Set.
3. Prev/Next Image
4. Save As
5. Delete recalled image / Delete last image

### Saving the image /cine to the Clipboard

The active image/cine is stored and placed on the clipboard when you press the print key (this assumes that you have already set up a print key to do this). The clipboard contains preview images with enough resolution to clearly indicate the contents of the image. CINE Loops are indicated by a movie clip icon.

The clipboard fills from left to right, starting in the left-hand corner. Once the top row is full, the second row starts to fill. Once both rows are full, the next image stored starts to fill a 'third' row (the first row disappears from the clipboard display, with the second row now becoming the first row, and the third row now becoming the second row).

## Previewing Clipboard Images

1. Select the **Pointer** key to obtain a cursor arrow.
2. Move the **Trackball** to position the pointer over the clipboard image you want to recall.
3. An enlarged preview of the image is displayed on the left-hand side of the monitor.

## Recalling Images from the Clipboard

To recall images from the clipboard,

1. Select the **Pointer** key to obtain a cursor arrow.
2. Move the **Trackball** to position the pointer over the clipboard image you want to recall.
3. Press **Set** to recall the image.
4. Press the left/right arrow of Menu icon to move to the previous/next image.

## To delete an image from the clipboard

1. If in images live, press **Freeze**.
2. Select the **Pointer** key to obtain a cursor arrow.
3. Place the cursor on the clipboard image you want to delete, then press **Set** to select the image.
4. Place the cursor on the Delete icon and press **Set**.  
A warning message is displayed asking the user to confirm the action to perform.
5. Select **Yes**.

# Save As

## Overview

Images and cineloops can be saved to a removable media storage to View on a **Windows PC** in the following standard formats:

- Still images: JPEG, DICOM and RawDICOM (Raw data + DICOM)
- Cineloops: WMV, DICOM and RawDICOM (Raw data + DICOM)

## SaveAs

To save images to the media:

1. Insert the media into the drive or connect the USB drive to the system.
2. On the scan screen, press the left **Set** key. The arrow cursor displays.
3. Place the cursor on the image or CINE Loop in the clipboard to be saved and press **Set**. The image displays on the screen.
4. Select **SaveAs** in the lower, right-hand corner of the screen. The Save As menu appears.

*NOTE: If you have not formatted the media, the media will be formatted when you select Save As.*

*NOTE: If you save the image as an .WMV file, run the CINE Loop before you select SaveAs.*

*NOTE: You cannot save a 2D cineloop image as a .jpeg file.*



---

**SaveAs (continued)**

5. Select the media from the Save in Archive pull-down menu.
6. Folder name: You can create the folder for the saved file.
  - Default is blank (The folder is not created)
  - Max 32 characters

*NOTE: You cannot edit the folder name when the folder is opened.*

7. File Name: The name of the file is automatically filled in, but you can type a file name as well.
  - Max 64 characters

*NOTE: DO NOT use the following special characters when saving images: !, @, #, \$, %, ^, &, \*, (, ), |, :, ;, <, >, ?, /, ~, [, ], {, }, and Yen sign.*

8. Store: Select Image only or Secondary capture.
  - Image only: Saves only the ultrasound image area
  - Secondary capture: Saves the ultrasound image area, title bar, and scan information area. Not available for DICOM or RawDICOM images.

*NOTE: If you select "WMV" for Save as type, Secondary capture is disabled.*

9. Compression: Specify Compression.
  - None
  - Rle
  - Jpeg
  - Jpeg2000
  - Lossless-Jpeg

*NOTE: If you select "WMV" for Save as type, Compression is disabled.*

10. Quality: Specify image quality (between 10-100). A high quality setting gives a lower compression.

*NOTE: If you select "WMV" for Save as type, Quality is disabled.*

### SaveAs (continued)

11. Save as type: Select one of the following.

- RawDICOM: saves the still image or CINE Loop in both GE HealthCare raw format and DICOM format.
- DICOM: saves the still image or CINE Loop in pure DICOM format.
- WMV: Saves the CINE Loop in WMV(Windows Media Video) format.

*NOTE: Store "Image Only" is available if you select WMV for Type.*

*NOTE: WMV type is only available with CINE loop image.*

- JPEG: Saves the still image in jpeg format.
- JPEG2000: Saves the still image in jpeg2000 format.

*NOTE: The Save button is disabled when you select "AllFiles". Select each Save as type when you want to save data.*

If you want to see all data saved onto the local drive, select "AllFiles(\*)". All the data names display in the window.

12. For images transferring to USB, press **Save**.

The images are saved directly to the USB drives storage whenever you press Save.

- If free space of the destination is not enough to save all selected images, then warning dialog appears.
- If the same file name exists in the destination, the warning dialog displays.

**OK:** Overwrite file and continue to save selected images.

**Cancel:** Cancel.

**SaveAs (continued)**

*NOTE: The Report Save As feature is somewhat different. As soon as you select to save a report, the report is saved.*

*NOTE: If you save 3D image as an WMV file, an annotation text "COMP" appears at the top of the saved image which represents the compressed image.*

*NOTE: Time line image can be saved as multi frames image with SaveAs.*

Table 9-3: Save As Formats

	<b>.wmv format</b>
B, B+CF	Multi frames
B+Doppler	Multi frames
B+M	Multi frames
3D	N/A

*NOTE: Verify the saved image works correctly on the Windows PC. If the image does not work, please save it again on the LOGIQ Totus.*

### 'SaveAs' Images

You can select multiple images to save at one time by selecting '**SaveAs**' in the Active Image screen.

Features are almost the same as the SaveAs feature. See 'Save As' on page 9-24 for more information.

**NOTE:** *We suggest that you save the images page by page with '**SaveAs**' Images in Active Images. It takes time if you have many images or raw data.*

**NOTE:** *If the image has a filmstrip icon, this indicates a CINE Loop, which gets saved as a .wmv file; single images are saved as a jpeg file.*

**NOTE:** *'SaveAs' Images function doesn't support images which are query/retrieved.*

1. In the Active Images screen, place the cursor on the image or CINE Loop to be saved and press **Set**. You can select multi images with multi pages.
2. Press '**SaveAs**' **Images** on the monitor display or the Touch Panel. The SaveAs menu appears.
3. Ensure that Jpeg&WMV is selected, then press Save.

### Storing Images with More Resolution

To store images with more resolution than is available with the JPEG selection, select Save As and select WMV as the Save As Type. You can save single images as .WMV files.

Table 9-4: Store Options

Image Type	Store as Image Only	Store as Secondary Capture
CINE Loop	Gives you a loop of just the image (no title bar and scan information).	Gives you a single image of the video area. DO NOT DO THIS BECAUSE YOU DO NOT KNOW WHICH IMAGE FROM THE LOOP THAT YOU ARE GETTING.
Still Image	Gives you a single image (no title bar and scan information).	Gives you a single image of the video area.

# Unified Background Export

## Export from Patient Screen

1. Export exams from the Exam List on the Patient screen by selecting **Export To**.

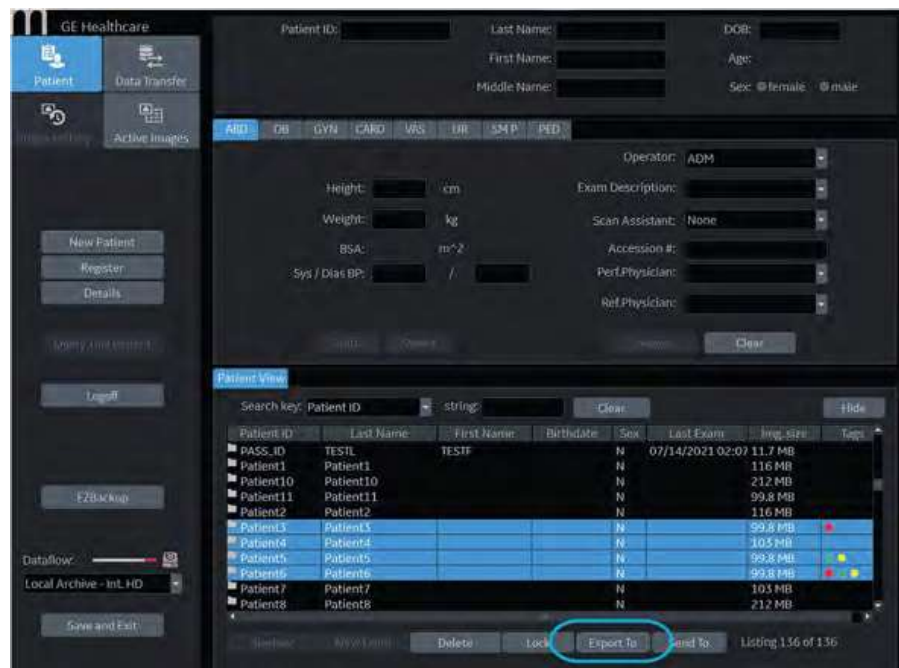

Figure 9-15. Patient Exam List

- Selected exams can be exported as DICOM or MediaFileType formats (WMFV, JPEG, etc). (DICOM is the default format.) If Export Only Tagged Images is selected the Tags will be displayed to select.

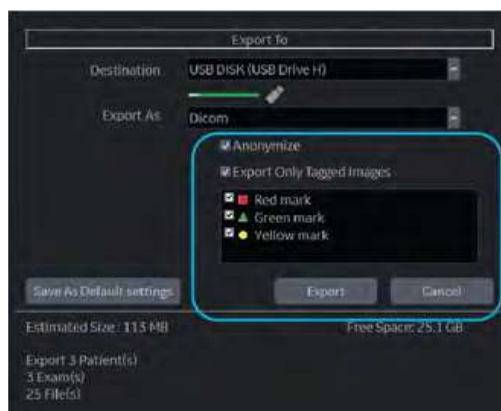

Figure 9-16. Export Dialogue with Tags

After selecting “Export” a message box appears with Anonymize Patient information. Select “OK” on the popup to proceed and select “OK” for the desired Anonymization to submit the exams to spooler for background export.

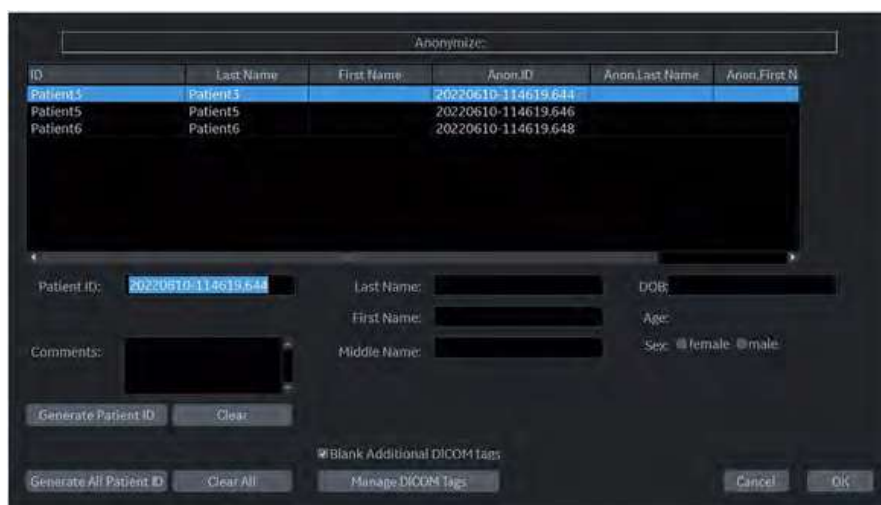

Figure 9-17. Anonymization

**NOTE:** *If the export Patient ID already exists, a prompt will appear to confirm that existing exam information may be overwritten.*

3. After submitting the job to the spooler, a message box displays the background job submission status.

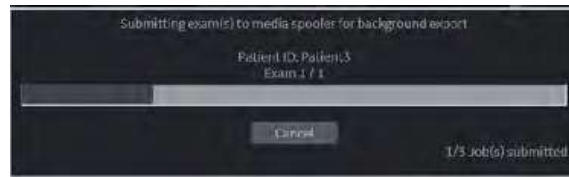

Figure 9-18. Background Export Submission Status

## Export from Active Image Screen

1. Export images from the Active Images screen by selecting the images and selecting **Export To** from the menu. Images can be exported as DICOM or MediaFileType formats (WMFV, JPEG, etc). (MediaFileType is the default format.)



Figure 9-19. Active Image Export

2. After submitting the job to the spooler, a message box displays the background job submission status.

## Spooler Screen

Launch the spooler by pressing the F4 key on the keyboard or by clicking the status bar media icon. The status bar media icon updates based upon the status of the media spooler. The DICOM spooler is accessed on the **Network Jobs** tab and the Media spooler on the **Media Jobs** tab.

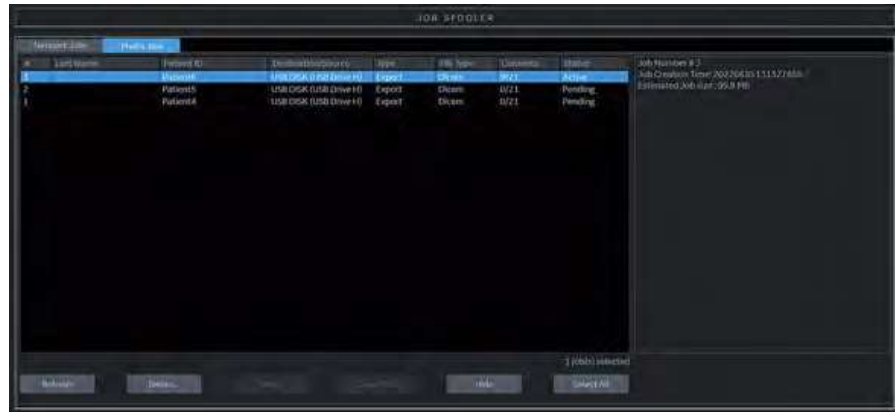

Figure 9-20. Spooler Screen



For failed spooler jobs, the error description and recommendations are displayed. **The Retry** and **Transfer To...** selections are enabled based upon the nature of the error.



## Spooler Status Icons

The Media spooler status updates with the media icons, displayed in the status bar.

Table 9-5: Media Spooler Status

Icon	Spooler Status
	Export to USB media is active.
	Failed export jobs to USB in the spooler.

If media is ejected while an active job is saving to that media, a warning message displays.

On system Shutdown, if any export is active a shutdown confirmation dialogue displays. The shutdown can be cancelled, the spooler status can be checked, or the shutdown can be continued. If the shutdown is continued, ongoing and pending spooler jobs are suspended.

**NOTE:** *The suspended jobs will not be auto resumed when the system is powered on again.*

# DICOM Viewer

This feature enables the export of a self-contained DICOM viewer to removable media, along with the transfer of selected images.

**NOTE:** *The exported DICOM Viewer software is a GE HealthCare developed DICOM Viewer. It is standalone software to display ultrasound images exported from GE HealthCare LOGIQ Ultrasound systems.*

**NOTE:** *This viewer is NOT intended to be a diagnostic tool. It is only meant to be used for reference.*

## Installing the DICOM Viewer

DICOM Viewer allows the user to transfer examinations to DICOM removable media together with the DICOM Viewer. To install :

1. Place the media in any Windows PC. Open the media and click the DicomViewer.exe file to install the DICOM Viewer.

**NOTE:** *Minimal Windows PC requirements are Windows 10/ Windows 11.*

2. The License Agreement appears. Select I Agree.

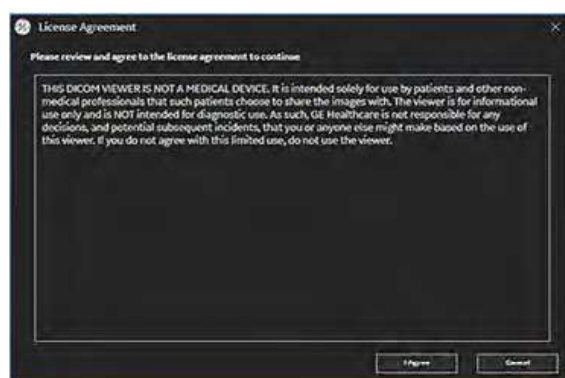

Figure 9-21. License Agreement

- The DICOM Viewer is displayed.



Figure 9-22. DICOM Viewer

## Configuring the DICOM Viewer

The user can configure the embedding of the DICOM viewer on the media on the Export To screen.

- Export exams from the Exam List on the Patient screen by selecting Export
- Check Add DICOM Viewer to Media. The DICOM Viewer will be exported when transferring examinations to the corresponding DICOM removable media.



Figure 9-23. Add DICOM Viewer to Media

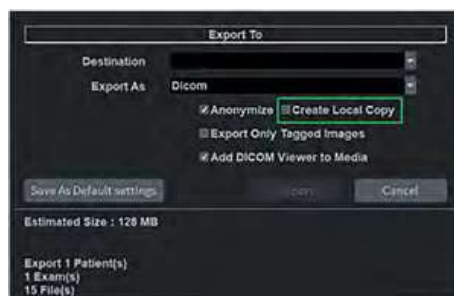

Figure 9-24. Create Local Copy

# Data Transfer

## Overview

The user can select and access the Exam Transfer services from the Exam Data Transfer screen.

- Import
- Export
- Worklist
- Q/R (Query/Retrieve)

**NOTE:** *Ensure that all patients are exported or backed up BEFORE deleting them.*

## Export/Import

To move exams from one Ultrasound system to another system or to back up/retrieve exam information, you need to export/import exam information.

**NOTE:** *Both database information and images are exported. No data is deleted from the local archive when exporting data.*

**NOTE:** *Export/Import patient records may take more than ten (10) minutes. Please allow sufficient time to export/import patients.*

**NOTE:** *You MUST verify the media you use BEFORE performing Export/Import. You must do this once each session. If you encounter problems, eject the media and then re-insert the media; then try the Export/Import again.*

**NOTE:** *If you try exporting a previously backed-up exam, the message "Can't Find Source file" displays. The image data has already been removed from the hard disk drive with EZBackup.*

**NOTE:** *It is STRONGLY recommended that you verify files on Eject when using Export.*

## Importing Data

To import an exam(s) to another Ultrasound system:

1. At the other Ultrasound system, insert the media.
2. Press **Patient** and select **Data Transfer**.
3. The Data Transfer screen displays. Press Import.
4. Select the media from the Transfer From pull-down menu.
5. The Transfer From search field shows the patients available for import from the removable media you just loaded onto the system.
6. Select the patient(s) or the exam(s) from the list to be imported.
7. Press Transfer. The progress bar displays during the transfer.
8. Please wait for the patient information to be copied to this Ultrasound system. Informational messages appear while the import is taking place.
9. Press **F3** to eject the media.

*NOTE: Use Import to restore EZBacked up and images.*

*NOTE: You can retrieve from the media to the local drive, playback, or process exam information on the system as Raw Data.*

## DICOM Import

You can import the graphics which has DICOM DIR from USB.



### CAUTION

If the following message displays, there is a possibility that Import may not work properly (“Data detected is not LOGIQ Totus. Measurements and RawData will not transfer.”).

## Worklist (Search and retrieve the Patient/Exam information)

*NOTE: Before you retrieve data from the Worklist server, make sure that default IP address is input in the Default Gateway field in Utility -> Connectivity -> TCP/IP.*

*NOTE: You need to select the patient prior to sending images to a PACS.*

1. Press **Patient** and select **Data Transfer**. The Data Transfer screen displays.
2. Select Worklist. The patient/exam list in the Local Archive displays in the Transfer To section.

*NOTE: Only "Local Archive - Int.HD" is enabled for Transfer To.*

3. The Worklist used last time is displayed on the monitor display. Press Refresh to refresh the list or select another Worklist server from the Transfer From pull-down menu.

*NOTE: The worklist server is configured in the Utility screen. Multiple servers are able to be configured.*

*NOTE: You can configure whether the auto-refresh worklist has been enabled/disabled in the Utility screen. The system automatically refreshes the list when the exam data transfer accesses the Worklist server or changes the Worklist server.*

4. Select the patient(s) or the exam(s) from the list.
5. Press Transfer. The progress bar displays during the transfer.

# External drives

## Intended Use

Removable media can be used for the following purposes:

- Backup of patient database and system configuration presets (see 'System Backup and Restore Preset Menu' on page 10-20)
- Export to copy a set of patient records to a third party DICOM review station.
- Copy of system configuration presets between to units using the Backup/Restore feature (see 'Preset Synchronization Using Media' on page 10-193).
- SaveAs: Save images as JPEG, WMV, DICOM and RawDICOM for review on a standard Windows computer.
- Privacy and Security Encryption. See Chapter 12 for more information.

## Supported removable media

The following removable media are supported:

- USB Flash Drive
- USB external hard disk drive

No matter which media is used, it is always highly recommended to make a backup of the media, which is the responsibility of the customer.



### HINTS

Keeping your media disc in an original media case or caddy all the time will prevent it from becoming dirty or damaged.

## USB Hard Disk Drive and USB Flash Drive

### Cautions and Warnings



**WARNING**

Before removing the USB drive from the USB port, press Eject (F3) and select USB Drive from the pull-down menu. Disconnect the USB drive after the success dialogue is displayed. If the unsuccessful dialogue is displayed, retry after a while. Failure to follow these instructions could result in loss of patient data.



**WARNING**

If a problem occurs while exporting to the USB-HDD, such as a crash, the export may not have completed. Try again with a smaller number of patients.



**WARNING**

DO NOT use “Select All” when you export the patient data to the USB-HDD.

**NOTE:** *Connect USB Flash Drives and Hard Disk Drives to the USB ports located on the Touch Panel (USB 3.0). Connect peripheral devices to the USB ports located at the rear of the system. (USB3.0).*

**NOTE:** *Do not insert USB Memory devices (hard drives or flash drives) that contain multiple partitions into the scanner. Use single partitioned USB Drives.*

**NOTE:** *Some USB memory device manufacturers allow for executable partitions or ship pre-formatted new USB memory devices with multiple partitions pre-configured. BEFORE inserting any memory device into the scanner, insert it into a PC or MAC to verify that there is only a single partition. If multiple partitions exist, contact the USB manufacturer for the steps in reformatting the memory to a single partition.*



## USB Ports



### CAUTION

Non-supported peripheral devices that use their own AC power source **CANNOT** be attached to the LOGIQ Totus. **DO NOT** connect the peripheral device's power cord into the LOGIQ Totus system. Only peripheral devices purchased from GE HealthCare with the purpose of being used with the LOGIQ Totus system should be used.

Use a USB printer cable that is less than 3 meters in length.

Failure to follow these instructions could lead to unexpected diagnostic performance.

## System USB Ports

### Side of Monitor

The two Monitor USB 2.0 Ports **SHOULD ONLY BE USED** for Bus-powered USB Hard Disk Drives and USB Flash Drives. The following configurations can be used:

- One or two USB Flash Drives
- One Flash Drive and One Bus-powered Hard Disk Drive
- One Bus-powered Hard Disk Drive



### CAUTION

**DO NOT** plug in **TWO** Bus-powered Hard Disk Drives at the same time.

### Operator Panel and Rear of System

The two USB 3.0 ports on the Touch Panel and at the back of the system SHOULD ONLY BE USED for the following devices:

- Color or Report Printer

*NOTE: When connecting an external printer to the LOGIQ Totus via the USB port on the back of the system, you MUST ensure that the power supplied to the printer is fed from the same power feed as the LOGIQ Totus. This assures compliance to leakage currents.*

- Footswitch
- PC Printer with isolation USB
- USB Storage (USB-HDD and USB Flash Device)

### Ejecting a USB Flash Drive/USB HDD

1. To eject a removable media, always press **F3**.
2. The Eject device menu is displayed. Select the relevant media.
3. Select USB Drive from the pull-down menu to disconnect the USB Drive. Disconnect the USB drive after the success dialogue is displayed.

Remove the USB Drive from the USB port.

*NOTE: If the unsuccessful dialogue is displayed, retry after a while.*

*NOTE: Verify is NOT available on Flash Drives or Hard Disk Drive media.*

## SaveAs

*NOTE:* See 'Save As' on page 9-24 for more information.

To save images to the USB Flash Drive or USB HDD,

1. Insert the USB Drive into the USB port.
2. Select the image(s) to be saved.
3. Select **Save As** menu in the lower, right-hand corner of the screen. Select the USB Drive as the archive media.
4. Specify: Image only or Secondary Capture, type of compression, quality, and image save format (Raw DICOM, DICOM, Jpeg, or WMV).
5. Press **Save**. When the images have been saved, press **Eject (F3)**.

*NOTE:* If you perform the SaveAs function to the USB drive (:\\Export) by RawDICOM format and review the data on your PC, the title of the data appears as  
“:\\GEMS\_IMG\\2006\_Oct\\08(date)\\xxxxx(PatientID)”.

## Direct SaveAs

You can save the image directly to the USB Drive just by pressing a **Print** key.

1. Insert the USB Drive into the USB port.
2. Select **Save As** from the pull-down menu in Utility -> Connectivity -> Service. Press **Add**.
3. Select **Save As** in the list. Rename it in the Name field if needed.
4. Select USB Drive in the Destination field.
5. Verify the service.
6. Press **Save**.
7. Assign Save As to the appropriate print key in Button tab.
8. Display the image on the monitor and press the print key.

### Export/Import

To export/import exams using the USB Flash Drive or USB HDD,

*NOTE: Before you export exams to the USB HDD, check “Export to USB HDD: Create DICOMDIR” in Utility -> Connectivity -> Miscellaneous. If you uncheck this parameter, you must import the data to review.*

1. Insert the USB Drive into the USB port.
2. On the Patient menu, select Data Transfer, then Export/Import. Specify USB Drive in the transfer To: pull-down menu. Select the patient/exam you want to transfer. Press **Transfer**.
3. When Export/Import has completed, press **F3**.

### EZBackup (USB HDD only)

1. Select “USB Drive” on the Utility -> Backup/Restore -> EZBackup -> Media.
2. Follow instructions for EZBackup. See ‘EzBackup’ on *page 10-73*
3. When EZBackup has completed, press **F3**.

## USB Quick Save

USB Quick Save easily sends images to a USB flash drive storage.

The images are stored either in .jpg or .WMV format.

## USB Quick Save Setup

In Utility -> Connectivity -> Service, select USB Quick Save.



Figure 9-25. Service USB Quick Save

## Assigning USB Quick Save to Print Keys

The USB Quick Save service can also be assigned to the Print keys via the Utility -> Connectivity -> Button preset menu.

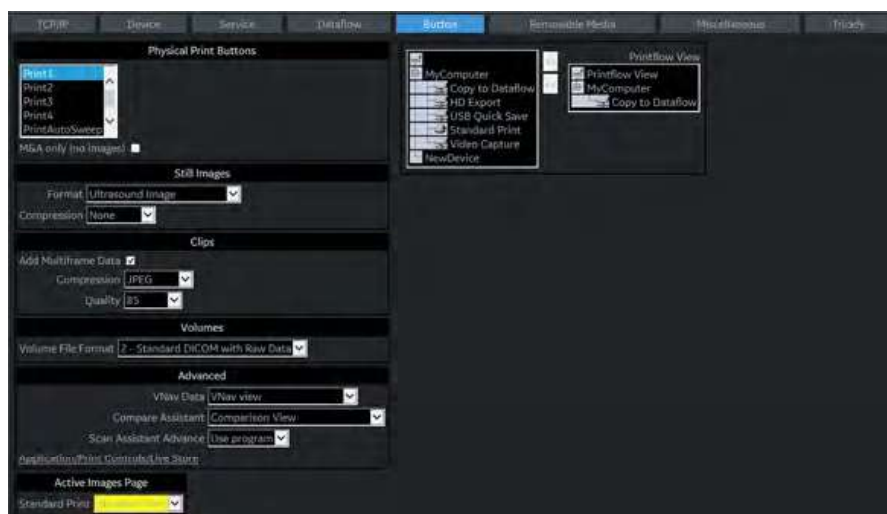

Figure 9-26. Assigning USB Quick Save to Print Keys

# Printing Options

## Setting up Digital Peripherals

Set up digital peripherals from the Utility --> System --> Peripherals menu.

The following printers can be connected to the power outlet supplied by the system.

- BW Printer: UP-D898DC

For the UP-DR80MD and UP-D25MD, insert the USB cable into the USB port of the rear panel and plug it into a wall socket.

*NOTE: Printing using a standard printing service overrides the orientation and N-up feature of the printer preferences. Printer preferences are set up in the printer folder (via Utility --> System --> Peripherals. Select Properties under Standard Printer Properties).*

## Digital Printer Setup

There are two steps to do when setting up a digital printer:  
1) follow the procedure below for each printer, then 2) set up specific properties for each printer (specific instructions are provided for each printer following this section).



### CAUTION

- Before powering on the LOGIQ Totus, connect the printer via the USB cable and turn the printer power on.
- DO NOT remove the cable while the LOGIQ Totus is powered on.

Follow this procedure for each printer:

1. Select Utility--> Connectivity--> Service. Add the Standard Print service. Select the printer from the Printer pull-down Properties menu. For the UP-D898DC printer, select "Portrait" as orientation.
2. Type the printer name in the Name field. This name is used on the Button screen. After you select the printer from the Printer pull-down Properties menu again, it turns white. Press Save.
3. Select Button. Select the appropriate print key (Print1, Print2...) from the Physical Print Buttons section. Select the printer from the MyComputer column and press >> to move it to the Printflow View column. Press Save.

## Sony UP-D25MD Instructions

Follow these steps to set up the paper size of Sony UP-D25MD printer.

1. Press Utility-->System-->Peripherals. Select the UP-D25MD from the pull-down menu under Standard Printer Properties. Click **Properties**.



Figure 9-27. Standard Printer Properties

2. Select Properties.

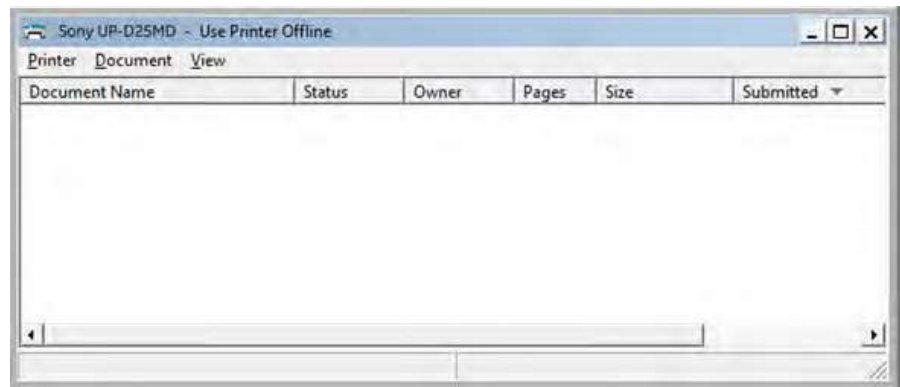

Figure 9-28. Properties

3. Select Printing Preferences. Select Paper Size. Press **Apply**. Press **OK**. Press **Save**, then **Exit**.



Figure 9-29. Printing Preferences



## Notes for Sony UP-DR80MD



### CAUTION

- Before powering on the LOGIQ Totus, connect the UP-DR80MD and turn the printer power on.  
There is no warning to let you know that the printer is not functioning. Check the printer.
- DO NOT remove the cable while the LOGIQ Totus is powered on.
- DO NOT plug in a DR80MD while the LOGIQ Totus is turned on.

## UP-D898DC Printer Settings

Preferred printer settings for the UP-D898DC are shown below; and instructions follow.

Table 9-6: Recommended Settings

Recommendations	Use These Settings
Recommended Setting	<ul style="list-style-type: none"> <li>• Paper Size: <b>1920x1280</b></li> <li>• Windows Orientation: <b>Landscape</b></li> <li>• Utility--&gt; Connectivity--&gt; Service--&gt; Standard Print--&gt; Orientation: <b>Landscape</b></li> </ul>
Avoid using WIDE Setting	Utility--> System--> System Display--> Use the settings below: <ul style="list-style-type: none"> <li>• Utility--&gt; System--&gt; System Display--&gt; Image Display--&gt; Image Display Area: <b>Default or Large</b></li> <li>• Utility--&gt; System--&gt; System Display--&gt; Use Wide Screen For... -- <b>turn OFF all parameters</b></li> </ul>
Use Large Print Setting	<ul style="list-style-type: none"> <li>• Paper Size: <b>1920x1280</b></li> <li>• Windows Orientation: <b>Landscape</b></li> <li>• Utility--&gt; Connectivity--&gt; Service--&gt; Standard Print--&gt; Orientation: <b>Portrait</b></li> </ul>

### Setting up the UP-D898DC Printer Settings

1. Select Portrait for Orientation in Utility -> Connectivity -> Service--> Standard Print and press Save.
2. Select Utility ->System ->Peripherals.
3. Select the printer to adjust (UP-D898DC) from the pull-down menu under Standard Printer Properties. Click Properties.
4. Select Properties from the Printer pull-down menu.
5. Click Printing Preferences at the bottom of Properties Window.
6. Select the Layout tab and select:
  - Paper: 1920x1280
  - Orientation: Landscape
  - Interpolation Method: Bilinear
7. Select the Density Adjust tab and select:
  - Gamma: TONE2
  - Sharpness = 0; Dark = 0; Light = 0; Sharpness = 2
8. To save the adjusted printer settings, click Apply and then OK.
9. Close the 'Printers' window with the close button.
10. Exit System Setup with Save&Exit.
11. Assign the Printer to the remote keys.

## Network Printer

A network printer can be added to the system.

**NOTE:** *It is solely the customer’s responsibility to determine printer and network settings and configuration to enable and ensure the specific network printer usage and functionality.*

### Add Network Printer

To add a network printer, the user must be logged on to the system as an administrator.

1. On the Utility ->System ->Peripherals page, Under “Network Printer,” select **Add Network Printer**.



Figure 9-30. Network Printer

The “Add Printer” Dialog Box appears.

### Add Network Printer (continued)

2. In the Add Printer dialog box, enter a Printer Name, the IP Address of the desired printer, and select the Printer Driver. Select "Add Printer."

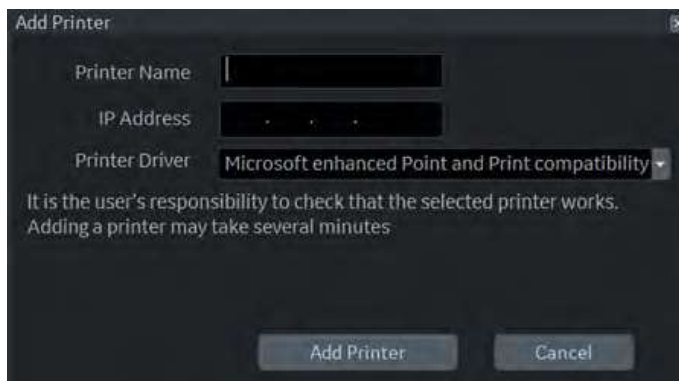

Figure 9-31. Add Printer

Adding a printer may take several minutes. A dialog box confirming installation displays when the printer has installed. Select "OK."

**NOTE:** *Printer installation does not guarantee the printer will function correctly. The printer may install even if the IP address is incorrect or inaccessible.*

3. After installing the printer, go to Utility -> Connectivity to add a Standard Print Service and a Print Button (see 'Digital Printer Setup' on page 9-47).

Print a test exam image or report and verify the full image or all information has printed. Verify the resolution, aspect ratio, clarity and color accuracy of the prints.

## Remove Network Printer

To remove a network printer, the user must be logged on to the system as a Network Administrator.

1. On the Utility ->System ->Peripherals page, Under “Network Printer,” select **Remove Network Printer** (Figure 9-30 on page 9-51).
2. Select the printer to remove from the drop-down list and select “Remove Printer.”

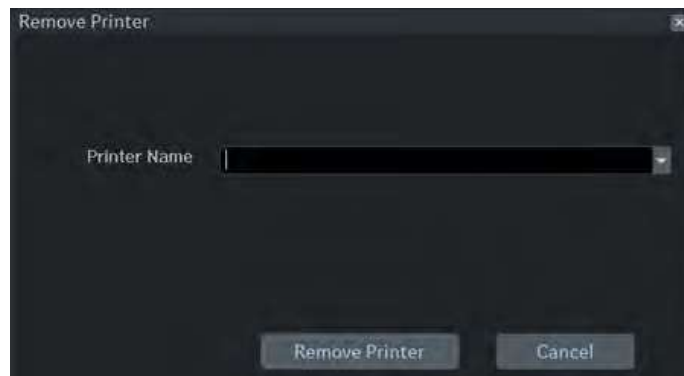

Figure 9-32. Remove Printer

A dialog box confirming printer removal displays when the printer has been uninstalled. Select “OK.”

## External Paper Printer

You can connect an external paper printer via the USB connection.



CAUTION

ONLY plug in devices to the USB ports located at the rear of the system WHILE the LOGIQ Totus is NOT powered up. If you plug in a device while the LOGIQ Totus is powered on, your system may become unusable.



CAUTION

DO NOT place an external paper printer inside the patient environment. This assures compliance to leakage current.

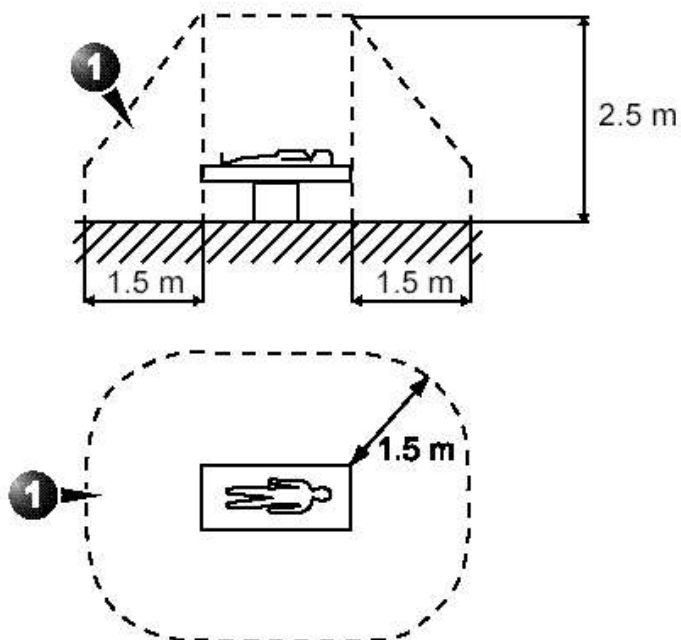

Figure 9-33. Patient Environment

## External Paper Printer Setup

**NOTE:** The printer driver is customized for the LOGIQ Totus at the factory; you do not need to change the settings.

1. Connect the printer to the USB port.
2. Select **Utility--> Connectivity--> Service**. Add the **Standard Print** service.

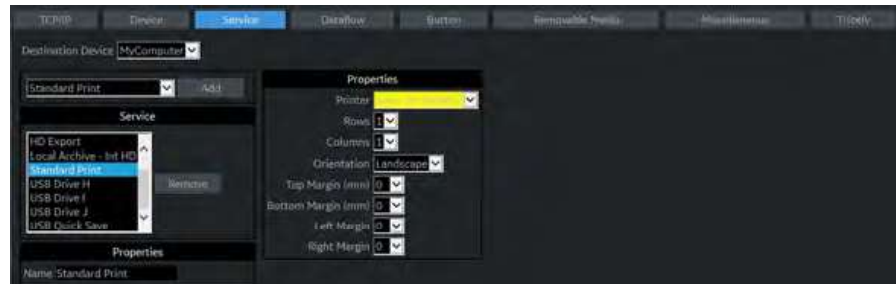

Figure 9-34. Connectivity -> Service Screen

3. Select the printer from the Printer pull-down Properties menu.

**NOTE:** After selecting the printer, the field turns white.

4. Set the following parameters in Properties: Rows, Columns, Orientation, and Right Margin.
  - *Rows=3*
  - *Columns=2*
  - *Orientation=Portrait*
  - *Right Margin (mm)=10*

5. Type the printer name in the *Name* field.

**NOTE:** This name is used on the *Button* screen.

### External Paper Printer Setup (continued)

6. Press **Save**, then select the **Button** tab.
7. Select the appropriate print key (**Print1**, **Print2...**) from the **Physical Print Buttons** section.
8. Select the printer from the **MyComputer** column and press **>>** to move it to the **Printflow View** column.



Figure 9-35. Connectivity -> Button Screen

9. If you want to assign this printer to the **Standard Print Button** on the **Active Image Screen**, select this printer at the **Active Image Printer** section.
10. Press **Save**.

**NOTE:** *Adjust the rows, columns, and margins as necessary to obtain the image size and quality that you find acceptable.*



## Setting up the Printer to Print Reports and Patient List Print

To set up the external printer to print reports and Patient List Print,

1. Press **Utility--> System--> Peripherals** and select **Printers** under Setup.
2. Select the printer from Default Printer pull-down menu.

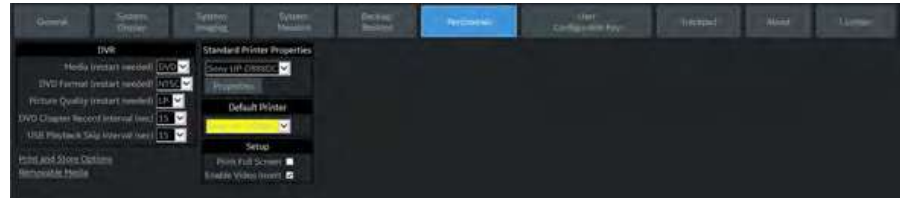

Figure 9-36. Report Printer Setup

3. Press **Save**.
4. Press Print on the Report screen to print the report.

# Portable Exam

## Perform a Portable Exam (Using the Worklist)

To perform a portable exam (using the worklist),

1. Go to the worklist and get the patient(s) you will need for this portable exam(s).
2. Ensure that images will be saved to the local hard drive.
3. Press the Power On/Off switch.
4. Proceed to perform the exam(s). Press Power On/Off. Select the patient, do the exam. Store images. Images are held in the spooler.
5. If there are additional patients to scan, repeat steps 4 and 5. After you have completed all portable exams, press Power On/Off.
6. When you have returned from performing the portable exam(s), reconnect to the network. Press Power On/Off.
7. Press F4. Send all of the images in the spooler to the printer/storage device.

---

## *Chapter 10*

# Customizing Your System

*Describes how to create system, user, and exam presets.*

## Overview

Preset Menus provide the following functionality:

### Utility, Page 1 Configuration Menus

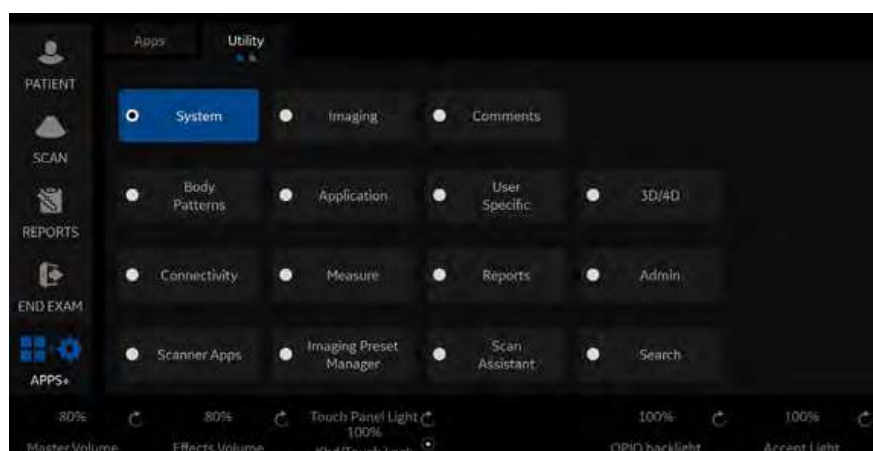

Figure 10-1. Utility Menu, Page 1

- **System presets.** View and update general system configuration settings, measurement and analysis settings, and video settings; backup and restore data and configuration files.
- **Imaging presets.** View and update exam and imaging parameters.
- **Comment library presets.** Set up comment libraries by application.
- **Body Pattern library presets.** Set up body pattern libraries by application.
- **Application and User Defined presets.** Configure application- and user-specific settings.

---

## Overview (continued)

### Utility, Page 1 Configuration Menus (continued)

- **User Specific.** Configure My Desktop.
- **3D/4D.** Real-time 4D and Static 3D scanning.
- **Connectivity Setup.** Define connection and communication setup, DICOM, Wireless Networking, Tricefy, and includes exam dataflow information.
- **Measurement and Analysis presets.** Customize exam studies, create measurements, set up manual sequencing, and create OB Tables. Refer to the “General Measurement and Calculations” chapter for more information.
- **Reports Presets.** Allows you to edit the report template, diagnosis codes, and report comments. Refer to the Advanced Features chapter for more information.
- **Administration presets.** Perform system administrator activities such as setting up user IDs and logon format.
- **Scanner Apps.** Configure AFI and AutoEF.
- **Image Preset Manager.** Activates the Image Preset Manager to create, edit, import, and export user imaging presets.
- **Scan Assistant.** Create, import/export, and manage Scan Assistant programs.
- **Search.** You can search for a parameter on the Utility pages (Measure, Reports, and Service pages cannot be searched.)

### Overview (continued)

#### Utility, Page 2 Configuration Menus

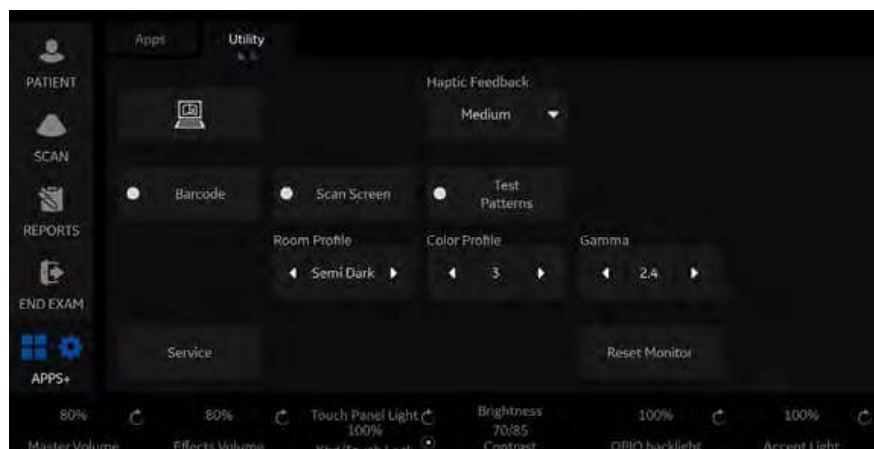

Figure 10-2. Utility Menu, Page 2

- **Electronic Instructions for Use (eIFU) Icon.** Activates the Online User Manual.
- **Haptic Feedback.** Controls the strength of the haptic feedback.
- **Barcode.** Configures barcode input setting.
- **Scan Screen.** Activate the Scan Screen so that you can adjust the monitor's brightness/contrast via the **Room Profile** control and adjust the monitor's RGB level/color temperature/gamma via the **Color Profile** control.
  - **Room Profile.** Change Brightness and Contrast of main display when set to **User Defined**.
  - **Color Profile.** Control RGB level, color temperature, gamma, etc.
  - **Gamma.** Set the Gamma at 2.2 or 2.4.
  - **Color Space (OLED only).** Select ITU 709 Standard for High Definition TV, Native 1 for most vivid OLED colors, or Native 2 for a setting between ITU 709 and Native 1.
  - **Reset Monitor.** Resets the monitor to system default settings.
- **Test Patterns.** Test the Monitor screen's performance.
- **Service.** Activate the Service Browser.

To access these functions, select the **Utility** tab on the Touch Panel, then select the appropriate Touch Panel key.

---

## Overview (continued)

In addition, you can adjust the following via the rotaries located beneath the Touch Panel.

- **Master Volume.** Select to adjust the system volume, e.g., Doppler volume.
- **Effects Volume.** Select to adjust the system notifications, e.g., Touch Panel pushes, Print sounds, etc.
- **Touch Panel Light.** Select to adjust the brightness of the Touch Panel.
- **Kbd/Touch Lock.** Select to lock the Keyboard and Touch Panel controls in order to clean the system.
- **Brightness/Contrast.** Select to adjust the monitor brightness/contrast.
  - User-adjustable when **Room Profile** is set to “**User Defined.**”
- **Control panel backlight.** Controls the level of brightness of the blue and green backlights on the hard keys.
- **Accent Light.** Controls the level of brightness of the probe port LED.

# System Presets

## Overview

System presets allows you to view or change the following parameters

- **General** – Location, Date/Time, Patient Info, Key Usage, and Utility configuration
- **System Display** - Presets related to the monitor display format.
- **System Imaging** – CINE Loop Store, Cardiac, Biopsy Guides, and Image Control and Display configuration
- **System Measure** – Measurement, Cursor, and Results Window configuration
- **Backup/Restore** – Backup, Media, EZBackup, Detailed Restore of User Defined
- **Peripherals** – DVR, Print and Store Options, and Setup configuration
- **User Configurable Key** -- BT (Breakthrough) Key, Keyboard Key
- **About** – Release information and part numbers for: Application Software (including version), Online Help, Service Platform, Security Package, Base Image and Base Image Update.
- **Licenses** – Licenses for software used on the LOGIQ Totus.
- **Scanner Apps Info** – Information of the installed Plug-in Applications.



## Changing system parameters

To change system parameters:

1. On the Touch Panel, select **Utility**.
2. On the Touch Panel, select **System**.  
The System screen is displayed.
3. On the monitor display, move the **Trackball** to select the tab that has the information you want to change.
4. Select values for the parameters you want to change.
5. To save the changes, select the **Save** button. Select **Exit** to return to scanning. In some cases, you may need to reboot the system for the change to take effect.

### System/General Preset Menu

The System/General screen allows you to specify hospital name and system date and time.

Table 10-1: Location

Preset Parameter	Description
Hospital	Type the institution's name.
Department	Type the institution's department name.
Machine Description (1&2)	Type the machine name.
Preset Region (restart needed)	Select region (None or Europe).
Language (restart needed)	Select the appropriate language from the drop-down list. Note: If you select Japanese (JPN), only the warning and status messages are displayed in Japanese. You can not type in Japanese.
Online Help Language	Select the language you would prefer to use to read the online user manual.
Units	Select metric or US units of measurement.
Regional Options (restart needed)	Select to set up the keyboard.

Table 10-2: Date/Time

Preset Parameter	Description
Time Format	Select the time format: 12 Hr. AM/PM or 24 Hr.
Date Format	Select the date format: dd/mm/yyyy, mm/dd/yyyy, or yyyy/mm/dd.
Default Century	Select the default century for the system to use.
Date/Time (restart needed)	Select to display the Date/Time Properties window, to specify the system date, time, time zone, and to auto adjust for daylight savings time.

Table 10-3: General User Interface

Preset Parameter	Description
Color Level (restart needed)	Select the darkness of the utility pages and any message windows: Brightest, Bright, Standard (Dark Text), Standard (Light Text), Dark, Darkest.

Table 10-4: Title Bar

Preset Parameter	Description
Hide Patient Data	<ul style="list-style-type: none"> <li>• <i>Always</i> - Patient information is removed from the scanning screen Title bar (and while storing images).</li> <li>• <i>On Store</i> - Patient information is removed only when storing the image.</li> <li>• <i>Never</i> - Patient information is always displayed.</li> </ul> <p>NOTE: Upon recall of images with measurements, Dual image and/or V Nav, the DICOM image is recalled. In this case, there is no patient data burned into the DICOM image. If you want the data to appear on the image, set to <b>Never</b>.</p>
Hide DateTime	<ul style="list-style-type: none"> <li>• <i>Always</i> - Date and time is removed from the scanning screen Title bar (and while storing images).</li> <li>• <i>On Store</i> - Date and time is removed only when storing the image.</li> <li>• <i>Never</i> - Date and time is always displayed.</li> </ul> <p>NOTE: Upon recall of images with measurements, Dual image and/or V Nav, the DICOM image is recalled. In this case, the date and time are not burned into the DICOM image. If you want the date and time to appear on the image, set to <i>Never</i>.</p>
Font Size (restart needed)	Select to display patient information in the title bar using a small or large font size. You need to reboot the system for this change to take effect.

Table 10-5: Worksheet

Preset Parameter	Description
Use Bold Worksheet Fonts (Restart Needed)	Select to bold fonts in Worksheets. The setting will take effect when the system is restarted.

Table 10-6: Trackball

Preset Parameter	Description
Speed	Set how fast you want the Trackball to move while performing actions such as tracing the anatomy. Speed is used for Menu and Scan Mode. 0=Slow; 20=Very Fast
Acceleration	Set how fast you want to Trackball to move across the display. Acceleration is used for Menu and Scan Mode. 0, 1, and 2 with 0 being the slowest acceleration.

Table 10-7: Key Usage

Preset Parameter	Description
Run Fast Key speed	Select the maximum value of the key interval when running Fast Key.

Table 10-8: Utility

Preset Parameter	Description
Prompt for Save on Exit	If selected, the system prompts you to save data when you select exit without saving.

Table 10-8: Utility (Continued)

Preset Parameter	Description
Utility Font Size	Select the font size you want to use to view the Utility menus: Small, Medium, or Large.

Table 10-9: Scan Assistant

Preset Parameter	Description
Use Doppler Cursor	Use the Doppler Cursor when you activate Scan Assistant.

Table 10-10: Start Assistant

Preset Parameter	Description
Use Start Assistant	<ul style="list-style-type: none"> <li>• <i>On: Use Exam Description (default)</i> - Saves exam mapping automatically from worklist</li> <li>• <i>On: Use Scan Assistant only</i> - Exam description is ignored and selection of probe and preset is based on Scan Assistant protocol only. Exam Category and Scan Assistant program are not automatically selected. Start Assistant Editor does not show the Exam description column. Manual entry of an Exam Description for table entry is prevented.</li> <li>• <i>Off</i></li> </ul>
Create/Edit	Select to open Start Assistant Mapping Editor.

Table 10-11: V Nav

Preset Parameter	Description
Max.non US images per exam on Image History	Specify the number of non-Ultrasound images per exam to appear on the Image History page.

Table 10-12: Touch TGC

Preset Parameter	Description
Delay Time for Auto Hide (sec)	Off, 3, 6, 8, 12, 16
Custom Settings	Select Application or Category
Include TGC Curve when Saving Presets	Check to select.

Table 10-13: Miscellaneous

Preset Parameter	Description
Reset Control Panel Park Lock	Press to reset operator panel park lock.

Table 10-14: Touch Keyboard

Preset Parameter	Description
Auto Popup Keyboard on Patient Screen	Display Touch Keyboard automatically when Patient screen is selected.
Auto Hide Delay Time for Touch Keyboard (sec)	Off, 6, 8, 12, 16, 20, 24, 30
Display Keyboard with Comment Button	Display Touch Keyboard automatically when Comment mode is activated.

Table 10-15: Voice Control

Preset Parameter	Description
Enable Voice Control	Select to enable Voice Control.
Language	Choose the language you want to use for Voice Control. Voice Control is currently available only for US English.
Wake with 'Hey LOGIQ'	Select to activate Voice Control with your voice.
'Hey LOGIQ' Sensitivity	Choose how sensitive Voice Control to be when it responds to "Hey LOGIQ" (0, 1, 2, 3, 4).
Time Out after No Speech (sec)	Stop Voice Control after a specified period of no speech (5, 15, 30, 120, Never)
Show Live Captions	Display live captions in real-time
Continuous Mode	Check if you want the voice control is on continuously.
Cine Back on Freeze (sec)	Select time by which cine back after recognition of the Freeze command (0.0, 1.0, 1.5, 2.0, 2.5).
Audio Input	Adjust the audio input volume.

Table 10-16: Front LED

Preset Parameter	Description
Front LED Brightness	Select the brightness of front LED from 1 to 10
Enable Voice Control Indicator	Check to enable Voice Control Indicator
Enable Battery Indicator	Check to enable Battery Indicator
Battery Mode	No function, Front LED color on Battery Mode
Low Battery	No function, Front LED color on Low Battery
Battery Warning	No function, Front LED color on warning of low battery

## System/System Display Preset Menu

The System/System Display screen allows you to specify parameters for the Monitor Display.

Table 10-17: Image Display

Preset Parameter	Description
Image Display Area	Select Image Display Area Size: Default, Large, Extra Large
Image size (probe selection required)	Select Default or Large.
Use Magnification Zoom (preset selection required)	Select to enable Magnification Zoom on images (enabled by default).

Table 10-18: Side Panel Content

Preset Parameter	Description
Side Clipboard	Display On/Off.
My Desktop	
Measurement Summary	

Table 10-19: Clipboard

Preset Parameter	Description
Preview Image	Display On/Off
Show Zoom Reference Image	
Bottom Clipboard	Display On (Always display)/ Off (Never display)/ Auto (Display whenever there is no side clipboard)
Bottom Clipboard Auto Dimming	On/Off/Auto When the windows pointer is moved over the clipboard area, the pointer is undimmed.
Side Clipboard Auto Dimming	

Table 10-20: Use Wide Screen for...

Preset Parameter	Description
Dual Screen	Automatically switch to Wide Screen when in Dual Screen.
DualView (Simultaneous)	Automatically switch to Wide Screen when in Simultaneous DualView Screen.
Contrast DualView	Automatically switch to Wide Screen when in Contrast DualView Screen.
LOGIQView	Automatically switch to Wide Screen when in LOGIQView.

Table 10-20: Use Wide Screen for... (Continued)

Preset Parameter	Description
Volume Nav	Automatically switch to Wide Screen when in Volume Navigation.
QAnalysis	Automatically switch to Wide Screen when in QAnalysis. Side by Side Timeline automatically switches to wide screen when in Timeline mode.
Display Format Horizontal Timeline	Side by Side Timeline automatically switches to wide screen when in Timeline mode.
Single Image	On/Off/Auto Auto turns on wide screen if 2D image exceeds width of non wide screen image area.

Table 10-21: Display

Preset Parameter	Description
Horizontal Scale	Select to display width markers.
TGC Display	Select to display TGC curve.
PW Velocity Units in cm/s	Select to change scale on timeline from centimeters per second to meters per second.
Shear Elasto Display Units	Select m/s or kPa.
Shear Stiffness and Velocity Measurement	Specify whether to display Shear Wave Stiffness and Velocity measurements.
Shear Elasto Color Map	Select Red as Hard or Blue as Hard.
Strain Elasto Color Map	Select Red as Hard or Blue as Hard.
UGAP Display Units	Select dB/cm/Mhz or dB/m
Attenuation Coefficient and Rate Measurement	Select to display Attenuation Coefficient and Rate Measurement
Image Parameter Size (restart needed)	Choose Small, Medium, Large, or Extra Large. Must reboot the system.
Highlight Image Parameter Changes	Select if you want the display to indicate which controls you adjusted by highlighting the new value on the display.
Use Thicker V Nav Graphics	Select to display thicker V Nav graphics
Overlay Color (single visible dataset)	Select Red, Green, Blue or BW (Black/White).
PET Color in V Nav (if grayscale-only dataset)	Select Hot Body, Hot Metal, Warm Metal, BW (Black/White).
Hide Multiple Dataset Menu When Storing	Select to hide the Multiple Dataset Menu when storing.
Live/Freeze Indicator	Display On/Off.

Table 10-21: Display (Continued)

Preset Parameter	Description
Enable DICOM grayscale display mode (GSDF)	Enable On/Off. Adjust Gamma curve on DICOM GSDF. <i>Note: With GSDF disabled, the monitor still uses a gamma curve that may be selected on the Touch Panel (for backwards compatibility with sites that are happy with their PACS or may have a mix of older systems). With GSDF enabled, the gamma button on the touch panel affects the image, emulating the appearance of that gamma, but does not affect the monitor.</i>
Room Profile	Dark, Semi Dark, Light, User Defined, Last Used



## System/System Imaging Preset Menu

The System/System Imaging screen allows you to specify parameters for key usage and image control and display.

Table 10-22: Biopsy Guides

Preset Parameter	Description
Show Center Line	Displays center biopsy guideline.
Show Outer Lines	Displays outer biopsy guidelines.
Enable 0.5cm markers	Activates biopsy depth markers every 0.5cm.
Show Biopsy Mark on CFM Simultaneous Mode	Displays the Biopsy Guideline on the image while in Simultaneous Mode.
Show Biopsy Mark on Dual View Mode	Displays the Biopsy Guideline on the image while in Dual View Mode.
Show Biopsy Circle	Specify whether to display the Biopsy Circle with the Biopsy guideline.

Table 10-23: Compare Assistant

Preset Parameter	Description
Comparison Image Side	Select Left or Right.
Comparison Image Date	Select All Dates, Different Date or None.
Copying Settings	Select Automatic: Imaging and Annotations, Automatic: Imaging Only, Automatic: Annotations Only, Manual: Imaging and Annotations, Manual: Imaging Only, Manual: Annotations Only or Off.

Table 10-24: Image Label Layout

Preset Parameter	Description
Clipboard	Select 1-Line Label, 2-Line Label, 1-Line Timer (Contrast Clock), 2-Line Timer (2 Contrast Clocks), 2-Line Both (1 Label and 1 Contrast Clock) or No Label.
Active Images	
Image History	

Table 10-25: Image Label Color

Preset Parameter	Description
Clipboard	Select the color of the Clipboard Image Label.
Active Images	Select the color of the Active Image Label.
Image History	Select the color of the Image History Image Label.

Table 10-26: Image Timer Color (Contrast Clock)

Preset Parameter	Description
Clipboard	Select the color of the Clipboard Image Timer.
Active Images	Select the color of the Active Image Timer.
Image History	Select the color of the Image History Image Timer.

Table 10-27: Contrast Clock Highlight (Interval notification for contrast examination)

Preset Parameter	Description
Clipboard	Select the interval notification by contrast clock highlight.
Active Images	Select the duration of contrast clock highlight
Image History	Select the sound of contrast clock highlight.

Table 10-28: Controls

Preset Parameter	Description
Auto Invert on Linear Steer	When selected, automatically inverts the color scale or spectral timeline when the Steer function is used.
Auto Invert on ASO	Automatically inverts the spectrum with ASO.
Link Color/Doppler Invert	When selected, the Doppler timeline scale inverts along with the color ROI.
Pushing Depth Rotary Performs Image Reverse	When selected, you can reverse the image when you push down on the Depth rotary.
Toggling Zoom Rotary Performs Depth	When selected, you can adjust the Depth by moving the toggle up and down.
Audio Volume	Adjusts the Doppler audio volume via a drop-down menu (for example, 0=softer; 20=louder).
Auto Freeze Time (probe selection required)	Automatically freezes the system after 10, 30 minutes, 1 hour of inactivity, or never.
Countdown Time For Contrast (sec)	Specify time for the Contrast Clock to countdown during a contrast study, 0 (off), 3, and 5 seconds.
Reverse Depth Control	Changes key direction for the Depth control.
Reverse Steer Controls	Changes key direction for the Steer controls.
Turn Off CrossXBeam for LOGIQView (non-linear probes)	Deactivates CrossXBeam when you activate LOGIQView.
3D Postprocessing when reloading	When selected, the system re-processes the recalled 3D CINE Loop.
Tru 3D/Easy 3D Resolution	Set Easy 3D/Tru 3D Resolution: Default, High, or Very High.
Doppler Scroll Priority	Set to 2D, Doppler, or Last Live Mode.

Table 10-28: Controls (Continued)

Preset Parameter	Description
Start Doppler in Update	Select to allow the B/CF image to continue live while the PW image is frozen in triplex.
Assign PW Sample Volume control to rotary	Select to assign PW Sample Volume control to rotary.
CF Knob Changes Shear Gain	Enables Shear Wave Elastography gain control via the CF knob on the console. Check box to enable Shear gain control with CF knob (Off by default).
Default Rotation when changing mode	Sets the default rotation when changing mode.
Default MyPreset	Check the box to start MyPreset. Uncheck the box to start ConventionalExam tab (Default).

Table 10-29: Auto Preset Assistant

Preset Parameter	Description
Enable	Enables this feature.
Default Auto Mode in new patient	Sets the default mode for automatic preset change when new patient is created. - "Automatic" : Preset is changed automatically, when scan image is classified to a different preset with a high score. - "Air Detected" : Preset is changed with a delay when scan image is classified with a high score. More specifically, preset change happens when air is detected. This is to avoid sudden preset change during scanning. - "OFF" : Preset is not changed automatically. A button (or trackball key) needs to be pressed to change preset.
Turn off Auto after changing preset	If checked, automatic preset change is disabled once preset is changed. In other words, Auto Mode becomes "OFF".
Automatically Retain Field Of View	If checked, Field Of View is retained after preset change.
Check before automatic change	If checked, a dialog is displayed to let user change or cancel preset change, during automatic preset change.
Recommendation without specifying preset	If checked, recommendation messages in the status bar do not include name of suggested preset.

Table 10-30: Auto Abdominal Color Assistant

Preset Parameter	Description
Enable	Enables this feature.
Auto Flow Model selection	If checked, automatic flow model change can happen with a high classification score.
Turn off Auto after manual Flow Model selection	If checked, automatic flow model change is disabled, if user manually selects a flow model.

Table 10-31: V Nav 3D Marker

Preset Parameter	Description
Inner Alpha	0-100
Margin Alpha	0-100
Color	Yellow, Orange, Red, Blue, Purple, Pink, or White
Margin Color	Yellow, Orange, Red, Blue, Purple, Pink, or White
Diameter (mm)	1-100
Margin Dist. (mm)	0-15 in 0.5 mm increments
Short Axis	1-100
Long Axis	1-100
Reposition	Check to reposition.

Table 10-32: EZ Settings

Preset Parameter	Description
EZ Touch Panel Page	Check to enable EZ Touch Panel on first page of B and flow mode tabs. Uncheck disable EZ Touch Panel (default).
MyPreset Shortcuts	Select "By Probe (Default)" or "By Category".
Maintain icon usage	Select "Always", "With EZ touch panel" or "Never".
B mode button	No function, Colorize, SRI HD, Reverse
Color mode button	No function, Map, Radiant Flow, Biopsy Guideline.
PDI mode button	No function, Map, Radiant Flow, Biopsy Guideline.
BFlow mode button	No function, Visualization, Background
MVI mode button	No function, Map, Radiant Flow, Biopsy Guideline.
PW mode button	No function, Simultaneous, Colorize, Wall Filter, Modify Auto Calcs, Trace Sensitivity, Quick Angle
CW mode button	No function, Simultaneous, Modify Auto Calcs, Trace Sensitivity, Trace Method, Map

## System/System Measure Preset Menu

The System/System Measure screen allows you to specify measurement parameters such as the type of default OB measurements and calculations. You can also define cursor and Results Window default functionality.

Table 10-33: Measurement

Preset Parameter	Description
Repeat Measurement	Select Repeat, No, DefaultMeasure Repeat = After you take a measurement, the system automatically starts the same measurement again. No = After you take a measurement, you have to touch a Touch Panel key or Trackball key to start another measurement. DefaultMeasure = After you take a measurement, the system automatically starts a default measurement based on the current scanning mode (B-Mode = basic length measurement, M-Mode = basic length measurement, Doppler Mode = velocity measurement except after a volume flow calculation).
OB Type	Select which OB measurements and calculations studies to use: USA, Europe, Tokyo, Osaka, or ASUM.
EFW GP	Select the source used to calculate EFW-GP Estimated Fetal Weight-Growth Percentile): Hadlock, Williams, Brenner, Kramer (f), Kramer (m), WHO.
CUA/AUA for Hadlock	Select to use CUA (Composite Ultrasound Age) or AUA (Average Ultrasound Age) as the default
Hadlock Table Type	Select Hadlock 82 or Hadlock 84 tables
EFW Formula (Europe)	Select the source used to calculate EFW (Europe) (Estimated Fetal Weight), Hadlock, Hansmann, Merz, Rich/Berk, Shep/Wars
EFW Formula (Tokyo)	Select the source used to calculate EFW (Tokyo) (Estimated Fetal Weight): Tokyo, Tokyo S-1, Tokyo S-2, Tokyo S-3.
Add 1 week to EDD	Select to add additional week to estimated date of delivery
OB Graph Display	Select Single or Quad for displaying OB Graphs.
OB Graph Single Display	Select Last Meas or EFW Single OB Graph displayed by default.
Fix Caliper by Print key	Select to use the Print key like the Set key. <i>NOTE: If you select this during a generic volume measurement, the print key does not function like the Set key, but instead ends the measurement sequence and initiates the volume calculation based on the number of measurements taken so far.</i>
LV Study using straight line	Sets straight line as the default for 2D LV studies.
Side selections of Rt, Lt and Off	Select to use "Rt, Lt and Off" for Side Selection. When not selected, displays only "Rt and Lt".
Dual Caliper on V Nav and Simultaneous.	Select to enable Dual Caliper on Volume Navigation and Simultaneous.

Table 10-33: Measurement (Continued)

Preset Parameter	Description
Map Cycle Select to Trackball Key	Map "AutoCalc cycle select" to Left/Right Set key.
Use WeekDay format for OB GA in DICOM SR	Select to use WeekDay format.
Volume Method	Select Single or Multiple for calculating volume. Single: Single volume is calculated when taking multiple L, H and W. Ex.) When take L, H, and W, them volume is calculated. After that take L, then volume is recalculated using the second L. Multiple: Each volume is calculated when taking multiple L, H and W. Ex.) When take L, H, and W, them volume is calculated. After that tale L, H, and W, then the second volume is calculated.
Display AutoContour	Check box to display the trace line of Auto Contour.

Table 10-34: Worksheet (USA/ASUM)

Preset Parameter	Description
Show Individual Growth Percentiles	Check to display individual growth percentiles on the Worksheet.
OB Range Type	Selections: Min-Max, Standard Deviation.

Table 10-35: Cursor

Preset Parameter	Description
Cursor Type	Select whether to mark measurements with numbers or symbols.
Cursor Size	Specify 12x12 or 9x9.
Cursor Line Display	If selected, after you press Set to complete a measurement, the cursor line is displayed. If not selected, after you press Set to complete a measurement, only the cursor number or symbol is displayed.
Cursor Ellipse Cross Line Display	Check box to display the cross line in Ellipse.
D Manual Trace Cross Line Display	Check box to display the cross line with the caliper.
Cursor Position	Select 1st Cursor, 2nd Cursor, or Image Center.
Color When Set (restart needed)	Select white, yellow, bright red, or orange.
Cursor is Displayed when Trackball is moved	The active cursor does not display until you move the Trackball. This assumes the following presets are set: Repeat Measurement, Repeat, Default Measurement, and Cursor.

Table 10-36: Results Window

Preset Parameter	Description
Result Window Mode Depend	Select this if you want the measurement result window to be repositioned, depending on the mode.
Result Window Position X[0-800]	You can set the coordinates for the measurement result window when you do not have the result window set to be mode dependent. This is the X coordinate (left/right)
Result Window Position Y[0-600]	You can set the coordinates for the measurement result window when you do not have the result window set to be mode dependent. This is the Y coordinate (up/down)
Result Window Location-2D	Select the Result Window location on the Monitor Display: Left-Bottom, Left-Top, Right-Bottom, Right-Top, Extreme Right-Top, or Extreme Right-Bottom.
Result Window Location-TimeLine	Select the Result Window location: Left-Bottom, Left-Top, Right-Bottom, Right-Top, Extreme Right-Top, or Extreme Right-Bottom.
Result Window Format	Select Wide or Narrow.
Font Color (restart needed)	Select White, Off White, Yellow, Bright Red or Orange (reboots the system)
Font Size (restart needed)	Select mini, small, medium, large, or extra large (reboots the system)

## System Backup and Restore Preset Menu

Table 10-37: Backup

Preset Parameter	Description
User Defined Configuration	Select to back up the user-defined configuration settings.
Service	Select to back up Service (InSite and Network) settings.
For Report templates, use Utility-> Report-> Export	
Backup	Select to begin the backup.

Table 10-38: Backup To/Restore From

Preset Parameter	Description
Location	Select media type to use for Backup, Restore and Detailed Restore. USB Drive F, Local Backup or Cloud.

Table 10-39: EZBackup

Preset Parameter	Description
Reminder Dialog Interval days	Specify the number of days after the last backup that you want the system to prompt you to perform an EZBackup procedure (only for moving images).
Enable Reminder Dialog	Select to activate the EZBackup reminder pop-up dialog.
Media	Select media type.

Table 10-40: Restore

Preset Parameter	Description
User Defined Configuration	Select to restore the user-defined configuration settings.
Service	Select to restore service InSite and Network settings.
Restore	Select to begin the restore process for the selected configuration files from media storage backup.



## System Backup and Restore Preset Menu (continued)

The detailed section of this menu allows you to restore one area at a time from the user defined configuration. This allows you to selectively restore what you want to restore across multiple machines. Check the box(es) you want to restore, insert the appropriate media, and press Restore.

Table 10-41: Detailed Restore of User Defined

Preset Parameter	Description
Imaging Presets	Select to restore imaging presets.
Connectivity Configuration	Select to restore connectivity configurations.
Measurement Configuration	Select to restore measurement configurations.
Comment/Body Pattern Libraries	Select to restore comment and body pattern configurations.
Protocol Templates	Select to restore protocol (Scan Assistant) templates.
Report Templates (Same Software Version Only)	Select to restore Report templates.
3D/4D	Select to restore 3D/4D settings.
Fast Key	Select to restore Fast Key.
Utility->Application Presets	Select to restore Utility--> Application presets.
Custom Scan Assistant Programs	Select to restore Scan Assistant programs.
All Others	Select to restore all other configurations not listed in the Detailed Restore section. This includes parameters defined on the System preset menus.
Detailed Restore	Select to begin the restore process for the selected configuration files from media backup.

Table 10-42: Local Backup or Local and Cloud Backup

Preset Parameter	Description
Backup Automatically	Select to automatically backup user-defined configuration settings to the system hard drive after a new setting or configuration is saved on the Utilities pages.

## System/Peripherals Preset Menu

The System/Peripherals screen allows you to specify video and system setup parameters.

Table 10-43: DVR

Preset Parameter	Description
Media (restart needed)	Select recording media: USB storage.
DVD Format (restart needed)	Select NTSC or PAL.
Picture Quality (reboot required)	SP, HQ, EP, LP. Extended Play or Long Play.
DVD Chapter Record Interval (sec)	Select the Interval of time recording DVD chapter from 15, 30, 60 and 120 seconds.
USB Playback Skip Interval (sec)	Select the Interval of time skipping for USB playback from 15, 30, 60 and 120 seconds.

Table 10-44: S-Video

Preset Parameter	Description
SVIDEO Output Format (restart needed)	Select NTSC or PAL.

**Print and Store Options.** Press Print and Store Options to go to the Utility --> Connectivity --> Miscellaneous setup page.

**Removable Media.** Press Removable Media to go to the Utility --> Connectivity --> Removable Media page.

Table 10-45: Standard Printer Properties

Preset Parameter	Description
Properties	Select to add an additional standard printer via the USB serial port and to configure digital printers. This activates the Windows Add Printer wizard. NOTE: Most printer drivers are available via Windows; however, newer printers may require you to load the manufacturer-supplied print driver. Refer to the Basic Service Manual for more information.

Table 10-46: Standard Printer Restore

Preset Parameter	Description
Restore Defaults	Select to restore the selected printer to default settings.

Table 10-47: Network Printer

Preset Parameter	Description
Add Network Printer	Select to add network printer.
Remove Network Printer	Select to remove network printer.

Table 10-48: Default Printer

Preset Parameter	Description
Default Printer	Select to choose default printer.

Table 10-49: Setup

Preset Parameter	Description
Print Full Screen	Select for the standard printer to print the full screen.
Enable Video Invert	Select for the standard printer to print black on white rather than white on black.

## System/User Configurable Key

The User Configurable Key screen allows you to reconfigure the User Configurable Keys and configure Trackball Key functionality.



Figure 10-3. Programmable Operator Panel Controls

Table 10-50: User Configurable Keys

Preset Parameter	Description
1 User Defined Key	Select desired function to each User Defined key.
2 - User Defined Trackball Set Key	Specify which controls you want to be used on the Trackball: <ul style="list-style-type: none"> <li>• B/B-Flow/Contrast: Auto or Frequency</li> <li>• Color Flow/TVI/PDI: Auto, Steer, or PRF</li> <li>• PW, CW, TVD: Auto, Baseline, or PRF</li> <li>• Use Set keys to change BSteer Angle (On or Off)</li> </ul>
3 - Replaceable Key caps	Replaceable key caps are provided and can be chosen to Reconfigure the user configurable keys.
Keyboard Key 0 - 9 (Not pictured)	Check "Enable" in Keyboard key menu. Select desired function to each Keyboard key.

## System/User Configurable Key (continued)



Figure 10-4. User Configurable Key Preset Menu

To reconfigure User Defined key (UD), numeric Keyboard Keys, or Trackball Keys,

1. Press Utility--> System--> User Configurable Key.  
To configure the User Defined Keys, select the function for each key (refer to Figure 10-3). There are 10 User Defined Keys.
2. To configure the numeric Keyboard Keys, select the function for each Keyboard key (refer to the illustration above). There are ten (10) Keyboard keys that are configurable.
3. To configure the Trackball Keys, select the function for each user-defined Trackball Set Keys by mode.
4. Press Save.

### Replace User Defined Key caps

To move and replace a User Defined key cap,

1. Insert the flat blade of a screwdriver into the hole on the top side of the key cap and lift it up to remove it.



2. Repeat for each key, to match how you have configured the User Defined keys.
3. Replace the key caps by positioning it and pushing down on the key cap until it clicks into place.

## System/About Preset Menu

The System/About screen lists information about the system software.

Table 10-51: Installed Software Packages

Preset Parameter	Description
Application Software	The version, revision and part number of the current software on this system.
Online Help	The current version and part number of the Online Help on this system.
Application Service Patch	The current version and part number of the Service Platform on this system.
Security Package	The current version and part number of the Security Package on this system.
Base Image	The current version and part number of the Base Image on this system.
Base Image Update	The current version and part number of the Base Image Update on this system.

Table 10-52: Copyright

Preset Parameter	Description
Copyright	Lists the copyright for the system.

## Licenses

The Licenses screen lists information about the software licensed for use on the LOGIQ Totus.

Table 10-53: Software

Preset Parameter	Description
License Titles	Scroll to select the License; the license is displayed in the License window.

## System/Scanner Apps Info

The Scanner Apps Info lists information about the installed plug-in applications.

Table 10-54: Scanner Apps Info

Preset Parameter	Description
Installed Plug-in Applications	Information of the installed Plug-in Applications.

# Imaging Presets

## Overview

Imaging screens allow you to specify parameters by Preset and Probe by Mode. For information about the specific parameters, refer to Chapter 5 Optimizing the Image.

- B-Mode (B)
- Color Flow Mode (CF)
- Power Doppler Imaging (PDI)
- Micro Vascular Imaging (MVI)
- Elastography (ELASTO)
- UGAP
- M-Mode (M)
- Anatomical M-Mode (AMM)
- Pulse Wave Mode (PW)
- Continuous Wave Mode (CW)
- Harmonics (HAR)
- B-Flow (BF)
- Contrast Reference (Ref)
- Contrast (CON)
- Tissue Velocity Imaging (TVI)
- Tissue Velocity Doppler (TVD)
- General



Figure 10-5. Imaging Preset Example

1. Preset/Application-dependent setup parameters.
2. Probe-dependent setup parameters.



## Changing imaging presets

To change imaging presets:

1. On the Touch Panel, select **Utility**.
2. On the Touch Panel, select **Imaging**.  
The system displays the Imaging screens.
3. In the row across the top of the screen, select the mode.  
The system displays two sets of parameters and settings. The left column lists all settings for the exam (for example, Abdomen). The right column(s) list settings that apply only to the exam and probe combination.
4. In the Preset list, select the exam.
5. In the Probe list, select the probe.
6. To change a parameter, do one of the following:
  - Select the value from a list
  - Select one value from a choice of two or more buttons
  - Select or clear a check box
7. After changing the parameters, to save the changes, select the Save button.

**NOTE:** *When you Save changes to imaging parameters, the system saves changes to all modes, not just the mode currently displayed.*

**NOTE:** *If you have problems with imaging, you can return parameters back to the original settings. Select the exam, probe, and mode, and then select Reload Factory Defaults. The system returns the selected parameters to the original settings.*

For information about the specific parameters, refer to Chapter 5 Optimizing the Image.

## General

You can specify a default probe per application and a default application per probe, ECG Display or Sync Mode.

### Default probe per application

1. To specify a default probe per application, select Utility --> Imaging --> General.
2. Check the parameter if you want to start it automatically.
3. Select the default probe from the pull-down menu.

### Default mode and application per probe

1. To specify a default application per probe, select Utility --> Imaging --> General.
2. Under Probe, specify the desired mode and application from the pull-down menu.

Checkmark the following fields when you want the system to activate a certain display. Values vary by probe.

- Simultaneous
- Automatically Retain Field of View  
If selected, the system automatically activates the Retain Field of View control when a field of view setting is changed. If not selected, you can activate the Retain Field of View manually from the Probe Touch Panel.
- Application Default Mode
  - B-Mode
  - Harmonic
  - Steer knob activates B Steer+
- Default PDI
  - PDI
  - MVI
- Default Elasto
  - Shear
  - Strain
- PDI/TVI button
  - PDI
  - TVI
- BF/CHI button
  - BF
  - CHI
- ECG
  - ECG Display
  - Sync Mode

# Comments Libraries Presets

## Overview

Comment screens allow you to specify comment text and pointer options, to define comment libraries, and assign comment libraries to applications.

## Comments Libraries/Libraries Preset Menu

On the comments *Libraries* tab, you can change and create comment libraries. A comment library is a list of comments that are associated with a specific application. The comments are listed in the library in the order in which they display on the Touch Panel. For each library, you can define two Touch Panel displays of comments (Page1 and Page2), with 30 comments on each Touch Panel. Home and Arrow controls can also be added to the Touch Panel displays.

You can configure these comment color groupings via Utility--> Comments--> Libraries (up to 5 groups).



Figure 10-6. Comment Libraries Preset Menu

### Comments Libraries/Libraries Preset Menu (continued)

Table 10-55: Libraries

Preset Parameter	Description
Library	The name of the comment library.
Reload Factory Defaults	Select to reload factory defaults.
Small List	Fields where you define a small list.
User Defined Library	The name of a new comment library that you want to create/delete.
Copy from Existing	You can add to or delete from the selection of comments.

### Defining Comments

1. In the *Library* field, select the library you want.  
The system displays all comments for the library. You can have two Touch Panel displays of comments for each library. The comments are listed in the order that they are shown on the Touch Panel when you use comments.
2. To change or add an comment, select the comment or blank location and press **Set**, then do one of the following:
  - Type the comment.
  - Select the comment in the *Copy from Existing* list, and press **Set**.
3. To save the changes, select the **Save** button.

### Creating a new comments library

1. In the *User Defined Library* field, type a name for the library, then select **Create**.  
The system creates a new library.
2. Enter comments as described in step 2 above.
3. To save the changes, select the **Save** button.

## Deleting a user defined library

1. Select the library name which you want to delete from the pull-down menu.
2. Press **Delete**.
3. Press **Save** to save the changes.

## Creating a small list

A small list is a list of up to three comments attached to one comment location on the Touch Panel. You can use a small list to group similar comments, such as those indicating a probe location. For example, you can specify that a small list include the following comments: Long, Transverse, and Coronal. To make comments easier to use, you can define the small list in the same location in each comment library.

To define a small list:

1. Move the **Trackball** to the comment field on Page1 or Page2 where you want to create a small list, and press **Set**.
2. Move the **Trackball** to the first field in the *Small List* section, and press **Set**.
3. To enter comments in the fields in the Small List section, select the field and press **Set**, then do one of the following:
  - Type the comment
  - Select the comment in the Copy from Existing list, and press **Set** twice.

You can enter up to three comments. When you enter an comment in the first field of the Small List section, the selected comment field on Page1 or Page2 changes to SMALL LIST.

4. To save the changes, select the **Save** button.

**NOTE:** *The small list can be displayed as a pop-up window or as a toggle field. The Small List Operation field on the General tab allows you to specify how it is displayed.*

## Comments Libraries/Comments Preset Menu

On the Comments tab you can specify text and pointer options.

Table 10-56: Text

Preset Parameter	Description
Text Font Size	Specify the font size. The font size increases as the number increases.
Text color (Text1 and Text2)	Select the color for comment Text1 and Text2.
Arrow Color	Select the color for comment Arrow.
Text Boundary	Select Group Move or Word Wrapping.
Small List Operation	Select whether you want small list options to display in a Pop-up window, by a Toggle function, or in a Pop-up with replace.
Enable Type Over Mode	Select to type over existing comments. Position the cursor over the text to be changed, then start typing.
Reset Small List	Select to indicate that small lists should not be reset to the first item.
Automatically Set Text	Sets the comment as you are typing it.
Replace Mode	Select to replace comment.

Table 10-57: Arrow

Preset Parameter	Description
Arrow Length	Select the default pointer length.
Arrow Size	Select the default pointer size.
Keep Arrow Angle	Keep the angle of arrow pointer head until next change.

Table 10-58: General

Preset Parameter	Description
Retain while entering or leaving timeline mode	If selected, the system keeps the comment(s) on the monitor display when you enter or leave timeline mode.
TextOverlay in Multiple Image	When selected, and you select the F8 key to hide or show comments, if you are in multiple image, the system hides the text in both images. When cleared, the system only hides the text for the active image.
TextOverlay Sequence	You can specify to display Text1, Text2, or both. This allows you to have some comments that do not change during the exam while allowing you to change other comments. Toggle the F8 key to cycle through the 3 Text1/Text12 states.
Erase when the probe or application is changed	Deletes annotations when you change the application or probe.

Table 10-58: General (Continued)

Preset Parameter	Description
Clear Non Active Image Comments	Select if you want comments to be removed from the non-active multi image.

After you change comment options, select **Save** to save the changes.

## Comments Libraries/Applications Preset Menu

The Comments Libraries/Applications tab is a link to the Applications preset menu. The Applications preset screen allows you to specify which libraries belong to an application. You also specify which is the default library that displays when you use comments.

The Applications/Comments screen can be accessed through either the Comments Libraries or Applications Touch Panel key.

### Specifying which libraries belong to an application

1. On the Applications tab, in the Application field, select the application.
2. In the Library Group Tabs fields, select the libraries for this application. You can select up to six libraries.
3. In the Default Library Group field, select the default library you want the system to display when you use comments.

*NOTE: When you use comments, the default library is displayed. To use other libraries for the application, press the tab for the library.*

4. To save the changes, select the Save button.

Table 10-59: Applications

Preset Parameter	Description
Preset	The name of the application preset.
Tabs	A list of libraries for the application. You can select up to six libraries.
Default Tab	The default library that the system displays when you use comments.

### Using comments from a library

To use comments, press the **Comment** key on the Control Panel. Comments are then displayed on the Touch Panel.

To select a comment library, press the appropriate tab (e.g. the tabs are OB23 and OB23\_1).



Figure 10-7. OB 2/3 Comments Touch Panel



## Comments Libraries/Mapping Preset Menu

The system uses the annotation/body pattern information associated with the image to automatically assign the segment/position qualifier of the breast lesion.

On the Mapping tab, you add/delete/reset the user-defined mapping for the qualifier.

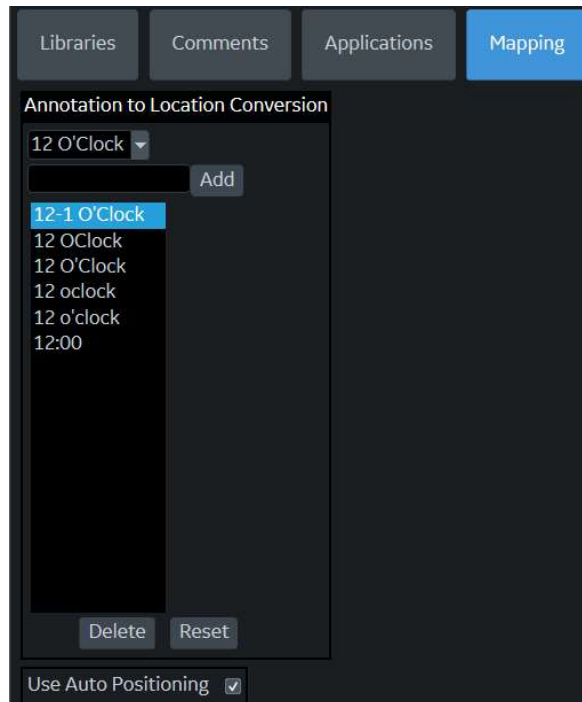

Figure 10-8. Comment Mapping

Table 10-60: Mapping preset

Preset Parameter	Description
Annotation to Location Conversion	Add/Delete/Reset the use-defined mapping annotation for the qualifier for Breast. <ul style="list-style-type: none"> <li>• <b>Add:</b> Add the use-defined mapping annotation</li> <li>• <b>Delete:</b> Delete selected user-defined mapping.</li> <li>• <b>Reset:</b> Reload factory default mappings to the selected qualifier.</li> </ul>
Use Auto Positioning	Configure a mapping of annotation and body pattern to location (Position and Segment) mappings. Note: This is effective only against the following body pattern: Breast4 Lt/Rt, Breast5 Lt/Rt, Breast6 Lt/Rt, Breast7 Lt/Rt, Breast8 Lt/Rt

After you change Mapping options, select Save to save the changes.

## Comments Libraries/Mapping Preset Menu (continued)

For example,

1. Select Qualifier "12 O'Clock" from the pull-down menu.
2. Type the mapping annotation "12" and press Add.
3. Check "Use Auto Positioning".

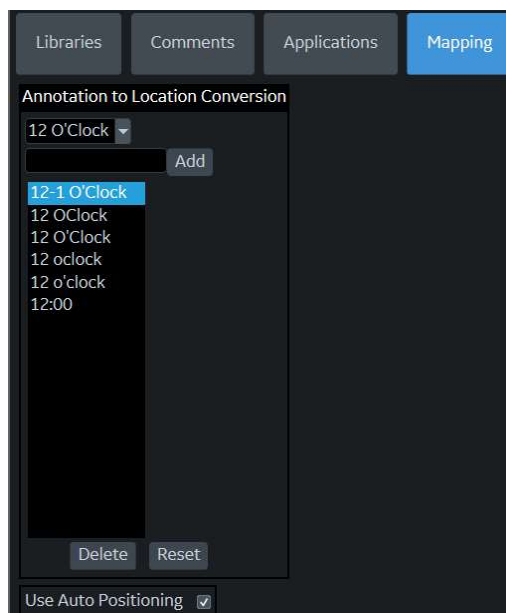

Figure 10-9. Comment Mapping

4. In Utility-> Body Pattern-> Libraries, select SMLP from pull-down menu.
5. Select an empty cell of the Library table.
6. Select Breast4\_Rt in Copy from Existing to add.

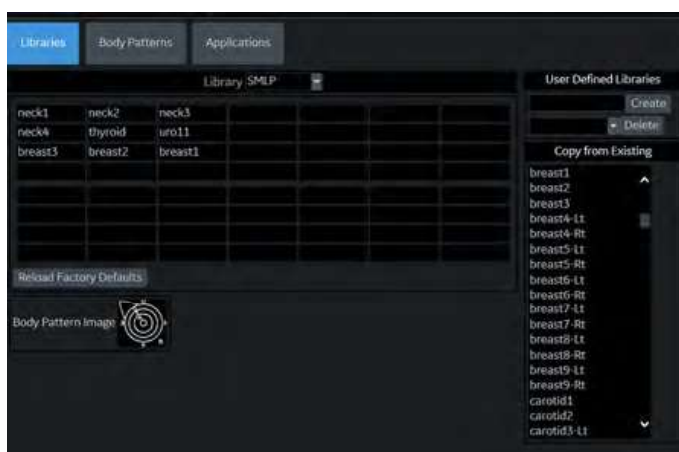

Figure 10-10. Comment Mapping - SMLP

## Comments Libraries/Mapping Preset Menu (continued)

7. Press Save and Exit.
8. Scan the patient.
9. Type "Right Breast 12 Zone 1" as Comment on the image.
10. Activate Breast measurement and select Lesion folder from the Touch Panel for add Lesion1.

Position Rotary is set 12 O'Clock, Segment Rotary is set A, and "12 O'Clock A" displays as measurement name automatically.

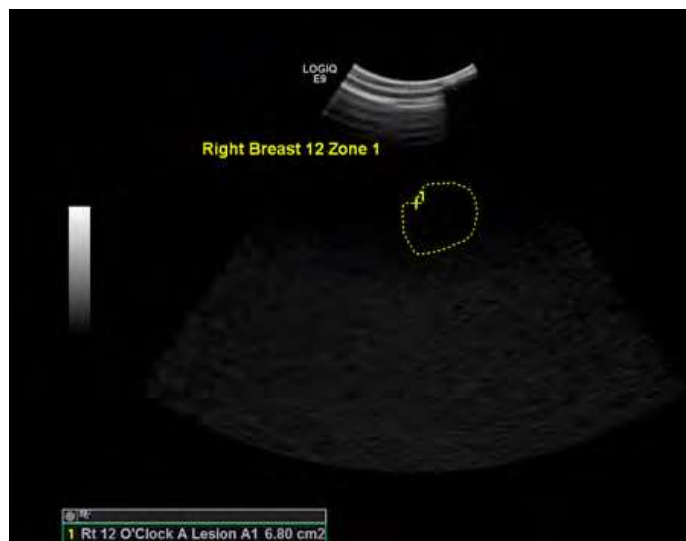

Figure 10-11. Comment Mapping - Measurement

**NOTE:** *The system assigns "-" to position qualifier if the value is not found in the annotation or body pattern information associated with the image.*

11. Select the frame for Lesion 2.
12. Select Breast4\_Rt as Body pattern on the image and locate the probe mark in the appropriate position.
13. Activate Breast measurement and select Lesion folder from the Touch Panel.
14. Position Rotary and Segment Rotary is set automatically associated with the position and segment of the probe mark.

# Body Patterns Presets

## Overview

Body patterns screens allow you to specify body pattern options, to define body pattern libraries, and assign body pattern libraries.

## Body Pattern Libraries/Libraries Preset Menu

On the Body Patterns Libraries tab, you can change and create body pattern libraries. A body pattern library is a list of body patterns that are associated with a specific application. The body patterns are listed in the library in the order in which they display on the Touch Panel. For each library, you can define two Touch Panel displays of body patterns (Page1 and Page2), with 15 body patterns on each Touch Panel.



Figure 10-12. Body Patterns Libraries Preset Menu

Table 10-61: Body Patterns Libraries

Preset Parameter	Description
Library	The name of the body pattern application library.

Table 10-61: Body Patterns Libraries (Continued)

Preset Parameter	Description
Reload Factory Defaults	Select to reload factory defaults.
Body Pattern Image	Displays the image of the currently selected body pattern.
User Defined Libraries-Create	The name of a new body pattern application library that you want to create.
User Defined Libraries-Delete	Allows the selection of the user defined library to be deleted.
Copy from Existing	A list of body patterns you can use to create an application library.

## Defining body patterns

- In the *Library* field, select the application library you want. The system displays all body patterns for the library. You can have two Touch Panel displays of body patterns for each library. The body patterns are listed in the order that they are shown on the Touch Panel.
- To change or add a body pattern, select the body pattern or blank location and press **Set**, then do one of the following:
  - Type the body pattern name.
  - Select the body pattern in the *Copy from Existing* list, and press **Set**.

**NOTE:** *When you select a body pattern name in a Touch Panel location or in the Copy from Existing list, the system displays the pattern in the lower left corner of the screen.*

- To save the changes, select the **Save** button.

## Creating a new body pattern library

- In the *User Defined Libraries* field, type a name for the library, then select Create. The system creates a new library.
- Enter body patterns as described in step 2 above.
- To save the changes, select the **Save** button.

## Body Pattern Libraries/Body Patterns Preset Menu

Table 10-62: Body Patterns

Preset Parameter	Description
Erase When the probe or application is changed	If checked, when you change probes or applications, the system erases the body pattern.
Erase When the image is unfrozen	If checked, when you unfreeze the image, the system erases the body pattern.
Copy to active side in multiple image	If checked, when you use dual B-Mode, the system copies the body pattern to the active side of the dual image.
Body pattern background	Select whether you want the body pattern background to be Transparent or Opaque.
Use Zoom Rotary knob to select Body pattern	If selected, you can scroll through the body patterns with the Zoom control.
Body Pattern knob Recall On	When the image is recalled, Body pattern knob works as below. Body Pattern on: Activate Body Pattern by press or move Up/Down/Left/Right the Body Pattern knob. U/D: Body Pattern On, L/R: Prev/Next image: Move Body Pattern knob Up and Down to Body Pattern On, Move left recalls previous image, move right recalls next image. Prev/Next image: Move up and left recall previous image, move down and right recall next image. None: Activate Body Pattern by press the Body Pattern knob.
Body Pattern knob Recall Off	When the image is not recalled, Body pattern knob works as below <ul style="list-style-type: none"> <li>• Body Pattern on: Activate Body Pattern by press or move Up/Down/Left/Right the Body Pattern knob.</li> <li>• U/D: Body Pattern On, L/R: Prev/Next image: Move Body Pattern knob Up and Down to Body Pattern On, Move left recalls previous image, move right recalls next image.</li> <li>• Prev/Next image: Move up and left recall previous image, move down and right recall next image.</li> <li>• None: Activate Body Pattern by press the Body Pattern knob.</li> </ul>
Body Pattern knob: Scan Assistant On	When Scan Assistant is activated, <ul style="list-style-type: none"> <li>• Scan Assistant Control: Navigate Scan Assistant protocol by move Up/Down the Body Pattern knob. Pause/Resume Scan Assistant by move Left/Right the Body Pattern Knob.</li> <li>• None: Activate Body Pattern by press the Body Pattern knob.</li> </ul>

After you change body pattern options, select Save to save the changes.

## Body Pattern Libraries/Applications Preset Menu

The Body Patterns Library/Applications tab is a link to the Applications preset menu. The Body Patterns Applications tab allows you to select body pattern application libraries. You also specify which is the default library that displays when you use body patterns.

The Applications/Body Patterns screen can be accessed through either the Body Pattern Libraries or Applications Touch Panel keys.



Figure 10-13. Body Patterns Applications Preset Menu

Table 10-63: Applications

Preset Parameter	Description
Preset	Defines the Body Pattern option.
Tabs	A list of body pattern applications.
Default Tab	The default library that the system displays when you use body patterns.

### Selecting body pattern application libraries

1. On the Applications tab, in the Application field, select the body pattern.
2. In the Library Group Tabs fields, select the application libraries for Body Patterns. You can select up to six libraries.
3. In the Default Library Group field, select the default application library you want the system to display when you use body patterns.

**NOTE:** *When you use body patterns, the default library is displayed. To use other application libraries, press the tab for the library.*

4. To save the changes, select the **Save** button.

## Using body pattern application libraries

See the following Body Patterns Small Parts Touch Panel.

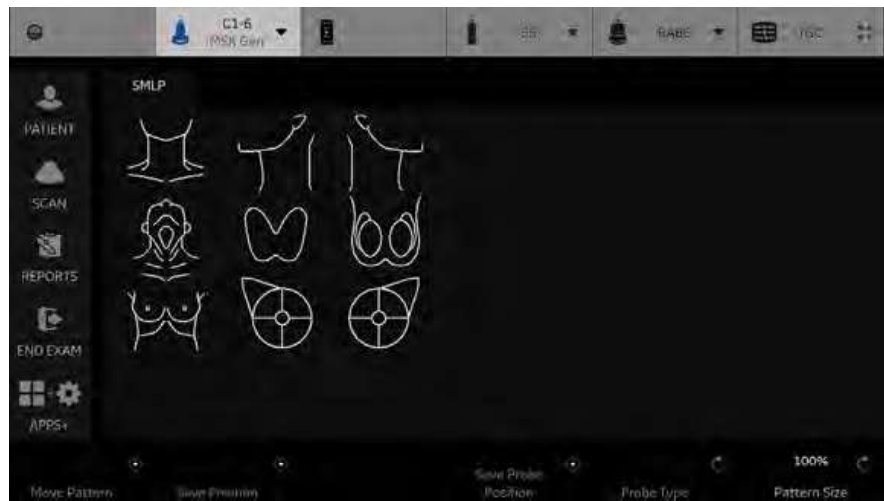

Figure 10-14. Body Patterns Small Parts Touch Panel

To select a body pattern library, select the tabs (for example, ABD or OB).

To select body patterns, use the **Ellipse/Body Pattern** control on the Control Panel.



# Application Presets

## **Overview**

Application Presets allow you to configure the application-specific settings (presets).

### Settings

Table 10-64: Preset

Preset Parameter	Description
Preset	Select the application that you want to specify the presets. Along with the various applications available on the system, there are four user-defined application presets that can be set.

Table 10-65: Image Control and Display

Preset Parameter	Description
Show kHz scale	When selected, displays the kHz scale on the left side of the Doppler spectrum.
Show Doppler Rate	When selected, displays the Doppler rate (mm/s) below the Doppler spectrum.
Anatomical Angle Correction	Select to keep the angle constant with regard to the anatomy.
Join Dual Image for Linear	Select to place linear probe dual images directly next to each other.
Hide Mode Cursor Key	Select to unmap (hide) the Mode Cursor key, which normally appears on the left Trackball key during live scanning in B-Mode or Color Flow Modes.
Horizontal Display for Biplane	Display of the two planes of the Biplane probe in a top and bottom layout.

Table 10-66: Auto Zoom Linear Probe Images at Shallow Depth...

Preset Parameter	Description
Check Desired Setting	<ul style="list-style-type: none"> <li>• Single Screen</li> <li>• Dual Screen and DualView</li> <li>• Virtual Convex</li> <li>• B Steer+</li> </ul>

Table 10-67: When Entering Dual Image...

Preset Parameter	Description
Duplicate Frozen Image to Opposite Side	When entering Dual Image, duplicate the frozen image to the opposite side.
Duplicate Live Image to Opposite Side	When entering Dual Image, duplicate the live image to the opposite side.

Table 10-68: Patient Info

Preset Parameter	Description
Titlebar Line 1	Select the patient information to display on the scanning screen Title bar.
Titlebar Line 2	Select the patient information to display on the scanning screen Title bar.

Table 10-68: Patient Info (Continued)

Preset Parameter	Description
Titlebar Line 3	Select the patient information to display on the scanning screen Title bar.

Table 10-69: Comments

Preset Parameter	Description
Active function at Freeze	Select None, Body Pattern, or Comments. If Body Pattern or Comment is selected, the Body Pattern or Comment is activated automatically when freezing the system.
Erase when the image is unfrozen	Select to erase image when system Freeze is deactivated.

Table 10-70: Footswitch

Preset Parameter	Description
Left, Middle, Right	Specify from the following for each footswitch pedal: No Function, Record/ Pause, Freeze, Next Heartcycle, Previous Heartcycle, Print 1,2,3,4, Update, Next Step (Scan Assistant), Previous Step (Scan Assistant), Scan Assistant Pause/Resume, or Mark Cine.

Table 10-71: Protocol

Preset Parameter	Description
Show Protocol Tab	Check to display the Protocol Tab on the Touch Panel.
Template	Select the default stress echo template: Bicycle Normal, Bicycle Sporty, Contrast Pharmacological, Pharmacological 4x4, Pharmacological 8x5, Exercise 2x4, Exercise 2x4 B, Pharmacological US 4x4

Table 10-72: ECG

Preset Parameter	Description
Show ECG Tab	Check to display the ECG Tab on the Touch Panel.
ECG Lead	Specify the number of ECG Leads (1, 2, or 3).

Table 10-73: ELASTO

Preset Parameter	Description
Show Quality Bar	Check to display a Quality Bar for Elastography. The more bars, the better the quality. As the quality increases, the bars go from red, to yellow, to green.
Show Quality Graph (restart needed)	Select to display a Quality Graph for Elastography. The higher the level, the higher the data quality for the frames.

Table 10-74: User Label

Preset Parameter	Description
Show Label	If selected, the system displays the User label in the Preview Window at the bottom left portion of the monitor.
Label 1-8	User Labels have eight (8) text lines. Each User Label is limited to 50 characters.

### Print Controls

Table 10-75: Live Store

Preset Parameter	Description
P1, P2, P3, P4, PrintScreen	Select Retrospective Clip (CINE prior to pressing Print), Prospective Clip (CINE after pressing Print), Single Image or None to store from a live image.

Press the “Connectivity/Buttons/Physical Print Buttons” hyperlink to go directly to the Connectivity Print Button Setup page.

Table 10-76: Time-Base Store

Preset Parameter	Description
Time span (s)	Select the number of seconds of CINE Loop storage. The default is 3 seconds.
3D/4D Time span (s)	Select the number of seconds of CINE Loop storage while in 3D/4D.
Contrast Time span (s)	Select the number of seconds of CINE Loop storage while in Contrast.
Preview clip before store	When selected, allows you to review cine loops before storage.
Segment prospective loops longer than time span	Specify length of Clip (15, 30, or 45 seconds, Off, or Max).

Table 10-77: ECG-Based Store

Preset Parameter	Description
Time before heart cycle [ms]	Sets the storage time span before R-wave of the first heart cycle.
Time after heart cycle [ms]	Sets the storage time span after R-wave of the last heart cycle.
Number of heart cycles	Select the number of heart cycles to store. (Must be de-selected for single frame.)
Preview cine clip before store	When selected, allows you to review Cine loops before storage.

Table 10-78: Mark Cine

<b>Preset Parameter</b>	<b>Description</b>
Enable Mark Cine Control	Lets you mark where you want the Cine Loop to start (prospective CINE).
Preview Loop Longer than... (s)	When selected, allows you to review Cine loops before storage for loops longer than selected timeframe (in seconds).

## Imaging Controls

You can select which controls you want to be available via the Touch Panel during a clinical scan. When you select Preset--> Application and Control Mode--> Clinical, deselect the controls you **DO NOT** want to appear while scanning in this clinical application.

*NOTE: If you select Research, all controls appear.*



Figure 10-15. Imaging Controls, Research

Clinical vs Research Touch Panel Example. To view all controls press the View All/View Less control (circled).

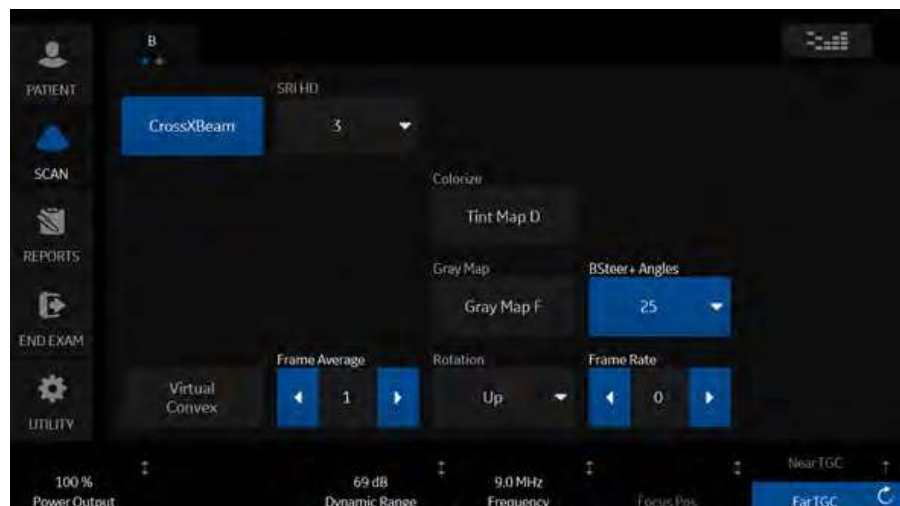

Figure 10-16. Clinical Control Mode

## Imaging Controls (continued)

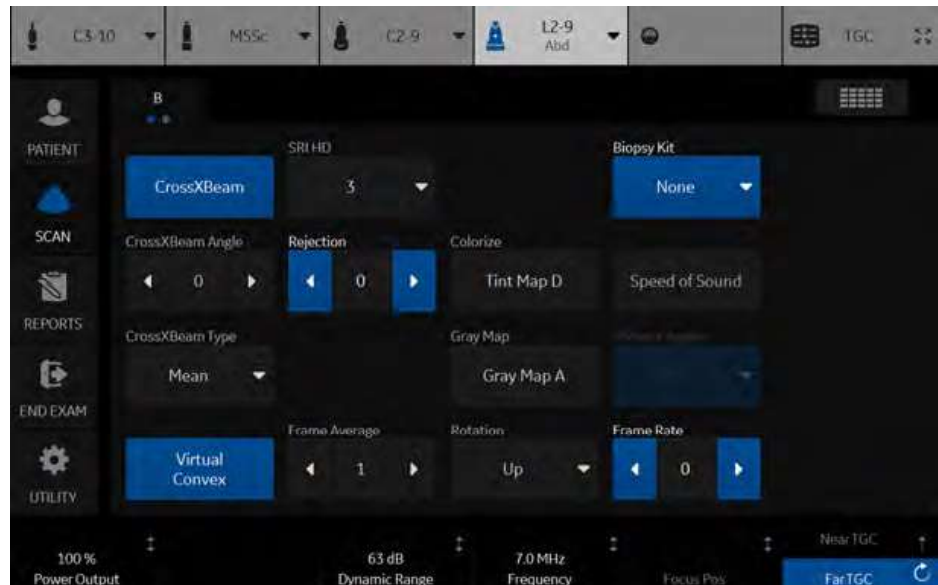

Figure 10-17. Research Control Mode

## Comments and Body Patterns

Comments and Body Patterns were described earlier in this chapter.

## Measurements

You can set the exam category measurement and calculation package you want to appear when you select the exam category Preset.

# User Specific

Refer to “Monitor Display” in Chapter 3 for more information.



# Test Patterns

For more information, see **Test Patterns** in the Wide Monitor section of Chapter 3.

## Overview

3D/4D presets allow you to set up application-specific settings (presets) for each 4D image acquisition type. You can define different application-specific settings for each probe. Refer to Chapter 5 for more information.

## 4D Presets

To set up 4D presets:

1. On the Touch Panel, select **Utility**.
2. On the Touch Panel, select **3D/4D**.  
The system displays the 4D Presets screen.
3. To select a probe, click on the plus sign (+) that appears next to the desired probe.
4. To select the application, click on the plus sign (+) that appears next to the desired application.
5. To select the acquisition type, click on the plus sign (+) that appears next to the desired application.
6. Double-click the desired application under the acquisition type. The Display tab is selected.

## Display Presets Tab

Table 10-79: Image Display

Preset Parameter	Description
Tile	Determines the number of display windows. Values include: 1 (Single), 2 (Dual), and 4 (Quad).
Visualization	Determines the method of display for working with images. Selections available: Sectional, Render, VOCAL, VCI static and TUI.
3D Orientation (degrees)	Determines the orientation of the ROI on the monitor display. Values include: 0, 90, 180, 270.
Zoom Factor	Determines the magnification factor of the zoom. Values include: 0.3 through 4.0, in .01 increments.
Orientation Help	Activate Orientation Help.
Gain	Set the desired Gain.

Table 10-80: Pre-mode ROI

Preset Parameter	Description
ROI Center (cm)	Determines the vertical center of the region of interest. Values vary by probe.
ROI Span (cm)	Determines the height of the region of interest. Values vary by probe.
Tilt (degrees)	Determines the degree of tilt from the vertical center location of the ROI. Values vary by probe.
Width (degrees)	Determines the width of the ROI. Values vary by probe.
Volume Angle	Set the range of the volume sweep. Values vary by probe. Listed in degrees for curved probes, cm for linear probes.

Table 10-81: Quality Setting

Preset Parameter	Description
Setting	Set quality setting -- balances speed with line density. Selections are Low, Mid1, Mid2, Hi1, Hi2, Max. High combines the highest density with the slowest speed. Low combines the lowest density with the highest speed.
CF Setting	Set quality setting -- balances speed with line density. Selections are Low, Mid1, Mid2, Hi1, Hi2. High combines the highest density with the slowest speed. Low combines the lowest density with the highest speed.

### Render Tab

Table 10-82: Render and Render for VCI Static

Preset Parameter	Description
Render Mode 1:Mode2 (Gray Inversion, and VCI Static)	Set render mode values. Surface Smooth, Surface Texture, Transp Max, Transp X-Ray, TransMin (Render 1), or HDlive Texture Surface Smooth, Light, Gradient Light, Transp Max, Transp X-Ray, Transp Min (Render 2), or HDlive Smooth.
Mix/Mix Inversion/eMixVCI Static (% Render Mode 2)	Set mix of Render 1 / Render 2 Mode, 0-100.
Lower Threshold	Set a lower threshold below which weaker echoes are removed, 0-255.
Transparency/ Transparency (Inversion)	Set the transparency of the image, 10/20-250. The higher the number, the more transparent the gray scale information.
Render Direction	Set the direction in which the ROI is viewed.
SonoRenderLive	Check to use SonoRenderLive.
SonoRenderLive Sensitivity	Set the SonoRenderLive sensitivity from 1-100.
[VCI Static] Slice Thickness	Set slice thickness, 2-20.

## Color / PDI Render tab

Table 10-83: Color / PDI Render

Preset Parameter	Description
Render Mode 1 (Color) / Render Mode 2 (Color)	Determine the render mode, selected from Render Mode 1 and Render Mode 2.
Mix (Color)	Set the percentage of Render Mode 1 to be mixed with Render Mode 2.
Lower Threshold (Color)	Set the lower threshold below which weaker echoes are removed.
Transparency (Color)	Determine the transparency of the image. The higher the number, the more transparent the gray scale information. Values: 20 to 255.
Render Gray : Color)	Determine the render mode, selected from Render Mode 1 and Render Mode 2.
Mix (Gray Color)	Set the percentage of Render Mode 1 to be mixed with Render Mode 2.

## VOCAL tab

Table 10-84: VOCAL

Preset Parameter	Description
Vocal Method	Set Sphere, Manual, Contour Detect, or Semi-Auto Contour Detect.
Vocal Semi-Auto-Detect type	Set Hypo, Cystic, or Hyper/Iso.
Vocal Rotation step	Set 6, 9, 15, or 30.

## TUI tab

Table 10-85: TUI

Preset Parameter	Description
Display Format	Set 1x1, 1x2, 2x2, or 3x3.
Total Slices	Set 3, 5, 7, 9, 11, 13, 15, 17, or 19.
Slice Distance (mm)	Set 0.5-40 (0.1 step increments).

## OmniView tab

Table 10-86: OmniView

Preset Parameter	Description
Show OmniView View Direction Marker	Select to view the direction marker in OmniView.

### Advanced tab

Table 10-87: Advanced

Preset Parameter	Description
Upper Threshold	Sets the higher threshold above which weaker echoes are removed.
Volume Calibration Shift	See a Field Service Engineer for information on this parameter.

# Configuring Connectivity

You use Connectivity functionality to set up the connection and communication protocols for the ultrasound system. The following page gives an overview of each of the Connectivity functions. Each function is described in detail in the following pages.

### Connection Manager

Connection Manager allows configuration of all connectivity functions on the Ultrasound system. Select Connectivity on the Utility Touch Panel page to launch Connection Manager.

If Connectivity was not previously set up on the Ultrasound system, the Scanner page appears when Connectivity is selected.

It is recommended to initially set up each area of Connectivity in the sequence they are listed across the top of the Connection Manager page, from left to right.

Navigate through Connection Manager from left to right by selecting the icons at the top of the screen or by selecting Next or Previous at the bottom of the screen. The recommended setup sequence is:

- 'Scanner Page' on *page 10-63*
- 'Network Page' on *page 10-65*
- 'MyComputer Device Page' on *page 10-72*
- 'Dicom Page' on *page 10-81*
- 'Special Devices Page' on *page 10-92*
- 'Print Button Page' on *page 10-116*
- 'Dataflow Page' on *page 10-119*
- 'Advanced Settings Page' on *page 10-121*

If Connection Manager has previously been set up, the Summary page appears when Connectivity is selected.

Navigate to the desired Connection Manager configuration screens by selecting the icons at the top of the screen or by selecting Next or Previous at the bottom of the screen to advance to through the screens.



## Scanner Page

Use the Scanner page to configure or modify details about the DICOM properties used for the Ultrasound system.

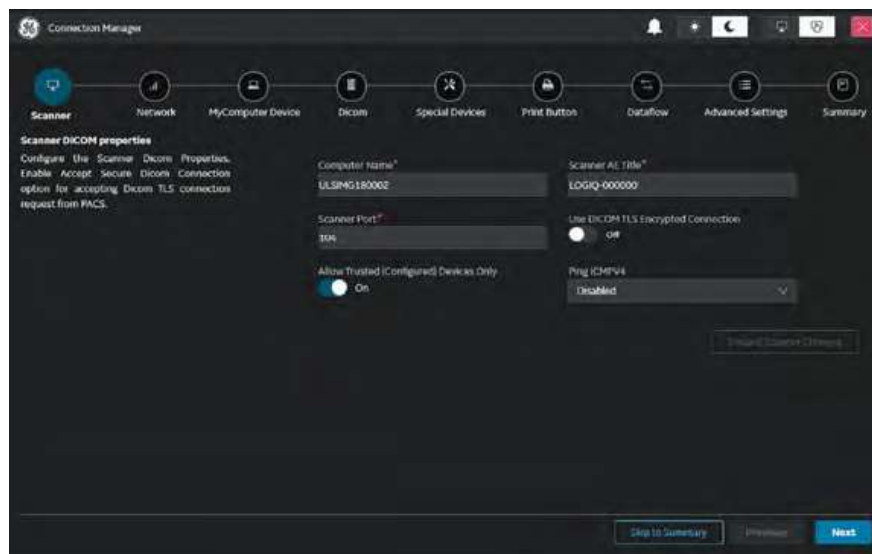

Figure 10-18. Scanner Page

This table shows all the preset parameters available on Scanner with descriptions.

Table 10-88: Scanner Page

Preset Parameter	Description
Computer Name	Enter a name for the Ultrasound system. This may be the same as the station name.
Scanner AE Title	Assign an AE Title to the Ultrasound system. (AE stands for Application Entity. DICOM services use this to identify the Ultrasound system.) AE Title is case-sensitive. This title may contain the Computer Name. Maximum number of characters in AE Title is 16 characters. It is NOT recommended to use the factory default. This is not prohibited, but more than one system with the same AE Title can cause confusion
Scanner Port	If needed, edit the default port number of 104. Restricted port numbers are listed in the user manual.
Allow Trusted (Configured) Devices Only	To prevent unsolicited inbound DICOM conversations, enable Allow Trusted (Configured) Devices Only. When enabled, the Ultrasound system only responds to TCP/IP ping or DICOM Echo from a defined DICOM source IP address. On = Enabled/Off - Disabled
Use DICOM TLS Encrypted Connection	To allow DICOM connectivity to a secure network connection using encryption and certificates using the TLS (transport layer security) protocol, enable Use DICOM TLS Encrypted Connection. Internal communication is still DICOM-structured. On = Allowed/Off = Not allowed

Table 10-88: Scanner Page

Preset Parameter	Description
Ping ICMPV4	To allow the Ultrasound system to respond to a network ping or traceroute command from another device on the network. Disabled = Ultrasound system will not respond to incoming IP ping requests from any remote device LocalSubnet = Ultrasound system responds to all incoming IP ping requests from any remote device that belongs to same local subnet. Any = Ultrasound system responds to all incoming IP ping requests from any remote device.
Discard Scanner Changes	Select to remove any changes made to Scanner.

### Configure Scanner

1. Navigate to **Connectivity > Connection Manager > Scanner**.
2. In **Computer Name**, enter a name for the Ultrasound system.
3. In **Scanner AE Title**, enter an AE Title for the Ultrasound system.
4. In **Scanner Port**, enter a port number for the Ultrasound system. The default port number is 104.
5. To allow DICOM connectivity to a secure network connection using encryption and certificates using the TLS (transport layer security) protocol, enable **Use DICOM TLS Encrypted Connection**.
6. To prevent unsolicited inbound DICOM conversations, enable **Allow Trusted (Configured) Devices Only**.
7. Under **Ping ICMPV4**, select to allow the Ultrasound system to respond to a network ping or traceroute command from another device on the network. Select Disabled if you do not want the Ultrasound system to respond to incoming IP ping requests from any remote device

## Network Page

Use the Network page to configure or modify network properties for the Ultrasound system.



Figure 10-19. Network Page

Refer to the following sections for more information:

- *'General'* on page 10-66
- *'Wired'* on page 10-67
- *'Wireless'* on page 10-68
- *'Proxy'* on page 10-70

### General

Use Scanner Network Properties - General to configure the protocol setting.

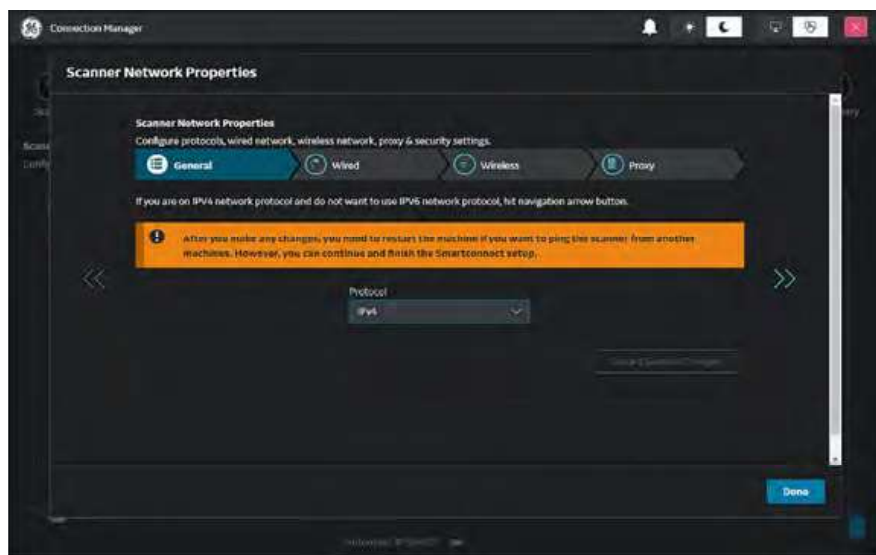

Figure 10-20. Scanner Network Properties - General

This table shows all the preset parameters available on Scanner Network Properties - General with descriptions.

Table 10-89: Scanner Network Properties - General

Preset Parameter	Description
Protocol	Select either the IPV4 or IPV6 static IP setting.

#### Add Scanner Network Properties - General

1. Navigate to **Connectivity > Connection Manager > Network**.
2. Select **General**.
3. Under **Protocol**, select either the IPV4 or IPV6 static IP setting.
4. Select **Done**.

## Wired

Use Scanner Network Properties - Wired to configure the local area network settings.

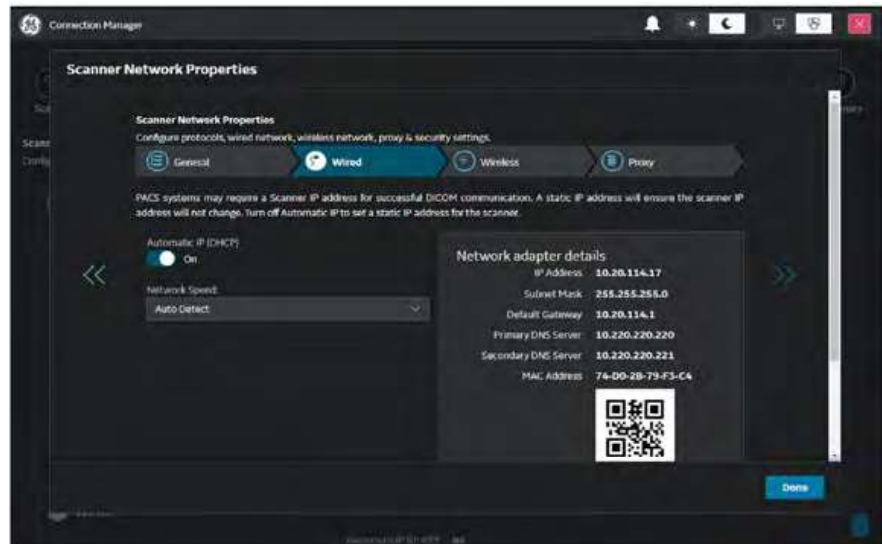

Figure 10-21. Scanner Network Properties - Wired

This table shows all the preset parameters available on Scanner Network Properties - Wired with descriptions

Table 10-90: Scanner Network Properties - Wireless

Preset Parameter	Description
Automatic IP (DHCP)	Enable to automatically configure your wired network settings. On = Enabled/Off - Disabled
Network Speed	Select the network speed (Auto Detect, 10Mbps/Half/Full Duplex, or 100 Mbps/Half/Full Duplex, and 1000Mbps/Auto-negotiate).
Network adapter details	Displays the actual network configuration the Ultrasound system is currently using and has recognized.

### Add Scanner Network Properties - Wired

1. Navigate to **Connectivity > Connection Manager > Network**.
2. Select **Wired**.
3. To automatically configure your wired network settings, enable **Automatic IP (DHCP)**.
4. Under **Network Speed**, select the network speed.
5. Select **Done**.

## Wireless

Use Scanner Network Properties - Wired to configure the local area network settings.

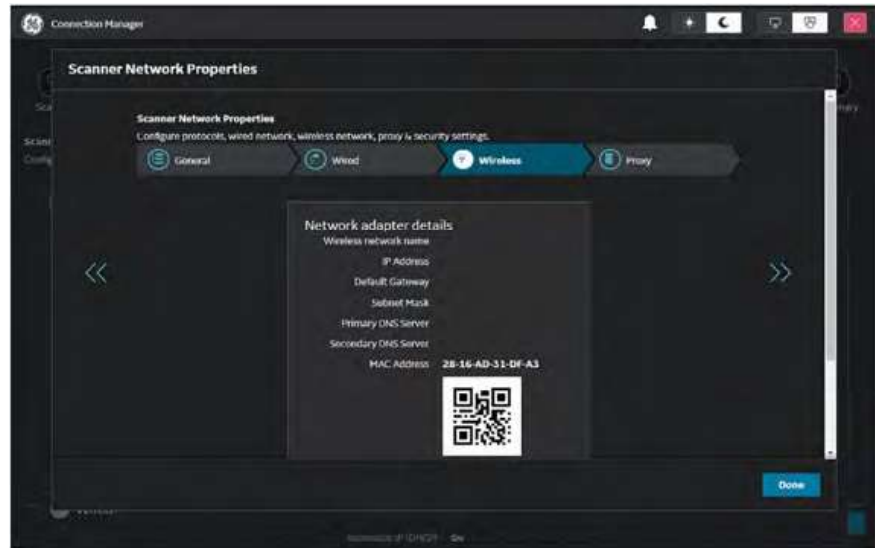

Figure 10-22. Scanner Network Properties - Wireless

This table shows all the preset parameters available on Scanner Network Properties

Table 10-91: Scanner Network Properties - Wireless

Preset Parameter	Description
Wireless Network Name	Name used for the wireless network.
IP Address	IP Address of the Ultrasound system. IP stands for Internet Protocol. Every device on the network has a unique IP address.
Default Gateway	Default gateway address (optional).
Subnet Mask	IP address filter that eliminates communication/messages from network devices of no interest to your system
Primary DNS Server	IP address for the primary DNS server (optional - at least one valid DNS address is needed for Insite remote service connectivity).
Secondary DNS Server	IP address for the secondary DNS server (optional). Do not configure Secondary DNS server only; if only one DNS IP address is being used, enter it in the Primary DNS Server field.
MAC Address	Unique network card address.
Speed (Mbps)	Actual network speed in Megabits per second.
Connected (min)	Number of minutes the Ultrasound system has been connected to the network.

Table 10-91: Scanner Network Properties - Wireless

Preset Parameter	Description
Connection Status	Current network status. <ul style="list-style-type: none"> <li>• Operational: Network adapter has been disabled, for example because of an address conflict.</li> <li>• Unreachable: Network adapter that is not connected.</li> <li>• Disconnected: For LAN adapters: network cable disconnected. For WLAN adapters: no carrier.</li> <li>• Connecting: Network adapter that is in the process of connecting.</li> <li>• Connected: Network adapter that is connected to a remote peer.</li> </ul>
Configure wireless network	Select to display the Wireless Network Configuration page.

### Add Scanner Network Properties - Wireless

1. Navigate to **Connectivity > Connection Manager > Network**.
2. Select **Wireless**.
3. Select **Configure Wireless Network**.
4. On the Wireless Network Configuration dialog box, select the wireless connection and select **Connect**.
5. When prompted, enter the new wireless network properties.
6. Select **Done**.

### Proxy

Use Scanner Network Properties - Proxy to configure a proxy server.

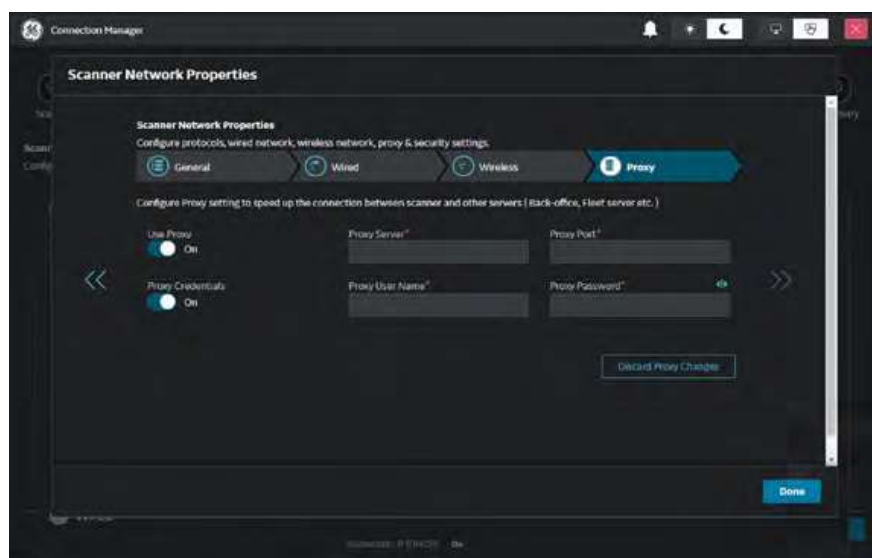

Figure 10-23. Scanner Network Properties - Proxy

This table shows all the preset parameters available on Scanner Network Properties - Proxy with descriptions.

Table 10-92: Scanner Network Properties - Proxy

Preset Parameter	Description
Use Proxy	Enable to use a proxy server. On = Enabled/Off = Disabled
Proxy Server	When Use Proxy is enabled, enter a proxy server address of the facility.
Proxy Port	When Use Proxy is enabled, enter a port number for the proxy server.
Proxy Credentials	Enable to use credentials for a proxy server. On = Enabled/Off = Disabled
Proxy User Name	When Proxy Credentials is enabled, enter an account user name for the proxy server.
Proxy Password	When Proxy Credentials is enabled, enter an account password for the proxy server.
Discard Proxy Changes	Select to remove any changes made to Scanner Network Properties - Proxy.



## Add Scanner Network Properties - Proxy

1. Navigate to **Connectivity > Connection Manager > Network**.
2. Select **Proxy**.
3. To use a proxy server, enable **Use Proxy**.
4. When Use Proxy is enabled, in **Proxy Server**, enter a proxy server address of the facility.
5. When Use Proxy is enabled, in **Proxy Port**, enter a port number for the proxy server.
6. To use proxy credentials, enable **Use Proxy Credentials**.
7. When Use Proxy Credentials is enabled, in **Proxy User Name**, enter an account user name for the proxy server.
8. When Use Proxy Credentials is enabled, in **Proxy Password**, enter an account password for the proxy server.
9. Select **Done**.

### MyComputer Device Page

Use the MyComputer Device page to configure or modify details about the Ultrasound system.

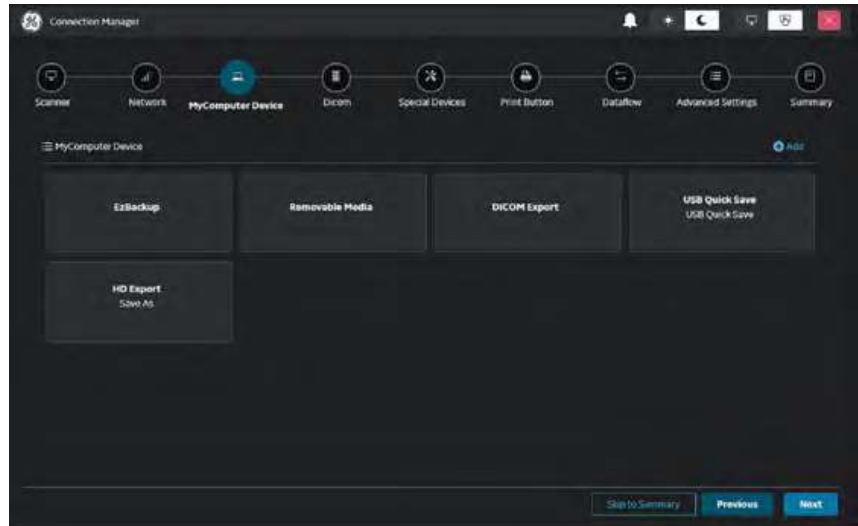

Figure 10-24. MyComputer Device Page

Refer to the following sections for more information:

- *'EzBackup'* on page 10-73
- *'Removable Media'* on page 10-75
- *'DICOM Export'* on page 10-77
- *'USB Quick Save'* on page 10-79
- *'HD Export'* on page 10-80

## EzBackup

Use EzBackup to manage hard disk space while maintaining the patient database on the Ultrasound system and back up the patient database and images by copying the data from the local drive to removable media.

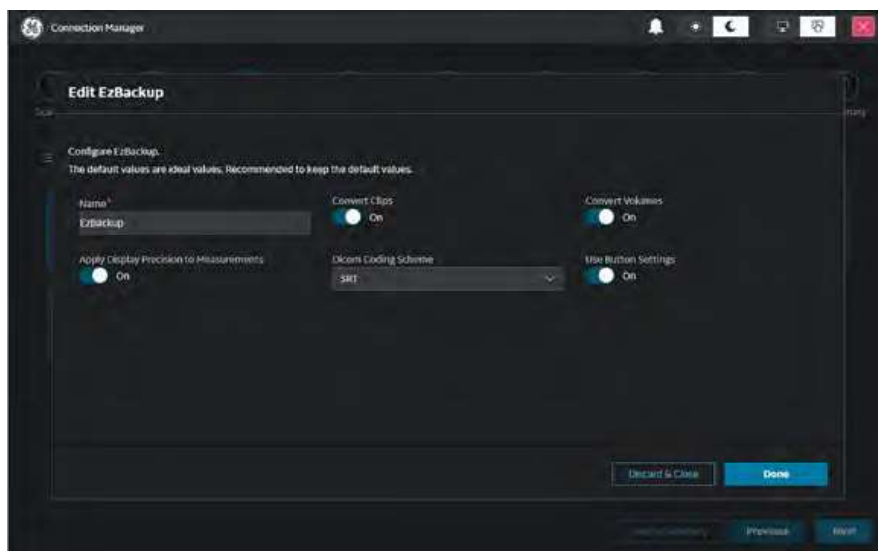

Figure 10-25. Edit EzBackup

This table shows all the preset parameters available on Edit EzBackup with descriptions.

Table 10-93: Edit EzBackup

Preset Parameter	Description
Name	Logical name of the service.
Convert Clips	When enabled, the raw cine clips get converted to DICOM multi-frames during EzBackup operation. On = Enabled/Off = Disabled
Convert Volumes	When enabled, the raw volumes get converted to Enhanced US Volume (DICOM 3D) format during EzBackup operation. On = Enabled/Off = Disabled
Apply Display Precision to Measurements	When enabled, the measurement values are rounded to configured number of decimal places. On = Enabled/Off = Disabled
Dicom Coding Scheme	Measurements are encoded with configured coding scheme in DICOM SR objects.
Use Button Settings	When enabled, uses button settings. On = Enabled. The Ultrasound system will use the default image storage and compression presets./Off = Disabled. Properties menu expands and image storage and compression presets can be defined.

### Add EzBackup

1. Navigate to **Connectivity > Connection Manager > MyComputer Device**.
2. Select **EzBackup > Configure**
3. In **Name**, enter a logical name of the service.
4. To have raw cine clips converted to DICOM multi-frames during EzBackup operation, enable **Convert Clips**.
5. To have raw volumes get converted to Enhanced US Volume (DICOM 3D) format during EzBackup operation, enable **Convert Volumes**.
6. To round measurement values to configured number of decimal places, enable **Apply Display Precision to Measurements**.
7. Under **Dicom Coding Scheme**, select how measurements are encoded with configured coding scheme in DICOM SR objects.
8. To use button settings, enable **Use Button Settings**.
9. Select **Done**.

## Removable Media

Use Removable Media to do the following:

- Verify the DICOM directory on removable media.
- Verify the free space of the media.
- Verify that the media is finalized or unfinalized.
- Verify that the media is formatted or unformatted.
- Format removable media (rewritable CD/DVD or USB device).



Figure 10-26. Edit Removable Media

This table shows all the preset parameters available on Edit Removable Media with descriptions.

Table 10-94: Edit Removable Media

Preset Parameter	Description
Removable Media	Select the removable media to format or verify.
Label	Type a label for a new removable media (free text).
SetLabel	When text has been entered under Label, select to set the text.
Format	Select to format the media. New media should always be formatted.
Media Properties	Shows properties for the configured media.
Done	Select to save the removable media settings.

### Add Removable Media

1. Navigate to **Connectivity > Connection Manager > MyComputer Device**.
2. Select **Removable Media > Configure**.
3. Under **Removable Media**, select the removable media to format or verify.
4. Under **Label**, enter a label for a new removable media (free text).
5. If you entered a label, select **SetLabel**.
6. Select **Format** to format the removable media.
7. Select **Done**.

## DICOM Export

Use DICOM Export to export DICOM content in either .mp4 and .avi formats.

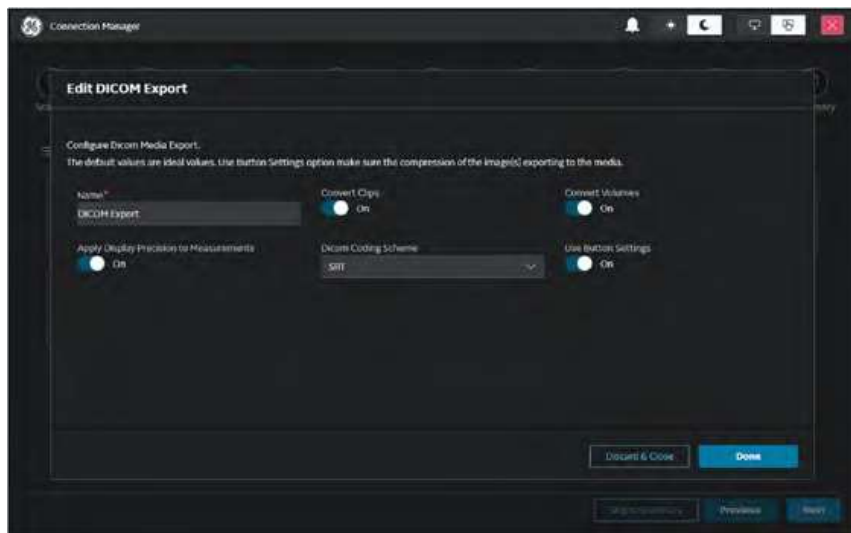

Figure 10-27. Edit DICOM Export

This table shows all the preset parameters available on Edit DICOM Export with descriptions.

Table 10-95: Edit DICOM Export

Preset Parameter	Description
Name	Logical name of the service.
Convert Clips	When enabled, the raw cine clips get converted to DICOM multi-frames during DICOM Export operation. On = Enabled/Off = Disabled
Convert Volumes	When enabled, the raw volumes get converted to Enhanced US Volume (DICOM 3D) format during DICOM Export operation. On = Enabled/Off = Disabled
Apply Display Precision to Measurements	When enabled, the measurement values are rounded to configured number of decimal places. On = Enabled/Off = Disabled
Dicom Coding Scheme	Measurements are encoded with configured coding scheme in DICOM SR objects.
Use Button Settings	When enabled, uses button settings. On = Enabled. The Ultrasound system will use the default image storage and compression presets./Off = Disabled. Properties menu expands and image storage and compression presets can be defined.

### Add DICOM Export

1. Navigate to **Connectivity > Connection Manager > MyComputer Device**.
2. Select **DICOM Export > Configure**.
3. In **Name**, enter a logical name of the service.
4. To have raw cine clips converted to DICOM multi-frames during EzBackup operation, enable **Convert Clips**.
5. To have raw volumes get converted to Enhanced US Volume (DICOM 3D) format during EzBackup operation, enable **Convert Volumes**.
6. To round measurement values to configured number of decimal places, enable **Apply Display Precision to Measurements**.
7. Under **Dicom Coding Scheme**, select how measurements are encoded with configured coding scheme in DICOM SR objects.
8. To use button settings, enable **Use Button Settings**.
9. Select **Done**.



## USB Quick Save

Use USB Quick Save to save images or video clips to a USB flash drive with a print button. The images are stored in either .jpg or .wmv formats.

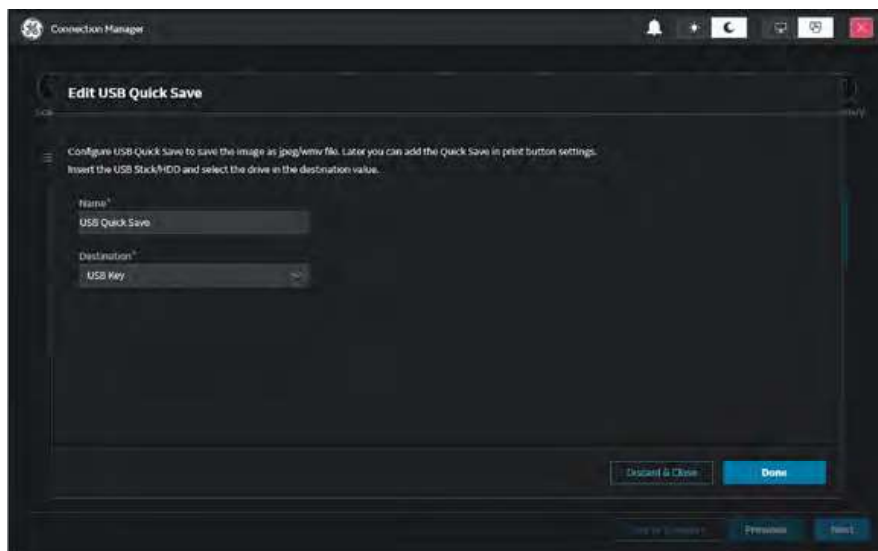

Figure 10-28. Edit USB Quick Save

This table shows all the preset parameters available on Edit USB Quick Save with descriptions.

Table 10-96: Edit USB Quick Save

Preset Parameter	Description
Name	Logical name of the service.
Destination	Destination device for the service.

### Add USB Quick Save

1. Navigate to **Connectivity > Connection Manager > MyComputer Device**.
2. Select **USB Quick Save > Configure**.
3. In **Name**, enter a logical name of the service.
4. Under **Destination**, enter a destination device for the service.
5. Select **Done**.

### HD Export

Use HD Export to save images or video clips to a USB flash drive or HD media with a print button. The images are stored in DICOM format.

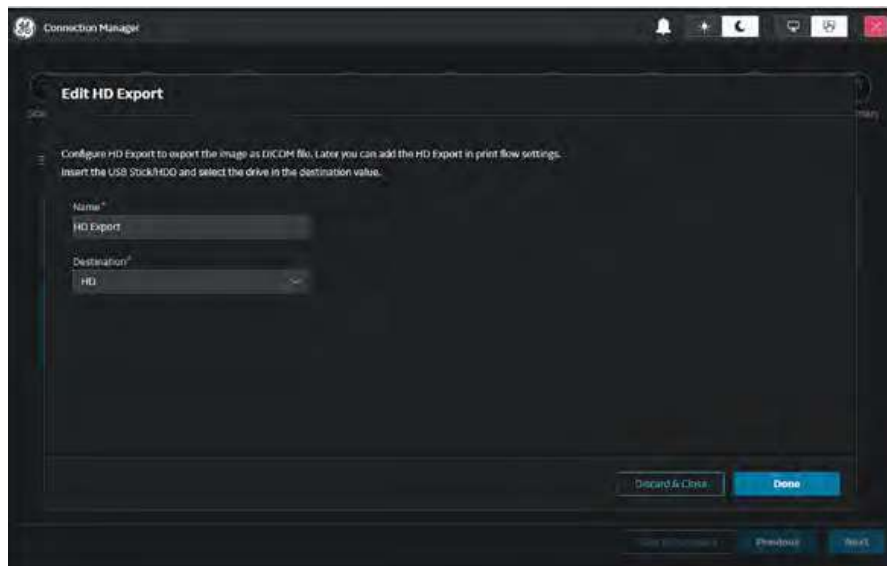

Figure 10-29. Edit HD Export

This table shows all the preset parameters available on Edit HD Export with descriptions.

Table 10-97: Edit HD Export

Preset Parameter	Description
Name	Logical name of the service.
Destination	Destination device for the service

### Add HD Export

1. Navigate to **Connectivity > Connection Manager > MyComputer Device**.
2. Select **HD Export > Configure**.
3. In **Name**, enter a logical name of the service.
4. Under **Destination**, enter a destination device for the service.
5. Select **Done**.

## Dicom Page

Use the Dicom page to add a Dicom device and then add one or more Dicom services to that device.

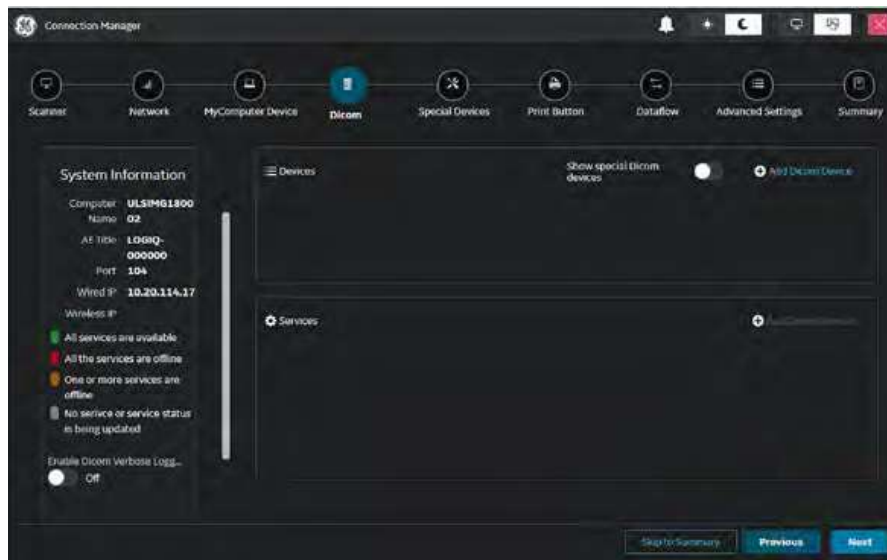

Figure 10-30. Dicom Page

This table shows all the preset parameters available on Dicom with descriptions.

Table 10-98: Dicom Page

Preset Parameter	Description
System Information	Information settings for the Ultrasound system.
Enable Dicom Verbose Logging	When enabled, DICOM traffic messages are logged to protected logs. The default time limit is set for 5 minutes. On = Enabled/ Off = Disabled
Devices	List of created devices.
Show special Dicom devices	When enabled, displays special dicom devices. By default, special dicom devices are hidden. When special devices (for example, Koios and Tricefy) are activated, the Ultrasound system automatically creates special dicom devices on the DICOM page.
Add Dicom Device	Select to add a new Dicom device.
Services	List of created services.
Add Dicom Service	Select to add a new Dicom service.

Refer to the following sections for more information:

- *'Add Dicom Device' on page 10-82*
- *'Add Dicom Service' on page 10-84*

### Add Dicom Device

Use Add Dicom Device to add a destination device (printer, worklist server, etc.) to the Ultrasound system.

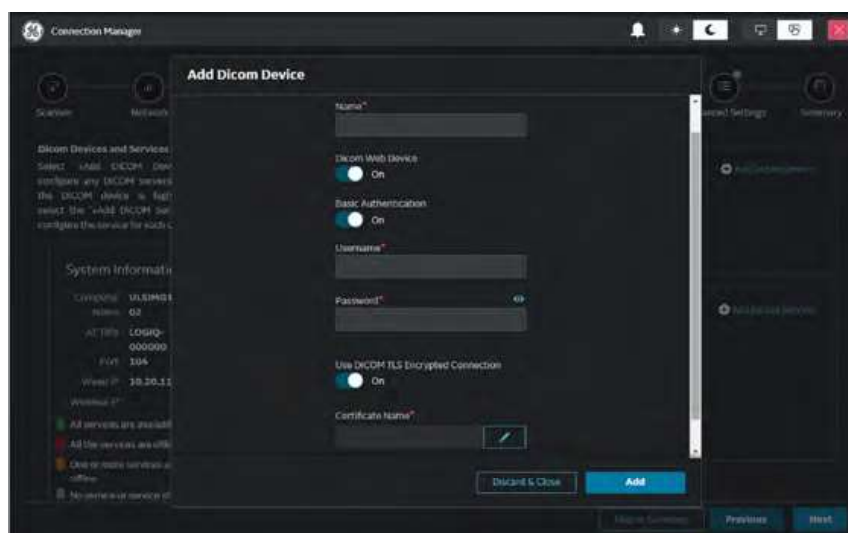

Figure 10-31. Add Dicom Device (with Dicom Web Device On)

This table shows all the preset parameters available on Add Dicom Device with descriptions.

Table 10-99: Add Dicom Device

Preset Parameter	Description
Name	Name for the DICOM device.
Dicom Web Device	Determines whether the device is a web device. On = Enabled/ Off = Disabled
Basic Authentication	When Dicom Web Device is enabled, determines whether basic authentication is used for the device. On = Enabled/ Off = Disabled
Username	Username used when Basic Authentication is enabled.
Password	Password used when Basic Authentication is enabled.
IP Address	When Dicom Web Device is Off, IP address for the device. IP stands for Internet Protocol. Every device on the network has a unique IP address.
Use DICOM TLS Encrypted Connection	When enabled, the Ultrasound system communicates securely with all the configured services for that device with secure communication by encrypting the DICOM objects during transfer through TLS1.2 protocol. On = Enabled/ Off = Disabled
Certificate Name	When Use DICOM TLS Encrypted Connection is enabled, name of imported certificate.

Table 10-99: Add Dicom Device

Preset Parameter	Description
Ping Status	When Dicom Web Device is Off, indicates whether a ping to the device is allowed.
Ping	When Dicom Web Device is Off, select to confirm that the device is connected.
Add	Select to add the DICOM device.
Discard and Close	Select to discard any changes you have made and to close the dialog box.

### Add a Dicom device

1. Navigate to **Connectivity > Connection Manager > Dicom**.
2. To display special Dicom devices, enable **Show special Dicom devices**.
3. Select **Add Dicom Device**.

*NOTE:* To edit an existing device, select the **Edit** for the device.

4. In **Name**, enter a name for the Dicom device.
5. To add a device (not a web device), set **Dicom Web Device** to Off.
6. In **IP Address**, enter an IP address for the device.
7. If **Use DICOM TLS Encrypted Connection** is On, select the pencil icon to display the TLS Encrypted Configuration dialog box to add a certificate.
8. Select **Add**.

### Add a Dicom Web device

1. Navigate to **Connectivity > Connection Manager > Dicom**.
2. To display special Dicom devices, enable **Show special Dicom devices**.
3. Select **Add Dicom Device**.

*NOTE:* To edit an existing device, select **Edit** for the device.

4. In **Name**, enter a name for the Dicom device.
5. To add a web device, set **Dicom Web Device** to On.
6. If Basic Authentication is On, enter a **Username** and **Password**.
7. If **Use DICOM TLS Encrypted Connection** is On, select the pencil icon to display the TLS Encrypted Configuration dialog box to add a certificate.
8. Select **Add**.

### Add Dicom Service

For each added device, set up the service(s) that the device supports (you must be an administrator to update these screens).

Use Add Dicom Service to set the properties for the service. The name and properties in this section change, depending on what service is currently selected.

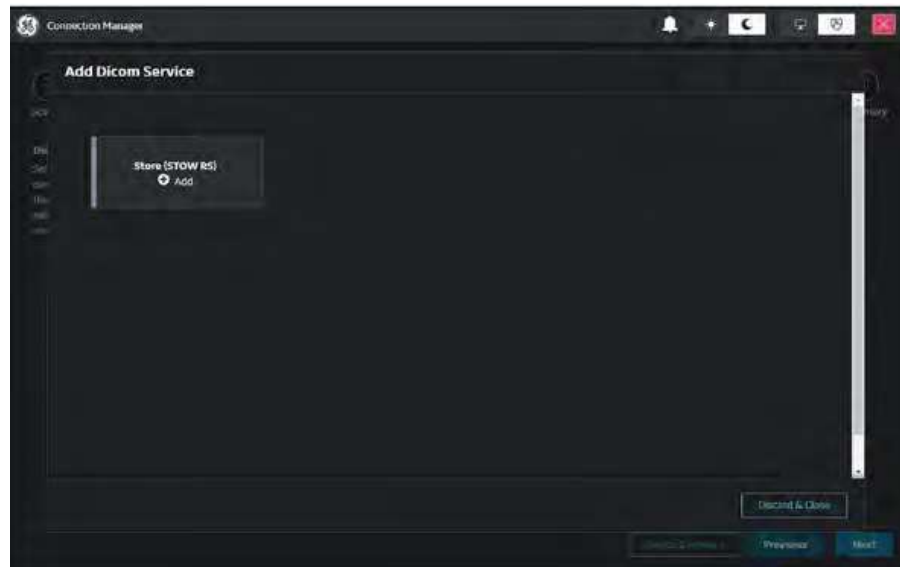

Figure 10-32. Add Dicom Service

Refer to the following sections for more information:

- *'Add Dicom Service - Service' on page 10-85*
- *'Add Dicom Service - Connection' on page 10-86*
- *'Add Dicom Service - Content' on page 10-87*
- *'Add Dicom Service - Compression' on page 10-89*
- *'Add Dicom Service - Summary' on page 10-90*

## Add Dicom Service - Service

Use Add Dicom Service - Service to set the properties for the service. The name and properties in this section change, depending on what service is currently selected.

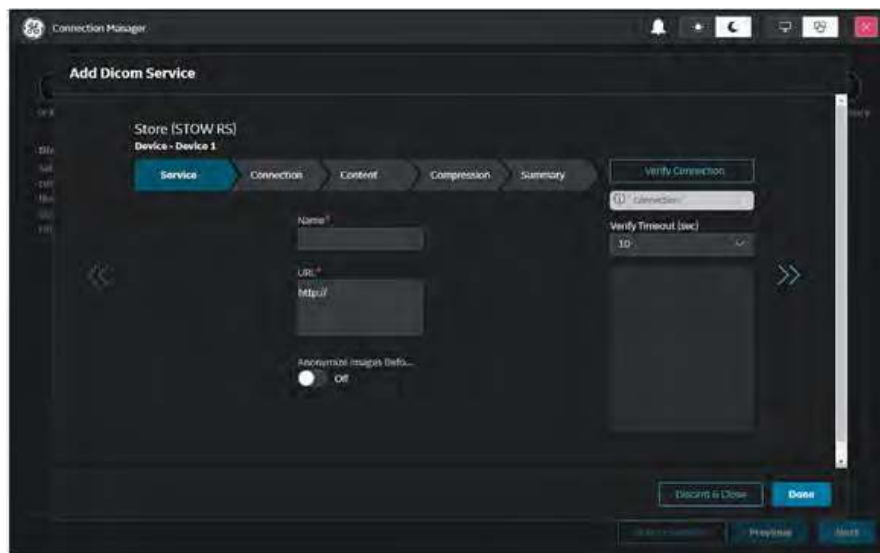

Figure 10-33. Add Dicom Service - Service

This table shows all the preset parameters available on Add Dicom Service - Service with descriptions.

Table 10-100: Add Dicom Service - Service

Preset Parameter	Description
Name	Descriptive name for the service.
URL	URL for the service
Anonymize images Before	When enabled, anonymizes patient data. On = Enabled/ Off = Disabled

### Add Dicom Service - Connection

Use Add Dicom Service - Connection to set the properties for the service. The name and properties in this section change, depending on what service is currently selected.

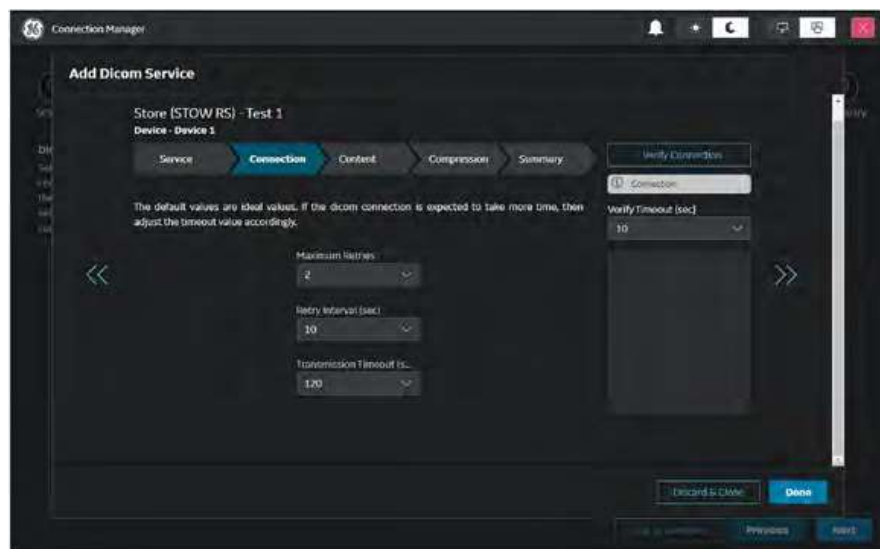

Figure 10-34. Add Dicom Service - Connection

This table shows all the preset parameters available on Add Dicom Service - Connection with descriptions.

Table 10-101: Add Dicom Service - Connection

Preset Parameter	Description
Maximum Retries	Maximum number of times to try establishing a connection to the service.
Retry Interval (sec)	Specify how often (in seconds) the Ultrasound system should try to establish a connection to the service.
Transmission Timeout (sec)	Specify the amount of time (in seconds) after which the Ultrasound system will stop trying to establish a connection to the service.



## Add Dicom Service - Content

Use Add Dicom Service - Content to set the properties for the service. The name and properties in this section change, depending on what service is currently selected.

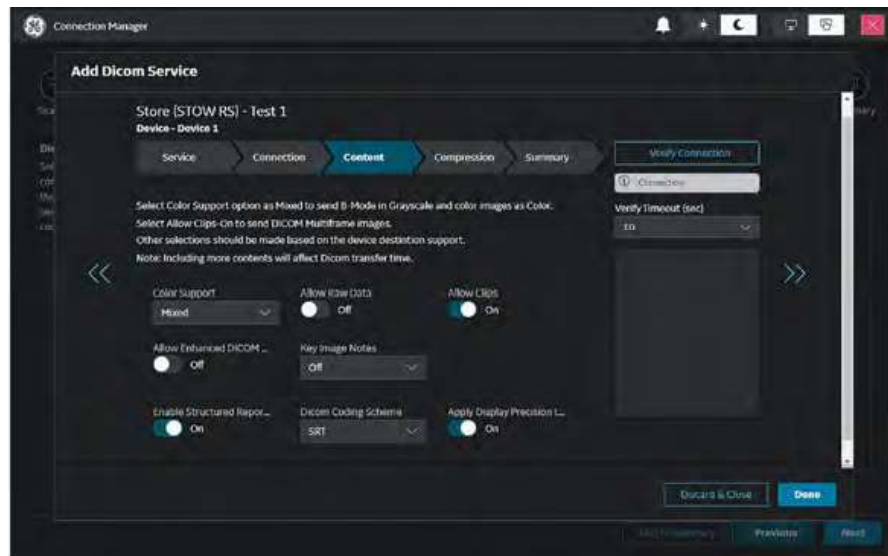

Figure 10-35. Add Dicom Service - Content

This table shows all the preset parameters available on Add Dicom Service - Content with descriptions

Table 10-102: Add Dicom Service - Content

Preset Parameter	Description
Color Support	Select Mixed or Color. Best performance when set to Color.
Allow Raw Data	Select to save data in both TruAccess (raw data) and DICOM format. Clear to save in DICOM format only.
Allow Clips	Select to allow cine loop storage. Deselect to send only Stills to PACS.
Allow Enhanced DICOM Objects	Select to allow enhanced DICOM objects.
Key Image Notes	Image deletion notification. ONLY available for the Direct Store Workflow and ONLY generated when there are images deleted during the exam. Selecting this lets the reader at the PACS system know which images have been deleted. An indicator is placed on deleted images with a reason, "Rejected for Quality Reasons" for example.
Enable Structured Reporting	Select for Structured Reporting.
Dicom Coding Scheme	

Table 10-102: Add Dicom Service - Content

<b>Preset Parameter</b>	<b>Description</b>
Apply Display Precision to Measurements	When Enable Structured Reporting is selected, Apply Display Precision to Measurements is available; select to apply the same precision for a Structured Report that is used on the scanner display. (Apply Display Precision to Measurements is always available for a DICOM SR Storage service.)

## Add Dicom Service - Compression

Use Add Dicom Service - Compression to set the properties for the service. The name and properties in this section change, depending on what service is currently selected.

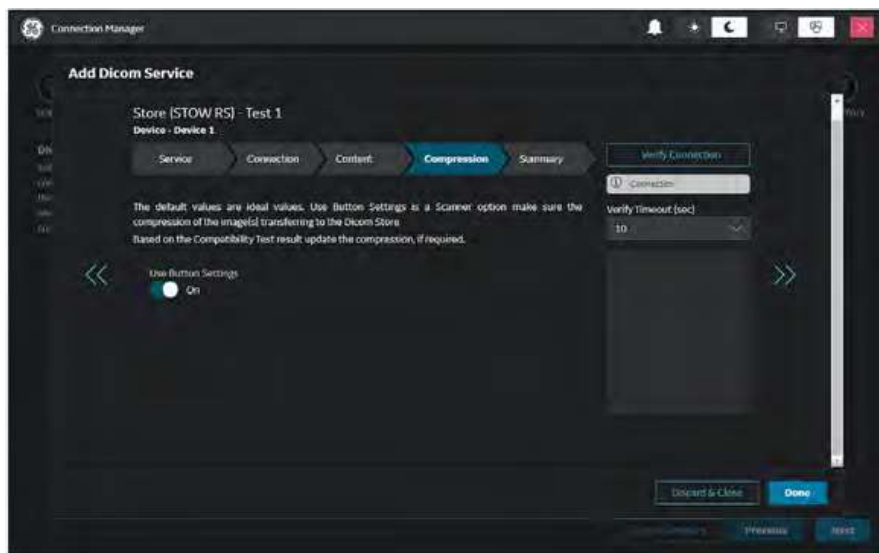

Figure 10-36. Add Dicom Service - Compression

This table shows all the preset parameters available on Add Dicom Service - Compression with descriptions.

Table 10-103: Add Dicom Service - Compression

Preset Parameter	Description
Use Button Settings	If “Use Button Settings” is checked, the system will use the default system image storage and compression presets. If “Use Button Settings” is unchecked, the Properties menu expands and the user can define the image storage and compression presets as desired.

## Add Dicom Service - Summary

Use Add Dicom Service - Summary to set the properties for the service. The name and properties in this section change, depending on what service is currently selected.

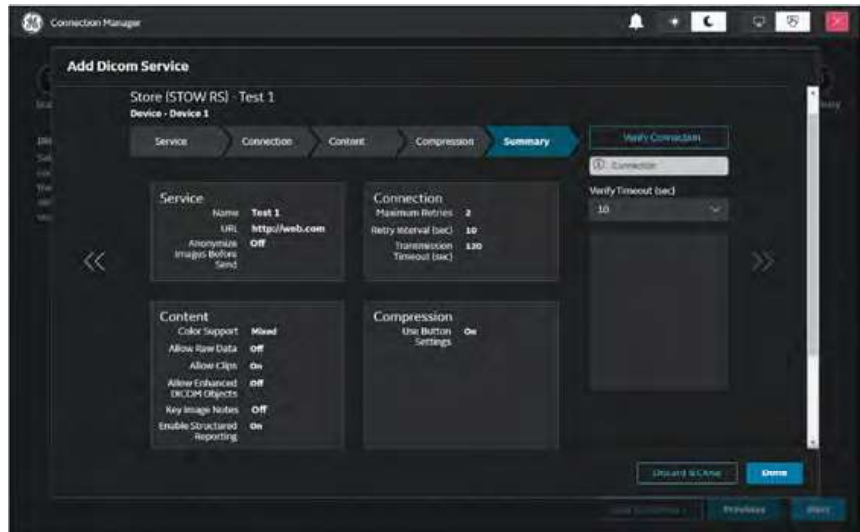

Figure 10-37. Add Dicom Service - Summary

This table shows all the preset parameters available on Add Dicom Service - Summary with descriptions.

Table 10-104: Add Dicom Service - Summary

Preset Parameter	Description
Service	Summary of the service settings for the service. See <i>'Add Dicom Service - Service'</i> on page 10-85
Connection	Summary of the connection settings for the service. See <i>'Add Dicom Service - Connection'</i> on page 10-86
Content	Summary of the content settings for the service. See <i>'Add Dicom Service - Content'</i> on page 10-87
Compression	Summary of the compression settings for the service. See <i>'Add Dicom Service - Compression'</i> on page 10-89
Verify Connection	Checks the connection status with the server and the compatibility with the PACS device.
Verify Timeout	Amount of time after which the system will stop trying to establish a connection to the service.

## Add a Dicom service

1. Navigate to **Connectivity > Connection Manager > Dicom**.
2. Do one of the following:
  - a. If the service is already displayed in Services, select **Edit** for the service.
  - b. If the service is not displayed in Services, select **Add Dicom Service**.
  - c. Select **Service** and then configure the fields on the page.
  - d. Select **Connection** and then configure the fields on the page.
  - e. Select **Content** and then configure the fields on the page.
  - f. Select **Compression** and then configure the fields on the page.
  - g. Select **Summary** to review the settings.
  - h. Select **Done**.

### Special Devices Page

Use the Special Devices page to configure or modify details about the special devices used with the Ultrasound system.

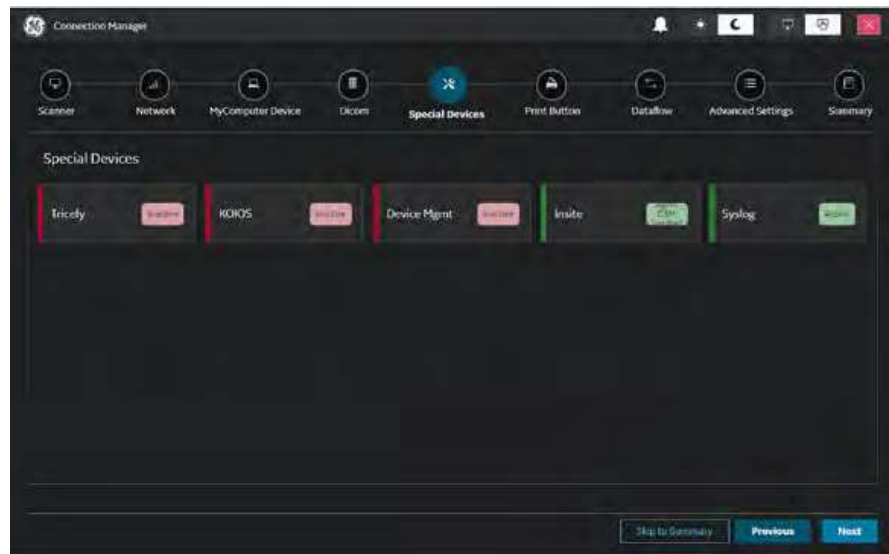

Figure 10-38. Special Devices Page

Refer to the following sections for more information:

- *'Tricefy' on page 10-93*
- *'KOIOS' on page 10-95*
- *'Device Mgmt' on page 10-103*
- *'Insite' on page 10-105*
- *'Syslog' on page 10-109*
- *'Data Streaming' on page 10-112*
- *'Vscan Air' on page 10-114*

## Tricefy

Tricefy is a cloud-based image viewer and a platform to archive, collaborate, and share. The corresponding DICOM destinations can be used through the Print keys. An internet connection is necessary for uploading data to Tricefy. DICOM connectivity to the optional Tricefy Cloud PACS system occurs over a proprietary protocol protected by TLS/HTTPS encryption, although the internal communication is still DICOM-structured.

As soon as the Tricefy option is enabled, relevant Tricefy items are displayed.

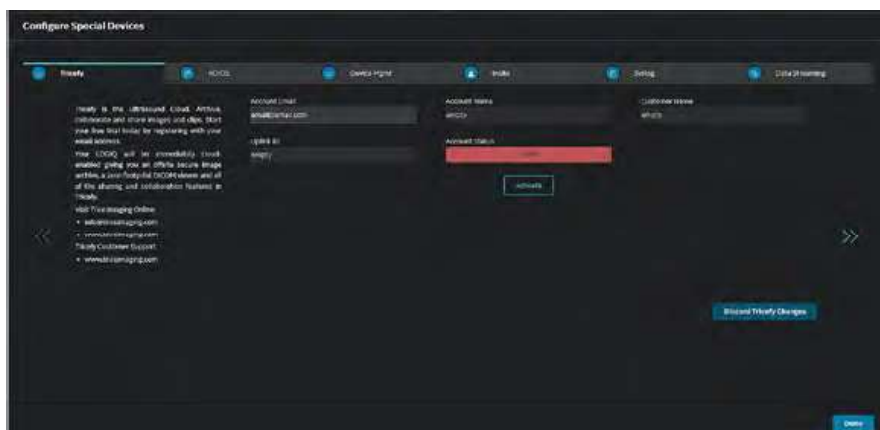

Figure 10-39. Tricefy Page

This table shows all the preset parameters available on Configure Special Devices - Tricefy with descriptions.

Table 10-105: Configure Special Devices - Tricefy

Preset Parameter	Description
Account Email	Email address for the Tricefy account.
Account Name	Name for the Tricefy account.
Customer Name	Name for the customer on the Tricefy account.
Uplink ID	Uplink ID for the Tricefy account.
Account Status	Status of the Tricefy account.
Activate	Select to activate the Tricefy option.
Discard Tricefy Changes	Select to remove any changes made to the Tricefy settings.

### Configure Tricefy

1. Navigate to **Connectivity > Connection Manager > Special Devices**.
2. Select **Tricefy**.
3. Configure the fields on the page.
4. Select **Activate**.
5. Select **Done**.



## KOIOS

Koios DS is a Breast and Thyroid Analysis Option. Koios DS is integrated with the system via DICOM and is configured similar to a DICOM Service. The user can accept/dismiss analysis results. If accepted, these results are included in the DICOM Structured Report.

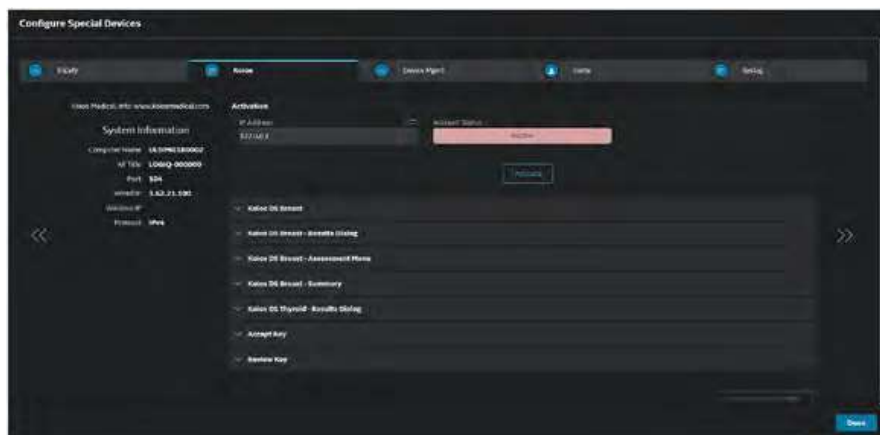

Figure 10-40. KOIOS Page

This table shows all the preset parameters available on Configure Special Devices - KOIOS with descriptions.

Table 10-106: Configure Special Devices - KOIOS

Preset Parameter	Description
IP Address	IP address for the Koios DS server.
Account Status	Status of the Koios DS account. Active or inactive.
Activate	Select to receive notification that you have successfully connected to the Koios DS server and the required device, service, and printflows will be automatically created.

Refer to the following sections for more information:

- *'KOIOS DS Breast' on page 10-96*
- *'KOIOS DS Breast - Results Dialog' on page 10-97*
- *'KOIOS DS Breast - Assessment Menu' on page 10-98*
- *'KOIOS DS Breast - Summary' on page 10-99*
- *'KOIOS DS Thyroid - Results Dialog' on page 10-100*
- *'Accept Key' on page 10-101*
- *'Review Key' on page 10-102*

## KOIOS DS Breast

Use Scanner Network Properties - General to configure the protocol setting.

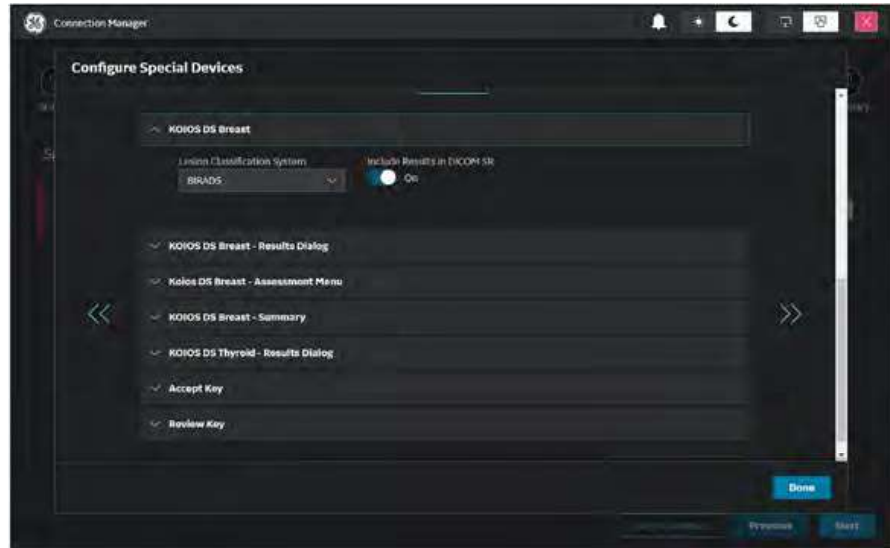

Figure 10-41. KOIOS Page - KOIOS DS Breast

This table shows all the preset parameters available on KOIOS DS Breast with descriptions.

Table 10-107: KOIOS Page - KOIOS DS Breast

Preset Parameter	Description
Lesion Classification System	Select BI-RADS or U1-U5.
Include Result in DICOM SR	Select to save Koios Breast results to Structured Reporting.

## KOIOS DS Breast - Results Dialog

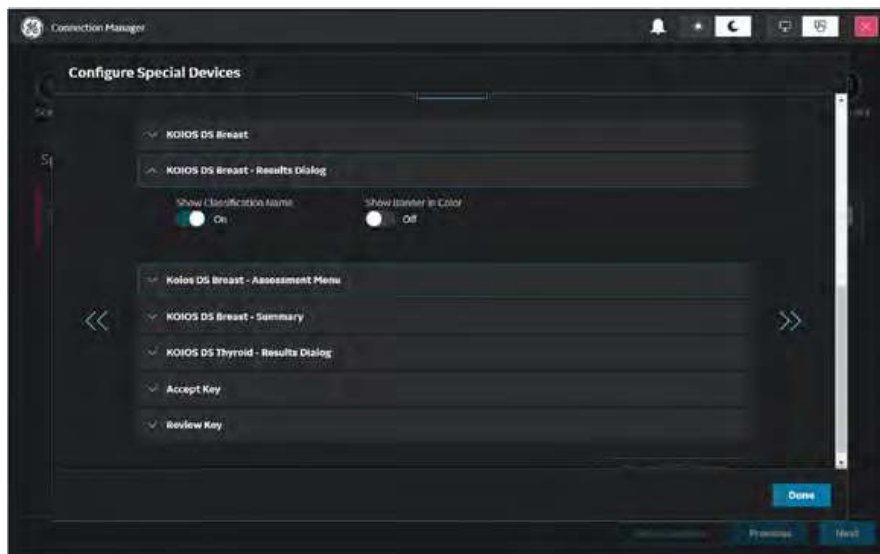

Figure 10-42. KOIOS Page - KOIOS DS Breast Results Dialog

This table shows all the preset parameters available on KOIOS DS Breast Results Dialog with descriptions.

Table 10-108: KOIOS Page - KOIOS DS Breast Results Dialog

Preset Parameter	Description
Show Classification Name	Select to show classification name.
Show Banner in Color	Select to show banner in color.

## KOIOS DS Breast - Assessment Menu

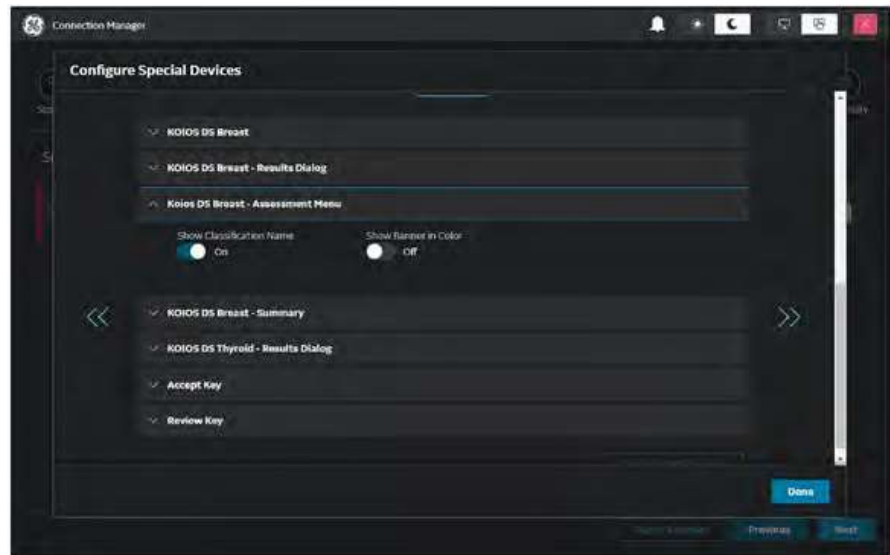

Figure 10-43. KOIOS DS Breast - Assessment Menu

This table shows all the preset parameters available on KOIOS DS Breast - Assessment Menu with descriptions.

Table 10-109: KOIOS DS Breast - Assessment Menu

Preset Parameter	Description
Show Classification Name	Select to show classification name.
Show Banner in Color	Select to show banner in color.

## KOIOS DS Breast - Summary

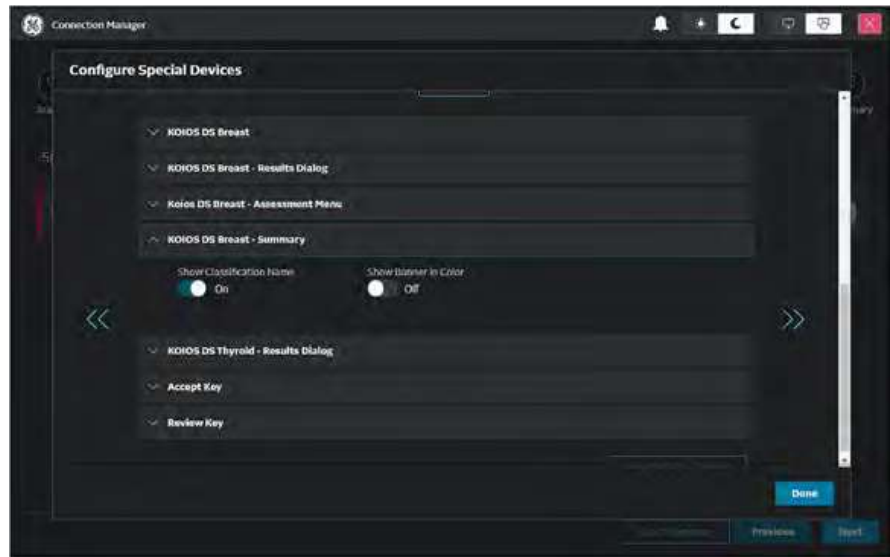

Figure 10-44. KOIOS DS Breast - Summary

This table shows all the preset parameters available on KOIOS DS Breast - Summary with descriptions.

Table 10-110: KOIOS DS Breast - Summary

Preset Parameter	Description
Show Classification Name	Select to show classification name.
Show Banner in Color	Select to show banner in color.

## KOIOS DS Thyroid - Results Dialog

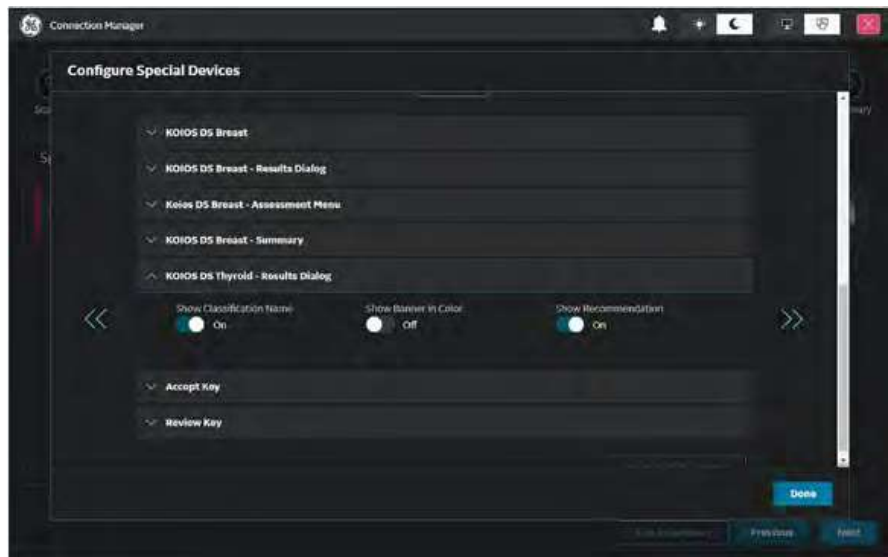

Figure 10-45. KOIOS DS Thyroid - Results Dialog

This table shows all the preset parameters available on KOIOS DS Thyroid - Results Dialog with descriptions.

Table 10-111: KOIOS DS Thyroid - Results Dialog

Preset Parameter	Description
Show Classification Name	Select to show classification name.
Show Banner in Color	Select to show banner in color.
Show Recommendation	Select to show recommendation

## Accept Key

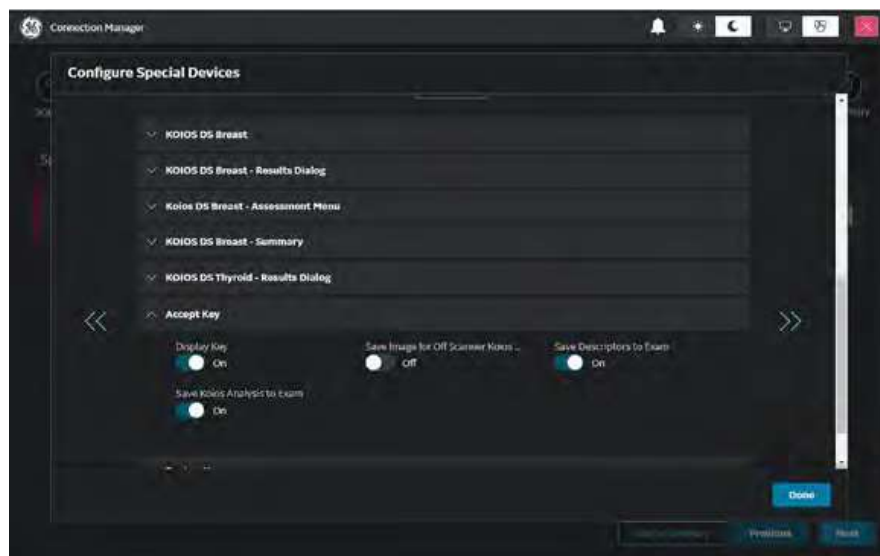

Figure 10-46. KOIOS Page - Accept Key

This table shows all the preset parameters available on KOIOS Page - Accept Key with descriptions.

Table 10-112: KOIOS Page - Accept Key

Preset Parameter	Description
Display Key	Select to display this key in the Results dialog.
Save Image for Off Scanner Koios Analysis	Select to save the image sent to Koios in the exam for off scanner analysis.
Save Descriptors to Exam	Select to save Descriptors from Koios Analysis to the exam.
Save Koios Analysis to Exam	Select to save Koios Analysis result to the exam.

### Review Key

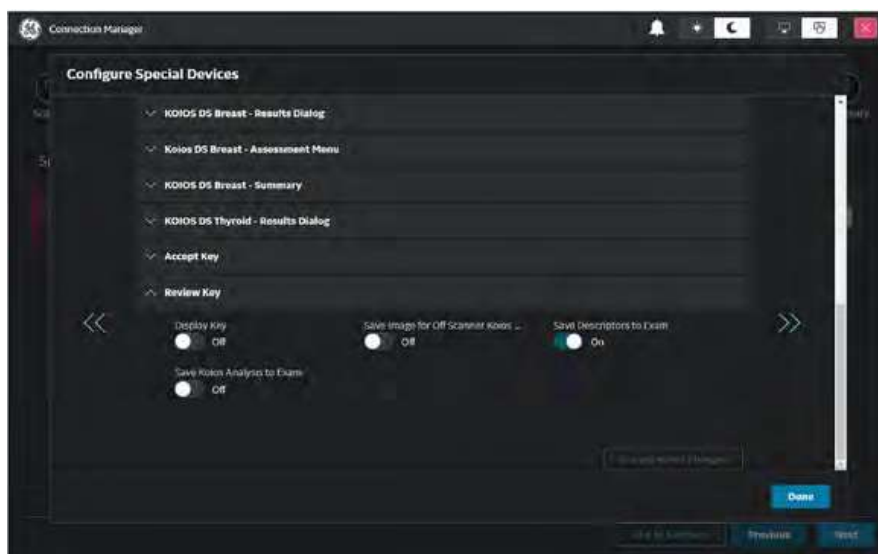

Figure 10-47. KOIOS Page - Review Key

This table shows all the preset parameters available on KOIOS Page - Review Key with descriptions.

Table 10-113: KOIOS Page - Review Key

Preset Parameter	Description
Display Key	Select to display this key in the Results dialog.
Save Image for Off Scanner Koios Analysis	Select to save the image sent to Koios in the exam for off scanner analysis.
Save Descriptors to Exam	Select to save Descriptors from Koios Analysis to the exam.
Save Koios Analysis to Exam	Select to save Koios Analysis result to the exam.

### Configure KOIOS

1. Navigate to **Connectivity > Connection Manager > Special Devices**.
2. Select **KOIOS**.
3. Configure the fields on the page.
4. Select **Activate**.
5. Select **Done**.



## Device Mgmt

Device Mgmt is a remote device management tool that enables bi-directional management capabilities on the device. Device Mgmt allows Cloud management of system preset configurations to a fleet of systems on network, as well as one to one system preset configuration Cloud backup and restore.

**NOTE:** For Cloud operation please refer to Device Mgmt online user manual after sign-up at <http://AVURI.gehealthcare.com/signup>

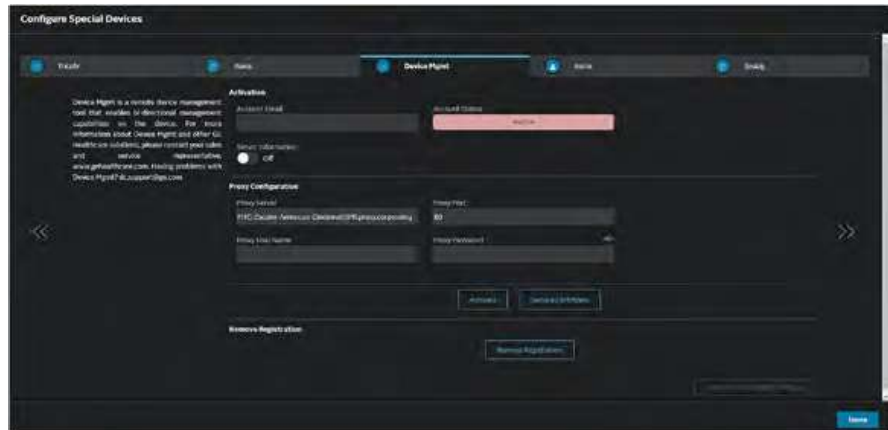

Figure 10-48. Device Mgmt Page

This table shows all the preset parameters available on Configure Special Devices - Device Mgmt with descriptions.

Table 10-114: Configure Special Devices - Device Mgmt

Preset Parameter	Description
Account Email	Email address for the Device Management account.
Account Status	Indicates whether Device Management is active or not. Valid values are Inactive or Active. This field will be Inactive after activation has failed. Otherwise, the field will be empty. If you never activated or activated and then deactivated, this field will be empty
Server Information	When enabled, displays the server information for the Device Management account. On = Enabled/Off = Disabled
Registration Key	Registration key for the Device Management account. Product specific key strings, pre-populated by the device (can be overwritten if necessary).
Server URL	URL of registration server strings, pre-populated by the device (can be overwritten if necessary).
Use Proxy	Enable to use a proxy server. On = Enabled/Off = Disabled

Table 10-114: Configure Special Devices - Device Mgmt

Preset Parameter	Description
Use System Proxy	When selected, uses the proxy settings configured under the Network page > Proxy tab.
Proxy Server	Name of the proxy server IP provided by the customer. This field is optional unless required by the customer facility infrastructure.
Proxy Port	Number of the proxy server port provided by the customer. This field is optional unless required by the customer facility infrastructure.
Proxy Credentials	Enable to use credentials for a proxy server. On = Enabled/Off = Disabled
Proxy User Name	Name of the proxy user provided by the customer. This field is optional unless required by the customer facility infrastructure.
Proxy Password	Password for the proxy user name provided by the customer. This field is optional unless required by the customer facility infrastructure.
Activate	Select to activate/deactivate Device Management.
Service Certificate	Select to download the certificate for Device Management from the backoffice server.
Remove Registration	Select to remove registration for Device Management from the backoffice server.

### Configure Device Mgmt

1. Navigate to **Connectivity > Connection Manager > Special Devices**.
2. Select **Device Mgmt**.
3. Configure the fields on the page.
4. Select **Activate**.
5. Select **Done**.

Insite

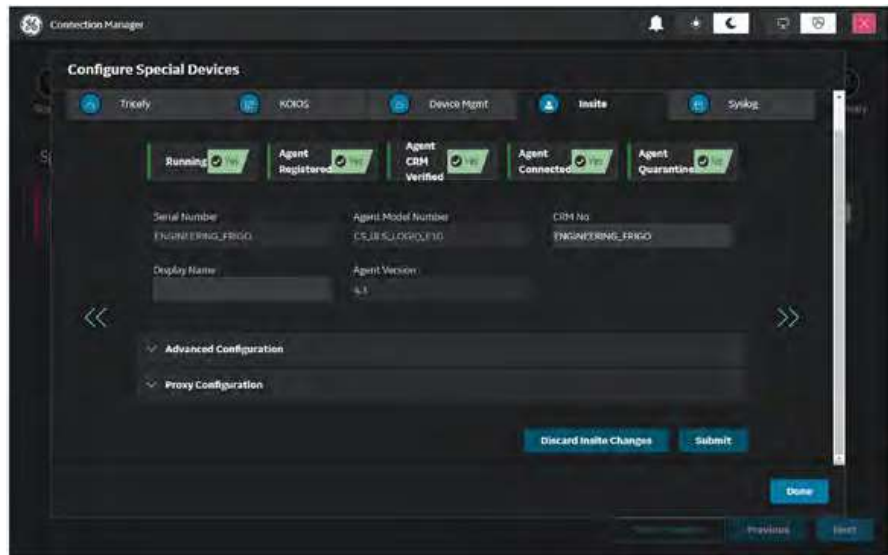

Figure 10-49. Configure Special Devices - Insite

This table shows all the preset parameters available on Configure Special Devices - Insite with descriptions.

Table 10-115: Configure Special Devices - Insite

Preset Parameter	Description
Serial Number	Serial number of the agent (read-only). If the agent is not registered with a serial number, this field is populated with the serial number of the Ultrasound system. The serial number of the agent is tied to the serial number of the Ultrasound system.
Agent Model Number	GE part number for the Ultrasound system. The same number as listed on the rating plate.
CRM No	Customer Relationship Management (CRM) number. System identifier assigned to the customer unit by the service region. This number must match the System ID loaded in Siebel CRM and the GE CARES sticker.
Display Name	Displayed name of the agent.
Agent Version	When Agent Connected is Yes, version of the RsVP Agent that is installed on the machine which facilitates the connectivity to the backoffice.

Autoconnect

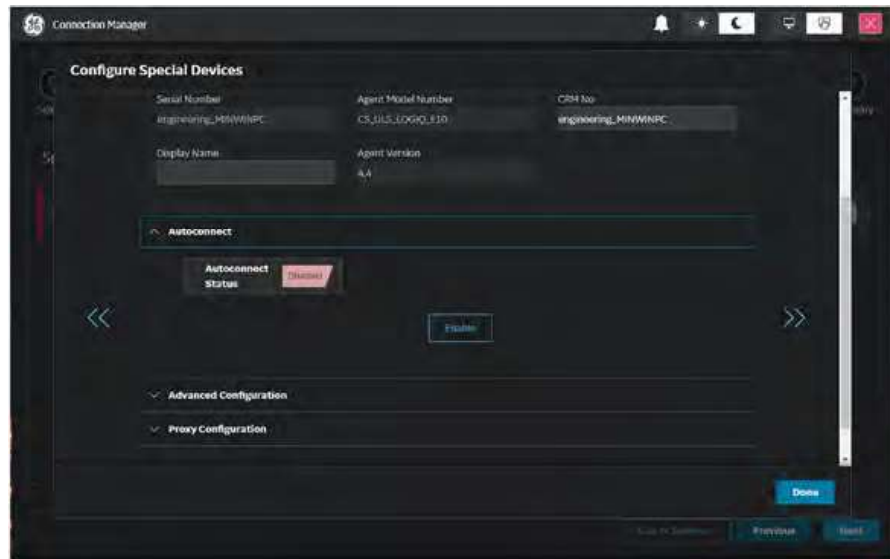

Figure 10-50. Insite Page - Autoconnect

This table shows all the preset parameters available on Autoconnect with descriptions.

Table 10-116: Insite Page - Autoconnect

Preset Parameter	Description
Autoconnect Status	Indicates whether Autoconnect to Insite is enabled or disabled.
Enable/Disable	Select to enable or disable Autoconnect to Insite.

## Advanced Configuration

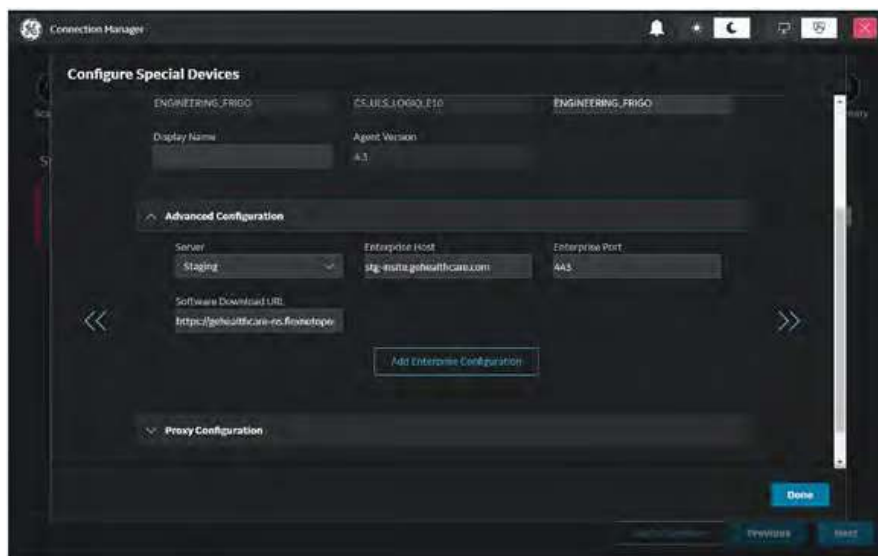

Figure 10-51. Insite Page - Advanced Configuration

This table shows all the preset parameters available on Advanced Configuration with descriptions.

Table 10-117: Insite Page - Advanced Configuration

Preset Parameter	Description
Server	Name of the enterprise server. This field should be normally set to Production for USCAN customers. Valid values are: <ul style="list-style-type: none"> <li>• Production - Use to configure an enterprise server for USCAN.</li> <li>• Production-EU - Use to configure an enterprise server for Europe.</li> <li>• CURRENT - Use to configure an enterprise server. CURRENT will be available after configuring a server with the Others selection.</li> <li>• Others - Use to configure a staging server. Select Others, add the server url (stginsite.healthcare.ge.com) and port (443). Do not use the IP address of the enterprise server using the Others selection as Windows 10 has removed the ability to bypass a certificate error that occurs when using the IP address. This error can block connectivity.</li> </ul>
Enable/Disable	Name of the enterprise host. This field should be normally set to insite.gehealthcare.com.
Enterprise Port	Number of the enterprise port. This field should be normally set to 443.
Software Download URL	Address where software will be downloaded from to the Ultrasound system.
Add Enterprise Configuration	Use as an alternative option to add an enterprise server. Once you use Add Enterprise Configuration to add an enterprise server, that enterprise server will be listed under Server. Add Enterprise Configuration can be used instead of Others.

## Proxy Configuration

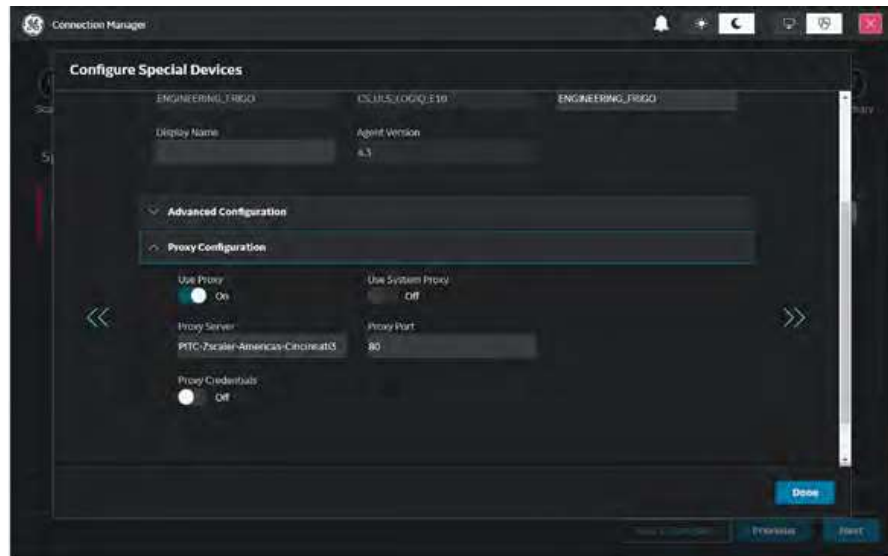

Figure 10-52. Insite Page - Proxy Configuration

This table shows all the preset parameters available on Proxy Configuration with descriptions.

Table 10-118: Insite Page - Proxy Configuration

Preset Parameter	Description
Use Proxy	Enable to use a proxy server. On = Enabled/Off = Disabled
Use System Proxy	When enabled, uses the proxy settings configured under the Network page > Proxy tab. On = Enabled/Off = Disabled
Proxy Server	When Use Proxy is On, provide proxy server address of the facility.
Proxy Port	When Use Proxy is On, provide port number of the proxy server.
Proxy Credentials	When Use System Proxy is Off, enable to use credentials for a proxy server. On = Enabled/Off = Disabled
Proxy User Name	When Proxy Credentials is On, provide account user name of the proxy server.
Proxy Password	When Proxy Credentials is On, provide account password of the proxy server

### Configure Insite

1. Navigate to **Connectivity > Connection Manager > Special Devices**.
2. Select **Insite**.
3. Configure the fields on the page.
4. Select **Submit**.
5. Select **Done**.

## Syslog

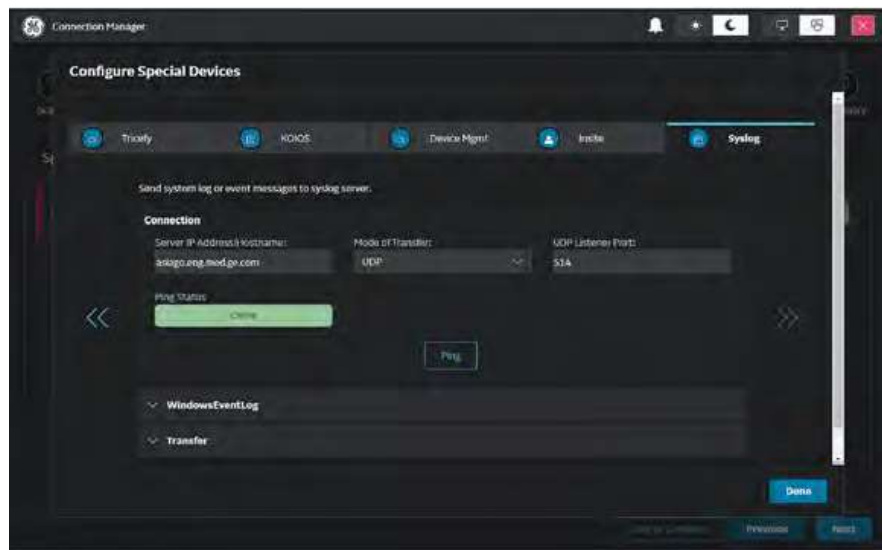

Figure 10-53. Configure Special Devices - Syslog

This table shows all the preset parameters available on Configure Special Devices - Syslog with descriptions.

Table 10-119: Configure Special Devices - Syslog

Preset Parameter	Description
Server IP Address/ Hostname	IP address of the server.
Mode of Transfer	Mode of transferring the data to the server (UDP, TCP, or TLS).
UDP Listener Port	User Datagram Protocol Listener Port. This is the port which we transfer logging data to use the syslog data protocol. It can be done by UDP or TCP, depending on the configuration of the customer logging server.
Ping Status	Indicates whether the connection has been confirmed or not.
Ping	Select to confirm that the server is connected.

## WindowsEventLog

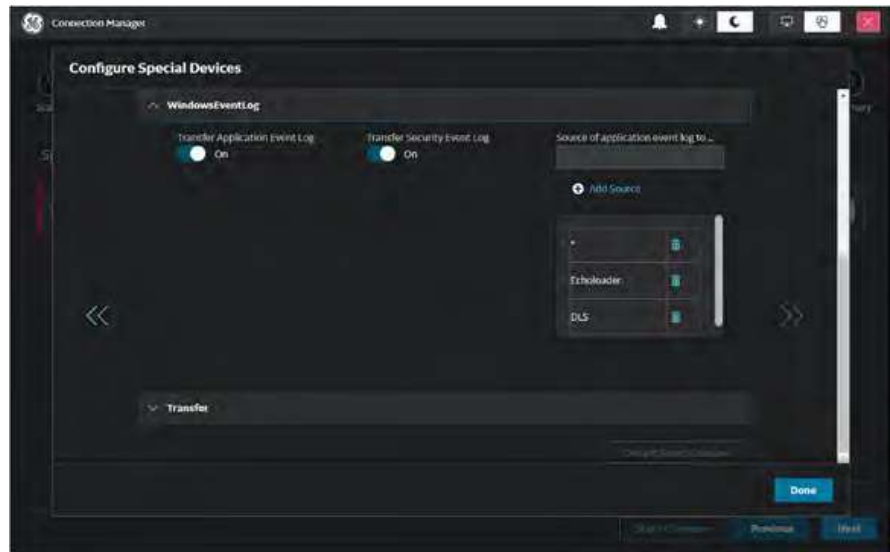

Figure 10-54. Syslog - WindowsEventLog

This table shows all the preset parameters available on WindowsEventLog with descriptions.

Table 10-120: Syslog - WindowsEventLog

Preset Parameter	Description
Transfer Application Event Log	When enabled, allows the transfer of application event logs. On = Enabled/Off = Disabled
Transfer Security Event Log	When enabled, allows the transfer of security event logs. On = Enabled/Off = Disabled
Source of application event log to transfer	Where to draw data from for the audit report.
Add Source	Select to specify where to draw data from for the audit report.



Transfer

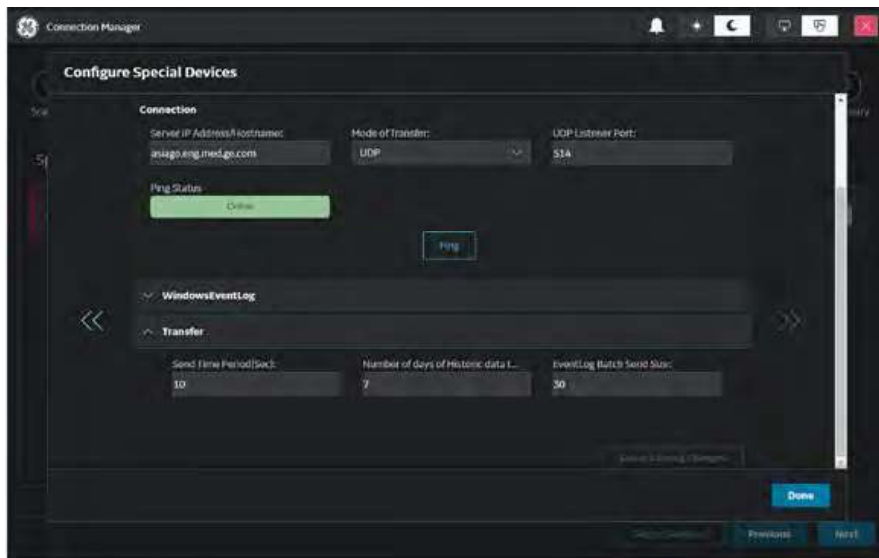

Figure 10-55. Syslog - Transfer

This table shows all the preset parameters available on Transfer with descriptions.

Table 10-121: Syslog - Transfer

Preset Parameter	Description
Send Time Period (Sec)	How often the system will attempt to contact the logging server to send logs.
Number of days of Historic data to send	If logging server connectivity has not been available, how many days of history should be sent when it is restored?
EventLog Batch Send Size	When sending historic data, how much to send in each transaction - this can help manage network traffic and server load, not typically necessary to change this.

Configure Syslog

1. Navigate to **Connectivity > Connection Manager > Special Devices**.
2. Select **Syslog**.
3. Configure the fields on the page.
4. Select **Ping**.
5. Select **Done**.

### Data Streaming

Use Data Streaming to stream live/recall/CINE ultrasound image data over the network connection to enabled devices. The data stream will contain grayscale, color map, geometry, view settings (flip/rotate/reverse), probe and system information, VNav position information with ultrasound data. No patient information is transferred with the streamed data.

It is recommended to use a 1 Gbps network connection for Data Streaming. The required bandwidth often lies in the 100-300 Mbps range. Usage of a 100 Mbps network leads to dropped frames and the risk of latency buildup.

The Data Streaming option key needs to be installed to enable the Data Streaming page.

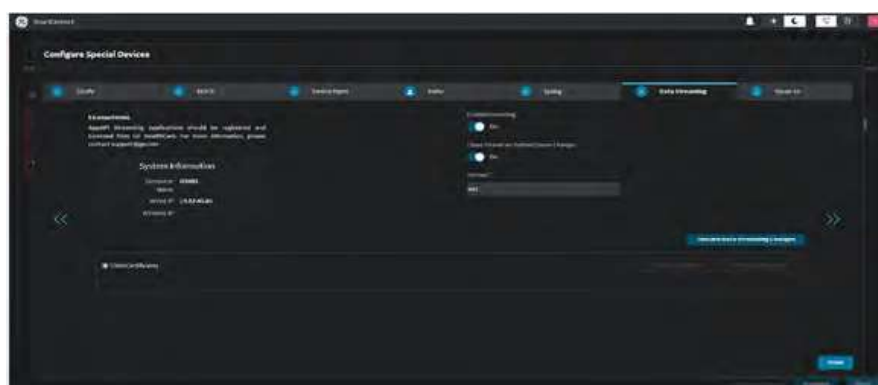

Figure 10-56. Configure Special Devices - Data Streaming

This table shows all the preset parameters available on Configure Special Devices - Data Streaming with descriptions.

Table 10-122: Configure Special Devices - Data Streaming

Preset Parameter	Description
System Information	Shows system information properties for the configured Ultrasound system.
Enable Streaming	When enabled, data streaming is allowed.
Close Stream on Patient/Exam Change	When enabled, data streaming will close when the patient/exam is changed.
PortNo	Port number used for data streaming.
Revoke Selected	Select to remove selected client certificates.
Revoke All Expired	Select to remove all expired client certificates.

### **Configure Data Streaming**

1. Navigate to **Connectivity > Connection Manager > Special Devices**.
2. Select **Data Streaming**.
3. Configure the fields on the page.
4. Select **Done**.

### Vscan Air

Use Vscan Air to pair the Vscan Air CL probe with the Ultrasound system.

The Vscan Air CL probe is a battery-operated, wireless, general-purpose diagnostic handheld ultrasound imaging system.

The Vscan Air option key needs to be installed to enable the Vscan Air page.

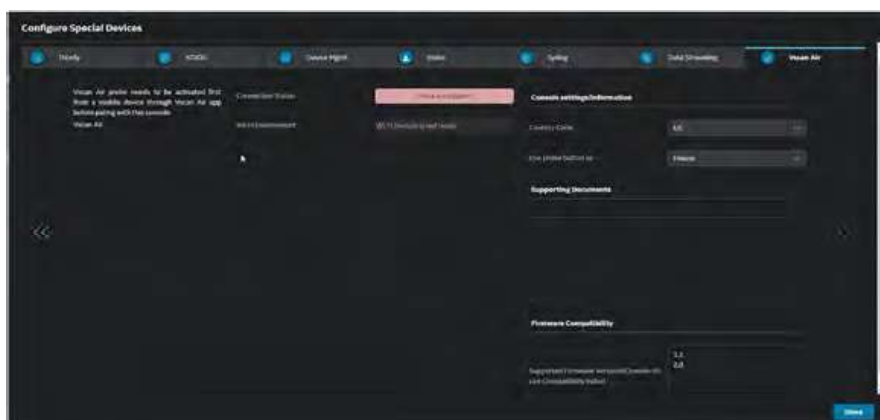

Figure 10-57. Configure Special Devices - Vscan Air (Not Paired with the Probe)



Figure 10-58. Configure Special Devices - Vscan Air (Paired with the Probe)

This table shows all the preset parameters available on Configure Special Devices - Vscan Air with descriptions.

Table 10-123: Configure Special Devices - Vscan Air

Preset Parameter	Description
Connection Status	Indicates the pairing status (with the serial number) of the Vscan Air probe.
Wi-Fi Environment	Indicates whether the current Wi-Fi environment (signal strength, channel usage) is appropriate for Vscan Air usage and displays errors if there are issues with Wi-Fi hardware.
Country Code	Setting for the Vscan Air probe to meet country regulations (for example, Wi-Fi frequencies).
Use probe button as	Maps the Vscan Air probe button to different functions (for example, Freeze/Print/Toggle).
Probe Serial Number	Serial number of the paired Vscan Air probe.
Probe Model	Model of the paired probe.
Probe Firmware Version	Firmware version on the paired Vscan Air probe.
Battery Level	Battery level for the paired Vscan Air probe.
Probe Temperature	Current temperature of the paired Vscan Air probe.
Activation Status	Indicates whether the Vscan Air probe is activated or not.
Acoustic Output Table (R1)	Link to the acoustic power output table for the paired Vscan Air probe.
Supporting Documents	Link to manuals and tips for the Vscan Air probe (if applicable)
Firmware Compatibility	Lists all the compatible Vscan Air probe firmware versions that can be paired with the Ultrasound system. If the firmware on the paired probe is not compatible with the Ultrasound system, firmware downgrade menu will be activated to allow user to downgrade probe firmware to a compatible probe firmware version.

### Configure Vscan Air CL

1. Navigate to **Connectivity > Connection Manager > Special Devices**.
2. Select **Vscan Air**.
3. Configure the fields on the page.
4. Select **Done**.

### Print Button Page

Use the Print Button page to configure or modify details about the print buttons used for the Ultrasound system.

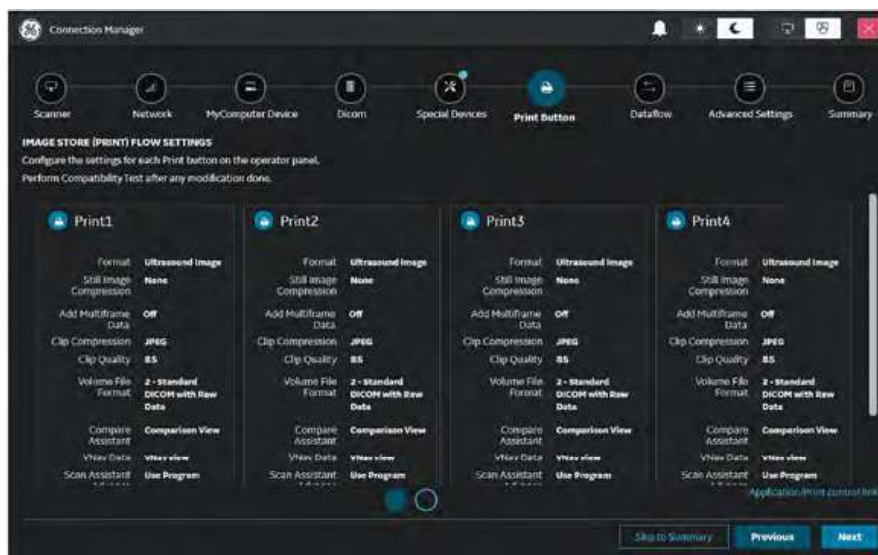

Figure 10-59. Print Button Page

### Configure Print Button

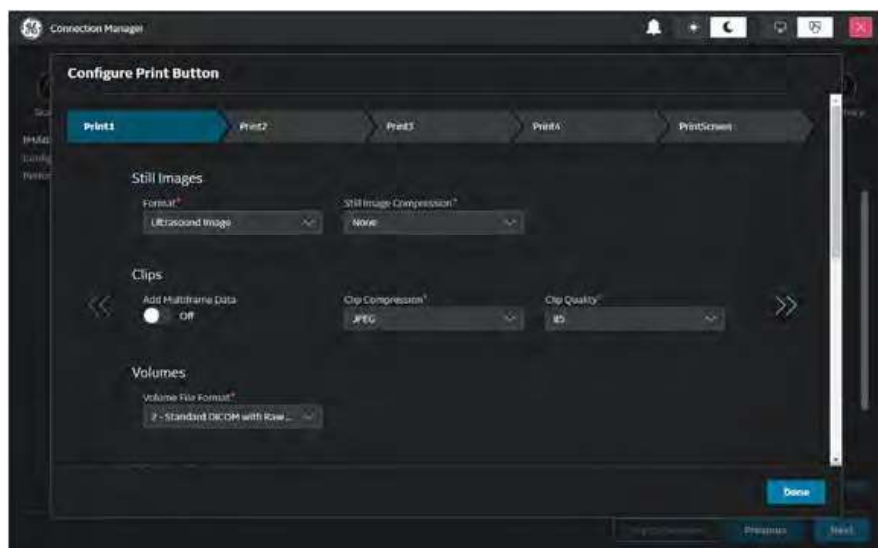

Figure 10-60. Configure Print Button

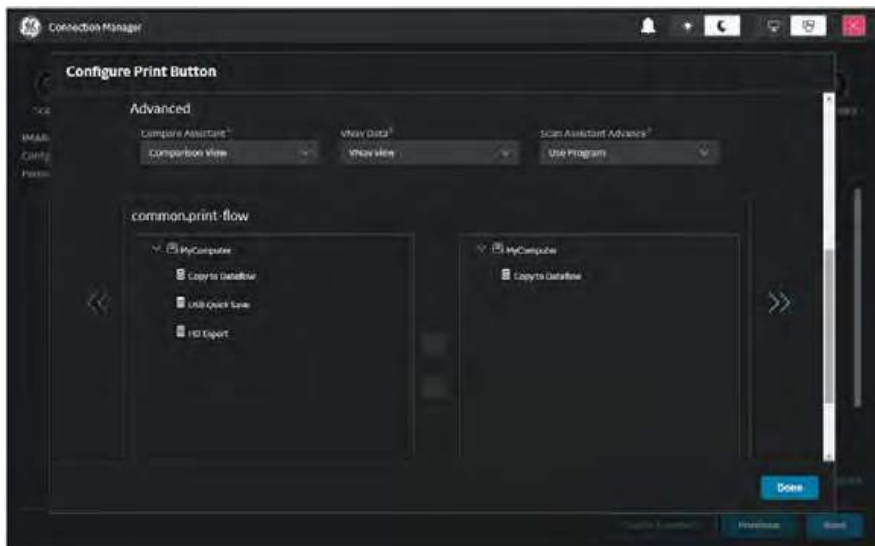

Figure 10-61. Configure Print Button - Advanced

This table shows all the preset parameters available on Configure Print Button with descriptions.

Table 10-124: Configure Print Button

Preset Parameter	Description
Format	Format: Ultrasound Image, Secondary Capture (Image, Video, Screen)
Still Image Compression	Compression: None, Rle, Jpeg, Jpeg2000
Add Multiframe Data	Clips: Add Multiframe Data: Checkbox
Clip Compression	Compression: None, Rle, Jpeg, Jpeg2000
Clip Quality	Quality: Lossless, 99, 98, 97, ... 50
Volume File Format	1-Standard DICOM (Default), 2-Standard DICOM with Raw Data; 3-Enhanced DICOM, 2&3 (2 files)
Compare Assistant	Compare Assistant: Comparison view (Default), New image, Both Comparison & New (2 files)
VNav Data	VNav Data: V Nav View (Default), Ultrasound Only, or VNav & Ultrasound (2 files)
Scan Assistant Advance	Scan Assistant Advance: On, Off, Use program (system uses setting from the Scan Assistant program which allows a user to configure two print keys identically except that one advances Scan Assistant and the other does not.) On =advances to the next step when that print key is pressed independently of the program setting. Off = does not advance to the next step when the print key is pressed independently of the program setting

### Configure a print button

1. Navigate to **Connectivity > Connection Manager > Print Button**.
2. Select **Print button**.
3. Configure the fields on the page.
4. Select **Done**.



## Dataflow Page

Use the Dataflow page to configure or modify details about the data flow properties used for the Ultrasound system.

A dataflow is a set of pre-configured services. When you select a dataflow, the ultrasound system automatically works according to the services associated with the dataflow. The Dataflow tab allows you to select and review information about dataflows. You can also create, change, and remove dataflows.

Set up dataflows for the services.

**NOTE:** You must be logged on as Administrator to use the Dataflow tab.

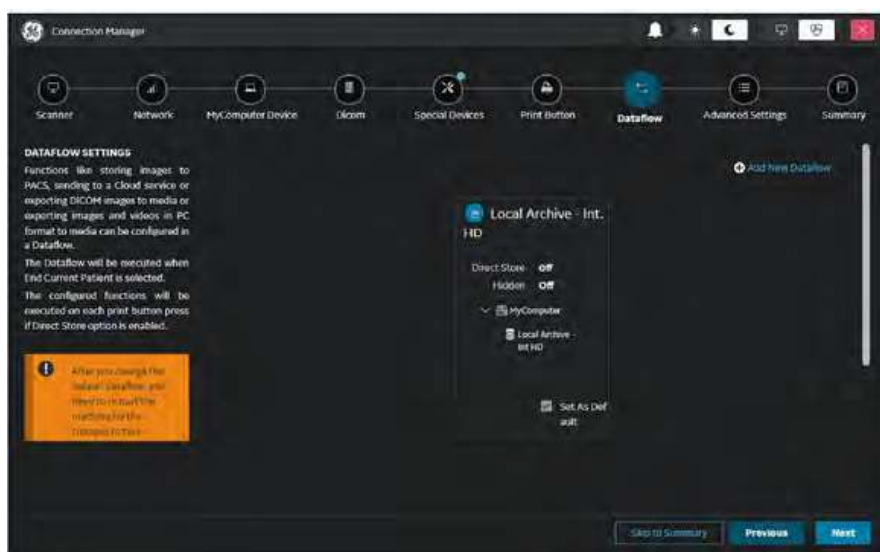

Figure 10-62. Dataflow Page

This table shows all the preset parameters available on Dataflow Page with descriptions.

Table 10-125: Dataflow Page

Preset Parameter	Description
Direct Store	Select to store data directly to archive (no buffer storage).
Hidden	Select so that this dataflow does not appear as a Dataflow on the Patient menu.
Set As Default	Select to use this dataflow as the default dataflow when the Ultrasound system starts.
Add New Dataflow	Select to add a new dataflow.

### Add a dataflow

1. Navigate to **Connectivity > Connection Manager > Data flow**.
2. Select **Add New Dataflow**.
3. Configure the fields on the page.
4. Select **Add**.

## Advanced Settings Page

Use the Advanced Settings page to configure or modify details about the advanced setting properties used for the Ultrasound system.

Refer to the following sections for more information:

- *'Advanced Settings - Patient Screen page' on page 10-122*
- *'Advanced Settings - Search Settings page' on page 10-124*
- *'Advanced Settings - Worklist Settings page' on page 10-125*
- *'Advanced Settings - Dataflow Settings page' on page 10-126*
- *'Advanced Settings - Dataflow Notification page' on page 10-127*
- *'Advanced Settings - Transfer Settings page' on page 10-129*
- *'Advanced Settings - Print Button Settings page' on page 10-131*
- *'Advanced Settings - Image Numbering page' on page 10-133*
- *'Advanced Settings - Imaging Insights page' on page 10-134*
- *'Advanced Settings - Measurement page' on page 10-135*
- *'Advanced Settings - Spooler Settings page' on page 10-136*
- *'Advanced Settings - LOGIQ Apps page' on page 10-137*

## Advanced Settings - Patient Screen page

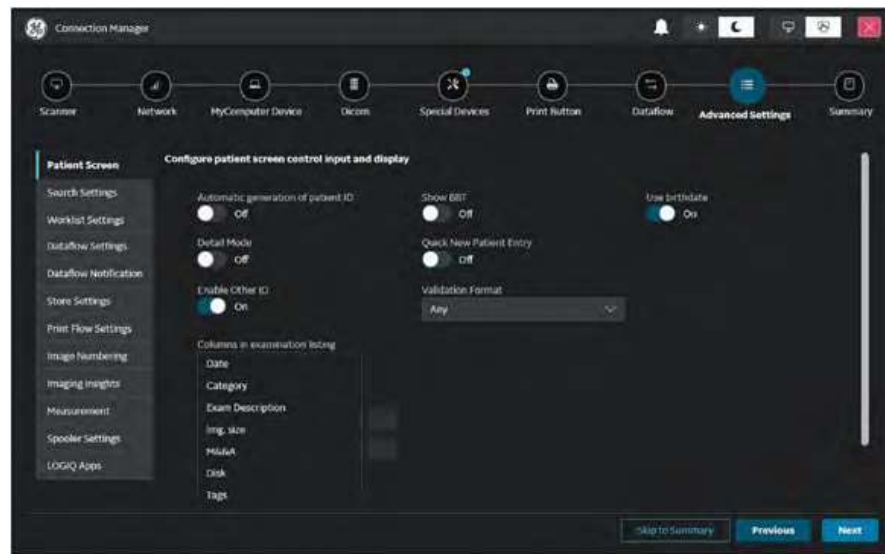

Figure 10-63. Advanced Settings - Patient Screen

This table shows all the preset parameters available on Advanced Settings - Patient Screen with descriptions.

Table 10-126:

Preset Parameter	Description
Automatic generation of patient ID	In the Search/Create Patient window: When selected, the Patient ID is not required when entering a new patient in the archive. The system automatically generates an ID number. When cleared, the Patient ID is required when entering a new patient in the archive. On = Enabled/Off - Disabled
Show BBT	Show BBT field on the OB patient screen to input the basal body temperature. On = Enabled/Off - Disabled
Use birthdate	In the Patient information window, enter either the patient age or the birth date: When selected, enter birth date, then the age is calculated. When cleared, enter age (birth date field not available). On = Enabled/Off - Disabled
Detail Mode	Select to display Detail Mode, rather than Exam View, when you select the patient name in the patient list on the Patient menu. You can also type comments while in Detail Mode. On = Enabled/Off - Disabled
Quick New Patient Entry	Select to store new patient automatically by pressing the Patient key. On = Enabled/Off - Disabled

Table 10-126:

Preset Parameter	Description
Enable Other ID	Not selected is the Default. If selected, allow entering Other ID, such as Citizen Service Number, Burger Service Number (BSN), National Health System (NHS) number, along with patient ID information on the Patient Screen. On = Enabled/Off - Disabled
Validation Format	If the Enable Other ID preset is selected, the system validates the format of "Other ID" when an ID is entered. Choose: NHS Number *** ** *****, Letters and Numbers, Numbers, or Any (no restriction).
Columns in examination listing	Create new columns, remove columns, and select the information to display in a column. Use the arrows (<< or >>) to reposition column headings.

### Configure Patient Screen

1. Navigate to **Connectivity > Connection Manager > Advanced Settings**.
2. Select **Patient Screen**.
3. Configure the fields on the page.
4. Select **Next** to proceed to Search Settings.

Advanced Settings - Search Settings page

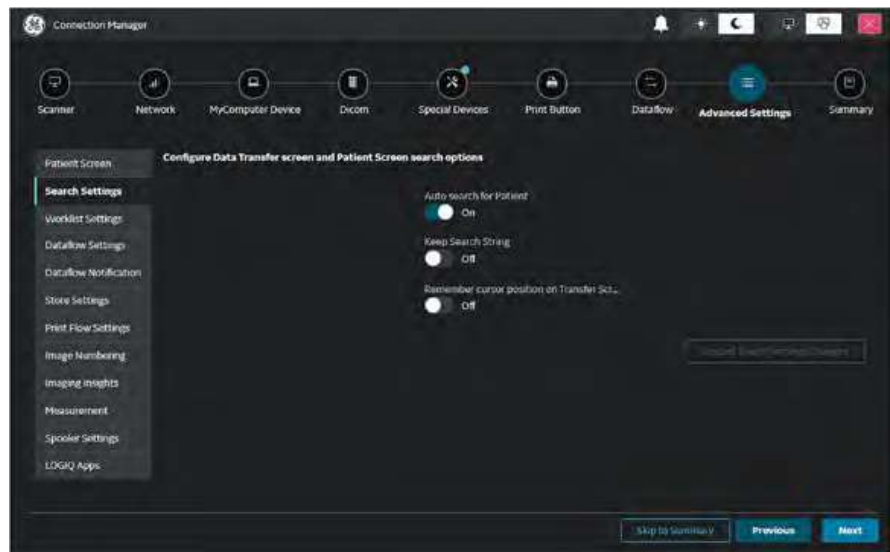

Figure 10-64. Advanced Settings - Search Settings

This table shows all the preset parameters available on Advanced Settings - Search Settings with descriptions.

Table 10-127: Advanced Settings - Search Settings

Preset Parameter	Description
Auto search for Patient	In the Search/Create Patient window: When selected, the system automatically searches through the selected patient archive, while the user enters patient information. When cleared, the automatic search tool is turned off. If you are trying to keep the past patient data confidential, DO NOT use this feature. On = Enabled/Off - Disabled
Keep Search String	Search string is kept rather than cleared. On = Enabled/Off - Disabled
Remember cursor position on Transfer Screen	Enable to set a default cursor location on the Data Transfer screen. On = Enabled/Off - Disabled

**Configure Search Settings**

1. Navigate to **Connectivity > Connection Manager > Advanced Settings**.
2. Select **Search Settings**.
3. Configure the fields on the page.
4. Select **Next** to proceed to Worklist Settings.

## Advanced Settings - Worklist Settings page

Use Scanner Network Properties - General to configure the protocol setting.

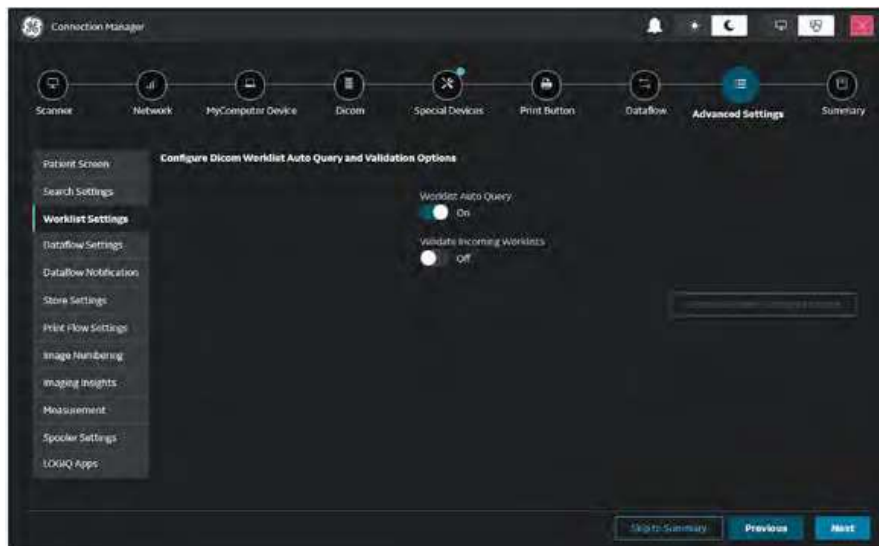

Figure 10-65. Advanced Settings - Worklist Settings

This table shows all the preset parameters available on Advanced Settings - Worklist Settings with descriptions.

Table 10-128: Advanced Settings - Worklist Settings

Preset Parameter	Description
Worklist Auto Query	Automatically queries the worklist server. On = Enabled/Off - Disabled
Validate Incoming Worklists	Confirm incoming Worklists are valid. On = Enabled/Off - Disabled

### Configure Worklist Settings

1. Navigate to **Connectivity > Connection Manager > Advanced Settings**.
2. Select **Worklist Settings**.
3. Configure the fields on the page.
4. Select **Next** to proceed to Dataflow Settings.

### Advanced Settings - Dataflow Settings page

Use Scanner Network Properties - General to configure the protocol setting.

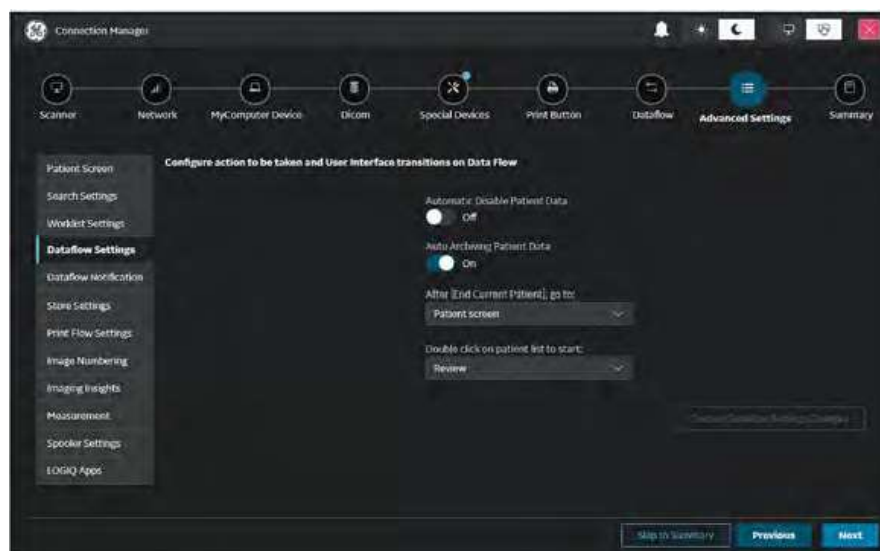

Figure 10-66. Advanced Settings - Dataflow Settings

This table shows all the preset parameters available on Advanced Settings - Dataflow Settings page with descriptions.

Table 10-129: Advanced Settings - Dataflow Settings

Preset Parameter	Description
Automatic Disable Patient Data	Select to automatically disable patient data. If selected, locks the patient name, date of birth and gender (like Patient ID). The Factory Default for this preset is unchecked. On = Enabled/Off - Disabled
Auto Archiving Patient Data	Archives patient data automatically. On = Enabled/Off - Disabled
After [End Current Patient], go to:	Select Worklist screen or Patient screen.
Double click on patient list to start	Select Review or New Exam to display each time you double click on the patient name in the patient list on the Patient menu.

#### Configure Dataflow Settings

1. Navigate to **Connectivity > Connection Manager > Advanced Settings**.
2. Select **Dataflow Settings**.
3. Configure the fields on the page.
4. Select **Next** to proceed to Dataflow Notification.



## Advanced Settings - Dataflow Notification page

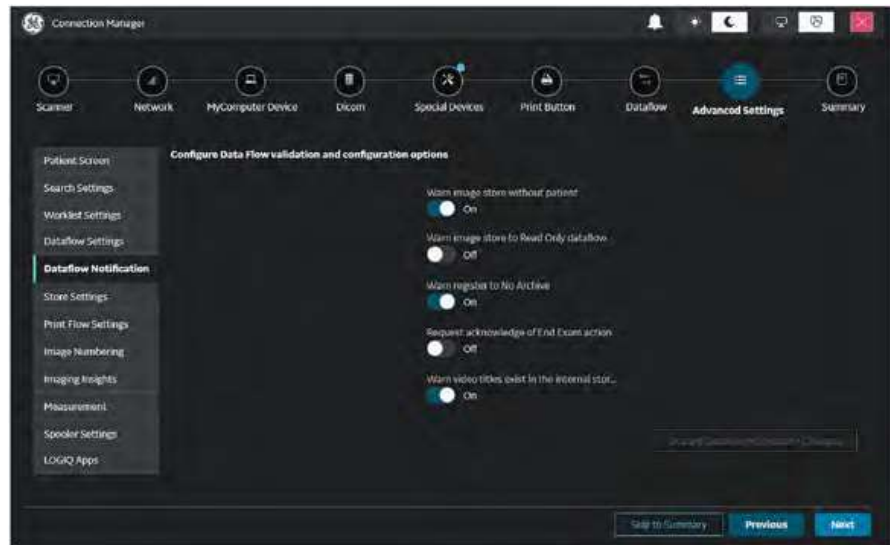

Figure 10-67. Advanced Settings - Dataflow Notification

This table shows all the preset parameters available on Advanced Settings - Dataflow Notification with descriptions.

Table 10-130: Advanced Settings - Dataflow Notification

Preset Parameter	Description
Warn image store without patient	Select to receive a warning when you press the Print key without an active patient. On = Enabled/Off - Disabled
Warn image store to Read Only dataflow	The system posts a warning message if you attempt to store images to a read-only Dataflow. On = Enabled/Off - Disabled
Warn register to No Archive	Select to receive a warning when you register a patient to the “No Archive” data flow. Select a different data flow for permanent storage of patient data. On = Enabled/Off - Disabled
Request acknowledge of End Exam action	When selected, the user is asked to confirm action when ending an examination. On = Enabled/Off - Disabled
Warn video titles exist in the internal storage	The system posts a warning if the video titles exist on the internal DVR flash memory. On = Enabled/Off - Disabled

### Configure Dataflow Notification

1. Navigate to **Connectivity > Connection Manager > Advanced Settings**.
2. Select **Dataflow Notification**.
3. Configure the fields on the page.
4. Select **Next** to proceed to Transfer Settings.

Advanced Settings - Transfer Settings page

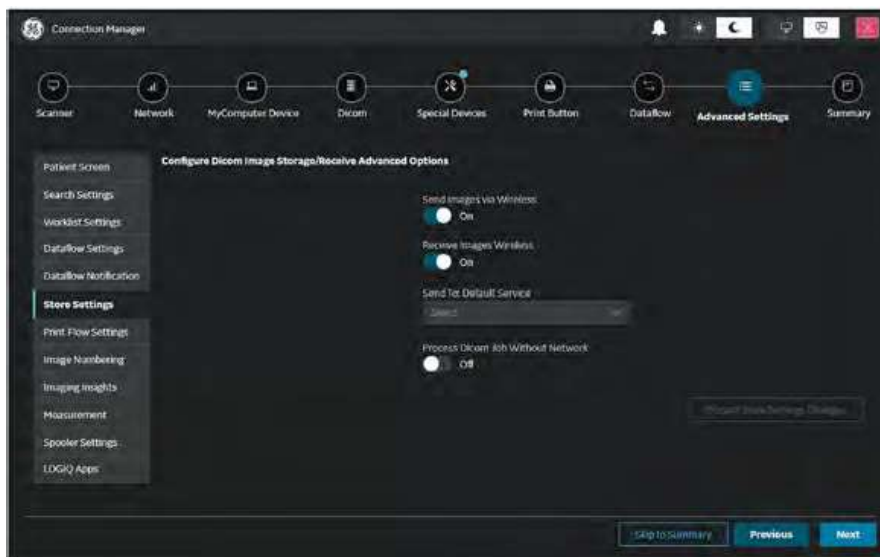

Figure 10-68. Advanced Settings - Transfer Settings

This table shows all the preset parameters available on Advanced Settings - Transfer Settings with descriptions.

Table 10-131: Advanced Settings - Transfer Settings

Preset Parameter	Description
Send Images via Wireless	When enabled and connected to the network through a wireless LAN, images will be sent to the DICOM device over the wireless LAN. If disabled, images spooled in the Spooler will be sent when the Ultrasound system is connected to the wired network. On = Enabled/Off - Disabled
Receive Images Wireless	When enabled and connected to the network through a wireless LAN, images will be received from the DICOM device over the wireless LAN. If disabled, images will be received when the Ultrasound system is connected to the wired network. On = Enabled/Off - Disabled
Send To: Default Service	Select default Send To service from the dropdown list.
Process Dicom Job Without Network	When enabled, preset that allows communication between the Ultrasound system and the Koios Server VM (installed in the Ultrasound system) even when there is no network. On = Enabled/Off - Disabled

### Configure Transfer Settings

1. Navigate to **Connectivity > Connection Manager > Advanced Settings**.
2. Select **Transfer Settings**.
3. Configure the fields on the page.
4. Select **Next** to proceed to Print Button Settings.

## Advanced Settings - Print Button Settings page

Use Scanner Network Properties - General to configure the protocol setting.

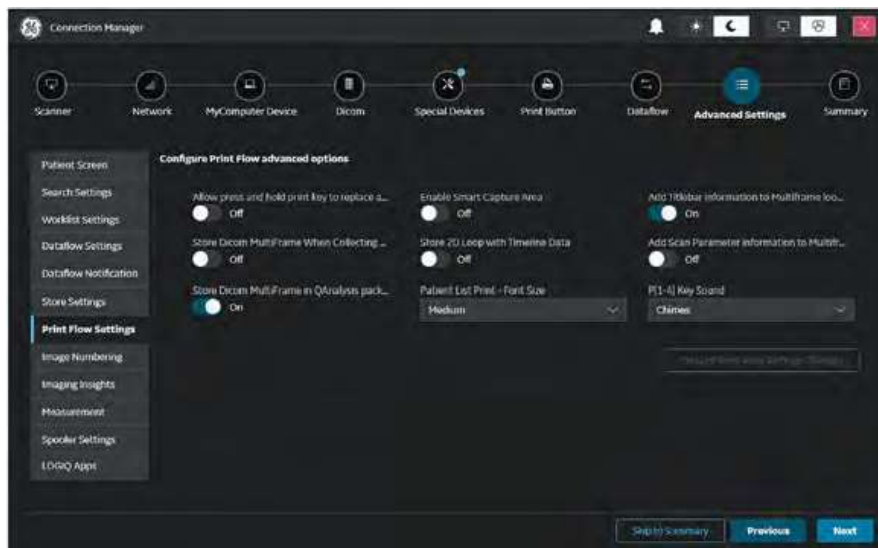

Figure 10-69. Advanced Settings - Print Button Settings

This table shows all the preset parameters available on Advanced Settings - Print Button Settings with descriptions.

Table 10-132: Advanced Settings - Print Button Settings

Preset Parameter	Description
Allow press and hold print key to replace an image	Select to enable pressing and holding print key to replace an image. On = Enabled/Off - Disabled
Enable Smart Capture Area	Check box to select. On = Enabled/Off - Disabled
Add Titlebar information to Multiframe loops	Adds a title bar to the DICOM image. On = Enabled/Off - Disabled
Store Dicom MultiFrame When Collecting RF Data	Select to store DICOM multiFrame images when collecting RF Data. On = Enabled/Off - Disabled
Store 2D Loop with Timeline Data	Check box to select. On = Enabled/Off - Disabled
Add Scan Parameter information to Multiframe Loops	Adds scan parameter(s) to the DICOM image. On = Enabled/Off - Disabled
Store Dicom MultiFrame in QAnalysis pack	Select to store DICOM MultiFrame images in Quantitative Analysis mode. Selected by default. On = Enabled/Off - Disabled

Table 10-132: Advanced Settings - Print Button Settings

Preset Parameter	Description
Patient List Print - Font Size	Select font size.
P[1-4] Key Sound	Select None, Click, Chimes, Ding, Ding-Dong, or Whoosh.

### Configure Print Button Settings

1. Navigate to **Connectivity > Connection Manager > Advanced Settings**.
2. Select **Print Button Settings**.
3. Configure the fields on the page.
4. Select **Next** to proceed to Image Numbering.

## Advanced Settings - Image Numbering page

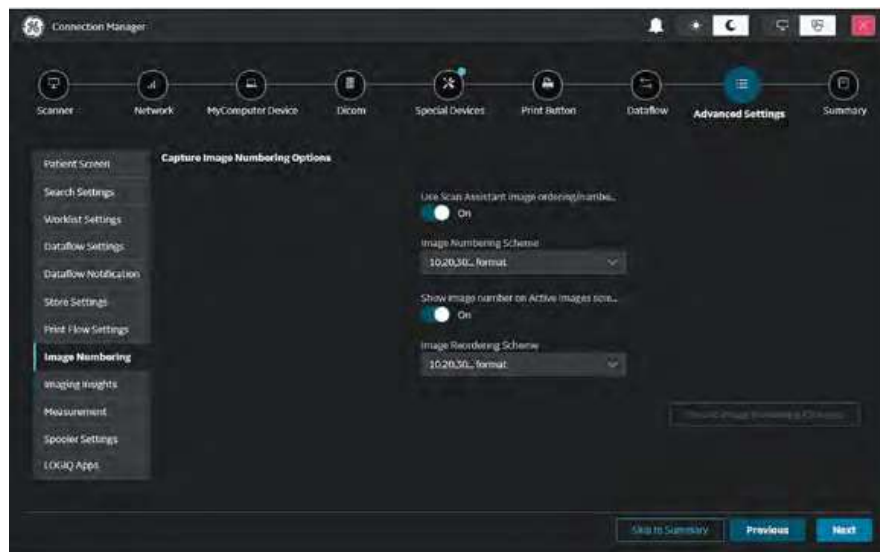

Figure 10-70. Advanced Settings - Image Numbering

This table shows all the preset parameters available on Advanced Settings - Image Numbering with descriptions.

Table 10-133: Advanced Settings - Image Numbering

Preset Parameter	Description
Use Scan Assistant image ordering/numbering	When enabled, uses Scan Assistant image reordering/renumbering. On = Enabled/Off - Disabled
Image Numbering Scheme	Preset that defines how the images are numbered during the examination/scanning process.
Show image number on Active Images screen	When enabled, shows the image number on the Active Images screen. On = Enabled/Off - Disabled
Image Reordering Scheme	Preset that defines how the images are numbered during image reorder operation.

### Configure Image Numbering

1. Navigate to **Connectivity > Connection Manager > Advanced Settings**.
2. Select **Image Numbering**.
3. Configure the fields on the page.
4. Select **Next** to proceed to Imaging Insights.

Advanced Settings - Imaging Insights page

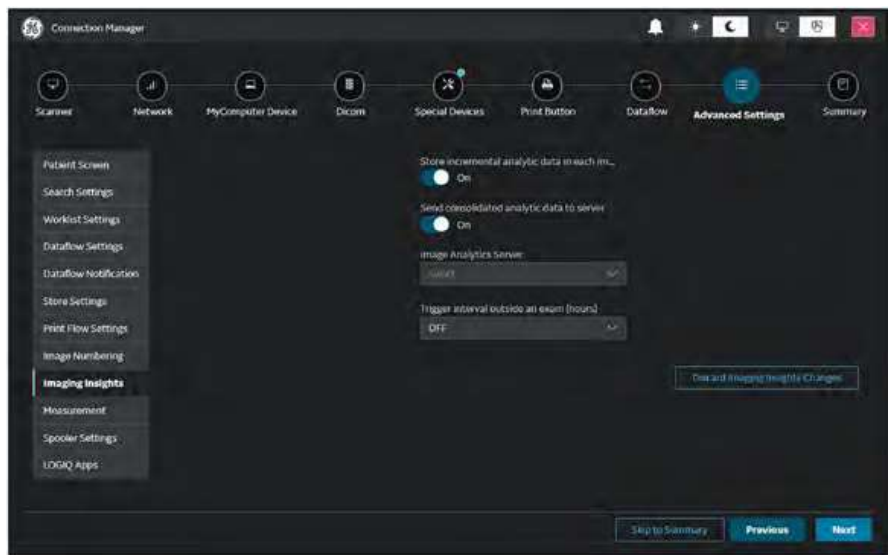

Figure 10-71. Advanced Settings - Imaging Insights

This table shows all the preset parameters available on Advanced Settings - Imaging Insights with descriptions.

Table 10-134: Advanced Settings - Imaging Insights

Preset Parameter	Description
Store incremental analytic data in each image	Select to store incremental data in each image. On = Enabled/Off - Disabled
Send consolidated analytic data to server	Select to send consolidated analytic data to server. On = Enabled/Off - Disabled
Image Analytics Server	Select server from dropdown list.
Trigger interval outside an exam (hours)	Off, 1, 2, 3, 5

**Configure Imaging Insights**

1. Navigate to **Connectivity > Connection Manager > Advanced Settings**.
2. Select **Imaging Insights**.
3. Configure the fields on the page.
4. Select **Next** to proceed to Measurement.



## Advanced Settings - Measurement page

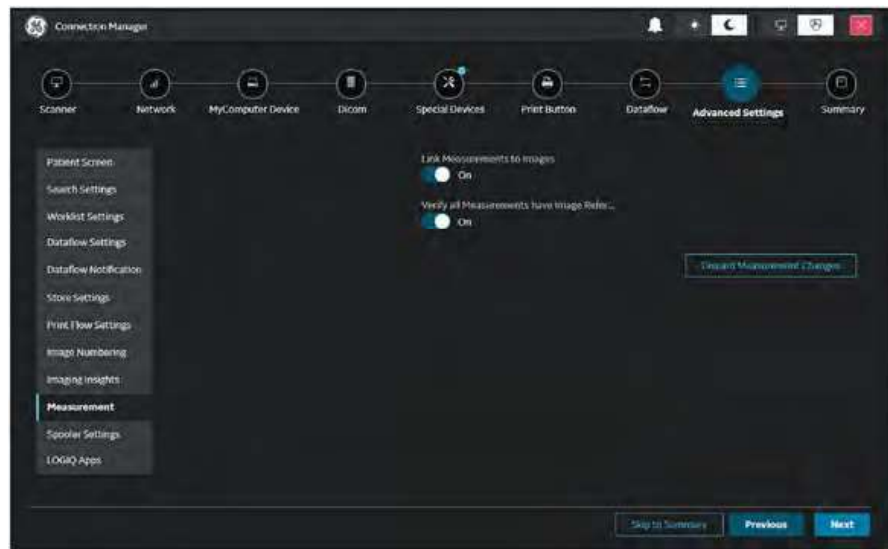

Figure 10-72. Advanced Settings - Measurement

This table shows all the preset parameters available on Advanced Settings - Measurement with descriptions.

Table 10-135: Advanced Settings - Measurement

Preset Parameter	Description
Link Measurement to Images	Links measurements to images when sent to PACS. On = Enabled/Off - Disabled
Verify all Measurements have Image References	Verifies that all measurements have image references when sent to PACS. On = Enabled/Off - Disabled

### Configure Measurement

1. Navigate to **Connectivity > Connection Manager > Advanced Settings**.
2. Select **Measurement**.
3. Configure the fields on the page.
4. Select **Next** to proceed to Spooler Settings .

Advanced Settings - Spooler Settings page

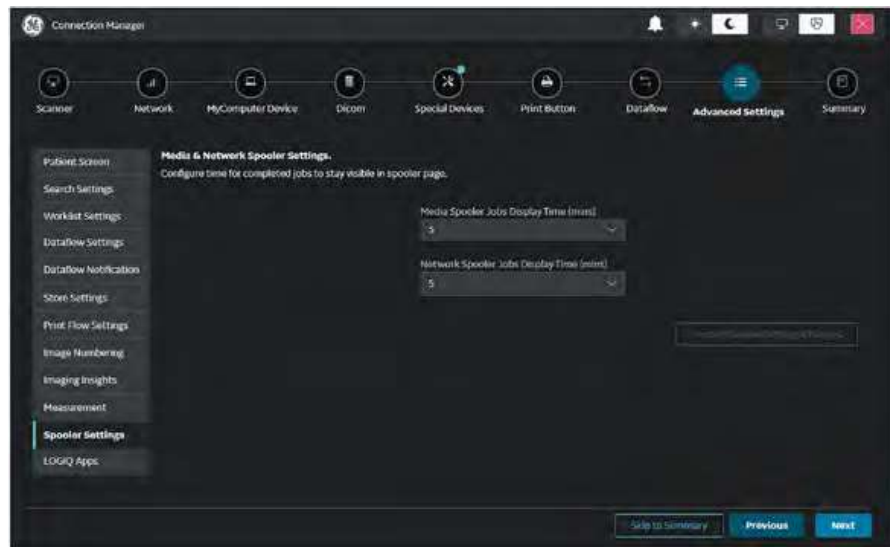

Figure 10-73. Advanced Settings - Spooler Settings

This table shows all the preset parameters available on Advanced Settings - Spooler Settings with descriptions.

Table 10-136: Advanced Settings - Spooler Settings

Preset Parameter	Description
Media Spooler Jobs Display Time (mins)	Number of minutes completed jobs will display in the media spooler.
Network Spooler Jobs Display Time (mins)	Number of minutes completed jobs will display in the network spooler.

**Configure Spooler Settings**

1. Navigate to **Connectivity > Connection Manager > Advanced Settings**.
2. Select **Spooler Settings**.
3. Configure the fields on the page.
4. Select **Next** to proceed to LOGIQ Apps.

Advanced Settings - LOGIQ Apps page

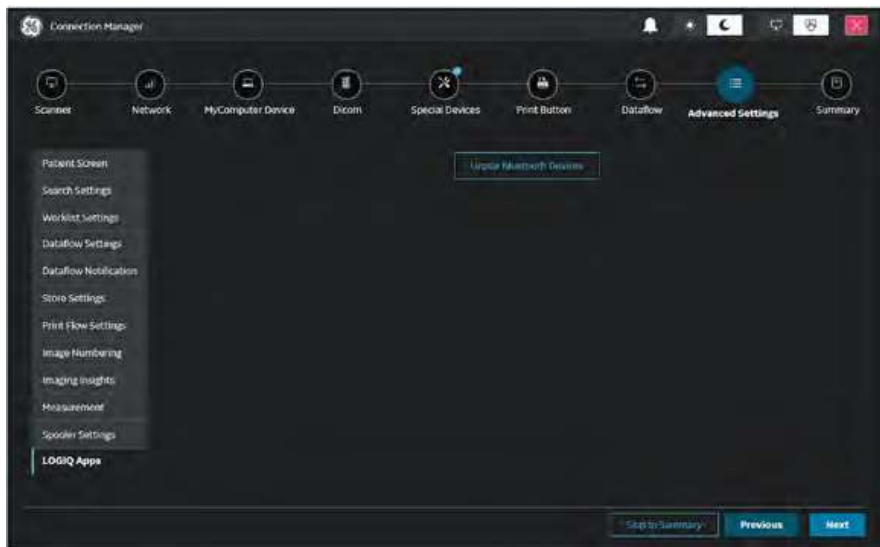

Figure 10-74.

This table shows all the preset parameters available on Advanced Settings - LOGIQ Apps with descriptions.

Table 10-137: Advanced Settings - LOGIQ Apps

Preset Parameter	Description
Unpair Bluetooth Devices	Select to unpair the LOGIQ Apps device.

Configure LOGIQ Apps

1. Navigate to **Connectivity > Connection Manager > Advanced Settings**.
2. Select **LOGIQ Apps**.
3. Configure the fields on the page.
4. Select **Next** to proceed to Summary.

### Connection Manager Summary Page

The Summary page lists the status of the wired or wireless connectivity and proxies configured on the left and Dicom Devices and Services on the right



Figure 10-75. Summary Page

Device status is noted with different colors:

- Green - Device and all services are available
- Red - Device is offline, or all the services are offline
- Orange - Device is available. However, one more of its services are offline
- Gray - Device has no service or service status is being updated

Navigate to configure connectivity functions by clicking the icons at the top of the screen to access the desired configuration screen, or by selecting Next or Previous at the bottom of the screen.

# Measure

Please refer to Chapter 7, General Measurements and Calculations for more information on setting up Measurement and Analysis Presets.

# Reports

Refer to Chapter 13 for more information.

# System Administration

## Overview

The Admin screen has the following sections:

- **System Administration** – lists all the options implemented in the system.
- **Users** – allows you to define user IDs, specify operator's registration, operator's rights, registration of staff related to an examination (for example, referral doctors and sonographers) and password update requirements.
- **Logon** – defines logon procedures, allows the System Administrator to set password policies, and LDAP Configuration.
- **Groups** – The System Administrator can set up user groups on this page.
- **System Password** – Password for the Application Windows Logon Account.
- **Disk Encryption** -- The System Administrator can encrypt the disk for highest system security, if required.
- **Audit Report** – Generates an audit report.
- **Vulnerability Scan Mode** – Part of the Advanced Security Option. Vulnerability Scan Mode configures the system so that an external scanner can analyze the LOGIQ Totus.

*NOTE: Only the System Administrator can access the pages.*

### Administrator Tasks

Here are the tasks typically performed by the LOGIQ Totus System Administrator. Instructions for each of these tasks can be found in this chapter.

- Privacy and Security Configuration options
- Define connection options for LDAP Directory Server
- Control encryption of the Patient Data drive
- Create Users/Groups
- Change rights for Users/Groups
- Change Encryption status for the system
- Change/Add Encryption Passwords
- Save/Print Recovery keys for encrypted drives
- Configure Password Policies
- Configure Session Policies
- Vulnerability Scan Mode
- Generate Audit Reports
- Configure Remote Logging Servers

### Privacy and Security

Privacy protects both personal and private interests and information of persons. Security protects both system and information from risks to confidentiality, integrity, and availability. The LOGIQ Totus Privacy and Security capabilities are discussed in Chapter 12; Privacy and Security configuration is discussed below, followed by a description of each system administrative page.



## Creating Password Policies and User Groups

The foundation of setting up effective privacy and security is controlling user groups, users, and their system permissions.

### Enabling Password Policies

Check the “Enable Password Policies” box on the Utility-> Admin-> LOGON page.

In addition, set the password policy for each selection. These policies should be set **BEFORE** creating new users. Save the changes and reboot the system. This applies rules for the passwords.



HINTS

Ensure the ADM password is known **BEFORE** rebooting the system.

Policies	
Enable Password Policies	<input type="checkbox"/>
Enable Session Timeout (Lock Screen)	<input checked="" type="checkbox"/>
Enable Session Timeout (Automatic Logoff)	<input type="checkbox"/>
User Name Policies	
Display Login User List	<input type="checkbox"/>
Password Policies	
Password cannot contain username	<input checked="" type="checkbox"/>
Minimum Password Length	8
Minimum Number Of Character Sets	4
Minimum Number Of Upper Case Letters	1
Minimum Number Of Lower Case Letters	1
Minimum Number Of Digits	1
Minimum Number Of Symbols (!#\$% etc.)	1
Minimum Password Age (hours)	1
Maximum Password Age (days)	365
Password Reuse History Count	10
Failed Logins Before Account Blocked	3
Account Block Time (min)	9
Session Lock Screen Timeout (min)	30
Session Auto Logoff Timeout (min)	60

Figure 10-76. Enable Password Policies

## Groups

You define Group access rights via the Utility-> Admin-> Groups page. When each user logs in, they will have access to the system according to the rights assigned to their group(s). Default system groups are preset with pre-determined access rights. To view these access rights, highlight a group name in the Group List column on the left, then look in the Groups Rights column to see the permissions by group.



HINTS

Admin has full access rights.

Name and Description		Factory Defaults					
Id	Description	SysAdmin	BioMed	Lead Sonographer	Sonographer	Physician	Emergency User
BioMed	Facility BioMed	<input checked="" type="checkbox"/>	<input checked="" type="checkbox"/>	<input checked="" type="checkbox"/>	<input checked="" type="checkbox"/>	<input checked="" type="checkbox"/>	<input checked="" type="checkbox"/>
<b>Group Rights</b>							
Login		<input checked="" type="checkbox"/>	<input checked="" type="checkbox"/>	<input checked="" type="checkbox"/>	<input checked="" type="checkbox"/>	<input checked="" type="checkbox"/>	<input checked="" type="checkbox"/>
Admin		<input checked="" type="checkbox"/>	<input checked="" type="checkbox"/>	<input checked="" type="checkbox"/>	<input checked="" type="checkbox"/>	<input checked="" type="checkbox"/>	<input checked="" type="checkbox"/>
Create Patient Data		<input checked="" type="checkbox"/>	<input checked="" type="checkbox"/>	<input checked="" type="checkbox"/>	<input checked="" type="checkbox"/>	<input checked="" type="checkbox"/>	<input checked="" type="checkbox"/>
Update Patient Data		<input checked="" type="checkbox"/>	<input checked="" type="checkbox"/>	<input checked="" type="checkbox"/>	<input checked="" type="checkbox"/>	<input checked="" type="checkbox"/>	<input checked="" type="checkbox"/>
Delete Patient Data		<input checked="" type="checkbox"/>	<input checked="" type="checkbox"/>	<input checked="" type="checkbox"/>	<input checked="" type="checkbox"/>	<input checked="" type="checkbox"/>	<input checked="" type="checkbox"/>
Transfer Patient Data		<input checked="" type="checkbox"/>	<input checked="" type="checkbox"/>	<input checked="" type="checkbox"/>	<input checked="" type="checkbox"/>	<input checked="" type="checkbox"/>	<input checked="" type="checkbox"/>
Export Patient Data		<input checked="" type="checkbox"/>	<input checked="" type="checkbox"/>	<input checked="" type="checkbox"/>	<input checked="" type="checkbox"/>	<input checked="" type="checkbox"/>	<input checked="" type="checkbox"/>
Import Patient Data		<input checked="" type="checkbox"/>	<input checked="" type="checkbox"/>	<input checked="" type="checkbox"/>	<input checked="" type="checkbox"/>	<input checked="" type="checkbox"/>	<input checked="" type="checkbox"/>
Basic Configuration		<input checked="" type="checkbox"/>	<input checked="" type="checkbox"/>	<input checked="" type="checkbox"/>	<input checked="" type="checkbox"/>	<input checked="" type="checkbox"/>	<input checked="" type="checkbox"/>
Imaging Configuration		<input checked="" type="checkbox"/>	<input checked="" type="checkbox"/>	<input checked="" type="checkbox"/>	<input checked="" type="checkbox"/>	<input checked="" type="checkbox"/>	<input checked="" type="checkbox"/>
Advanced Configuration		<input checked="" type="checkbox"/>	<input checked="" type="checkbox"/>	<input checked="" type="checkbox"/>	<input checked="" type="checkbox"/>	<input checked="" type="checkbox"/>	<input checked="" type="checkbox"/>
Authorize Remote Service Access		<input checked="" type="checkbox"/>	<input checked="" type="checkbox"/>	<input checked="" type="checkbox"/>	<input checked="" type="checkbox"/>	<input checked="" type="checkbox"/>	<input checked="" type="checkbox"/>
Capture Logs		<input checked="" type="checkbox"/>	<input checked="" type="checkbox"/>	<input checked="" type="checkbox"/>	<input checked="" type="checkbox"/>	<input checked="" type="checkbox"/>	<input checked="" type="checkbox"/>
Capture Logs with PHI		<input checked="" type="checkbox"/>	<input checked="" type="checkbox"/>	<input checked="" type="checkbox"/>	<input checked="" type="checkbox"/>	<input checked="" type="checkbox"/>	<input checked="" type="checkbox"/>
Access Service Desktop		<input checked="" type="checkbox"/>	<input checked="" type="checkbox"/>	<input checked="" type="checkbox"/>	<input checked="" type="checkbox"/>	<input checked="" type="checkbox"/>	<input checked="" type="checkbox"/>

Figure 10-77. Groups Page

## Adding users

You define Group access rights via the Utility-> Admin-> Users page.

Figure 10-78. Page to Add Users

## Creating a user

1. Press **Add**.
2. Type the user ID.



### HINTS

ENSURE that you DO NOT include the following characters in a user's ID: slash (/), dash (-), asterisk (\*), question mark (?), an underscore (\_), ampersand (&), or blank spaces.

3. Type the user's information in the Identity section, ensuring that you are using the defined policies. User IDs are enforced as all uppercase letters for local users.

### NOTE:

*If a password is created, the user will be required to enter the password when logging on, even if Password Policies is not enabled. Remember, passwords are case-sensitive.*

4. Select the user's group(s). Multiple groups can be selected, if needed.

### Creating a user (continued)

5. If the user needs full configuration and advanced operations access, select **Admin**.
6. Press **Save**.

*NOTE: DO NOT add users with the same User ID. The system allows you to do this; however, the first user is erased and only the second user remains.*

*NOTE: When adding a new user, press Add first. Then edit the ID from the default of "NewUser" and edit the other fields. **DO NOT** press Add again unless you actually want to create another user. Press Save after adding one or more users. The user listed as NewUser on the list will be updated with the edited ID when you re-enter this screen.*

### User Login

After the system administrator adds a new user, the new user should login with their new user name and password. If designated by the system administrator, they may be required to change their password.

The user will be prompted for their password when logging into the system or when selecting their user name from the Patient menu as well.

After logging in, the user will have access according to the rights available to them within their assigned group(s).

### Changing a user configuration

The system administrator can update a user. The system administrator can also specify whether the user's account is "Active," "Blocked," or requires a password change. If needed, select the check box, "User must change password." Then the user will be prompted to change their password the next time they log into the LOGIQ Totus.

1. Move the **Trackball** to a user ID in the User List.
2. Make the desired changes.

## Deleting a user

The system administrator can delete a user.

1. Move the **Trackball** to a user ID in the User List.
2. Select **Remove**. This marks the account as inactive.  
The user is removed from the User List.
3. Select Remove again.

**NOTE:** *Accounts are not removed immediately because User data is retained for auditing purposes. This can be useful because their name will still appear in audit reports. Also, they can be reactivated.*

If you permanently remove the user, by selecting "Remove" on an inactive user, this traceability will be lost.

## User Accounts and Password Policies Frequently Asked Questions

Here are answers to some frequently-asked questions:

**Q** I lost or forgot my password.

**A** System Admin can change your password.

**Q** I entered the wrong password multiple times and now the system says I am locked out.

**A** Wait until you are unlocked, enter the correct password. If you have forgotten your password, the System Admin can access the system and user details. Utility>Admin>Users

**Q** I am locked out after multiple attempts to remember my password, does the System Admin have to wait until my account is unlocked before accessing the system?

**A** The System Admin can logon with their own logon information before the users blocked time is over. The box "Block user account" Utility>Admin>User, should be unchecked to allow the user to logon.

**Q** I have created a list of users on one u/s system, I have three more in the department, can I do a backup to disk and restore the user list onto the other systems?

**A** Yes, you can copy both User and Password.

## **User Accounts and Password Policies Frequently Asked Questions**

**(continued)**

**Q** I have a sonographer who left the facility, how do I delete this user?

**A** The System Admin can deactivate or delete a user. Utility>Admin>Logon. Select the user and press “remove”

**Q** I have a sonographer who is on medical leave for a few weeks. I do not want to remove their user logon but I want to make sure they cannot access the system while not working.

**A** The System Admin can block a user account. Utility>Admin>Logon, select the user and check “Block user account,” or deselect “active user account.”

**Q** We have information that a weekend users password may have been compromised, I need to ask the user to change their password the next time they logon.

**A** The System Admin can require the user to change their password. Utility>Admin>Logon, select the user and check “Require password change”

**Q** I have created a new user for a new sonographer, how do I assign the correct group?

**A** When a new user is added to the list, the groups list is located on the right column of the screen. Assign the user to a group or multiple groups with the appropriate access rights.

**Q** Can I change the access rights for a pre-defined group?

**A** Currently this is not supported. You can select multiple groups from the factory default list for any user that needs additional access but not full admin rights; or create your own groups with desired rights.

**Q** The default “ADM” user account does not have a password, can I create a password for this account?

**A** Yes, you can create a password for the default ADM. Be sure to write this down for anyone who will need access to the system, such as GE HealthCare Service.

## User Accounts and Password Policies Frequently Asked Questions (continued)

**Q** I was the last user on the system, the screen has gone black, do I need to logon again?

**A** Yes, once the Screen Lock time has been reached touch any button or the trackball on the operator panel to display the logon screen. Logon with your current credentials.

**Q** Can I use the Auto Logon feature?

**A** Yes, the Auto logon if checked will logon with the last user if the “Use password policies” is unchecked and the user has blank password. If the user is not assigned a password they will be logged on with no other entry required. If the user is assigned a password the logon window will pop-up requiring the password to be entered.

### Locking the Screen and Logon

You define Automatically Lock Screen via the Utility-> Admin-> Logon page by checking the Enable Session Timeout (Lock Screen) box. Then go to the bottom of the column to designate after how many minutes the screen should be locked (Session Lock Screen Timeout (min)).

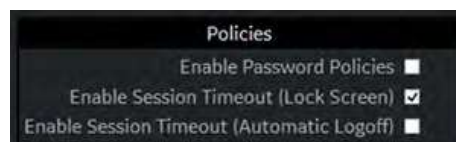

Figure 10-79. Enable Lock Screen

The screen will lock after the designated time. During this time, the system will be completely black. To reactivate the system, the user will need to logon again.

**NOTE:** *If “use password policies” is unchecked and no password is set to the user, and when Auto Logon is checked, the system will start by using the ID of the last operator. If Admin is used as the operator, assure that all characters are removed from the password field.*

To lock the screen,

- Type [Alt+L].

## System Admin

The System Admin screen has information about any options implemented for the system.

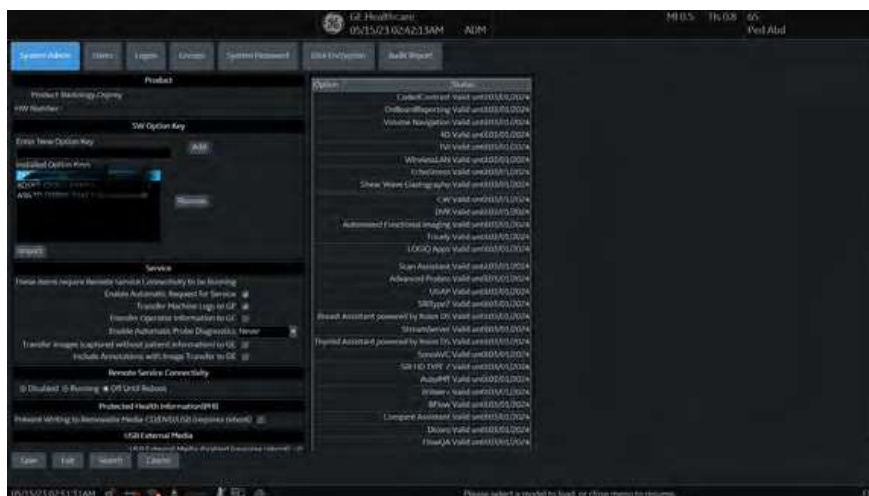

Figure 10-80. Administrative System Admin Preset Menu

Table 10-138: Product

Preset Parameter	Description
Product	The name of the product.
HW Number	The hardware number of the product.

Table 10-139: Software Option Key

Preset Parameter	Description
Enter New Option Key	Type the key for the option you wish to add and press Add. <i>Note: The Option Key may contain alphanumeric characters (2-9, A-H, J-N, P-Z) and special characters ("?", "%" and "&amp;").</i>
Installed Option Keys	Lists the key for the installed options.
Add	Press to add a software option key.
Remove	To remove a software option key, select the key in the SW Option Key list, and then select Remove.
Import	Used to import option strings stored on media (USB) or in the system (OptionKeys.txt may be stored at d:\service). When you press Import, a dialog box comes up that allows you to select from the following locations: USB drive and d:\service.



Table 10-140: Service

Preset Parameter	Description
Enable Automatic Request for Service	Check this box to enable the system to send system-generated requests for service, without your intervention.
Transfer Machine Logs to GE HealthCare	Allows transfer of monitoring errors and status logs to GE HealthCare back office for data analytics.
Transfer Operator Information to GE HealthCare	Allows transfer of operator information to GE HealthCare back office for usage analytics.
Enable Automatic Probe Diagnostics	Enable Automatic Probe Diagnostics to run and save data to log file for transfer to GE HealthCare backoffice for analysis.
Transfer Images (captured without patient information) to GE HealthCare	Allows transfer of images for analysis.
Include Annotation with Image transfer to GE HealthCare	Usage Analysis: Allows transfer of operator information to GE HealthCare back office for usage analytics.

If your site decides to deactivate the InSite ExC Agent, then Remote Connectivity is no longer available on the LOGIQ Totus. This also means that Remote Service can no longer connect to the LOGIQ Totus via Disruptive Mode to diagnose system issues. and the “Service” section will be removed from this Utility page. In addition, you will not be able to initiate a Request for Service or Clinical Support Request via the “GE HealthCare InSite ExC” icon control located at the bottom of the Monitor Display.

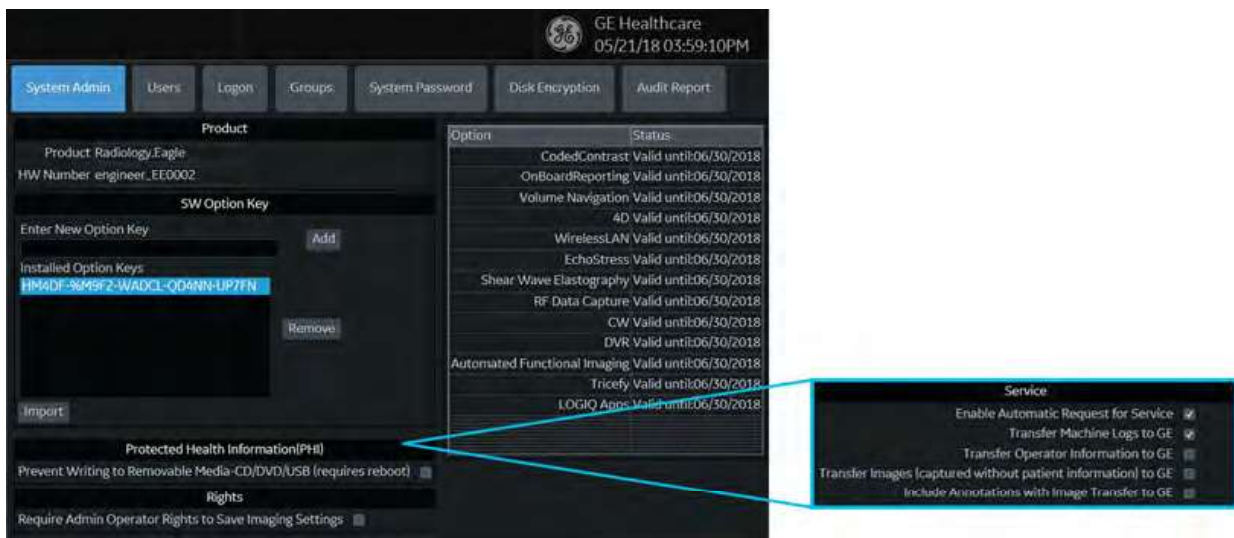

Figure 10-81. Remote Connectivity Deactivated; Service Fields Removed

Table 10-141: Protecting Health Information (PHI)

Preset Parameter	Description
Prevent Writing to Removable Media USB (requires reboot)	Check this box to prevent users from copying/saving information to removable media.

Table 10-142: USB External Media

Preset Parameter	Description
USB External Media disabled (requires reboot) By Checking this box you will disconnect all external USB Mass Storage devices	Select to disable any USB media from connecting to the LOGIQ Totus. <b>Please remember to enable this feature to reload software or to install the eIFU USB Media.</b>

Table 10-143: Rights

Preset Parameter	Description
Require Admin Operator Rights to Save Imaging Settings	Check this box to require the User to have Administrative rights in order to save image settings.

Table 10-144: Option Status

Preset Parameter	Description
Options	A list of the option name and status.
Status	Lists each option's effectivity.

## Users

The Users screen allows you to define user IDs. It also allows you to specify operators registration, operator's rights setting, and registration of staff related to an examination (for example, referring and interpreting physicians).



Figure 10-82. Users Preset Menu

Table 10-145: User List

Preset Parameter	Description
User List	Lists the user ID for all system users.
Identity	Type the operator's user ID, Password, Prefix, Last Name, First Name, Middle Name, Suffix, Phone Number.
User Controls	The System Administrator can specify whether a user's account is active, blocked, or requires a password update.
Group Membership	Select the user's group: Operator (sonographers, doctors, or any person using the ultrasound system); Ref.Phys. (referring physician can be associated to the patient examination in the extended Patient information window); Perf.Phys. – physician performing the exam can be associated to the patient examination in the extended Patient information window. Note, other groups may exist as set up by the System Administrator.

## Logon

The Logon section defines log on procedures.

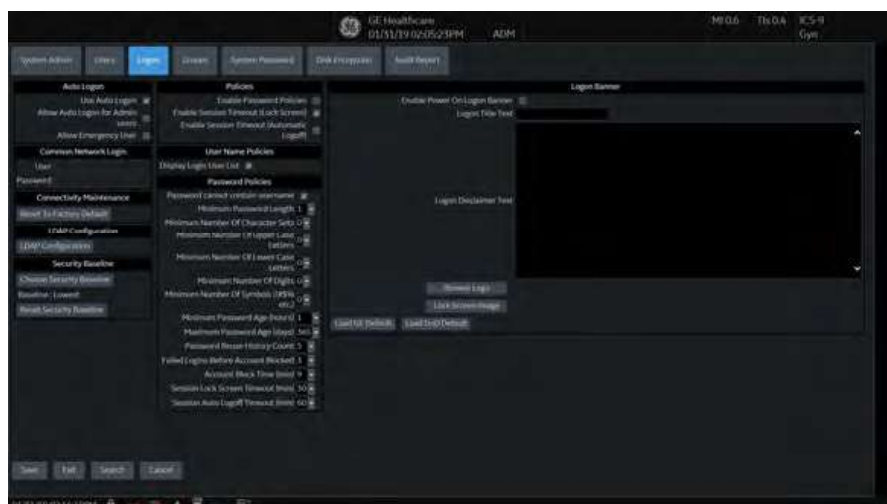

Figure 10-83. Administrative Logon Preset Menu

Table 10-146: Logon

Preset Parameter	Description
Auto Logon	<p>Specifies logon procedures:</p> <ul style="list-style-type: none"> <li>• Use Auto Logon <ul style="list-style-type: none"> <li>• When selected, the system is started automatically, using the last user logon.</li> <li>• When blank, the user must select a user ID and enter a password when logging on.</li> </ul> </li> </ul> <p>Note: Auto LOGON only works when password policies are disabled and if there is no password assigned to the user.</p> <ul style="list-style-type: none"> <li>• Allow Auto Logon for Admin users: The system is started automatically when logging in as an ADM user.</li> <li>• Allow Emergency User: The system will allow the EUSR user for emergency use.</li> </ul>
Common Network Login	<p>Specifies the user ID and password used to access the network.</p> <ul style="list-style-type: none"> <li>• User – User ID for network access</li> <li>• Password – Password for network access</li> </ul>
Connectivity Maintenance	Reset to factory default.
LDAP Configuration	Refer to the next section for LDAP instructions.

Table 10-146: Logon (Continued)

Preset Parameter	Description
Security Baseline	<p><b>Choose Security Baseline.</b> Select a baseline set of security policies for password and session management. For example:</p> <p><b>Lowest (default):</b> Autologon available. No password complexity rules.</p> <p><b>Medium:</b> Autologon unavailable. Passwords must meet the following criteria:</p> <ul style="list-style-type: none"> <li>• Minimum password length of 8.</li> <li>• Minimum of 2 character sets.</li> <li>• Password should not contain username.</li> <li>• Password should not be any of the last 10 passwords.</li> </ul> <p><b>High:</b> Autologon unavailable. Passwords must meet the following criteria:</p> <ul style="list-style-type: none"> <li>• Minimum password length of 10.</li> <li>• Minimum of 4 character sets.</li> <li>• Minimum of 1 lower case characters.</li> <li>• Minimum of 1 upper case characters.</li> <li>• Minimum of 1 special characters.</li> <li>• Minimum of 1 digits.</li> <li>• Password should not contain username.</li> <li>• Password should not be any of the last 15 passwords.</li> </ul> <p><b>Highest:</b> Autologon unavailable. Passwords must meet the following criteria:</p> <ul style="list-style-type: none"> <li>• Minimum password length of 14.</li> <li>• Minimum of 4 character sets.</li> <li>• Minimum of 1 lower case characters.</li> <li>• Minimum of 1 upper case characters.</li> <li>• Minimum of 1 special characters.</li> <li>• Minimum of 1 digits.</li> <li>• Password should not contain username.</li> <li>• Password should not be any of the last 25 passwords.</li> </ul> <p><b>Reset Security Baseline:</b> Clears the stored value for customer-selected security baseline. This forces the dialog which allows you to choose a baseline to be presented at the next Admin logon.</p>

Table 10-147: Policies

Preset Parameter	Description
Enable Password Policies	Specify whether to enable establishing policies for acceptable passwords, This specifies Password requirements such as # of letters, numbers, symbols, etc.
Enable Session Timeout (Lock Screen)	2-step logout: 1. System will display a lock screen after a set amount of time (configurable below under "session Lock Screen Timeout"). 2. System attempts to logout the user if "Automatic Logoff" is enabled and the timeout for it is reached or another user logs in instead.
Enable Session Timeout (Automatic Logoff)	This logs out a user automatically after a set amount of time.
Require Logon At Startup	Select to require logon with password at startup.

Table 10-148: User Name Policies

Preset Parameter	Description
Display Login User List	Check this box to display a list of Users.

Table 10-149: Password Policies

Preset Parameter	Description
Password cannot contain username	Password policy stating that the password cannot contain the user's name.
Minimum Password Length	Password policy for password minimum length.
Minimum Number of Character Sets	Password policy for minimum number of characters types (Upper-Case, Lower-Case, Digits, Symbols).
Minimum Number of Upper Case Letters	Password policy for minimum number of upper-case letters allowed (A, B, C, etc.)
Minimum Number of Lower Case Letters	Password policy for minimum allowed for number of lower-case letters (a, b, c, etc.)
Minimum Number of Digits	Password policy for minimum number of numbers (1, 2, 3, etc).
Minimum Number of Symbols (~#\$% etc.)	Password policy for minimum number of symbols allowed (#, @, etc.).
Minimum Password Age (hours)	Password policy for the minimum age for a password, in hours.
Maximum Password Age (days)	Password policy for the maximum age for a password, in days.
Minimum Changes Between Passwords	Password policy for the minimum number of changes between passwords.
Maximum Number Of Repeated Characters	Password policy for the maximum number of repeated password characters.
Maximum Number Of Sequential Characters	Password policy for the maximum number of sequential password characters.
Password Reuse History Count	Password policy -- users can't reuse old password -- # of old passwords it stores so you can't reuse it
Failed Logins Before Account Blocked	Password policy for the number of failed attempts to login that are allowed.
Do Not Allow Common Passwords	Select to disallow commonly used passwords.
Account Block Time (min)	There's a policy which will block an account for a certain amount of time after a certain number of failed logins -- you can set how long that time is
Session Lock Screen Timeout (min)	Password policy for the time, in minutes, before the system will lock the screen.

Table 10-149: Password Policies

Preset Parameter	Description
Session Auto Logoff Timeout (min)	Password policy for the time, in minutes, before the system will automatically log a user off the system.

## Logon Banner

The Power On Logon Banner displays the text at power-on and requires user confirmation to complete booting the system. This is user-configurable.

### Updating the Logon Banner Page

You can change the text that displays when the user logs onto the LOGIQ Totus via the Utility-> Admin-> Login screen.

There are three login screens that can be used:

- GE HealthCare Default Login Screen
- Department of Defense (DoD) Default Login Screen
- User-customized Login Screen

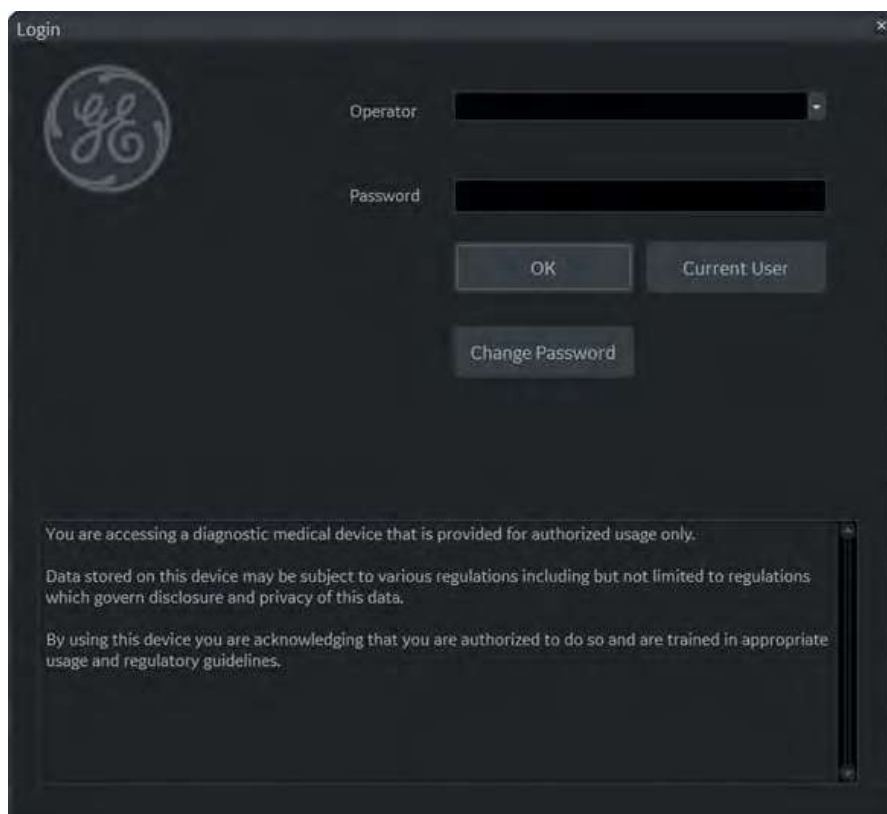
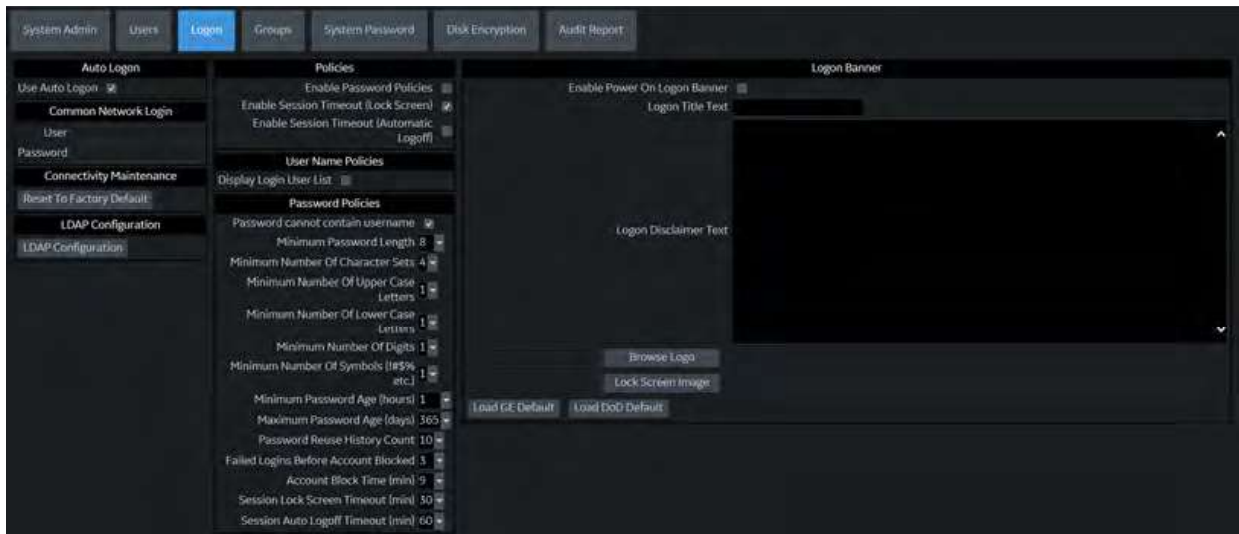

Figure 10-84. GE HealthCare Default Login Window

### Updating the Logon Banner Page (continued)

To configure a customer-specific Login Banner page,

1. Access the Utility-> Admin-> Login screen.



Update the Logon Banner portion of this screen:

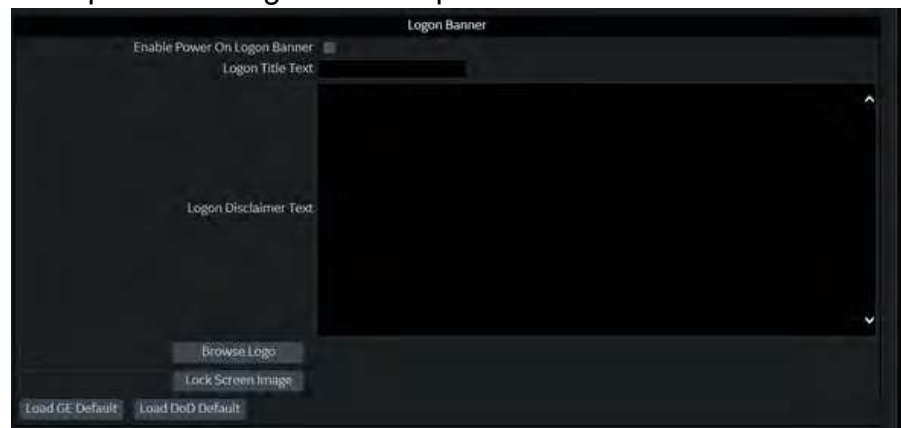

2. Type the Title into Logon Title Text.
3. Type the text into Logon Disclaimer Text.
4. Press Save.



## Updating the Logon Banner Page (continued)

To set the GE HealthCare Default as the Login window, press Load GE HealthCare Default. Then press OK-> Save.



Figure 10-85. Default GE HealthCare Logon Banner

To set the DoD Default as the Login window, press Load DoD Default. Then press OK-> Save.



Figure 10-86. Department of Defense Logon Banner

### Enabling the Power On Logon Banner

To ensure the Power On Logon Banner displays and requires user confirmation to complete booting the system,

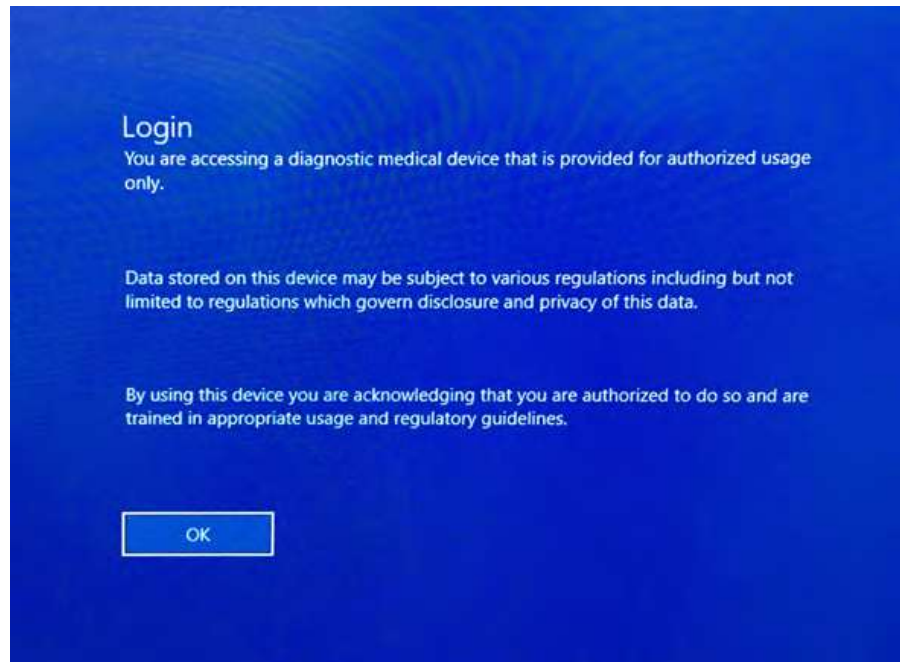

Figure 10-87. Power On Logon Banner

1. Access the Utility-> Admin-> Login screen.
2. Checkmark **Enable Power On Logon Banner**.
3. Press Save and Exit.

### Adding a Logon Logo

The system default logo on the LOGIQ Totus is the GE HealthCare Logo. To add your own Logo,

1. Insert the USB Flash Drive with the Logo into a USB port on the LOGIQ Totus.  
Specifications: The 'Logo' image should be a bitmap image (.BMP) format ONLY, with a size of 128x128.
2. Navigate to the Utility-> Admin-> Login screen.
3. Select Browse Logo. A pop-up window appears for you to navigate to the USB Flash Drive and Logo you want to add.
4. Select the Logo. Select OK. Then Save.

### Adding a "Lock Screen" Image

You can add a custom lock-screen image.

Specifications: The 'Lock Screen' image should be a bitmap image (.BMP) format ONLY, with a size of 1920x1080.

*NOTE: Please select a screen that does not have high contrast or bright colors.*

To add a 'Lock Screen' image,

1. Insert the USB Flash Drive with the image into a USB port on the LOGIQ Totus.
2. Navigate to the Utility-> Admin-> Login screen.
3. Select Lock Screen Image. A pop-up window appears for you to navigate to the USB Flash Drive and image you want to add.
4. Select the image. Select OK. Then Save.

### LDAP Configuration

To enable LDAP authentication, check the “Enable LDAP authentication” box at the top of the LDAP Configuration page.

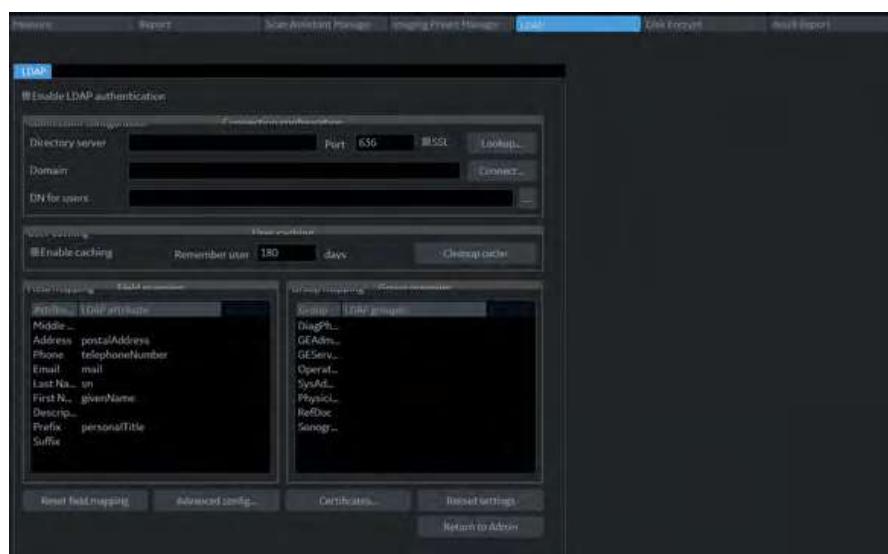

Figure 10-88. LDAP Configuration

Table 10-150: Connection Configuration

Preset Parameter	Description
Enable LDAP authentication	The administrator can select to enable system credentials using LDAP
Connection Configuration:	
Directory Server	URL for the Directory Server
Port	Port for the Directory Server
SSL	SSL (Secure Sockets Layer) -- Select to enable LDAPs (LDAP over SSL).
Lookup...	Button that opens up a Query pop-up for groups, domain, LDAP server, etc.
Domain	Domain name for LDAP server (if needed).
Connect...	Select to connect to server as...
DN for users	Distinguished Name for users. The LDAP API references an LDAP object by its distinguished name (DN). A DN is a sequence of relative distinguished names (RDN) connected by commas.
...	Select to open a list of DNs supported by the server.
User caching:	
Enable caching	The administrator can select to allow the user to cache their password credentials.

Table 10-150: Connection Configuration (Continued)

Preset Parameter	Description
Remember user ____ days	This field specifies the number of days to remember the user for caching purposes.
Cleanup cache	The user can cache credentials. When they select this, it clears out the cache of credentials.
Field mapping:	
Field mapping	The mapping between attributes on the Ultrasound system and LDAP attributes. This allows you (for instance) to select which of several phone numbers that may be stored in your AD server are mapped to the Phone Number field of a user on the system or to refrain from mapping any AD element to that field.
Group mapping:	
Group mapping	Maps an LDAP group to a local group on the machine.
Selection buttons on bottom of screen:	
Reset field mapping	Resets field mapping to the factory defaults
Advanced config...	Entries in this menu should only be changed by experienced network administrators.
Certificates...	Server Certificate
Reload settings	Reloads LDAP settings.
Return to Admin	Press to go back to the Utility--> Admin configuration screens.

### Lookup LDAP Servers

To look up LDAP Servers, select “Lookup” from the LDAP Configuration menu. Select the Domain from the pull-down menu, then select the LDAP Server from the list and press OK.

### Logging on to the LDAP Server

To logon to the LDAP server, type your User Name and Password, then press OK.

### Cleaning Up the Cache of Credentials

To clean up (empty) the cache of credentials, type your User Name and Password, then press OK.

### Certificate Management

The Certificate Manager displays the system's Intermediate and Trusted Root Certification Authorities, as noted on the Certificate Manager's Tabs (Intermediate Certification Authorities and Trusted Root Certification Authorities). You can import or remove certificates.

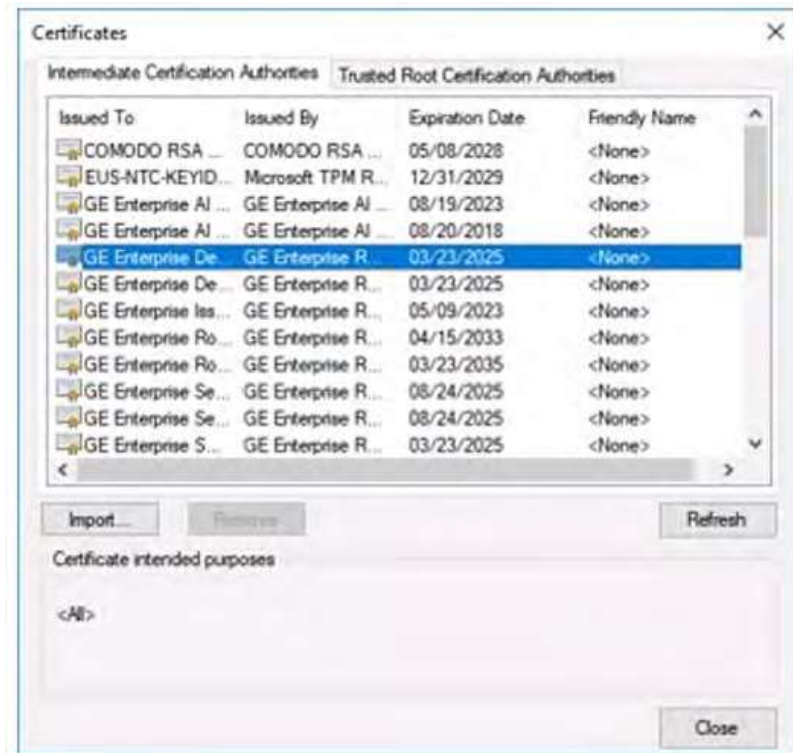

Figure 10-89. Certificate manager

Select the appropriate Certification Authority, then press “Import” to import Certificates or press “Remove” to remove Certificates.



Figure 10-90. Certificate Import Dialog

## Advanced LDAP Configuration

Advanced LDAP Configuration Settings can be set on the Advanced LDAP Configuration menu.

Figure 10-91. Advanced LDAP Configuration

Table 10-151: Advanced LDAP Configuration

Preset Parameter	Description
Default naming context attribute	Attribute name for the naming context.
User search filter	Search for the user using a keyword
Account name attribute	Attribute name for LDAP Attribute to be used as Account/User Name
Group search filter	Search for the group using a keyword
Group name attribute	Attribute name for the LDAP group.
Member Of attribute	Attribute name for the "Member Of".
Search timeout(s)	Limits the time to perform a search
Search page size (objects)	Limits the number of search results
Two step authentication	Under LDAP there's a option for a secondary authentication so you give it a user name and password to login to the LDAP server. (Advanced Configuration)
Enabled	Check this box to enable two-step authentication.
User distinguished name	The user's distinguished name.

Table 10-151: Advanced LDAP Configuration (Continued)

<b>Preset Parameter</b>	<b>Description</b>
User password	The user's password.
Load default settings	The user can select to load system default settings.



## Groups

System rights are set by the Administrator. If you do not have rights to a feature/function, please contact the Administrator. If access is denied, a message in red will appear in the status line (such as “You do not have the required permission to perform...” or a dialog will be displayed with more information. In some cases, buttons or sections of the screen may simply be disabled if you do not have appropriate rights.



Figure 10-92. Groups Configuration

Table 10-152: Group List

Preset Parameter	Description
Add	This creates a new group.
Default Groups	BioMed, DiagPhys, Emergency User, Lead Sonographer, Operator, Physician, RefDoc, Sonographer, and SysAdmin.
SysAdmin	All Group Rights
BioMed	All Group Rights, except Admin. Can edit Imaging/Connectivity Utility pages. Can change the system time and date. Can access the Service Desktop. Cannot edit Admin Utility pages.
Lead Sonographer	Login, Create/Update/Delete/Transfer/Export Patient Data, Basic/Imaging Configuration, Authorize Remote Service Access, and Capture Logs. Can edit Imaging Utility pages. Cannot edit Connectivity or Admin Utility pages and cannot change the system time and date.
Sonographer	Login, Create/Update/Transfer/Export Patient Data, Basic Configuration, Authorize Remote Service Access, and Capture Logs

Table 10-152: Group List (Continued)

Preset Parameter	Description
Physician	Login, Create/Update/Delete/Transfer/Export Patient Data, Basic/Imaging Configuration, Authorize Remote Service Access, and Capture Logs
Emergency User	Login, Create/Transfer Patient Data. Only access to the Utility System and Search Tabs.

Table 10-153: Name and Description

Preset Parameter	Description
Id	The Id, from the Group List.
Description	A description of the Group List Id.

Table 10-154: Group Rights

Preset Parameter	Description																																																																																																																																																			
Rights assigned to each Group, by default	 <table border="1"> <thead> <tr> <th></th> <th>SysAdmin</th> <th>BioMed</th> <th>Lead Sonographer</th> <th>Sonographer</th> <th>Physician</th> <th>Emergency User</th> </tr> </thead> <tbody> <tr><td><input checked="" type="checkbox"/></td><td><input checked="" type="checkbox"/></td><td><input checked="" type="checkbox"/></td><td><input checked="" type="checkbox"/></td><td><input checked="" type="checkbox"/></td><td><input checked="" type="checkbox"/></td><td><input checked="" type="checkbox"/></td></tr> <tr><td><input checked="" type="checkbox"/></td><td></td><td></td><td></td><td></td><td></td><td></td></tr> <tr><td><input checked="" type="checkbox"/></td><td><input checked="" type="checkbox"/></td><td><input checked="" type="checkbox"/></td><td><input checked="" type="checkbox"/></td><td><input checked="" type="checkbox"/></td><td><input checked="" type="checkbox"/></td><td><input checked="" type="checkbox"/></td></tr> <tr><td><input checked="" type="checkbox"/></td><td><input checked="" type="checkbox"/></td><td><input checked="" type="checkbox"/></td><td><input checked="" type="checkbox"/></td><td><input checked="" type="checkbox"/></td><td><input checked="" type="checkbox"/></td><td></td></tr> <tr><td><input checked="" type="checkbox"/></td><td><input checked="" type="checkbox"/></td><td><input checked="" type="checkbox"/></td><td><input checked="" type="checkbox"/></td><td><input checked="" type="checkbox"/></td><td><input checked="" type="checkbox"/></td><td><input checked="" type="checkbox"/></td></tr> <tr><td><input checked="" type="checkbox"/></td><td><input checked="" type="checkbox"/></td><td><input checked="" type="checkbox"/></td><td><input checked="" type="checkbox"/></td><td><input checked="" type="checkbox"/></td><td><input checked="" type="checkbox"/></td><td></td></tr> <tr><td><input checked="" type="checkbox"/></td><td><input checked="" type="checkbox"/></td><td><input checked="" type="checkbox"/></td><td><input checked="" type="checkbox"/></td><td><input checked="" type="checkbox"/></td><td><input checked="" type="checkbox"/></td><td></td></tr> <tr><td><input checked="" type="checkbox"/></td><td><input checked="" type="checkbox"/></td><td><input checked="" type="checkbox"/></td><td><input checked="" type="checkbox"/></td><td><input checked="" type="checkbox"/></td><td><input checked="" type="checkbox"/></td><td></td></tr> <tr><td><input checked="" type="checkbox"/></td><td><input checked="" type="checkbox"/></td><td><input checked="" type="checkbox"/></td><td><input checked="" type="checkbox"/></td><td><input checked="" type="checkbox"/></td><td><input checked="" type="checkbox"/></td><td></td></tr> <tr><td><input checked="" type="checkbox"/></td><td><input checked="" type="checkbox"/></td><td><input checked="" type="checkbox"/></td><td><input checked="" type="checkbox"/></td><td><input checked="" type="checkbox"/></td><td><input checked="" type="checkbox"/></td><td></td></tr> <tr><td><input checked="" type="checkbox"/></td><td><input checked="" type="checkbox"/></td><td><input checked="" type="checkbox"/></td><td><input checked="" type="checkbox"/></td><td><input checked="" type="checkbox"/></td><td><input checked="" type="checkbox"/></td><td></td></tr> <tr><td><input checked="" type="checkbox"/></td><td><input checked="" type="checkbox"/></td><td><input checked="" type="checkbox"/></td><td><input checked="" type="checkbox"/></td><td><input checked="" type="checkbox"/></td><td><input checked="" type="checkbox"/></td><td></td></tr> <tr><td><input checked="" type="checkbox"/></td><td><input checked="" type="checkbox"/></td><td><input checked="" type="checkbox"/></td><td><input checked="" type="checkbox"/></td><td><input checked="" type="checkbox"/></td><td><input checked="" type="checkbox"/></td><td></td></tr> <tr><td><input checked="" type="checkbox"/></td><td><input checked="" type="checkbox"/></td><td><input checked="" type="checkbox"/></td><td><input checked="" type="checkbox"/></td><td><input checked="" type="checkbox"/></td><td><input checked="" type="checkbox"/></td><td></td></tr> <tr><td><input checked="" type="checkbox"/></td><td><input checked="" type="checkbox"/></td><td><input checked="" type="checkbox"/></td><td><input checked="" type="checkbox"/></td><td><input checked="" type="checkbox"/></td><td><input checked="" type="checkbox"/></td><td></td></tr> <tr><td><input checked="" type="checkbox"/></td><td><input checked="" type="checkbox"/></td><td><input checked="" type="checkbox"/></td><td><input checked="" type="checkbox"/></td><td><input checked="" type="checkbox"/></td><td><input checked="" type="checkbox"/></td><td></td></tr> <tr><td><input checked="" type="checkbox"/></td><td><input checked="" type="checkbox"/></td><td><input checked="" type="checkbox"/></td><td><input checked="" type="checkbox"/></td><td><input checked="" type="checkbox"/></td><td><input checked="" type="checkbox"/></td><td></td></tr> <tr><td><input checked="" type="checkbox"/></td><td><input checked="" type="checkbox"/></td><td><input checked="" type="checkbox"/></td><td><input checked="" type="checkbox"/></td><td><input checked="" type="checkbox"/></td><td><input checked="" type="checkbox"/></td><td></td></tr> <tr><td><input checked="" type="checkbox"/></td><td><input checked="" type="checkbox"/></td><td><input checked="" type="checkbox"/></td><td><input checked="" type="checkbox"/></td><td><input checked="" type="checkbox"/></td><td><input checked="" type="checkbox"/></td><td></td></tr> <tr><td><input checked="" type="checkbox"/></td><td><input checked="" type="checkbox"/></td><td><input checked="" type="checkbox"/></td><td><input checked="" type="checkbox"/></td><td><input checked="" type="checkbox"/></td><td><input checked="" type="checkbox"/></td><td></td></tr> </tbody> </table>		SysAdmin	BioMed	Lead Sonographer	Sonographer	Physician	Emergency User	<input checked="" type="checkbox"/>	<input checked="" type="checkbox"/>	<input checked="" type="checkbox"/>	<input checked="" type="checkbox"/>	<input checked="" type="checkbox"/>	<input checked="" type="checkbox"/>	<input checked="" type="checkbox"/>	<input checked="" type="checkbox"/>							<input checked="" type="checkbox"/>	<input checked="" type="checkbox"/>	<input checked="" type="checkbox"/>	<input checked="" type="checkbox"/>	<input checked="" type="checkbox"/>	<input checked="" type="checkbox"/>	<input checked="" type="checkbox"/>	<input checked="" type="checkbox"/>	<input checked="" type="checkbox"/>	<input checked="" type="checkbox"/>	<input checked="" type="checkbox"/>	<input checked="" type="checkbox"/>	<input checked="" type="checkbox"/>		<input checked="" type="checkbox"/>	<input checked="" type="checkbox"/>	<input checked="" type="checkbox"/>	<input checked="" type="checkbox"/>	<input checked="" type="checkbox"/>	<input checked="" type="checkbox"/>	<input checked="" type="checkbox"/>	<input checked="" type="checkbox"/>	<input checked="" type="checkbox"/>	<input checked="" type="checkbox"/>	<input checked="" type="checkbox"/>	<input checked="" type="checkbox"/>	<input checked="" type="checkbox"/>		<input checked="" type="checkbox"/>	<input checked="" type="checkbox"/>	<input checked="" type="checkbox"/>	<input checked="" type="checkbox"/>	<input checked="" type="checkbox"/>	<input checked="" type="checkbox"/>		<input checked="" type="checkbox"/>	<input checked="" type="checkbox"/>	<input checked="" type="checkbox"/>	<input checked="" type="checkbox"/>	<input checked="" type="checkbox"/>	<input checked="" type="checkbox"/>		<input checked="" type="checkbox"/>	<input checked="" type="checkbox"/>	<input checked="" type="checkbox"/>	<input checked="" type="checkbox"/>	<input checked="" type="checkbox"/>	<input checked="" type="checkbox"/>		<input checked="" type="checkbox"/>	<input checked="" type="checkbox"/>	<input checked="" type="checkbox"/>	<input checked="" type="checkbox"/>	<input checked="" type="checkbox"/>	<input checked="" type="checkbox"/>		<input checked="" type="checkbox"/>	<input checked="" type="checkbox"/>	<input checked="" type="checkbox"/>	<input checked="" type="checkbox"/>	<input checked="" type="checkbox"/>	<input checked="" type="checkbox"/>		<input checked="" type="checkbox"/>	<input checked="" type="checkbox"/>	<input checked="" type="checkbox"/>	<input checked="" type="checkbox"/>	<input checked="" type="checkbox"/>	<input checked="" type="checkbox"/>		<input checked="" type="checkbox"/>	<input checked="" type="checkbox"/>	<input checked="" type="checkbox"/>	<input checked="" type="checkbox"/>	<input checked="" type="checkbox"/>	<input checked="" type="checkbox"/>		<input checked="" type="checkbox"/>	<input checked="" type="checkbox"/>	<input checked="" type="checkbox"/>	<input checked="" type="checkbox"/>	<input checked="" type="checkbox"/>	<input checked="" type="checkbox"/>		<input checked="" type="checkbox"/>	<input checked="" type="checkbox"/>	<input checked="" type="checkbox"/>	<input checked="" type="checkbox"/>	<input checked="" type="checkbox"/>	<input checked="" type="checkbox"/>		<input checked="" type="checkbox"/>	<input checked="" type="checkbox"/>	<input checked="" type="checkbox"/>	<input checked="" type="checkbox"/>	<input checked="" type="checkbox"/>	<input checked="" type="checkbox"/>		<input checked="" type="checkbox"/>	<input checked="" type="checkbox"/>	<input checked="" type="checkbox"/>	<input checked="" type="checkbox"/>	<input checked="" type="checkbox"/>	<input checked="" type="checkbox"/>		<input checked="" type="checkbox"/>	<input checked="" type="checkbox"/>	<input checked="" type="checkbox"/>	<input checked="" type="checkbox"/>	<input checked="" type="checkbox"/>	<input checked="" type="checkbox"/>		<input checked="" type="checkbox"/>	<input checked="" type="checkbox"/>	<input checked="" type="checkbox"/>	<input checked="" type="checkbox"/>	<input checked="" type="checkbox"/>	<input checked="" type="checkbox"/>		<input checked="" type="checkbox"/>	<input checked="" type="checkbox"/>	<input checked="" type="checkbox"/>	<input checked="" type="checkbox"/>	<input checked="" type="checkbox"/>	<input checked="" type="checkbox"/>	
	SysAdmin	BioMed	Lead Sonographer	Sonographer	Physician	Emergency User																																																																																																																																														
<input checked="" type="checkbox"/>	<input checked="" type="checkbox"/>	<input checked="" type="checkbox"/>	<input checked="" type="checkbox"/>	<input checked="" type="checkbox"/>	<input checked="" type="checkbox"/>	<input checked="" type="checkbox"/>																																																																																																																																														
<input checked="" type="checkbox"/>																																																																																																																																																				
<input checked="" type="checkbox"/>	<input checked="" type="checkbox"/>	<input checked="" type="checkbox"/>	<input checked="" type="checkbox"/>	<input checked="" type="checkbox"/>	<input checked="" type="checkbox"/>	<input checked="" type="checkbox"/>																																																																																																																																														
<input checked="" type="checkbox"/>	<input checked="" type="checkbox"/>	<input checked="" type="checkbox"/>	<input checked="" type="checkbox"/>	<input checked="" type="checkbox"/>	<input checked="" type="checkbox"/>																																																																																																																																															
<input checked="" type="checkbox"/>	<input checked="" type="checkbox"/>	<input checked="" type="checkbox"/>	<input checked="" type="checkbox"/>	<input checked="" type="checkbox"/>	<input checked="" type="checkbox"/>	<input checked="" type="checkbox"/>																																																																																																																																														
<input checked="" type="checkbox"/>	<input checked="" type="checkbox"/>	<input checked="" type="checkbox"/>	<input checked="" type="checkbox"/>	<input checked="" type="checkbox"/>	<input checked="" type="checkbox"/>																																																																																																																																															
<input checked="" type="checkbox"/>	<input checked="" type="checkbox"/>	<input checked="" type="checkbox"/>	<input checked="" type="checkbox"/>	<input checked="" type="checkbox"/>	<input checked="" type="checkbox"/>																																																																																																																																															
<input checked="" type="checkbox"/>	<input checked="" type="checkbox"/>	<input checked="" type="checkbox"/>	<input checked="" type="checkbox"/>	<input checked="" type="checkbox"/>	<input checked="" type="checkbox"/>																																																																																																																																															
<input checked="" type="checkbox"/>	<input checked="" type="checkbox"/>	<input checked="" type="checkbox"/>	<input checked="" type="checkbox"/>	<input checked="" type="checkbox"/>	<input checked="" type="checkbox"/>																																																																																																																																															
<input checked="" type="checkbox"/>	<input checked="" type="checkbox"/>	<input checked="" type="checkbox"/>	<input checked="" type="checkbox"/>	<input checked="" type="checkbox"/>	<input checked="" type="checkbox"/>																																																																																																																																															
<input checked="" type="checkbox"/>	<input checked="" type="checkbox"/>	<input checked="" type="checkbox"/>	<input checked="" type="checkbox"/>	<input checked="" type="checkbox"/>	<input checked="" type="checkbox"/>																																																																																																																																															
<input checked="" type="checkbox"/>	<input checked="" type="checkbox"/>	<input checked="" type="checkbox"/>	<input checked="" type="checkbox"/>	<input checked="" type="checkbox"/>	<input checked="" type="checkbox"/>																																																																																																																																															
<input checked="" type="checkbox"/>	<input checked="" type="checkbox"/>	<input checked="" type="checkbox"/>	<input checked="" type="checkbox"/>	<input checked="" type="checkbox"/>	<input checked="" type="checkbox"/>																																																																																																																																															
<input checked="" type="checkbox"/>	<input checked="" type="checkbox"/>	<input checked="" type="checkbox"/>	<input checked="" type="checkbox"/>	<input checked="" type="checkbox"/>	<input checked="" type="checkbox"/>																																																																																																																																															
<input checked="" type="checkbox"/>	<input checked="" type="checkbox"/>	<input checked="" type="checkbox"/>	<input checked="" type="checkbox"/>	<input checked="" type="checkbox"/>	<input checked="" type="checkbox"/>																																																																																																																																															
<input checked="" type="checkbox"/>	<input checked="" type="checkbox"/>	<input checked="" type="checkbox"/>	<input checked="" type="checkbox"/>	<input checked="" type="checkbox"/>	<input checked="" type="checkbox"/>																																																																																																																																															
<input checked="" type="checkbox"/>	<input checked="" type="checkbox"/>	<input checked="" type="checkbox"/>	<input checked="" type="checkbox"/>	<input checked="" type="checkbox"/>	<input checked="" type="checkbox"/>																																																																																																																																															
<input checked="" type="checkbox"/>	<input checked="" type="checkbox"/>	<input checked="" type="checkbox"/>	<input checked="" type="checkbox"/>	<input checked="" type="checkbox"/>	<input checked="" type="checkbox"/>																																																																																																																																															
<input checked="" type="checkbox"/>	<input checked="" type="checkbox"/>	<input checked="" type="checkbox"/>	<input checked="" type="checkbox"/>	<input checked="" type="checkbox"/>	<input checked="" type="checkbox"/>																																																																																																																																															
<input checked="" type="checkbox"/>	<input checked="" type="checkbox"/>	<input checked="" type="checkbox"/>	<input checked="" type="checkbox"/>	<input checked="" type="checkbox"/>	<input checked="" type="checkbox"/>																																																																																																																																															
Login	Allows users in this group to logon to the system.																																																																																																																																																			
Admin	Allows users in this group to have system administrator's rights. Can add/remove users and enable/disable encryption, etc.																																																																																																																																																			
Create Patient Data	Allows users in this group to create patient and exam data. This right is needed to register a patient and start an exam. Access to the following controls is prohibited without this right: New Patient, Register, and Save and Exit.																																																																																																																																																			
Update Patient Data	Allows users in this group to change patient and exam data. This right is needed to view patient and exam information stored in the patient database. Access to the following is prohibited without this right: Patient List, Exam List, Data Transfer screen, ability to delete images from the clipboard or active images screen, ability to delete reports from the Reports screen, ability to change to the USB Read Only workflow, ability to see all the jobs (except one's own) in the Spooler.																																																																																																																																																			

Table 10-154: Group Rights (Continued)

Preset Parameter	Description
Delete Patient Data	Allows users in this group to delete patient and exam data. This right is needed to use the Delete button on the Patient List and Exam List. Access to the following is prohibited without this right: Patient delete via Patient Registration and Patient List.
Transfer Patient Data	Allows users to transfer patient and exam data over DICOM. This right is needed for DICOM transfers over the network configured for Print keys and with Workflows. Access to the following is prohibited without this right: DICOM Image Storage, DICOM SR Storage, DICOM MPPS, DICOM Storage Commitment, and DICOM Print; Print button and Workflow; Koios DS in TCS; and Sent To from Patient Registration and Active Image Patient screens.
Export Patient Data	Allows users to export patient and exam data to media. This right is needed to Export, Save As, USB quick Save to media and for print functionalities. Access to the following is prohibited without this right: Executing a Save As, USB Quick Store, or Video Capture via a configured Print key, EZBackup, Printing or Saving a Report As, Print the Patient List; in TCS Standard Print Button, and Save As Images controls, Data Transfer screen functionality to perform an Export.
Import Patient Data	Allows users to import patient and exam data from media. This right is needed to import from media, Worklist download, or to use the Query/ Retrieve feature.
Basic Configuration	Allows access to and modification of basic Utility pages, which everyone has access to, except members of the Emergency User's Group.
Imaging Configuration	Allows modification of imaging preset Utility pages. Note, If the "Require Admin Operator Rights to Save Imaging Settings" is checked on the Utility page, then the "Imaging Configuration" right can only be used by a SysAdmin.
Advanced Configuration	Allows access to and modification of advanced configuration pages.
Device Mgmt Configuration	Allows users in this group to activate and configure Device Mgmt Cloud configuration management tool.
Authorize Remote Service Access	Allows users to authorize service engineers to connect to the system remotely and perform service tasks.
Capture Logs	Allows users in this group to capture and export a system log to monitor system performance.
Capture Logs with PHI	Allows users in this group to export log files with PHI included.
Access Service Desktop	Allows users in this group to access the Service Desktop.
Software Management	Allows users in this group to access Software Download.

To set up a new group,

1. Select the Group.
2. Assign the Rights you wish this Group to have.

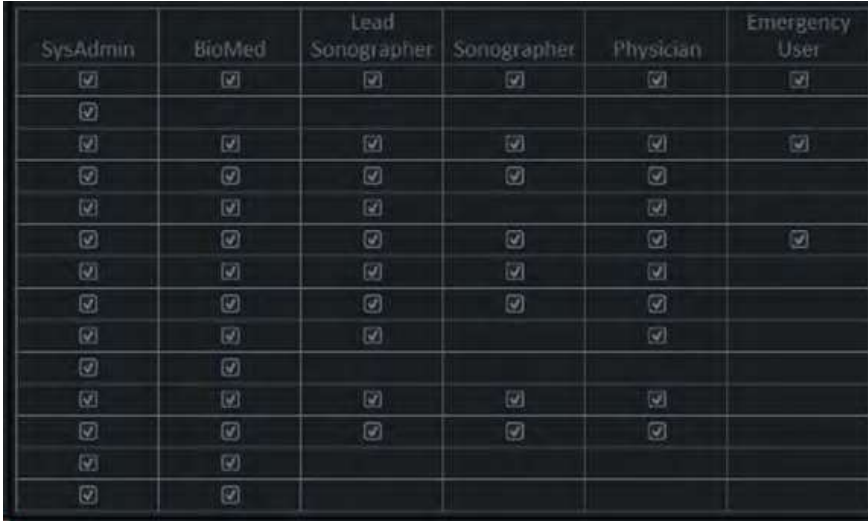
### System Password

The System Password is the Windows Password used by the LOGIQ Totus to automatically log into Windows. Users of the system will never need to use this password. The only reason to change the password will be if the user, for security reasons, prefers to define their own password instead of using the factory-created default password. As with all passwords, this should be treated with care and archived appropriately so that it can be provided to service personnel if necessary.

If you have changed the System Password, you must have the Current Password to change it.

To change the System Password,

1. Type your current password in the System Password field

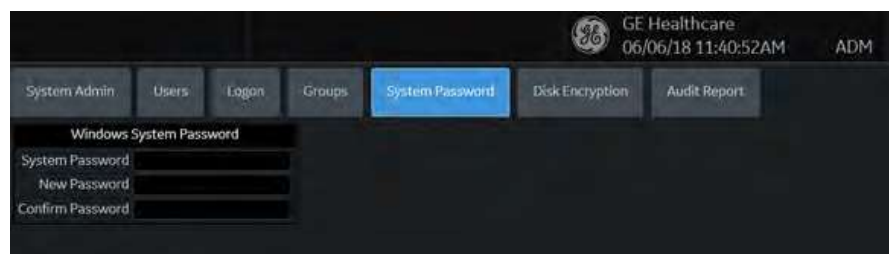

**NOTE:** *There is no need to enter the “current password” to change the System Password if the System Password has not been previously changed from the factory default. The same is true for the Database Password.*

2. Type the new password in the New Password field.
3. Type the new password again in the Confirm Password field.
4. Press Save to save the new Password; then press Exit.

**NOTE:** *‘Windows System password’ is the password for the underlying Windows OS user running this application. Do not change this password unless you are the system administrator of the device. This password is not needed for users of the system. It will only be needed by GEHC service in special situations. If you change the password, be sure to keep the new password secured and available if needed by GEHC service.*

## Disk Encryption

Disk Encryption is designed to protect data privacy and assist your organization with HIPAA/HITECH compliance. Safeguards include:

- All patient data on the system's patient archive drive can be encrypted to provide protection in the event of a stolen device or hard drive.



### WARNING

If you've selected "Encryption ON. Key is stored on USB / password is entered manually" encryption and both password and recovery key are lost, you will not be able to access archived patient data (images and measurements included) nor store new patient data on this system.

The only way to recover the system to allow storing patient data is to reset the entire disk, which deletes all the archived patient data on the disk.

It is strongly recommended that all the patient data be stored in PACS or backed up to media prior to encrypting the disk.

In addition, it is recommended that the recovery key be stored on a USB storage device, printed, and kept in a secure location, ensuring that it will not be lost.



### CAUTION

Make sure the system power cable is plugged into external power. **DO NOT** attempt to perform the initial encryption function on battery power.

### Disk Encryption (continued)

The system encrypts patient data by default (Encryption On. Disks are unlocked automatically).

1. If you wish to change the default encryption setting, select the desired Encryption Policy, then press Accept.

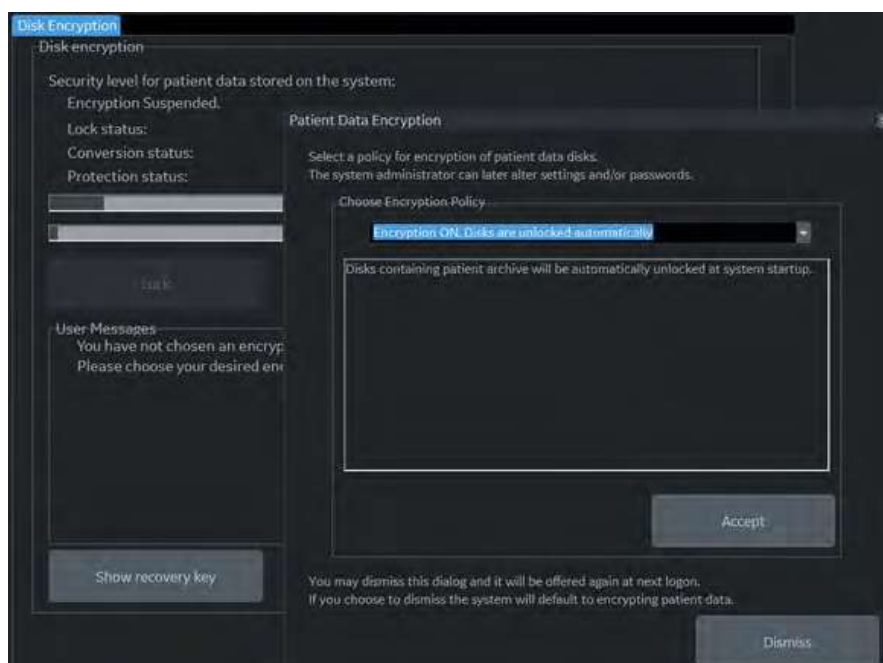

Figure 10-93. Initialize System Encryption

**NOTE:** *If you (or the Field Service Engineer) reloads system software, you will need to press “Initialize System Encryption” to encrypt the system and reset System Encryption password and preferences.*

## Disk Encryption (continued)

Table 10-155: Encryption Policy Selections

Encryption Policy	Description
Encryption OFF	Patient Data will not be encrypted. Selecting "OFF" will unencrypt the drive. System drive and recovery partition will remain encrypted.
Encryption ON. Disks are unlocked automatically	System Default. Patient data is encrypted and unlocked at system boot-up. Recovery Key and Password tied to the hard drive.
Encryption On. Require Pre-Boot PIN/Password before unlocking system drives	The system will not boot until the Pre-Boot PIN or Password has been entered. Unlike other manual key entry configurations, no system functionality is available without the PIN/Password. This encryption policy is intended for high security environments or customers with specific needs.
Encryption ON. Key is stored on USB / password is entered manually	The system will request the encryption password or recovery key at system startup. The system is not accessible until this password or a disk recovery key is provided. Requiring a password to access the patient archive may prevent emergency usage of the system.

**NOTE:** *If you choose to dismiss this dialog, you will be reminded to continue configuring encryption at each logon.*

## Disk Encryption (continued)

2. You must set the Encryption Password and record the Recovery Key in order to ensure access to your institution's patient data (required if replacing the system drive, ECB Board, or reformatting the C:\ Drive).
  - a. To reset the Encryption Password, "Change password."

NOTE:

*Press **NO** if this question pop-up appears: "Password is already set on a disk. Do you want to reuse it? Press Yes to reuse existing password. Press No to delete existing password. You will be prompted to set new."*

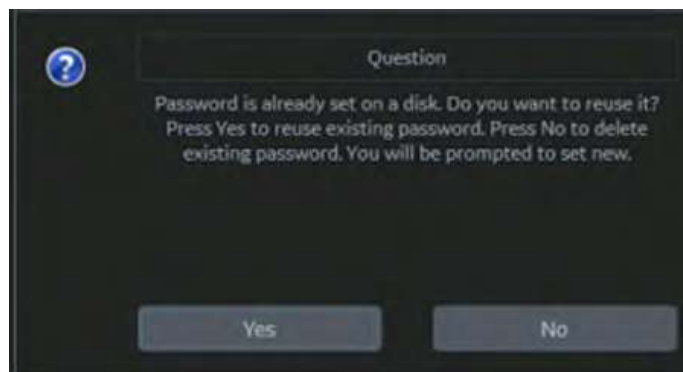

You can now update the encryption password, then press OK.





## Disk Encryption (continued)

3. Recovery Keys are not backed up by the system; you must record / archive the Recovery Key in order to retrieve patient data.



CAUTION

Make sure to keep the password, recovery key, and any backup of these in a secure place, not accessible for any unintended audience.

```

Recovery Keys
HW Number: engineer_500469J57
Drive Letter: D:
Full recovery key identification: B1026E13-1930-4AFA-8242-23CD803C5825
BitLocker Recovery Key: 211178-413270-085998-416427-664752-148687-189992-430155
Drive Letter: E:
Full recovery key identification: 64CBEF7D-D54F-49AC-87D1-EEEE25D0FCA4
BitLocker Recovery Key: 211178-413270-085998-416427-664752-148687-189992-430155
Drive Letter: V:
Full recovery key identification: 0F6163AC-AB6C-47BC-9AAA-467D98628C67
BitLocker Recovery Key: 211178-413270-085998-416427-664752-148687-189992-430155
  
```

You can Show or Hide the Encryption key. Store the Recovery Key in a secure location, accessible to the ADM user as necessary.

- a. Insert the USB flash drive into a USB port to save the recovery key.

**NOTE:**

*Use the USB flash drive as the repository only for the recovery key. DO NOT use it for data archiving or DVR recording.*

Save recovery key to a USB Flash Drive by pressing **Save recovery keys**.

- b. View the Recovery Key by pressing **Show recovery key**, then print it to a local printer or PACS.

Press the **Print key** to print the recovery key on the local printer.

- c. Press **Show recovery key** to display the recovery key on the screen.

Press **Hide recovery key** to hide the recovery key.

### Change password

Press **Change Password** to change the password as necessary.

### Change the recovery key

If you want to change the recovery key, select **Change recovery key** to generate a new key.

*NOTE: Generating a new key causes the previous key to expire.*

### Disk Encryption Frequently Asked Questions

Here are answers to some frequently-asked questions:

**Q** What type of encryption technology is used on my ultrasound system?

**A** The system uses Microsoft Bitlocker FDE configured to use FIPS-Compliant encryption protocols.

**Q** The system was accidentally turned off or lost power during the disk encryption process.

**A** Restart the system, and then go to Utility>Admin>Disk Encryption, select "On", ...resume, the disk encryption will continue

**Q** The USB recovery key was accidentally formatted. How do I access the system?

**A** If a password was created or the recovery key was written down, enter the information in the pop up window. Then go to Utility>Admin>Disc Encryption and Select **Change recovery key**. Be sure to print and save the new recovery key and store the USB in a secure location.