



NASAL EPISTAXIS BALLOON

Safe and Fast Nasal Bleeding Control



OTOLARYNGOLOGY
SERIES



NASAL EPISTAXIS BALLOON

Fortune[®] Silicone Nasal Epistaxis Balloon Features:

- 100% medical grade silicone for superior biocompatibility.
- Inflatable flexible balloon provides direct uniform pressure.
- Soft and beveled tip facilitates insertion and minimizes trauma.
- Larger balloon can be inflated up to 30 cc to control anterior nasal bleeding.
- Smaller balloon can be inflated up to 10 cc to control posterior nasal bleeding.
- Airway channel design allows nasal breathing.
- Unique pilot balloon design allows cuff monitoring to prevent over-pressure.
- Ideal for nasal packing for septoplasty, rhinoplasty and intra-nasal surgical procedure.

- A** Nasal Epistaxis Balloon, Intra-Pack
- B** Nasal Epistaxis Balloon, Post-Pack
- C** Nasal Epistaxis Balloon, Double Balloon

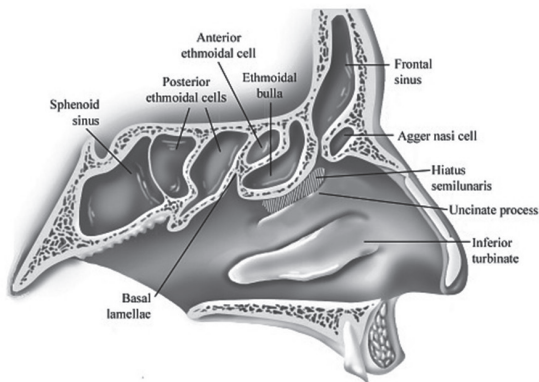

NASAL EPISTAXIS BALLOON

SPECIFICATIONS

Nasal Epistaxis Balloon, Intra-Pack:

REF. No.	Size	Application
3101-0830	30 cc	Intra-anterior nasal chamber

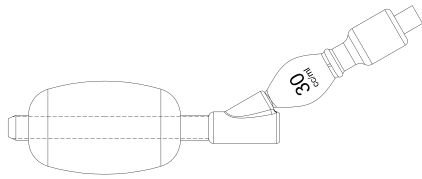

3101-0830

Nasal Epistaxis Balloon, Post-Pack:

REF. No.	Size	Application
3102-2010	10 cc	Posterior nasal chamber

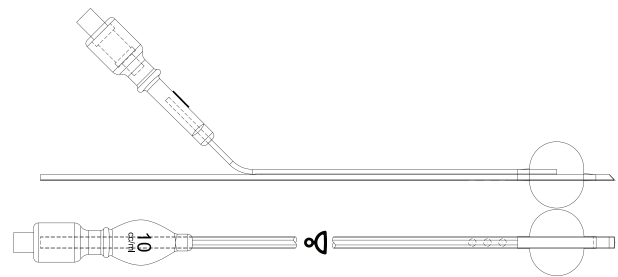

3102-2010

Nasal Epistaxis Balloon, Double Balloon:

REF. No.	Size	Application
3103-0930	30/10 cc	anterior and posterior nasal chamber

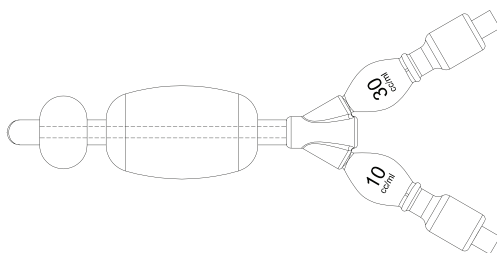

3103-0930



6 F., No. 29, Sec. 2, Jhongjheng E. Rd.,
Danshuei Dist, New Taipei City, 251 Taiwan
Tel.:(886) 2-2624-2233 Fax.:(886) 2-2624-2266
www.fortunemed.com Mail:info@fortunemed.com

Distribuitor autorizat in Moldova



www.ericon.md

Tel:0-22-520108

mob.079410042

FONDAT 1992

15,Zelinski str.
Chişinău, MOLDOVA



SILICONE ENDOTRACHEAL TUBE

100% Silicone for Great Comfort and Flexibility



ANESTHETIC
SERIES

SILICONE ENDOTRACHEAL TUBE

Fortune[®] Silicone Endotracheal Tube is made of 100% medical grade silicone. It provides superior bio-compatibility and flexibility. Great transparency allows easy visual inspection. Graduation and X-ray opaque line help depth and location confirmation. A pilot balloon is equipped to monitor balloon status. Low pressure cuff models are available to reduce the pressure on trachea wall and to provide greater comfort to patient.

- A** Silicone Endotracheal Tube, Cuffless
- B** Silicone Endotracheal Tube, OC Type
- C** Silicone Endotracheal Tube, LC Type
- D** Silicone Endotracheal Tube, OW Type
- E** Silicone Endotracheal Tube, LW Type



SPECIFICATIONS

Endotracheal Tube, Cuffless:

PED-Magill REF. No.	Size/I.D.	O.D.	Length	Description
1510-0025	2.5 mm	4.0 mm	140 mm	
1510-0030	3.0 mm	4.7 mm	160 mm	Magill Series: Magill tip
1510-0035	3.5 mm	5.3 mm	180 mm	Cuffless
1510-0040	4.0 mm	6.0 mm	200 mm	Wire reinforced
1510-0045	4.5 mm	6.7 mm	220 mm	Graduation
1510-0050	5.0 mm	7.3 mm	240 mm	X-ray opaque line

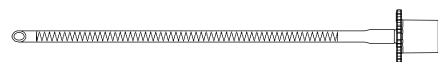

1510-00XX

SILICONE ENDOTRACHEAL TUBE

Endotracheal Tube, OC Type (Ordinary cuff, Curved):

OC-Magill REF. No.	OC-Murphy REF. No.	Size/I.D.	O.D.	Length	Description
1520-0045	1525-0045	4.5 mm	6.7 mm	220 mm	
1520-0050	1525-0050	5.0 mm	7.3 mm	240 mm	
1520-0055	1525-0055	5.5 mm	8.0 mm	270 mm	*OC-Magill
1520-0060	1525-0060	6.0 mm	8.7 mm	280 mm	series: Magill
1520-0065	1525-0065	6.5 mm	9.3 mm	290 mm	tip
1520-0070	1525-0070	7.0 mm	10.0 mm	300 mm	*OC-Murphy
1520-0075	1525-0075	7.5 mm	10.7 mm	310 mm	series: Murphy
1520-0080	1525-0080	8.0 mm	11.3 mm	320 mm	eye
1520-0085	1525-0085	8.5 mm	12.0 mm	330 mm	Ordinary cuff
1520-0090	1525-0090	9.0 mm	12.7 mm	340 mm	Curved
1520-0095	1525-0095	9.5 mm	13.3 mm	350 mm	Graduation
1520-0100	1525-0100	10.0 mm	14.0 mm	360 mm	Pilot balloon
					X-ray opaque
					line

Endotracheal Tube, LC Type (Low pressure cuff, Curved):

LC-Magill REF. No.	LC-Murphy REF. No.	Size/I.D.	O.D.	Length	Description
1530-0045	1535-0045	4.5 mm	6.7 mm	220 mm	
1530-0050	1535-0050	5.0 mm	7.3 mm	240 mm	
1530-0055	1535-0055	5.5 mm	8.0 mm	270 mm	*LC-Magill
1530-0060	1535-0060	6.0 mm	8.7 mm	280 mm	series: Magill
1530-0065	1535-0065	6.5 mm	9.3 mm	290 mm	tip
1530-0070	1535-0070	7.0 mm	10.0 mm	300 mm	*LC-Murphy
1530-0075	1535-0075	7.5 mm	10.7 mm	310 mm	series: Murphy
1530-0080	1535-0080	8.0 mm	11.3 mm	320 mm	eye
1530-0085	1535-0085	8.5 mm	12.0 mm	330 mm	Low pressure
1530-0090	1535-0090	9.0 mm	12.7 mm	340 mm	cuff
1530-0095	1535-0095	9.5 mm	13.3 mm	350 mm	Curved
1530-0100	1535-0100	10.0 mm	14.0 mm	360 mm	Graduation
					Pilot balloon
					X-ray opaque
					line

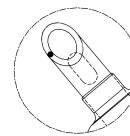
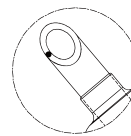
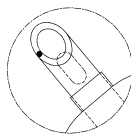
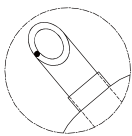
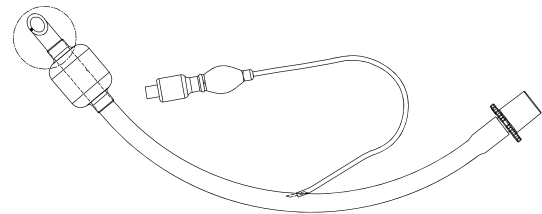
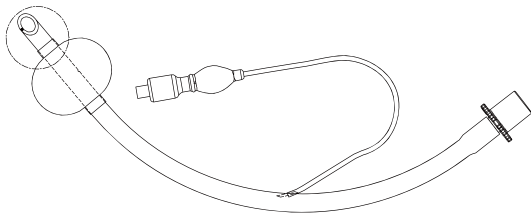

1520-OXXX

1525-OXXX

1530-OXXX

1535-OXXX

SILICONE ENDOTRACHEAL TUBE

Endotracheal Tube, OW Type (Ordinary cuff, Wire reinforced):

OW-Magill REF. No	OW- Murphy REF. No.	Size/I.D.	O.D.	Length	Description
1540-0045	1545-0045	4.5 mm	6.7 mm	220 mm	
1540-0050	1545-0050	5.0 mm	7.3 mm	240 mm	
1540-0055	1545-0055	5.5 mm	8.0 mm	270 mm	
1540-0060	1545-0060	6.0 mm	8.7 mm	280 mm	*OW-Magill series: Magill tip
1540-0065	1545-0065	6.5 mm	9.3 mm	290 mm	*OW-Murphy series: Murphy eye
1540-0070	1545-0070	7.0 mm	10.0 mm	300 mm	
1540-0075	1545-0075	7.5 mm	10.7 mm	310 mm	Ordinary cuff Wire reinforced
1540-0080	1545-0080	8.0 mm	11.3 mm	320 mm	Graduation Pilot balloon
1540-0085	1545-0085	8.5 mm	12.0 mm	330 mm	
1540-0090	1545-0090	9.0 mm	12.7 mm	340 mm	
1540-0095	1545-0095	9.5 mm	13.3 mm	350 mm	
1540-0100	1545-0100	10.0 mm	14.0 mm	360 mm	

Endotracheal Tube, LW Type (Low pressure cuff, Wire reinforced):

LW-Magill REF. No	LW-Murphy REF. No.	Size/I.D.	O.D.	Length	Description
1550-0045	1555-0045	4.5 mm	6.7 mm	220 mm	
1550-0050	1555-0050	5.0 mm	7.3 mm	240 mm	
1550-0055	1555-0055	5.5 mm	8.0 mm	270 mm	
1550-0060	1555-0060	6.0 mm	8.7 mm	280 mm	*LW-Magill series: Magill tip
1550-0065	1555-0065	6.5 mm	9.3 mm	290 mm	*LW-Murphy series: Murphy eye
1550-0070	1555-0070	7.0 mm	10.0 mm	300 mm	
1550-0075	1555-0075	7.5 mm	10.7 mm	310 mm	Low pressure cuff Wire reinforced
1550-0080	1555-0080	8.0 mm	11.3 mm	320 mm	Graduation Pilot balloon
1550-0085	1555-0085	8.5 mm	12.0 mm	330 mm	
1550-0090	1555-0090	9.0 mm	12.7 mm	340 mm	
1550-0095	1555-0095	9.5 mm	13.3 mm	350 mm	
1550-0100	1555-0100	10.0 mm	14.0 mm	360 mm	

O: ordinary cuff, L: low pressure cuff, W: wire reinforced

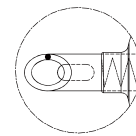
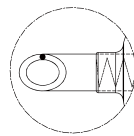
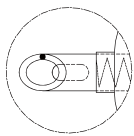
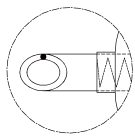
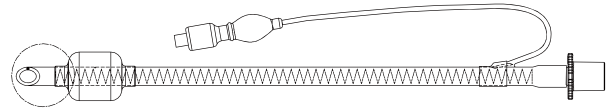
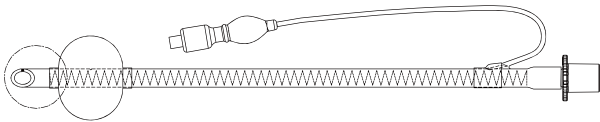

1540-OXXX:LW-MAGILL

1545-OXXX:LW-MYRPHY

1550-OXXX:LW-MAGILL

1555-OXXX:LW-MYRPHY

TRACHEAL TUBE FIXATION DEVICE

INTENDED USE:

The Fortune tracheal tube fixation device (hereinafter referred to as the fixer) is intended to be used to secure a tracheal tube in an appropriate position. It is easy to operate and enhances patient comfort.

FEATURES:

1. Easy to operate: quick to mount; efficiently prevents biting of the tube.
2. The anti-ulceration pad reduces the risk of ulcerated lips.
3. Smaller and shorter than artificial airways, the fixer's small size reduces the risk of damage to the patient's oral cavity.
4. The fixer's adjustable strap reduces the risk of skin damage. The strap is designed with patient comfort in mind.

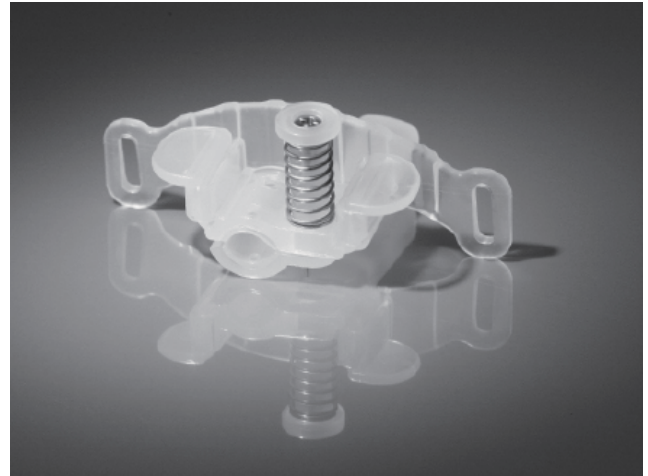

SPECIFICATIONS

Designed to match tracheal tubes with outer diameter (O.D.) from 8.0 mm to 12.0 mm.

Fortune Tracheal tube	size	O.D. (mm)	I.D. (mm)
	0060 26FR	8.7	6.0
1520 series,	0065 28FR	9.3	6.5
1525 series,			
1530 series,	0070 30FR	10.0	7.0
1535 series,			
1540 series,	0075 32FR	10.7	7.5
1545 series,			
1550 series,	0080 34FR	11.3	8.0
1555 series,			
	0085 36FR	12.0	8.5
	0090 38FR	12.7	9.0

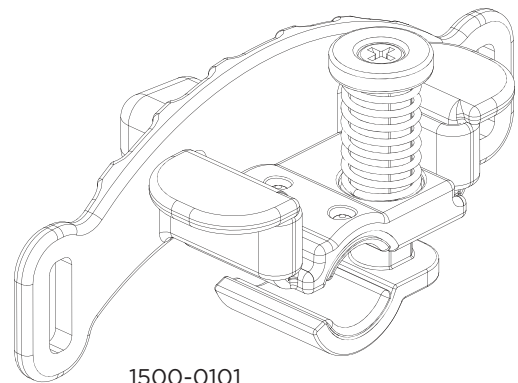

1500-0101



6 F., No. 29, Sec. 2, Jhongjheng E. Rd.,
 Danshuei Dist, New Taipei City. 251 Taiwan
 Tel.:(886) 2-2624-2233 Fax.:(886) 2-2624-2266
 www.fortunemed.com Mail:info@fortunemed.com

Distribuitor autorizat in Moldova

www.ericon.md
Tel:0-22-520108
mob.079410042

FONDAT 1992
 15,Zelinski str.
 Chişinău,MOLDOVA



SILICONE FOLEY BALLOON CATHETER

The Right Choice for Quality Catheters



SILICONE FOLEY BALLOON CATHETER

Fortune[®] Silicone 2 way Foley balloon Catheter Features:

- 100% medical grade silicone for superior biocompatibility.
- Transparent medical grade silicone tube allows easy visual inspection and fluid observation.
- X-ray opaque line allows for confirmation of intubated tube using X-ray.
- Soft and uniformly inflated balloon makes the tube sit well against the bladder.
- Smooth round shaft can minimize trauma during insertion and withdrawal.
- 6FR, 8FR and 10FR Pediatric Foley Catheter has disposable stylet for easy insertion.
- Includes an individual sterilized packed Catheter Spigot.
- Sterilized double packaging.
- Firm yet flexible tip designed to aid insertion.
- Recommended usage up to 90 days for 4833 series, of which balloon is more durable recommended usage up to 29 days for 182X/1856/1830/4822/4856 series.

- A Pediatric**
- B Standard, 5-10 cc/ml**
- C Standard, 20-30 cc/ml**
- D Female**
- E Catheter Spigot**
- F Tiemann Tip**



SPECIFICATIONS

2-Way Foley Balloon Catheter, Pediatric:

REF. No.	Size	Balloon	Length	Description
1821-0506	6 FR	1-1.5 cc/ml	330 mm	Stylet X-ray opaque line Catheter spigot
1821-0508	8 FR	2-3 cc/ml		
1821-0510	10 FR	3-5 cc/ml		
1821-0606	6 FR	1-1.5 cc/ml	330 mm	Metal Stylet X-ray opaque line Catheter spigot
1821-0608	8 FR	2-3 cc/ml		
1821-0610	10 FR	3-5 cc/ml		



1821-05XX/1821-06XX

SILICONE FOLEY BALLOON CATHETER

2-Way Foley Balloon Catheter, Standard, 5-10 cc/ml:

REF. No.	Size	Balloon	Length	Description
1822-0512	12 FR			
1822-0514	14 FR			
1822-0516	16 FR			
1822-0518	18 FR	5-10 cc/ml	420 mm	X-ray opaque line Catheter spigot
1822-0520	20 FR			
1822-0522	22 FR			
1822-0524	24 FR			
1822-0526	26 FR			



1822-05XX

2-Way Foley Balloon Catheter, Standard, 20-30 cc/ml:

REF. No.	Size	Balloon	Length	Description
1823-0514	14 FR			
1823-0516	16 FR			
1823-0518	18 FR			
1823-0520	20 FR	20-30 cc/ml	420 mm	X-ray opaque line Catheter spigot
1823-0522	22 FR			
1823-0524	24 FR			
1823-0526	26 FR			



1823-05XX

2-Way Foley Balloon Catheter, Female:

REF. No.	Size	Balloon	Length	Description
1824-0512	12 FR			
1824-0514	14 FR			
1824-0516	16 FR			
1824-0518	18 FR	5-10 cc/ml	250 mm	X-ray opaque line Catheter spigot
1824-0520	20 FR			
1824-0522	22 FR			
1824-0524	24 FR			
1824-0526	26 FR			



1824-05XX

2-Way Foley Balloon Catheter, Tiemann Tip:

REF. No.	Size	Balloon	Length	Description
1856-0210	10FR	3-5 cc/ml		
1856-0212	12 FR			
1856-0214	14 FR			
1856-0216	16 FR	5-10 cc/ml	420 mm	Tiemann tip X-ray opaque line Catheter spigot
1856-0218	18 FR			
1856-0220	20 FR			
1856-0222	22 FR			
1856-0224	24 FR			



1856-02XX

Catheter Spigot:

REF. No.	Size	Description
1820-0000	Universal	ABS Sterilized packaging 50 pcs/box



1820-0000

SILICONE FOLEY BALLOON CATHETER

Fortune[®] Silicone 3-Way Foley Catheter Features:

- 100% medical grade silicone for superior biocompatibility.
- Transparent tube with X-ray opaque line.
- A soft and uniformly inflated balloon makes the tube sit well against the bladder.
- 3-Way design with an attached plug on the irrigation funnel.
- Tapered Central funnel could be connected with irrigation bags.
- Includes an individual sterilized packed Catheter Spigot.
- Sterilized double packaging.
- The tip of 3-way Foley Balloon Catheter with open hole, it could be used together with guide wire for difficulty in catheterization.

A Silicone 3-Way Foley Balloon



SPECIFICATIONS

3-Way Foley Balloon Catheter

REF. No.	Size	Balloon	Length	Description
1830-0514	14 FR			
1830-0516	16 FR			
1830-0518	18 FR			
1830-0520	20 FR	20-30 cc/ml	420 mm	Attached plug on flushing port X-ray opaque line Catheter spigot
1830-0522	22 FR			
1830-0524	24 FR			
1830-0526	26 FR			

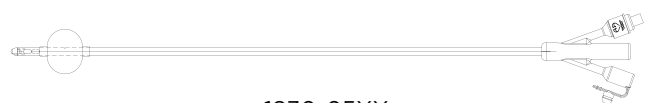

SILICONE FOLEY BALLOON CATHETER

Fortune® Foley Integrated Balloon Catheter:

Catheter with Integrated Balloon was designed to minimize the discomfort during catheterization procedure. Compare to the ordinary balloon, due to its thickness, creates a conjunction edge after adhered onto the tubing shaft. This conjunction edge between balloon and shaft will eventually increase patient discomfort during insertion and withdrawal.

Fortune® Integrated Balloon Catheter is invented to eliminate the uneven edge out of ordinary balloon. Patented balloon is integrated into the catheter shaft, creates “complete” smooth surface. No conjunction edge between balloon and shaft is formed, which minimizes the friction within the urethra and reduced patient discomfort. Recommended usage up to 90 days for 4833 series, of which balloon is more durable recommended usage up to 29 days for 4822/4856 series.

Advantages:

- Patented balloon integrated into the shaft.
- Complete smooth surface.
- Reduce friction within the urethra
- Reduce trauma and secondary harm.
- Reduce discomfort during insertion and withdrawal.
- Reduce accumulation of urine sediment.
- The 4833 series has been successfully passed the long-term balloon test, the balloon filled with 10cc sterile water performed no deflation or rupture after being immersed in the simulate urine for 90 days.

- A Silicone Foley Integrated Balloon Catheter**
- B Silicone Foley Integrated Balloon Catheter, Tiemann Tip**
- C Foley Integrated Balloon Catheter, Long-Term balloon**

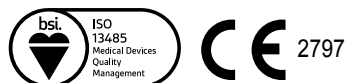
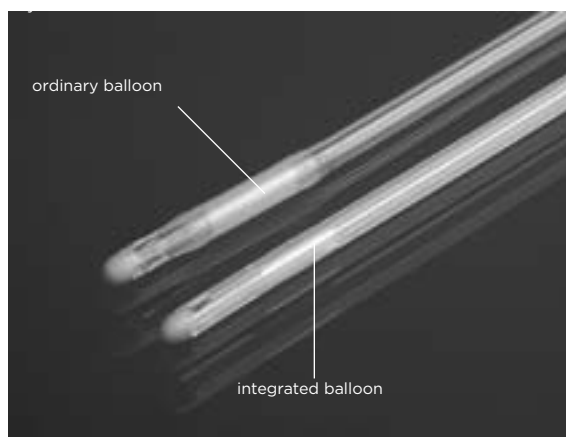

SILICONE FOLEY BALLOON CATHETER

SPECIFICATIONS

Foley Integrated Balloon Catheter:

REF. No.	Size	Balloon	Length	Description
4822-0512	12 FR			
4822-0514	14 FR			
4822-0516	16 FR			
4822-0518	18 FR	5-10 cc/ml	420 mm	Integrated balloon X-ray opaque line Catheter spigot
4822-0520	20 FR			
4822-0522	22 FR			
4822-0524	24 FR			
4822-0526	26 FR			



4822-05XX

Foley Integrated Balloon Catheter, Tiemann Tip:

REF. No.	Size	Balloon	Length	Description
4856-0212	12 FR			
4856-0214	14 FR			
4856-0216	16 FR			
4856-0218	18 FR	5-10 cc/ml	420 mm	Tiemann tip Integrated balloon X-ray opaque line Catheter spigot
4856-0220	20 FR			
4856-0222	22 FR			
4856-0224	24 FR			



4856-02XX

Foley Integrated Balloon Catheter, Long-Term balloon

REF. No.	Size	Balloon	Length	Description
4833-0512	12 FR			
4833-0514	14 FR			
4833-0516	16 FR			
4833-0518	18 FR	5-10 cc/ml	420 mm	Integrated , long term balloon X-ray opaque line Catheter spigot
4833-0520	20 FR			
4833-0522	22 FR			
4833-0524	24 FR			
4833-0526	26 FR			



4833-05XX

SILICONE FOLEY BALLOON CATHETER ,GROOVED

Fortune® Silicone 2 way Foley balloon grooved Catheter Features:

- 100% medical grade silicone for superior biocompatibility.
- Transparent medical grade silicone tube allows easy visual inspection and fluid observation.
- Grooved catheter was designed to minimize the discomfort during catheterization procedure. With ribs on outer profile of tubes, lubricity of catheter is increased, facilitating easy catheter removal.
- Soft and uniformly inflated balloon makes the tube sit well against the bladder.
- Includes an individual sterilized packed Catheter Spigot.
- Sterilized double packaging.

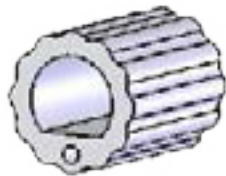

Grooved Tube

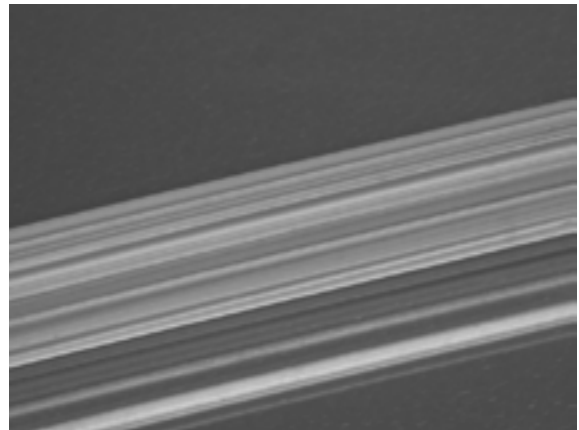
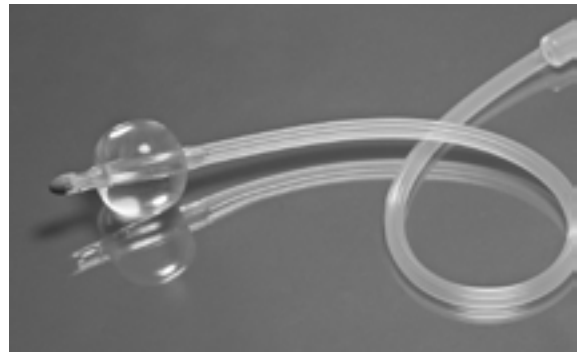

SPECIFICATIONS

Silicone 2-way Foley balloon catheter, grooved tube

REF. No.	Size	Balloon	Length	Description
1827-0012	12 FR			
1827-0014	14 FR			
1827-0016	16 FR			
1827-0018	18 FR	5-10 cc/ml	420 mm	grooved tube, Catheter spigot
1827-0020	20 FR			
1827-0022	22 FR			
1827-0024	24 FR			

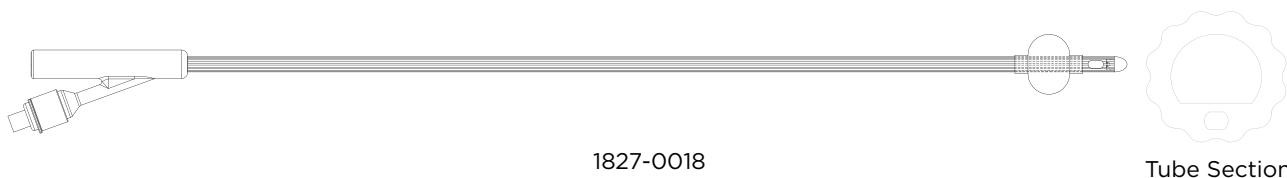

1827-0018

Tube Section



REGISTRUL DE STAT AL DISPOZITIVELOR MEDICALE

Nr	Denumire	Den.comerc.	Model	Nr. catalog	Tara	Producatorul	Reprezentant	Ordin	Data
<input type="text"/>	<input type="text"/>	<input type="text"/>	<input type="text"/>	<input type="text"/>	<input type="text"/>	fortune	eric	<input type="text"/>	<input type="text"/>
DM000283984	CATETER URINAR		1862		Taiwan	FORTUNE MEDICAL INSTRUMENT CORP.	ERICON S.R.L.	Rg04-000017	29-01-2021
DM000283986	CATETER URINAR		1864		Taiwan	FORTUNE MEDICAL INSTRUMENT CORP.	ERICON S.R.L.	Rg04-000017	29-01-2021
DM000283955	CANULĂ NAZALĂ		3102-2010		Taiwan	FORTUNE MEDICAL INSTRUMENT CORP.	ERICON S.R.L.	Rg04-000017	29-01-2021
DM000283983	CATETER URINAR		1861		Taiwan	FORTUNE MEDICAL INSTRUMENT CORP.	ERICON S.R.L.	Rg04-000017	29-01-2021
DM000283987	CATETER URINAR		1865		Taiwan	FORTUNE MEDICAL INSTRUMENT CORP.	ERICON S.R.L.	Rg04-000017	29-01-2021
DM000283985	CATETER URINAR		1863		Taiwan	FORTUNE MEDICAL INSTRUMENT CORP.	ERICON S.R.L.	Rg04-000017	29-01-2021
DM000283956	CANULĂ NAZALĂ		3103-0930		Taiwan	FORTUNE MEDICAL INSTRUMENT CORP.	ERICON S.R.L.	Rg04-000017	29-01-2021
DM000283954	CANULĂ NAZALĂ		3101-0830		Taiwan	FORTUNE MEDICAL INSTRUMENT CORP.	ERICON S.R.L.	Rg04-000017	29-01-2021



Содержит([Producatorul], 'fortune') И Содержит([Reprezentant], 'eric')

DECLARATION OF CONFORMITY

MANUFACTURER:

FORTUNE MEDICAL INSTRUMENT CORP.

6FL., NO. 29, SEC. 2, JHONGJHENG E. RD., DANSHUEI DIST., NEW TAIPEI CITY 251, TAIWAN
(FACTORY) NO. 256, CHANGCHUN 2ND RD., JHONGLI DIST, TAOYUAN CITY 320, TAIWAN

Single registration number (SRN):N/A

EUROPEAN REPRESENTATIVE:

Emergo Europe

Prinsessegracht 20, 2514 AP The Hague, The Netherlands

Tel: (31) (0) 70 345-8570

Single registration number (SRN): NL-AR-000000116

PRODUCT NAME: Silicone Thoracic Drain Tube
NO. OF PRODUCT: 2018 series
CLASSIFICATION: Class IIa, Rule 7
(According to Annex IX of the MDD)
GMDN CODE: 11308
Basic UDI-DI: 471096193040201FV

WE HERewith DECLARE THAT THE ABOVE MENTIONED PRODUCTS MEET THE PROVISIONS OF THE COUNCIL DIRECTIVE 93/42/EEC FOR MEDICAL DEVICES. ALL SUPPORTING DOCUMENTATION IS RETAINED UNDER THE PREMISES OF THE MANUFACTURER.

STANDARDS APPLIED:

MDD 93/42/EEC(INCLUDING 2007/47/EC), EN ISO 13485:2016, ISO 10993-1:2018, EN ISO 10993-3:2014, EN ISO 10993-5:2009, EN ISO 10993-6:2016, EN ISO 10993-10:2013, EN ISO 10993-11:2018, EN ISO 15223-1:2016 , EN ISO 11135:2014, EN ISO 11607-1:2020, EN ISO 11607-2:2020, BS EN ISO 20697:2018, BS EN ISO 14644-1&2:2015, EN ISO 14971:2019

COMMON SPECIFICATION(CS): N/A

NOTIFIED BODY:

BSI Netherlands NB (2797)

Say Building, John M. Keynesplein 9, 1066 EP Amsterdam, The Netherlands

CONFORMITY ASSESSMENT ROUTE: Annex II excluding section 4

(EC) CERTIFICATE: CE 588902

START OF CE MARKING: December 16, 1998

SIGNATURE: CHEW, MING HONG

FUNCTION: Person responsible for regulatory compliance

PLACE AND DATE OF ISSUE: Taiwan, May 26, 2021

DECLARATION OF CONFORMITY

MANUFACTURER:

FORTUNE MEDICAL INSTRUMENT CORP.

6FL., NO. 29, SEC. 2, JHONGJHENG E. RD., DANSHUEI DIST., NEW TAIPEI CITY 251, TAIWAN

(FACTORY) NO. 256, CHANGCHUN 2ND RD., JHONGLI DIST, TAOYUAN CITY 320, TAIWAN

Single registration number (SRN):N/A

EUROPEAN REPRESENTATIVE:

Emergo Europe

Prinsessegracht 20, 2514 AP The Hague, The Netherlands

Tel: (31) (0) 70 345-8570

Single registration number (SRN): NL-AR-000000116

PRODUCT NAME: Silicone Endotracheal Tube

NO. OF PRODUCT: 1510, 1520, 1525, 1530, 1535, 1540, 1545, 1550, 1555 series

CLASSIFICATION: Class IIa, Rule 5 (According to Annex IX of the MDD)

GMDN CODE: 46967

Basic UDI-DI: 471096193070501HD

WE HEREWITH DECLARE THAT THE ABOVE MENTIONED PRODUCTS MEET THE PROVISIONS OF THE COUNCIL DIRECTIVE 93/42/EEC FOR MEDICAL DEVICES. ALL SUPPORTING DOCUMENTATION IS RETAINED UNDER THE PREMISES OF THE MANUFACTURER.

STANDARDS APPLIED:

MDD 93/42/EEC(INCLUDING 2007/47/EC), EN ISO 13485:2016, ISO 10993-1:2018, EN ISO 10993-5:2009, EN ISO 10993-10:2013, EN ISO 15223-1:2016, EN 1041:2008, EN ISO 11135:2014, EN ISO 11607-1:2020, EN ISO 11607-2:2020, BS EN ISO 14644-1&2:2015, EN ISO 14971:2019, EN ISO 5361:2016

COMMON SPECIFICATION(CS): N/A

NOTIFIED BODY:

BSI Netherlands NB (2797)

Say Building, John M. Keynesplein 9, 1066 EP Amsterdam, The Netherlands

CONFORMITY ASSESSMENT ROUTE: Annex II excluding section 4

(EC) CERTIFICATE: CE 588902

START OF CE MARKING: October 5, 2018

SIGNATURE: CHEN, MING HONG

FUNCTION: Person responsible for regulatory compliance

PLACE AND DATE OF ISSUE: Taiwan, May 26, 2021

EC Certificate - Full Quality Assurance System

Directive 93/42/EEC on Medical Devices, Annex II excluding Section 4

No. CE 588902
Issued To: **Fortune Medical Instrument Corp**
6F., No. 29, Sec. 2, Jhongjheng E.Rd.,
Danshuei Dist,
New Taipei City
251
Taiwan

In respect of:

The design, manufacture and final inspection of sterile urological catheter sets, drainage tube sets, endotracheal tube, tracheostomy tube, gastrointestinal tubes, silicone surgical ruler and silicone vessel ID loops;

The design, manufacture and final inspection of non-sterile birth-vac cup, laryngeal mask tube and manual resuscitator sets.

Those aspects concerned with securing and maintaining sterile conditions in the manufacture of closed wound vacuum reservoir, collection bag and endo connector.

on the basis of our examination of the quality assurance system under the requirements of Council Directive 93/42/EEC, Annex II excluding section 4. The quality assurance system meets the requirements of the directive. For the placing on the market of class III products an Annex II section 4 certificate is required.

For and on behalf of BSI, a Notified Body for the above Directive (Notified Body Number 2797):



Gary E Slack, Senior Vice President Medical Devices

First Issued: **2012-08-27**

Date: **2021-02-24**

Expiry Date: **2023-09-24**

...making excellence a habit.™

Page 1 of 4

Validity of this certificate is conditional on the quality system being maintained to the requirements of the Directive as demonstrated through the required surveillance activities of the Notified Body. This approval excludes all products designed and/or manufactured by a third party on behalf of the company named on this certificate, unless specifically agreed with BSI.

This certificate was issued electronically and is bound by the conditions of the contract.

EC Certificate - Full Quality Assurance System

Supplementary Information to CE 588902

Issued To:

Fortune Medical Instrument Corp
6F., No. 29, Sec. 2, Jhongjheng E.Rd.,
Danshuei Dist,
New Taipei City
251
Taiwan

Number	Device name	Intended purpose
Class IIb - Sterile		
GMDN 34917	Silicone 2-way Foley Catheter with Integrated Long-Term balloon	Used for drainage of urine from the bladder for up to 90 days.
GMDN 34917	Silicone 2-Way Foley Balloon Catheter (with/without groove)	Used for drainage of urine from the bladder for up to 29 days (with subsequent continuous long-term use).
GMDN 34917	Silicone 3-Way Foley Balloon Catheter	Used for drainage of urine from the bladder for up to 29 days (with subsequent continuous long-term use) and to inject water via an irrigation funnel for flushing the bladder.
GMDM 34930	Silicone 3-Way Hematuria Catheter	Used for the drainage of urine from the bladder after prostatectomy and to irrigate the bladder post-surgery for flushing of blood clots/other debris from bladder.
GMDN 34917	Silicone Foley Catheter with Rigid Guide	Used to assist in the percutaneous insertion of catheter and drainage when indicated and in TVT surgery. Used for urethral length measurement.
GMDN 10735	Silicone Nephrostomy Catheter	Used for the drainage of urine from the kidney. It is inserted through the skin into the kidney.
GMDN 34924	Silicone Supra-Pubic Catheter	Used for the drainage of urine from the bladder. It is inserted through a suprapubic incision directly into the bladder.
GMDN 34924	Supra-Pubic Catheter Puncture Set (consisting of catheter, split cannula, clamp & spigot)	Used to gain a percutaneous suprapubic access via the lower abdominal wall, to the urinary bladder for placement of supra-pubic catheter.

First Issued: **2012-08-27**

Date: **2021-02-24**

Expiry Date: **2023-09-24**

...making excellence a habit.™

Page 2 of 4

Validity of this certificate is conditional on the quality system being maintained to the requirements of the Directive as demonstrated through the required surveillance activities of the Notified Body. This approval excludes all products designed and/or manufactured by a third party on behalf of the company named on this certificate, unless specifically agreed with BSI.

This certificate was issued electronically and is bound by the conditions of the contract.

Information and Contact: BSI, Say Building, John M. Keynesplein 9, 1066 EP Amsterdam, The Netherlands Tel: + 31 20 346 0780

BSI Group The Netherlands B.V. registered in The Netherlands under 33264284.

A member of BSI Group of Companies.

EC Certificate - Full Quality Assurance System

Supplementary Information to CE 588902

Issued To:

Fortune Medical Instrument Corp
6F., No. 29, Sec. 2, Jhongjheng E.Rd.,
Danshuei Dist,
New Taipei City
251
Taiwan

Number	Device name	Intended purpose
GMDN 34924	Supra-Pubic Catheter Exchange Set (catheter, guidewire, clamp & spigot)	Used for the drainage of urine from the bladder. It is inserted through a suprapubic incision directly into the bladder.
GMDN 35404	Silicone Tracheostomy Tube	Placed into a surgical created opening of the trachea to facilitate ventilation to the lungs.
GMDM 14221	Silicone Stomach (Gastric) Tube	Used for nasogastric nutritional supplementation to stomach.
GMDM 35419	Silicone Gastrostomy Catheter	Used for long-term enteral feeding. Introduced via a surgically created opening.
Class IIa - Sterile		
MD 0106	Wound Drainage Trocars	N/A
MD 0106	Silicone Drains, Drain Kits and Drain Sets	
MD 0106	Silicone Closed Wound Vacuum Drain Systems & Drain Bag Systems	
MD 0106	Silicone Endo/Hubless Endo Drains and Kits	
MD 0106	Silicone T, Y & T-Y Drains	
MD 0106	Silicone Penrose Drain Tubes	
MD 0106	Silicone Sump Drain Tube & Foley Sump Drain Tube	
MD 0106	Silicone Thoracic Drain Tubes	
MD 0106	Silicone Vessel ID Loops	

First Issued: **2012-08-27**

Date: **2021-02-24**

Expiry Date: **2023-09-24**

...making excellence a habit.™

Page 3 of 4

Validity of this certificate is conditional on the quality system being maintained to the requirements of the Directive as demonstrated through the required surveillance activities of the Notified Body. This approval excludes all products designed and/or manufactured by a third party on behalf of the company named on this certificate, unless specifically agreed with BSI.
 This certificate was issued electronically and is bound by the conditions of the contract.

EC Certificate - Full Quality Assurance System

Supplementary Information to CE 588902

Issued To:

**Fortune Medical Instrument Corp
6F., No. 29, Sec. 2, Jhongjheng E.Rd.,
Danshuei Dist,
New Taipei City
251
Taiwan**

Number	Device name	Intended purpose
MD 0106	Silicone Surgical Ruler	N/A
MD 0106	Silicone Gastroplasty Calibration Tube	
MD 0101	Silicone Endotracheal Tube	
Class IIa – Non-Sterile		
MD 0106	Single Use Laryngeal Mask Tube	N/A
MD 0101	Single Use Manual Resuscitator Sets containing Single Use Accessories: PVC Resuscitator, Silicone Resuscitator, Sil-Crush Mask, PVC Air-Crush Mask, Silicone Mask, Oxygen Reservoir and Reservoir Valve, Oxygen Tubing, Patient Valve, PEEP Valve & PEEP Valve Diverter	
MD 0106	Reusable Birth-Vac Cup	
Class I - Sterile		
MD 0106	Silicone Closed Wound Vacuum Reservoir	N/A
MD 0106	Collection Bag	
MD 0106	Endo Connector	

First Issued: **2012-08-27**

Date: **2021-02-24**

Expiry Date: **2023-09-24**

...making excellence a habit.™

Page 4 of 4

Validity of this certificate is conditional on the quality system being maintained to the requirements of the Directive as demonstrated through the required surveillance activities of the Notified Body. This approval excludes all products designed and/or manufactured by a third party on behalf of the company named on this certificate, unless specifically agreed with BSI.

This certificate was issued electronically and is bound by the conditions of the contract.

Information and Contact: BSI, Say Building, John M. Keynesplein 9, 1066 EP Amsterdam, The Netherlands Tel: + 31 20 346 0780

BSI Group The Netherlands B.V. registered in The Netherlands under 33264284.

A member of BSI Group of Companies.

EC Certificate - Full Quality Assurance System

Directive 93/42/EEC on Medical Devices, Annex II excluding Section 4

List of Significant Subcontractors

Recognised as being involved in services relating to the product covered by:

Certificate No: **CE 588902**
 Date: **2021-02-24**
 Issued To: **Fortune Medical Instrument Corp**
6F., No. 29, Sec. 2, Jhongjheng E.Rd.,
Danshuei Dist,
New Taipei City
251
Taiwan

Subcontractor:

Service(s) supplied

Emergo Europe
 Prinsessegracht 20
 2514 AP
 The Hague
 The Netherlands

EU Representative

Fortune Medical Instrument Corp
 No. 256, Changchun 2nd Road
 Jhongli Dist
 Taoyuan City 320
 Taiwan

Design
ETO Sterilization
Final Inspection
Manufacture
Regulatory Compliance

...making excellence a habit.™

EC Certificate - Full Quality Assurance System Certificate History

Certificate No: **CE 588902**
 Date: **2021-02-24**
 Issued To: **Fortune Medical Instrument Corp
 6F., No. 29, Sec. 2, Jhongjheng E.Rd.,
 Danshuei Dist,
 New Taipei City
 251
 Taiwan**

Date	Reference Number	Action
27 August 2012	7859139	First issue. Transfer from another Notified Body, TÜV SÜD, certificate reference G1 11 06 65095 006.
01 October 2013	8063652	Certificate renewal.
05 October 2018	9642053	Amendment to scope to add in "and accessories" for sterile urological catheters, "and accessories" for sterile drainage tube, addition of sterile Silicone surgical ruler, sterile Silicone vessel ID loops. Administrative changes to the address for the head office and the subcontractor, Fortune Medical Instrument Corp, No 256, Changchun 2nd Road. Removal of vacuum suction and resuscitator. Certificate renewal.
25 February 2019	7932553	Traceable to NB 0086.

...making excellence a habit.™

Validity of this certificate is conditional on the quality system being maintained to the requirements of the Directive as demonstrated through the required surveillance activities of the Notified Body. This approval excludes all products designed and/or manufactured by a third party on behalf of the company named on this certificate, unless specifically agreed with BSI.
 This certificate was issued electronically and is bound by the conditions of the contract.

EC Certificate - Full Quality Assurance System Certificate History

Certificate No: **CE 588902**
 Date: **2021-02-24**
 Issued To: **Fortune Medical Instrument Corp
 6F., No. 29, Sec. 2, Jhongjheng E.Rd.,
 Danshuei Dist,
 New Taipei City
 251
 Taiwan**

Date	Reference Number	Action
24 February 2021	9788667	Amendment to scope to add "non-sterile birth-vac cup" and "non-sterile manual resuscitator sets" Clarification of certificate scope to replace the term "and accessories" with "sets" with full definition of sets provided in supplementary device table Reformatting of certificate scope to separate list of sterile and non-sterile devices Reformatting of certificate scope to list Class Is accessories separately (closed wound vacuum reservoir, collection bag & endo connector) Administrative change to address for EU Representative Administrative addition of supplementary device table Clarification of Class IIa Non-Sterile devices as either reusable or single use in supplementary device table.
Non-significant changes approved after the 26th May 2021 as per the Transitional Provisions of MDR Article 120.3		
30 November 2021	3483419	Addition of EU Representative, Emergo Europe and removal of EU Representative, PRIM S.A.

...making excellence a habit.™

Page 2 of 2

Validity of this certificate is conditional on the quality system being maintained to the requirements of the Directive as demonstrated through the required surveillance activities of the Notified Body. This approval excludes all products designed and/or manufactured by a third party on behalf of the company named on this certificate, unless specifically agreed with BSI.
 This certificate was issued electronically and is bound by the conditions of the contract.

30 November 2021

Fortune Medical Instrument Corp
6F, No. 29, Sec. 2, Jhongjheng E.Rd.,
Danshuei Dist,
New Taipei City
251
Taiwan

To whom it may concern,

The transitional provisions specified in MDR Article 120(3) prohibit Notified Bodies from issuing new certificates or amending, modifying, supplementing any existing MDD/AIMDD certificates from 26th May 2021.

This letter is to confirm that BSI has reviewed and approved the change(s) detailed in the table below. These changes do not represent a significant change in design or intended purpose under MDR Article 120(3) and as per the guidance provided in MDCG 2020-3. The related MDD certificate specified below remains valid until the expiry date specified on the certificate.

Certificate	Directive and Annex	Reference Number	Changes approved
CE 588902	93/42/EEC Annex II excluding Section 4	3483419	Addition of EU Representative, Emergo Europe and removal of EU Representative, PRIM S.A.

Should you have any queries concerning your certification, or if we can be of further assistance to you, please contact your BSI Scheme Manager.

Yours sincerely,



Gary Slack
Senior Vice President, Medical Devices

DECLARATION OF CONFORMITY

MANUFACTURER:

FORTUNE MEDICAL INSTRUMENT CORP.

6FL., NO. 29, SEC. 2, JHONGJHENG E. RD., DANSHUEI DIST., NEW TAIPEI CITY 251, TAIWAN

(FACTORY) NO. 256, CHANGCHUN 2ND RD., JHONGLI DIST, TAOYUAN CITY 320, TAIWAN

Single registration number (SRN):N/A

EUROPEAN REPRESENTATIVE:

Emergo Europe

Prinsessegracht 20, 2514 AP The Hague, The Netherlands

Tel: (31) (0) 70 345-8570

Single registration number (SRN): NL-AR-000000116

PRODUCT NAME: Silicone Endotracheal Tube

NO. OF PRODUCT: 1510, 1520, 1525, 1530, 1535, 1540, 1545, 1550, 1555 series

CLASSIFICATION: Class IIa, Rule 5 (According to Annex IX of the MDD)

GMDN CODE: 46967

Basic UDI-DI: 471096193070501HD

WE HEREWITH DECLARE THAT THE ABOVE MENTIONED PRODUCTS MEET THE PROVISIONS OF THE COUNCIL DIRECTIVE 93/42/EEC FOR MEDICAL DEVICES. ALL SUPPORTING DOCUMENTATION IS RETAINED UNDER THE PREMISES OF THE MANUFACTURER.

STANDARDS APPLIED:

MDD 93/42/EEC(INCLUDING 2007/47/EC), EN ISO 13485:2016, ISO 10993-1:2018, EN ISO 10993-5:2009, EN ISO 10993-10:2013, EN ISO 15223-1:2016, EN 1041:2008, EN ISO 11135:2014, EN ISO 11607-1:2020, EN ISO 11607-2:2020, BS EN ISO 14644-1&2:2015, EN ISO 14971:2019, EN ISO 5361:2016

COMMON SPECIFICATION(CS): N/A

NOTIFIED BODY:

BSI Netherlands NB (2797)

Say Building, John M. Keynesplein 9, 1066 EP Amsterdam, The Netherlands

CONFORMITY ASSESSMENT ROUTE: Annex II excluding section 4

(EC) CERTIFICATE: CE 588902

START OF CE MARKING: October 5, 2018

SIGNATURE: CHEN, MING HONG

FUNCTION: Person responsible for regulatory compliance

PLACE AND DATE OF ISSUE: Taiwan, May 26, 2021

DECLARATION OF CONFORMITY

MANUFACTURER:

FORTUNE MEDICAL INSTRUMENT CORP.
6FL., NO. 29, SEC. 2, JHONGJHENG E. RD., DANSHUEI DIST., NEW TAIPEI CITY 251, TAIWAN
(FACTORY) NO. 256, CHANGCHUN 2ND RD., JHONGLI DIST, TAOYUAN CITY 320, TAIWAN
Single registration number (SRN):N/A

EUROPEAN REPRESENTATIVE:

Emergo Europe
Prinsessegracht 20, 2514 AP The Hague, The Netherlands
Tel: (31) (0) 70 345-8570
Single registration number (SRN): NL-AR-000000116

PRODUCT NAME: Silicone Thoracic Drain Tube
NO. OF PRODUCT: 2018 series
CLASSIFICATION: Class IIa, Rule 7
(According to Annex IX of the MDD)
GMDN CODE: 11308
Basic UDI-DI: 471096193040201FV

WE HERewith DECLARE THAT THE ABOVE MENTIONED PRODUCTS MEET THE PROVISIONS OF THE COUNCIL DIRECTIVE 93/42/EEC FOR MEDICAL DEVICES. ALL SUPPORTING DOCUMENTATION IS RETAINED UNDER THE PREMISES OF THE MANUFACTURER.

STANDARDS APPLIED:

MDD 93/42/EEC(INCLUDING 2007/47/EC), EN ISO 13485:2016, ISO 10993-1:2018, EN ISO 10993-3:2014, EN ISO 10993-5:2009, EN ISO 10993-6:2016, EN ISO 10993-10:2013, EN ISO 10993-11:2018, EN ISO 15223-1:2016 , EN ISO 11135:2014, EN ISO 11607-1:2020, EN ISO 11607-2:2020, BS EN ISO 20697:2018, BS EN ISO 14644-1&2:2015, EN ISO 14971:2019

COMMON SPECIFICATION(CS): N/A

NOTIFIED BODY:

BSI Netherlands NB (2797)
Say Building, John M. Keynesplein 9, 1066 EP Amsterdam, The Netherlands

CONFORMITY ASSESSMENT ROUTE: Annex II excluding section 4

(EC) CERTIFICATE: CE 588902

START OF CE MARKING: December 16, 1998

SIGNATURE: CHEW, MING HONG

FUNCTION: Person responsible for regulatory compliance

PLACE AND DATE OF ISSUE: Taiwan, May 26, 2021