



# AESCULAP® POWER SYSTEMS

CATALOG 2022

ELAN 4 and Acculan 4



# CONTENT

---

## ELAN 4

- ELAN 4 electro
  - ELAN 4 Accessories
- 

## Acculan 4

- Acculan 4 & Acculan 4 Small Drill
  - Acculan 4 Electro
  - Acculan 4 Accessories
- 

## PROCESSING

- Sterilit® Power Systems
  - Processing
- 

## OTHERS

- Tool Attachments Overview
  - Signs & Symbols
  - Brochures
  - Index
-





# AESCLAP® ELAN 4

PRECISION. PERFORMANCE. PLEASURE.

With its technical concept ELAN 4 addresses important requirements of the surgeon and all parties involved in handling power systems in the hospital.

- Convenient and reliable grip
- Powerful, precise and reliable work
- Easy to set up and simple to use



# AESCLAP® ELAN 4

ELAN 4 electro

ELECTRIC HIGHSPEED SYSTEM



## ELAN 4 electro BASIC COMPONENTS

### GA800

#### ELAN 4 electro CONTROL UNIT

with irrigation pump; touch screen;  
power cord not included  
pump flow 0 - 65 ml/min

100 - 240 V AC; 50/60 Hz;  
380 x 330 x 200 mm; 9,500 g

consisting parts:  
GD412804 bottle holder

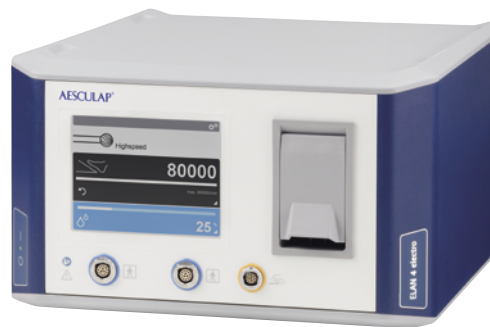

### GA808

#### ELAN 4 electro FOOT CONTROL

protection type IPX8; anaesthetic  
proof class AP

5.0 m;  
245 x 144 x 76 mm; 2,240 g



### GA810

#### ELAN 4 electro WIRELESS FOOT CONTROL

protection type IPX8; anaesthetic  
proof class AP

271 x 266 x 85 mm; 3,800 g

Requires control unit with software  
version V3.00.



### GA806

GB073R

#### ELAN 4 electro MOTOR CABLE

for use with ELAN 4 electro applied  
parts

4.0 m; 270 g

consisting parts:  
GB600860 Sterilit® spray adapter  
ELAN 4 electro



# AESCULAP® ELAN 4

## ELAN 4 electro

### BASIC COMPONENTS, PERFORATOR DRIVER & LOWSPEED MOTOR

**GA804**

**GB073R**

#### ELAN 4 electro MOTOR CABLE WITH HAND SWITCH

for use with ELAN 4 electro applied parts

4.0 m; 374 g

consisting parts:  
GB600860 Sterilit® spray adapter  
ELAN 4 electro



**GA805**

**GB073R**

#### ELAN 4 electro MOTOR CABLE WITH HAND CONTROL

for use with ELAN 4 electro applied parts

4.0 m; 369 g

consisting parts:  
GB600860 Sterilit® spray adapter  
ELAN 4 electro



**GA822**

**GB076R**

#### ELAN 4 electro PERFORATOR DRIVER

for use with cranial perforators with Hudson shank

180 W; 0 - 1,200 rpm; 250 Ncm;  
166 x 35 mm; 410 g



**GA824**

**GB077R**

#### ELAN 4 electro LOWSPEED MOTOR

with intra coupling

180 W; 0 - 40,000\* rpm;  
10 Ncm; 123 x 23 mm; 150 g

\* Requires control unit with software version V3.00. With lower versions the motor runs max. 20,000 rpm.





## ELAN 4 electro CRANIOTOME & ATTACHMENTS

**GA849**

**GB085R**

### ELAN 4 electro CRANIOTOME AND MULTIFUNCTION HANDPIECE

2-ring coding; for use with  
dura guards and holding sleeves  
GB941R - GB947R; spray nozzle  
GA259SU (not included)

140 W; ↻ ↺; 0 - 80,000 rpm; 2.2 Ncm;  
156 x 17 mm; 📖 121 g



**GB941R**

**GB719R**

### ELAN 4 DURA GUARD PEDIATRIC

fixed; 1 dot coding;  
for craniotome and multifunction  
handpieces GA749, GA849

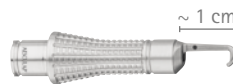

**GB942R**

**GB719R**

### ELAN 4 DURA GUARD STANDARD

fixed; 2 dot coding;  
for craniotome and multifunction  
handpieces GA749, GA849



**GB943R**

**GB719R**

### ELAN 4 DURA GUARD LONG

fixed; 3 dot coding;  
for craniotome and multifunction  
handpieces GA749, GA849



**GB945R**

**GB719R**

### ELAN 4 HOLDING SLEEVE

for craniotome and multifunction  
handpieces GA749, GA849



**GB947R**

**GB719R**

### ELAN 4 DURA GUARD STANDARD

turnable; 2 dot coding;  
for craniotome and multifunction  
handpieces GA749, GA849



# AESCULAP® ELAN 4

## ELAN 4 electro

### 1-RING HIGHSPEED HANDPIECES

**GA861**

**GB083R**

ELAN 4 electro 1-RING HANDPIECE  
L4

1-ring coding;  
spray nozzle GA261SU (not included)  
140 W; ↗ ↘; 0 - 80,000 rpm; 2.2 Ncm;  
152 x 16 mm; 80 g



**GA862**

**GB083R**

ELAN 4 electro 1-RING HANDPIECE  
L7

1-ring coding;  
spray nozzle GA262SU (not included)  
140 W; ↗ ↘; 0 - 80,000 rpm; 2.2 Ncm;  
177 x 16 mm; 83 g



**GA863**

**GB083R**

ELAN 4 electro 1-RING HANDPIECE  
L10

1-ring coding;  
spray nozzle GA263SU (not included)  
140 W; ↗ ↘; 0 - 80,000 rpm; 2.2 Ncm;  
206 x 16 mm; 87 g



**GA864**

**GB083R**

ELAN 4 electro 1-RING HANDPIECE  
L13

1-ring coding;  
spray nozzle GA264SU (not included)  
140 W; ↗ ↘; 0 - 80,000 rpm; 2.2 Ncm;  
237 x 16 mm; 91 g





## ELAN 4 electro 2-RING HIGH SPEED HANDPIECES

**GA865**

**GB083R**

ELAN 4 electro 2-RING HANDPIECE  
L7



2-ring coding;  
spray nozzle GA265SU (not included)  
140 W;  ; 0-80,000 rpm; 2.2 Ncm;  
176 x 16 mm;  89 g



**GA866**

**GB083R**

ELAN 4 electro 2-RING HANDPIECE  
L10



2-ring coding;  
spray nozzle GA266SU (not included)  
140 W;  ; 0-80,000 rpm; 2.2 Ncm;  
206 x 16 mm;  95 g



**GA867**

**GB083R**

ELAN 4 electro 2-RING HANDPIECE  
L13

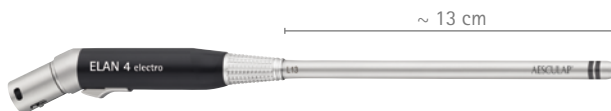

2-ring coding;  
spray nozzle GA267SU (not included)  
140 W;  ; 0-80,000 rpm; 2.2 Ncm;  
236 x 16 mm;  100 g



**GA868**

**GB083R**

ELAN 4 electro 2-RING HANDPIECE  
L17



2-ring coding;  
spray nozzle GA268SU (not included)  
140 W;  ; 0-80,000 rpm; 2.2 Ncm;  
276 x 16 mm;  108 g



**GA869**

**GB083R**

ELAN 4 electro 2-RING HANDPIECE  
L22

2-ring coding;  
spray nozzle GA269SU (not included)  
140 W;  ; 0-80,000 rpm; 2.2 Ncm;  
326 x 16 mm;  118 g



# AESCULAP® ELAN 4

ELAN 4 electro

MIS HANDPIECE & HANDPIECE SHAFTS





**GA860**

**GB084R**

**ELAN 4 electro MIS HANDPIECE**

for use with MIS handpiece shafts  
GB920R - GB927R

140 W; ↖ ↗; 0 - 80,000 rpm;  
2.2 Ncm; 118 x 17 mm; 100 g



**GB920R**

**GB723R**

**ELAN 4 MIS HANDPIECE SHAFT  
L10 STRAIGHT**

spray nozzle GB796SU (not included)



**GB921R**

**GB723R**

**ELAN 4 MIS HANDPIECE SHAFT  
L10 CURVED**

spray nozzle GB796SU (not included)



**GB922R**

**GB723R**

**ELAN 4 MIS HANDPIECE SHAFT  
L10 HEAVY CURVED**

spray nozzle GB796SU (not included)



**GB925R**

**GB723R**

**ELAN 4 MIS HANDPIECE SHAFT  
L13 STRAIGHT**

spray nozzle GB797SU (not included)



**GB926R**

**GB723R**

**ELAN 4 MIS HANDPIECE SHAFT  
L13 CURVED**

spray nozzle GB797SU (not included)



**GB927R**

**GB723R**

**ELAN 4 MIS HANDPIECE SHAFT  
L13 HEAVY CURVED**

spray nozzle GB797SU (not included)

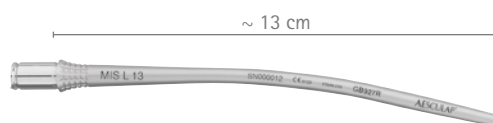

# AESCLAP<sup>®</sup> ELAN 4

ELAN 4 electro

SAWS



**GA836**

**GB086R**

ELAN 4 electro MICRO SAGITTAL SAW  
spray nozzle GA258SU (not included)  
180 W; 0 - 20,000 rpm; 161 x 23 mm;  
 $\sphericalangle$  7°;  $\updownarrow$  190 g

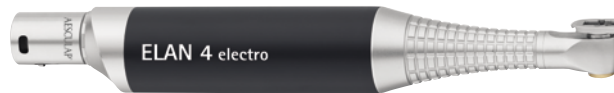

**GA837**

**GB087R**

ELAN 4 electro  
MICRO RECIPROCATING SAW  
spray nozzle GA258SU (not included)  
180 W; 0 - 20,000 rpm; 184 x 23 mm;  
 $\updownarrow$  1.3 mm;  $\updownarrow$  198 g



**GA831**

**GB088R**

ELAN 4 electro SAGITTAL SAW  
spray nozzle GA258SU (not included)  
180 W; 0 - 20,000 rpm; 129 x 23 mm;  
 $\sphericalangle$  4.5°;  $\updownarrow$  220 g



**GA832**

**GB087R**

ELAN 4 electro RECIPROCATING SAW  
spray nozzle GA258SU (not included)  
180 W; 0 - 20,000 rpm; 194 x 23 mm;  
 $\updownarrow$  2.5 mm;  $\updownarrow$  238 g



**GA833**

**GB088R**

ELAN 4 electro TRANSVERSAL SAW  
spray nozzle GA258SU (not included)  
180 W;  $\sphericalangle$   $\sphericalangle$ ; 0 - 20,000 rpm; 10 Ncm;  
130 x 23 mm;  $\sphericalangle$  10°;  $\updownarrow$  185 g  
to be used with saw blade shafts  
GP580R, GP582R, GP586R and GP590R

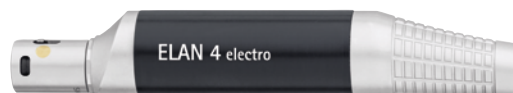

# AESCULAP® ELAN 4

ELAN 4 electro

DRILL





**GA844**

**GB482R**

**ELAN 4 electro DRILL**

with fixed motor cable, oscillating and tapping mode

200 W;  3.2 mm;  
122 x 130 x 27 mm;  800 g

consisting parts:

GA344244 K-wire protection guide

TA011944 cleaning brush

GA344211 rinsing adapter

GB600880 Sterilit® spray adapter

Requires control unit with software version V3.00.





**GB870R**

**GB716R**

**INTRAMEDULLARY REAMER ATTACHMENT**

with Jacobs chuck 0.5 - 7.4 mm, not for use with acetabulum reamers

0 - 320 rpm; 6.5 Nm;  3.2 mm;  
105 x 29 mm;  230 g

consisting parts:

key GA031R





**GB871R**

**GB716R**

**INTRAMEDULLARY REAMER ATTACHMENT**

with large AO chuck, not for use with acetabulum reamers

0 - 320 rpm; 6.5 Nm;  3.2 mm;  
88 x 29 mm;  170 g





**GB872R**

**GB716R**

**INTRAMEDULLARY REAMER ATTACHMENT**

with Hudson/Zimmer chuck, not for use with acetabulum reamers

0 - 320 rpm; 6.5 Nm;  3.2 mm;  
86 x 25 mm;  150 g



# AESFULAP® ELAN 4



## ELAN 4 electro ATTACHMENTS

**GB881R**

**GB716R**

### DRILL ATTACHMENT

with Jacobs chuck 0.5 - 7.4 mm

0 - 1,250 rpm; 2 Nm;  3.2 mm;  
89 x 29 mm;  163 g

consisting parts:  
key GA031R





**GB882R**

**GB716R**

### DRILL ATTACHMENT

with Jacobs chuck 0.5 - 4 mm

0 - 1,250 rpm; 2 Nm;  3.2 mm;  
76 x 22 mm;  100 g

consisting parts:  
key GA062R





**GB884R**

**GB716R**

### DRILL ATTACHMENT

with small AO chuck

0 - 1,250 rpm; 2 Nm;  2.8 mm;  
60 x 22 mm;  66 g





**GB886R**

**GB716R**

### DRILL ATTACHMENT

with AESFULAP® hexagonal chuck

0 - 1,250 rpm; 2 Nm;  3.2 mm;  
57 x 24 mm;  67 g





**GB887R**

**GB716R**

### DRILL ATTACHMENT

with Dental shank

0 - 1,250 rpm; 2 Nm;  1.8 mm;  
56 x 22 mm;  50 g



**GB878R**

**GB716R**

**DRILL ATTACHMENT**

for Synthes radiolucent drive 511.300

0 - 1,250 rpm; 2 Nm;  
111 x 27 mm; 181 g

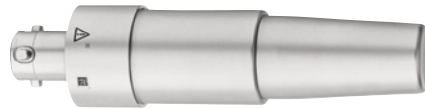

**GB894R**

**GB716R**

**K-WIRE ATTACHMENT**

for K-wires from 0.6 - 3.2 mm

0 - 1,250 rpm; 3.2 mm;  
92 x 27 x 124 mm; 179 g

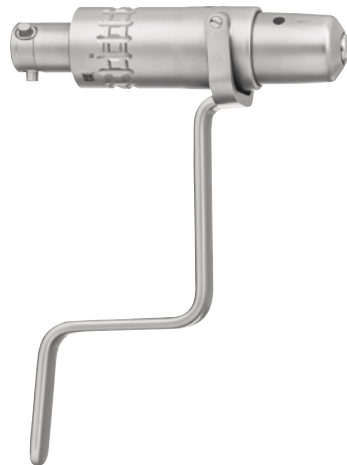

**GB891R**

**GB716R**

**SAGITTAL SAW ATTACHMENT**

for "L-sagittal" sawblades

0 - 15,750 rpm; 74 x 33.5 mm;  
4.5°; 179 g



**GB892R**

**GB716R**

**RECIPROCATING SAW ATTACHMENT**

for reciprocating sawblades

0 - 15,750 rpm; 135 x 24.5 mm;  
2.5 mm; 166 g



# AESCULAP® ELAN 4



ELAN 4 electro  
ATTACHMENTS

**GB896R**

**GB716R**

SCREW ATTACHMENT

with small AO chuck

0 - 165 rpm; 12 Nm;  1.7 mm;  
95 x 28 x 129.5 mm;  235 g





**GB897R**

**GB716R**

SCREW ATTACHMENT

with AESCULAP® hexagonal chuck

0 - 165 rpm; 12 Nm;  1.7 mm;  
92 x 28 x 129.5 mm;  231 g





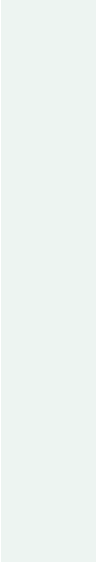

# AESCLAP® ELAN 4

## ELAN 4 ACCESSORIES

**GB861P**

**GB727R**

ELAN 4 LENGTH REDUCTION SLEEVE  
for use with 1-ring handpieces



**GB863P**

**GB727R**

ELAN 4 LENGTH REDUCTION SLEEVE  
for use with 2-ring handpieces



**GB862P**

**GB727R**

ELAN 4 MIS SLEEVE  
for use with 1-ring handpieces



**GB866R**

ELAN 4 LATERAL BURR GUARD  
for use with 1-ring handpieces and  
burrs up to 4.5 mm diameter



**TE780**

POWER CORD  
Europe,  1.5 m

**TE730**

POWER CORD  
Europe,  5.0 m

**TE734**

POWER CORD  
UK,  5.0 m

**TE735**

POWER CORD  
USA, Canada, Japan,  3.5 m



**GA395SU**

sterile  

ELAN 4 electro DISPOSABLE TUBE SET

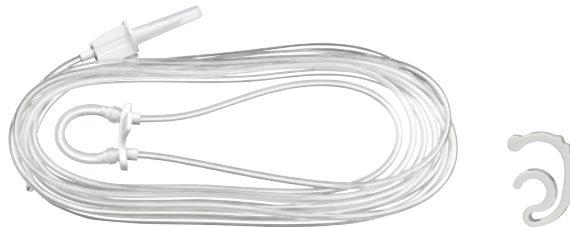

## ELAN 4 SPRAY NOZZELS

sterile 

**GA259SU**

for craniotome attachments

**GA261SU**

for 1-ring handpiece L4

**GA262SU**

for 1-ring handpiece L7

**GA263SU**

for 1-ring handpiece L10

**GA264SU**

for 1-ring handpiece L13

**GA265SU**

for 2-ring handpiece L7

**GA266SU**

for 2-ring handpiece L10

**GA267SU**

for 2-ring handpiece L13

**GA268SU**

for 2-ring handpiece L17

**GA269SU**

for 2-ring handpiece L22

**GB796SU**

for MIS handpiece shafts L10

**GB797SU**

for MIS handpiece shafts L13



**GA258SU**

for saws





# AESCLAP® Acculan 4

LOOK. FEEL. EXPERIENCE.

Acculan 4 the battery-operated power system for orthopaedics, traumatology, cardiothoracic surgery and dermatology

- Powerful
- Longevity – Exclusion of battery and electronic control from sterilization process
- Easy handling – **Titanium** housing allows mechanical alkaline reprocessing



# AESCULAP® Acculan 4

## DRILL & ATTACHMENTS

**GA330**

**GB495R**

Acculan 4 DRILL AND REAMER

250 W; 4.0 mm;  
207 x 121 x 55 mm; 1,250 g

consisting parts:

GA678 sterile funnel

GA672207 K-wire protection sleeve

TA011944 cleaning brush

GA672211 rinsing adapter

GB600840 Sterilit® spray adapter

Acculan

Lid GA675 and NiMH battery GA676 to be ordered separately.

Measurements and weight are including battery and lid.



**GB620R**

**GB496R**

Acculan 4 DRILL ATTACHMENT

with Jacobs chuck keyless 0.5 - 7.4 mm

0 - 1,000 rpm; 5.0 Nm; 4.0 mm;  
133 x 35 mm; 397 g



**GB621R**

**GB496R**

Acculan 4 DRILL ATTACHMENT

with Jacobs chuck 0.5 - 7.4 mm

0 - 1,000 rpm; 5.0 Nm; 4.0 mm;  
118 x 35 mm; 300 g

consisting parts:

key GA031R

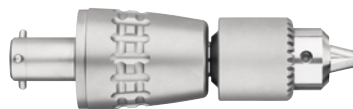

**GB623R**

**GB496R**

Acculan 4 DRILL ATTACHMENT

with small AO chuck

0 - 1,250 rpm; 4.0 Nm; 2.8 mm;  
90 x 35 mm; 210 g





## ATTACHMENTS

**GB639R**

**GB496R**

**Acculan 4 DRILL ATTACHMENT**

with Jacobs chuck 0.5 – 4.0 mm

0 – 1,250 rpm; 4.0 Nm;  4.0 mm;  
105 x 35 mm;  243 g

consisting parts:  
key GA062R



**GB645R**

**GB496R**

**Acculan DRILL ATTACHMENT**

for Synthes radiolucent drive 511.300

0 – 900 rpm; 110 x 35 mm;  225 g





**GB663R**

**GB496R**

**Acculan 4 DRILL ATTACHMENT**

with trinkle chuck

0 – 1,000 rpm; 5.0 Nm;  4.0 mm;  
93 x 35 mm;  217 g





**GB664R**

**GB496R**

**Acculan 4 DRILL ATTACHMENT**

with AESCULAP® hexagonal chuck

0 – 1,000 rpm; 5.0 Nm;  4.0 mm;  
86 x 35 mm;  225 g





**GB665R**

**GB496R**

**Acculan 4 DRILL ATTACHMENT**

with Hudson / Zimmer chuck

**0 – 1,000 rpm**; 5.0 Nm;  4.0 mm;  
100 x 35 mm;  230 g



# AESCULAP® Acculan 4



## ATTACHMENTS

**GB657R**

**GB496R**

### Acculan 4 INTRAMEDULLAR ATTACHMENT

with large AO chuck

0 - 370 rpm; 12.0 Nm;  4.0 mm;  
108 x 35 mm;  300 g





**GB667R**

**GB496R**

### Acculan 4 REAMER ATTACHMENT

with Jacobs chuck 0.5 - 7.4 mm chuck

0 - 250 rpm; 19.0 Nm;  4.0 mm;  
133 x 35 mm;  280 g

consisting parts:  
key GA031R

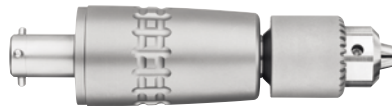



**GB668R**

**GB496R**

### Acculan 4 REAMER ATTACHMENT

with large AO chuck

0 - 250 rpm; 19.0 Nm;  4.0 mm;  
108 x 35 mm;  300 g





**GB669R**

**GB496R**

### Acculan 4 REAMER ATTACHMENT

with Hudson / Zimmer chuck

0 - 250 rpm; 19.0 Nm;  4.0 mm;  
118 x 35 mm;  300 g





**GB670R**

**GB496R**

### Acculan 4 REAMER ATTACHMENT

with Harris chuck

0 - 250 rpm; 19.0 Nm;  4.0 mm;  
106 x 35 mm;  290 g





**GB660R**

**GB496R**

Acculan **SAGITTAL SAW ATTACHMENT**

for Acculan rapid action saw blades with a **maximum useable length of 50 mm**

«» **0 - 17,000 rpm**;  $\angle$  4°47';  
89 x 36 x 44 mm;  $\text{♁}$  270 g



**GB641R**

**GB496R**

Acculan **K-WIRE ATTACHMENT**

for K-wires from **0.6 - 4.0 mm**

0 - 1,250 rpm; 93 x 36 x 137 mm;  
 $\text{♁}$  285 g



# AESCULAP® Acculan 4

## OSCILLATING SAWS

**GA331**

**GB495R**

### Acculan 4 OSCILLATING SAW

250 W;  $\leftrightarrow$  0 - 13,000 rpm;  $\sphericalangle$  4.1°;  
211 x 177 x 55 mm;  $\updownarrow$  1,600 g

consisting parts:  
GA678 sterile funnel

Lid GA675 and NiMH battery GA676 to  
be ordered separately.

Measurements and weight are including  
battery and lid.



**GA336**

**GB498R**

### Acculan 4 OSCILLATING SAW STRAIGHT

250 W;  $\leftrightarrow$  0 - 13,000 rpm;  $\sphericalangle$  4.1°;  
290 x 55 x 84 mm;  $\updownarrow$  1,480 g

consisting parts:  
GA678 sterile funnel

Lid GA675 and NiMH battery GA676 to  
be ordered separately.

Measurements and weight are including  
battery and lid.



**GA337**

**GB498R**

### Acculan 4 OSCILLATING STERNUM SAW

250 W;  $\leftrightarrow$  0 - 13,000 rpm;  $\sphericalangle$  4.1°;  
290 x 55 x 84 mm;  $\updownarrow$  1,480 g

consisting parts:  
GA678 sterile funnel

Lid GA675 and NiMH battery GA676 to  
be ordered separately.

Measurements and weight are including  
battery and lid.



## RECIPROCATING SAW

**GA334**

**GB495R**

### Acculan 4 RECIPROCATING SAW

250 W; ↔ 0 - 15,000 rpm; ↓ 3.2 mm;  
207 x 180 x 55 mm; ⚖ 1,540 g

consisting parts:

GA678 sterile funnel

GB440215 cleaning plate

GA674890 cleaning adapter

Lid GA675 and NiMH battery GA676 to  
be ordered separately.

Measurements and weight are including  
battery and lid.



**GB436R**

**GB686R**

### PROTECTION GUIDE

for use with GA334 and saw blade  
GC761R



# AESCULAP® Acculan 4

## DERMATOME

**GA340**

**GB498R**

### Acculan 4 DERMATOME

width keyless adjustable;  
thickness adjustable (1 / 10 mm steps);  
cutting thickness: 0.2 - 1.2 mm;  
cutting width: max. 78 mm;  
suitable blades: GB228R  
(to be ordered separately)

250 W; ↔ 0 - 6,500 rpm; ↑↓ 3.1 mm;  
277 x 113 x 83 mm; ⚖ 1,650 g

consisting parts:  
GA678 sterile funnel

Lid GA675 and small Li-Ion battery  
GA346 to be ordered separately.

Measurements and weight are including  
battery and lid.



**GA341**

**GB498R**

### Acculan 4 DERMATOME 0.1 MM

width keyless adjustable;  
thickness adjustable (1 / 10 mm steps);  
cutting thickness: 0.1 - 1.1 mm;  
cutting width: max. 78 mm;  
suitable blades: GB228R  
(to be ordered separately)

250 W; ↔ 0 - 6,500 rpm; ↑↓ 3.1 mm;  
277 x 113 x 83 mm; ⚖ 1,650 g

consisting parts:  
GA678 sterile funnel

Lid GA675 and small Li-Ion battery  
GA346 to be ordered separately.

Measurements and weight are including  
battery and lid.



**BA720R**

**GB688R**

### SKIN GRAFT MESHER

for use in combination with skin graft  
carriers BA721 (1:1.5) / BA722 (1:3) /  
BA723 (1:6)

150 x 195 x 105 mm; ⚖ 4,800 g

consisting parts:  
BA725R cutting roller  
BA726R ratchet wrench



# AESCULAP® Acculan 4

LOOK. FEEL. EXPERIENCE.

Acculan 4 small drill – the smallest member of the Acculan 4 family can be used for small fragment Osteosynthesis as well as for reamed intramedullary nailing.



# AESCULAP® Acculan 4

## SMALL DRILL

### DRILL & ATTACHMENTS

**GA344**

**GB482R**

#### Acculan 4 SMALL DRILL

with oscillating and tapping mode;  
not for use with acetabulum reamers

85 W;  3.2 mm;  
177 x 124 x 55 mm;  840 g

consisting parts:

GA678 sterile funnel

GA344244 K-wire protection guide

TA011944 cleaning brush

GA344211 rinsing adapter

GB600880 Sterilit® spray adapter

Lid GA675 and small Li-Ion battery  
GA346 to be ordered separately.

Measurements and weight are including  
battery and lid.





**GB870R**

**GB716R**

#### INTRAMEDULLARY REAMER ATTACHMENT

with Jacobs chuck 0.5 - 7.4 mm,  
not for use with acetabulum reamers

0 - 320 rpm; 5 Nm;  3.2 mm;  
105 x 29 mm;  230 g

consisting parts:

key GA031R





**GB871R**

**GB716R**

#### INTRAMEDULLARY REAMER ATTACHMENT

with large AO chuck,  
not for use with acetabulum reamers

0 - 320 rpm; 5 Nm;  3.2 mm;  
88 x 29 mm;  170 g





**GB872R**

**GB716R**

#### INTRAMEDULLARY REAMER ATTACHMENT

with Hudson/Zimmer chuck,  
not for use with acetabulum reamers

0 - 320 rpm; 5 Nm;  3.2 mm;  
86 x 25 mm;  150 g





## SMALL DRILL ATTACHMENTS

**GB881R**

**GB716R**

### DRILL ATTACHMENT

with Jacobs chuck 0.5 - 7.4 mm

0 - 1,250 rpm; 1.5 Nm;  3.2 mm;  
89 x 29 mm;  163 g

consisting parts:  
key GA031R

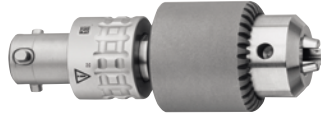



**GB882R**

**GB716R**

### DRILL ATTACHMENT

with Jacobs chuck 0.5 - 4 mm

0 - 1,250 rpm; 1.5 Nm;  3.2 mm;  
76 x 22 mm;  100 g

consisting parts:  
key GA062R

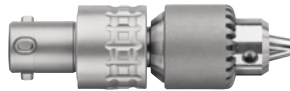



**GB884R**

**GB716R**

### DRILL ATTACHMENT

with small AO chuck

0 - 1,250 rpm; 1.5 Nm;  2.8 mm;  
60 x 22 mm;  66 g





**GB886R**

**GB716R**

### DRILL ATTACHMENT

with AESCULAP® hexagonal chuck

0 - 1,250 rpm; 1.5 Nm;  3.2 mm;  
57 x 24 mm;  67 g





**GB887R**

**GB716R**

### DRILL ATTACHMENT

with Dental shank

0 - 1,250 rpm; 1.5 Nm;  1.8 mm;  
56 x 22 mm;  50 g



# AESCU LAP<sup>®</sup> Acculan 4

## SMALL DRILL ATTACHMENTS

**GB878R**

**GB716R**

### DRILL ATTACHMENT

for Synthes radiolucent drive 511.300

0 - 1,250 rpm; 1.5 Nm;  
111 x 27 mm; 181 g

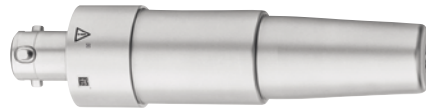

**GB894R**

**GB716R**

### K-WIRE ATTACHMENT

for K-wires from 0.6 - 3.2 mm

0 - 1,250 rpm; 3.2 mm;  
92 x 27 x 124 mm; 179 g



**GB891R**

**GB716R**

### SAGITTAL SAW ATTACHMENT

for "L-sagittal" sawblades

0 - 15,750 rpm; 74 x 33.5 mm;  
4.5°; 179 g



**GB892R**

**GB716R**

### RECIPROCATING SAW ATTACHMENT

for reciprocating saw blades

0 - 15,750 rpm; 135 x 24.5 mm;  
166 g; 2.5 mm







**GB896R**

**GB716R**

**SCREW ATTACHMENT**

with small AO chuck

0 - 165 rpm; 10 Nm;  1.7 mm;  
95 x 28 x 129.5 mm;  235 g





**GB897R**

**GB716R**

**SCREW ATTACHMENT**

with AESCULAP® hexagonal chuck

0 - 165 rpm; 10 Nm;  1.7 mm;  
92 x 28 x 129.5 mm;  231 g



# AESCULAP® Acculan 4

## CHARGER & BATTERIES

### GA320

#### Acculan 4 CHARGER

for Acculan Li-Ion and NiMH batteries  
GA346, GA676; 4 charging bays;  
automatic battery diagnosis function;  
power cord not included

100 - 240 V AC; 50 / 60 Hz;  
410 x 120 x 160 mm; 2,300 g



### GA346

#### Acculan 4 LI-ION BATTERY SHORT

only for GA340, GA341 and GA344;  
with integrated electronic motor  
control 9.9 V; 10.89 Wh

120 x 43 x 50 mm; 265 g



### GA676

#### Acculan NIMH BATTERY

only for GA330, GA331, GA334, GA336,  
GA337; with integrated electronic  
motor control 9.6 V; 1.95 Ah

140 x 43 x 50 mm; 425 g



### GA679

### GB489R

#### Acculan BATTERY REMOVAL DEVICE



### GA675

### GB487R

#### Acculan LID

90 g



### GA678

### GB488R

#### Acculan STERILE FUNNEL



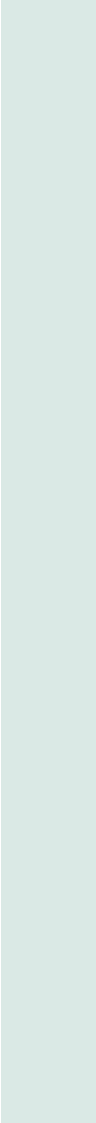

# AESCULAP® Acculan 4 Electro

LOOK. FEEL. EXPERIENCE.

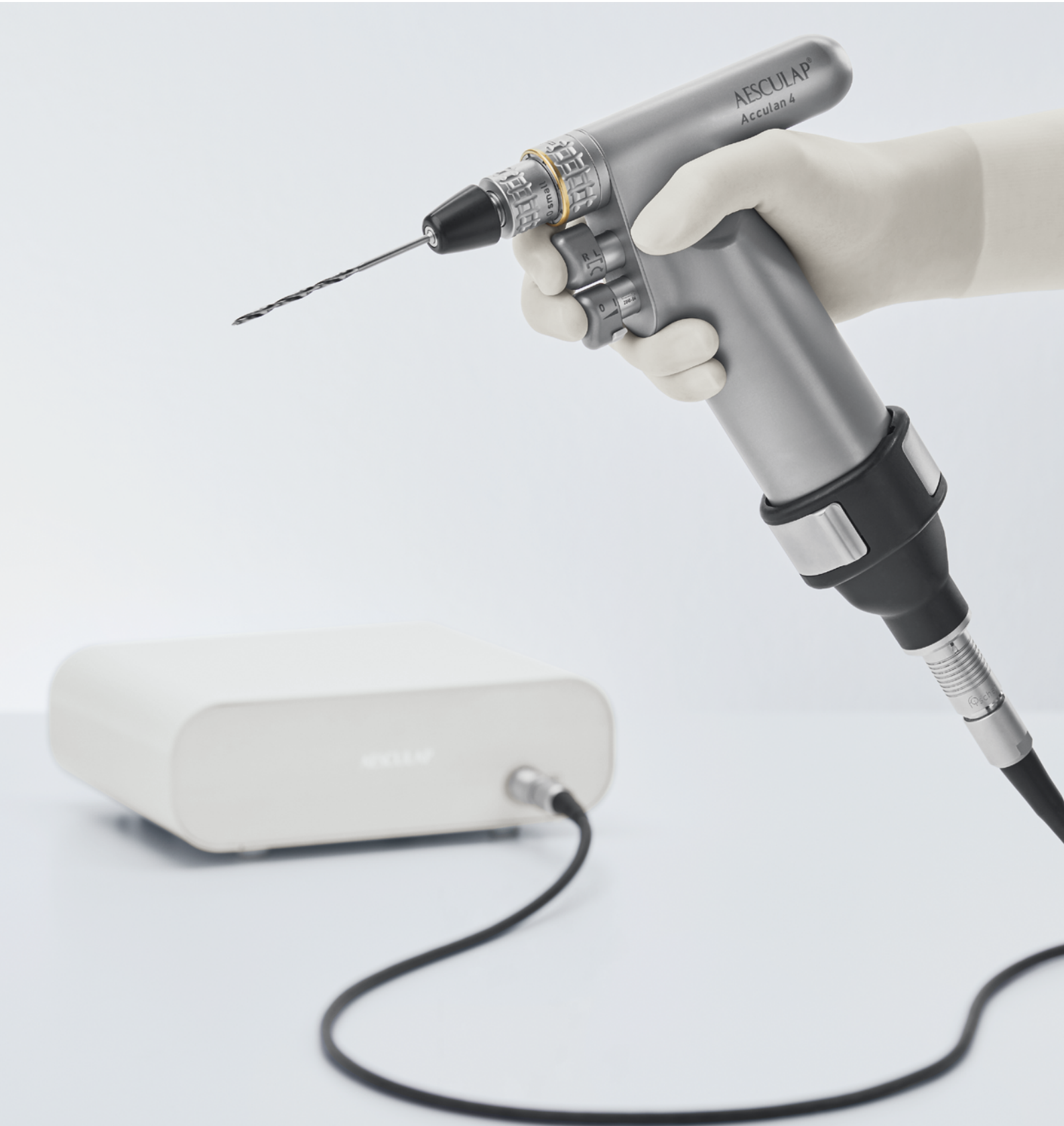

## CONSOLE & BATTERIES

### GA877

Acculan Electro CONSOLE  
power cord not included  
100 – 240 V AC; 50 / 60 Hz;  
255 x 217 x 90 mm; 2,930 g

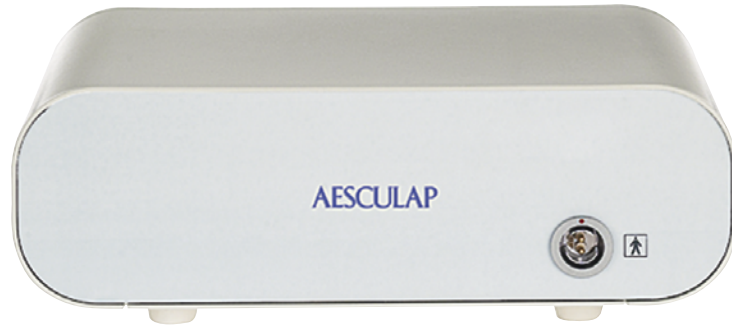

### GA878

GB486R

Acculan Electro CONNECTION CABLE  
for use with Acculan 4 handpieces  
3.0 m; 410 g



### GA875

GB485R

Acculan Electro LID



### GA876

Acculan Electro ADAPTER  
120 x 49 x 42 mm; 165 g



### GA678

















GB488R

Acculan STERILE FUNNEL



# AESCULAP® Acculan 4 ACCESSORIES

## ADAPTERS, KEYS & POWER CORD

<p><b>GB176R</b> <span style="float: right;"><b>GB690R</b></span></p> <p>ZIMMER ADAPTER            tool: Zimmer            motor: Hudson/Zimmer            only in combination with GB630R,            GB656R, GB665R, GB669R or GB872R   3.0 mm</p>	<p><b>GB414R</b> <span style="float: right;"><b>JG344</b></span></p> <p>AESCULAP® HEX ADAPTER            tool: AESCULAP® hexagonal            motor: triangular   3.5 mm</p>	<p><b>GB628R</b> <span style="float: right;"><b>JG344</b></span></p> <p>SYNTHES DHS /DCS ADAPTER            tool: Synthes DHS /DCS            motor: AO large   4.0 mm</p>
		
<p><b>GB184R</b> <span style="float: right;"><b>JG344</b></span></p> <p>HARRIS ADAPTER            tool: Harris            motor: AO large   3.4 mm</p>	<p><b>XF457R</b> <span style="float: right;"><b>JG344</b></span></p> <p>DIN ADAPTER            tool: DIN            motor: AO large   3.7 mm</p>	<p><b>GA031R</b> <span style="float: right;"><b>JG342 + JG344</b></span></p> <p>KEY            for large Jacobs chuck            suitable for GB620R, GB621R,            GB667R, GB870R, GB881R</p>
		
<p><b>GA062R</b> <span style="float: right;"><b>JG342</b></span></p> <p>KEY            for small 4 mm Jacobs chuck            suitable for GB639R, GB882R</p>		
		
<p><b>TE780</b></p> <p>POWER CORD            Europe,  1.5 m</p>	<p><b>TE734</b></p> <p>POWER CORD            UK,  5.0 m</p>	
<p><b>TE730</b></p> <p>POWER CORD            Europe,  5.0 m</p>	<p><b>TE735</b></p> <p>POWER CORD            USA, Canada, Japan,  3.5 m</p>	



# AESFULAP® PROCESSING

Sterilit® POWER SYSTEMS



PROCESSING

# AESCALAP® PROCESSING

Sterilit® POWER SYSTEMS

**GB600**



Sterilit® POWER SYSTEMS  
oil spray; 300 ml



**GB600860**

Sterilit® POWER SYSTEMS SPRAY  
ADAPTER

for ELAN 4 electro



**GB600870**

Sterilit® POWER SYSTEMS SPRAY  
ADAPTER

for ELAN 4 MIS handpiece shafts



**GB600840**

Sterilit® POWER SYSTEMS SPRAY  
ADAPTER

for Acculan 4



**GB600880**

Sterilit® POWER SYSTEMS SPRAY  
ADAPTER

for Acculan 4 small drill and ELAN 4  
electro drill





# AESFULAP® MECHANICAL PROCESSING

- The solution for storage and mechanical reprocessing of our AESFULAP® Power Systems.
- For detailed information please refer to the instructions for use.



# AESULAP<sup>®</sup> MECHANICAL PROCESSING

## ECCOS<sup>®</sup> SETS

### ELAN 4

#### GB261R

##### ELAN 4 electro ECCOS<sup>®</sup> SET

 56 mm

consisting parts:

GB073R

GB076R

GB083R

GB085R

GB719R

GB072R

JF212R

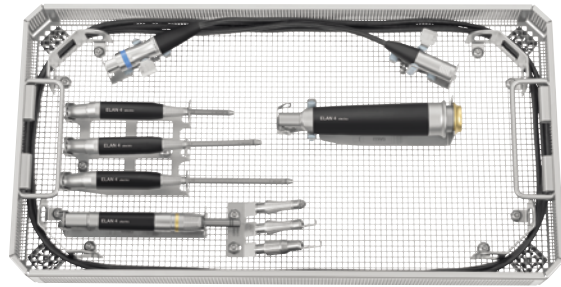

#### GB262R

##### ELAN 4 electro ECCOS<sup>®</sup> SET FOR DRILL GA844

 106 mm

consisting parts:

GB072R

GB073R

GB482R

GB715R

GB716R

2x GB690R

JG342

JG344

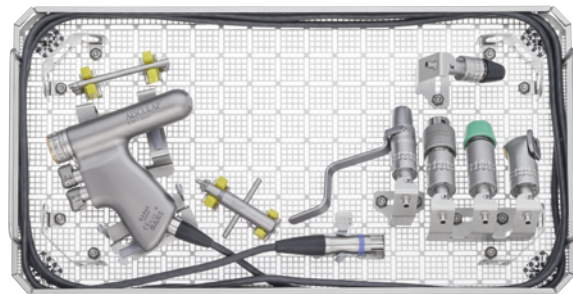



**ECCOS®**  
ELAN 4 electro

<p><b>GB073R</b></p> <p><b>ECCOS® HOLDER</b> for motor cable GA804, GA805, GA806 (set consisting of 2 pieces)</p>  56 mm	<p><b>GB076R</b></p> <p><b>ECCOS® HOLDER</b> for perforator driver GA822</p>  56 mm	<p><b>GB077R</b></p> <p><b>ECCOS® HOLDER</b> for intra motor GA824</p>  56 mm
 	 	 
<p><b>GB082R</b></p> <p><b>ECCOS® HOLDER</b> for 1 handpiece</p>  56 mm	<p><b>GB083R</b></p> <p><b>ECCOS® HOLDER</b> for 3 handpieces</p>  56 mm	<p><b>GB085R</b></p> <p><b>ECCOS® HOLDER</b> for craniotome GA849</p>  56 mm
 	 	 
<p><b>GB086R</b></p> <p><b>ECCOS® HOLDER</b> for micro sagittal saw GA836</p>  56 mm	<p><b>GB087R</b></p> <p><b>ECCOS® HOLDER</b> for reciprocating saws GA832, GA837</p>  56 mm	<p><b>GB088R</b></p> <p><b>ECCOS® HOLDER</b> for saws GA831, GA833</p>  56 mm
 	 	 

# AESULAP<sup>®</sup> MECHANICAL PROCESSING

ECCOS<sup>®</sup>

ELAN 4 electro

GB482R	GB715R	GB716R
<p>ECCOS<sup>®</sup> HOLDER for ELAN 4 electro drill GA844</p>  106 mm	<p>ECCOS<sup>®</sup> HOLDER for 1 attachment GB870R, GB871R, GB872R, GB878R, GB881R, GB884R, GB892R, GB896R, GB897R</p>  106 mm	<p>ECCOS<sup>®</sup> HOLDER for 3 attachments GB870R, GB871R, GB872R, GB878R, GB881R, GB884R, GB892R, GB896R, GB897R</p>  106 mm
		
		

# ECCOS® & RINSING DEVICES

## ELAN 4 electro

### GB084R

#### ECCOS® HOLDER

for MIS handpiece GA860

 56 mm

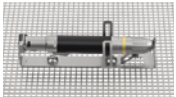

### GB723R

#### ECCOS® HOLDER

for MIS handpiece shafts GB920R - GB927R

 56 mm



### GB692R

#### RINSING DEVICE

for applied parts, incl. ceramic filter GB693



(not suitable for autoclaving)

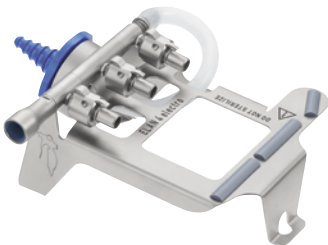

### GB679R

#### RINSING DEVICE

for 4 MIS shafts, incl. ceramic filter GB693



(not suitable for autoclaving)

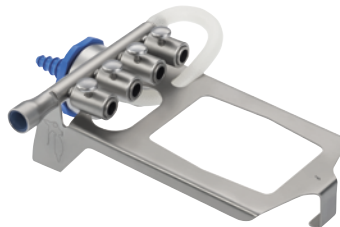

### GB698R

#### RINSING ADAPTER

for applied parts

(for manual cleaning)



### GB699R

#### RINSING ADAPTER

for MIS shafts













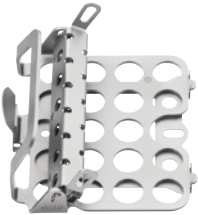









(for manual cleaning)



# AESCALAP® MECHANICAL PROCESSING

ECCOS®

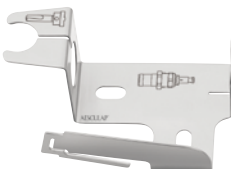
ELAN 4 ACCESSORIES

<p><b>GB718R</b></p>	<p><b>GB719R</b></p>	<p><b>GB720R</b></p>
<p>ECCOS® HOLDER for 12 1- and 2-ring burrs  56 mm</p>	<p>ECCOS® HOLDER for 3 craniotome attachments  56 mm</p>	<p>ECCOS® UNIVERSAL HOLDER for saw blades  56 mm</p>
		
		
<p><b>GB729R</b></p>	<p><b>GB730R</b></p>	<p><b>GB072R</b></p>
<p>ECCOS® HOLDER for 2 reciprocating saw shafts  56 mm</p>	<p>ECCOS® HOLDER for 2 transversal saw shafts  56 mm</p>	<p>ECCOS® CABLE/HOSE POS. GUIDE for cable and hoses (set of 4 pieces)  56 mm</p>
		
		
<p><b>GB727R</b></p>	<p><b>GB572R</b></p>	
<p>ECCOS® HOLDER for handpiece holding-sleeves GB861P, GB862P, GB863P  56 mm</p>	<p>ECCOS® FIXATION for GB300R - GB304R  56 mm</p>	
		
		

## ECCOS® SETS

### Acculan 4

#### GB257R

##### ECCOS® SET

for Acculan 4 small drill GA344

 106 mm

consisting parts:

GB482R

GB487R

GB488R

GB715R

GB716R

2x GB690R

JG342

JG344

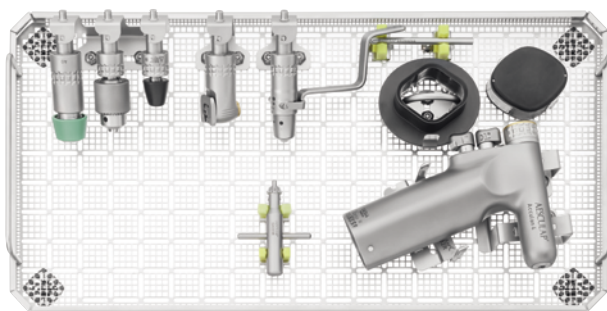

#### GB243R

##### ECCOS® SET

for 2 Acculan 4 machines

 106 mm

consisting parts:

GB481R

GB487R

GB488R

GB495R

GB496R

GB497R

2x GB690R

JG342

JG344

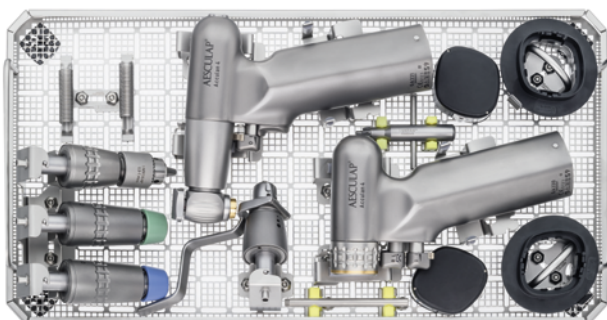

#### GB256R

##### ECCOS® SET

for Acculan 4 dermatome

 106 mm

consisting parts:

GB487R

GB488R

GB498R



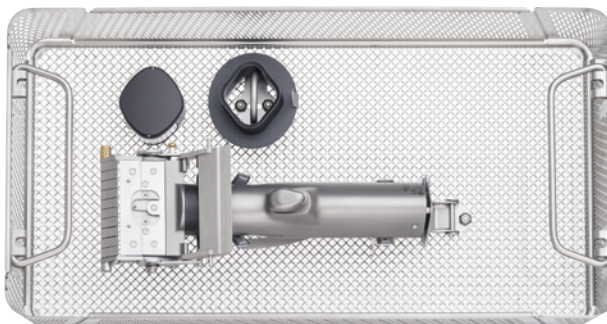











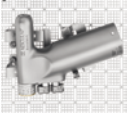

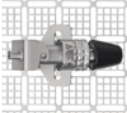
JJ464R

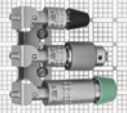

# AESCULAP® MECHANICAL PROCESSING

ECCOS®

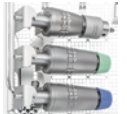
Acculan 4

<p><b>GB482R</b></p> <p>ECCOS® HOLDER for Acculan 4 small drill GA344</p>  106 mm	<p><b>GB715R</b></p> <p>ECCOS® HOLDER for 1 attachment GB870R, GB871R, GB872R, GB878R, GB881R, GB884R, GB892R, GB896R, GB897R</p>  106 mm	<p><b>GB716R</b></p> <p>ECCOS® HOLDER for 3 attachments GB870R, GB871R, GB872R, GB878R, GB881R, GB884R, GB892R, GB896R, GB897R</p>  106 mm
 	 	 
<p><b>GB495R</b></p> <p>ECCOS® HOLDER for GA330, GA331, GA334</p>  106 mm	<p><b>GB496R</b></p> <p>ECCOS® HOLDER for GB620R, GB621R, GB623R, GB639R, GB641R, GB645R GB660R, GB663R, GB664R, GB665R, GB657R, GB667R, GB668R, GB669R, GB670R</p>  106 mm	<p><b>GB497R</b></p> <p>ECCOS® HOLDER for GB620R, GB621R, GB623R, GB639R, GB641R, GB645R GB660R, GB663R, GB664R, GB665R, GB657R, GB667R, GB668R, GB669R, GB670R</p>  106 mm
 	 	 



GB487R	GB488R	GB489R
--------	--------	--------

ECCOS® HOLDER  
for GA675



ECCOS® HOLDER  
for GA678

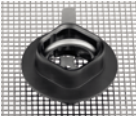

ECCOS® HOLDER  
for GA679



GB498R	GB686R
--------	--------

ECCOS® HOLDER  
for GA336, GA337, GA340, GA341

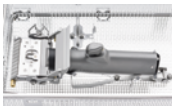



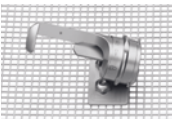







ECCOS® HOLDER  
for GB436R

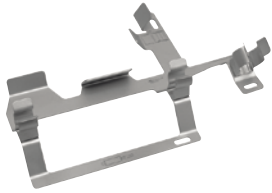
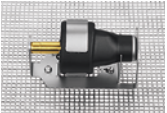
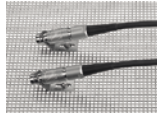

# AESCULAP® MECHANICAL PROCESSING

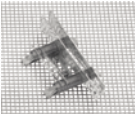

## ECCOS® HOLDER

Acculan 4

<p><b>GB485R</b></p>	<p><b>GB486R</b></p>	<p><b>GB688R</b></p>
<p>ECCOS® HOLDER for GA875  56 mm</p>	<p>ECCOS® HOLDER for GA878  56 mm</p>	<p>ECCOS® HOLDER for BA720R  106 mm</p>
		
		
<p><b>GB481R</b></p>	<p><b>JF148R</b></p>	<p><b>JJ589R</b></p>
<p>ECCOS® HOLDER for saw blades and other accessories  56 mm</p>	<p>MINI TRAY WITH LID outer size: 145 x 44 x 25 mm inner size: 140 x 39 x 18 mm for storage of Acculan 4 Dermatome rod and flaps during automatic cleaning process</p>	<p>SOCKET WRENCH AF7</p>
 		

# ECCOS® HOLDER

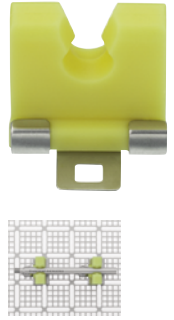
## Universal Tools

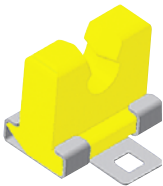
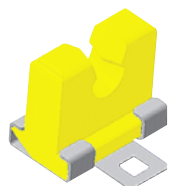
<p><b>GB459R</b></p> <p>ECCOS® MOUNTING KIT</p> <p>consisting of: socket wrench AF10 and hex-wrench</p>	<p><b>GB690R</b></p> <p>ECCOS® HOLDER</p> <p>5 mm for drilling wire guide GA672207, GA344244</p>	<p><b>JG303R</b></p> <p>REPLACEMENT SCREWS-SET</p> <p>screw nut size AF7</p>
		
<p><b>JG342</b></p> <p>SILICONE CLAMP</p> <p>8.5 mm screw JG303R to be ordered separately</p>	<p><b>JG344</b></p> <p>SILICONE CLAMP</p> <p>12 mm screw JG303R to be ordered separately</p>	
		

# AESCALAP® POWER SYSTEMS

## TOOL ATTACHMENTS OVERVIEW

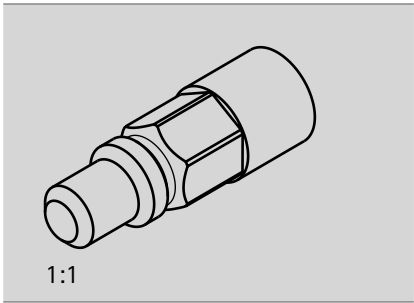

AO LARGE

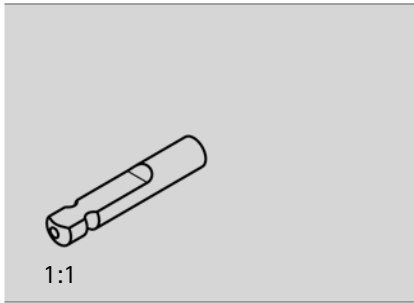

AO SMALL

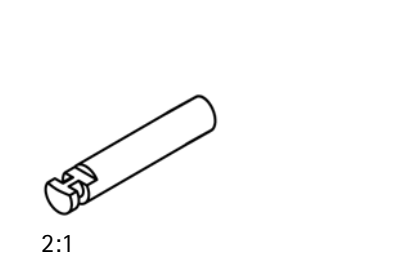

DENTAL

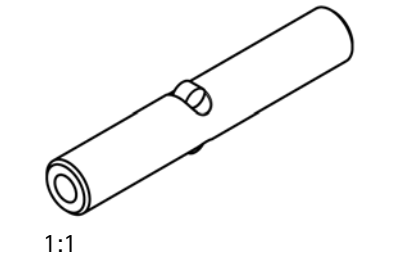

DIN

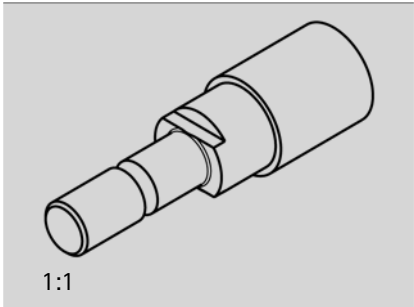

HARRIS

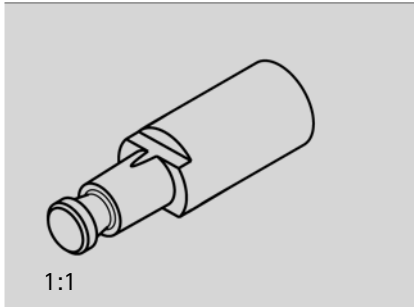

HUDSON

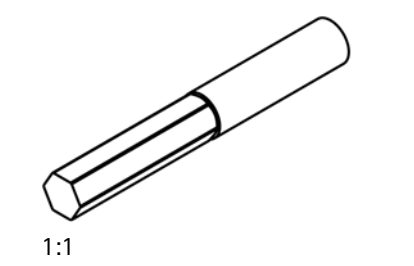

HEXAGON

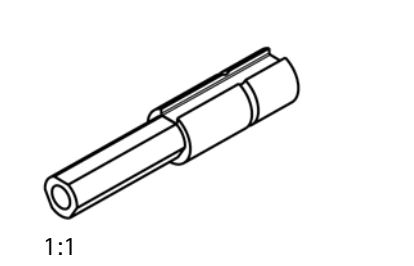

SYNTHES  
DHS/DCS

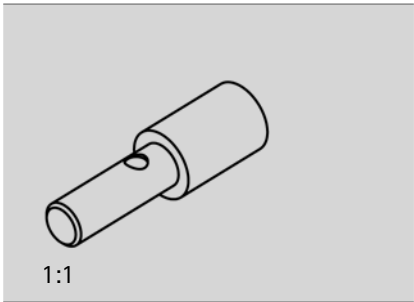



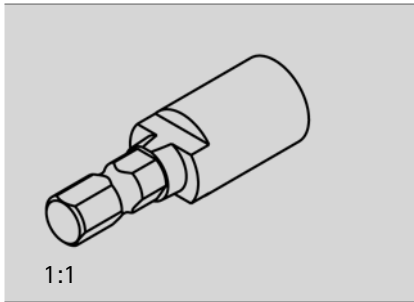









TRINKLE

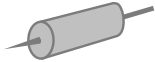

ZIMMER

## SIGNS & SYMBOLS

	<p><b>LATEX-FREE</b> All products listed in this catalogue are latex-free</p>
	<p><b>ARTICLE CODE ECCOS® FIXATION</b></p>
	<p><b>FORWARD / REVERSE DRIVE</b></p>
	<p><b>FORWARD DRIVE</b></p>
	<p><b>OSCILLATION FREQUENCY</b></p>
	<p><b>OSCILLATION ANGLE</b></p>
	<p><b>STROKE</b></p>
	<p><b>CANNULATION</b></p>
	<p><b>CABLE LENGTH</b></p>
	<p><b>WEIGHT</b></p>
	<p><b>PACKAGING UNIT</b></p>
	<p><b>SINGLE USE</b></p>
	<p><b>REQUIRED HEIGHT OF TRAY</b></p>
	<p><b>STERILE</b></p>

# AESCULAP® POWER SYSTEMS

## BROCHURES

### Main Catalogues

084002  
Power Systems

017599  
Burrs & Blades

[CLICK HERE  
for Electronic Instructions for Use \(eIFU\)](#)

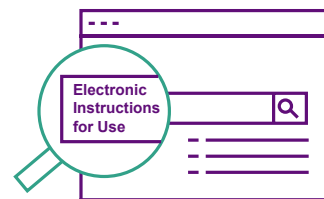

### ELAN 4

071602  
ELAN 4

071511  
Mechanical Cleaning

012002  
Manual Cleaning

### Acculan 4





001802  
Acculan 4

001902  
Acculan 4 Dermatome

002002  
Acculan 4 Electro

002102  
Acculan 4 Sternum Saws

## INDEX

Art. No.		Art. No.		Art. No.		Art. No.	
BA720R	32	GA866	11	GB639R	27	GB922R	13
GA031R	42	GA867	11	GB641R	29	GB925R	13
GA062R	42	GA868	11	GB645R	27	GB926R	13
GA258SU	23	GA869	11	GB657R	28	GB927R	13
GA259SU	23	GA875	41	GB660R	29	GB941R	9
GA261SU	23	GA876	41	GB663R	27	GB942R	9
GA262SU	23	GA877	41	GB664R	27	GB943R	9
GA263SU	23	GA878	41	GB665R	27	GB945R	9
GA264SU	23	GB072R	50	GB667R	28	GB947R	9
GA265SU	23	GB073R	47	GB668R	28	JF148R	54
GA266SU	23	GB076R	47	GB669R	28	JF212R	46
GA267SU	23	GB077R	47	GB670R	28	JG303R	55
GA268SU	23	GB082R	47	GB679R	49	JG342	55
GA269SU	23	GB083R	47	GB686R	53	JG344	46, 55
GA320	38	GB084R	49	GB688R	54	JJ589R	54
GA330	26	GB085R	47	GB690R	55	TE730	22, 42
GA331	30	GB086R	47	GB692R	49	TE734	22, 42
GA334	31	GB087R	47	GB698R	49	TE735	22, 42
GA336	30	GB088R	47	GB699R	49	TE780	22, 42
GA337	30	GB176R	42	GB715R	48, 52	XF457R	42
GA340	32	GB184R	42	GB716R	48, 52		
GA341	32	GB243R	51	GB718R	50		
GA344	34	GB256R	51	GB719R	50		
GA346	38	GB257R	51	GB720R	50		
GA395SU	23	GB261R	46	GB723R	49		
GA675	38	GB262R	46	GB727R	50		
GA676	38	GB414R	42	GB729R	50		
GA678	38, 41	GB436R	31	GB730R	50		
GA679	38	GB459R	55	GB796SU	23		
GA800	7	GB481R	54	GB797SU	23		
GA804	8	GB482R	48, 52	GB861P	22		
GA805	8	GB485R	54	GB862P	22		
GA806	7	GB486R	54	GB863P	22		
GA808	7	GB487R	53	GB866R	22		
GA810	7	GB488R	53	GB870R	17, 34		
GA822	8	GB489R	53	GB871R	17, 34		
GA824	8	GB495R	52	GB872R	17, 34		
GA831	15	GB496R	52	GB878R	19, 36		
GA832	15	GB497R	52	GB881R	18, 35		
GA833	15	GB498R	53	GB882R	18, 35		
GA836	15	GB572R	50	GB884R	18, 35		
GA837	15	GB600	44	GB886R	18, 35		
GA844	17	GB600840	44	GB887R	18, 35		
GA849	9	GB600860	44	GB891R	19, 36		
GA860	13	GB600870	44	GB892R	19, 36		
GA861	10	GB600880	44	GB894R	19, 36		
GA862	10	GB620R	26	GB896R	20, 37		
GA863	10	GB621R	26	GB897R	20, 37		
GA864	10	GB623R	26	GB920R	13		
GA865	11	GB628R	42	GB921R	13		

# AESFULAP<sup>®</sup> – a B. Braun brand

Aesculap AG | Am Aesculap-Platz | 78532 Tuttlingen | Germany  
Phone +49 7461 95-0 | Fax +49 7461 95-2600 | [www.aesculap.com](http://www.aesculap.com)

The main product trademark "AESFULAP" and the product trademarks "ECCOS" and "Sterilit" are registered trademarks of Aesculap AG.

Subject to technical changes. All rights reserved. This brochure may only be used for the exclusive purpose of obtaining information about our products. Reproduction in any form partial or otherwise is not permitted.