

Lot 13

30650

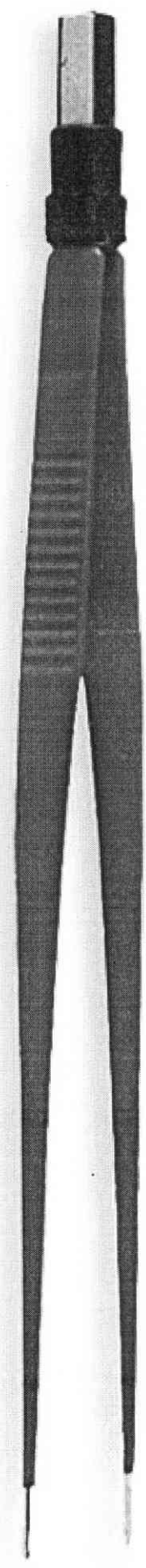

Lot 13

UNIVERSAL HIGH QUALITY INSULATED BIPOLAR FORCEPS

EUROPEAN CONNECTOR BIPOLAR FORCEPS

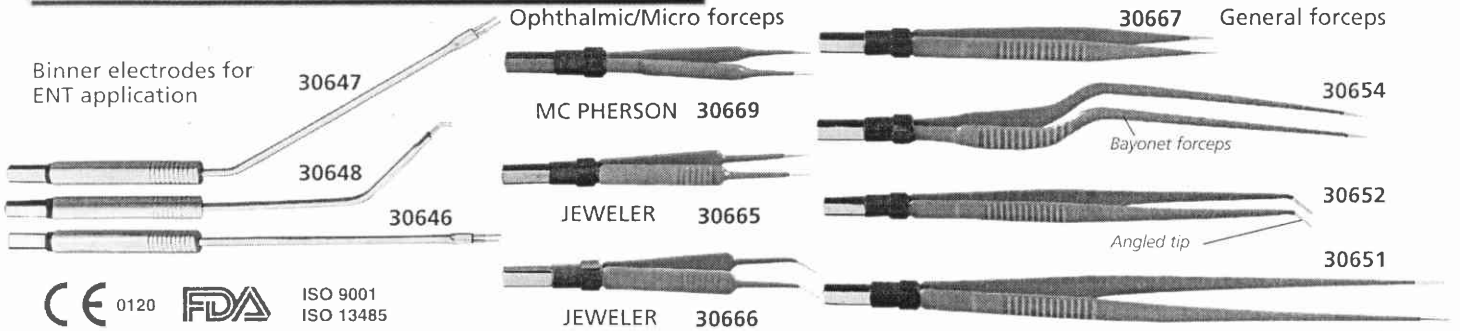

CE 0120 FDA ISO 9001 ISO 13485

GIMA code	Model	Connector	Length		Tip style	Application	Tip size
			cm	inches			
30645	BINNER	EU	22 cm	8½"	ANGLED	ENT	-
30646	BINNER	EU	18 cm	7"	STRAIGHT	ENT	-
30647	BINNER	EU	18 cm	7"	ANGLED	ENT	-
30648	BINNER	EU	19 cm	7¾"	ANGLED 45°	ENT	-
30650	STRAIGHT	EU	18 cm	7"	STRAIGHT	GENERAL	1 mm round points
30656	STRAIGHT with irrigation	EU	18 cm	7"	STRAIGHT	GENERAL	1 mm round points
30651	STRAIGHT	EU	20 cm	7¾"	STRAIGHT	GENERAL	1 mm round points
30658	STRAIGHT	EU	20 cm	7¾"	STRAIGHT	GENERAL	2 mm round points
30652	STRAIGHT	EU	18 cm	7"	ANGLED	GENERAL	1 mm round points
30653	STRAIGHT	EU	20 cm	7¾"	ANGLED	GENERAL	1 mm round points
30657	BAYONET	EU	16.5 cm	6½"	STRAIGHT	GENERAL	1 mm round points
30654	BAYONET	EU	18 cm	7"	STRAIGHT	GENERAL	1 mm round points
30655	BAYONET	EU	20 cm	7¾"	STRAIGHT	GENERAL	1 mm round points
30659	BAYONET	EU	22 cm	8¾"	STRAIGHT	GENERAL	1 mm round points
30663	BAYONET	EU	24 cm	9½"	STRAIGHT	GENERAL	1 mm round points
30660	STRAIGHT	EU	18 cm	7"	ANGLED	GENERAL	0.3 mm points
30661	STRAIGHT	EU	18 cm	7"	STRAIGHT	GENERAL	0.3 mm points
30662	STRAIGHT	EU	20 cm	7¾"	STRAIGHT	GENERAL	0.3 mm points
30664	ADSON	EU	12.1 cm	6"	STRAIGHT	GENERAL	1 mm round points
30665	JEWELER 5	EU	11.5 cm	4½"	STRAIGHT	OPHTHALMIC/MICRO	0.25 mm points
30666	JEWELER 5	EU	11.5 cm	4½"	ANGLED	OPHTHALMIC/MICRO	0.25 mm points
30667	STRAIGHT	EU	15 cm	6"	STRAIGHT	OPHTHALMIC/MICRO	0.5 mm points
30668	STRAIGHT	EU	15 cm	6"	ANGLED	OPHTHALMIC/MICRO	0.5 mm points
30669	Mc PHERSON	EU	10.2 cm	4"	STRAIGHT	OPHTHALMIC/MICRO	0.5 mm points

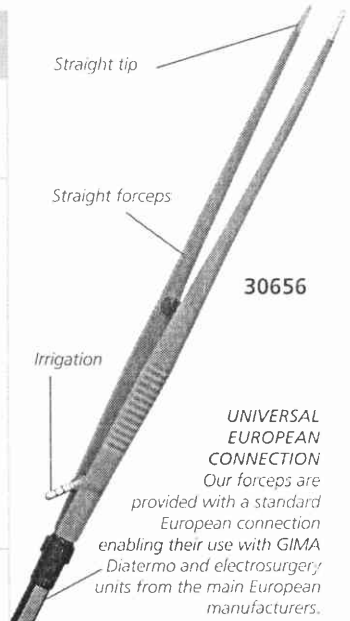

UNIVERSAL EUROPEAN CONNECTION
Our forceps are provided with a standard European connection enabling their use with GIMA Diathermy and electrosurgery units from the main European manufacturers.

US CONNECTOR BIPOLAR FORCEPS

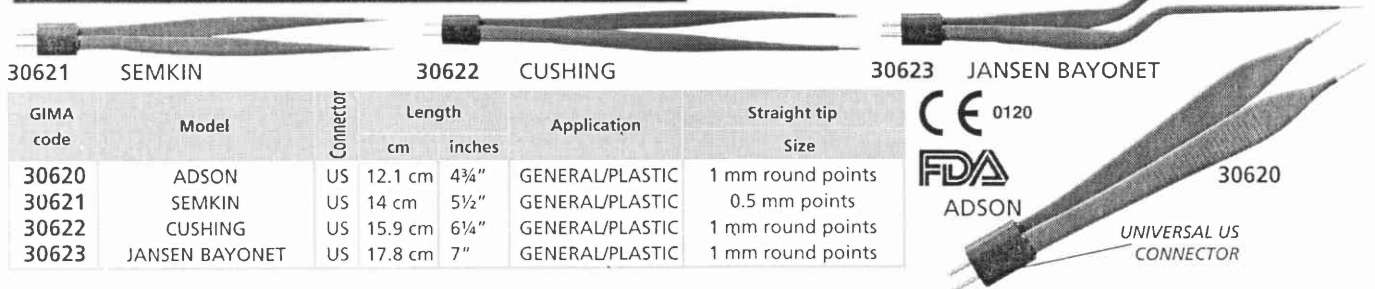

GIMA code	Model	Connector	Length		Application	Straight tip Size
			cm	inches		
30620	ADSON	US	12.1 cm	4¾"	GENERAL/PLASTIC	1 mm round points
30621	SEMKIN	US	14 cm	5½"	GENERAL/PLASTIC	0.5 mm points
30622	CUSHING	US	15.9 cm	6¼"	GENERAL/PLASTIC	1 mm round points
30623	JANSEN BAYONET	US	17.8 cm	7"	GENERAL/PLASTIC	1 mm round points

CE 0120 FDA ADSON

UNIVERSAL US CONNECTOR

EUROPEAN NON-STICK BIPOLAR FORCEPS

NON-STICK BIPOLAR FORCEPS

Thanks to new Ag-Tech non-stick technology, the forceps stay clean, virtually eliminating the need for cleaning during

coagulation. A tip material with excellent thermal properties prevents the sticking of tissues. The non-stick effect is permanent and will not reduce with the use of forceps.

GIMA code	Model	Connector	Length		Tip style	Tip size
			cm	inches		
30460	STRAIGHT	EU	15	6"	STRAIGHT	1 mm
30461	STRAIGHT	EU	18	7"	STRAIGHT	1 mm
30462	STRAIGHT	EU	20	7¾"	STRAIGHT	1 mm
30464	STRAIGHT	EU	18	7"	ANGLED	1 mm
30465	STRAIGHT	EU	20	7¾"	ANGLED	1 mm
30468	BAYONET	EU	18	7"	STRAIGHT	1 mm
30469	BAYONET	EU	20	7¾"	STRAIGHT	1 mm
30472	JEWELER	EU	11.5	4.5"	STRAIGHT	0.7 mm
30473	JEWELER	EU	11.5	4.5"	ANGLED	0.7 mm
30474	ADSON	EU	12.1	4¾"	STRAIGHT	1 mm

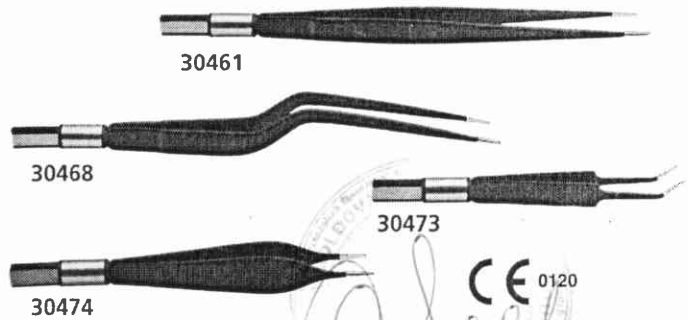

CE 0120

ELECTROSURGERY

Lotul 13

*Reusable
electrosurgical pencils*

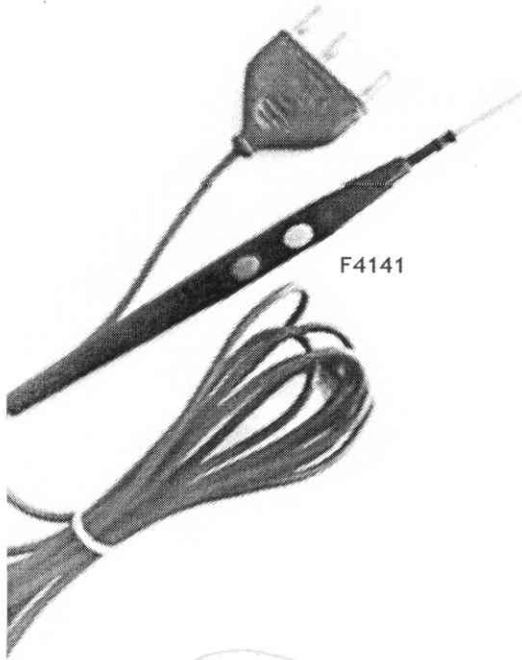

REUSABLE HAND SWITCH PENCILS

REF	CABLE LENGTH	CONNECTOR	ELECTRODE	Ø	GUARANTEED STERILIZATIONS
F4141	300 cm	Valleylab	blade F4060	2,38 mm	30
F4141/ERB	300 cm	Erbe 5 mm	blade F4060	2,38 mm	30
F4151	500 cm	Valleylab	blade F4060	2,38 mm	30
F4243	320 cm	Valleylab	blade F4060	2,38 mm	100
F4244	300 cm	Valleylab	blade F4060	2,38 mm	100
F4254	500 cm	Valleylab	blade F4060	2,38 mm	100
F4246	300 cm	Valleylab	blade F4060/4	4,00 mm	100
F4256	500 cm	Valleylab	blade F4060/4	4,00 mm	100

REUSABLE FOOT CONTROL PENCILS

REF	CABLE LENGTH	CONNECTOR	ELECTRODE	Ø	GUARANTEED STERILIZATIONS
F4814	300 cm	4 mm plug	blade F4060	2,38 mm	100

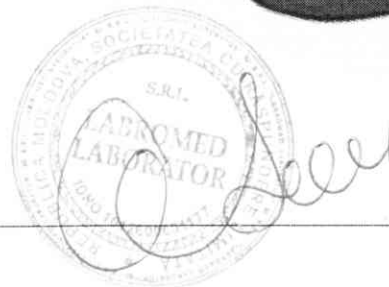
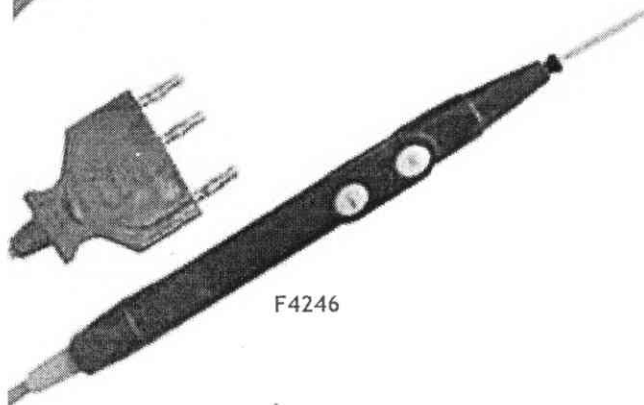
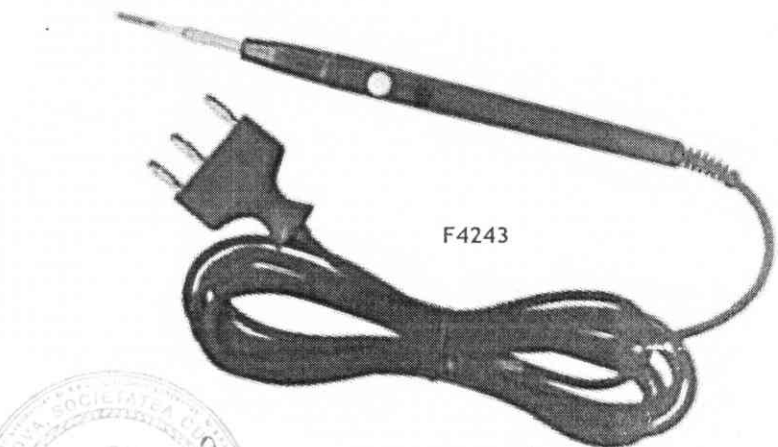
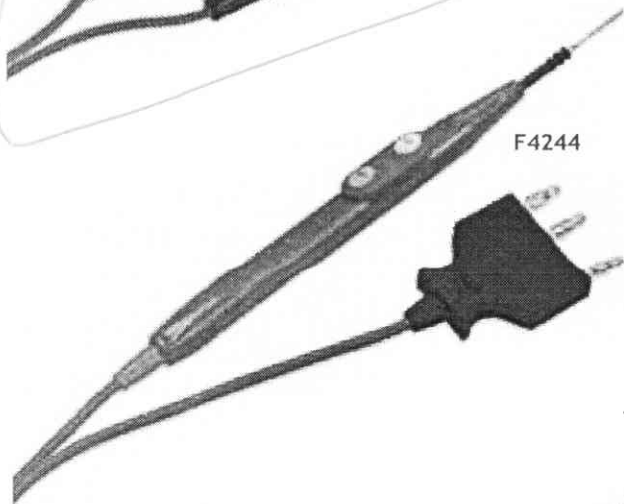
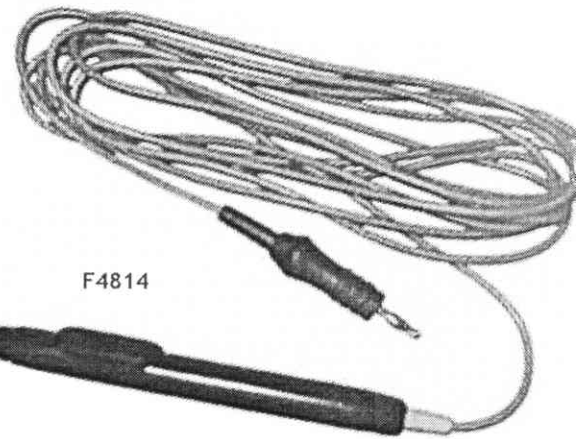
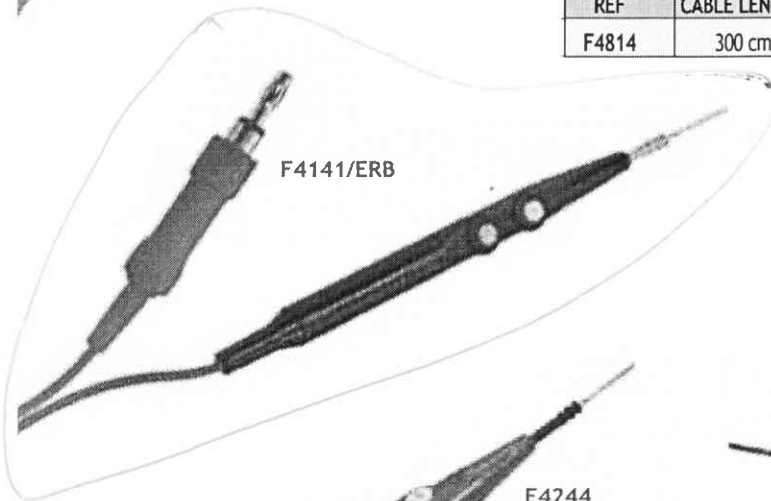

ELECTROSURGERY

Lotul 13

*Reusable
electrosurgical pencils*

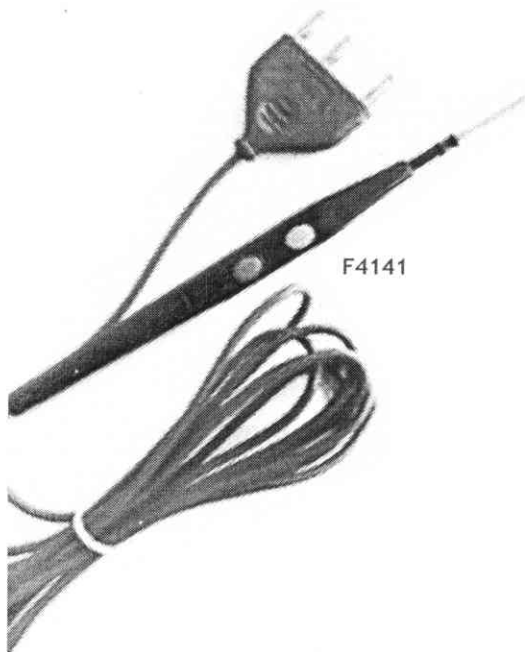

F4141

REUSABLE HAND SWITCH PENCILS					
REF	CABLE LENGTH	CONNECTOR	ELECTRODE	Ø	GUARANTEED STERILIZATIONS
F4141	300 cm	Valleylab	blade F4060	2,38 mm	30
F4141/ERB	300 cm	Erbe 5 mm	blade F4060	2,38 mm	30
F4151	500 cm	Valleylab	blade F4060	2,38 mm	30
F4243	320 cm	Valleylab	blade F4060	2,38 mm	100
F4244	300 cm	Valleylab	blade F4060	2,38 mm	100
F4254	500 cm	Valleylab	blade F4060	2,38 mm	100
F4246	300 cm	Valleylab	blade F4060/4	4,00 mm	100
F4256	500 cm	Valleylab	blade F4060/4	4,00 mm	100

REUSABLE FOOT CONTROL PENCILS					
REF	CABLE LENGTH	CONNECTOR	ELECTRODE	Ø	GUARANTEED STERILIZATIONS
F4814	300 cm	4 mm plug	blade F4060	2,38 mm	100

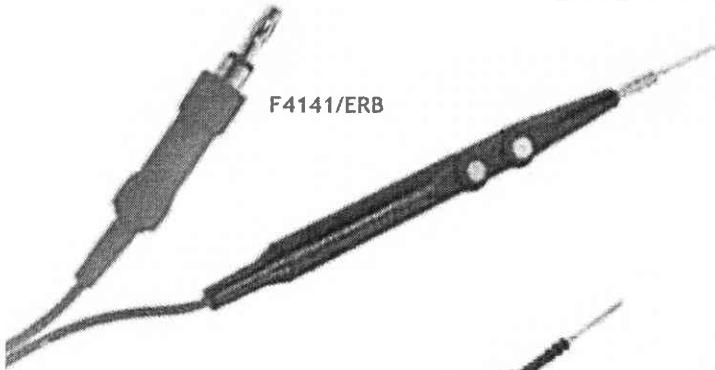

F4141/ERB

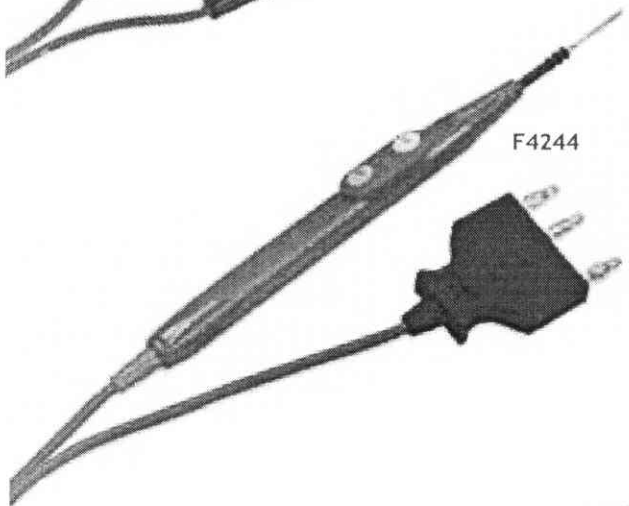

F4244

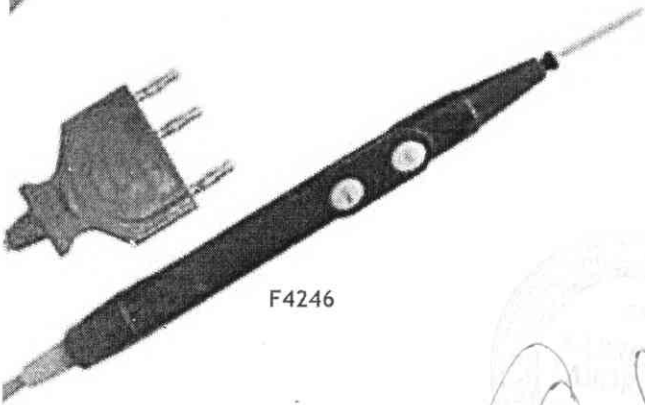

F4246

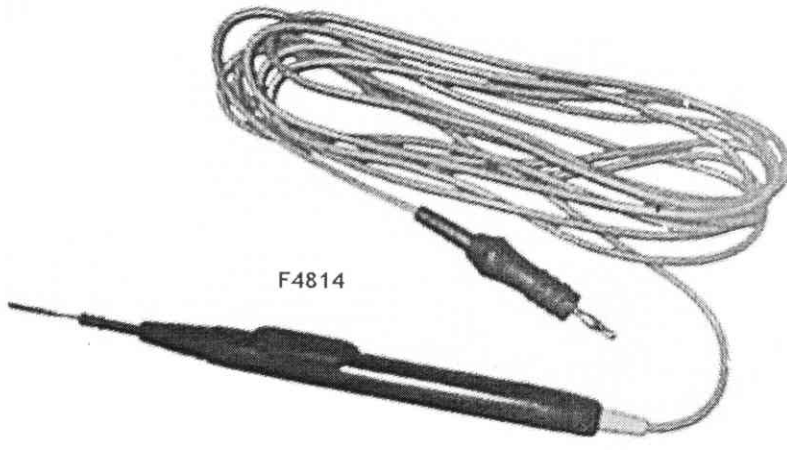

F4814

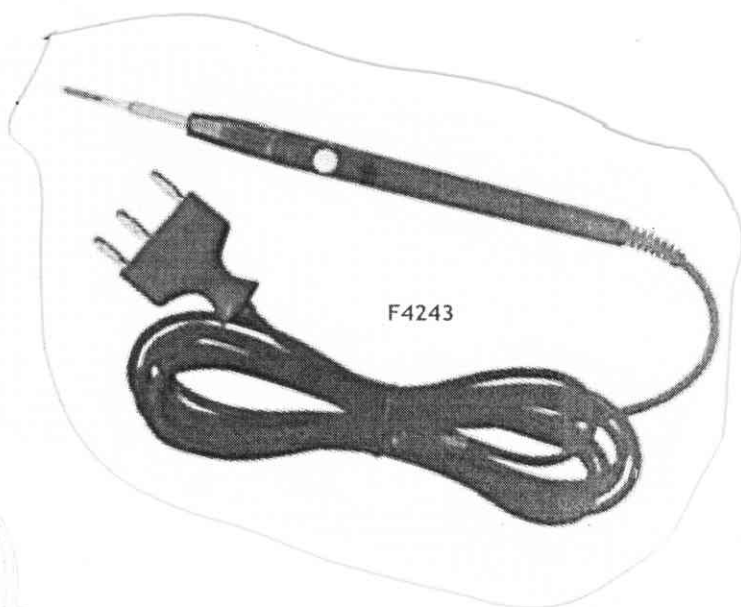

F4243

Handwritten signature

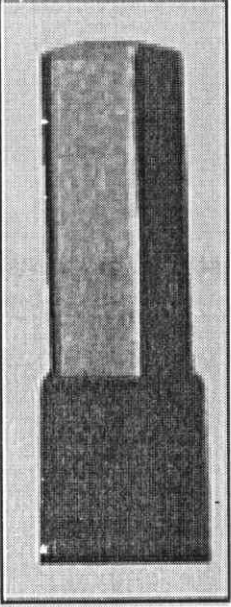
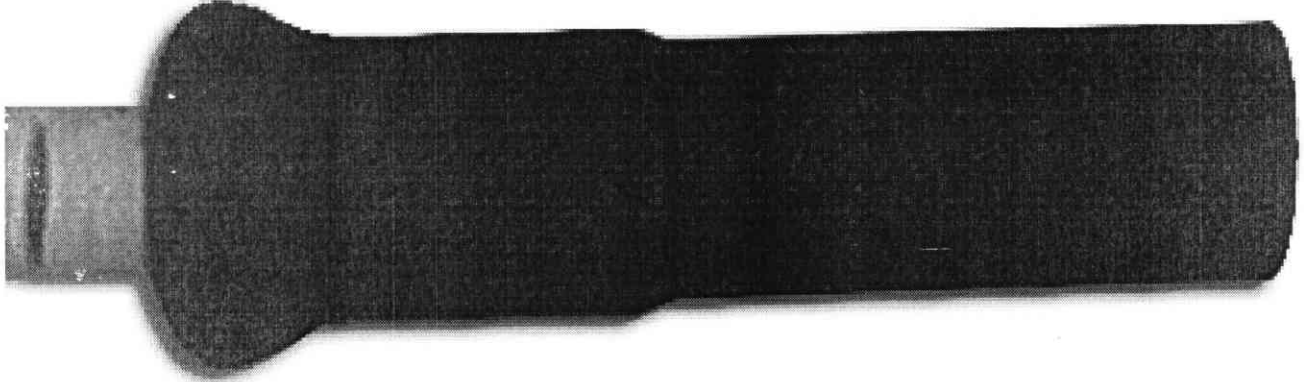
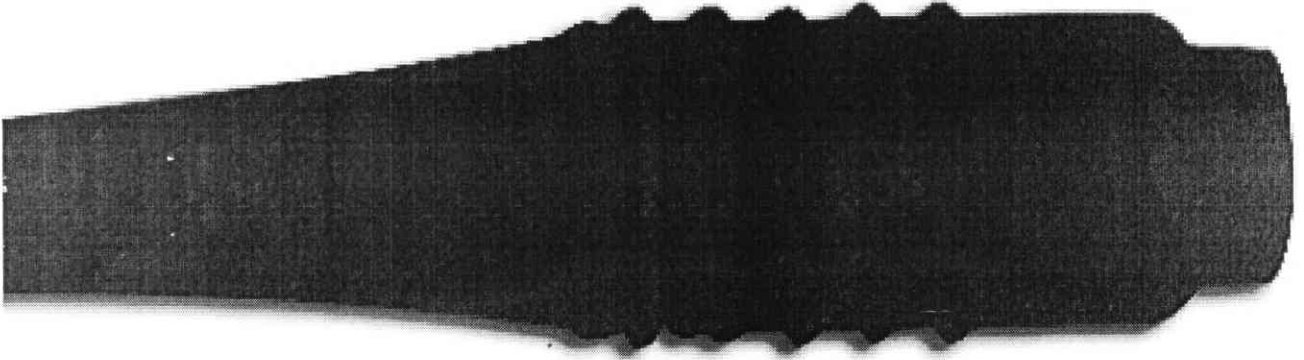

F11



30638

Lotus 13



BIPOLAR CABLES FOR MAJOR BRANDS

Quality highly flexible silicone bipolar cables. Autoclavable at 134°C for minimum 20 times. 3 m long (10").

Recommended ETO sterilization for max extended life. Suitable for most generators, with connector for European or US forceps.

GIMA Code	30632	30618	30640	30637	30643	30618+ 30642	30617	30644	30639	30638
Connector to forceps	EU	US	EU	US	EU	US	EU	US	EU	EU
Compatibility brand/model	GIMA: MB 240, MB 380 VALLEY LAB, CONMED, CODMAN, OLYMPUS		GIMA: MB 120 F, MB 200 F, MB 200 D, MB 250, MB 300 D, MB 400 D LED: SURTRON 120, 200, 300, 400 VALLEY LAB, EMC, DOLLEY		GIMA: MB 122, MB 160, MB 200, MB 202		GIMA: MB 80 D, MB 120 D, MB 160 D LED: SURTRON 80, 120, 160		MARTIN, BERCHTOLD, AESCULAP, WOLF	ERBE, SELECT, DOWNS, SIEMENS

SINGLE USE, METAL AND RUBBER PLATES

30563 Cable

30495 Adult/pediatric REM disposable plate

30492 Adult disposable plate

30493 Adult REM disposable plate

30490 Pediatric disposable plate

30494 Adult/pediatric disposable plate

30561 (rod neutral plate)

30564 (metal plate)

30566 (metal plate)

30573 (rubber plate 20x15 cm)

30574 (rem rubber plate)

30563 (cable)

30575 (cable)

- 30492 DISPOSABLE GROUND PADS WITH SOLID GEL - adult
 - 30490 DISPOSABLE GROUND PADS WITH SOLID GEL - pediatric
 - 30493 REM DISPOSABLE GROUND PADS WITH SOLID GEL - adult
 - 30494 DISPOSABLE NON WOVEN GROUND PADS - adult/ped
 - 30495 REM DISPOSABLE NON WOVEN GROUND PADS - adult/ped
 - 30563 CABLE FOR PLATES - 5 m
 - 30559 CABLE FOR PLATES - 2.5 m
- Universal cable to connect plates (30490-30495) to diathermo. Safety lock with universal connection - bipolar Ø 6.3 mm plug.

- 30573 RUBBER PLATE 20x15 cm - without cable
- 30574 REM RUBBER PLATE 20x15 cm - without cable
- 30575 CABLE FOR RUBBER PLATES
- 30566 METAL PLATE - without cable
- 30564 SURGEON NEUTRAL PLATE 16x12 cm - with cable
- 30561 ROD NEUTRAL PLATE with cable

3M ELECTROSURGICAL GROUNDING PADS WITH SAFETY RING

- 30496 3M 9160 SPLIT GROUNDING PAD - box of 100
 - 30497 3M 9160F SPLIT GROUNDING PAD - box of 200 (40 pouches of 5 pieces)
 - 30498 3M 9165 SPLIT GROUNDING PAD - pre-recorded - box of 40
- The 3M 9160, and 9165 Universal Grounding Pads all have a conductor area of 15 square inches and come with the patented 3M Green Safety Ring technology which allows them to perform the same as grounding pads that are up to 33% larger in conductor area. Green Ring allows adult and pediatric use.

In addition, they have fluid resistant, non-woven backing which allows heat to pass through up to 25% faster than foam, and they have no minimum age or weight limit.



ELECTROSURGERY



F7902

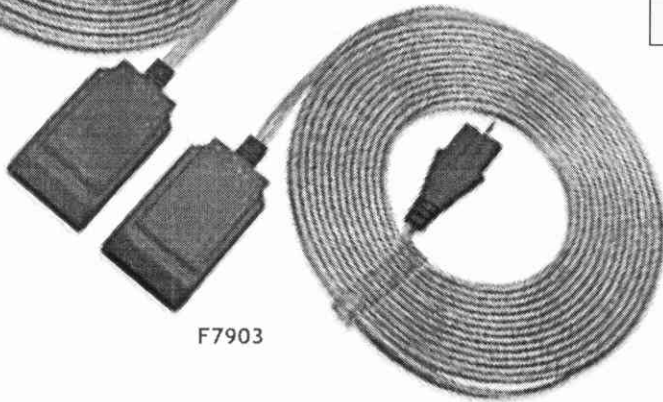

F7903

CABLES FOR DISPOSABLE GROUNDING PADS		
REF	CONNECTOR	LENGTH
F7902	Universal 6.3 mm mono Jack	500 cm
F7902/4	4 mm plug	500 cm
F7902/24	Double 4 mm plug	500 cm
F7903	Valleylab type (ESU with REM)	500 cm
F7903/F	Valleylab type (ESU without REM)	500 cm
F7904	Special 6.3 mm mono Jack for ERBE: ACC, ICC, VIO, T	500 cm

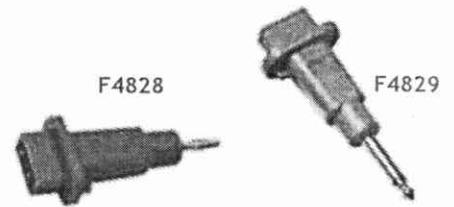

F4828

F4829

REUSABLE ADAPTERS FOR DISPOSABLE GROUNDING PADS

REF	CONNECTOR
F4828	From Valleylab to 4 mm plug
F4829	From Valleylab to 6.3 mm plug

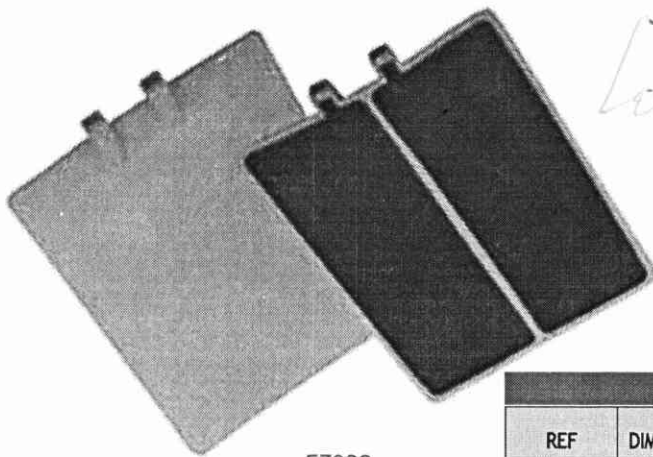

F7930

Label 13

Reusable grounding pads

REUSABLE ADULT GROUNDING PADS

REF	DIMENSIONS	BAKING	ACTIVE SURFACE	REM/not REM	CABLE	CONNECTION
F7915	200X150 mm	Silicone	266 cm ²	Not REM	No	4mm socket
F7930	200X150 mm	Silicone	250 cm ²	REM	No	4mm socket

6,3 mm MONO JACK



4 mm PLUG



DOUBLE 4 mm PLUG



VALLEYLAB TYPE (with REM)



VALLEYLAB TYPE (without REM)

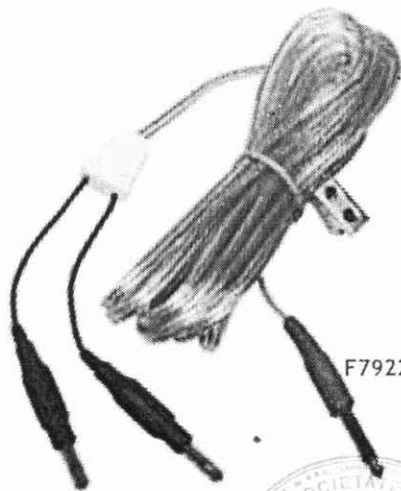

F7922

CABLES FOR REUSABLE GROUNDING PADS/CE GUIDE

REF	CONNECTOR	LENGTH
F7922	Universal 6.3 mm mono Jack	500 cm
F7922/WB	Universal 6.3 mm mono Jack without derivation box	500 cm
F7922/4	4 mm plug	500 cm
F7922/24	Double 4 mm plug	500 cm
F7923	Valleylab type (ESU with REM)	500 cm
F7923/F	Valleylab type (ESU without REM)	500 cm
F7924	Special 6.3 mm mono Jack for ERBE: ACC, ICC, VIO, T	500 cm

