

Original KLEINSASSER Operating Laryngoscopes

Full size illustration:
inner diameter in mm proximal and distal

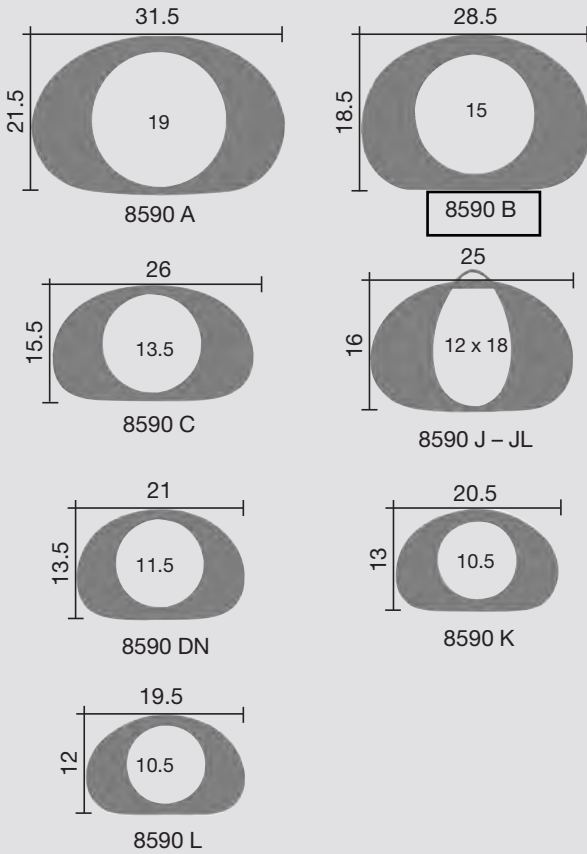

8590 A – L

8590 GF – HF

8590 A

KLEINSASSER Operating Laryngoscope, for adults, extra large, length 17 cm

8590 B

Same, large

8590 C

Same, medium (most commonly used model)

8590 DN

Same, small, length 18 cm (for particularly difficult anatomical circumstances)

8590 J

Same, medium, length 18 cm (for anterior commissure)

8590 JL

Same, medium, length 22 cm (for especially long neck)

8590 K

Same, for children, small, length 15 cm

8590 L

Same, for infants, small, length 13 cm

497 AC

Clip, for proximal illumination

8590 GF

Fiber Optic Light Carrier, for distal illumination, working length 14 cm, for use with Laryngoscopes 8590 A – JL

8590 HF

Fiber Optic Light Carrier, for distal illumination, working length 7.5 cm, for use with Laryngoscopes 8590 K – L

8590 KC

Injection Cannula, for positive pressure assisted ventilation, working length 8.5 cm, for use with Laryngoscopes 8590 A – L

8590 M

Suction Tube to remove vapor, for LASER treatment, diameter 3 mm, working length 12.5 cm, for use with Laryngoscopes 8590 A – JL

8590 N

Suction Tube, to remove vapor, for LASER treatment, diameter 3 mm, working length 9 cm, for use with Laryngoscopes 8590 K – L

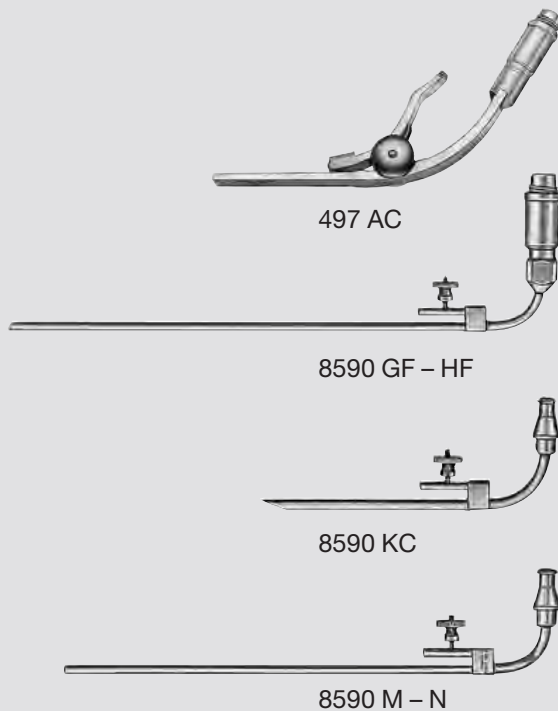

WEERDA Distending Diverticuloscope for CO₂ LASER Technique

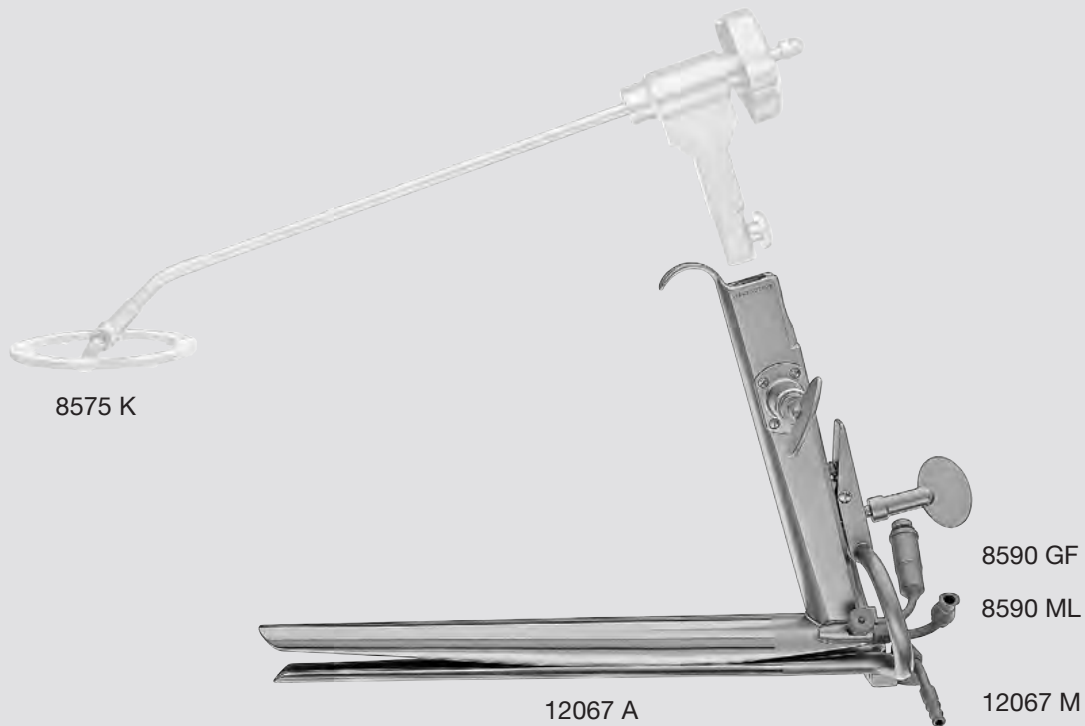

Outer dimensions in mm: 12067 A
proximal:



Spread: max. 40
min. 29

distal:

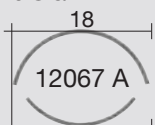

Spread: max. 65
min. 7

8590 GF

8590 ML

12067 M

8575 K

8575 KC

WEERDA Distending Diverticuloscope, length 24 cm,
with adaptor for Suction Tube 12067 M

Proximal size open: max. 40 x 27 mm
min. 29 x 27 mm

Distal size open: max. 65 x 18 mm
min. 7 x 18 mm

Fiber Optic Light Carrier, for distal illumination,
working length 14 cm

Suction Tube, to remove vapor, for LASER treatment,
outer diameter 3 mm

Suction Tube, to remove vapor, flat, size 6 x 3 mm

Laryngoscope Holder and Chest Support,
GÖTTINGEN model, with adjustment wheel
including:

Support Rod, movable, with metal ring, diameter 9 cm,
length 34 cm

or

BENJAMIN-PARSONS **Laryngoscope Holder and Chest
Support**, GÖTTINGEN model, with adjustment wheel
including:

BENJAMIN-PARSONS **Support Rod**, movable, with metal ring,
diameter 12 cm and 2 lateral set screws, length 34 cm

Components/Spare Parts see chapter 16

Instruments

for Endolaryngeal Microsurgery

Working length 23 cm

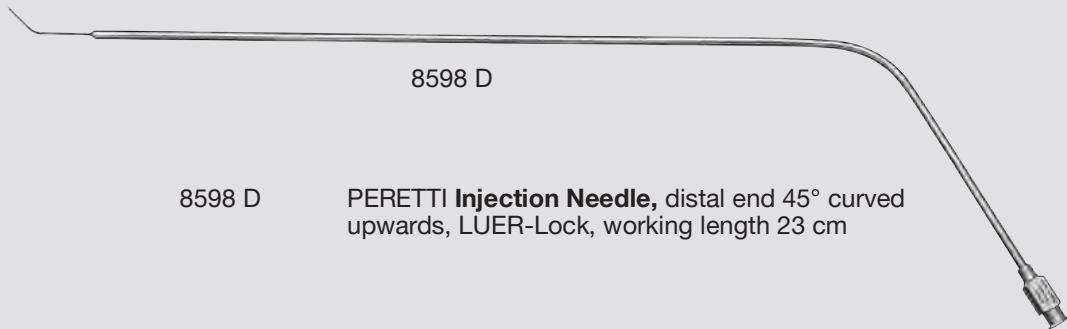

8598 D

8598 D **PERETTI Injection Needle**, distal end 45° curved upwards, LUER-Lock, working length 23 cm

Working length 26 cm

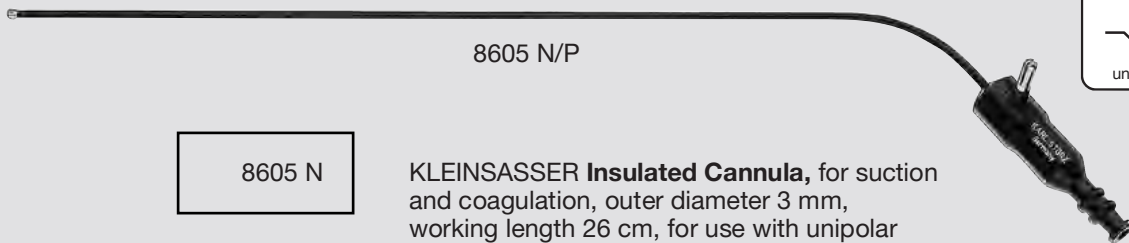

8605 N/P



8605 N

KLEINSASSER Insulated Cannula, for suction and coagulation, outer diameter 3 mm, working length 26 cm, for use with unipolar High Frequency Cords 26005 M or 26002 M/26004 M/26006 M

8605 P **Same**, outer diameter 5 mm

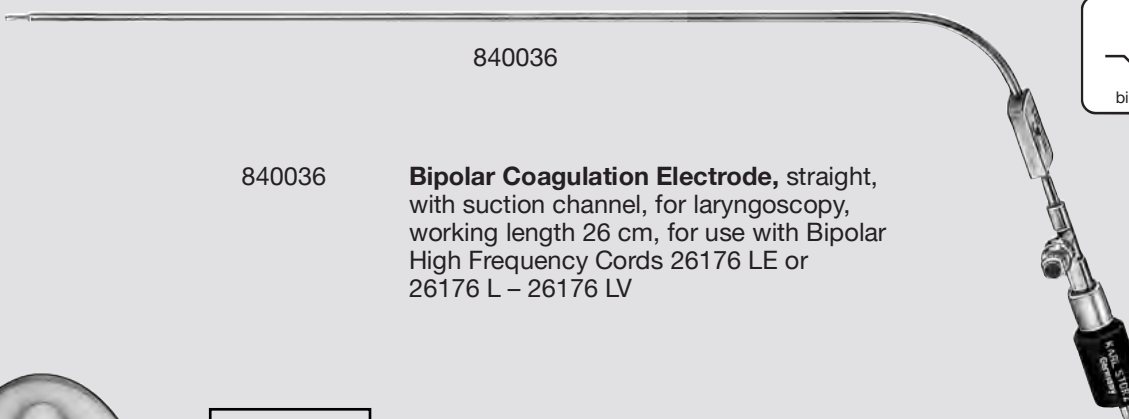

840036



840036 **Bipolar Coagulation Electrode**, straight, with suction channel, for laryngoscopy, working length 26 cm, for use with Bipolar High Frequency Cords 26176 LE or 26176 L – 26176 LV

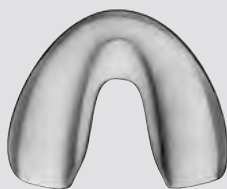

8575 QS

8575 QS

Teeth Protector, silicone, autoclavable, can also be used as inlay in metal teeth protector

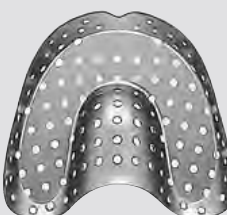

8575 RA – RD

8575 RA **Teeth Protector, metal, large**
8575 RB **Same**, medium
8575 RC **Same**, small
8575 RD **Same**, extra small

8-11

FEHLAND-NAWKA and KLEINSASSER Needle Holder

for Endolaryngeal Microsurgery

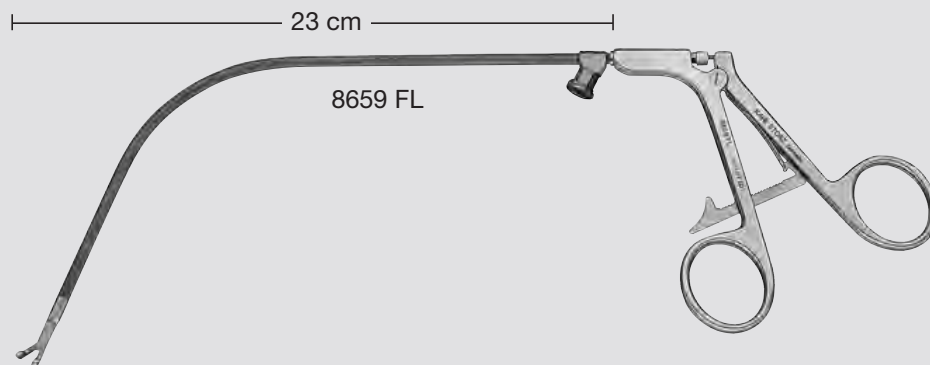

8659 FL

FEHLAND-NAWKA Needle Holder, with crosswise recess for holding the butterfly needle, for indirect injection into the larynx, with ratchet, angled 90° to the left, with cleaning connector, working length 23 cm



8659 FR

Same, angled 90° to the right

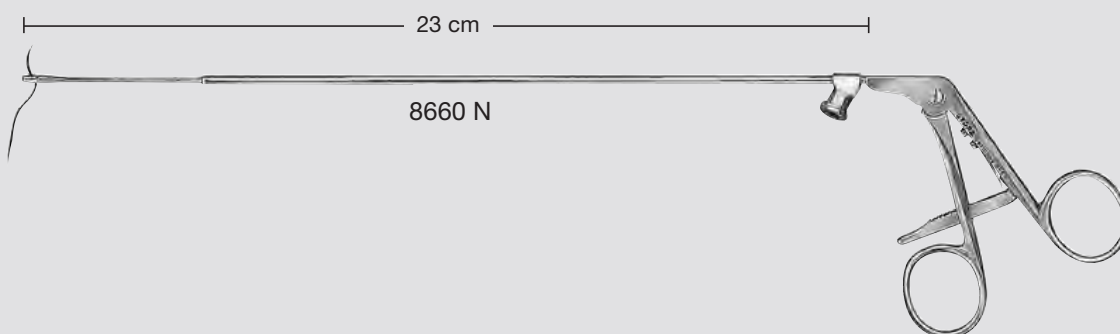

8660 N









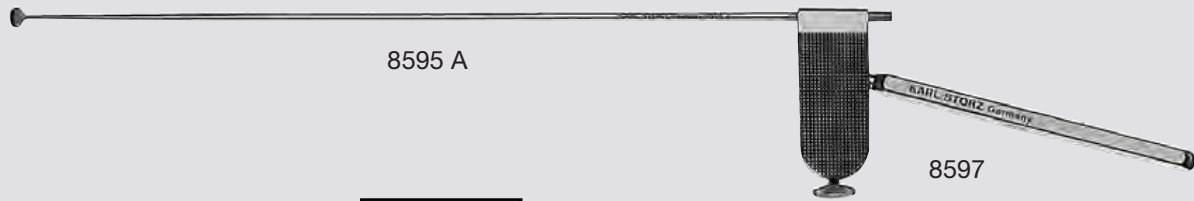



KLEINSASSER Needle Holder, delicate, straight, serrated jaws, size 1.8 x 3.5 mm, sheath conically reinforced from distal to proximal end, with ratchet, with cleaning connector, working length 23 cm

Original KLEINSASSER Instruments

for Endolaryngeal Microsurgery

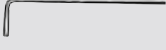
KLEINSASSER Instruments, working length 23 cm, for use with Handle 8597



- | | | |
|---|---------------|--|
|  | 8595 A | Knife , oval, straight |
|  | 8595 B | Same , angled 45° |
|  | 8595 C | Same , sickle-shaped, curved, pointed |
|  | 8595 D | Same , straight cut, pointed |
|  | 8595 E | Same , golf club-shaped, curved, round |
|  | 8595 F | Same , round, cuts vertically |
|  | 8596 A | Hook , blunt, with probe end |
|  | 8596 B | Hook , sharp |
|  | 8596 C | Hook , blunt, angled 90°, with probe end, length 5 mm |
|  | | Needle , curved to right, working length 23 cm |
|  | | Same , curved to left |
|  | 8596 H | Suction Elevator , working length 23 cm |
|  | 8596 T | Knot Tier |
| | 8597 | KLEINSASSER Handle , for use with 8595 A – 8596 T, 8655 A – K, 8693 A/B |



- | | | |
|--|---------|---|
| | 8596 W | |
| | 8596 W | Cotton Applicator , straight, working length 25 cm |
| | 8596 WJ | Cotton Applicator , for endolaryngeal microsurgery, straight, working length 21 cm |
| | 8596 WK | Same , working length 18 cm |

Original KLEINSASSER Instruments

for Endolaryngeal Microsurgery

Working length 23 cm

Special Features:

- Distal end thinner than proximal end to provide better viewing
- Sheath conically reinforced from distal to proximal end to increase mechanical stability

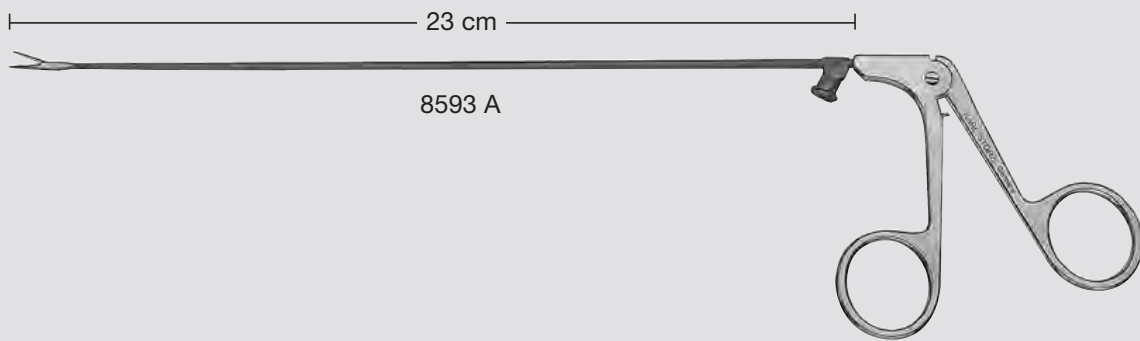
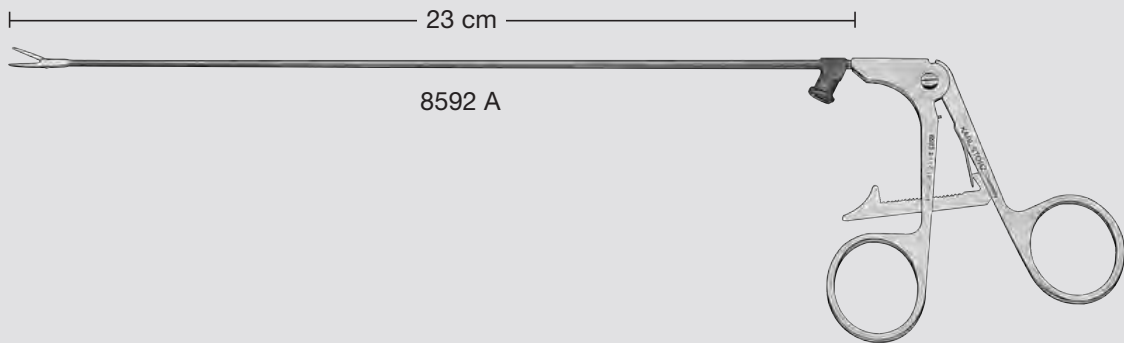

	8592 A	KLEINSASSER Artery Forceps , with ratchet, with cleaning connector, working length 23 cm
	8593 A	KLEINSASSER Grasping Forceps , without ratchet, serrated, straight, with cleaning connector, straight, working length 23 cm
	8593 B	Same , curved to right
	8593 C	Same , curved to left
	8593 E	Same , curved upwards
	8593 G	Same , with triangular jaws, curved upwards to right
	8593 H	Same , curved upwards to left

3-992

Special Features:

- Excellent cutting performance with optimal transfer of strength
- Due to specially ground surface scissor blades stay sharper much longer
- Distal end thinner than proximal end to provide better viewing
- Sheath conically reinforced from distal to proximal end to increase mechanical stability

Working length 23 cm

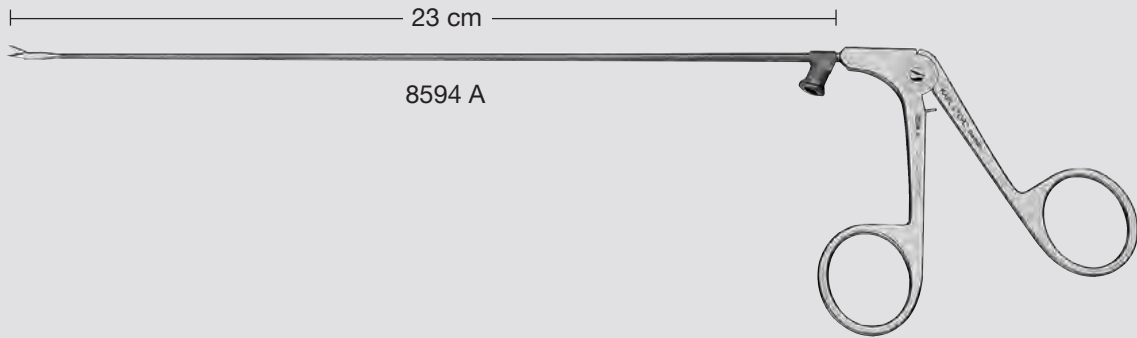

	8594 A	KLEINSASSER Scissors , straight, with cleaning connector, working length 23 cm
	8594 BB	Same , angled 15°
	8594 B	Same , angled 45°
	8594 C	Same , curved to right
	8594 D	Same , curved to left
	8594 E	Same , straight, cuts horizontally

Working length 21 cm, for adolescents

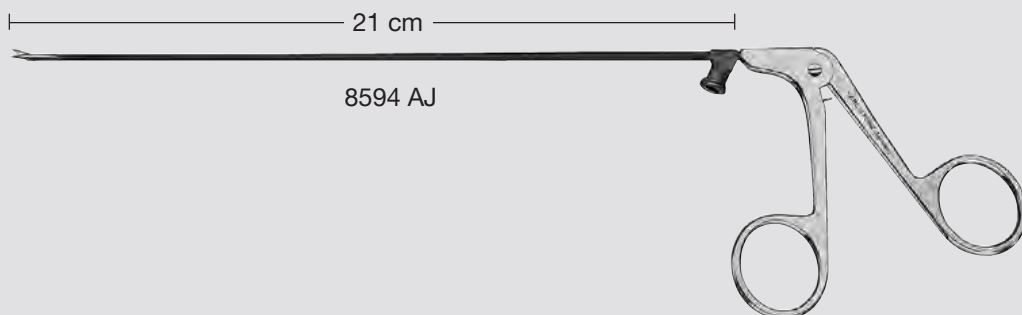

	8594 AJ	KLEINSASSER Scissors , straight, sheath conically reinforced from distal to proximal end, with cleaning connector, working length 21 cm
	8594 CJ	Same , curved to right
	8594 DJ	Same , curved to left

4-952

Original KLEINSASSER Instruments





for Endolaryngeal Microsurgery

Working length 23 cm

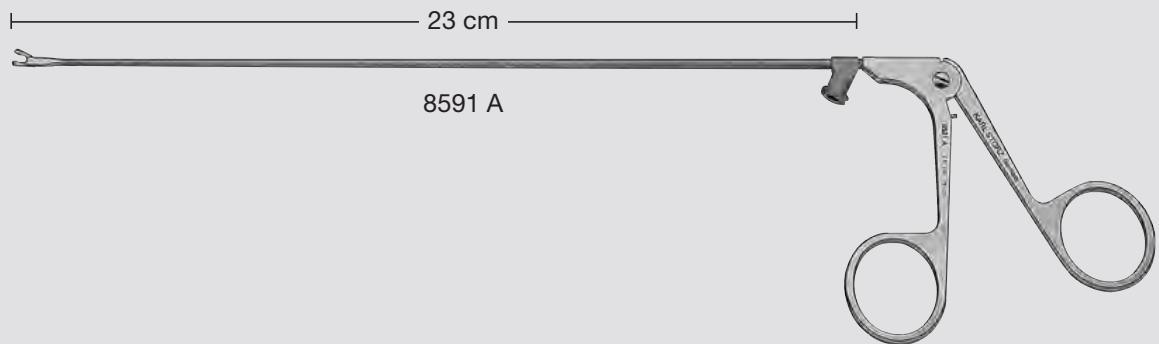
Special Features:

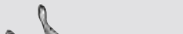
- Distal end thinner than proximal end to provide better viewing
- Sheath conically reinforced from distal to proximal end to increase mechanical stability

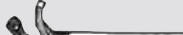

	8591 A	KLEINSASSER Cutting Forceps , straight, with 2 mm cupped jaws, with cleaning connector, working length 23 cm
	8591 B	Same , curved upwards
	8591 C	Same , curved to right
	8591 D	Same , curved to left
	8591 EA	Same , with straight cutting edge for tangential removal of polyps on vocal cords edge, curved upwards to right
	8591 FA	Same , with straight cutting edge for tangential removal of polyps on vocal cords edge, curved upwards to left

Working length 23 cm

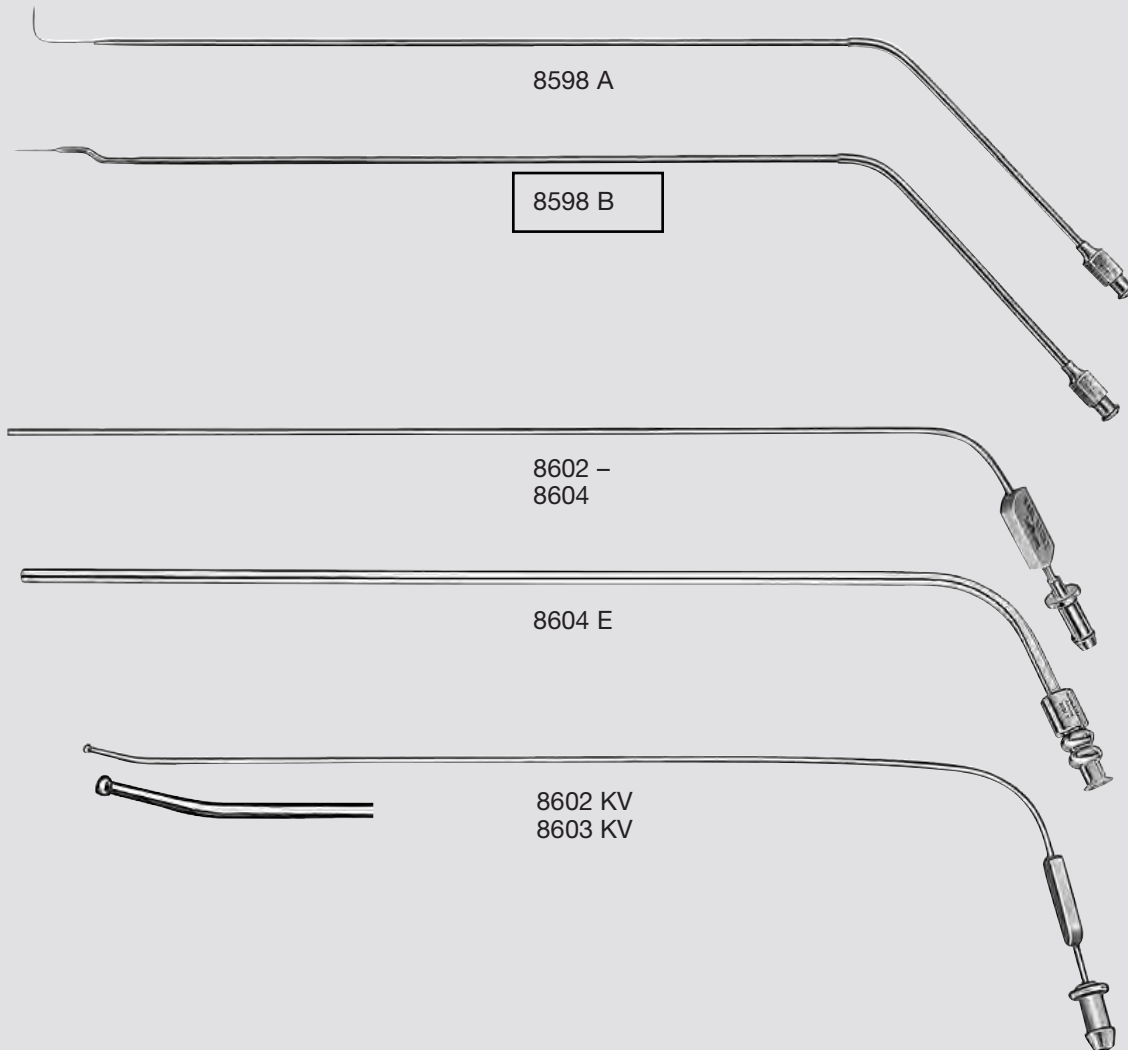

- | | |
|--------|--|
| 8598 A | KLEINSASSER Injection Needle , LUER-Lock, curved, working length 23 cm
Same , straight |
| 8602 | KLEINSASSER Suction Tube , outer diameter 2 mm, working length 23 cm
Same , outer diameter 2.5 mm |
| 8604 | Same , outer diameter 3 mm |
| 8604 E | KLEINSASSER Suction Tube , outer diameter 4 mm, working length 23 cm |

For use with KANTOR-BERCI Video-Laryngoscopes

- | | |
|---------|---|
| 8602 KV | KLEINSASSER Suction Tube , ball end, curved upwards, outer diameter 2 mm, working length 23 cm |
| 8603 KV | Same , outer diameter 3 mm |



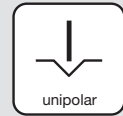

Accessories

Unipolar High Frequency Cords



Unipolar High Frequency Cords

KARL STORZ High Frequency
Instrument Surgical Units

	26002 M	Unipolar High Frequency Cord , with 4 mm plug for models KARL STORZ, Erbe type T, older models and Ellman, length 300 cm
	26004 M	Unipolar High Frequency Cord , with 4 mm plug for models Berchtold and Martin, length 300 cm
	26005 M	Unipolar High Frequency Cord , with 5 mm plug for AUTOCON® II 400 SCB system (111, 115, 122, 125), AUTOCON® II 200, AUTOCON® II 80, KARL STORZ AUTOCON® system (50, 200, 350) and Erbe type ICC, length 300 cm
	26006 M	Unipolar High Frequency Cord , with 8 mm plug for models KARL STORZ AUTOCON® II 400 SCB system (112, 116) and Valleylab, length 300 cm

Please note: All high frequency cords of this page are delivered with a length of 300 cm. If a length of 500 cm is requested please add letter **L** to the part number, e. g. 26002 **ML**, 26176 **LVL**.

Instruments

for endolaryngeal microsurgery

Working length 23 cm



8660 H

KLEINSASSER Forceps, robust model with alligator jaws, single action jaws, with cleaning connector, working length 23 cm



8660 L

KLEINSASSER Laryngeal Biopsy Forceps, robust model with oval jaws, size 3 x 4 mm, single action jaws, with cleaning connector, working length 23 cm

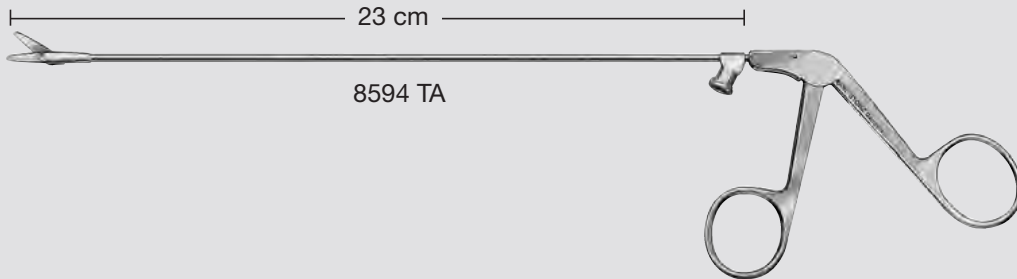

8594 TA

LARYNGOFORCE® II Scissors for Large Tumors, straight, robust model, cutting blade 10 mm, sheath diameter 3 mm, with cleaning connector, working length 23 cm

Recommended Cleaning Rack 39220 CA for Instruments with Cleaning Connectors see page 105