

# LANCING DEVICE and TWIST LANCET TD-5010

TaiDoc's Lancing Device is designed with more comfortable grip, different depth selections, and twist-release cap. It provides more convenient, more comfortable, and easier operation for the users.

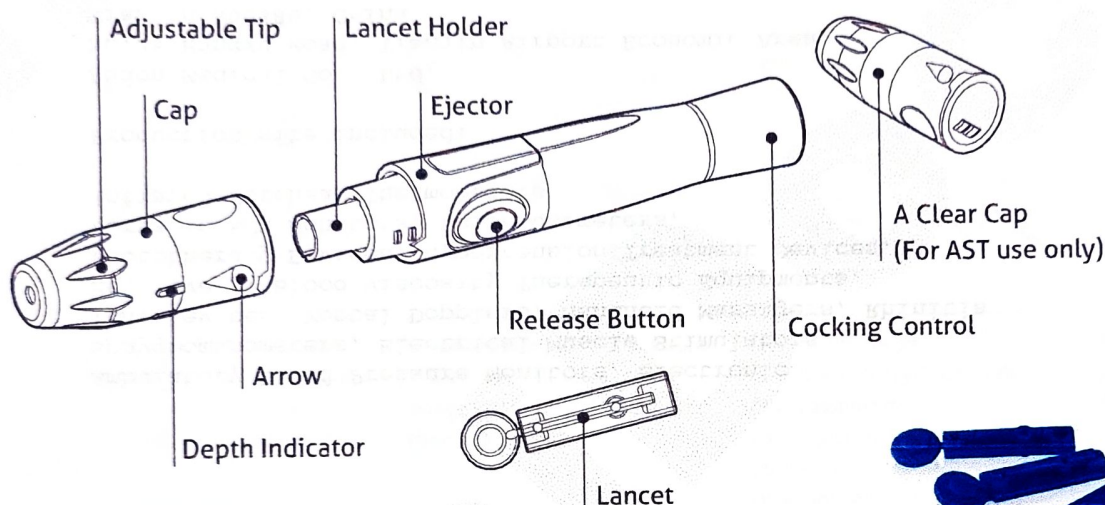

## FEATURES

- Twist-Release provides safer and easier operation for users.
- 6-level depth selection. More noticeable clicks between each level.
- The lancet can be ejected anytime.
- Large contact area – provides steady and comfortable puncture.
- Better adjustable tip grip
- Large holding area on the cap
- Status display on the release button is more visible
- Less vibration less pain

## SPECIFICATIONS

### LANCING DEVICE

Model Number: TD-5010
Penetration Depth Setting: 6-level comfort dial
Penetration Range: 0.8 mm to 1.8 mm
Dimension: 118.7 (L) x 17.5 (D) mm
Weight: 16.5 g
Priming of Device:
Push button to prime with status display window
Lancet Ejection: Yes
Alternative Site Testing: Yes

### SHIPPING INFO

Units per Carton: 100
Gross Weight per Carton: 13 kg
Carton size: 43.8 (L) x 35.8 (W) x 41.5 (H) cm

### Quality Compliance

ISO 11137, ISO 11737,  
ISO 10993-10:2002/Amd 1:2006,  
ISO 10993-5:2009

### ISTA 2A Compliance

ASTM E171, ASTM D4332,  
ASTM D642, ASTM D999,  
ASTM D5276

### TWIST LANCET

Model Number: TD-5084
Lancet Gauge: 30G
Weight: 0.4g
Dimension: 32.6mm x 6.4mm
Units per Carton: 100 pcs/box and 140 boxes/carton
Net Weight per Carton: 7.62 kg
Gross Weight per Carton: 8.62 kg

### SHIPPING INFO

Units per Carton: 140
Gross Weight per Carton: 9.8 kg
Carton size: 43.8 (L) x 36.8 (W) x 25 (H) cm

# INSTRUCTION FOR USE

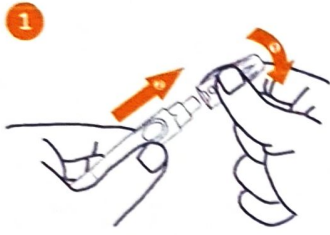

1 Twist and pull off the cap of the lancing device.

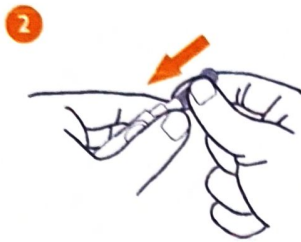

2 Insert a lancet into the lancet holder and push down firmly until it is fully secured.

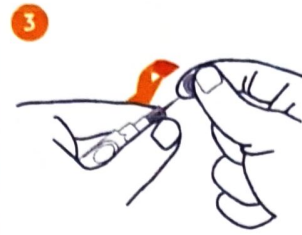

3 Twist the protective disk off the lancet.

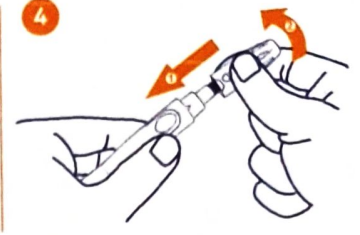

4 Replace and twist the cap as shown in the picture.

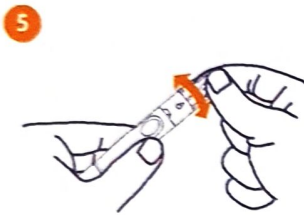

5 Select the depth of penetration by turning the adjustable tip in either direction so that the arrow on the cap points to the desired depth.

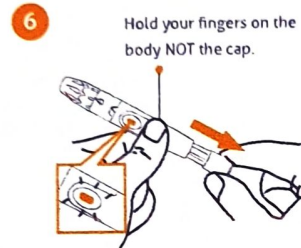

6 Hold your fingers on the body NOT the cap. Pull the cocking control back until it clicks. You will see a color change inside the release button when it is ready.



7 Lancing the finger Press the lancing device's tip firmly against the lower side of your fingertip. Press the release button to prick your finger, then a click indicates that the puncture is complete.



8 Remove the device from the puncture site. After penetration, remove the first drop of blood with a clean cotton swab. Gently squeeze the punctured area to obtain another drop of blood. Be careful NOT to smear the blood sample. Apply the blood to the test strip.

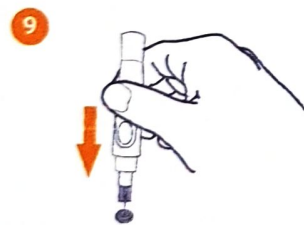

9 Remove the lancet by pulling the cap off first. Safely dispose of the used lancet by placing the protective disk on a hard surface, and pushing the exposed tip into the disk.



10 Slide the ejector forward to remove the used lancet. Dispose of the lancet according to your local regulations.



**TaiDoc**  
♥ ♥ ♥

www.taidoc.com

**TaiDoc Technology Corp.**

B1-7F., No.127, Wugong 2nd Rd., Wugu Dist.,  
New Taipei City 24888, Taiwan  
Tel : +886-2-6625-8188 Fax : +886-2-6625-0288